

Accessories, Power and Data



Accessories - Overview

Power Accessories

Pages [GP3-GP10](#)

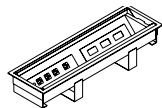

Power and Data Tilt Out



15" Power and Data Unit



Dual Sided Power and Data Unit



Single Sided Power and Data Unit

Telecom Jacks

Pages [GP16-GP19](#)

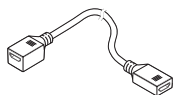

HDMI Connector

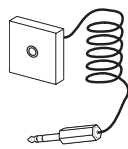

Mini Stereo Jack

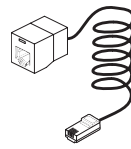

Network Jack

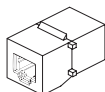

Voice Coupler

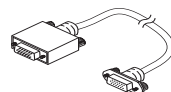

Data Jack

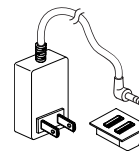

Dual Powered Charging USB

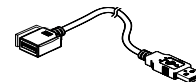

3.0 USB Connector

Wire Management Accessories

Page [GP11](#)



Vertical Wire Manager

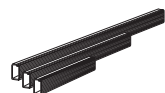

Wire Management Channel

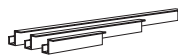

Wire Management Trough



Wire Management Channel



Cable Management Clip



Velcro Straps

Tasklights

Pages [GP20-GP21](#)

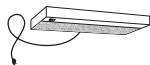

Tasklights

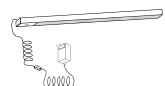

LED Tasklights



Motion Sensor for Tasklights

Keyboard Accessories

Pages [GP22-GP23](#)

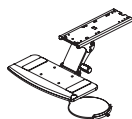

Articulating Keyboard Tray

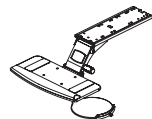

Articulating Keyboard Tray

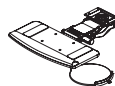

Articulating Keyboard Tray

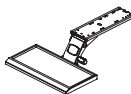

Articulating Keyboard Tray





Keyboard Tray Mouse Pad

Monitor Support Arm

Page [GP24-GP25](#)



For Use with Desk and Conference Tables

Description	D	W	H	CTN WT	CU FT	① Model	List Price
 <p>Mini Power and Data Tilt Up</p> <ul style="list-style-type: none"> fluid one touch tilt up access one power receptacle - 120 volt; 15 amp and one opening for voice/data port data adapter kit provided to accept jacks from most port manufacturers (see page GP15) accepts one Type 3 Telecom Jack (see page GP19) 72" power cord with molded plug drop in field installation required cut out provided in top at specified location (see page GP14) UL listed component Black or Silver finish 	4 1/4	5 1/2		6	1	EC10	\$394
 <p>Mini Power Tilt Up</p> <ul style="list-style-type: none"> fluid one touch tilt up access two power receptacles - 120 volt; 15 amp 72" power cord with molded plug drop in field installation required cut out provided in top at specified location (see page GP14) UL listed component Black or Silver finish 	4 1/4	5 1/2		6	1	EC11	\$409
 <p>Mini Power and USB Tilt Up</p> <ul style="list-style-type: none"> fluid one touch tilt up access one power receptacle - 120 volt; one 20-watt USB-C+A 72" power cord with molded plug drop in field installation required cut out provided in top at specified location (see page GP14) UL listed component Black or Silver finish 	4 1/4	5 1/2		6	1	EC12	\$441

To Order, Specify:

① Model number

Keyboard Accessories

For Use with Desk Bookcases

ACCESSORIES

Description	D	W	H	CTN WT	CU FT	① Model	List Price
Power and Data Tilt Out	30	9		7	6	EC4	\$3,650

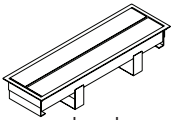

closed

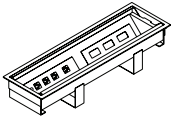

open

- 30" power and data unit
- retractable doors
- standard in silver pearl powder coat
- brush aluminum doors available; specify and add \$1,399 list
- door design allows cords/cables to exit while doors are in closed position
- seven power receptacles
- one dual powered USB
- accepts up to six (6) Type 1 Telecom Plates; additional plate configurations sold separately, see see page [GP15](#)
- unit ships standard with six (6) TCP101, three (3) TCP110 Telecom Plates and three (3) data adapter kits
- power inserts are UL or ETL listed
- two 108" power cords with molded plugs
- cannot be positioned over table support base

Description	D	W	H	CTN WT	CU FT	① Model	List Price
15" Power and Data Unit	15	9		4	2	EC5	\$2,147

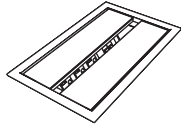

closed

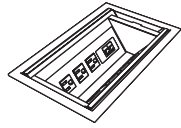

open

- retractable doors
- available in silver pearl powder coat
- brush aluminum doors available; specify and add \$900 list
- door design allows cords/cables to exit while doors are in closed position
- three power receptacles
- one dual powered USB
- accepts up to three (3) Type 1 Telecom Plates; additional plate configurations sold separately, see page [GP15](#)
- unit ships standard with three (3) TCP101, two (2) TCP110 Telecom Plates and two (2) data adapter kits
- power inserts are UL or ETL listed
- 108" power cord with molded plug

Dual Sided Power and Data Unit	11 1/2	14 3/4		7	2	EC6	\$1,492
---------------------------------------	--------	--------	--	---	---	------------	----------------

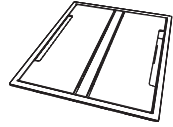

closed

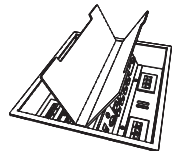

open

- door design allows cords/cables to exit while doors are in closed position
- eight power receptacles, four per side
- accepts up to eight (8) Type 1 Telecom Plates; additional plate configurations sold separately, see page [GP15](#)
- unit ships standard with four (4) TCP101, four (4) TCP110 Telecom Plates and two (2) data adapter kits
- lids lift to open and contain an access slot to allow cords to exit while in use
- available in silver pearl and black texture powder coat
- units are UL listed and CSA certified
- 108" power cord with molded plug

Single Sided Power and Data Unit	5 3/8	9		4	1	EC7	\$579
---	-------	---	--	---	---	------------	--------------



- two power receptacles
- accepts one (1) Type 1 Telecom Plates; additional plate configurations sold separately, see page [GP15](#)
- unit ships standard with one (1) TCP101, one (1) TCP110 Telecom Plate and one (1) data adapter kit
- additionally accepts up to (4) Type 2 Telecom Jacks
- lid lifts to open and contain an access slot to allow cords to exit while in use
- available in silver pearl or black textured powder coat finish
- units are UL listed and CSA certified
- 108" power cord with molded plug
- one under surface power receptacle

To Order, Specify:

- ① Model number

Description	D	W	H	CTN WT	CU FT	① Model	List Price
Single Sided Power and Data Unit	8 3/8	4		3	1	EC9	\$525

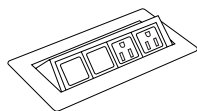

- two power receptacles - 120 volt, 15 amp and two openings for voice/data jacks
- data adapter kit provided to accept jacks from most port manufacturers (see page [GP15](#))
- accepts up to two Type 3 Telecom Jacks (see page [GP19](#))
- push to open pop up door
- clear anodized aluminum
- 72" power cord with molded plug
- UL listed

Dual Power and Data Tilt Up	8	8 3/8		16	1	EC13	\$1,042
------------------------------------	---	-------	--	----	---	-------------	----------------

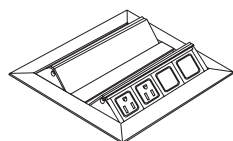

- fluid one touch tilt up access
- back to back tilt sections
- four power receptacles (2 per side) - 120 volt; 15 amp with four openings for voice/data jacks (2 per side)
- data adapter kit provided to accept jacks from most port manufacturers
- accepts up to four Type 3 Telecom Jacks (see page [GP19](#))
- two 72" power cord with molded plug
- drop in field installation required
- cut out provided in top at specified location (see page [GP14](#))
- UL listed component
- available in Silver (S)

Edge Mount Electrical	3	10		16	1	EC15	\$489
------------------------------	---	----	--	----	---	-------------	--------------

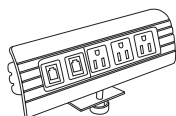

- clamp mounts to the edge of the worksurface - requiring minimum 2" surface overhang
- three power receptacles - 120 volt; 15 amp with two voice/data ports
- data adapter kit provided to accept jacks from most port manufacturers
- accepts up to two Type 3 Telecom Jacks (see page [GP19](#))
- 72" power cord with molded plug - exits back of unit
- UL listed component
- clear anodized aluminum

Description	D	W	H	CTN WT	CU FT	① Model	List Price
Moire Power Unit	3 3/8	3 3/8	2	5	1	EC23	\$496

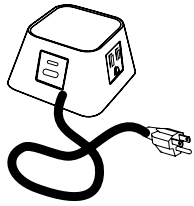

- three power 110 outlets
- one 20-watt USB-C+A
- 72" 3-prong - 15amp plug power feed
- 15amp/110 volt
- specify Black (BK) or White (WH)

Node Power Unit	3 3/8	3 3/8	3/8	5	1	EC24	\$396
------------------------	-------	-------	-----	---	---	-------------	--------------

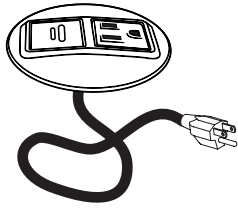

- one power & one 20-watt USB-C+A, 72" cord
- color: black or white

Ellora Power Unit	5 1/2	8 1/2	3 1/2	5	1	EC25	\$759
--------------------------	-------	-------	-------	---	---	-------------	--------------

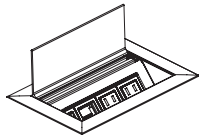

- used in Media Table or Media Credenza
- two power, one 20-watt USB-C+A & one opening for voice/data port, 72" power cord
- adapter kit provided to accept jacks for most port manufactures
- accepts one Type 3 telecom jack
- wire pass-through
- anodized aluminum

To Order, Specify:

- ① Model number

Description	D	W	H	CTN WT	CU FT	① Model	List Price
Worksurface Power	2 5/8	6 3/8	3	3	1	EC26	\$532

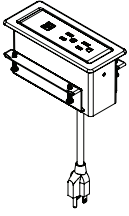

- two power receptacles - 120 volt; 15 amp dual powered USB
- 120" power cord with molded plug
- White (W) or Black (B) finish available, specify when ordering
- UL recognized
- meets UL spill requirements

Under Surface Power	3	6 1/2	1 13/16	2	1	EC27	\$419
----------------------------	---	-------	---------	---	---	-------------	--------------

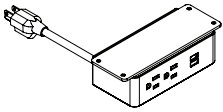

- two power receptacles - 120 volt; 15 amp dual powered USB
- 120" power cord with molded plug
- White (W) or Black (B) finish available, specify when ordering
- UL recognized

Edge Mount Power	3 1/2	5 1/2	7 1/2	3	1	EC28	\$427
-------------------------	-------	-------	-------	---	---	-------------	--------------

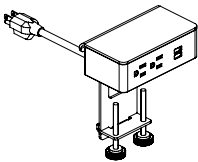



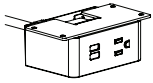
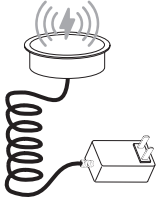
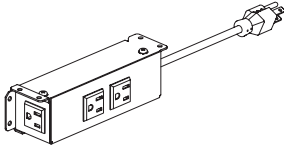

- two power receptacles - 120 volt; 15 amp dual powered USB
- 120" power cord with molded plug
- White (W) or Black (B) finish available, specify when ordering
- UL recognized

Description	D	W	H	CTN WT	CU FT	① Model	List Price
Power Center - Under Mount  <ul style="list-style-type: none"> · 10' cord · frame mounted simplex receptacle and two USB/10' - three prong plug power cord · specify black or white - cord color will match unit · optional graphite fabric cord available, specify and add \$197 list · overall mounting bracket tabs: 5"w 	2 3/4	4	2 5/16			EC30	\$374
Wireless Charging Unit  <ul style="list-style-type: none"> · wireless charging for use with Qi enabled devices · 72" power cord · black · UL Listed · CE/FCC certified 	3 1/2	3 1/2	1	3	1	EC33	\$348
Under Surface Convenience Power Unit  <ul style="list-style-type: none"> · three outlets · 108" power cord · black · ETL Listed for US 	3 1/8	7 1/8	2 1/8	3	1	EC34	\$303

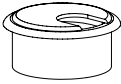
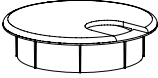
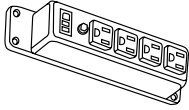
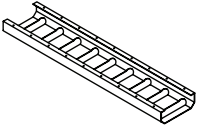
To Order, Specify:

- ① Model number

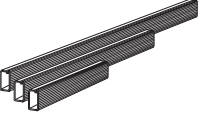
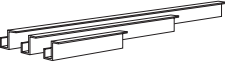
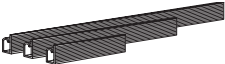
Description	D	W	H	CTN WT	CU FT	① Model	List Price
2"dia. Grommet  <ul style="list-style-type: none"> · use in panels 3/4" thick or greater · plastic sleeve and removable lid · matte black (MBK) · interior 1 1/2" dia. · recommended 1 3/4" dia. cut out for installation in field 	2	2	7/8			GP02FIG	\$34
3"dia. Grommet  <ul style="list-style-type: none"> · use in panels 3/4" thick or greater · plastic sleeve and removable lid · matte black (MBK) · interior 2 1/4" dia. · recommended 2 5/8" dia. cut out for installation in field 	3	3	3/4			GP03FIG	\$34
Power Strip  <ul style="list-style-type: none"> · includes switch · power surge with 10' cord · four electrical outlets 	1 1/2	1 7/8	8			GP9ACP1-0212	\$96
Wire Management Trays  <ul style="list-style-type: none"> · silver powder-coated finish · four hanging brackets (CI2C00) 	7 1/2	45				GP9WMT1-0845	\$279
	7 1/2	35				GP9WMT1-0835	\$235
	7 1/2	25				GP9WMT1-0825	\$191

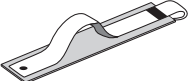
Description	D	W	H	CTN WT	CU FT	① Model	List Price
Vertical Wire Manager  <ul style="list-style-type: none"> flexible, vertebrae-style construction field installed to bottom of worksurface with screws provided length can be adjusted by removing individual discs as required wire manager is 1 1/2" diameter weighted base is 4" diameter black plastic 	1 1/2	1 1/2	45	4	1	45VWM	\$135
Wire Management Channel  <ul style="list-style-type: none"> available in 12", 24" and 36" increments field installed with adhesive tape provided black 	1/2	36	1	4		36WC	\$82
	1/2	24	1	3		24WC	\$74
	1/2	12	1	2		12WC	\$64
Wire Management Trough  <ul style="list-style-type: none"> available in 12", 24" and 36" increments field installed with screws provided black 	2 1/2	36	2 1/2	3		36WCT	\$157
	2 1/2	24	2 1/2	3		24WCT	\$143
	2 1/2	12	2 1/2	2		12WCT	\$123
Wire Management Trough  <ul style="list-style-type: none"> available in 12", 24" and 36" increments field installed with adhesive tape provided mounts to edge of surface top black 	1 1/8	36	2 3/8	1		36WJC	\$67
	1 1/8	24	2 3/8	1		24WJC	\$49
	1 1/8	12	2 3/8	1		12WJC	\$26
Cable Management Clip  <ul style="list-style-type: none"> four retention loops field installed with screws provided mounts under surface black 	2 5/8	3 3/4	1 5/8	1		0304CMC	\$56
Wire Management Velcro Straps  <ul style="list-style-type: none"> set of four field installed with adhesive tape provided mounts under surface or on vertical panels black 	1 3/4	3 1/2	1/8	1		04WVS	\$58

To Order, Specify:

① Model number

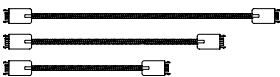
Description	D	W	H	CTN WT	CU FT	① Model	List Price
Jumper 	144			4	1	EC4T-144JK	\$260
	138			4	1	EC4T-138JK	\$253
	132			4	1	EC4T-132JK	\$247
	126			4	1	EC4T-126JK	\$243
	120			4	1	EC4T-120JK	\$237
	114			4	1	EC4T-114JK	\$233
	108			4	1	EC4T-108JK	\$230
	102			4	1	EC4T-102JK	\$223
	96			3	1	EC4T-96JK	\$218
	90			3	1	EC4T-90JK	\$212
	84			3	1	EC4T-84JK	\$206
	78			3	1	EC4T-78JK	\$200
	72			3	1	EC4T-72JK	\$196
	66			3	1	EC4T-66JK	\$187
	60			3	1	EC4T-60JK	\$176
	54			3	1	EC4T-54JK	\$171
	48			2	1	EC4T-48JK	\$164
	42			2	1	EC4T-42JK	\$155
	36			2	1	EC4T-36JK	\$151
	30			2	1	EC4T-30JK	\$146
24			2	1	EC4T-24JK	\$142	
18			2	1	EC4T-18JK	\$141	

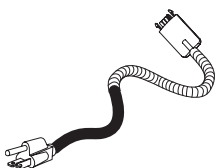
Three Prong Power Infeed - Flex Metallic Conduit 	120			4	1	EC4T-120APE	\$393
	108			4	1	EC4T-108APE	\$384
	96			3	1	EC4T-96APE	\$373
	84			3	1	EC4T-84APE	\$370
	72			3	1	EC4T-72APE	\$314
	60			3	1	EC4T-60APE	\$267
	48			2	1	EC4T-48APE	\$260

- single circuit infeed
- two foot rubber cord transitions to metal conduit

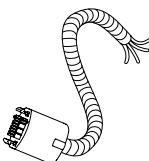
Hardwire Power Infeed - Flex Metallic Conduit 	144			4	1	EC4T-144HPE	\$243
	132			4	1	EC4T-132HPE	\$232
	120			4	1	EC4T-120HPE	\$225
	108			4	1	EC4T-108HPE	\$218
	96			3	1	EC4T-96HPE	\$204
	84			3	1	EC4T-84HPE	\$194
72			3	1	EC4T-72HPE	\$185	

- single or double circuit infeed
- 4 wire 2 circuit system
- 13 duplexes available per each circuit

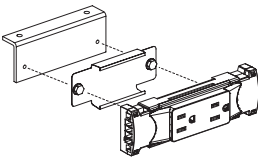
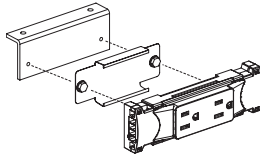
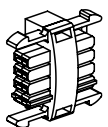
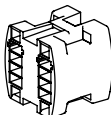
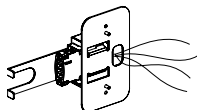
Description	D	W	H	CTN WT	CU FT	① Model	List Price
Conduit Clamp  <ul style="list-style-type: none"> includes screw 				1	1	EC4T-CLAMP	\$14
Duplex Receptacle Kit Circuit 1  <ul style="list-style-type: none"> used in single circuit and multi-circuit applications vertical and horizontal mounting brackets included 				1	1	EC4T-DUP1K	\$134
Duplex Receptacle Kit Circuit 2  <ul style="list-style-type: none"> used in multi-circuit applications vertical and horizontal mounting brackets included 				1	1	EC4T-DUP2K	\$134
Receptacle to Receptacle Connector 				1	1	EC4T-R2R	\$81
H Block Connector Kit  <ul style="list-style-type: none"> accepts one power infeed and connects up to three jumpers mounting bracket included 				1	1	EC4T-4HCON	\$89
Quick Disconnct  <ul style="list-style-type: none"> hardwire connection (4 wire), mounts to wall accommodates single or multi-circuit connects directly to jumper in place of power infeed 	1	2 3/4	4 5/8	1	1	EC4T-4QD	\$177

To Order, Specify:

① Model number

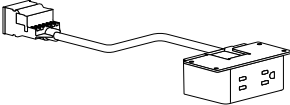
Description	D	W	H	CTN WT	CU FT	① Model	List Price
Perimeter Under-Mount Power - (1) 110 Outlet (2) USB-A 						ECPA-0610	\$5,398
						ECPA-0508	\$4,105
						ECPA-0406	\$3,231
						ECPA-0306	\$3,231
						ECPA-0104	\$2,351
						ECPA-0204	\$2,341
						ECPA-0804	\$2,260
						ECPA-0702	\$1,412

- power infeed(s) with three-prong 15A, 120" cord
- jumpers included
- White (W) or Black (B) finish available, specify when ordering
- ECPA-0610 includes 10 duplex power units and accomodates 216" and 240" table with 2 power infeeds
- ECPA-0508 includes 8 duplex power units and accomodates 168" and 192" tables
- ECPA-0406 includes 6 duplex power units and accomodates 144" tables
- ECPA-0306 includes 6 duplex power units and accomodates 108", 120", and 132" tables
- ECPA-0104 includes 4 duplex power units and accomodates 72" and 84" tables
- ECPA-0204 includes 4 duplex power units and accomodates 96" tables
- ECPA-0804 includes 4 duplex power units and accomodates square tables
- ECPA-0702 includes 2 duplex power units and accomodates round tables

Description	D	W	H	CTN WT	CU FT	① Model	List Price
Perimeter Under-Mount Power - 110 Outlets 						ECPP-0610	\$3,566
						ECPP-0508	\$2,640
						ECPP-0406	\$2,133
						ECPP-0306	\$2,133
						ECPP-0104	\$1,619
						ECPP-0204	\$1,609
						ECPP-0804	\$1,528
					ECPP-0702	\$1,045	

- power infeed(s) with three-prong 15A, 120" cord
- jumpers included
- White (W) or Black (B) finish available, specify when ordering
- ECPP-0610 includes 10 duplex power units and accomodates 216" and 240" tables with 2 power infeeds
- ECPP-0508 includes 8 duplex power units and accomodates 168" and 192" tables
- ECPP-0406 includes 6 duplex power units and accomodates 192" tables
- ECPP-0306 includes 6 duplex power units and accomodates 108", 120", and 132" tables
- ECPP-0104 includes 4 duplex power units and accomodates 72" and 84" tables
- ECPP-0204 includes 4 duplex power units and accomodates 96" tables
- ECPP-0804 includes 4 duplex power units and accomodates square tables
- ECPP-0702 includes 2 duplex power units and accomodates round tables

To Order, Specify:

① Model number

Standard Power and Data Locations for Casegoods:

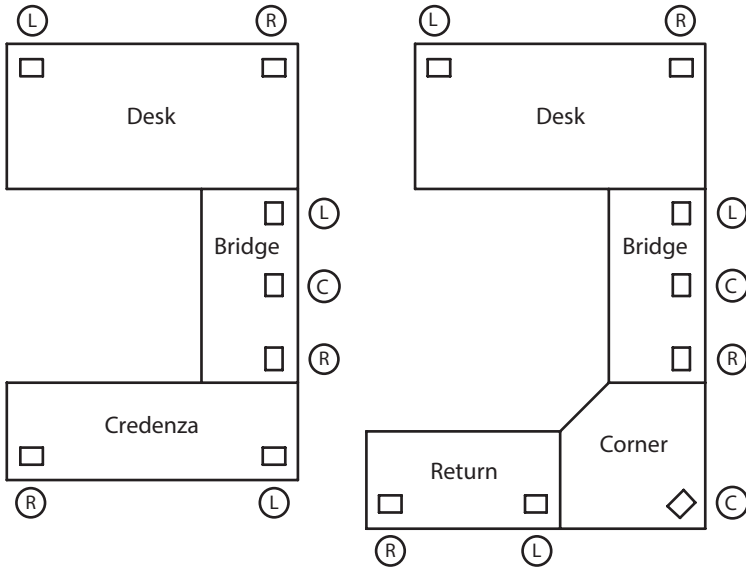

- Specify - Location when ordering on desk, return, computer corner, bridge and credenza - please provide drawing.
- Computer corner units - power/data replaces grommet.
- Standard power and data unit locations are indicated from user side of desk, return, computer corner bridge or credenza.

NOTE: Verify fit of data jack in adapter before ordering large quantities as manufacturer designs may change without notice

Standard Power and Data Locations for Tables and Conference Units:

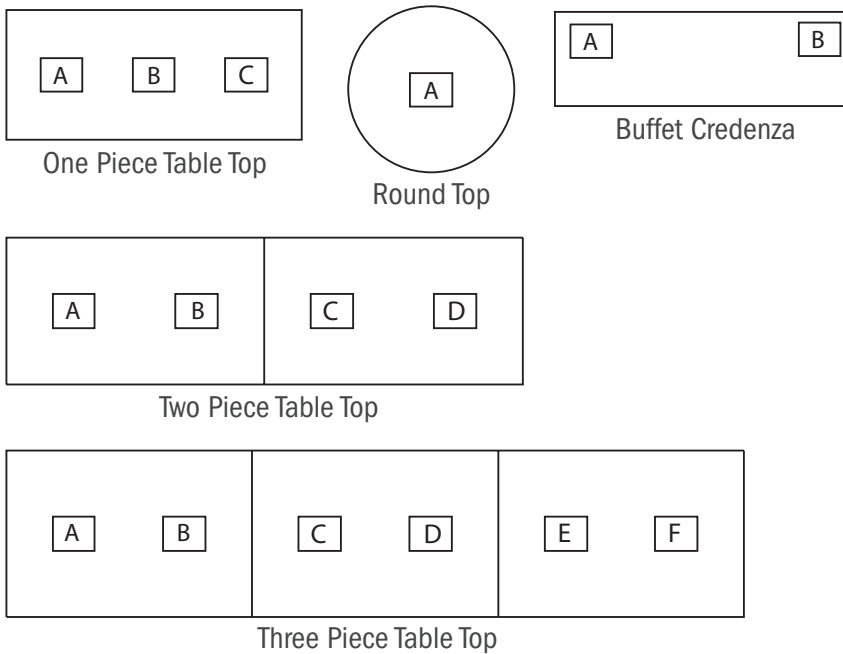

- Verify fit of jack in adapter before ordering large quantities as manufacturer designs may change without notice.
- Installation of Power and Data units on a seam of multi piece tops should be avoided when possible.
- Specify location when ordering conference tops or buffet credenza.
- Standard power and data units are indicated from the side of conference tops and user side of buffet credenza.

Data Adapter Applications

Data adapter kits ship with each power and data unit.

Adapter plates are marked on the back with letter designators to indicate the data jack manufacturer, series and style. Websites are listed below for quick reference to verify data jack series or style.

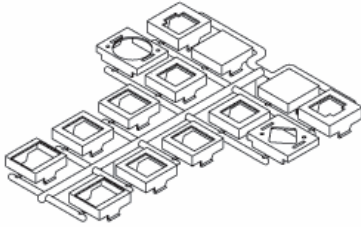

Included with EC9, EC10, EC13, EC15, TCP110 and CC9CNE1-0708.

NOTE: Verify fit of data jack in adapter before ordering large quantities as manufacturer designs may change without notice.

Adapter	Manufacturer	Website
AA	Uniprise/Systimax/Avaya	www.unipriseresolutions.com
BB	Tyco SL and 100 Connect Series Modular Jacks	www.ampconnect.com
BB	Siemon Keystone Style	www.siemon.com
BB	Allen Tel Versa Tap Series	www.allentel.com
BB	Leviton Quick Port® Series	www.leviton.com
BB	Nordx Keystone Style	www.nordx.com
CC	Tyco SL Coupler Series	www.ampconnect.com
CC	Krone 6000 Series	www.adc.com
CC	Hubbell Xcelerator™ Keystone Series	www.hubbell.com
DD	Blank (no coupler/jack)	
EE	Ortronics TracJack Series	www.ortronics.com
FF	Panduit Mini-Com Series	www.panduit.com
GG	Microphone jack/3-pin XLR, solder type only	
HH	Video Monitor jack/DB-15, panel mount solder style	

The TCP110 Type 1 Data plate comes with the adapter kit to allow installation of data jacks listed above. The TCP110 can be installed in the EC4, EC5, EC6, EC7, EC36, EC37, EC38 and EC57.

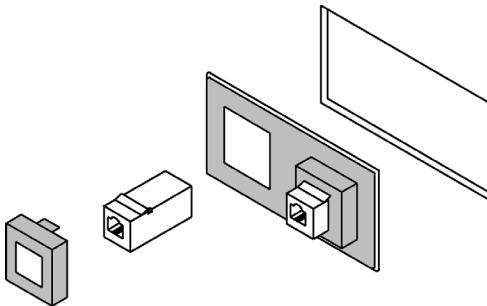

Type 1 Telecom Plates/Jacks

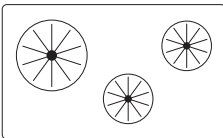
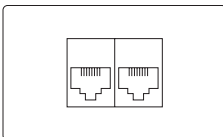
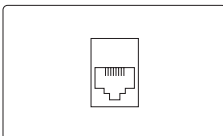
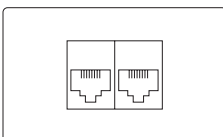
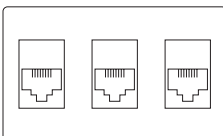
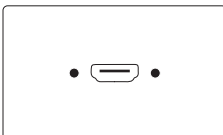
Description	D	W	H	CTN WT	CU FT	① Model	List Price
Data Plate - Blank Cap  <ul style="list-style-type: none"> · for use in EC4, EC5, EC6, EC7, EC36, EC37, EC38 and EC57 		1 3/4	3 1/8			TCP101	\$17
Data Plate - Three Cord Bushings  <ul style="list-style-type: none"> · for use in EC4, EC5, EC6, EC7, EC36, EC37, EC38 and EC57 		1 3/4	3 1/8			TCP102	\$79
Data Plate - Two Jacks  <ul style="list-style-type: none"> · one RJ11 Cat3 Jack · one RJ-45 Cat6 Jack · for use in EC4, EC5, EC6, EC7, EC36, EC37, EC38 and EC57 		1 3/4	3 1/8			TCP103	\$141
Data Plate - One Jack  <ul style="list-style-type: none"> · one RJ-45 Cat6 jack · for use in EC4, EC5, EC6, EC7, EC36, EC37, EC38 and EC57 		1 3/4	3 1/8			TCP104	\$100
Data Plate - Two Jacks  <ul style="list-style-type: none"> · two RJ-45 Cat6 jacks · for use in EC4, EC5, EC6, EC7, EC36, EC37, EC38 and EC57 		1 3/4	3 1/8			TCP105	\$168
Data Plate - Three Jacks  <ul style="list-style-type: none"> · three RJ-45 Cat6 jacks · for use in EC4, EC5, EC6, EC7, EC36, EC37, EC38 and EC57 		1 3/4	3 1/8			TCP106	\$236
Data Plate - HDMI  <ul style="list-style-type: none"> · one HDMI female to female with 36" cord · for use in EC4, EC5, EC6, EC7, EC36, EC37, EC38 and EC57 		1 3/4	3 1/8			TCP107	\$223

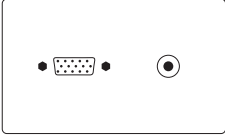
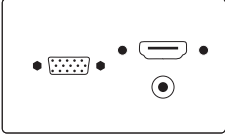
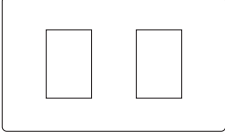
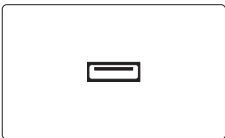
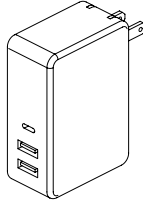
Description	D	W	H	CTN WT	CU FT	① Model	List Price
Data Plate - VGA and Mini-Stereo  <ul style="list-style-type: none"> · one VGA female to female with 72" cord · one Mini-Stereo Inline · for use in EC4, EC5, EC6, EC7, EC36, EC37, EC38 and EC57 		1 ¾	3 ⅛			TCP108	\$216
Data Plate - VGA, HDMI and Mini-Stereo  <ul style="list-style-type: none"> · one VGA female to female with 72" cord · one HDMI female to female with 36" cord · one Mini-Stereo Inline · for use in EC4, EC5, EC6, EC7, EC36, EC37, EC38 and EC57 		1 ¾	3 ⅛			TCP109	\$373
Data Plate - Two Open Data Ports  <ul style="list-style-type: none"> · used with two Type 3 Telecom Jacks; see page GP19 · for use in EC4, EC5, EC6, EC7, EC36, EC37, EC38 and EC57 		1 ¾	3 ⅛			TCP110	\$17
Data Plate - USB 3.0  <ul style="list-style-type: none"> · one USB 3.0 Type A/A with 36" patch cord with male end · for use in EC4, EC5, EC6, EC7, EC36, EC37, EC38 and EC57 · data transfer port · can become powered USB charging port with addition of TCP111-POW power supply 		1 ¾	3 ⅛			TCP111	\$245
USB Charging - Power Supply  <ul style="list-style-type: none"> · USB power supply · for use with TCP111 · converts TCP111 into USB charging port · power source under table or from building required to power unit 						TCP111-POW	\$106

To Order, Specify:

- ① Model number

Type 2 Telecom Jacks

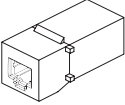
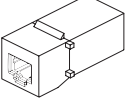
Description	D	W	H	CTN WT	CU FT	① Model	List Price
Phone Jack  <ul style="list-style-type: none">· RJ-11 phone jack· for use in EC7						TCP201	\$70
Data Jack  <ul style="list-style-type: none">· CAT6-RJ45 data jack· for use in EC7						TCP202	\$92

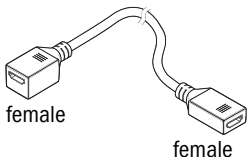
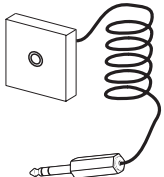
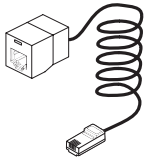
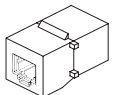
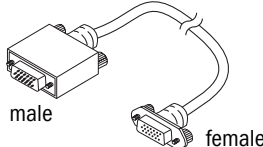
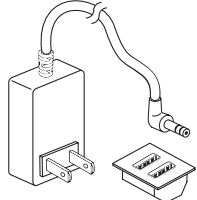
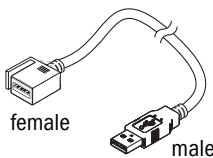
Description	D	W	H	CTN WT	CU FT	① Model	List Price
HDMI Connector 						TCP301	\$114
<ul style="list-style-type: none"> · HDMI coupler · 18" cord · female to female connection · for use in EC9, EC10, EC13, EC15 · uses data adapter kit CCC adapter plate 							
Mini Stereo Jack 						TCP302	\$58
<ul style="list-style-type: none"> · 3.5 mm Mini Stereo Jack · 10 foot cord · female to male connection · for use in EC9, EC10, EC13, EC15 · installs directly into unit without need of data adapter kit 							
Network Jack 						TCP303	\$105
<ul style="list-style-type: none"> · Cat5e RJ-45 Panduit Jack · Pre-terminated · 9 foot cord · 8-Pin · for use in EC9, EC10, EC13, EC15 · uses data adapter kit FFF adapter plate 							
Voice Coupler 						TCP304	\$43
<ul style="list-style-type: none"> · AMP Category 3, RJ-11 · 6-Pin · connects to standard phone cord · for use in EC9, EC10, EC13, EC15 · uses data adapter kit CCC adapter plate 							
Data Jack - VGA 15 Pin 						TCP305	\$141
<ul style="list-style-type: none"> · 120" M/F cable - female-to-male connection · 15 pin connections · provides electronic device to remove display connection · uses data adapter kit HHH adapter plate 							
Dual Powered USB Charging 						TCP306	\$180
<ul style="list-style-type: none"> · two (2) USB-A connections for USB powered devices or charging mobile electronics · 2000mA (2 amp) charging power per USB port · black or white option · for use in EC9, EC10, EC13, EC15 · installs directly into unit without need of data adapter kit · 72" cord 							
Data Jack - USB 3.0 						TCP307	\$98
<ul style="list-style-type: none"> · USB 3.0 data jack with 10' cord and male plug · for use in EC9, EC10, EC13, EC15 · data transfer port - no USB charging capability · data transfer speed up to 5gbs/sec · uses data adapter kit CCC adapter plate 							

To Order, Specify:

- ① Model number

Description	D	W	H	CTN WT	CU FT	① Model	List Price
-------------	---	---	---	-----------	----------	---------	------------

48" w Tasklight	4 ½	48	1 ½	6	1	48T5L	\$361
------------------------	-----	----	-----	---	---	--------------	-------

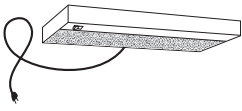

- use with overhead cabinets 60" wide and larger
- uses slim energy-efficient T5 - 3500k lamp (included)
- two position on - off switch
- prismatic lens with electronic ballast
- ETL listed component
- factory installation optional (no additional charge); please specify unit where light is to be installed

24" w Tasklight	4 ½	24	1 ½	4	1	24T5L	\$335
------------------------	-----	----	-----	---	---	--------------	-------

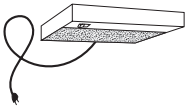

- use with overhead cabinets 30" wide and larger
- uses slim energy-efficient T5 - 3500k lamp (included)
- two position on - off switch
- prismatic lens with electronic ballast
- ETL listed component
- factory installation optional (no additional charge); please specify unit where light is to be installed

LED Tasklight	½	60	¾	3	1	TL60LEDF	\$348
----------------------	---	----	---	---	---	-----------------	-------

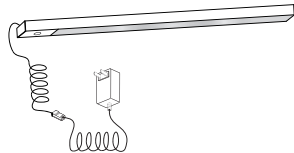

	½	45	¾	3	1	TL45LEDF	\$299
	½	39	¾	3	1	TL39LEDF	\$265
	½	27	¾	3	1	TL27LEDF	\$231



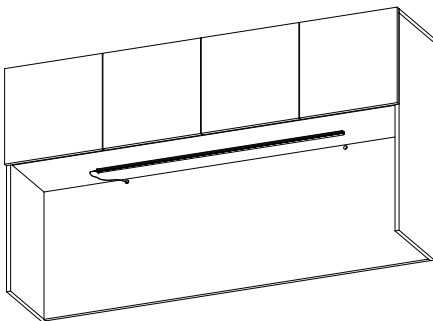

- low profile LED tasklight
- toggle on and off switch
- 4000K cool white
- 13ft cord
- dimmable
- includes attaching brackets, adhesive tape and wire manager
- recommended tasklight length for each cabinet size; see chart below

LED Tasklights

Tasklights are available for overhead cabinets. Specify separately. Grommet holes for wire management are 5/8" diameter for the LED tasklight. Refer to the chart to the right for the recommended tasklight length according to overhead cabinet width.



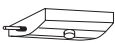

Overhead Width	Tasklight Model Number	Tasklight Length
96"	TL60LEDF	60"
90"	TL60LEDF	60"
84"	TL45LEDF	45"
78"	TL45LEDF	45"
72"	TL45LEDF	45"
66"	TL45LEDF	45"
60"	TL39LEDF	39"
54"	TL27LEDF	27"
48"	TL27LEDF	27"
42"	TL27LEDF	27"
36"	TL27LEDF	27"
30"	TL27LEDF	27"

Description	D	W	H	CTN WT	CU FT	① Model	List Price
31" w LED Starter Tasklight  <ul style="list-style-type: none"> use with overhead cabinets 42" wide and larger slim energy-efficient stand alone or starter LED lamp soft touch switching with instant on to fade way off infinite dimming with last state memory (dimming range 100% to 15%) automatic time off after 10 hours includes power supply ETL listed component GSA compliant factory installation optional (no additional charge); please specify unit where light is to be installed 	2	31	½	4	1	TL31LED-S	\$541
31" w LED Linking Adder Tasklight  <ul style="list-style-type: none"> use with overhead cabinets 42" wide and larger slim energy-efficient LED lamp for linking to a starter tasklight string may contain 1 starter with up to five adders soft touch switching with instant on to fade way off infinite dimming with last state memory (dimming range 100% to 15%) automatic time off after 10 hours ETL listed component GSA compliant factory installation optional (no additional charge); please specify unit where light is to be installed 	2	31	½	4	1	TL31LED-A	\$423
17" w LED Starter Tasklight  <ul style="list-style-type: none"> use with overhead cabinets 30" wide and larger slim energy-efficient stand alone or starter LED lamp soft touch switching with instant on to fade way off infinite dimming with last state memory (dimming range 100% to 15%) automatic time off after 10 hours includes power supply ETL listed component GSA compliant factory installation optional (no additional charge); please specify unit where light is to be installed 	2	17	½	2	1	TL17LED-S	\$418
17" w LED Linking Adder Tasklight  <ul style="list-style-type: none"> use with overhead cabinets 30" wide and larger slim energy-efficient LED lamp for linking to a starter tasklight string may contain 1 starter with up to five adders soft touch switching with instant on to fade way off infinite dimming with last state memory (dimming range 100% to 15%) automatic time off after 10 hours ETL listed component GSA compliant factory installation optional (no additional charge); please specify unit where light is to be installed 	2	17	½	2	1	TL17LED-A	\$360
Motion Sensor for Tasklights  <ul style="list-style-type: none"> occupancy sensor for LED tasklights integrates with TL31LED or TL17LED shuts off after 30 minutes of inactivity connects to end of light fixture (adds 3" to length of fixture) one sensor controls starter and connected adders 	2	3	½	1	1	TL03-OCPS	\$462

To Order, Specify:

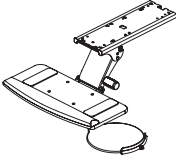
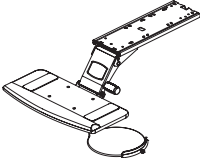
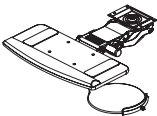
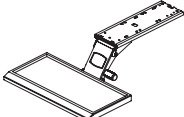
① Model number

Description	D	W	H	CTN WT	CU FT	① Model	List Price
Articulating Keyboard Tray  <ul style="list-style-type: none"> · articulating keyboard tray - black color · mouse tray included · 16" glide track · easy one-handed adjustment; vertical range of motion of 5.1" below glide track · tray tilt range +10 degree to -20 degree · unit swivels side-to-side · tray size is 19.4" wide x 9.4" deep · tray includes palm rest · tray is made with recyclable high density polyethylene 	13	24	7	14	2	AK2	\$536
Articulating Keyboard Tray  <ul style="list-style-type: none"> · articulating keyboard tray - black color · mouse tray included · 17" glide track · easy one-handed adjustment; vertical range of motion of 8.9"; (6.5" below the glide track and an additional 2.38" above) · tray tilt range +10 degree to -20 degree · unit swivels side-to-side · tray size is 19.4" wide x 9.4" deep · tray includes palm rest · tray is made with recyclable high density polyethylene 	13	24	7	12	2	AK3	\$567
Articulating Keyboard Tray  <ul style="list-style-type: none"> · trackless articulating keyboard tray - black color · mouse tray included · use when depth under work surface for mounting is limited; minimum of 9.38" depth recommended · easy one-handed adjustment; vertical range of motion of 5.73 · tray tilt range +10 degree to -15 degree · unit swivels side-to-side · tray size is 19.4" wide x 9.4" deep · tray includes palm rest · tray is made with recyclable high density polyethylene 	11	23	3	11	2	AK5	\$552
Articulating Keyboard Tray  <ul style="list-style-type: none"> · articulating keyboard tray - wood finish tray with black mechanism · recommended for spaces with 24" clearance side to side · mouse tray purchased separately - specify MT4 · 17" glide track · easy one-handed adjustment; vertical range of motion of 8.9"; (6.5" below the glide track and an additional 2.38" above) · tray tilt range +10 degree to -20 degree · unit swivels side-to-side · tray size is 21.75" wide x 11" deep · wood tray requires finish selection; see component finishes for the selection 	14	23	7	15	2	AK4	\$598
Keyboard Tray Mouse Pad  <ul style="list-style-type: none"> · adjusts for user comfort · 8" x 8" · for left or right hand operation · compatible with AK4 Keyboard Drawer only 	8	8	1/4	2		MT4	\$201

Description	D	W	H	CTN WT	CU FT	① Model	List Price
-------------	---	---	---	-----------	----------	---------	------------

Wide Pencil Drawer	19 1/4	22	1 7/8	5	1	GP2219CD	\$129
--------------------	--------	----	-------	---	---	----------	-------

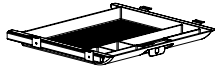

- plastic

Pencil Drawer	19 1/4	16 1/8	2 3/8	4	1	GP1619CD	\$119
---------------	--------	--------	-------	---	---	----------	-------



- plastic

Center Nook Drawer	8 1/4	15 1/4	2	2	1	GP1509CD	\$114
--------------------	-------	--------	---	---	---	----------	-------

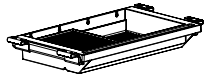

- plastic

Angled Front Center Drawer	17 5/8	24 1/2	2 1/2	20	1	GP9CDRC-1524	\$422
----------------------------	--------	--------	-------	----	---	--------------	-------

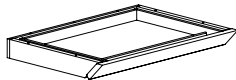

- not available on table desk with apron
- not available in makore or double cut
- wood drawer
- non-locking

To Order, Specify:

- ① Model number

Description	D	W	H	CTN WT	CU FT	① Model	List Price
Monitor Support Arm	12	6	17	9		AMA3B	\$666

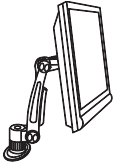

- 360 degree swivel
- adjusts height, tilt and distance of monitor screen to user
- integrated cable management
- grommet and edge clamp mount included
- black finish
- monitor not included
- will fit monitors made to the VESA standard of 75 mm or 100 mm hole spacing in a square configuration

Conference

Flat Screen Mount - Universal Bracket (standard with TV, DTV and FSTV model)

Peerless® ST650 universal tilting flat screen mount is supplied with the FSTV Flat Screen Mounting Frame.

- For use with 32"-50" screens
- Maximum weight 175 lbs. (79kg)
- Tilt 15° forward and -5° backward angles
- Mounting pattern allows up to 6" of vertical adjustment

NOTE: To verify TV interface to universal bracket

1. Access website - www.peerlessmounts.com
2. Locate "Mount Finder™" on home page side navigation bar
3. Enter make and/or model of your flat screen
4. Verify model: ST650 is listed as available model

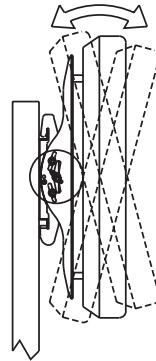

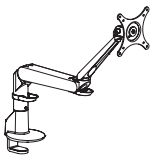
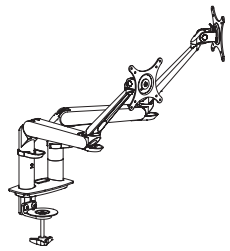
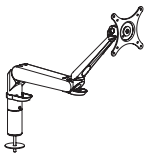
Description	D	W	H	CTN WT	CU FT	① Model	List Price
Monitor Arm - Edge Mount  <ul style="list-style-type: none"> · mounts to edge of worksurface · silver or black 				9	1	GP5901MA	\$709
Dual Monitor Arm - Edge Mount  <ul style="list-style-type: none"> · mounts to edge of worksurface · supports two monitors · silver or black 				18	2	GP5902MA	\$1,277
Monitor Arm  <ul style="list-style-type: none"> · mounts through hole in worksurface · field drilled and field installed · supports up to 12 lbs and/or 27" monitor · silver or black 				9	1	GP5905MA	\$791

To Order, Specify:

① Model number