

Brogan



BROGAN

Desks [BG16](#)
 Modesty Panels [BG19](#), [BG21](#)
 Returns and Bridges [BG22](#)
 Credenzas [BG24](#)
 Modular Components [BG26](#)
 Overhead Cabinets [BG28](#)
 Wall Mount Storage [BG29](#)
 Tackboards [BG28](#)
 Transaction Counters [BG30](#)
 Bookcases [BG31](#)
 Lateral Files [BG32](#)
 Freestanding Tables [BG34](#)
 Storage Cabinets [BG35](#)

Brogan - Overview

Desks

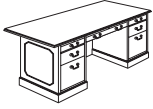

[Executive Double Pedestal Desk](#)

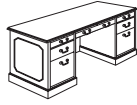

[Double Pedestal Desk](#)



[Table Desk](#)



[Electric Adjustable Height Table Desk](#)



[Pneumatic Adjustable Height Table Desk](#)

Desk Applications

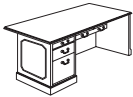

[Single Pedestal Desk](#)

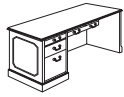

[Single Pedestal Desk](#)

Peninsula Desks

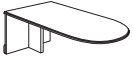

[Bullet Peninsula Desk](#)



[P-Top Peninsula Desk](#)

Peninsula Desk Bases and Modesty Panels



[Column Base](#)

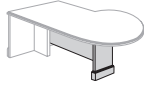

[3/4 Modesty Panel](#)

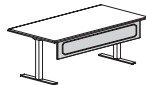

[Adjustable Table Modesty Panel Page](#)

Return and Corner Unit Applications

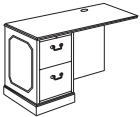

[File/File Return](#)



[Lateral File Return](#)

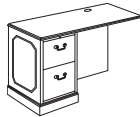

[File/File Corner](#)



[Lateral File Corner Return](#)



[Corner Unit](#)

Bridge Applications

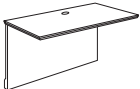

[Executive Bridge](#)

Brogan - Overview

Credenzas

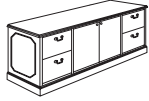

[Storage Credenza](#)

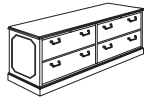

[Lateral File Credenza](#)

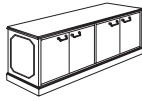

[Four Door Credenza](#)



[Two Door Credenza](#)

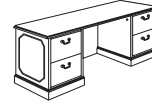

[Kneespace Credenza](#)

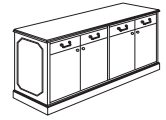

[Buffet Credenza](#)

Credenza Applications

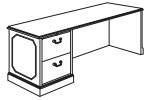

[File/File Pedestal Credenza](#)

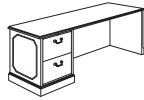

[File/File Reception Pedestal Credenza](#)

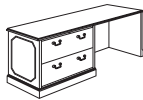

[Lateral File Pedestal Credenza](#)



[Multi-File Pedestal Credenza](#)

Modular Applications

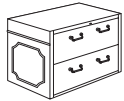

[Modular Lateral File](#)

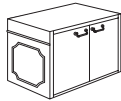

[Modular Storage Cabinet](#)

Credenza Tops and Bases



[Modular Credenza Tops](#)



[Modular Credenza Bases](#)

Modular Bookcases

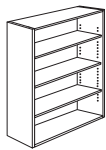

[Modular Open Bookcase](#)

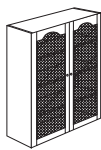

[Modular Grille Door Bookcase](#)

Modular Bookcase Tops



[Modular Bookcase Tops](#)

Brogan - Overview

Overhead Cabinets



[Open Storage Overhead Cabinet](#)



[Storage Overhead Cabinet with Four Doors](#)



[Storage Overhead Cabinet with Clear Glass](#)

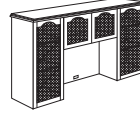

[Storage Overhead Cabinet with Glass/Grille](#)

Tackboards



[Tackboard for Storage Overhead Cabinet](#)



[Tackboard for Storage Overhead Cabinet](#)

Wall Mount Storage

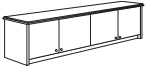

[Wall Mount Overhead with Four Doors](#)

Tackboards



[Wall Mount Tackboards](#)

Transaction Counters

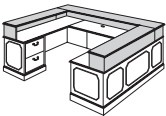

[Transaction Counter for U Unit](#)

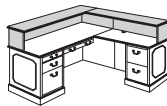

[Transaction Counter for L Unit](#)

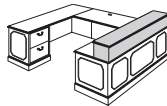

[Transaction Counter](#)

Bookcases

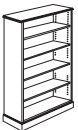

[Bookcase](#)

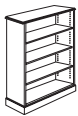

[Bookcase](#)



[Bookcase](#)

Lateral Files



[Lateral File](#)



[Lateral File](#)

Brogan - Overview

Storage Cabinets

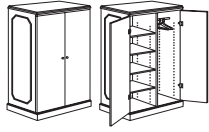

[Wardrobe](#)



[Hanging Bar to Shelves Conversion Kit](#)

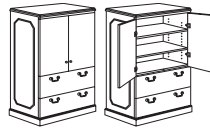

[File/File Lateral Storage Cabinet](#)

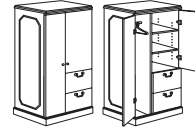

[File/File Storage Wardrobe](#)

Printer Stand



[Printer Stand](#)

Corner Unit

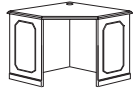

[Corner Unit](#)

Tables



[Sofa Table](#)



[Magazine Table](#)



[End Table](#)

Accessories

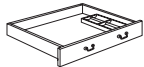

[Center Drawer](#)

Brogan Product Information

Exterior Wood Materials

Exterior surfaces are made from the finest selected veneers to achieve clarity and consistency in the Brogan product line. To attain a pleasing, symmetrical pattern, all veneers in Brogan are book-matched. All exterior solid lumber is matched to coordinate with the veneer.

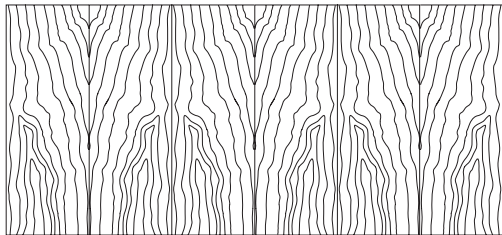

Alternating pieces of veneer are flipped over so they face each other like the pages within a book.

Brogan is available in flat cut cherry and walnut veneer. A wide range of wood stains have been formulated to enhance the beauty of the veneer.

Work Surface Construction

Tops are 5-ply balanced construction, 1 3/8" thick with solid matching hardwood edges.

Coordinating high pressure laminate in a veneer grain pattern can be applied to the top surface and is available at no additional charge.

Case Construction

All construction is a combination of full mortise and tenon, reinforced with screws. Leveling glides are set in solid hardwood to prevent glides tear out.

Outside End Panels are 1 3/8" thick with 3-ply construction and rimmed with veneer bands.

Drawer Construction

Drawers are assembled using four corner, dovetailed box and 1/4" thick drawer bottom panel construction with exterior front attached separately. Sides and backs are 9-ply, 7/8" thick unidirectional hardwood. Interiors are sanded and finished with clear catalyzed varnish to protect against shrinking, swelling or warping, and to provide a clean, smooth feel and appearance.

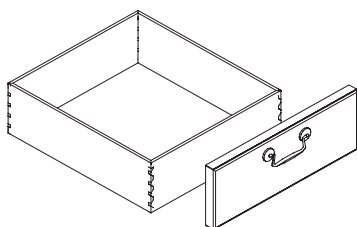

Drawer Suspension

The high quality black drawer suspensions carry a lifetime warranty. Slides feature steel ball bearings for longer life with cushioned in/out stops. All drawers, including file and box drawers, fully extend past the pedestal chassis allowing full access to the drawer box.

Filing Hardware

All file drawers are constructed with a custom designed filing system in place to allow for hanging folders. Filing diagram on pages [BG14-BG15](#).

Locking

All desk, and lateral files feature central locking. Credenza and returns feature pedestal locking.

Units are shipped randomly keyed as standard. Key alike units are available upon request for no additional charges. Removable cores for in-field re-keying are standard.

Finish - Stain/Colors

We offer a variety of wood stains on Brogan. Please see the chart below. Samples are available upon request.

ESS Essentials Veneer Collection

BRK	Brickdust	OBK	Outback
CSK	Cask	SIE	Sienna
CLY	Clay	TRF	Truffle
MES	Mesa	UMB	Umber
MCH	Mocha		

Protective Top Coat

DuraTex™ offers exceptional hardness along with abrasion and impact resistance, it has been formulated to eliminate hazardous and harmful gases that are normally associated with wood finish.

DuraTex™ Features

Safety - Significantly reduces hazardous formaldehyde emissions, which help improve the quality of the indoor air we breathe.

Quality - Developed to be tough and durable with special attention to appearance. The DuraTex™ finish preserves the natural beauty of wood.

Durability - Designed to meet a wide range of demanding performance and environmental standards to withstand even the highest wear and tear.

Laminate Tops

Work surface only, no additional upcharge if Brogan's coordinating wood grain laminate is specified. Contact Customer Service for any other laminate request. Listed below are finishes that have coordinating wood grain HPL laminates.

ESS Essentials Veneer

BRK	Brickdust	MCH	Mocha
CSK	Cask	OBK	Outback
CLY	Clay	UMB	Umber
MES	Mesa		

Brogan Product Information

Product Modification

Finish Sheen

All casegood veneer finishes are standard in 35-sheen, with the exception of Raven, which is only offered in 15-sheen. All other finishes are available in 15-sheen, with a 5% upcharge, per model.

Custom/Special Finishes

JSI, upon request, will accommodate special finishes. A written request is required to proceed with custom finish orders. A sample reference is required for first-time matches and must be included with the written request.

There is a one-time charge of **\$384 list per order** for any non-standard wood finish.

Orders will be entered noting the special finish. A sample match will be provided to the customer. Written approval is needed before the finish process can be started. Delays in approval may have an impact on lead times.

Every effort will be made to create the requested match; however, an acceptable match may not be possible because of natural variations of wood. These natural variations can also cause minor differences in the final finish product.

Use standard pricing and option pricing for each line item with a special finish, unless additional modifications have been specified. For items available in both Essential and Artisan veneers, apply the Essentials pricing.

Pedestal Configuration Change

Writing shelf-tray-box-file drawer configuration standard on desk pedestals. Desk pedestal only can be switched out to a file-file configuration. Must be specified at the time of order with an additional **\$198 list per pedestal**.

Changing to a file-file pedestal configuration will eliminate the writing shelf (arm slide).

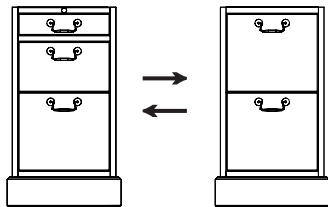

Desk Dictation Slide

The approach side of the desk in the center break front area has an option of a center pullout dictation slide. Add **\$496** to the list price of the desk.

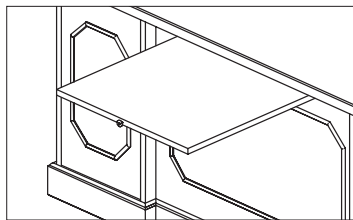

Product Modification

Trim Molding

Angled Trim molding is standard on all Brogan products.

Without molding or Scalloped Trim molding can be specified at the time of order placement.

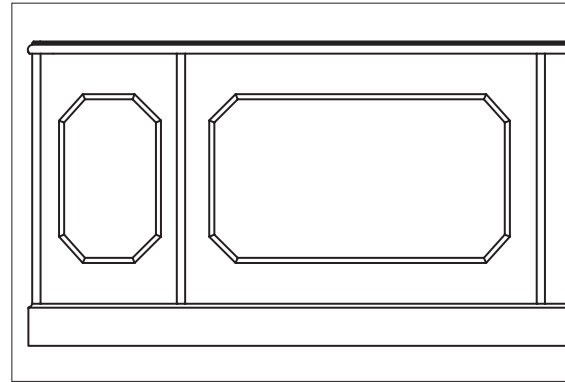

Angled Trim
standard

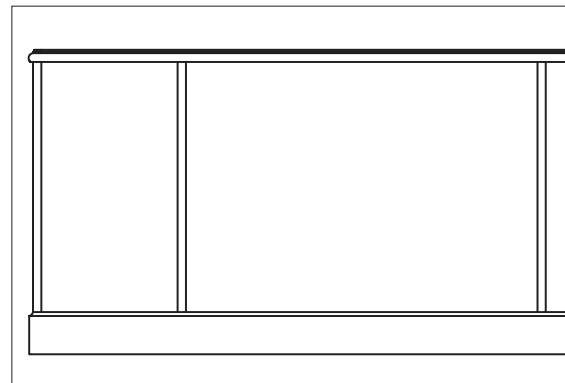

Base Molding Only (without trim)
optional at no charge

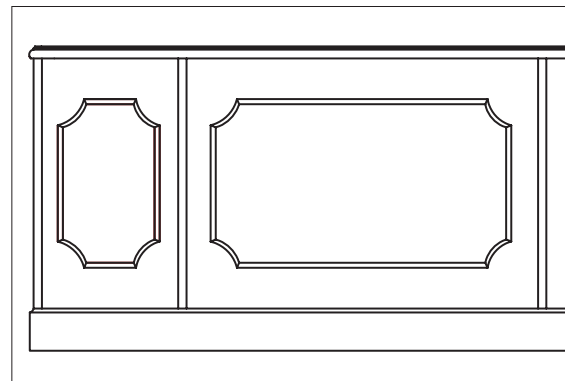

Scalloped Trim

optional with upcharge to list for each item

\$151 for all desk

\$79 for all other product with standard trim molding

Brogan Product Information

BROGAN

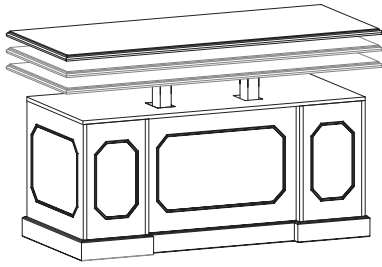

ERGO Adjustable Work Height Mechanism

Our proprietary adjustable work height mechanism can be specified on many of the models in Brogan.

ERGO mechanism allows height adjustability to be added to the worksurface. Our solution uses a standardized design that minimizes the modifications required to standard desk, bridge, or credenza models. The mechanism and control box are neatly concealed to maintain the appearance of the original elegance of the product. A push button activates the electric powered lifting columns for adjustability from sitting height to a standing height. A $\frac{3}{4}$ " thick finished sub top is added to the top of the desk chassis for a clean appearance when the surface is in the raised position. In the lowered position, please note that ERGO adds $\frac{3}{4}$ " to the standard height of the desk and the installation will decrease kneespace depth by 8".

Automatic Collision Control is built into each mechanism as a standard feature. When the system senses an obstacle obstructing the movement, the mechanism will reverse direction and retreat by 1".

When ERGO is added to a desk worksurface in a "L" or "U" group, the unit that connects to the desk also needs to have a sub top added. These units are considered to be ERGO ADJACENT units. ERGO ADJACENT units must have a fixed height worksurface that matches the lowest position of the ERGO mechanism and the top. This is accomplished by adding a $\frac{3}{4}$ " sub top between the chassis and the worksurface. This feature can also be specified for cabinets which may sit next to a unit with the ERGO mechanism.

Height adjustment starts at 30 $\frac{3}{4}$ ", to a standing height of 50 $\frac{1}{4}$ ", a range of 19 $\frac{1}{2}$ ".

To specify the unit that has the mechanism, add **ERGO** to the end of the model number.
To specify the connecting or adjacent units add, **ERGO ADJACENT** to the end of the model number.

Note: The kneespace depth is decreased when the ERGO mechanism is specified. Contact Customer Service for dimension information.

The Ergo mechanism and controls are warranted for a period of (1) year. The rest of the casegood unit(s) are warranted under the Lifetime Warranty.

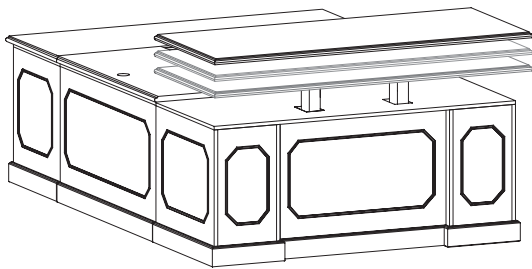

Example

BG3672LD-ERGO	add \$4,981 to list
BG2448EB-ERGO ADJACENT	add \$625 to list
BG2472RC-ERGO ADJACENT	add \$733 to list

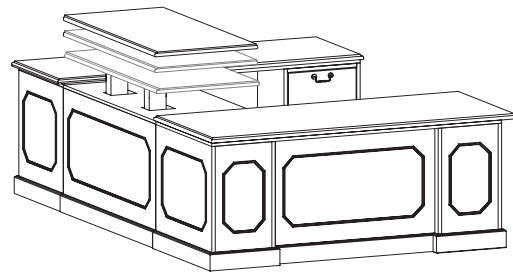

Example

BG3672LD-ERGO ADJACENT	add \$733 to list
BG2448EB-ERGO	add \$4,981 to list
BG2472RC-ERGO ADJACENT	add \$733 to list

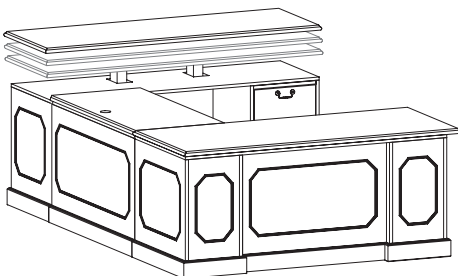

Example

BG3672LD-ERGO ADJACENT	add \$733 to list
BG2448EB-ERGO ADJACENT	add \$625 to list
BG2472RC-ERGO	add \$4,981 to list

Brogan Product Information

Availability of Brogan Units with the Mechanism

The following models are available with the ERGO Adjustable Work Height Mechanism. When specifying add "ERGO" to the end of the model number.

Adjacent Connecting Units - Models below require adjacent products to create "L" or "U" layouts; add \$4,981 to the list price.

<u>Single Pedestal Desk</u>	<u>Bridges</u>	<u>Credenzas</u>	<u>Returns</u>	<u>Corner Units</u>
BG3672LD	BG2448EB	BG2472LC	BG2448ELCR	BG4242CU
BG3672RD	BG2442EB	BG2472RC	BG2448ERCR	BG4242ELCU
BG3072LD	BG2436EB	BG2466LC	BG2448ELR	BG4242ERCU
BG3072RD		BG2466RC	BG2448ERR	
BG3066LD			BG2442ELCR	
BG3066RD			BG2442ERCR	
			BG2442ELR	
			BG2442ERR	

Freestanding Units - Models below do not require adjacent products; add \$4,981 to the list price.

<u>Double Pedestal Desk</u>	<u>Credenzas</u>
BG4284ED	BG2472KC
BG4278ED	BG2466KC
BG3672ED	
BG3672DD	
BG3072DD	
BG3066DD	
BG3060DD	

Connecting or Adjacent Units to Match Starting Height

All the units listed above can be specified as connecting or adjacent units. Other Brogan units could also be used as connecting units. Please contact Customer Service for additional items and pricing. When specifying, please add "ERGO ADJACENT" to the end of the model number.

Pricing for Standard Connecting or Adjacent Units
 Tops larger than 24" x 48" add \$733 to list price.
 Tops 24" x 48" or smaller add \$625 to list price.

Brogan Product Information

Edge and Hardware

Brogan offers a traditional edge profile and three drawer pulls. Hardware is available in antique brass or antique pewter.

Edge Profile

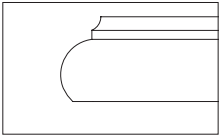

Brogan Edge Profile
Accepts Laminate Top

Drawer Hardware

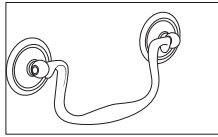

Brogan Hardware
Antique Brass (ANB)
Antique Pewter (ANP)

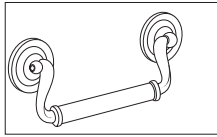

Gala Hardware
Antique Brass (ANB)
Antique Pewter (ANP)

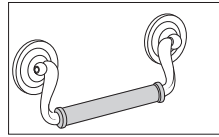

Gala Leather Wrapped Hardware
Antique Brass (ANB)
Antique Pewter (ANP)

Optional matching leather wrapped pulls available for desk with leather inlay or other coordinating units. Specify leather wrapped pulls, add \$61 list upcharge per pull. Indicate Antique Brass (ANB) or Antique Pewter (ANP) pull.

Worksurface Grommets

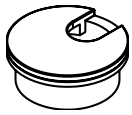

Worksurface Grommet
Antique Brass (ANB)
Black (BLK)

Worksurface grommets are standard on bridges, corner units, returns and the backs of overheads. Additional worksurface grommets can be specified on desks, credenzas, and other types of veneer/laminate worksurfaces. The grommet location must be approved by JSI manufacturing, contact Customer Service.

Add \$118 to the list for each additional grommet.

Models with an Antique Brass pull will receive an Antique Brass grommet, those with an Antique Pewter pull will receive a Black grommet.

BG4284ED

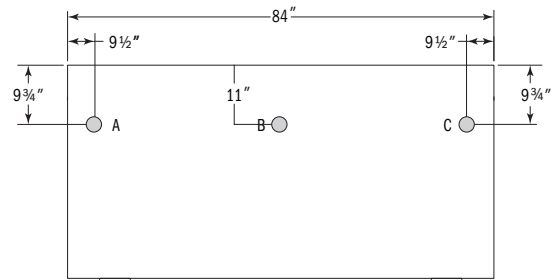

BG4278ED and BG3672ED

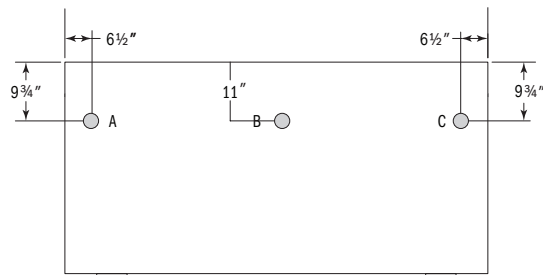

BG3672RD and BG3672LD



Brogan Product Information

Grommet and Color Options Continued

Desk without Overhang

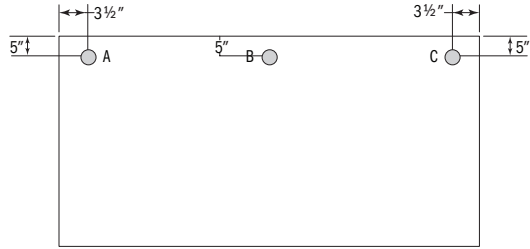

Support End and Run-Off Desks



Bridges, Returns and Credenzas

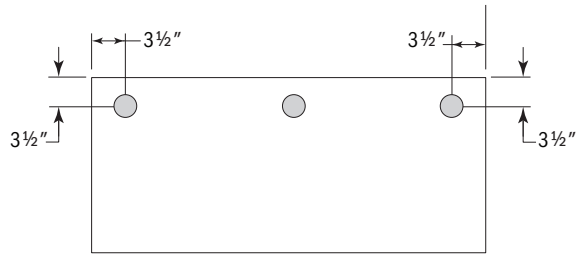

Brogan Product Information

Decorative Doors

Brogan offers four overhead cabinet models with two door styles, 72" & 66" wide overhead with clear glass doors and 72" & 66" wide overhead with open glass/grille mesh in two finishes, Antique Brass and Antique Pewter.

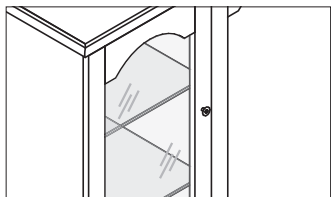

Clear Glass (not low iron)
with clear glass shelves

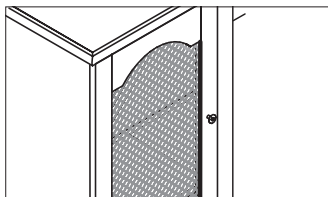

Glass/Grille
Antique Brass (ANB)
Antique Pewter (ANP)

3-Piece Leather Inlay

Brogan can be enhanced with a 3-Piece Leather Inlay, which may be added to the worksurface of any freestanding desk excluding the adjustable height table desk for a \$2,562 list price upcharge.

Models

BG4284ED	BG3672DD	BG3672TD	BG3672RD	BG3066RD
BG4278ED	BG3072DD	BG3066TD	BG3672LD	BG3066LD
BG3672ED	BG3066DD		BG3072RD	
	BG3060DD		BG3072LD	



Cortina Leather Options

Caprone
Old English

Leather Inlay is limited to specific style and thickness of leather.
Call Customer Service for more information.
Visit jsifurniture.com for leather colors.

Brogan Product Information

Finish and Product Reference Codes

Select	Code
Essentials Veneer Collection	
Brickdust	BRK
Cask	CSK
Clay	CLY
Mesa	MES
Mocha	MCH
Outback	OBK
Sienna	SIE
Truffle	TRF
Umber	UMB

Essentials Veneer with Laminate Top

Brickdust	BRK
Cask	CSK
Clay	CLY
Mesa	MES
Mocha	MCH
Outback	OBK
Umber	UMB

Select	Code
Top Edge Profile	
Traditional Edge	

Pull/Hardware Finish

Brogan	
Antique Brass	ANB
Antique Pewter	ANP
Gala	
Antique Brass	ANB
Antique Pewter	ANP

Molding Trim

Angled Trim	
Base Molding Only	
Scalloped Trim	see page BG7 price add-on

Top Grommet Finish

2" dia. Antique Brass
2" dia. Black

Brogan Product Information

Standard Filing Option & Interior Drawer Sizes

- Models
 BG4284ED Desk
 BG4278ED Desk
 BG3672ED Desk
 BG3672DD Desk

	D	W	H
Tray	21"	14 7/8"	1 7/8"
Box	21"	14 7/8"	4 1/4"
File	21"	14 7/8"	9 3/8"

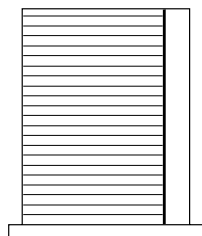

Legal
Front to Back

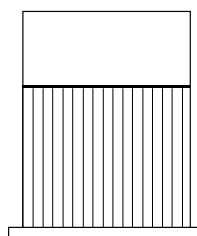

Letter
Side to Side

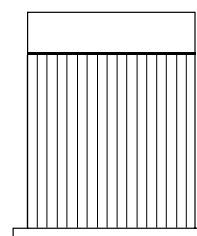

Legal
Side to Side Only

- Models
 BG3072DD Desk
 BG3066DD Desk
 BG3060DD Desk
 BG3672RD Desk
 BG3672LD Desk
 BG3072RD Desk
 BG3072LD Desk
 BG3066RD Desk
 BG3066LD¹ Desk

	D	W	H
Tray	21"	11 7/8"	1 7/8"
Box	21"	11 7/8"	4 1/4"
File	21"	11 7/8"	9 3/8"

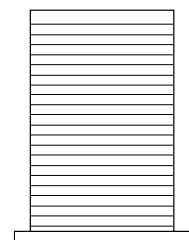

Letter
Front to Back

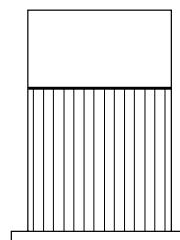

Letter
Side to Side

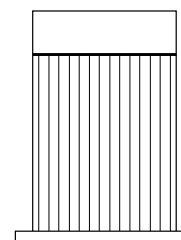

Legal
Side to Side

- Models
 BG2472SC Storage Credenza
 BG2466SC Storage Credenza
 BG2472KC Kneespace Credenza
 BG2466KC Kneespace Credenza

	D	W	H
File	21"	11 7/8"	9 3/8"

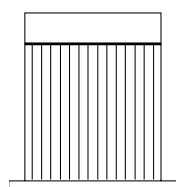

Letter
Side to Side

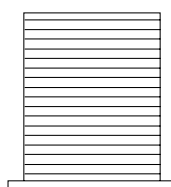

Legal
Front to Back

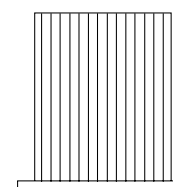

Legal
Side to Side

- Models
 BG2472LFC Lateral File Credenza
 BG3654LF Lateral File Cabinet
 BG3630LF Lateral File Cabinet

	D	W	H
Lateral File	15 1/4"	31"	9 3/8"

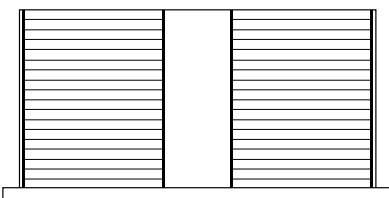

Letter
Double Front to Back

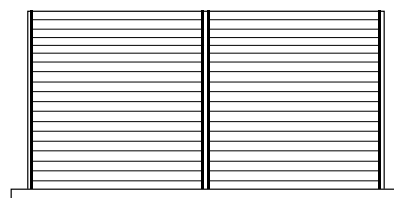

Legal
Double Front to Back

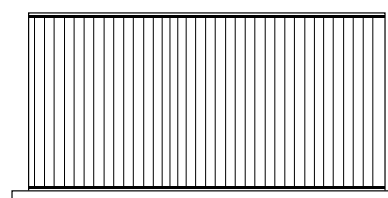

Legal
Side to Side

Brogan Product Information

Models

BG2448ERR	Return
BG2448ELR	Return
BG2448ERCR	Return
BG2448ELCR	Return
BG2442ERR	Return
BG2442ELR	Return
BG2442ERCR	Return
BG2442ELCR	Return
BG2448LRR	Return
BG2448LLR	Return
BG2448LLR	Return
BG2448LRCR	Return
BG2448LLCR	Return
BG3672SWLF	Storage Cabinet
BG2472SWR	Storage Cabinet
BG2472SWL	Storage Cabinet

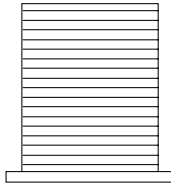

Letter
Front to Back

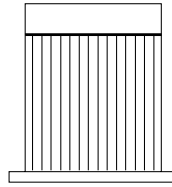

Letter
Side to Side

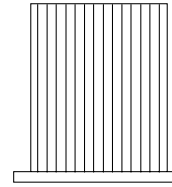

Legal
Side to Side Only

	D	W	H
File	15 1/4"	11 7/8"	9 3/8"
Lateral	15 1/4"	31"	9 3/8"

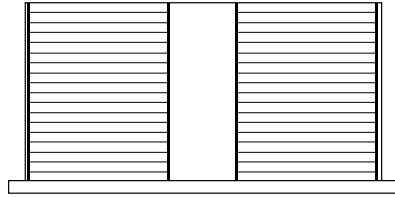

Letter
Double Front to Back

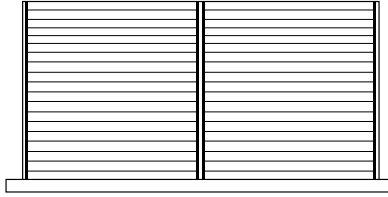

Legal
Double Front to Back

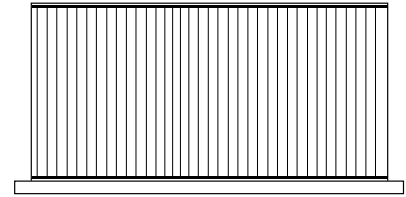

Legal
Side to Side

Models

BG2472RC	Credenza
BG2472LC	Credenza
BG2466RC	Credenza
BG2466LC	Credenza
BG2472RCR	Credenza
BG2472LCR	Credenza
BG2472LRC	Credenza
BG2472LLC	Credenza
BG2472MRC	Credenza
BG2472MLC	Credenza

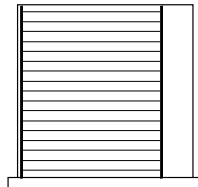

Legal
Front to Back

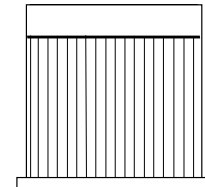

Letter
Side to Side

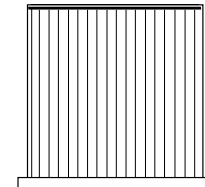

Legal
Side to Side

	D	W	H
File	15 1/4"	14 7/8"	9 3/8"
Lateral	15 1/4"	31"	9 3/8"

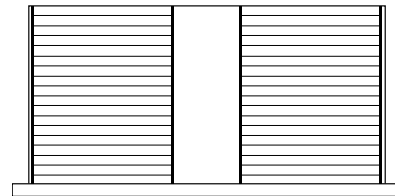

Letter
Double Front to Back

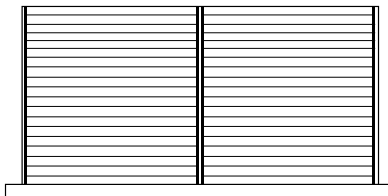

Legal
Double Front to Back

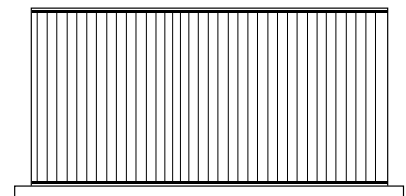

Legal
Side to Side

Other Models

BG2472BSC	Buffet Credenza
BG3672TD & BD3066TD	Table Desk
BG1826CDB	Center Drawer

Drawer Type	D	W	H
Box Drawer	15 1/4"	14 3/16"	4 1/4"
Pencil Drawer	19 7/16"	23"	1 7/8"
Pencil Drawer	16"	26"	1 7/8"

Description	D	W	H	CTN WT	CU FT	① Model	List Price
Executive Desk	42	84	30	480	71	BG4284ED	\$7,166
	42	78	30	460	66	BG4278ED	\$6,393
	36	72	30	340	53	BG3672ED	\$4,977

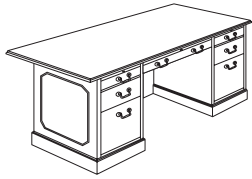

- locking center drawer
- central locking
- writing shelf/tray/box/file
- 3-piece leather inlay available, specify and \$2,562 add list
- BG4284ED has a 6" overhang on each end and 6" overhang on the approach side
- BG4278ED & BG3672ED has a 3" overhang on each end and 6" overhang on the approach side
- BG4284ED & BG4278ED have legal width pedestals
- BG3672ED has letter width pedestals
- BG4284ED chassis - 36" x 72"
- BG4278ED chassis - 36" x 72"
- BG3672ED chassis - 30" x 66"
- BG4284ED kneespace - 33"
- BG4278ED kneespace - 33"
- BG3672ED kneespace - 33"
- 24 $\frac{7}{8}$ " clearance from floor to bottom of center drawer

Double Pedestal Desk	36	72	30	435	53	BG3672DD	\$5,519
	30	72	30	320	44	BG3072DD	\$4,833
	30	66	30	310	41	BG3066DD	\$4,691
	30	60	30	300	37	BG3060DD	\$4,378

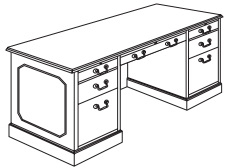

- writing shelf/tray/box/file
- letter width pedestals
- locking center drawer
- central locking
- 3-piece leather inlay available, specify and \$2,562 add list
- BG3672DD chassis - 36" x 72"
- BG3072DD chassis - 30" x 72"
- BG3066DD chassis - 30" x 66"
- BG3060DD chassis - 30" x 60"
- BG3672DD, BG3072DD and BG3066DD kneespace - 33"
- BG3060DD kneespace - 27"
- 24 $\frac{7}{8}$ " clearance from floor to bottom of center drawer

Description	D	W	H	CTN WT	CU FT	① Model	List Price
Table Desk	36	72	30	170	53	BG3672TD	\$3,899
	30	66	30	150	41	BG3066TD	\$3,423



- locking center drawer
- 24 7/8" clearance from floor to bottom of center drawer
- 3-piece leather inlay available, specify and \$2,562 add list

To Order, Specify:

- ① Model Number
- ② Finish Color ([see page BG13](#))
- ③ Pull Style and Color ([see page BG13](#))
- ④ Other Product Options ([see page BG7-BG12](#))
- ⑤ Accessories, Power and Data

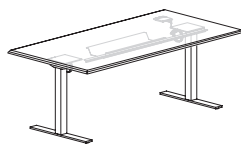
Description	D	W	H	CTN WT	CU FT	① Model	List Price
Electric Adjustable Height Table Desk 	36	72	Adj.	194	18	BG3672AHTD-EL	\$3,143
	30	72	Adj.	175	16	BG3072AHTD-EL	\$3,022
	30	66	Adj.	168	15	BG3066AHTD-EL	\$2,988
	30	60	Adj.	160	14	BG3060AHTD-EL	\$2,952
	24	72	Adj.	151	12	BG2472AHTD-EL	\$2,902
	24	66	Adj.	146	11	BG2466AHTD-EL	\$2,872
	24	60	Adj.	140	10	BG2460AHTD-EL	\$2,845

- 22 1/2" - 49" height adjustment
- top edge profile on user and approach sides
- push button control pad mounted right or left
- maximum weight rating 140 lbs. (evenly distributed load)
- key pad features height display with three memory settings
- display will reference position to the nearest 1/2"
- 120" power cord
- specify Matte Black (MBK) or Arctic Silver (STS) base finish
- ships KD

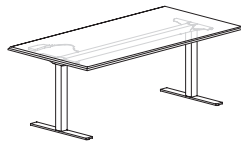
Pneumatic Adjustable Height Table Desk 	36	72	Adj.	194	18	BG3672AHTD-PN	\$5,504
	30	72	Adj.	175	16	BG3072AHTD-PN	\$5,267
	30	66	Adj.	168	15	BG3066AHTD-PN	\$5,112
	30	60	Adj.	160	14	BG3060AHTD-PN	\$4,951
	24	72	Adj.	151	12	BG2472AHTD-PN	\$4,931
	24	66	Adj.	146	11	BG2466AHTD-PN	\$4,845
	24	60	Adj.	140	10	BG2460AHTD-PN	\$4,741

- 27 1/2" - 44 1/2" height adjustment
- top edge profile on all sides
- release lever mounts under edge of top
- 225 lb. max load
- specify Matte Black or Alloy base finish
- ships KD

Description	D	W	H	CTN WT	CU FT	① Model	List Price
Modesty Panels for Adjustable Height Tables	¾	64	12	18	2	BG0964TDM	\$816
	¾	58	12	16	2	BG0958TDM	\$789
	¾	52	12	14	2	BG0952TDM	\$770

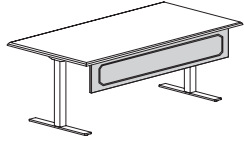

- BG0964TDM use with 72" wide adjustable height desk
- BG0958TDM use with 66" wide adjustable height desk
- BG0952TDM use with 60" wide adjustable height desk
- flat edge detail
- modesty panel bracket is available in Black Sandtex (BSX) or Stardust Silver (STS)

To Order, Specify:

- ① Model Number
- ② Finish Color ([see page BG13](#))
- ③ Pull Style and Color ([see page BG13](#))
- ④ Other Product Options ([see page BG7-BG12](#))
- ⑤ Accessories, Power and Data

Desk Applications

Executive L

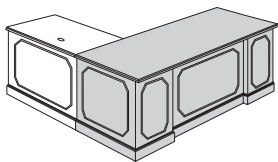

Executive U

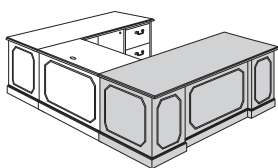

Computer U

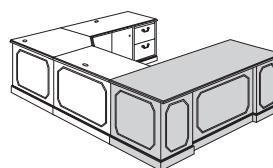

BROGAN

Description	D	W	H	CTN WT	CU FT	① Model	List Price
Single Pedestal Desk	36	72	30	270	53	BG3672RD	\$4,691
	36	72	30	270	53	BG3672LD	\$4,691

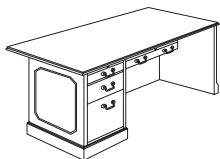

left shown

- 6" overhang on approach side
- chassis - 30" x 72"
- writing shelf/tray/box/file
- letter width pedestals
- locking center drawer
- central locking
- 3-piece leather inlay available, specify and \$2,562 add list

Single Pedestal Desk	30	72	30	260	44	BG3072RD	\$4,535
	30	72	30	260	44	BG3072LD	\$4,535
	30	66	30	240	41	BG3066RD	\$4,378
	30	66	30	240	41	BG3066LD	\$4,378



left shown

- writing shelf/tray/box/file
- letter width pedestals
- locking center drawer
- central locking
- 3-piece leather inlay available, specify and \$2,562 add list

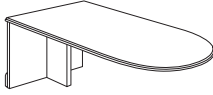
Description	D	W	H	CTN WT	CU FT	① Model	List Price
 right shown	36	72	30	185	53	BG3672RB	\$4,974
	36	72	30	185	53	BG3672LB	\$4,974
	30	72	30	177	44	BG3072RB	\$4,844
	30	72	30	177	44	BG3072LB	\$4,844

- not recommended for freestanding use
- bases must be purchased separately; see below for options

 right shown	42	72	30	210	58	BG4272RP	\$4,986
	42	72	30	210	58	BG4272LP	\$4,986

- 42" at widest point
- 36" at end panel
- not recommended for freestanding use
- bases must be purchased separately; see below for options

Bases Options and Modesty Panels for Peninsula Tops
 (these bases must be ordered separately from the desks listed above)

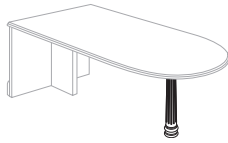

Wood Column Base
 • 04WB - Wood \$894

Base:
 • 4" diameter

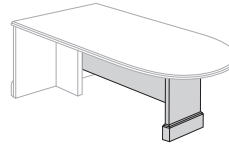
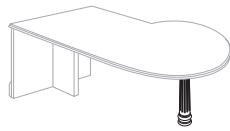

3/4 Modesty Panel
 • BG2454RMP - right \$1,049
 • BG2454LMP - left \$1,049

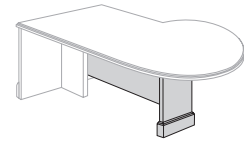

To Order, Specify:

- ① Model Number
- ② Finish Color ([see page BG13](#))
- ③ Pull Style and Color ([see page BG13](#))
- ④ Other Product Options ([see page BG7-BG12](#))
- ⑤ Accessories, Power and Data

Return Applications - Executive L

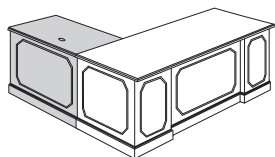

Description	D	W	H	CTN WT	CU FT	① Model	List Price
Executive Return	24	48	30	145	25	BG2448ERR	\$3,243
	24	48	30	145	25	BG2448ELR	\$3,243
	24	42	30	140	22	BG2442ERR	\$3,124
	24	42	30	140	22	BG2442ELR	\$3,124

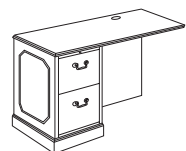

left shown

- one surface grommet
- short grain direction
- letter width file/file pedestal
- pedestal locking

Lateral File Return	24	48	30	170	25	BG2448LRR	\$3,950
	24	48	30	170	25	BG2448LLR	\$3,950

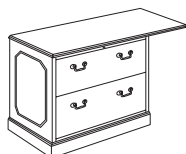

left shown

- 36" width lateral file
- no grommet
- short grain direction
- pedestal locking

Corner Unit Applications - Computer U

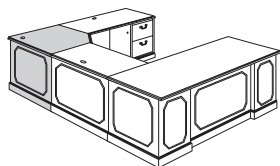

Description	D	W	H	CTN WT	CU FT	① Model	List Price
Executive Corner Unit	42	42	30	165	36	BG4242ERCU	\$3,277
	42	42	30	165	36	BG4242ELCU	\$3,277
	36	36	30	148	27	BG3636ERCU	\$3,018
	36	36	30	148	27	BG3636ELCU	\$3,018

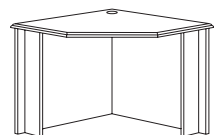

right shown

- straight grain top; direction determined by right and left units
- not for freestanding use
- use with pedestal return
- one surface grommet

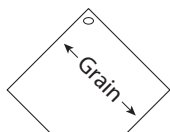

Corner Return Applications - Computer U

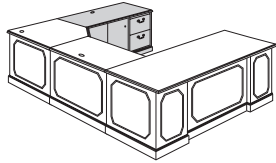

Description	D	W	H	CTN WT	CU FT	① Model	List Price
Executive Corner Return	24	48	30	145	25	BG2448ERCR	\$3,243
	24	48	30	145	25	BG2448ELCR	\$3,243
	24	42	30	140	22	BG2442ERCR	\$3,124
	24	42	30	140	22	BG2442ELCR	\$3,124

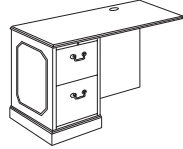

left shown

- use with corner unit
- one surface grommet
- long grain direction
- letter width file/file pedestal
- pedestal locking

Lateral File Corner Return	24	48	30	170	25	BG2448LRCR	\$3,950
	24	48	30	170	25	BG2448LLCR	\$3,950

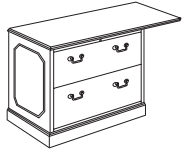

left shown

- use with corner unit
- 36" width lateral file
- anti-tip interlock mechanism
- no grommet
- long grain direction
- pedestal locking

Bridge Applications - Executive U

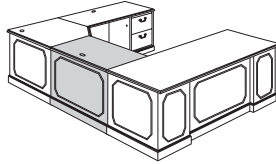

Description	D	W	H	CTN WT	CU FT	① Model	List Price
Executive Bridge	24	48	30	105	4	BG2448EB	\$1,650
	24	42	30	95	3	BG2442EB	\$1,520
	24	36	30	85	3	BG2436EB	\$1,416

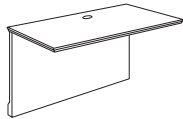

- one surface grommet
- short grain direction

To Order, Specify:

- ① Model Number
- ② Finish Color ([see page BG13](#))
- ③ Pull Style and Color ([see page BG13](#))
- ④ Other Product Options ([see page BG7-BG12](#))
- ⑤ Accessories, Power and Data

Description	D	W	H	CTN WT	CU FT	① Model	List Price
Storage Credenza Hinged Doors	24	72	30	290	36	BG2472SC	\$4,890
	24	66	30	270	33	BG2466SC	\$4,604

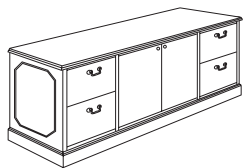

- legal width file/file pedestals
- adjustable shelf in center storage
- grommet located in top center of back panel
- pedestal locking
- locking doors available, specify and add \$147 list

Lateral File Credenza	24	72	30	300	36	BG2472LFC	\$5,087
-----------------------	----	----	----	-----	----	-----------	---------

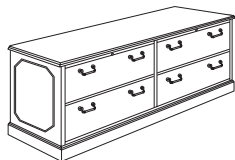

- two drawer lateral files side by side
- anti-tip interlock mechanism
- pedestal locking

Four Door Credenza	24	72	30	310	33	BG2472DSC	\$4,890
--------------------	----	----	----	-----	----	-----------	---------

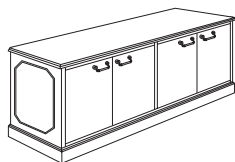

- adjustable shelves
- locking doors available, specify and add \$294 list

Two Door Credenza	24	36	30	90	15	BG3630SC	\$2,523
-------------------	----	----	----	----	----	----------	---------

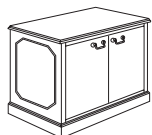

- one adjustable shelf
- locking doors available, specify and add \$147 list

Kneespace Credenza	24	72	30	240	36	BG2472KC	\$4,604
	24	66	30	220	33	BG2466KC	\$4,305

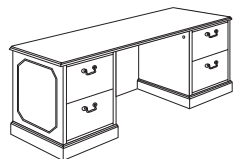

- legal width file/file pedestals
- grommet located in top center of back panel
- pedestal locking
- kneespace for BG2472KC - 33"
- kneespace for BG2466KC - 27"

Buffet Credenza	24	72	36	330	43	BG2472BSC	\$6,358
-----------------	----	----	----	-----	----	-----------	---------

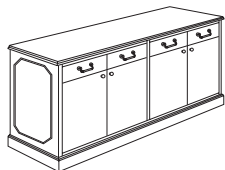

- four door credenza
- four box drawers above doors
- locking not available
- adjustable shelf in storage cabinet

Credenza Applications - Executive U

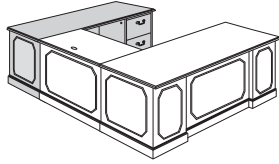

Description	D	W	H	CTN WT	CU FT	① Model	List Price
Pedestal Credenza	24	72	30	220	36	BG2472RC	\$4,215
	24	72	30	220	36	BG2472LC	\$4,215
left shown	24	66	30	210	33	BG2466RC	\$3,835
	24	66	30	210	33	BG2466LC	\$3,835

- grommet located in top center of back panel
- legal width file/file pedestal
- pedestal locking

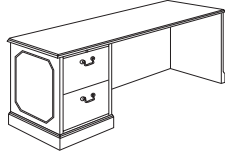

left shown

Reception Pedestal Credenza	24	72	30	220	36	BG2472RCR	\$4,215
	24	72	30	220	36	BG2472LCR	\$4,215

- no grommet
- legal width file/file pedestal
- pedestal locking

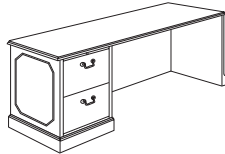

left shown

Lateral Pedestal Credenza	24	72	30	230	36	BG2472LRC	\$4,800
	24	72	30	230	36	BG2472LLC	\$4,800

- no grommet
- pedestal locking

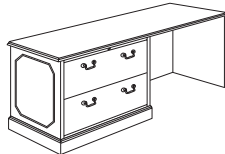

left shown

Multi-File Pedestal Credenza	24	72	30	265	36	BG2472MRC	\$4,990
	24	72	30	265	36	BG2472MLC	\$4,990

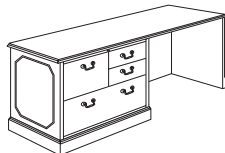

- no grommet
- pedestal locking



left shown

To Order, Specify:

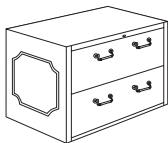
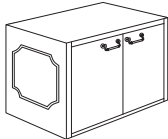
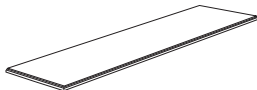
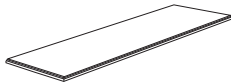
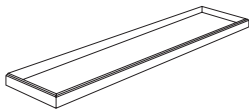
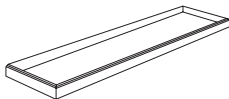
- ① Model Number
- ② Finish Color ([see page BG13](#))
- ③ Pull Style and Color ([see page BG13](#))
- ④ Other Product Options ([see page BG7-BG12](#))
- ⑤ Accessories, Power and Data

Description	D	W	H	CTN WT	CU FT	① Model	List Price
Modular Lateral File  <ul style="list-style-type: none"> · anti-tip interlock mechanism · pedestal locking · no molding, molding on left, molding on right · top and base required, see below 	23 ¼	34 ½	24 ¼	120	15	BG2436MLF	\$2,742
Modular Storage Cabinet  <ul style="list-style-type: none"> · one adjustable shelf · non-locking · no molding, molding on left, molding on right · top and base required, see below 	23 ¼	34 ½	24 ¼	90	15	BG2436MSC	\$2,305
Modular Credenza Top  <ul style="list-style-type: none"> · for use with three modular units; BG2436MLF or BG2436MSC 	24	105 ¾	1 ⅙	45	6	BG24108MCT	\$1,621
Modular Credenza Top  <ul style="list-style-type: none"> · for use with two modular units; BG2436MLF or BG2436MSC 	24	72	1 ⅙	30	4	BG2472MCT	\$1,093
Modular Credenza Base  <ul style="list-style-type: none"> · for use with three modular units; BG2436MLF or BG2436MSC 	23 ⅝	105	4 ¼	60	7	BG24108MCB	\$843
Modular Credenza Base  <ul style="list-style-type: none"> · for use with two modular units; BG2436MLF or BG2436MSC 	23 ⅝	70 ¾	4 ¼	30	4	BG2472MCB	\$602
Modular Credenza Base 	23 ⅝	35 ¾	4 ¼	20	3	BG2436MCB	\$430

BROGAN

Description	D	W	H	CTN WT	CU FT	① Model	List Price
Modular Open Bookcase	15	34 ½	40 13/16	105	17	BG1542MBC	\$1,662

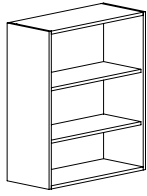

- two adjustable shelves

Modular Glass/Grille Door Bookcase	15	34 ½	40 13/16	105	17	BG1542MGBC	\$2,984
---	----	------	----------	-----	----	-------------------	----------------

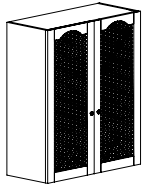

- two adjustable shelves
- non-locking
- specify grille color - antique brass (ANB) or antique pewter (ANP)

Modular Bookcase Top	15 7/8	105	1 3/16	73	5	BG15108MCT	\$1,136
-----------------------------	--------	-----	--------	----	---	-------------------	----------------

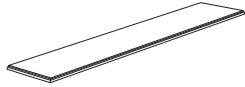

- for use with three single bookcases; BG1542MGBC or BG1542MBC

Modular Bookcase Top	15 7/8	70 ½	1 3/16	48	3	BG1572MCT	\$768
-----------------------------	--------	------	--------	----	---	------------------	--------------

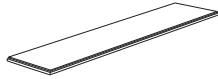

- for use with two single bookcases; BG1542MGBC or BG1542MBC

Modular Bookcase Top	15 7/8	36	1 3/16	23	2	BG1536MCT	\$439
-----------------------------	--------	----	--------	----	---	------------------	--------------



- for use with a single bookcase; BG1542MGBC or BG1542MBC

To Order, Specify:

- ① Model Number
- ② Finish Color ([see page BG13](#))
- ③ Pull Style and Color ([see page BG13](#))
- ④ Other Product Options ([see page BG7-BG12](#))
- ⑤ Accessories, Power and Data

Description	D	W	H	CTN WT	CU FT	① Model	List Price
Open Storage Overhead Cabinet	15 7/8	84	42	220	39	BG158400	\$3,643
	15 7/8	78	42	205	37	BG157800	\$3,575
	15 7/8	72	42	190	33	BG157200	\$3,501
	15 7/8	66	42	170	30	BG156600	\$3,348

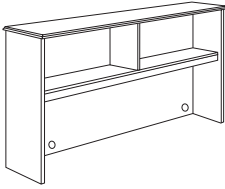

- tackboard available, see below and page [BG29](#)
- task lights available, see [accessories price list](#)
- grommet located bottom left and right and top center of back panel
- clearance opening for BG158400 - 19 1/2" h x 79 7/8" w
- clearance opening for BG157800 - 19 1/2" h x 73 7/8" w
- clearance opening for BG157200 - 19 1/2" h x 67 7/8" w
- clearance opening for BG156600 - 19 1/2" h x 61 7/8" w

Storage Overhead Cabinet with Four Doors	15 7/8	84	42	240	39	BG1584S0	\$3,833
	15 7/8	78	42	215	37	BG1578S0	\$3,759
	15 7/8	72	42	190	33	BG1572S0	\$3,687
	15 7/8	66	42	170	30	BG1566S0	\$3,531

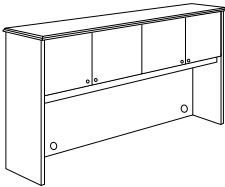

- tackboard available, see below and page [BG29](#)
- task lights available, see [accessories price list](#)
- grommet located bottom left and right and top center of back panel
- non-locking
- locking doors available, specify and add \$294 list
- clearance opening for BG1584S0 - 19 1/2" h x 79 7/8" w
- clearance opening for BG1578S0 - 19 1/2" h x 73 7/8" w
- clearance opening for BG1572S0 - 19 1/2" h x 67 7/8" w
- clearance opening for BG1566S0 - 19 1/2" h x 61 7/8" w

Description	D	W	H	CTN WT	CU FT	① Model	List Price Per Grade
Tackboard for 84" w Storage Overhead Cabinet	3/8	79 1/2	15 3/4	3	4	BG84TK	COM \$412
							A \$529
							B \$553
							C \$623
							D \$720
							E \$809
							F \$909
							G \$1,029
							H \$1,202
							I \$1,253
						J \$1,401	

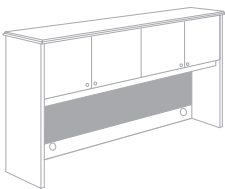

- for use with 84" wide storage overhead cabinet
- fabrics available; visit www.jsifurniture.com/finishes-and-materials/textiles for our textiles program
- com ydg: 2 3/4

Tackboard for 78" w Storage Overhead Cabinet	3/8	73 1/2	15 3/4	3	4	BG78TK	COM \$406
							A \$512
							B \$534
							C \$597
							D \$686
							E \$767
							F \$858
							G \$967
							H \$1,124
							I \$1,171
						J \$1,305	

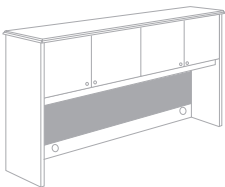

- for use with 78" wide storage overhead cabinet
- fabrics available; visit www.jsifurniture.com/finishes-and-materials/textiles for our textiles program
- com ydg: 2 1/2

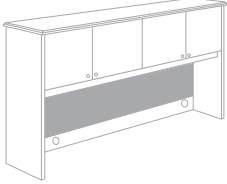
Description	D	W	H	CTN WT	CU FT	① Model	List Price Per Grade
Tackboard for 72" w Storage Overhead Cabinet  <ul style="list-style-type: none"> for use with 72" wide storage overhead cabinet fabrics available; visit www.jsifurniture.com/finishes-and-materials/textiles for our textiles program com ydg: 2 ¼ 	¾	67 ¾	15 ¾	2	3	BG72TK	COM \$383 A \$478 B \$498 C \$554 D \$634 E \$707 F \$789 G \$887 H \$1,029 I \$1,071 J \$1,192

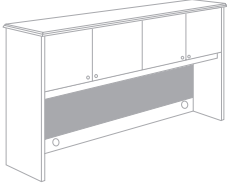
Tackboard for 66" w Storage Overhead Cabinet  <ul style="list-style-type: none"> for use with 66" wide storage overhead cabinet fabrics available; visit www.jsifurniture.com/finishes-and-materials/textiles for our textiles program com ydg: 2 	¾	61 ¾	15 ¾	2	3	BG66TK	COM \$359 A \$444 B \$461 C \$512 D \$582 E \$647 F \$720 G \$807 H \$933 I \$971 J \$1,079
---	---	------	------	---	---	--------	---

To Order, Specify:

- ① Model Number
- ② Finish Color ([see page BG13](#))
- ③ Pull Color ([see page BG13](#))
- ④ Fabric Selection: vendor, pattern, color
- ⑤ Other Product Options ([see page BG7-BG12](#))
- ⑥ Accessories, Power and Data

Description	D	W	H	CTN WT	CU FT	① Model	List Price
Storage Overhead Cabinet with Clear Glass	15 $\frac{7}{8}$	72	42	200	33	BG1572C0	\$5,222
	15 $\frac{7}{8}$	66	42	180	30	BG1566C0	\$4,956

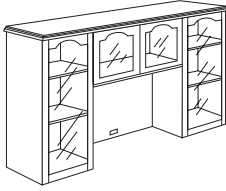

- four adjustable glass shelves
- grommets located in top and bottom center of back panel
- locking not available
- tackboards available, see below
- task lights available, see [accessories price list](#)
- BG1572C0 clearance opening - 23 $\frac{1}{2}$ " h x 33" w
- BG1566C0 clearance opening - 23 $\frac{1}{2}$ " h x 27" w
- interior lighting with 3 LED lights and on/off switch available, specify and add \$627

Storage Overhead Cabinet with Glass/Grille	15 $\frac{7}{8}$	72	42	200	33	BG1572G0	\$5,639
	15 $\frac{7}{8}$	66	42	180	30	BG1566G0	\$5,249

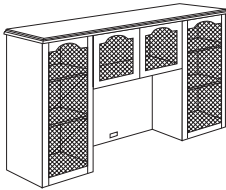

- four adjustable glass shelves
- grommets located in top and bottom center of back panel
- locking not available
- tackboards available, see below
- task lights available, see [accessories price list](#)
- BG1572G0 clearance opening - 23 $\frac{1}{2}$ " h x 33" w
- BG1566G0 clearance opening - 23 $\frac{1}{2}$ " h x 27" w
- interior lighting with 3 LED lights and on/off switch available, specify and add \$627
- specify grille color - antique brass or antique pewter

Description	D	W	H	CTN WT	CU FT	① Model	List Price Per Grade
Tackboard for 72" w Storage Overhead Cabinet	$\frac{3}{8}$	32 $\frac{7}{8}$	20 $\frac{5}{16}$	3	2	BG34TK	COM \$265
							A \$318
							B \$329
							C \$361
							D \$405
							E \$445
							F \$491
							G \$545
							H \$625
							I \$648
							J \$716

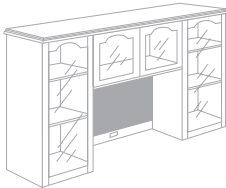

- for use with 72" wide storage overhead cabinet
- fabrics available; visit www.jsifurniture.com/finishes-and-materials/textiles for our textiles program com ydg: 1 $\frac{1}{4}$

Tackboard for 66" w Storage Overhead Cabinet	$\frac{3}{8}$	26 $\frac{7}{8}$	20 $\frac{5}{16}$	3	2	BG28TK	COM \$238
							A \$292
							B \$302
							C \$334
							D \$378
							E \$419
							F \$464
							G \$519
							H \$598
							I \$621
							J \$689



- for use with 66" wide storage overhead cabinet
- fabrics available; visit www.jsifurniture.com/finishes-and-materials/textiles for our textiles program
- com ydg: 1 $\frac{1}{4}$

Description	D	W	H	CTN WT	CU FT	① Model	List Price
Wall Mount Overhead with Four Doors	15 7/8	72	22	200	22	BG1572WSO	\$3,496
	15 7/8	66	22	190	20	BG1566WSO	\$3,344

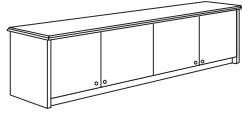

- tackboard available, see below
- task lights available, see [accessories price list](#)
- locking doors available, specify and add \$294 list

Description	D	W	H	CTN WT	CU FT	① Model	List Price Per Grade
72" w Wall Mount Tackboard	1 1/2	70	17	2	3	BG7220WT	COM \$464

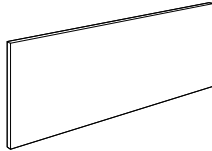

- for use with 72" wide wall mount overhead cabinet
- fabrics available; visit www.jsifurniture.com/finishes-and-materials/textiles for our textiles program
- four 3/8" deep x 2" wide vertical channels in back of panel allow wire management
- com ydg: 2 1/4

A	\$560
B	\$579
C	\$636
D	\$715
E	\$788
F	\$871
G	\$968
H	\$1,111
I	\$1,154
J	\$1,276

66" w Wall Mount Tackboard	1 1/2	64	17	2	3	BG6620WT	COM \$439
----------------------------	-------	----	----	---	---	----------	-----------

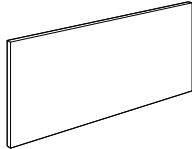

- for use with 66" wide wall mount overhead cabinet
- fabrics available; visit www.jsifurniture.com/finishes-and-materials/textiles for our textiles program
- four 3/8" deep x 2" wide vertical channels in back of panel allow wire management
- com ydg: 2

A	\$524
B	\$542
C	\$592
D	\$663
E	\$728
F	\$801
G	\$888
H	\$1,015
I	\$1,053
J	\$1,161

To Order, Specify:

- ① Model Number
- ② Finish Color ([see page BG13](#))
- ③ Pull Style and Color ([see page BG13](#))
- ④ Fabric Selection: vendor, pattern, color
- ⑤ Other Product Options ([see page BG7-BG12](#))
- ⑥ Accessories, Power and Data

Description	D	W	H	CTN WT	CU FT	① Model	List Price
Transaction Counter for U Unit	13	90	17 ³ / ₁₆	145	12	BG13186TC coordinates with BG2472RCR, BG2472LCR, and BG2442EB	\$2,780

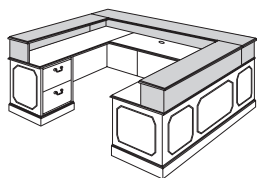

- for U units
- 16" vertical clearance from worksurface to bottom of transaction top

Transaction Counter for L Unit	13	66	17 ³ / ₁₆	110	9	BG13114RTC coordinates with BG3066LD BG2448ERR	\$2,169
--------------------------------	----	----	---------------------------------	-----	---	---	---------

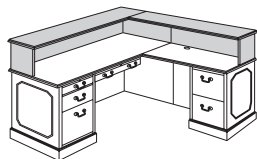

right shown

- for L units
- 16" vertical clearance from worksurface to bottom of transaction top

Transaction Counter	13	72	17 ³ / ₁₆	87	9	BG1372TC coordinates with a 72" surface	\$1,557
---------------------	----	----	---------------------------------	----	---	---	---------

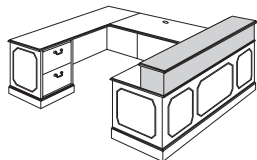

	13	66	17 ³ / ₁₆	79	8	BG1366TC coordinates with a 66" surface	\$1,488
--	----	----	---------------------------------	----	---	---	---------

- 16" vertical clearance from worksurface to bottom of transaction top

Description	D	W	H	CTN WT	CU FT	① Model	List Price
Bookcase	15	36	72	165	28	BG3672BC	\$2,989

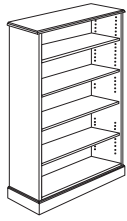

- one fixed shelf
- three adjustable shelves

Bookcase	15	36	54	135	21	BG3654BC	\$2,247
----------	----	----	----	-----	----	----------	---------

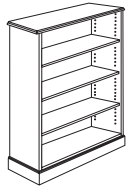

- three adjustable shelves

Bookcase	15	36	30	75	12	BG3630BC	\$1,497
----------	----	----	----	----	----	----------	---------



- one adjustable shelf

Bookcase Overhead	15	36	42	85	20	BG1536B0	\$1,502
-------------------	----	----	----	----	----	----------	---------



- for use with BG3630LF and BG3630SC
- one adjustable shelf
- one fixed shelf
- one back panel grommet standard

To Order, Specify:

- ① Model Number
- ② Finish Color ([see page BG13](#))
- ③ Other Product Options ([see page BG7-BG12](#))

Description	D	W	H	CTN WT	CU FT	① Model	List Price
Lateral File	24	36	54	280	33	BG3654LF	\$4,558



- four drawers
- edge profile on three sides
- anti-tip interlock mechanism
- pedestal locking

Lateral File	24	36	30	175	19	BG3630LF	\$3,016
--------------	----	----	----	-----	----	----------	---------

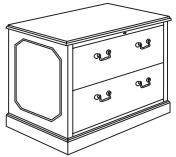

- two drawers
- edge profile on three sides
- anti-tip interlock mechanism
- pedestal locking

BROGAN

Description	D	W	H	CTN WT	CU FT	① Model	List Price
72" h Wardrobe	24	34 5/8	72	360	43	BG3672W	\$4,104

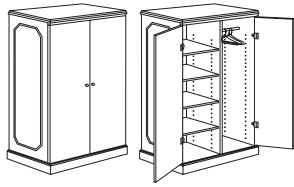

- chrome hanging bar on right
- shelves on left (second from bottom fixed)
- locking doors available; specify and add \$294 list

Hanging Bar to Shelves Conversion Kit			3/4	56	2	BG1824SK	\$884
--	--	--	-----	----	---	-----------------	--------------

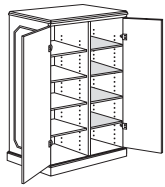

- four shelves
- for 36" wide wardrobe

72" h File/File Lateral Storage Cabinet	24	36	72	360	43	BG3672SWLF	\$5,739
--	----	----	----	-----	----	-------------------	----------------

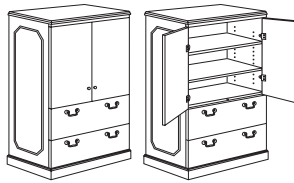

- two adjustable shelves
- locking doors available; specify and add \$147 list
- file/file lateral
- pedestal locking

72" h File/File Storage Wardrobe	24	23 5/8	72	340	30	BG2472SWR	\$3,980
	24	23 5/8	72	340	30	BG2472SWL	\$3,980

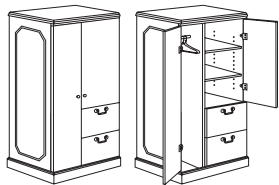

- chrome hanging bar
- two adjustable shelves
- bottom shelf fixed
- file/file pedestal
- locking not available

left shown

To Order, Specify:

- ① Model Number
- ② Finish Color ([see page BG13](#))
- ③ Pull Style and Color ([see page BG13](#))
- ④ Other Product Options ([see page BG7-BG12](#))

Description	D	W	H	CTN WT	CU FT	① Model	List Price
Printer Stand	24	30	30	125	16	BG2430PS	\$2,325

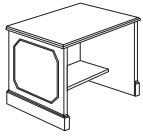

- fixed 11" deep shelf

Corner Unit	42	42	30	165	36	BG4242CU	\$3,277
	36	36	30	148	27	BG3636CU	\$3,018

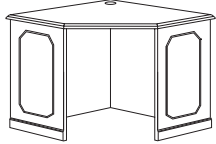

- angle grain direction on top
- one surface grommet
- freestanding
- keyboard tray or mouse pad cannot be used with BG3636CU

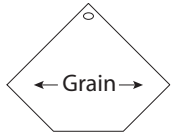

Description	D	W	H	CTN WT	CU FT	① Model	List Price
Sofa Table	18	60	30	81	4	BG1860ST	\$1,309

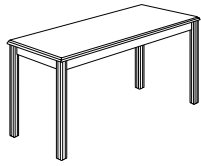

• ships KD in one carton

Magazine Table	20	42	16	63	4	BG2042MT	\$1,103
----------------	----	----	----	----	---	----------	---------

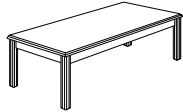

• ships KD in one carton

End Table	24	24	20	43	3	BG2424ET	\$935
-----------	----	----	----	----	---	----------	-------

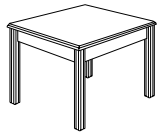

• ships KD in one carton

End Table	20	28	20	43	3	BG2028ET	\$930
-----------	----	----	----	----	---	----------	-------

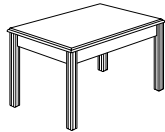

• ships KD in one carton

Center Drawer	16	24 ¼	3	12	2	BG1826CDB	\$482
---------------	----	------	---	----	---	-----------	-------

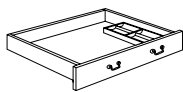

• non-locking

To Order, Specify:

- ① Model Number
- ② Finish Color ([see page BG13](#))
- ③ Pull Style and Color ([see page BG13](#))
- ④ Other Product Options ([see page BG7-BG12](#))
- ⑤ Accessories, Power and Data

Brogan Conference Product Information



BROGAN

Brogan Conference Product Information

Exterior Wood Materials

Exterior surfaces are made from the finest selected veneers to achieve clarity and consistency in the Brogan product line. To attain a pleasing, symmetrical pattern, all veneers in Brogan are book-matched. All exterior solid lumber is matched to coordinate with the veneer.

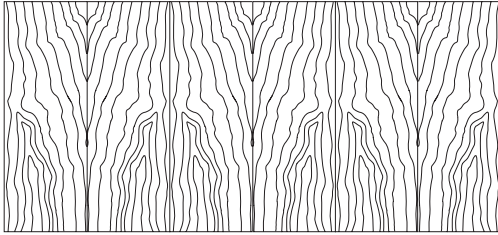

Book Matched Example

Alternating pieces of veneer are flipped over so they face each other like the pages within a book.

Brogan is available in flat cut cherry and walnut veneer. A wide range of wood stains have been formulated to enhance the beauty of the veneer.

Work Surface Construction

Tops are 5-ply balanced construction, 1 3/16" thick with solid matching hardwood edges. Tops are available in one edge profile.

Matching or coordinating high pressure laminate in a veneer grain can be applied to the top surface and is available at no additional charge.

Base Construction

Panels are joined together by mortise and tenon construction. In addition to mortise and tenon joint construction. Leveling glides are set into solid hardwood with t-nut inserts, which helps to prevent the leveling glide from tear out. Tops are secured to the bases with top fastening cleats screwed to the inside of the panels.

Drawers

The 9ply unidirectional hardwood sides of the drawer box are 7/16" thick assembled with English dovetail construction at each corner of the box. The drawer bottom panel is 1/4" thick fitting into a groove machined into the side of the box. Interiors are sanded and coated with clear U.V. finish to protect against shrinking, swelling or warping, and to provide a clean, smooth feel and appearance.

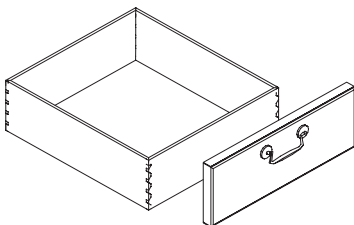

Drawer Suspension

The high quality black drawer suspensions carry a lifetime warranty. Slides feature steel ball bearings for longer life with cushioned in/out stops. File and box drawers have 100% full extension.

Finish - Stain/Colors

We offer a variety of wood stains and paint colors on Brogan. Please see the chart below. Samples are available upon request.

ESS Essentials Veneer Collection

BRK	Brickdust	OBK	Outback
CSK	Cask	SIE	Sienna
CLY	Clay	TRF	Truffle
MES	Mesa	UMB	Umber
MCH	Mocha		

Protective Top Coat

DuraTex™ offers exceptional hardness along with abrasion and impact resistance, it has been formulated to eliminate hazardous and harmful gases that are normally associated with wood finish.

DuraTex™ Features

Safety - Significantly reduces hazardous formaldehyde emissions, which help improve the quality of the of the indoor air we breathe.

Quality - Developed to be tough and durable with special attention to appearance. The DuraTex™ finish preserves the natural beauty of wood.

Durability - Designed to meet a wide range of demanding performance and environmental standards to withstand even the highest wear and tear.

Finish Sheen

All veneer finishes, for Brogan, are standard in 35-sheen. All other finishes can have their sheen modified with a 15% upcharge added to the list price of each item.

Special Finishes

Special finishes can be requested by following the instruction in the general introduction section. There is a one time charge of \$384 list per order.

Brogan Conference Product Information

Product Modification

Laminate Tops

Worksurface only, no additional upcharge if coordinating wood grain laminate is specified. Contact Customer Service for any other laminate request. Listed below are finishes that have coordinating wood grain HPL laminates.

ESS Essentials Veneer

BRK	Brickdust	MCH	Mocha
CSK	Cask	OBK	Outback
CLY	Clay	UMB	Umber
MES	Mesa		

Special Finishes

Special finishes can be requested by following the instruction in the general introduction section. There is a one time charge of \$384 list per order.

Finish Sheen

All veneer finishes are standard in 35-sheen, with the exception of Raven. Raven is only offered in 15 sheen. All other finishes can have their sheen modified with a 15% upcharge added to the list price of each item.

Product Modification

Trim Molding

Angled Trim molding is standard on all Brogan products.

Without molding or Scalloped Trim molding can be specified at the time of order placement. (diagram below show the molding options)

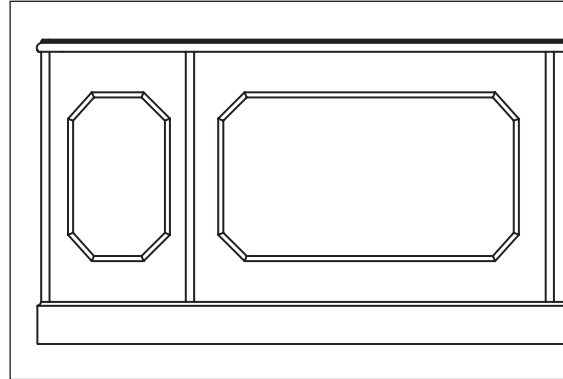

Angled Trim
standard

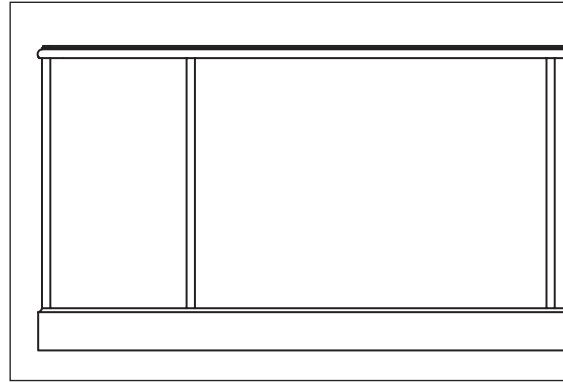

Base Molding Only (without trim)
optional at no charge

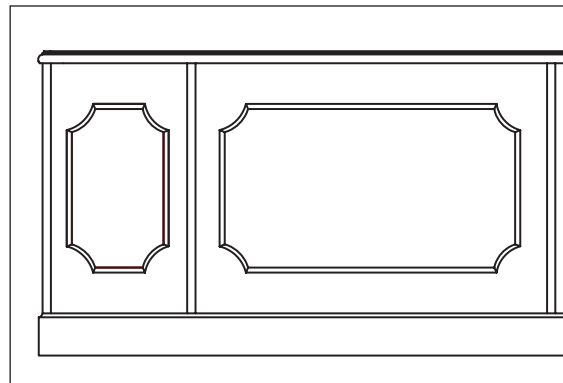

Scalloped Trim
optional with upcharge to list for each item
\$79 list per base

Brogan Conference Product Information

Edge and Hardware

Brogan offers a traditional edge profile and the Brogan drawer pull in antique brass or antique pewter finish.

Edge Profile

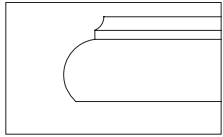

Federal Edge Profile (C3)
Accepts Laminate Top

Drawer Hardware

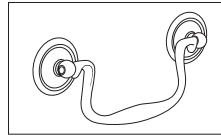

Brogan Hardware
Antique Brass (ANB)
Antique Pewter (ANP)

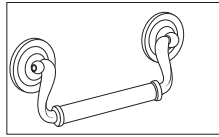

Gala Hardware
Antique Brass (ANB)
Antique Pewter (ANP)

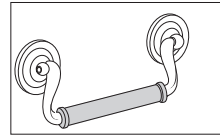

Gala Leather Wrapped Hardware
Antique Brass (ANB)
Antique Pewter (ANP)

Optional matching leather wrapped pulls available for desk with leather inlay or other coordinating units. Specify leather wrapped pulls, add \$61 list upcharge per pull. Indicate Antique Brass (ANB) or Antique Pewter (ANP) pull.

Top Shapes - size - base requirement - seating capacity

top sizes 108" through 192" are 2 pieces

top sizes above 192" are 3 pieces

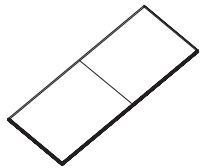

size	base requirement	seating capacity
264" x 54"	4 bases	seats 22
240" x 54"	4 bases	seats 20
216" x 54"	4 bases	seats 18
192" x 54"	3 bases	seats 16
264" x 48"	4 bases	seats 22
240" x 48"	4 bases	seats 20
216" x 48"	4 bases	seats 18
192" x 48"	3 bases	seats 16
168" x 48"	3 bases	seats 14
144" x 48"	3 bases	seats 12
120" x 48"	2-3* bases	seats 8
120" x 42"	2-3* bases	seats 8
108" x 42"	2 bases	seats 8
96" x 42"	2 bases	seats 8
72" x 36"	2 bases	seats 6



size	base requirement	seating capacity
264" x 54"	4 bases	seats 22
240" x 54"	4 bases	seats 20
216" x 54"	4 bases	seats 18
192" x 54"	3 bases	seats 16
264" x 48"	4 bases	seats 22
240" x 48"	4 bases	seats 20
216" x 48"	4 bases	seats 18
192" x 48"	3 bases	seats 16
168" x 48"	3 bases	seats 14
144" x 48"	3 bases	seats 12
120" x 48"	2-3* bases	seats 8
120" x 42"	2-3* bases	seats 8
108" x 42"	2 bases	seats 8
96" x 42"	2 bases	seats 8
72" x 36"	2 bases	seats 6

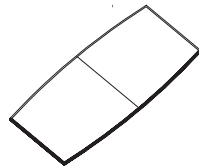

size	base requirement	seating capacity
264" x 54"	4 bases	seats 22
240" x 54"	4 bases	seats 20
216" x 54"	4 bases	seats 18
192" x 54"	3 bases	seats 16
264" x 48"	4 bases	seats 22
240" x 48"	4 bases	seats 20
216" x 48"	4 bases	seats 18
192" x 48"	3 bases	seats 16
168" x 48"	3 bases	seats 14
144" x 48"	3 bases	seats 12
120" x 48"	2-3* bases	seats 8
120" x 42"	2-3* bases	seats 8
108" x 42"	2 bases	seats 8
96" x 42"	2 bases	seats 8
72" x 36"	2 bases	seats 6



size	base requirement	seating capacity
60" dia.	Seats 6	
54" dia.	Seats 6	
48" dia.	Seats 4	
42" dia.	Seats 4	
36" dia.	Seats 4	

*requires 1 base

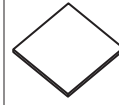

size	base requirement	seating capacity
60" sq.	seats 8	
54" sq.	seats 6	
48" sq.	seats 4	
42" sq.	seats 4	
36" sq.	seats 4	
30" sq.	seats 4	

*requires 1 base

Base (units with access panel in the base for wire management are available, order this feature with the appropriate model number.)

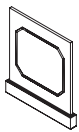

panel base
30" and 24" width

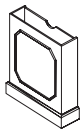

rectangular base
30" and 24" width



square base
24" width

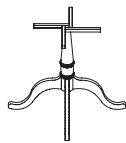

cabriole base
33" width

Grommet

Brogan Grommets

Work surface grommets can be specified work surfaces. The grommet location must be approved by JSI manufacturing; contact Customer Service.

Add \$118 to the list for each grommet.

Grommet color must be specified, select Antique Brass or Matte Black. Lock cores will match grommet color.

Matte Black (MBK)
Antique Brass (ANB)

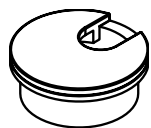

Brogan Conference Product Information

Finish and Product Reference Codes

Select	Code	Select	Code	Select	Code
Essentials Veneer Collection		Pull & Finishes Codes		Essentials Veneer with Laminate Top	
Brickdust	BRK	Brogan Pull-Antique Brass	ANB	Brickdust	BRK
Cask	CSK	Brogan Pull-Pewter	PTR	Cask	CSK
Clay	CLY			Clay	CLY
Mesa	MES	Grommet Finish Codes		Mesa	MES
Mocha	MCH	Antique Brass	ANB	Mocha	MCH
Outback	OBK	Matte Black	MBK	Outback	OBK
Sienna	SIE			Umber	UMB
Truffle	TRF			Sienna	SIE
Umber	UMB			Truffle	TRF
				Umber	UMB

Order Check List:

Specify:

- 1. Model Number
- 2. Finish
- 3. Top Options - standard veneer - laminate surface (see page [BGC3](#))
- 4. Pull Section **if applicable**
- 5. Other Product Options
- 6. Power and Data Accessories (*drawing showing location and orientation must accompany order*)
- 7. Side Mark Information (*i.e. room number, East Conference Room*)
- 8. Shipping Address (*contact name and phone number*)
- 9. Special Delivery Instructions (*i.e. call before delivery, deliver to job site*)

Description	D	W	H	Seating Capacity	CTN WT	CU FT	① Model	List Price
-------------	---	---	---	------------------	--------	-------	---------	------------

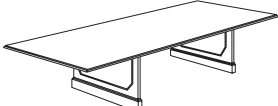
	42	96	30	8			BG4296CTP	\$5,903
	Consists of:							
					172	15		BG4296TT - Table Top

59 ea.	4 ea.						BG2428PB - Panel Bases (2)	\$930 ea.
--------	-------	--	--	--	--	--	----------------------------	-----------

- ships KD in four cartons
- one piece top
- price reflects two bases
- includes BG0655SP stretcher panel

Conference Table	36	72	30	6			BG3672CTP	\$4,460
------------------	----	----	----	---	--	--	------------------	----------------

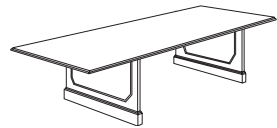

Consists of:

				110	10		BG3672TT - Table Top	\$2,600
59 ea.	4 ea.						BG2428PB - Panel Bases (2)	\$930 ea.

- ships KD in four cartons
- one piece top
- price reflects two bases
- includes BG0631SP stretcher panel

Round Conference Table	48	48	30	4			BG48CTC	\$3,440
------------------------	----	----	----	---	--	--	----------------	----------------

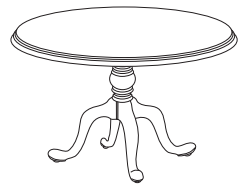

Consists of:

				73	7		BG48TT - Table Top	\$2,024
				30	16		BG33CB - Cabriole Base	\$1,416

- ships KD in two cartons

Round Conference Table	42	42	30	4			BG42CTC	\$2,964
------------------------	----	----	----	---	--	--	----------------	----------------

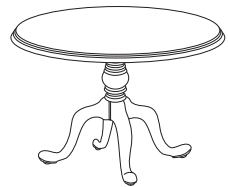

Consists of:

				56	5		BG42TT - Table Top	\$1,548
				30	16		BG33CB - Cabriole Base	\$1,416

- ships KD in two cartons

Description	D	W	H	Seating Capacity	CTN WT	CU FT	① Model	List Price
-------------	---	---	---	------------------	--------	-------	---------	------------

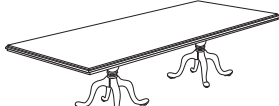
	42	96	30	8			BG4296CTC	\$6,875	
	Consists of:								
					172	15		BG4296TT - Table Top	\$4,043

- ships KD in three cartons
- one piece top
- price reflects two bases

				30 ea.	16 ea.		BG33CB - Cabriole Bases (2)	\$1,416 ea
--	--	--	--	--------	--------	--	-----------------------------	------------

Conference Table	36	72	30	6			BG3672CTC	\$5,432
------------------	----	----	----	---	--	--	------------------	----------------

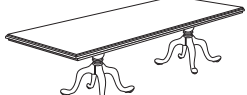
	Consists of:								
					110	10		BG3672TT - Table Top	\$2,600
					30 ea.	16 ea.		BG33CB - Cabriole Bases (2)	\$1,416 ea

- ships KD in three cartons
- one piece top
- price reflects two bases

BROGAN

To Order, Specify:

- ① Model Number
- ② Finish Color
 - A Worksurface Finish
 - B. Chassis Finish
- ③ Accessories, Power and Data
- ④ Other Product Options

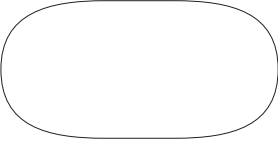
Description	① Model	W	L	Seat Capacity	Top Pieces	Bases Required	CTN WT	CU FT	List Price
Rectangular Tops 	BG60264TT	60	264	24	3	4	673	57	\$17,053
	BG60240TT	60	240	22	3	4	613	51	\$15,504
	BG60216TT	60	216	20	3	4	552	48	\$13,958
	BG60192TT	60	192	18	2	3	490	42	\$12,403
	BG54264TT	54	264	22	3	4	609	52	\$14,213
	BG54240TT	54	240	20	3	4	554	50	\$12,921
	BG54216TT	54	216	18	3	4	498	43	\$11,631
	BG54192TT	54	192	16	2	3	441	38	\$10,339
	BG48264TT	48	264	22	3	4	548	47	\$12,639
	BG48240TT	48	240	20	3	4	498	43	\$11,491
	BG48216TT	48	216	18	3	4	447	38	\$10,339
	BG48192TT	48	192	16	2	3	396	33	\$9,192
	BG48168TT	48	168	14	2	3	346	30	\$8,045
	BG48144TT	48	144	12	2	3	296	28	\$6,896
	BG48120TT**	48	120	8	2	2	245	22	\$5,750
	BG4896TT	48	96	8	1	2	197	17	\$4,620
	BG42120TT**	42	120	8	2	2	217	19	\$5,031
	BG42108TT	42	108	8	2	2	195	17	\$4,531
	BG4296TT	42	96	8	1	2	172	15	\$4,043
	BG4284TT	42	84	8	1	2	151	13	\$3,520
BG3672TT	36	72	6	1	2	110	10	\$2,600	
Racetrack Tops 	BG60264RT	60	264	24	3	4	646	57	\$20,152
	BG60240RT	60	240	22	3	4	589	51	\$18,321
	BG60216RT	60	216	20	3	4	530	48	\$16,493
	BG60192RT	60	192	18	2	3	471	42	\$14,663
	BG54264RT	54	264	22	3	4	586	52	\$16,794
	BG54240RT	54	240	20	3	4	530	50	\$15,269
	BG54216RT	54	216	18	3	4	474	43	\$13,744
	BG54192RT	54	192	16	2	3	417	38	\$12,217
	BG48264RT	48	264	22	3	4	529	47	\$14,930
	BG48240RT	48	240	20	3	4	479	43	\$13,575
	BG48216RT	48	216	18	3	4	428	38	\$12,217
	BG48192RT	48	192	16	2	3	377	33	\$10,861
	BG48168RT	48	168	14	2	3	327	30	\$9,391
	BG48144RT	48	144	12	2	3	277	28	\$8,149
	BG48120RT**	48	120	8	2	2	226	22	\$6,794
	BG4896RT	48	96	8	1	2	185	17	\$5,438
	BG42120RT**	42	120	8	2	2	203	19	\$5,944
	BG42108RT	42	108	8	2	2	180	17	\$5,350
	BG4296RT	42	96	8	1	2	157	15	\$4,755
	BG4284RT	42	84	8	1	2	142	13	\$4,180
BG3672RT	36	72	6	1	2	100	10	\$3,065	

BROGAN

**When ordering RECTANGLE or PANEL BASES - BG48120 and BG42120 require (3) panel bases and additional stretchers. Stretchers will be included as required.

**When ordering RECTANGLE or PANEL BASES - BG48120 and BG42120 require (3) panel bases and additional stretchers. Stretchers will be included as required.

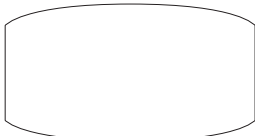
Description	① Model	W	L	Seat Capacity	Top Pieces	Bases Required	CTN WT	CU FT	List Price
Boat Shape Tops  Stretchers will be included as required.	BG60264BT	60	264	24	3	4	646	57	\$20,152
	BG60240BT	60	240	22	3	4	589	51	\$18,321
	BG60216BT	60	216	20	3	4	530	48	\$16,493
	BG60192BT	60	192	18	2	3	471	42	\$14,663
	BG54264BT	54	264	22	3	4	586	52	\$16,794
	BG54240BT	54	240	20	3	4	530	50	\$15,269
	BG54216BT	54	216	18	3	4	474	43	\$13,744
	BG54192BT	54	192	16	2	3	417	38	\$12,217
	BG48264BT	48	264	22	3	4	529	47	\$14,930
	BG48240BT	48	240	20	3	4	479	43	\$13,575
	BG48216BT	48	216	18	3	4	428	38	\$12,217
	BG48192BT	48	192	16	2	3	377	33	\$10,861
	BG48168BT	48	168	14	2	3	327	30	\$9,391
	BG48144BT	48	144	12	2	3	277	28	\$8,149
	BG48120BT**	48	120	8	2	2	226	22	\$6,794
	BG4896BT	48	96	8	1	2	185	17	\$5,438
	BG42120BT**	42	120	8	2	2	203	19	\$5,944
	BG42108BT	42	108	8	2	2	180	17	\$5,350
BG4296BT	42	96	8	1	2	157	15	\$4,755	
BG4284BT	42	84	8	1	2	142	13	\$4,180	
BG3672BT	36	72	6	1	2	100	10	\$3,065	

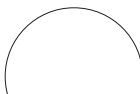
Description	① Model	W	L	Seat Capacity	Top Pieces	Bases Required	CTN WT	CU FT	List Price
Round Tops 	BG60TT	60	N/A	6	1	1	112	10	\$3,420
	BG54TT	54	N/A	6	1	1	92	8	\$2,568
	BG48TT	48	N/A	4	1	1	73	7	\$2,024
	BG42TT	42	N/A	4	1	1	56	5	\$1,548
	BG36TT	36	N/A	3	1	1	42	4	\$1,363

Description	① Model	W	L	Seat Capacity	Top Pieces	Bases Required	CTN WT	CU FT	List Price
Square Tops 	BG6060TT	60	60	8	1	1	154	10	\$3,134
	BG5454TT	54	54	6	1	1	125	8	\$2,375
	BG4848TT	48	48	4	1	1	99	7	\$1,874
	BG4242TT	42	42	4	1	1	77	5	\$1,438
	BG3636TT	36	36	4	1	1	56	4	\$1,297

To Order, Specify:

- ① Model Number
- ② Finish Color
- ③ Accessories, Power and Data
- ④ Other Product Options

BROGAN

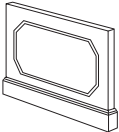
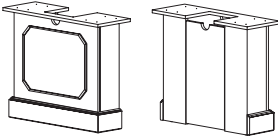
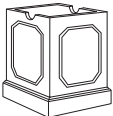
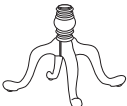
Description	D	W	H	CTN WT	CU FT	① Model	List Price
Panel Base 	2 5/16	36	28 3/4	88	6	BG3628PB · for use with 60" width top	\$1,215
	2 5/16	30	28 3/4	73	5	BG3028PB · for use with 54" width top	\$1,074
	2 5/16	24	28 3/4	59	4	BG2428PB · for use with 36", 42", and 48" width top · (3) bases are required when ordering BG48120 or BG42120	\$930
Rectangle Base 	7 5/8	36	28 3/4	74	7	BG3628PBA · for use with 60" width top · access panel	\$1,715
	7 5/8	30	28 3/4	66	6	BG3028PBA · for use with 54" width top · access panel	\$1,639
	7 5/8	24	28 3/4	56	5	BG2428PBA · for use with 36", 42", and 48" width top · access panel	\$1,560
Square Base 	30	30	28 3/4	73	16	BG30SB · for use with 60" width top	\$1,539
	30	30	28 3/4	73	16	BG30SBA · for use with 60" width top · access panel	\$1,684
	24	24	28 3/4	74	12	BG24SB · for use with 48" & 54" width top	\$1,393
	24	24	28 3/4	74	12	BG24SBA · for use with 48" & 54" width top · access panel	\$1,542
	18	18	28 3/4	45	7	BG18SB · for use with 30", 36" and 42" width top	\$1,247
	18	18	28 3/4	45	7	BG18SBA · for use with 30", 36" and 42" width top · access panel	\$1,399
Cabriole Base 	33	33	28 3/4	30	16	BG33CB · for use with 36", 42" and 48" width top	\$1,416

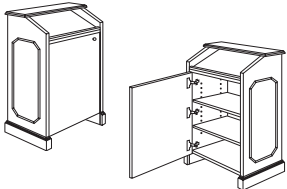
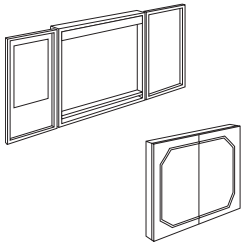
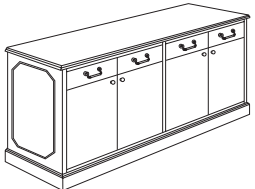
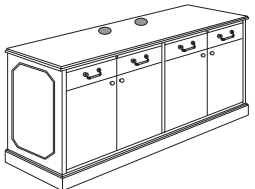
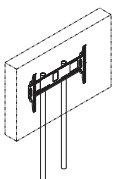
Description	D	W	H	CTN WT	CU FT	① Model	List Price
Conference Lectern  <ul style="list-style-type: none"> two adjustable shelves four concealed, locking casters door is non-locking standard door is hinged on left round grommet in bottom panel notches in adjustable shelves allow wires to pass through 	23	27	48	250	23	BG2723LEC	\$3,583
Visual Board  <ul style="list-style-type: none"> corkboard on left and right doors; paper pad on left only marker board in center four markers and eraser included locking not available 	3 1/2	48	48	125	8	BG4848VB	\$4,316
Buffet Credenza  <ul style="list-style-type: none"> four door credenza four box drawers above doors locking not available adjustable shelf in storage cabinet 	24	72	36	330	43	BG2472BSC	\$6,358
Buffet Credenza - Flat Screen Support  <ul style="list-style-type: none"> four door credenza four box drawers above doors locking not available adjustable shelf in storage cabinet flat screen mounting grommets in top back panel includes cord exit grommets 	24	72	36	330	43	BG2472BSCT	\$6,876
Flat Screen Mounting Frame  <ul style="list-style-type: none"> round 2" tube frame with cable management to inside of credenza mounting bracket for TV provided available in black (B) or silver (S) TV not included TV dimension not to exceed 70"w x 38"h to allow proper mounting clearance coordinates with BG2472BSCT 	2	14	55	35	4	FSTV	\$1,768

To Order, Specify:

- ① Model Number
- ② Finish Color
- ③ Pull Style and Color (see page [BGC4](#))
- ④ Accessories, Power and Data
- ⑤ Other Product Options

Description	D	W	H	CTN WT	CU FT	① Model	List Price
72" h File/File Lateral Storage Cabinet	24	36	72	360	43	BG3672SWLF	\$5,739

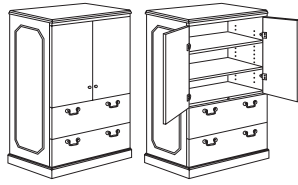

- two adjustable shelves
- locking doors available; specify and add \$147 list
- file/file lateral
- pedestal locking

72" h Wardrobe	24	34 5/8	72	360	43	BG3672W	\$4,104
----------------	----	--------	----	-----	----	---------	---------

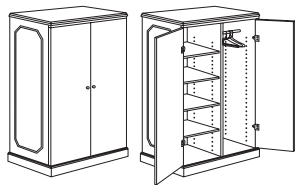

- chrome hanging bar on right
- shelves on left (second from bottom fixed)
- locking doors available; specify and add \$294 list

BROGAN

Description	D	W	H	CTN WT	CU FT	① Model	List Price
72" h File/File Storage Wardrobe	24	23 5/8	72	340	30	BG2472SWR	\$3,980
	24	23 5/8	72	340	30	BG2472SWL	\$3,980

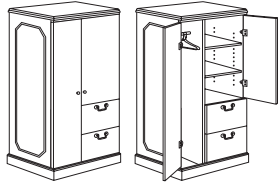

left shown

- chrome hanging bar
- two adjustable shelves
- bottom shelf fixed
- file/file pedestal
- locking not available

Hanging Bar to Shelves Conversion Kit			3/4	56	2	BG1824SK	\$884
---------------------------------------	--	--	-----	----	---	----------	-------

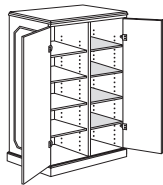

- four shelves
- for 36" wide wardrobe

To Order, Specify:

- ① Model Number
- ② Finish Color
- ③ Pull Style and Color (see page [BGC4](#))
- ④ Accessories, Power and Data
- ⑤ Other Product Options

Accessories/ Keyboard/ Tasklights

For a list of electrical units, grommets, keyboards, wire management, monitor arms & telecom jacks, please see our [accessories price list](#)

Contact your customer service representative for specific questions regarding which units can be used with Brogan.

