



## **SURCHARGE:**

Effective for orders placed on and after **February 28, 2022**, we will be adding a **9% surcharge** to the order total, which will be reflected as a line item on your acknowledgment and invoice. **This surcharge will end with a mid-year price increase outlined below.**

## **PRICE INCREASE:**

Effective **June 1st, 2022** we will implement a price increase. Contact customer service for details or log into the JSI portal Document Library for more information.

## **QUICKSHIP TEMPORARILY SUSPENDED:**



Effective immediately we are temporarily suspending our Quickship Program in order to deliver on our promise of on time shipments. We apologize for the inconvenience and appreciate your understanding.

*price list* effective October 4, 2021

# TABLES + CASEGOODS

---

V1 A-M



# JSI Price Lists

## Tables + Casegoods | Volume 1

- Apogee
- Bourne Tables
- Bravado
- Brogan
- Collective Office
- Collective Presentation
- Finale
- Fresco
- Power and Data

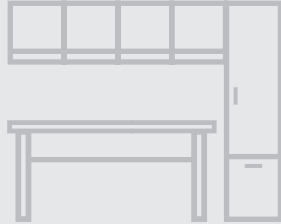

## Tables + Casegoods | Vision

- Casegoods
- Tables



## Tables + Casegoods | Volume 2

- Native
- Nosh
- Prep
- Prost
- Reef
- Romy
- Trail
- Power and Data

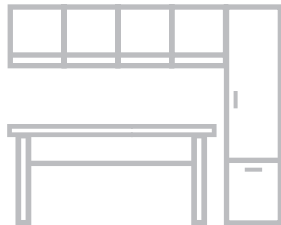

## Seating | Volume 1

- |                |                   |  |        |
|----------------|-------------------|--|--------|
| Addison        | Cabaret           |  |        |
| Alden          | Collective Motion |  |        |
| Americana      | Connect           |  |        |
| Ansen          | Corbin            |  |        |
| Arwyn          | Cym               |  |        |
| Avalon         | Encore            |  |        |
| Avini          | Esque             |  |        |
| BeSpace        | Finn              |  |        |
| Bison          | Finn Nu           |  | Harbor |
| Boston         | Florette          |  | Hedron |
| Bourne Seating | Garvey R5         |  | Hoopz  |
| Bryn           | Gatsby            |  | Indie  |
| Caav           | Hanover           |  |        |

## Tables | Lok

- Training Tables
- Teamwork Tables
- Conference Tables
- Occasional Tables



## Tables + Casegoods | Flux

- Private Office
- Open Plan

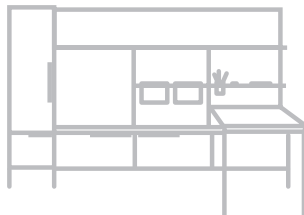

## Seating | Volume 2

- |          |          |  |         |
|----------|----------|--|---------|
| Jude     | Oxley    |  |         |
| Knox     | Pillow   |  |         |
| Kyla     | Portrait |  |         |
| Laurel   | Protocol |  |         |
| Luci     | Proxy    |  |         |
| Mackey   | Ramona   |  |         |
| Madison  | Ria      |  |         |
| Melrose  | Solara   |  |         |
| Milk     | Sosa     |  | Waltham |
| Moto     | Tara     |  | Wink    |
| Murphy   | Totem    |  | Ziva    |
| Newton   | Trinity  |  |         |
| Olympian | Tyler    |  |         |

## Online Only | [jsifurniture.com](http://jsifurniture.com)



- |          |           |           |         |          |            |
|----------|-----------|-----------|---------|----------|------------|
| Axis     | Class Act | Congress  | Lincoln | Shuffle  | Walden     |
| Bentley  | Classmate | Hudson    | Menu    | Stockton | Wellington |
| Broadway | Collegian | Jefferson | Regal   | Strata   |            |



# Casegoods and Tables Price List | Volume 1: A-M

## General Information

Environmental Mission . . . . .	4
Warranty. . . . .	5
Laminate and Veneer Characteristics . . . . .	5
Samples. . . . .	6
Order Procedures . . . . .	6
Quickship Program. . . . .	6
Delivery . . . . .	6
Freight Damage . . . . .	7
Repairs and Returns . . . . .	7
Care and Maintenance. . . . .	7
Fire Retardancy / CAL 133 . . . . .	8
Textile Information / COM and COL Policy. . . . .	9

## Textile and Leather Swatch Card Programs

Maharam . . . . .	10-11
Momentum . . . . .	12-16
Spradling . . . . .	17
Stinson . . . . .	17
Ultrafabrics . . . . .	18
Cortina . . . . .	18

## Fabric Grading

Arc-Com. . . . .	19
Designtex . . . . .	20
Maharam . . . . .	21
Mayer . . . . .	22
Momentum . . . . .	23
Spradling . . . . .	25
Stinson . . . . .	24
Ultrafabrics . . . . .	25

## Leather Grading

Cortina . . . . .	26
-------------------	----

## Specification Tools. . . . .

## GSA Terms and Conditions . . . . .

<b>Apogee</b> . . . . .	31
Desks . . . . .	68
Consoles . . . . .	74
Meeting Tables. . . . .	76
Bridges . . . . .	76
Returns . . . . .	77
Credenzas . . . . .	80
Lateral Files . . . . .	85
Modular Credenzas . . . . .	86
Overhead Cabinets. . . . .	106
Wall Mount Storage . . . . .	120
Wall Panels . . . . .	134
Wall Mount Tackboards. . . . .	135
Vertical Storage Units . . . . .	139
Workwalls . . . . .	157
Accessories . . . . .	173

**Axis**. . . . . Online at  
jsifurniture.com

**Bentley**. . . . . Online at  
jsifurniture.com

<b>Bourne</b> . . . . .	175
Standard Height Tables . . . . .	188
Counter Height Tables . . . . .	192
Bar Height Tables . . . . .	196
Storage . . . . .	198

<b>Bravado</b> . . . . .	201
Rectangular Conference Tables . . . . .	210, 220
Boat Shape Conference Tables . . . . .	214, 224
View Conference Tables . . . . .	216, 228
Square Conference Tables . . . . .	230
Credenza . . . . .	231
Media Cabinets . . . . .	232
Wall Panel . . . . .	234
Media Wall Cabinet . . . . .	235

**Broadway** . . . . . Online at  
jsifurniture.com

**Broadway Conference** . . . . . Online at  
jsifurniture.com

<b>Brogan Modular</b> . . . . .	237
Shells . . . . .	244
Corner Unit . . . . .	245
Bridge Applications . . . . .	245
Modular Pedestals. . . . .	246
Modular Drawers. . . . .	247

<b>Brogan</b> . . . . .	249
Desks . . . . .	268
Returns and Bridges . . . . .	274
Credenzas . . . . .	276
Modular Pedestals. . . . .	278
Overhead Cabinets. . . . .	280
Wall Mount Storage . . . . .	283
Tackboards . . . . .	283
Transaction Counters. . . . .	284
Bookcases. . . . .	285
Lateral Files . . . . .	286
Storage Cabinets . . . . .	287
Freestanding Tables . . . . .	289

<b>Brogan Conference</b> . . . . .	291
Conference Tables . . . . .	296
Conference Tops . . . . .	298
Conference Table Bases . . . . .	300
Lectern . . . . .	301
Visual Board. . . . .	301
Credenzas . . . . .	301
Vertical Storage Units . . . . .	302

<b>Collective Conference</b> . . . . .	305
Conference Tables . . . . .	318
Conference Tops . . . . .	378
Conference Bases . . . . .	382
Center Console Options . . . . .	390

<b>Collective Presentation</b> . . . . .	393
Media Wall . . . . .	402
Complementary Products . . . . .	419

<b>Finale</b> . . . . .	421
Desks . . . . .	444
Modesty Panels . . . . .	444
Returns and Bridges . . . . .	452
Credenzas . . . . .	457
Overhead Cabinets. . . . .	460
Tackboards . . . . .	464
Tool Rail Accessories. . . . .	470
Wall Mount Storage . . . . .	471
Storage Towers. . . . .	480
Transaction Counters. . . . .	489
Bookcases. . . . .	490
Lateral Files . . . . .	491
Vertical Storage Units . . . . .	492
Freestanding Tables . . . . .	496

<b>Finale Conference</b> . . . . .	501
Conference Tables . . . . .	507
Conference Tops . . . . .	508
Conference Table Bases . . . . .	510
Lectern . . . . .	512
Visual Board. . . . .	512
Credenzas . . . . .	512
Vertical Storage Units . . . . .	513

**Fresco** . . . . . 516

**Jefferson** . . . . . Online at  
jsifurniture.com

**Lincoln** . . . . . Online at  
jsifurniture.com

**Menu & Bases** . . . . . Online at  
jsifurniture.com

<b>Accessories, Power and Data</b> . . . . .	519
Power and Data . . . . .	521
Wire Management . . . . .	525
Task Lights. . . . .	532
Keyboard Accessories . . . . .	534

**Index** . . . . . 536

## Environmental Mission

Our vision and goal is a sustaining supplier, manufacturer and customer for the long term protection and preservation of our environment for future generations.

### MISSION

To achieve this vision, we are dedicated to ensuring the health and wellbeing of all of our partners, reducing negative impact on the environment, and maintaining price structure by increasing efficiencies and reducing consumption.

JSI, and its parent company, is an internal manufacturer and has been an environmentally conscious organization for more than 80 years.

We are proud to use wood as our primary sustainable material resource and all corporate policies and procedures support the efforts to “recover, recycle, reuse, repurpose, reduce, refuse, and re-engineer”. In doing this, we are committed to the conservation of the environment and its natural resources as well as encouraging our suppliers and customers to do the same. A goal of a “Sustainable Partnership”, supplier, manufacturer and customer, is essential for the long term protection preservation and sustainability of our environment for future generations.

### LOCATION

Our manufacturing facilities are located in the center of Southern Indiana. With our diverse product offering and manufacturing capabilities, we provide a single source for all of your project needs allowing you to conserve our fossil fuels and reduce greenhouse gases.

### PACKAGING

We place emphasis on the minimal use of disposable packaging while still providing adequate protection to the finished product. Our corrugated packaging is recyclable, reusable, and up to 100% recycled content. We reuse or recycle more than 175 tons of corrugated material annually.

### REGULATORY

All of our manufacturing facilities are in compliance with applicable OSHA regulations and meet or exceed all applicable DEM and EPA regulations for air emissions, storm water and hazardous waste disposal.

### MANUFACTURING FACILITIES

Our manufacturing facilities are geared toward eco-efficiency and are encouraged to continually improve and conserve. Solid wood not used in the direct manufacturing process is recovered for the operation of our dry kilns, thus reducing greenhouse gases, the use of fossil fuels, and the burden of waste placed on landfills. Composite panels not used in the direct manufacturing process are ground and sold for use as animal bedding and boiler fuel. In addition to other energy savings techniques, our manufacturing facilities use high efficient lighting, make use of power factor capacitors, and encourage all to conserve and reduce energy consumption and water usage. Condensation pumps are used to aid in water conservation as well as extending boiler life.

### MANUFACTURING PROCESSES

Our finish processes utilize efficient spray guns and proper spray techniques to reduce wasted material. Excess finish material, solvents, and waste are recycled. Many of the assembly processes use water based glues that contain no hazardous ingredients.

### TEXTILES

Many of our fabric options utilize up to 100% recycled content. Our leather alternative program includes selections that contain no toxic materials, plasticizers, heavy metals, or formaldehyde and have a 100% biodegradable back cloth. Some of the available panel fabric used, if discarded is a biological nutrient for the soil. Most of the components (foam, batting, and polycord) used in upholstered products are recyclable. Excess fabrics and leathers not utilized in the upholstery process go to recyclers and local charities for additional use.

### WOOD

Wood is the most diverse, most process friendly, and most widely utilized natural resource in mankind’s history. No other natural resource can match the environmental advantages of wood, including being renewable, recyclable, natural, carbon negative, and biodegradable. Utilizing the sun’s energy, trees grow and remove carbon dioxide from the air while giving off oxygen to benefit the entire planet. Approximately 49% of wood’s dry weight is carbon and harvesting mature trees in a sustainable forest, which has slowed in the absorption of carbon dioxide, allows the photosynthetic cycle to continue at full optimization and allow for the carbon to remain sequestered. We are proud to use wood as our primary “sustainable” renewable resource.

### WOOD OPTIONS

Many environmentally friendly solid wood and engineered wood options are available for quote, including: Lyptus®, Plyboo®, reclaimed woods, agricultural and post-consumer waste fiber products, etc.

### INDOOR AIR QUALITY

Our goal is to reduce the impact our products will have on the indoor air quality. We practice the latest technologies and utilize a third party to assure we meet this goal. GreenGuard, one of the leaders in IAQ certification, continues to certify our product offering with UL2818 - GreenGuard Indoor Air Quality certification.

### PARTNERSHIPS

BIFMA  
*Business and Institutional Furniture Manufacturer Association*  
 USGBC  
*United States Green Building Council*  
 IIDA  
*International Interior Design Association*  
 FSC  
*Forest Stewardship Council - Forestland*  
 UL GreenGuard  
*Indiana Department of Natural Resources - Division of Forestry - Classified Forest, Wildlands Program*

### Lifetime Warranty

JSI warrants to the original purchaser that each piece of furniture will be free from defects in workmanship, given normal use and care for as long as the original customer owns and uses the product. Normal use is defined as the equivalent of a single shift, 40-hour work week.

JSI will, at its option, repair or replace with comparable product within the terms of the warranty.

#### Exceptions to Warranty:

##### 12 Years (from date of purchase)

- Wood Seating
- Seating Controls
- Veneer Surfaces
- Laminate Surfaces
- Pneumatic Cylinders

##### 5 Years (from date of purchase)

- Glides · Casters · Task Lights
- Mesh/Knit Material · Foam
- Florette Plastic Frame Chairs
- Electrical Components
- Electric Height Adjustable Bases

#### This Warranty Does Not Cover:

- Natural variations in color, grain or texture of wood and other covering materials over which JSI has no control.
- Normal wear, color fastness, shrinkage, puddling, wrinkling and stretching of upholsteries including fabric, vinyl, leather and other textiles. This warranty does not cover any defects that may arise in the use of COM or COL upholstery materials. Textile manufacturer's warranty will apply.
- Damages resulting from transportation, improper assembly, installation, handling, accident, user modification attachments, misuse, or neglect of product care.
- Damage resulting from extreme climate conditions.
- Finish damages resulting from normal wear and tear, improper maintenance, water damage, exposure to sunlight, extreme high or low humidity or temperature, or other acts of nature.
- Damage created by loading file drawers with anything other than hanging folders.

JSI makes no expressed or implied warranties to any product and, in particular, makes no warranty of merchantability of fitness for any particular purpose. JSI will not be liable for any consequential or incidental damages under this warranty.

### Unique Characteristic of Natural Woods and Veneers

JSI uses high quality wood and veneer harvested from sustainably managed forests. Every tree has unique and defining characteristics, like fingerprints. These characteristics can be defined by differences in color, grain configuration, and textures. These characteristics will be more noticeable if the product has a clear or lighter finish.

Maple and Cherry species have a higher degree of uneven distribution of grain, small color streaks, and pin knots.

At JSI, we take care of selecting woods and veneers that are used in our products. With this in mind, we hope you appreciate the beauty of each tree's fingerprints. Products will not be replaced due to these natural characteristics.

Veneers can be sliced in a variety of ways to create unique patterns. JSI uses several different patterns, as shown below.

Flat (Plain) Cut as shown in diagram

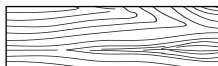

Quarter Sliced as shown in diagram

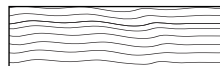

Double Cut as shown in diagram



#### Double Cut

The Double Cut veneer is a processed product that has at least two cuttings to create the final veneers. These cuts of veneer strands are dyed and layered into a block to create variation of patterns from a very tight grain pattern to an exotic figure grain pattern.

JSI uses select beech, cherry, maple, oak and walnut cut wood products to produce the desired look of our furniture products.

Please reference the featured highlights of each product line to identify the species and grain patterns available for that product.

### Laminates (Veneer Series)

HPL (Higher Pressure Laminate) laminates can be specified on most of our work surface tops in most of our product lines. Refer to the specification pages for each series. The specification pages will also list the available coordinating finishes.

### Laminate Series

JSI laminate series offer a full laminated product with imprinted grain to hide finger prints and provide durability. The worksurface tops are HPL (High Pressure Laminate). TFL (Thermal Fused Laminate) is used on the product's chassis. Please reference the featured highlights of each product for additional details.

### Finish - Top Coat

To reduce hazardous formaldehyde emissions, we use our proprietary specially designed top coat, DuraTex™. It significantly reduces hazardous formaldehyde emissions and helps improve indoor air quality.

### Finish - Color/Stains

A wide range of stains are available to bring out the beautiful characteristics of each wood species. We coordinate finish color between our veneer stains and solid lumber stains; however, not all may be a perfect match. The stains are continually reviewed for accuracy of color, as well as a constant monitoring of the latest color trends in the furniture market.

### Finish - Matching

Due to the natural characteristics of wood, environmental effects, and material upgrades, JSI cannot guarantee exact finish matches on existing furniture previously ordered.

If an exact match is required to accompany existing furniture, it must be specified at the time of order placement, so specific internal procedures can be followed to ensure a proper and acceptable finish match. We reserve the right to change our finish formula at any time to improve safety, quality, and appearance. Unless a finish match for existing furniture is requested at the time of ordering, we accept no liability for finish that may not match the existing furniture from prior orders.

Solid lumber may inherently have mineral streaks, pits, and various other natural occurrences. Care is taken in selecting the solid lumber to coordinate with the requested finish on our veneer products. This internal selection process is subject to availability of solid lumber parts.

### Custom/Special Finishes

JSI, upon request, will accommodate special finishes. A written request is required to proceed with custom finish orders. A sample reference is required for first time matches and must be included with the written request.

There is a one time charge of **\$332 list per order** for any non-standard wood finish.

Orders will be entered noting the special finish. A sample match will be provided to the customer. Written approval is needed before the finish process can be started. Delays in approval may have an impact on lead times.

Every effort will be made to create the requested match; however, an acceptable match may not be possible because of natural variations of wood. These natural variations can also cause minor differences in the final finish product.

### Samples

Samples of standard wood finishes, paints colors, metal colors, and standard laminate are available upon request. The fastest way for requests to be filled is by using our website. See below for options to request samples.

Website – jsifurniture.com (click the resource tab)

JSI Sales representatives

Phone – 800.457.4511 – Customer Service

Email – customerservice@jaspergroup.us.com

### Pricing

Prices found in this document or on our website are list prices in U.S. dollars for standard product delivery to one destination. Prices do not include storage, installation, or taxes. Possession of this price list does not constitute an offer to sell. Orders can only be received from approved authorized JSI dealers.

Prices and product information in this document, as well as our website, are subject to change without notice. Reference website for most up to date product offering and pricing.

### Orders

Detailed specification pages are available in the price list at the beginning of each series.

Additional information may be obtained by consulting the Customer Service Department or our website.

Indicate shipping address if different from billing address.

Send Orders To:

US Mail – JSI

225 Clay Street

Jasper, IN 47546

Fax – 812-482-1548

Email – orders@jaspergroup.us.com

JSI reserves the right to make changes in dimensions, styles, or specifications if we believe these changes will improve the safety, quality, or appearance of the product.

Acceptance of orders will be subject to credit approval, barring any acts of governments, or any other causes beyond our control (e.g. strikes, fire, embargo of materials, etc).

### Product Modifications

While we offer a wide range of products to accommodate many possible solutions, we also recognize the needs for our products to be modified from our standard offering.

In the series introduction section of each product, we address modification options for that series.

To see if the desired modification is possible, please contact our Customer Service Department for a quote. Note that order quantities and material availability can affect the quote. Additional information may be requested to fully quote modifications.

### Order Acknowledgments

All orders will be acknowledged promptly upon entry of a clean order. The acknowledgment will show how the order was entered, ship date and any other information pertinent to the order. It is the purchaser's responsibility to verify all the information on the acknowledgment carefully and notify us immediately, in writing, of any discrepancies.

Every reasonable effort is made to ship as acknowledged; however, the acknowledged ship date is approximate. Company will generally ship within five (5) working days of the acknowledged ship date. If a firm ship date is necessary, customer must inform company at time of order and company will make all reasonable efforts to meet each customer's request. Acknowledged shipping dates are contingent upon the force majeure conditions contained in these terms and conditions.

### Quickship

Items indicated with a Quickship symbol  ship within 10 business days of receipt of a clean, credit approved purchase order. Product for up to 20 offices or 20 tables can be selected from the Bourne, Brogan or Finale series. See individual product pages for those models available on quickship. Available capacity is filled by orders as they are received. If normal 10 day Quickship is not available because capacity has been filled, you will be immediately notified. Changes and cancellations to Quickship orders are not allowed under any circumstances.

### Delivery

Our freight policy consists of prepaid freight to the 48 contiguous states; all other shipments are prepaid to port of exit ONLY. JSI reserves the right to select the appropriate carrier and shipment routes, most shipments are on freight carriers that are dedicated furniture specialists. Standard deliveries require a DOCK that can accommodate **75 foot trucks**. Ownership and inspection of product is the responsibility of the buyer upon pickup by the freight carrier. Pricing in this book is for standard delivery only. Standard delivery does **not** include non-dock delivery, inside delivery, residential delivery or installation of product. Fees and changes for non-standard deliveries are listed below.

### Standard Delivery Time

Between 8AM and 3PM Monday through Friday. Special delivery requests can be subject to additional fees to accommodate requests.

### Cancellations and Changes

All orders are considered firm and are not subject to cancellation or change without approval from JSI. All approved changes are subject to additional charges and revised lead times

### No Touch Freight

Our freight is considered "no touch". Therefore, customers are to be prepared to unload freight from inside the truck prior to arrival. In the instance that a driver must unload the shipment, driver assists fees will apply (see fees below).

### Detention Fees

- Carriers are given two-hour maximum time allotment to unload for one-stop truckloads.

- Carriers are given one hour maximum time allotment to unload for multi-stop truckloads

\*Detention fees apply after allotted unloading time and will be at buyer's expense.

### On-Site Deliveries

Shipments to the installation site, and time deliveries are available on full truckloads or slightly less, at no additional charge. Shipments or timed deliveries for smaller shipments may not be available, or if available may require an additional charge.

### Residential Deliveries

Our freight policy prohibits the delivery of freight to a residential property.



## Fees

Orders of less than \$1,000 net . . . . .	\$78 net per order
Weekday deliveries outside of standard delivery times . . . . .	\$250
Weekend deliveries (Saturday or Sunday) . . . . .	\$500
Liftgate Deliveries. . . . .	\$100 minimum 5% of net price
Driver Assist . . . . .	\$75
Jobsite Non-Dock Delivery . . . . .	\$100
Inside Delivery (first floor inside only) - no installation or carton removal. . . . .	\$125 minimum 5% of net price

## Warehouse/Storage Fees

Additional storage time with a provided two-week approved notice is calculated at 3% per month of the product amount or per day.

## Please be Advised

- Reconsignment fees are the responsibility of the buyer.
- Any charges arising from failure to meet shipment, re-routing while in transit or carrier storage charges are the responsibility of the buyer.
- Contact Customer Service to inquire about skidding of products, special crating of products and product installation. These requests must be approved by JSI and made at the time of order.
- Carriers have the right to refuse delivery to a specified location if it conflicts with their liability policy.

## Freight Damage

JSI products are packed in cartons and meet or exceed existing codes for furniture and seating products. All shipments are delivered to the carrier in good condition and our liability ceases thereafter. If delivery arrives short or damaged, contact the carrier immediately to file a claim. In the event of concealed damage, notify the carrier and request immediate inspection. Failure to file a claim within 15 days after receipt of merchandise constitutes acceptance and a waiver of any such claims. Please inspect merchandise immediately upon receipt, otherwise there is no recourse. Keep all cartons and packing material, discarding these materials may negate your claim.

Storage of product in areas of uncontrolled humidity and temperature may cause damage to the product and void the JSI warranty.

## Repairs

JSI will not issue credit allowance for any type of repairs without prior written consent.

Sales order, product model numbers, and reason for repair will be expected in order to process the repair request. A digital photo will help to expedite the request. JSI reserves the right to recommend solutions for repair.

## Returns

No merchandise may be returned to JSI without a signed Return Good Authorization (RGA) form issued by our Customer Service Department. Any authorized return not due to damage or defect will be assessed a 45% restocking fee and all return freight charges must be prepaid. Additional restocking fees may apply for any modification, special or custom built product.

Liability for defective merchandise shall be limited to replacement or repair.

Under no circumstance can we accept COD (Cash On Delivery) returns. Any such shipment will be refused.

## Replacement Parts

Obtain information and pricing on replacement parts by contacting Customer Service. Please have the model number available when requesting replacement parts. Additional information may be required to ensure proper replacement parts.

## Care and Maintenance

### Care of Upholstery Surfaces

Cleanability will vary based on the fabric type. For best results, a professional service is recommended. Dirt and crumbs may be gently brushed or vacuumed off. Spills should be wiped up immediately with a cloth. Vinyl textiles can be cleaned with warm soapy water and then wiped down with a warm damp cloth. For more details on any JSI carded fabric and vinyl, please visit our website at [jsifurniture.com](http://jsifurniture.com) or consult the back of the appropriate swatch card for cleaning codes and any specific instructions. For COM materials, consult with the individual textile manufacturer for cleaning codes and any specific instructions pertaining to your particular fabric.

### Maintenance of Mechanical Parts

Clean any lint or debris from the moving parts of the base mechanisms. Mechanisms have been designed and tested to not require lubrication under normal conditions; however, lubricant can be used if needed.

### Care of Wood Edges and Veneer Surfaces

Clean all surfaces frequently with water dampened soft cloth, moving the cloth with the grain direction. Immediately remove any liquids that come in contact with wood surfaces with a blotting action to absorb liquid. Buff dry. Lift objects to move them, never pull them across the finished surface. For an additional safeguard, use a protective surface pad. This will ensure a lasting finish by protecting your furniture from possible damage caused by pens, cups and sharp objects. Avoid exposure of furniture to extremes of heat and cold, or to wide humidity variances. Avoid exposure of furniture to strong sunlight. Avoid exposure of furniture to harsh solvents such as nail polish remover, acetates, etc., as it will cause finish deterioration. If using a protective glass top, place spacer pads under the glass top to allow the wood to breath.

### Care of Metal Finishes

Wash you powder-coated item at least one every six months. Use soft rags only - No abrasives. For stubborn stains and grease marks, use soap and water mixture. Combine 1 gallon of water and 1 cup of the neutral detergent in the bucket. Mix it up by swirling one of the rags around in it. Wipe down the powder coat with a rag that has been dampened with the cleaning solution. Do not scrub, but use gentle, repetitive pressure to remove any built-up grime. Rinse the powder coat off with a rag dampened with clear, clean water. Do not spray it down, but rather wipe it off with the rag. You may need to do this several times to get all the soap off. Wipe the powder coat down with a clean dry rag. This will prevent streaking and spotting.

### Care of Frosted Glass

Use a clean, dry lint free cloth to wipe the surface. Follow with warm water and a clean rag; no soap or chemicals. Wipe dry with a clean, dry lint free cloth. Cleaning the frosted side is not recommended, if desired to clean use the above method but do not spray the water on the frosted side, use a clean rag. Please allow 48 hours for the frosted side to dry and not to show cloudiness.

### Tempered Glass Information

JSI is aware of occasional occurrences of spontaneous glass breakage in various furniture products. Tempered glass makes it stronger and if it breaks, will cause it to break into many small pieces of “cubes” rather than sharp and potentially dangerous shards.

Glass breakage in furniture may occur for a variety of reasons. Tempered glass is particularly prone to breakage from damage (scratches, nicks, etc.) that may occur during shipping, handling, installation, use or maintenance. Exposure to rapid changes in temperature or concentrated temperature zones may also cause breakage.

Tempered glass may also break due to a specific type of imperfection or “inclusion” that occurs within the glass when manufactured. When this condition exists glass breakage may occur without any obvious cause. This is often referred to as “spontaneous” breakage but is a very isolated occurrence in the glass industry.

### Care of Dry Erase Boards

Erase after every use to eliminate ghosting. Clean weekly with a Dry Erase Cleaner. Avoid the use of orange and red Dry Erase Markers. Follow manufacturer cleaning instructions for the eraser. If ghosting or staining remains use a small amount of rubbing alcohol on a clean, soft towel to remove.

### Care of Solid Surface

Although liquids cannot penetrate Solid Surface, it is best to wipe up spills as they occur. Generally, a damp microfiber cloth used with a standard household kitchen spray should remove most stains.

For most residues, all you need to clean your Solid Surface countertops is a warm soapy water, ammonia-based household cleaner or a dedicated countertop cleaner. Do avoid window cleaners; however, as they can leave a waxy build-up that dulls the surface. Always clean using a circular motion.

Film will build up on countertops if water is left to dry on the surface. This film will dull the countertop surface, making the finish appear blotchy and uneven. To prevent film build-up, it is very important to wipe the countertop completely dry immediately after spills and cleaning.

Some color of Solid Surface may require more frequent cleaning to maintain a uniform finish. Darker colors tend to require more attention than lighter colors. Over time, even with proper care, your countertop will acquire a sheen. Dark colors may show light scratches more readily.

### Fire Retardancy

All JSI upholstered components comply with California Bureau of Home Furnishings and Thermal Insulation-Technical Bulletin 117-2013 issued by State of California Department of Consumer Affairs. This standard requires upholstered furniture to be safer from the hazards associated with smolder ignition in all four (4) categories of materials, as applicable.

Compliance with more stringent codes may require special manufacturing considerations and upcharges.

### California Technical Bulletin 133 (CAL 133)

JSI uses a barrier material between the foam cushioning and the upholstery cover in order to comply with CAL 133. The standard upcharge on products specified to comply with CAL 133 is **\$69 list per yard** of textile.

JSI has performed a series of full scale fire tests on samples - representing worst case scenarios of upholstered units - to comply with the requirements of the state of California Technical Bulletin 133 (CAL 133). Products in compliance are labeled in accordance of the standards.

Some product designs and fabric cannot be combined to comply with CAL 133. Because of this, we reserve the right to reject any request for an upholstery cover, including COM, textile may not contain olefin or product style that we feel may compromise the integrity or safety of a product specified to comply with CAL 133.

Contact Customer Service for a quote if you require laboratory certification that a specific product and upholstery combination WILL PASS CAL 133. The quotation will include testing, video, and transportation charges plus the list cost of the sample.

Our standard lead time will apply to products that do not require certification. Allow an additional six weeks over the standard lead time for products that need actual laboratory certification.

The end user, specifier and/or dealer have the responsibility to make sure all products specified will meet the flammability and safety codes of the jurisdiction where the products will be located and used.

### Flame Spread

All JSI may be required to comply with the requirements of Flame Spread based on ASTM standards/NFPA Life Safety Codes and general public knowledge are as follows:

Solid Wood - Class C  
 Topcoats - Class A  
 Carded Fabric - Class A  
 Composite Panels - Class C  
 Laminate - Class B

Plastics - According to the NFPA, the lack of stability of plastics under high temperature conditions and inherit combustibility have eliminated the use of plastics for applications requiring a flame spread rating.

Also be advised that improvements may be attained in certain instances with the addition of chemicals which may add additional costs, chemical exposure and/or compromise the integrity of the product.

### Textile Carded Programs

JSI is proud to partner with Maharam, Momentum, Spradling, Stinson, Ultrafabrics and Cortina Leather. Please refer to the respective pages in this pricer for each of these partners. Scan the QR codes on the back of the swatch card for latest grades and other information.

### Textile Grade-In Programs

For the convenience of our specifiers, we have graded in the following suppliers:

- Arc Com [www.arc-com.com](http://www.arc-com.com)
- Designtex [www.designtex.com](http://www.designtex.com)
- Maharam [www.maharam.com](http://www.maharam.com)
- Mayer [www.mayerfabrics.com](http://www.mayerfabrics.com)
- Momentum [www.themomgroup.com](http://www.themomgroup.com)
- Spradling [www.spradlingvinyl.com](http://www.spradlingvinyl.com)
- Stinson [www.cfstinson.com](http://www.cfstinson.com)
- Ultrafabrics [www.ultrafabricsllc.com](http://www.ultrafabricsllc.com)
- Cortina Leather [www.cortinaleathers.com](http://www.cortinaleathers.com)

For memo samples, contact textile suppliers.

Please contact Customer Service for pricing grades on textiles and leathers not listed.

Indicate on purchase order if JSI is to order the fabric.

Grades and availability of fabric are subject to change without notice. Changes could include but are not limited to price increase, discontinued patterns, discontinued colors, etc. See jsifurniture.com for up to date information.

Many textiles have repeats and the additional yardage required has been factored in for textiles ordered through the JSI Carded and Grade-In Programs. We reserve the right not to match textiles with a horizontal or vertical repeat greater than 17". Additional charges may apply for textile being applied with special instructions.

Some fabric thickness or stiffness may cause issue with proper upholstering of tackable wall panels or upholstery privacy screens. Please contact customer service with concerns on the fabric thickness for these items.

### COM/COL Address

JSI  
 Attn: COM/COL Department  
 Receiving B  
 Dock 71  
 201 East Martin St.  
 Orleans, IN 47452

Tag: Dealer Name / Purchase Order #

### General COM Fabric/COL Hide Policy

Refer to the COM/COL Price Columns for list prices.

All yardage requirements listed in the price list are based upon 54" plain non-directional material. Additional yardage may be required based on fabric repeat and matching.

All square footage requirements for COL are based on an average hide size of 50 square feet.

Contact Customer Service for any of the following conditions:

- + approval of COM/COL to be used  
 (see policy on the next page)
- + fabric repeats greater than 3"
- + fabric less than 54" wide
- + leather hides smaller than 50 square feet
- + special application requirements request

When requesting information from Customer Service on COM/COL please supply the following information:

- + model number and quantity of the product the COM/COL will be applied
- + COM/COL textile supplier's name
- + name of pattern and color of the textile
- + any special application request

Customer Service will check the database to see if the textile has already been approved. If there is no record for this particular textile then a Memo Sample will be required.

Send a Memo Sample of the COM/COL  
 (recommended memo be at least 4" x 4")

JSI  
 Attn: COM/COL Approval Department  
 Receiving B  
 Dock 71  
 201 East Martin St.  
 Orleans, IN 47452

JSI takes no responsibility when additional materials must be ordered.

All COM/COL must meet applicable codes and regulations, including TB117-2013. By selecting COM/COL, customer certifies that the material meets such codes. JSI assumes no responsibility for the applicable codes and regulation regarding flammability rating and safety rating of any COM/COL.

JSI will review and test as needed all requests. You will be notified as soon as results are documented by our review personnel. JSI reserves the right to reject any COM/COL on our products. We will provide COM/COL explanation of any unapproved textile whenever possible.

JSI cannot be held responsible for receipt of defective fabrics, as we apply all COM as first quality goods.

We can take no responsibility for tailoring, wear-ability or application of COM/COL textiles. Any warranty claims for the COM/COL Textile materials will fall to the original vendor of the textile, not JSI.

# Textile and Leather Swatch Card Program

## Maharam - M Series Card

### Pattern - Manner

#### Grade - C

##### Colorways

MAN013	Ablaze	MAN020	Parakeet
MAN022	Aquatic	MAN046	Passerine
MAN026	Basin	MAN014	Peel
MAN023	Cottage	MAN003	Porpoise
MAN035	Cruise	MAN048	Roseate
MAN043	Dill	MAN027	Schooner
MAN004	Flint	MAN050	Siltstone
MAN005	Hush	MAN029	Silverpoint
MAN051	Kimono	MAN038	Tidewater
MAN032	Magnetic	MAN052	Valiant
MAN040	Oceanside	MAN033	Woad

### Pattern - Meld

#### Grade - C

##### Colorways

MLD018	Amethyst	MLD020	Magma
MLD026	Bare	MLD041	Mariner
MLD027	Blonde	MLD036	Nordic
MLD009	Bulb	MLD002	Panda
MLD023	Clementine	MLD005	Quill
MLD029	Comet	MLD037	Reef
MLD014	Crater	MLD003	Skyline
MLD017	Fuchsia	MLD011	Stark
MLD007	Grate	MLD035	Waterfall
MLD022	Heat	MLD031	Wild
MLD034	Kale		

### Pattern - Messenger

#### Grade - C

##### Colorways

MES028	Apple	MES16	Ice
MES029	Ash	MES037	Lime
MES13	Azure	MES038	Longspur
MES04	Bayou	MES24	Lumine
MES030	Blanch	MES07	Mao
MES031	Capri	MES12	Nile
MES032	Cassis	MES09	Onyx
MES033	Cherry	MES039	Satsuma
MES10	Cloud	MES040	Snow
MES11	Depth	MES23	Tangelo
MES034	Dipper	MES041	Vireo
MES035	Everglade	MES042	Voyage
MES036	Hunter		

### Pattern - Metric

#### Grade - C

##### Colorways

MTR026	Admiral	MTR013	Lava
MTR020	Alligator	MTR034	Midday
MTR024	Anchor	MTR027	Seaport
MTR012	Cardinal	MTR029	Skate
MTR031	Film	MTR040	Sunny
MTR043	Galah	MTR035	Talisman
MTR030	Hopscotch		

### Pattern - Murmur

#### Grade - C

##### Colorways

MUR010	Baby	MUR002	Harmonica
MUR015	Biome	MUR012	Iceberg
MUR006	Cauldron	MUR019	Ignite
MUR004	Dim	MUR005	Peppercorn
MUR011	Elderberry	MUR008	Rapids
MUR001	Gust	MUR009	Seawater

### Pattern - Muse

#### Grade - C

##### Colorways

MUS004	Ascend	MUS018	Noble
MUS030	Celebrate	MUS029	Poinsettia
MUS007	Clear	MUS019	Pulsar
MUS010	Compass	MUS006	Refresh
MUS001	Crescendo	MUS002	Resonate
MUS016	Frigid	MUS017	Riverbend
MUS013	Goal	MUS003	Runway
MUS012	Grasshopper	MUS031	Spectacle
MUS027	Jovial	MUS028	Theater
MUS014	Mistletoe	MUS023	Vase
MUS026	Neat		

**NOW!**  
Need it.  
JSI Quickship

M Series patterns and colors listed above are available for quickship.

# Textile and Leather Swatch Card Program

## Maharam - Mode

### Pattern - Mode

#### Grade - D

#### Colorways

MOD01 Alder*	MOD08 Clavicle*	MOD17 Jetty*	MOD26 Ominous*	MOD35 Stroll*
MOD02 Angelfish	MOD09 Cottontail	MOD18 Kermes	MOD27 Oriole*	MOD36 Sycamore*
MOD03 Ballpoint	MOD10 Crush*	MOD19 Lemon	MOD28 Oxeye*	MOD37 Talus*
MOD04 Barberry	MOD11 Denim*	MOD20 Lichen	MOD29 Paradise	MOD38 Toile
MOD05 Billygoat*	MOD12 Eucalyptus	MOD21 Lioness	MOD30 Petal*	MOD42 Valley
MOD40 Blush*	MOD13 Goldenrod*	MOD22 Machine*	MOD31 Rust*	MOD39 Vermillion*
MOD41 Bonsai*	MOD14 Henge*	MOD23 Mallard	MOD32 Saltwater*	MOD43 Yucca
MOD06 Carotene	MOD15 Hollow*	MOD24 Marsh	MOD33 Sassafras*	
MOD07 Celtic*	MOD16 Intaglio*	MOD25 Odyssey*	MOD34 Spindle*	

**NOW!**  
Need it.  
JSI Quickship

Select Mode colors, denoted by \* are available on quickship.  
Check availability for all other colors.

## Maharam - Value Reference 6 Card

### Pattern - Brindle

#### Grade - D

#### Colorways

BRN001 Calico	BRN010 Seagrass
BRN003 Torch	BRN012 Aquarium
BRN009 Inland	

### Pattern - Keen

#### Grade - D

#### Colorways

KEE001 Gaur	KEE004 Oatmeal
KEE002 Lock	KEE007 Coyote

### Pattern - Multiply

#### Grade - E

#### Colorways

MUL002 Encore	MUL010 Deep
MUL006 Daze	

### Pattern - Wend

#### Grade - D

#### Colorways

WEN002 Tulle	WEN010 Sigma
WEN008 Midi	WEN011 Riverfront

### Pattern - Caper

#### Grade - E

#### Colorways

CAP006 Note	CAP007 Silverback
-------------	-------------------

### Pattern - Loop

#### Grade - E

#### Colorways

LOO003 Navel	LOO010 Penguin
LOO008 Wildfire	

### Pattern - Spry

#### Grade - D

#### Colorways

SPR003 Fizz	SPR007 Trance
SPR006 Jam	

### Pattern - Conduit

#### Grade - E

#### Colorways

CON003 Nimbus	CON007 Caribbean
CON005 Fawn	CON008 Canal

### Pattern - Lunar

#### Grade - D

#### Colorways

LUN002 Jingle	LUN005 Grace
LUN004 Code	

### Pattern - Trundle

#### Grade - D

#### Colorways

TRU002 Element	TRU008 Wake
TRU003 Ray	TRU011 Magnet
TRU005 Aloe	

**NOW!**  
Need it.  
JSI Quickship

Value Reference 6 patterns and colors listed above are available for quickship.

# Textile and Leather Swatch Card Program

## Momentum - Color Card

### Pattern - Infinity C-Zero

#### Grade - C

##### Colorways

INF01	Aluminum	INF17	Maize
INF02	Aster	INF18	Papaya
INF03	Atoll	INF19	Pewter
INF04	Barley	INF22	Rinse
INF05	Berry	INF24	Sable
INF07	Capri	INF25	Stucco
INF08	Dove	INF26	Terrain
INF10	Graphite	INF30	Vine
INF11	Gull		

### Pattern - Marathon C-Zero

#### Grade - C

##### Colorways

MRN01	Alert	MRN16	Noir
MRN03	Caravel	MRN18	Oz
MRN06	Clove	MRN19	Pinot
MRN07	Curry	MRN20	Pollen
MRN08	Cyan	MRN21	Rain
MRN09	Deep	MRN23	Sprite
MRN10	Flax	MRN24	Storm
MRN12	Foliage	MRN27	Toile
MRN13	Herb	MRN29	Vivacious
MRN15	Marigold		

### Pattern - Millennium C-Zero

#### Grade - C

##### Colorways

MLL02	Amber	MLL20	Plateau
MLL04	Cascade	MLL21	Pool
MLL06	Cerise	MLL22	Pyrite
MLL07	Clean	MLL23	Safari
MLL08	Coastal	MLL24	Sapphire
MLL10	Crisp	MLL25	Spark
MLL11	Electric	MLL26	Steel
MLL17	Onyx	MLL27	Tanzanite
MLL18	Orchid	MLL28	Thrill
MLL19	Peridot	MLL30	Zinc

### Pattern - Odyssey C-Zero

#### Grade - C

##### Colorways

ODY02	Amp	ODY17	Linen
ODY03	Breeze	ODY19	Maritime
ODY06	Cedar	ODY23	Primary
ODY07	Craft	ODY24	Roast
ODY08	Cruise	ODY25	Rue
ODY10	Eggplant	ODY26	Sangria
ODY11	Emerald	ODY27	Skim
ODY12	Fossil	ODY28	Smith
ODY13	Ink	ODY29	Tinge
ODY15	Iris	ODY30	Western

### Pattern - Tradition C-Zero

#### Grade - C

##### Colorways

TRD01	Ash	TRD14	Malbec
TRD02	Branch	TRD16	Mist
TRD03	Class	TRD18	Plated
TRD04	Distant	TRD19	Regal
TRD05	Flirt	TRD21	Soar
TRD06	Fronde	TRD22	Soy
TRD08	Hedge	TRD24	Sprout
TRD09	Hidden	TRD26	Sun
TRD12	Kelly	TRD27	Tango
TRD13	Latte	TRD29	Wash

**NOW!**  
Need it.  
JSI Quickship

Color Card patterns and colors listed above are available for quickship.

# Textile and Leather Swatch Card Program

## Momentum - Everyday Solutions III Card

### Pattern - Bangle

Grade - A

Colorways

BAN01	Baltic	BAN05	Sable
BAN02	Cork	BAN06	Suede
BAN03	Granite	BAN07	Teak
BAN04	Orchid		

### Pattern - Bobby

Grade - B

Colorways

BOB01	Anchor	BOB05	Iris
BOB02	Aqua	BOB06	Lemon
BOB03	Fuchsia	BOB07	Moss
BOB04	Glow		

### Pattern - Canter EPU

Grade - C

Colorways

CNR35	Folkstone Grey	CNR11	Safari
CNR19	Ink	CNR09	Sable
CNR20	Iron	CNR12	Sand
CNR08	Onyx		

### Pattern - Dart

Grade - C

Colorways

DAR01	Ash	DAR05	Geode
DAR02	Cadet	DAR06	Ink
DAR03	Carmine	DAR07	Slate
DAR04	Ebony		

### Pattern - Free

Grade - D

Colorways

FRE01	Cocoa	FRE05	Orbit
FRE02	Evening	FRE06	Pearl
FRE03	Graphite	FRE07	Platinum
FRE04	Oasis		

### Pattern - Fuse

Grade - A

Colorways

FUS11	Azurean	FUS07	Pepper
FUS01	Carmine	FUS13	Pristine
FUS02	Cress	FUS10	Walnut
FUS04	Lunar		

### Pattern - Graph

Grade - B

Colorways

GRA01	Alpine	GRA05	Parrot
GRA08	Anchor	GRA06	Ruby
GRA02	Chalice	GRA09	Wave
GRA03	Coal		

### Pattern - Guild

Grade - A

Colorways

GLD01	Celadon	GLD05	London
GLD02	Cyan	GLD06	Mandarin
GLD03	Earthen	GLD07	Shale
GLD04	Ink		

### Pattern - Insight

Grade - A

Colorways

INS07	Ebony	INS10	Real Red
INS08	Fossil	INS03	Summit
INS06	Midnight	INS012	Wasabi
INS09	Periwinkle		

### Pattern - Knack

Grade - C

Colorways

KNA05	Brisk	KNA01	Reed
KNA06	Carbon	KNA02	Teak
KNA08	Filament	KNA13	Zing
KNA09	Fresco		

### Pattern - Lens

Grade - C

Colorways

LEN01	Crimson	LEN04	Sand
LEN02	Graphite	LEN05	Silver
LEN03	Navy	LEN07	Terra
LEN06	Night		

### Pattern - Origin

Grade - A

Colorways

ORG20	Euro	ORG07	Iron
ORG22	Gaia	ORG08	Jet
ORG05	Garnet	ORG26	Poppy
ORG06	Indigo		

### Pattern - Parenthesis

Grade - A

Colorways

PAR01	Capri	PAR07	Mercury
PAR05	Charcoal	PAR03	Steel
PAR06	Ink	PAR04	Violet
PAR02	Lime		

### Pattern - Skip

Grade - C

Colorways

SKP01	Chalk	SKP09	Ruby
SKP04	Nickel	SKP06	Sprite
SKP08	Onyx	SKP07	Yacht
SKP05	Pool		

### Pattern - Slice

Grade - B

Colorways

SLI01	Admiral	SLI04	Miller
SLI02	Charcoal	SLI05	Pumice
SLI06	Graphite	SLI07	Slate
SLI03	Henna		

**NOW!**  
Need it.  
JSI Quickship

Everyday Solutions III patterns and colors listed above are available for quickship.

# Textile and Leather Swatch Card Program

## Momentum - Inspired Crypton Performance Card

### Pattern - Cover Cloth Grade - D

#### Colorways

CVR02	Cyan	CVR08	Platinum
CVR03	Delft	CVR10	Sorrel
CVR04	Graphite	CVR17	Vesper
CVR14	Indigo	CVR12	Vessel
CVR06	Jet	CVR13	Zest
CVR07	Oat		

### Pattern - Faux Felt Grade - D

#### Colorways

FXF08	Charcoal	FXF04	Pool
FXF09	Coral	FXF05	Quail
FXF02	Flannel	FXF06	Sprout
FXF10	Graphite	FXF07	Stone
FXF11	Lagoon	FXF13	Vibrant
FXF12	Pebble		

### Pattern - Flock Grade - D

#### Colorways

FLC01	Amber	FLC07	Harp
FLC02	Baltic	FLC11	Lapis
FLC03	Cayman	FLC08	Nickel
FLC04	Dusk	FLC09	Paprika
FLC05	Fern	FLC10	Twine
FLC06	Flint		

### Pattern - Hobnob Grade - D

#### Colorways

HOB01	Ash	HOB06	Iris
HOB02	Bay	HOB13	Limon
HOB03	Carbon	HOB07	Shale
HOB11	Depth	HOB08	Smith
HOB04	Dew	HOB09	Tangelo
HOB12	Forest	HOB14	Teal
HOB05	Ginger	HOB10	Zebra

### Pattern - Keynote Grade - D

#### Colorways

KYN04	Chai	KYN05	Reflect
KYN01	Granite		

### Pattern - Solitaire Grade - D

#### Colorways

SOL15	Aztec	SOL08	Griffin
SOL01	Cadet	SOL09	Jubilee
SOL02	Currant	SOL10	Midnight
SOL03	Cyan	SOL11	Onyx
SOL04	Dove	SOL12	Pumice
SOL05	Flax	SOL13	Tinsel
SOL06	Galena	SOL14	Tobacco
SOL07	Graphite		

### Pattern - Kit Grade - E

#### Colorways

KIT01	Aqua	KIT06	Moonstone
KIT02	Blazer	KIT07	Pacific
KIT03	Earth	KIT08	Paradise
KIT04	Ebony	KIT09	Pebble
KIT05	Fiesta	KIT10	Quartz
KIT11	Mocha		

### Pattern - Sport Grade - D

#### Colorways

SPT01	Alarm	SPT11	Mercury
SPT02	Apple	SPT08	Onyx
SPT03	Brick	SPT09	Pewter
SPT04	Cadet	SPT12	Pumice
SPT05	Cobalt	SPT13	Spa
SPT06	Dayglow	SPT10	Turquoise
SPT07	Flax		

### Pattern - Oath Grade - E

#### Colorways

OTH01	Azure	OTH03	Juniper
OTH02	Charcoal		

### Pattern - Synergy Grade - D

#### Colorways

SGY01	Aegean	SGY03	Carbon
SGY02	Bedrock	SGY04	Denim

**NOW!**  
Need it.  
JSI Quickship

Inspired Crypton Performance patterns and colors listed above are available for quickship.



# Textile and Leather Swatch Card Program

## Momentum - Midday Solutions II Card

### Pattern - Amuse

#### Grade - D

##### Colorways

AMU01	Admiral	AMU05	Poppy
AMU02	Alloy	AMU04	Quartz
AMU03	Mocha		

### Pattern - Boom II

#### Grade - D

##### Colorways

BOM14	Cloud	BOM06	Mushroom
BOM15	Foliage	BOM19	Toucan
BOM18	Pewter	BOM20	Wall Street

### Pattern - Habit

#### Grade - C

##### Colorways

HAB01	Aspen	HAB04	Pier
HAB05	Blueprint	HAB06	Salt
HAB02	Dune	HAB07	Tailor
HAB03	Kindle		

### Pattern - Otto

#### Grade - D

##### Colorways

OTT01	Alarm	OTT08	Midas
OTT02	Alloy	OTT09	Mineral
OTT03	Cyprus	OTT10	Pumice
OTT04	Driftwood	OTT11	Seed
OTT05	Flint	OTT12	Slate
OTT06	Grotto	OTT13	Vivid
OTT07	Gulf		

### Pattern - Stroll

#### Grade - E

##### Colorways

STO01	Alert	STO05	Parchment
STO02	Flax	STO06	Silver
STO03	Grotto	STO07	Steinway
STO04	Nitro		

### Pattern - Beep

#### Grade - D

##### Colorways

BEP01	Bridge	BEP04	Pontoon
BEP03	Greenlight	BEP05	Steel
BEP06	Jet		

### Pattern - Bravo II

#### Grade - D

##### Colorways

BRV19	Black	BRV13	Mica
BRV20	Cinder	BRV15	Night
BRV12	Dusk	BRV07	Saddle
BRV25	Graystone		

### Pattern - Lineup

#### Grade - C

##### Colorways

LUP01	Baltic	LUP05	Shadow
LUP02	Fern	LUP06	Spice
LUP03	Pewter	LUP07	Tranquil
LUP04	Sandstone		

### Pattern - Pip

#### Grade - D

##### Colorways

PIP01	Anise	PIP09	Malachite
PIP02	Calico	PIP10	Pepper
PIP03	Calypso	PIP11	Pewter
PIP04	Chalice	PIP07	Rune
PIP05	Crimson	PIP12	Turrent
PIP06	Dusk	PIP13	Yacht
PIP08	Lake	PIP14	Zest

### Pattern - Tanner

#### Grade - D

##### Colorways

TAN01	Black	TAN05	Nickel
TAN02	Bonsai	TAN06	Sapphire
TAN03	Lagoon	TAN07	Tint
TAN04	Natural		

### Pattern - Beta

#### Grade - D

##### Colorways

BET01	Bark	BET09	Koi
BET02	Basalt	BET10	Lapis
BET03	Cadet	BET11	Madder
BET04	Cassis	BET12	Malt
BET05	Cinder	BET13	Pearl
BET06	Crater	BET14	Sand
BET07	Deck	BET15	Twine
BET08	Ivy		

### Pattern - Faux Felt

#### Grade - D

##### Colorways

FXF01	Bark	FXF06	Sprout
FXF02	Flannel	FXF07	Stone
FXF12	Pebble	FXF13	Vibrant
FXF03	Pool		

### Pattern - Solace

#### Grade - D

##### Colorways

SOC02	Azul	SOC13	Lapis
SOC09	Fossil	SOC16	Nickel
SOC10	Glided	SOC18	Pear
SOC12	Ivory		

### Pattern - Toggle

#### Grade - C

##### Colorways

TOG01	Agave	TOG05	Lead
TOG02	Flint	TOG06	Punch
TOG03	Iron	TOG07	Quarry
TOG04	Lapis		

# Textile and Leather Swatch Card Program

## Momentum - PVC Free Coated Solutions Card

### Pattern - Beeline EPU

#### Grade - D

##### Colorways

BEL01	Canvas	BEL18	Oat
BEL02	Cork	BEL09	Oriole
BEL03	Eclipse	BEL11	Portobello
BEL04	Eucalyptus	BEL12	Sisal
BEL05	Forge	BEL13	Sprout
BEL06	Fossil	BEL14	Sundance
BEL07	Geyser	BEL15	Tidal
BEL19	Jetty	BEL21	Valley
BEL20	Lake	BEL16	Walnut
BEL08	Nimbus		

### Pattern - Canter EPU

#### Grade - C

##### Colorways

CNR01	Alfalfa	CNR08	Onyx
CNR14	Ballad	CNR25	Quarry
CNR16	Basalt	CNR09	Sable
CNR03	Bordeaux	CNR10	Saddle
CNR17	Brazen	CNR11	Safari
CNR05	Earth	CNR12	Sand
CNR19	Ink	CNR26	Storm
CNR20	Iron	CNR27	Sumac
CNR07	Night	CNR37	Summer White
CNR23	Nimbus		

### Pattern - Endurance EPU

#### Grade - D

##### Colorways

END01	Bisque	END11	Neptune
END02	Bluebell	END12	Noir
END03	Cascade	END13	Nordic
END04	Dove	END14	Paprika
END05	Gravel	END15	Seed
END06	Gull	END16	Smith
END07	Heather	END17	Taupe
END08	Ink	END18	Tobacco
END09	Java	END19	Toffee
END10	Jetty		

### Pattern - Eon EPU

#### Grade - D

##### Colorways

EON16	Anew	EON11	Grove
EON08	Arena	EON12	Hydra
EON09	Ascension	EON13	Mineral
EON17	Atlantic	EON04	Mystery
EON18	Blaze	EON05	Nocturnal
EON10	Coquette	EON06	Omega
EON19	Cove	EON07	Path
EON20	Fire	EON21	Spring
EON01	Freshwater	EON15	Typographic
EON02	Goldmine		

### Pattern - Groove EPU

#### Grade - D

##### Colorways

GRV01	Archive	GRV16	Intense
GRV02	Beach	GRV09	Khaki
GRV03	Calm	GRV17	Maize
GRV04	Demure	GRV10	Polar
GRV14	Digital	GRV18	Seed
GRV15	Ember	GRV11	Stone
GRV05	Expanse	GRV12	Surplus
GRV06	Glacier	GRV13	Vapor
GRV07	Guide	GRV19	Zest
GRV08	Harbor		

### Pattern - Silica

#### Grade - F

##### Colorways

SIL01	Alloy	SIL23	Manor
SIL02	Appletini	SIL24	Marigold
SIL05	Breakwater	SIL43	Nero
SIL07	Brownstone	SIL39	Petunia
SIL10	Cloak	SIL40	Quartz
SIL12	Cumulus	SIL41	Sands
SIL13	Dare	SIL44	Seacoast
SIL42	Eclipse	SIL34	Terra
SIL15	Gallant	SIL35	Tropic
SIL20	Haze		

### Pattern - Silica Leather

#### Grade - F

##### Colorways

SLL01	Almond	SLL10	Ink
SLL02	Aloe	SLL11	Juniper
SLL03	Barley	SLL12	Lichen
SLL04	Chambray	SLL20	Marigold
SLL19	Denim	SLL17	Mink
SLL18	Dove	SLL14	Pewter
SLL05	Driftwood	SLL16	Saddle
SLL06	Dune	SLL21	Shadow
SLL08	Eclipse	SLL22	Umber
SLL09	Hyacinth		

### Pattern - Silica Triad

#### Grade - F

##### Colorways

SLD01	Brew	SLD11	Luster
SLD02	Bronze	SLD12	Mood
SLD03	Char	SLD13	Orchid
SLD04	Conceal	SLD14	Remote
SLD05	Crest	SLD15	Settle
SLD06	Everglade	SLD16	Smoke
SLD07	Heat	SLD17	Sonar
SLD08	Heron	SLD18	Stark
SLD09	Hover	SLD19	Zing
SLD10	Lazuli		

### Pattern - Whit EPU

#### Grade - D

##### Colorways

WHT01	Blush	WHT11	Madder
WHT02	Cane	WHT12	Nightfall
WHT03	Castle	WHT13	Ocean
WHT04	Delft	WHT14	Path
WHT05	Driftwood	WHT15	Platinum
WHT06	Fable	WHT16	Smith
WHT07	Flint	WHT17	Storm
WHT08	Humble	WHT18	Verbena
WHT09	Inland	WHT19	Zephyr
WHT10	Jet		

**NOW!**  
Need it.  
JSI Quickship

PVC Free Coated Solutions patterns and colors listed above are available for quickship.

# Textile and Leather Swatch Card Program

## Spradling - Coated Solution - Vinyls by Spradling

### Pattern - Edgeline

#### Grade - C

##### Colorways

EDG1857	Atlantic	EDG1866	Jasper
EDG1860	Aubergine	EDG1865	Latte
EDG1862	Autumn	EDG1859	Midnight
EDG1868	Caramel	EDG1867	Mustard
EDG1872	Charcoal	EDG1856	Olive
EDG1853	Clover	EDG1852	Peacock
EDG1864	Crimson	EDG1870	Pewter
EDG1854	Emerald	EDG1858	Royal
EDG1869	Espresso	EDG1861	Ruby
EDG1851	Fullmoon	EDG1863	Sangria
EDG1871	Graphite	EDG1855	Storm

### Pattern - Maglia

#### Grade - C

##### Colorways

MAG1956	Aegean	MAG1964	Rose
MAG1967	Alaska	MAG1954	Sage
MAG1958	Aqua	MAG1952	Sapphire
MAG1962	Clay	MAG1957	Sky
MAG1963	Coral	MAG1968	Thunder*
MAG1951	Desert	MAG1966	Truffle
MAG1965	Driftwood	MAG1953	Vanilla
MAG1961	Goldenrod	MAG1955	Viridian
MAG1959	Indigo	MAG1960	Wisteria

### Pattern - Silvertex NEO

#### Grade - C

##### Colorways

STX8834	Acid	STX8811	Mandarin
STX8820	Basil	STX8801	Marine Blue
STX8837	Bazaar	STX8824	Meteor
STX8817	Blackberry	STX8825	Mocha
STX8823	Carbon*	STX8839	Plata
STX8819	Celery	STX8818	Sage
STX8808	Champagne	STX8804	Sapphire*
STX8833	Creme de Menthe	STX8840	Sterling*
STX8805	Jet	STX8822	Storm
STX8802	Lagoon	STX8809	Taupe
STX8842	Limoncello	STX8803	Turquoise

### Pattern - Whisper NEO

#### Grade - C

##### Colorways

WHI2120	Antelope	WHI2150	Fawn
WHI2140	Black*	WHI2157	Fog
WHI2117	Bone	WHI2129	Forest
WHI2118	Camel	WHI2163	Indigo
WHI2121	Cappuccino	WHI2123	Luggage
WHI2141	Cashew	WHI2165	Molten
WHI2136	Cerulean	WHI2137	Navy
WHI2139	Charcoal	WHI2162	Paradise
WHI2142	Cognac	WHI2134	Patina
WHI2138	Elephant*	WHI2154	Pewter*
WHI2143	Espresso	WHI2155	Storm

**NOW!**  
Need it.  
JSI Quickship

Select Coated Solutions colors, denoted by \* are available on quickship.  
Check availability for all other colors.s

## Stinson - Lara Card

### Pattern - Lara

#### Grade - C

##### Colorways

LRA81	Athens	LRA86	Gate	LRA83	Minty	LRA61	Salsa	LRA82	Titanium
LRA90	Bahama	LRA87	Haze	LRA57	Miso	LRA103	Sherwood	LRA95	Tranquil
LRA97	Barista	LRA96	Hearth	LRA105	Mystery	LRA66	Spice	LRA76	Velvet
LRA78	Barre	LRA88	Hydro	LRA94	Patriot	LRA50	Stone	LRA68	Vicuna
LRA84	Blue Ice	LRA106	Java	LRA64	Pear	LRA67	Tamale	LRA100	Wizard
LRA52	Blush	LRA91	Kitten	LRA107	Pitch	LRA69	Taupe		
LRA70	Cashew	LRA85	Lake	LRA71	Plum	LRA75	Tawny		
LRA89	Champion	LRA65	Marigold	LRA72	Port	LRA101	Tempest		
LRA102	Espresso	LRA99	Mid-Blue	LRA73	Pumice	LRA74	Timberland		
LRA104	Evening	LRA92	Mink	LRA62	Red Earth	LRA80	Tint		

**NOW!**  
Need it.  
JSI Quickship

Lara patterns and colors listed above are available for quickship.

# Textile and Leather Swatch Card Program

## Ultrafabrics 2020 Card

### Pattern - Brisa | Original Grade - E

#### Colorways

BRI34 Ash*	BRI46 Evening Blue
BRI37 Bark	BRI47 Ginger
BRI31 Birch	BRI48 Mineral
BRI21 Black Onyx*	BRI49 New Sand
BRI20 Cabernet	BRI12 Night Navy
BRI35 Cambridge Blue	BRI15 Sage
BRI18 Canyon	BRI17 Truffle*
BRI44 Caramel	BRI24 White*
BRI23 Celery	BRI50 Wishbone
BRI45 Cinnabar	BRI51 Wrought Iron

### Pattern - Ultraleather Promessa Grade - E

#### Colorways

PME14 Ash	PME18 Horsehair
PME15 Aspen Green	PME02 Parchment*
PME01 Atlantic	PME19 Snow
PME16 Battleship	PME20 Sun Shower
PME05 Bronze	PME21 Tusk
PME17 Corn Flour	PME22 Woodpecker
PME08 Dogwood	

### Pattern - Brisa | Distressed Grade - E

#### Colorways

BDS03 Buckskin	BDS14 Navajo Ivory
BDS12 Coyote	BDS15 Railroad
BDS13 Moccasin	BDS11 Shield

### Pattern - Ultraleather Tottori Grade - E

#### Colorways

TOT01 Black Sesame*	TOT08 Rice Paper
TOT02 Blue Mirage	TOT09 Rouge
TOT03 Desert Dune	TOT10 Sand Castle
TOT04 Ginseng*	TOT11 Shibori Blue
TOT05 Hot Spring	TOT12 Soy Sauce
TOT06 Lichen*	TOT13 Udon
TOT07 Orchid	

### Pattern - Ultraleather Pro Grade - F

#### Colorways

ULP01 Blueberry	ULP16 Mortar
ULP02 Campfire*	ULP08 Parfait
ULP03 Char	ULP17 Sailor
ULP05 Cloud*	ULP18 Swan
ULP06 Coastal*	ULP12 White Wash*
ULP14 Cork*	ULP13 Woodcres
ULP15 Dark Chocolate	

**NOW!**  
Need it.  
JSI Quickship

Select Ultrafabrics 2020 colors, denoted by \* are available on quickship.  
Check availability for all other colors.

## Cortina - Davenport Leather Card

### Pattern - Davenport Grade - L1

#### Colorways

DAV9968 Aluminum	DAV1112 Black*	DAV9969 Evergreen	DAV9945 Rosewood
DAV9202 Amethyst	DAV1097 Brown	DAV4536 Fog*	DAV9788 Saddle
DAV7378 Atlantis*	DAV7835 Camel	DAV9970 Mist	DAV7579 Smoke
DAV7800 Austin	DAV8774 Chamois	DAV9967 Nutmeg	DAV9203 Spring
DAV8548 Bark	DAV9204 Copper	DAV8554 Olive*	DAV8779 Storm
DAV9206 Bayview	DAV8979 Cream	DAV4536 Plum	DAV8787 Tomato
DAV9201 Berry	DAV7298 Dusk	DAV7574 Porcellana	DAV7349 Wet Sand*
DAV7153 Bittersweet*	DAV7568 Earthy*	DAV9966 Powder*	DAV7582 Yonder

**NOW!**  
Need it.  
JSI Quickship

Select Cortina - Davenport Leather colors, denoted by \* are available on quickship.  
Check availability for all other colors.

## Cortina - Caprone + Old English Leather Card

### Pattern - Caprone Grade - L2

#### Colorways

CPN004 Acorn	CPN073 Koala
CPN032 Blueberry	CPN089 Laguna
CPN111 Bright White	CPN007 Maple
CPN027 Cloud	CPN071 Persimmon
CPN034 Cocoa	CPN092 Picholine
CPN039 Ebony	CPN016 Plum
CPN010 Glove	CPN037 Seal
CPN012 Gunmetal	CPN082 Stucco
CPN044 Heron	CPN087 Sublime
CPN030 Holly	CPN088 Tiffany
CPN030 It's A Boy	

### Pattern - Old English Grade - L2

#### Colorways

COA0096 Black	COA1572 Medium Blue
COA1520 Blackberry	COA1649 Navy
COA1263 Brown	COA1500 Rouge
COA7949 Camel	COA3144 Walnut
COA9887 Grey	

## Arc Com Fabric Grading

For memo samples order online at [www.arc-com.com](http://www.arc-com.com) or call Arc-Com at 800-223-5466Grades and availability of fabric are subject to change without notice. Changes could include but are not limited to price increases, discontinued patterns, discontinued colors, etc. See [jsifurniture.com](http://jsifurniture.com) for updated information.

Pattern	Grade	Pattern	Grade	Pattern	Grade
Aberdeen	J	Harlequin	I	Roundabout	F
Alpha	F	Highlands	G	Santa Fe	F
Ambiance	E	Hush	F	Santorini	G
Apex	I	Illusion	D	Saxon	G
Apollo	F	Illusion 2	D	Sea Willow	J
Arabesque	G	Insight	D	Sector	G
Arashi	H	Intaglio	F	Sherlock	E
Around	G	Intaglio 2	F	Sherlock 2	E
Astor	F	Intersect	F	Shimmer	E
Atomic	I	Interstate	F	Shimmer 2	E
Axis	G	Iona	F	Silverado	E
Bali	I	Isabella	E	Silverado 2	E
Block Petal	I	Itajime	H	Skye	G
Boardwalk	F	Jive	G	Soho	D
Bocce	H	Journey	G	Solitude	G
Bronco	F	Kaolin	F	Sonata Stripe	H
Burkina	H	Katano	G	Sonic	F
Cadence	F	Key	G	Spectrum	E
Carnival	F	Kinetic	H	Speedway	G
Cavo	G	Kuba	I	Spin	H
Centring Stripe	I	Kumo	G	Spinnaker	I
Channel	E	Legacy	F	Spirit	E
Chroma	E	Legend	F	Square One	I
Cirque	H	Linea	F	Staccato	J
Coastline	E	Loara	H	Stallion	C
Column	F	Lore	G	Strata	E
Compass	J	Lunette	J	Streamline	G
Contour	G	Luxe	G	Sukhala	I
Cosmos	G	Lyre	F	Sundial	H
Crescendo	H	Lyric	I	Sync	F
Dakota	E	Majorca	G	Tailored	F
Dakota	E	Marathon	F	Talavera	J
Daytona	H	Marquee	G	Tally	F
Dazzle	I	Mason	G	Tectonic	G
Delphi	E	Mason Stripe	G	The Plaid	J
Delta	E	Meadow	I	Tick-Tock	G
Drifter	E	Mesa	F	Transform	D
Durango	D	Montage	J	Traverse	G
Dynasty	F	Moon Beam 2	F	Vault	I
Eden	J	Morgan	F	Venture	I
Elementary	I	Nahouri	I	Victoria	G
Elevado	F	Network	I	Watson	D
Emerson	D	Oculus	F		
Empress	E	Odyssey	F		
Encore	E	Ombre Petal	I		
Engrave	F	Omega	F		
Etch	E	Palatine 2	F		
Evolution	I	Paragon	I		
Fiji	F	Paxton	G		
Fragment	I	Perspective	H		
Frontier	D	Polished	F		
Galaxy	H	Polo	G		
Gamma	E	Posh	G		
Gardenia	G	Primavera	G		
Gatsby	E	Quest	H		
Gem	E	Radius	I		
Geostitch	H	Raya	G		
Glam	F	Reality Check	G		
Glo	F	Rodeo	D		
Great Wall	G	Rodeo 2	D		
Grid	G	Rogue	F		

Effective October 22, 2021

## Designtex Fabric Grading

For memo samples order online at [www.designtex.com](http://www.designtex.com) or call Designtex at 800-221-1540

Grades and availability of fabric are subject to change without notice. Changes could include but are not limited to price increases, discontinued patterns, discontinued colors, etc. See [jsifurniture.com](http://jsifurniture.com) for updated information.

Pattern	Grade	Pattern	Grade	Pattern	Grade
Acacia	H	Geometric II	J	Raia	J
Adler	F	Gleam	G	Rainwater	I
Alcazar	E	Glimmer	F	Reppweave	E
Aloft	F	Gridley	D	Revelry	G
Annex	F	Hashtag	E	Rider	F
Appleseed	G	Heather	G	Rise	E
Arne	E	Hint	F	Rocket	D
Aspect	D	Holmes	H	Rodenbach	I
Atria	H	Hyde	D	Rotary	J
Bark Cloth	F	Hyphen	F	Rove	H
Big Dot	G	Ink	I	Samba	H
Big Texture	G	Interlock	H	Scale	F
Billiard Cloth	F	Interlude	I	Schism	F
Birdseye	D	Iota	E	Segment	I
Bixby Macro	I	Jaunt	I	Shortcut	I
Bixby Micro	H	Josef	G	Silicone Element	G
Boucle	G	Jumper	I	Silicone Element	H
Boucle Dot	G	Kami	I	Celliant	H
Boucle Melange	H	Keen	G	Silicone Nappa	G
Brushed Flannel	E	Kindred	H	Sketch	I
Building Blocks	I	Kith	E	Sorano	E
Bunta	G	Lambert	I	Span	E
Burlap Weave	F	Latitude	I	Spandau	E
Burrard	I	Lattice	H	Splice	F
Burrard Ground Cloth	G	Leap	G	Split	F
Bute Braemar	J	Linen Like	F	Sprint	H
Bute Melrose	J	Linnen	F	Standard	H
Bute Tweed	I	Little Dot	G	Starburst	I
Carom	I	Loop To Loop	H	Stratum	I
Carrick	J	Lumi	I	Stride	E
Chapiteau	F	Luster	G	Subtle	F
Chenille Chevron	J	Mark	E	Symbol	J
Chunky Tweed	H	Mateo	F	System	F
Clad Celliant	E	Measure	F	Tack Cloth	G
Cloud Velvet	E	Melange	E	Tap	H
Code	G	Metallo	F	Terra	F
Collier	F	Metta	E	Tilt	J
Colten	F	Microgrid	F	Tiny Boucle	F
Corded	H	Migration	I	Tiny Herringbone	F
Course	I	Minnie	D	Tramway	I
Crossweave	E	Mod	H	Treeline	I
Crosswind	G	Mohair Plus	J	Trim	I
Cubitt	I	Motif	H	Trove	E
Current	G	Mountainous	I	Tumbleweed	G
Dapple	H	Nest	F	Tweed Multi	E
Dart	H	Nook	E	Ulster 4149	C
Delaine	F	Opulent	E	Ulster Upholstery	D
Distressed Texture	G	Pause	F	3957	D
Double Weave	I	Pave	H	Union Cloth	F
Draft	H	Pennant	J	Upholstery	F
Drift	F	Pennant Celliant	J	Velvet Corduroy	I
Ellipsis	D	Pennington	J	Vero	F
Encircle	J	Phenomena	H	Viewpoint	I
Everywhere Texture	F	Pigment	H	Vine	I
Felt 2MM	J	Pika	E	W	F
Flow	J	Pinball	I	Wend	E
Fluent	H	Pinpoint	H	Whim	F
Fomo	F	Pivot	F	Willis	I
Forestbound	F	Plaid	I	Windowpane	F
Gale	F	Plus	I	Crypton	F
Gamut	D	Prime	D	Woolish	D
Gamut Celliant	E	Queue	I		

## Maharam Fabric Grading

For memo samples order online at [www.maharam.com](http://www.maharam.com) or call Maharam at 800-645-3943

Grades and availability of fabric are subject to change without notice. Changes could include but are not limited to price increases, discontinued patterns, discontinued colors, etc. See [jsifurniture.com](http://jsifurniture.com) for updated information.

Pattern	Grade	Pattern	Grade	Pattern	Grade
Ample	I	Gild	F	Quay	F
Anagram	J	Glen	F	Queue	I
Apt	H	Grove	H	Rail	J
Arabesque	J	Hearth	H	Relay	I
Aria	J	Houndstooth	J	Rill	G
Article	E	Insignia	I	Roman	I
Beacon	I	Instill	F	Roster	F
Beck	G	Jasper	G	Route	F
Beryl	G	Keen	D	Rule	I
Bind	I	Lariat	F	Runner	I
Bluff	F	Lean	H	Runner Standard	G
Boundary	G	Ledger	F	Scuba	F
Bright Angle	I	Levity	F	Scute	H
Bright Cube	I	Lift	I	Scuttle	G
Bright Grid	I	Limn	J	Sendal	G
Brim	I	Linden	I	Sequence	G
Brindle	D	Lineage	G	Shadow	H
Brio	I	Link	I	Sheen	G
Buffer	H	Lithe	H	Shift	I
Bureau	E	Loop	E	Sift	I
Bushel	G	Luce	G	Soft Tweed	J
Campana	G	Lunar	D	Sort	J
Candor	F	Manner	C	Span	H
Caper	E	Mantle	E	Splay	G
Chalet	G	Mechanism	I	Spry	D
Chasm	G	Medium	E	Stature	G
Chassis	G	Melange Tweed	J	Steady Crypton	G
Checker	J	Meld	C	Strum	G
Chime	F	Merit	E	Sudden	G
Clamber	I	Mesh	I	Sundry	H
Coach Cloth	J	Messenger	C	Switch	G
Coast	G	Metaphor	D	Swivel	H
Coin	F	Metric	C	Teatro	I
Coin Crypton	G	Mexidot	H	Tempera	H
Compound	G	Micro	F	Tend	J
Conduit	E	Milestone	D	Terra	I
Cosset	G	Mimic	H	Tracery	H
Cotton Velvet	J	Minicheck	J	Trait	G
Cove	I	Mister	I	Transmit	D
Crew	I	Mode	D	Trellis	J
Crush	G	Multiply	E	Trundle	D
Cycle	G	Murmur	C	Valor	I
Dots	J	Muse	C	Veer	F
Double Triangles	J	Nico	E	Voyage	J
Dwell	E	Nimble	G	Wend	D
Ellipsis	J	Offset	I	Wide Corduroy	J
Elm	E	Orbit	F	Willow	I
Embed	G	Pallet	E	Wool Rib	I
Emit	E	Pare	G		
Enmesh	G	Parquet	I		
Equate	H	Pepitas	H		
Facets	J	Pepper	F		
Fathom	G	Petra	G		
Feature	H	Pick	F		
Festoon	J	Pick Crypton	G		
Flint	J	Pinnacle	I		
Fluent Crypton	G	Pitch	F		
Flurry	I	Plait	G		
Frequency	H	Pocket	H		
Gallant	F	Prime	G		
Gemma	G	Prompt	F		
Gemma Multi	G	Province	G		

Effective February 15, 2022

# Mayer Fabric Grading

For memo samples order online at [www.mayerfabrics.com](http://www.mayerfabrics.com) or call Mayer at 800-428-4415.

Grades and availability of fabric are subject to change without notice. Changes could include but are not limited to price increases, discontinued patterns, discontinued colors, etc. See [jsifurniture.com](http://jsifurniture.com) for updated information.

INFORMATION

Pattern	Grade	Pattern	Grade	Pattern	Grade	Pattern	Grade
Abbey	D	Gem	C	Plaza	E	Zazen	G
Acclaim	D	Genesis	C	Polygon	D	Zen	G
Acuco	H	Genesis Plus	D	Positive Thoughts	G		
Align	D	Nanoguard	D	Primo	E		
Ankara	G	Gravity	E	Prism 10	C		
Antique	D	Haarlem	H	Puno	G		
Apollo Silicone	F	Havana	C	Quattro	C		
Arabesque	D	Hexagon	D	Ranchero	B		
Aristocrat	D	Huipil	F	Reflector	G		
Array	E	Images FR	D	Refuge	E		
Bali	C	Imprint	C	Relativity	F		
Batik	D	Infinity	H	Replay	E		
Bolero	E	Interlace	D	Reverb	C		
Boro	H	Intrigue	D	Rift	E		
Botanica	F	Jekyll & Hyde	D	Rumba	C		
Botany	F	Jitterbug	D	Samba	D		
Caressa	D	Jive	C	Saori	H		
Cascade	E	Journey	D	Score	E		
Catwalk	E	Kantha	G	Sequel	C		
Channel	D	Kensington	D	Sequel Plus Nanoguard	D		
Chaps	D	Key Largo	C	Sequence	D		
Charette FR	E	Labyrinth	G	Shantung	E		
Chequers	E	Landscape	F	Signs	I		
Circumference	G	Latitude	F	Silverweave	D		
Cirque	F	Lavish	D	Sketch	D		
Collage	G	Links	D	Slick	D		
Comalapa	H	London	F	Social Network	E		
Contempo	C	Longhorn	E	Soho	F		
Continuum 10	C	Longitude	E	Soleil	G		
Cosmopolitan	D	Lotus	H	Sophisticate	D		
Cross Check	C	Madras	D	Spacer Mesh	C		
Cuddle Up	F	Malibu	D	Special Black Madrid	A		
Curlicue	D	Mandala	I	Special Black Oxen	A		
Dande	E	Marmara	F	Special Black Sierra	A		
Darning	H	Matka	D	Splendor	E		
Debonair	G	Matter	E	Spokes	J		
Destiny	C	Maverick	C	Static	F		
Destiny Plus Nanoguard	D	Mayfair	F	Sula	H		
Disco	D	Meander	E	Suna	H		
Durango	C	Metal Strips	H	Sutra	G		
Duraweave 10	B	Micro Dot	C	Sydney	C		
Echo	D	Milagro	I	Tango	D		
Ecosphere	G	Milano	D	Tattersall	F		
Elevation	F	Mingle	D	Textura	G		
Engrave	C	Mode	D	Theory 10	C		
Entwine	E	Molecule	G	Time Line	D		
Ephesus	G	Moonscape	C	Turnabout	G		
Essence	D	Mosaic	D	Variant 10	C		
Etch	C	Mosaic Plus Nanoguard	E	Vector	H		
Fanfare	H	Neo	D	Venetian	I		
Fedora	C	Niche	E	Verona	D		
Fiji	C	Nirvana	H	Vibrant	E		
Finale	D	Noble	C	Viewpoint	G		
Florentino	C	Nostalgia	D	Villa	F		
Form	E	Nylon-Stat	F	Vintage Mohair	J		
Forte	B	Obsession	F	Vogue	F		
Foundation 10	C	Odessa	F	Volante	I		
Fretwork	G	Optic 10	C	Voyager	E		
Function	D	Outback	C	Whirligig	J		
Gala	F	Palermo	E	Wilson	H		
Galveston	D	Pastime	F	Wool Boucle	G		
Gatsby	D	Patio	C	Xanadu	H		



Effective February 15, 2022

# Momentum Fabric Grading

For memo samples order online at [www.memosamples.com](http://www.memosamples.com) or call Momentum at 800-366-6839

Grades and availability of fabric are subject to change without notice. Changes could include but are not limited to price increases, discontinued patterns, discontinued colors, etc. See [jsifurniture.com](http://jsifurniture.com) for updated information.

Pattern	Grade	Pattern	Grade	Pattern	Grade	Pattern	Grade	Pattern	Grade
Ace	D	Endurance EPU	D	Lore	I	Silica Blend	F	Trefoil	J
Acoustic	G	Eon EPU	D	Ludwig	J	Silica Bracket	G	Tribeca CV	E
Acrobat	J	Essay	H	Mandala	H	Silica Checker	H	Trilogy	G
Agora II	E	Etude	I	Mapping Ideas	I	Silica Chopsticks	H	Tufted	J
Amenity II	H	Evo CV	D	Marathon C-Zero	C	Silica Compass	H	Turin	H
Amuse	D	Evolve	I	Marcel	I	Silica Cusp	H	Uplift	H
Analog	I	Expo	C	Memory	J	Silica Deflect	I	Vanguard CV	E
April	G	Faux Felt	D	Mezzanine	H	Silica Effloresce	H	Velocity	F
Archer	I	Faux Mo	F	Millennium C-Zero	C	Silica Etc.	G	Via	E
Ascend	F	Fleet	G	Mixology CV	D	Silica Etch	F	Viva II	F
Audubon	I	Float	E	Mogul EPU	E	Silica Fiona	I	Vox	C
Bandwidth II	G	Flock	D	Nagoya	I	Silica Flick	I	Wander	H
Bangle	A	Flow	H	Nifty	D	Silica Fresco	G	Waver	F
Banter	I	Flux	I	Nimble	J	Silica Fritz	I	Weaving Palettes	G
Beeline EPU	D	Focal	E	Oath	E	Silica Gidget	I	Whim	G
Beep	D	Fold	I	Odyssey C-Zero	C	Silica Hiatus	I	Whit EPU	D
Beta	D	Follow CV	F	Origin	A	Silica Hoop	G	Widget	C
Bobby	B	Foray	F	Otto	D	Silica Jig	I	Zipped	I
Boom II	D	Foundation	H	Overpass	H	Silica Kip	I		
Boxcar	I	Free	D	Pantheon	I	Silica Leather	F		
Bravo II	D	Fuse	A	Parable	G	Silica Likely	I		
Brink	G	Glide	G	Parenthesis	A	Silica Reach	H		
Brisk	H	Graph	B	Pax	J	Silica Roam	J		
Build	E	Grid	D	Perk	C	Silica Scout	I		
Buoy	H	Groove EPU	D	Phase	I	Silica Spoke	H		
Byways	I	Guild	A	Photon	I	Silica Strata	I		
Cairns	J	Habit	C	Phrase	H	Silica Stride	G		
Camber	H	Halo	I	Pierre	J	Silica Suede	F		
Canter EPU	C	Hearsay	I	Ping	F	Silica Tao	H		
Carlo	I	Highline	I	Pip	D	Silica Tech	F		
Cashmere II	E	Hitch	G	Pique	F	Silica Thatch	G		
Central	F	Hobnob	D	Plan	F	Silica Triad	F		
Centric	G	Hop	G	Platform	G	Silica Waltz	I		
Channel	F	Hue	D	Poetic CV	E	Silica Wifi	I		
Chipper	J	Hyde CV	D	Point	D	Site Line	I		
Chromatic	J	Improv CV	E	Polka	G	Skip	C		
Cityscape	J	Infinity C-Zero	C	Printwork EPU	I	Slice	B		
Civil	G	Infusion	G	Propel	H	Small Talk	H		
Clang	F	Insight	A	Propensity II	D	Solace	D		
Climb	J	Interim	J	Proximity	I	Solitaire	D		
Collect	E	Interlock	J	Raft	H	Spontaneous	I		
Colorwheel	H	Intermix II	E	Rein II	E	Sport	D		
Cover Cloth	D	Iota	H	Reverb	I	Spunk CV	F		
Croquet	I	Jitney	F	Revolve	I	Starboard	I		
Crosswise	E	Jot	D	Riga	I	Stroll	E		
Cube	H	Journal	I	Ring	H	Strum	F		
Culture	F	Kayak	I	Rise	D	Strut	F		
Current	E	Keynote	D	Rivet	F	Subdivide	J		
Cutout	J	Kindred	G	Ronda	G	Sunny	G		
Cycle	F	Kinney	F	Row	E	Swim	D		
Dart	C	Kit	E	Rubato	G	Synergy	D		
Dash	H	Knack	C	Rush Hour	I	Syntax	D		
Dayspell	I	Lasso CV	F	Sail	I	Tack	D		
Decode	D	Lateral	G	Score	H	Tactic	I		
Dexter EPU	E	Ledge	F	Scrabble	D	Tag	I		
Docket	I	Lella	H	Sensory CV	E	Tanner	D		
Domain	G	Leno	I	Shuttle	G	Tesla	H		
Dome CV	F	Lens	C	Sidestep	I	Tilt	G		
Drift	I	Level	H	Silica	F	Toggle	C		
Ebb	J	Lina	J	Silica Andy	I	Traction	I		
Edison	I	Linen CV	E	Silica Arc	I	Tradition C-Zero	C		
Embark	G	Lineup	C	Silica Bauble	I	Trapeze	I		

# Stinson Fabric Grading

For memo samples order online at [www.cfstinson.com](http://www.cfstinson.com) or call Stinson at 800-841-6279

Grades and availability of fabric are subject to change without notice. Changes could include but are not limited to price increases, discontinued patterns, discontinued colors, etc. See [jsifurniture.com](http://jsifurniture.com) for updated information.

Pattern	Grade	Pattern	Grade	Pattern	Grade	Pattern	Grade	Pattern	Grade
Ace	D	Etch	F	Mica/Mica 2.0	D	Satchel	D	Volterra-HC	I
Acrobat	I	Euclid	E	Migration	I	Scintillate	H	Vortexia/	I
Adagio	F	Fast Lane	D	Moby	D	Scout/Scout 2.0	D	Vortexia 2.0	I
Affinity/Affinity 2.0	F	Fenestra Too!	I	Moccasin	C	Script/Script 2.0	D	Walk The Line	J
Alamo	C	Fiberdrill	F	Mod	H	Season	I	Weft	C
Alignment	G	Figment	H	Modena	F	Sedona	I	Whirl	H
Amplify	C	Fizz/Fizz 2.0	F	Monhegan	H	Sensor	G	Winnly	E
Anagram	G	Flanders	D	Montage	F	Sentry-HC/	F	Wish	J
Ardent	C	Fleck	D	Montana	C	Sentry-HC 2.0	D	Ybor	F
Arioso	F	Fractal	H	Natural World	J	Sequence	D	Zanzibar	J
Armature	I	Frequency	G	Nest	I	Serene	H	Ziggy	C
Artisan	D	Full Turn	J	Network	G	Shantung/	C	Zoom	F
Avant	D	Furrows	D	New Hempstead	D	Shantung 2.0	C		
Banyan	F	Fuse/Fuse 2.0	C	Nimble	G	Shift	D		
Bass Line	G	Galileo	F	Nishiki/Nishiki 2.0	D	Shimmy	E		
Bespoke	E	Glisten	I	Nova	F	Shuffle	I		
Bistro	C	Graph	F	Obscura	G	Sideline	F		
Blip	D	Gravity	F	Olivia	C	Silicone - Avail	G		
Bliss	I	Grille/Grille 2.0	D	Olympus/	G	Silicone - Downtown	I		
Borderline	H	Handwork	H	Olympus 2.0	G	Silicone Max - ONE	H		
Breton	G	Happy Tappy	I	Orbit/Orbit 2.0	E	Silicone - Uptown	I		
Brilliant	D	Hashtag	G	Outlander	D	Sirocco	G		
Brixton	G	Haven	F	Overlay	F	Sleek	D		
Brushwork	I	Helix	I	Oxford/Oxford 2.0	D	Sleeping Bear	G		
Bryant Park	D	Hexie	I	Pacifica	H	Dunes	H		
Bubblerake/	J	Hi-Fi	D	Paloma	D	Smoothie/	D		
Bubblerake 2.0	J	Highlands	D	Paradox	I	Smoothie 2.0	D		
Calibration	I	Highlight	D	Park Avenue	F	Solitaire	C		
Cannon Beach	I	Hive	D	Penelope	G	Splice	I		
Carlisle	D	Hopsack	D	Pergola	F	Sprint	C		
Cassidy	D	Hush	F	Perimeter	F	Square One	D		
Catalina	G	I Spy	H	Perspective/	H	Squire	F		
Ceremony	H	Impress w/Stakleen	G	Perspective 2.0	H	Staple	C		
Channel/	E	Infinity Plush	I	Piccadilly	F	Steppe	H		
Channel 2.0	E	Inside Track	D	Pinball	G	Stitch In Time	D		
Charlotte	E	Jala	I	Polka	E	Storyboard	J		
Cirque/Cirque 2.0	F	Jillian	D	Posey	F	Strand	D		
Clean Slate	D	Juxy	G	Posh	F	Stratford	I		
Comeback	H	Kennebunk	H	Power Grid	I	Stride	D		
Connect/	C	Kid	F	Prisma	F	Summit	F		
Connect 2.0	C	Knot	F	Prodigy	I	Sundance	F		
Continuum	F	Kusari/Kusari 2.0	D	Progression	G	w/Stakleen	F		
Converge	I	Lara	C	Promenade	G	Supersillyness	I		
Core/Core 2.0	C	Laredo	C	Radiance	I	Swipe	G		
Corium	F	Lateral	D	Raffia/Raffia 2.0	E	Swivel	H		
Criss Cross/	D	Lava/Lava 2.0	H	Rally	C	Sync	I		
Criss Cross 2.0	D	Level/Level 2.0	G	Raquette	H	Tangram	G		
Dakota	D	Lifecycle	I	Raya	I	Tender	I		
Dart	D	Lift	I	Realm	E	Tendril	E		
Deflection	G	Live Wire	H	Retrograde	D	Tessuto/Tessuto 2.0	D		
Deza	I	Loophole	G	Revolution	G	Thrive	I		
Didi	F	Lorelai - MB	F	Revolve	I	Tidbit	F		
Divvy	I	Luster	F	Rhythm	J	Torus	H		
Donegal	F	Mandala	H	Rialto	D	Touch Base	F		
Drift	F	Mantra	J	Riddle	E	Touchstone	D		
Drizzle	I	Marquetry	H	Ritz	F	Tranquility	H		
Duet	F	Martini/Martini 2.0	F	Rivera	F	Tribeca	D		
Eddy	J	Matrix	F	Rogue2	C	Trio	I		
Effervescence/	I	Maxwell	E	Round Trip	I	Twiggy	F		
Effervescence 2.0	I	Maze	I	Route	E	Twist	H		
Elderberry	H	Median	F	Rubric	H	Vanish	I		
Essential	C	Mesa	I	Salinas	J	Voltage	I		



Effective February 15, 2022

## Spradling Fabric Grading

Grades and availability of fabric are subject to change without notice. Changes could include but are not limited to price increases, discontinued patterns, discontinued colors, etc. See [jsifurniture.com](http://jsifurniture.com) for updated information.

For memo samples order online at [www.spradlingvinyl.com](http://www.spradlingvinyl.com).

<u>Pattern</u>	<u>Grade</u>
Edgeline	C
Genero	C
Maglia	C
Modena	B
Silververtex NEO	C
Whisper NEO	C



Effective October 22, 2021

## Ultrafabrics Fabric Grading

Grades and availability of fabric are subject to change without notice. Changes could include but are not limited to price increases, discontinued patterns, discontinued colors, etc. See [jsifurniture.com](http://jsifurniture.com) for updated information.

For memo samples order online at [www.ultrafabricsllc.com](http://www.ultrafabricsllc.com).

<u>Pattern</u>	<u>Grade</u>
Brisa Distressed	E
Brisa Distressed Outdoor	G
Brisa Fresco	E
Brisa Mokume	F
Brisa Original	E
Ultraleather Cora Outdoor	G
Ultraleather Fusion	G
Ultraleather Fusion Shimmer	G
Ultraleather Geom	G
Ultraleather Linen	F
Ultraleather Original	E
Ultraleather Pearlized	G
Ultraleather Pony	F
Ultraleather Pro	F
Ultraleather Promessa	E
Ultraleather Reef Pro	G
Ultraleather Tottori	E
Ultraleather Volar Bio	H
Ultratech Cove	G
Ultratech Dwell	G
Ultratech Eco Tech	E
Ultratech Helix	G
Ultratech Wired	H

Effective February 15, 2022

## Cortina Leather Grading

For memo samples order online at [jsi@cortinaleathers.com](mailto:jsi@cortinaleathers.com)

Grades and availability of leather are subject to change without notice. Changes could include but are not limited to price increases, discontinued patterns, discontinued colors, etc. See [jsifurniture.com](http://jsifurniture.com) for updated information.

<u>Pattern</u>	<u>Grade</u>
Caprone	L2
Davenport	L1
Old English	L2

If selecting non-carded patterns/colorways pricing will be based on Full Hide usage.  
Contact Customer Service for price quote.

## Specification Tools

JSI products are manufactured to order and provide a multitude of options to address your individual customer needs. As you process your order do not forget to include all the necessary information to allow the order entry process to be completed. Please see the order checklist at the beginning of every series.

JSI Customer Service edits every order for complete information. If details are not included with the purchase order, Customer Service will contact you to answer these questions. If information is not completed in a timely manner it will delay the entry process and could effect your product delivery date. To avoid delay in order entry and potential delay in delivery of your order, please double check the line items to ensure all selections have been completed.

To ensure completion of details on your purchase order, electronic catalogs and specification tools have been developed to aid in the process. These electronic tools include:

**20-20 GIZA Studio and 20-20 CAP Studio** software offers state-of-the-art design, specification, photo-realistic rendering and three-dimensional visualization capabilities for configurable products in the commercial interior design markets. 20-20 GIZA Studio and 20-20 CAP Studio are available for all JSI Casegood and Seating products, in 2D and 3D graphics and the Specifier Catalog. Updates are made monthly reflecting any changes that occurred. To be sure the most up to date information is provided on orders, users of this software program are responsible to update their catalogs.

**CET Designer, by Configura** is an all-in-one software solution for space planning and configuration of products. The intuitive workflow guides you through entire process from idea to reality - supporting every step of the sales process

**ProjectMatrix, Inc.** offers a full software solution for the contract furniture industry. Their software can help you create space plans to specifications for ease of specifying our JSI Casegood and Seating product lines. Updates are made monthly reflecting any changes that occurred. To be sure the most up to date information is provided on orders, users of this software program are responsible to update their catalogs.

**GSAdvantage** is a Federal Government electronic catalog site offered to assist GSA customers in specifying and pricing JSI product. Listed at this site are all contract items and prices under GSA Contract # GS-28F-0030U.

Our JSI website [jsifurniture.com](http://jsifurniture.com) provides many tools to assist in the design and order selection. Included in the site are downloadable images, typicals, product symbols, brochures, contact information, price lists, sales representative locations, warranty and environmental information.

# GSA Terms and Conditions



## Contract Holder

Contract # GS-28F-0030U

**In addition to the standard terms and conditions, the following terms and conditions apply to GSA contract.**

### Contract Number

GS-28F-0030U

### Contract Period

June 24, 2013 - June 24, 2023

### Statement of Intended Use

The furniture covered by special item number 33721 Office Furniture shall comply with the requirements defined in purchase description 3QSAB 09-608. All furniture offered under this SIN shall be GSA Chassis Grade 1, 2, 3 or NA, GSA Drawer Grade 1, 2, 3, 4 or NA, Design A B or C, as defined in 3QSAB 09-608.

### Description of Special Item Number SIN #33721

#### Cooperative Purchasing

No

#### Set Aside

No

#### FSC/PSC Code

7125

**NAICS** 337211 Wood Office Furniture Manufacturing 1000 employees

Includes all furniture placed in an office, such as chairs, desks, etc. In addition, ancillary services are included, however services performed shall not be the primary purpose of the work ordered.

#### Lowest Price Model

SIN #	Model Number	Net Price
33721	VS-LBRKT-20	\$28.03

### Maximum Order

\$250,000 net

### Geographic Coverage

48 contiguous states and Washington D.C.

### Point of Production

Jasper, Dubois County, Indiana  
Orleans, Orange County, Indiana  
Paoli, Orange County, Indiana

### Discount

Discount 61.6%\* off list.

\*Discount for Walden and Wellington is 61.71% off list.

### Discount Quantity

Walden and Wellington only  
\$300,000 to \$350,000 Net = 0.5%  
\$350,001 to \$400,000 Net = 1%  
\$400,001 to \$450,000 Net = 1.5%

### Prompt Payment Terms

1% 15 - net 30 days from date of invoice.

### Government purchase cards are accepted at or below the micro-purchase threshold

### Government purchase cards are accepted above the micro-purchase threshold

### Foreign Terms

Not applicable.

### Time of Delivery

30-75 days after receipt of order, 90 days maximum.

### Expedited Delivery

Contact Customer Service 800-457-4511

### Overnight and 2-day Delivery

Not applicable.

### Urgent Requirements

Contact Customer Service 800-457-4511

### F.O.B. Points

F.O.B. destination, freight prepaid and allowed to 48 contiguous states and Washington D.C. excludes special delivery requirements.

# GSA Terms and Conditions

## Ordering Address

Jasper Seating Company, Inc. d/b/a JSI  
 Attn: Participating Dealer  
 225 Clay Street  
 Jasper, IN 47546  
 Fax: 812-482-1548  
 Phone: 800-457-4511  
 Email: orders@jaspergroup.us.com

## Order Procedures:

Per contract

## Payment Address

JSI  
 225 Clay Street  
 Jasper, IN 47546

## Warranty Provision

Limited Lifetime

## Export Package Charges

Quoted on project-by-project basis.

## Terms of Government Commercial Credit Card Acceptance

Accepted.

## Rental, Maintenance, and Repair

Not applicable.

## Terms and Conditions of installation

12% of net purchase order for installation services up to \$150,000.00 of net purchase price.

## Terms and conditions of repair parts, etc.

See warranty.

## List of service and distribution points

Contact Customer Service 800-457-4511.

## List of participating dealers

Contact Customer Service 800-457-4511.

## Preventive Maintenance

N/A

## Environmental Attributes

GreenGuard Certified and recycled wood waste and fabric remnants

## Section 508 Compliance.

N/A

## DUNS #

00-636-7767

## CCR and SAMS Registration

Jasper Seating Company, Inc. is registered  
 Cage Code #31881  
 Federal ID #35-0420370

## Product Modifications

We willingly accept customers' modifications to standard products. See product modification information by series at the start of each series under the "Product Modification" sections. If there is a modification you desire that is not listed in this section, please call Customer Service for a modification quote/price

## Acceptance, Modification, Assignment

By placing this order for furniture, material or other products (sometimes collectively referred to as "goods"), customer agrees to these terms and conditions which shall prevail over inconsistent provisions in any other form or document of customer. No change or modification shall be applicable unless set forth in writing and signed by company. Neither this order nor any interest therein shall be assigned by customer except with the prior written consent of company.

## Payment

Customer agrees to pay to company the amount indicated on the invoice, 1% 15 days, net 30 days from date of invoice (U.S. funds only), for goods ordered. Interest will be charged after 30 days from the date of invoice at the rate of one and a half percent (1.5%) per month. International sales will require additional payment arrangements. No goods shall be sold on consignment or conditional sales basis. Payment for the goods delivered hereunder shall constitute acceptance thereof.

## Attorneys' Fees

Customer shall be responsible for all expenses and cost in connection with the enforcement by company of these terms and conditions and the cost of collection (including the fees of any collection agencies to whom the customer's account may be referred), plus reasonable attorneys' fees (which attorneys' fees shall not be less than 25% of the amount due, unless a lower amount is specified by applicable law).

## Remedies

The remedies herein reserved shall be cumulative, and additional to any other or further remedies provided in law or equity. No waiver of a breach of any provision of these terms and conditions shall constitute waiver of any other breach or of such provision.

## Insolvency

Company may forthwith cancel this order in the event of the happening of any of the following or any other comparable event: insolvency of the customer, the filing of a voluntary petition in bankruptcy, the filing of any involuntary petition to have customer declared bankrupt provided it is not vacated within thirty (30) days from the date of filing, the appointment of a receiver or trustee for customer provided such appointment is not vacated within thirty (30) days from the date of such appointment, or the execution by customer of an assignment for the benefit of creditors.

## GSA Terms and Conditions

### Limitation of Liability

The Company shall not under any circumstances be liable to the customer, owner of the goods or any third party for special, indirect, incidental, or consequential damages, including, without limitation, loss of profits or revenues, loss or damage to other property or equipment, cost of capital or of purchased or replacement goods, or expense, delay, or inconvenience cause by or arising from the purchase, sale, use, repair or inability to use the goods or by any performance or non-performance under, or breach of, these terms and conditions. The Company's sole liability for any defective goods shall be its repair or its replacement pursuant to the express warranties set forth above, or if amended, as applicable at the time of manufacture or repair of the goods. Some states do not allow the exclusion or limitation of incidental or consequential damages, so the above limitations or exclusion may not apply to all customers. Any action resulting from any breach on the part of company as to the goods or services delivered here under must be commenced within one year after the cause of action has occurred.

### Returns and Allowances

Reasonable touch-up and deluxing is the dealer's responsibility. The Company will not make allowances for trip or delivery charges, but will only make allowance for actual work performed to correct manufacturing defects. Allowances may be authorized only by a company officer. It is the responsibility of the field sales representative to inspect any defective merchandise and make suggestions and recommendations as to the proper disposition. Field personnel cannot obligate or bind the company by definite agreement, without final authorization by a company officer. Company will not accept automatic charge backs which do not have prior authorization. All defects must be called to the company's attention upon arrival at the customer's "ship to" destination. To initiate any type of claim or request for parts, it is imperative to have the model number or fabric number, which may be located on the tag attached to the frame of the unit. Authorization for return to the company via a return goods authorization. Company will not issue credit allowances for any repairs without company's prior consent. Under no circumstances shall the company accept COD (cash on delivery) returns, and any such shipment will be refused.

### Security Agreement

The Company may require and customer shall grant a security interest in goods sold pursuant to any credit the company may extend to the customer.

### Governing Law

All disputes between the parties, whether or not arising out of these terms and conditions, will be governed by the laws of the state of Indiana. Customer agrees to submit to the jurisdiction of and agrees all lawsuits relating to any disputes between the customer and the company will be brought only in a state court located in Dubois County, Indiana or the United States District Court for the Southern District of Indiana. The customer hereby waives the right to a trial by jury in any action, proceeding, claim, or counterclaim whether in contract or tort, at law or in equity, arising out of or relating in any way to these terms and conditions and all other disputes between the parties.

### Mitigation

If the company repossesses the goods prior to payment by the customer of all amounts due hereunder, the company may sell the goods, as is, where is, free and clear of all rights of the customer at either public or private sales, and apply the net proceeds (after deducting expenses of repossession and sale) to the obligation of customer hereunder. The customer may dispose of the goods in any commercially reasonable place and manner and the customer waives any notice of time, place and manner of sale.

### Integration

This order for goods, including these terms and conditions, along with any credit application, invoice, statement, dealer contract, acknowledgment, bill of lading (and any exhibits, addenda or amendments thereto) of which this order may be a part, constitutes the sole and complete agreement between the company and the customer with respect to the purchase of the goods.

### Dimensions/Specifications/Finishes

All dimensions are approximate and may vary due to the upholstery technique of each craftsman. If exact dimensions are required, it is necessary for the customer to state such specifications with the order. Detailed specifications sheets are available for each series of goods, and customer should consult the company's customer service department for these specification sheets. Company reserves the right to make changes in dimensions, style, or specifications if company believes these changes will improve the goods' quality or appearance. Company reserves the right to substitute hardwoods due to availability at production. Due to the natural characteristics of wood, environmental effects, and material upgrades, the company cannot guarantee exact finish matches on existing goods previously ordered from company. If an exact match to customer's existing goods is required, it must be specified so that the proper procedures can be followed to ensure an acceptable finish. Company will accept no liability for the finish if this procedure isn't followed. Company reserves the right to make changes in a finish formula if company believes the change will improve the quality or appearance of company's goods.

### Company's Performance of Its Obligation

The production and delivery of the goods to the extent delayed or hindered or prevented from the performance by reason of natural disasters, acts of god, strikes, lockouts, labor troubles, inability to procure materials, casualties, failure of power, restrictive governmental laws or regulations, riots, insurrections, acts of terrorism, war or other reason of a like nature not the fault of the company shall excuse for the period of the delay the company's performance and the period for the performance shall be extended for a period equivalent to the period of such delay.





Desks . . . . . 68  
 Consoles . . . . . 74  
 Meeting Tables. . . . . 76  
 Bridges . . . . . 76  
 Returns . . . . . 77  
 Credenzas . . . . . 80  
 Lateral Files . . . . . 85  
 Modular Credenzas . . . . . 86  
 Overhead Cabinets. . . . . 106  
 Wall Mount Storage . . . . . 120  
 Wall Panels . . . . . 134  
 Wall Mount Tackboards. . . . . 135  
 Vertical Storage Units . . . . . 139  
 Workwalls . . . . . 157  
 Accessories . . . . . 173

# Apogee™ - Overview

## Desks



Double Pedestal Desk with Full Modesty Panel  
Page 68



Veneer Table Desk with Open Frame Leg  
Page 68



Glass Table Desk with Open Frame Leg  
Page 68



Single Pedestal Desk with Full Modesty Panel  
Page 69

## Peninsula Desks



End Panel Desk  
Page 70



Access End Panel Desk  
Page 70

## Run-Off Desks



Rectangular Pedestal Run-Off  
Page 71



Table Desk with Open Frame Leg  
Page 72



Rectangular Desk with Post  
Page 72



Arc Run-Off Desk  
Page 73



Trapezoid Run-Off Desk  
Page 73

## Console Desks

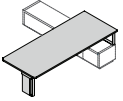

Console Desk with Leg Support  
Page 74

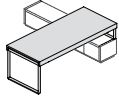

Console Desk with Open Frame Leg  
Page 74

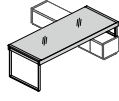

Console Glass Desk with Open Frame Leg  
Page 74

## One-High Console Return



Low Console Bridge  
Page 75



Low Console Connector with Hinge Door  
Page 75

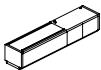

Freestanding Low Console Return  
Page 75

## Meeting Table



Meeting Table  
Page 76

## Bridges

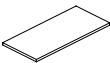

Bridge Top  
Page 76

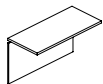

Bridge with Modesty Panel  
Page 76

# Apogee™ - Overview

## Returns



Return  
Page 77



Lateral File Return  
Page 78

## Return Shells



Return Shell  
Page 79



Return Shell with Wall Access Panel  
Page 79

## Credenzas

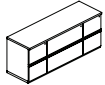

Storage credenza  
Page 80

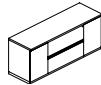

Storage credenza  
Page 80

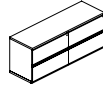

Lateral File Credenza  
Page 81



Open Corner Credenza  
Page 82



Open Corner Lateral File Credenza  
Page 83

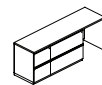

Open Corner Credenza  
Page 84

## Freestanding Lateral Files



Two-High Lateral File  
Page 85



One-High Lateral File  
Page 85

## Two-High Modular Credenzas

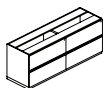

Two-High Lateral File  
Page 86



Two-High Lateral File  
Page 86



Utility/Box/File Pedestal  
Page 87



File/File Pedestal  
Page 87

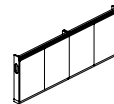

Kneespace Access Panel, Full Height  
Page 88

## End Support



End Support  
Page 88



End Panel Transition to Access Panel  
Page 88

# Apogee™ - Overview

## One-High Modular Credenzas

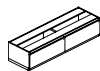

One-High Lateral File  
Page 89



One-High Lateral File  
Page 89



One-High Pedestal  
Page 90

## One-High Kneespace Units

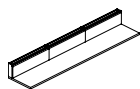

Kneespace Access Panel, Partial Height with Workwall Top  
Page 91

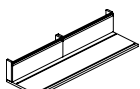

Workwall Top with Shuttle Tracks and Access Panels  
Page 92

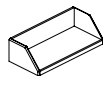

Storage Shuttle  
Page 92

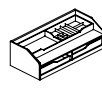

Piling Shuttle  
Page 92

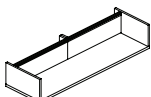

Kneespace Access Panel, with 22" d Extensions, Partial Height with Workwall Top  
Page 93

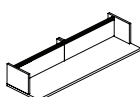

Kneespace Access Panel, with 15" d Extensions, Partial Height with Workwall Top  
Page 94

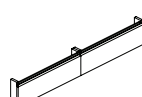

Kneespace Access Panel, Partial Height  
Page 97

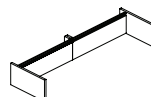

Kneespace Access Panel with Extensions, Partial Height  
Page 98

## Workwall Top

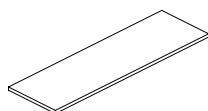

Workwall Top  
Pages 95-96

## Modular Credenzas



Two-High Run-Off Lateral File Credenza  
Page 99



Two-High Run-Off Lateral File Credenza  
Page 100

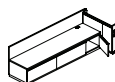

One-High Run-Off Credenza with Access Door  
Pages 101-102



One-High Run-Off Credenza  
Pages 103-104



Utility/File Mobile Pedestal  
Page 105



Utility/File Mobile Pedestal with Cushion Top  
Page 105

# Apogee™ - Overview

## Double Height Storage Overhead Cabinets



Double Height Storage Overhead Cabinet with Doors  
Pages 106-107



Double Height Storage Overhead Cabinet with Doors and Open Center Shelf  
Pages 108-109



Double Height Storage Overhead Cabinet with Doors and Open Storage  
Pages 110-111

## Storage Overhead Cabinets

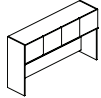

Storage Overhead Cabinet with Doors  
Pages 112-113



Overhead Cabinet with Doors and Open Center Shelf  
Pages 114-115



Storage Overhead Cabinet with Flipper Doors  
Pages 116-119

## Double Height Wall Mount Overhead Cabinet



Double Height Wall Mount Overhead Cabinet with Open Storage  
Page 120



Double Height Wall Mount Overhead Cabinet with Doors  
Pages 121-123



Double Height Wall Mount Overhead Cabinet with Doors and Open Storage  
Pages 124-125

## Wall Mount Overhead Cabinet



Wall Mount Overhead Cabinet with Open Storage  
Page 126



Wall Mount Overhead Cabinet with Doors  
Pages 127-129



Wall Mount Overhead Cabinet with Flipper Doors  
Pages 130-131

## Open End Shelves



Open End Shelves  
Page 132



Open End Shelf  
Page 132

## Valance



Valance  
Page 133

## Overhead Support End Panel



Overhead Support Panel  
Page 133

# Apogee™ - Overview

## Wall Panels



Wall Panel  
Page 134



Wall Panel with Shelf  
Page 134

## Wall Mount Tackboards

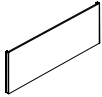

Wall Mount Tackboards  
Pages 135-136

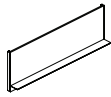

Wall Mount Tackboards with Shelf  
Pages 137-138

## Worksurface Storage Towers / Asymmetric Shelves

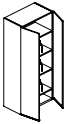

Storage Tower  
Pages 139-143

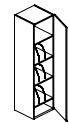

Storage Tower  
Pages 140-144

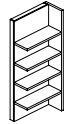

Asymmetric Shelves  
Pages 145-149



Asymmetric Shelves  
Pages 146-149

## Storage Units

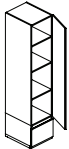

Storage Unit with Drawer  
Pages 150 and 154

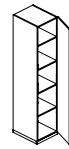

Storage Unit  
Pages 152 and 154



Wardrobe Unit  
Pages 151 and 154

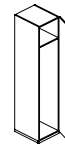

Wardrobe Unit  
Pages 152-153 and 155-156

# Apogee™ - Overview

## Workwalls with Shelves

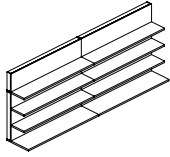

Dual Open Workwall with 3 Shelves  
Page 159

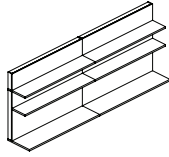

Dual Open Workwall with 2 Shelves  
Page 158

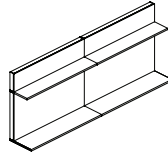

Dual Open Workwall with Shelf  
Page 157

## Workwalls

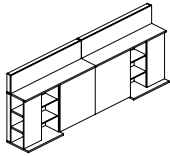

Dual Wardrobe Workwall with Sliding Doors  
Page 160

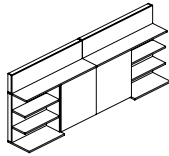

Dual Shelf Workwall with Sliding Doors  
Page 165

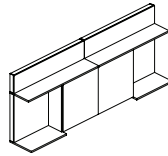

Dual Display Workwall with Sliding Doors  
Page 168

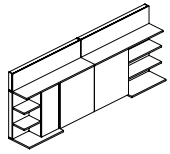

Wardrobe Workwall and Shelf Workwall with Sliding Doors  
Pages 161-162

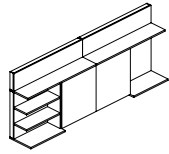

Shelf Workwall and Display Workwall with Sliding Doors  
Pages 166-167

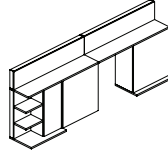

Wardrobe Workwall and Display Workwall with Sliding Doors  
Pages 163-164

## Workcenters

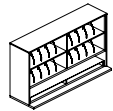

Workcenter  
Page 169

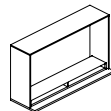

Media Workcenter  
Page 169

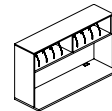

Workcenter  
Page 170

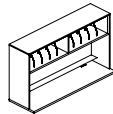

Workcenter with Mini Shelf  
Page 171

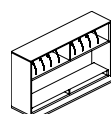

Workcenter  
Page 172

## Accessories

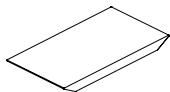

Leather Desk Pad  
Page 173

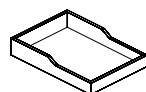

Paper Trays  
Page 173



Magnets  
Page 173

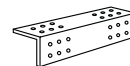

Angle Bracket  
Page 173

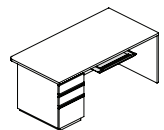

Angled Front Center Drawer  
Page 173





# Apogee™ Product Information

## Product Modification

### Special Finishes

Special finishes can be requested by following the instructions in the general introduction section, page 5. There is a one time charge of \$332 list per order.

### Premium Veneer

Upon request standard veneer can be changed to a special veneer contact Customer Service for availability and pricing.

### Pedestal Configuration Change

Utility/Box/File configuration is standard on all desks and File/File configuration is standard on all return units.

Apogee drawer configuration on pedestals 29 1/2" high can be reconfigured to a Utility/Box/File or File/File configuration, but must be specified at the time of order with an additional \$178 list per pedestal.

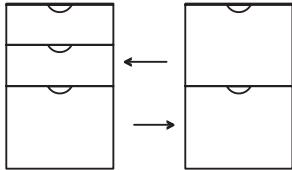

### Grommets

Please see page 50 for location and placement availability. Add \$99 list for each grommet.

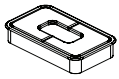

### Modesty Panel

End Panel Desks are standard with a partial modesty. A full modesty is available as an option and should be ordered with the desk. See price list pages for availability and pricing.

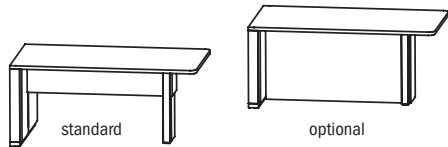

Run-Off Desks are standard without a modesty. Optional partial or full modesty may be specified on the desk. See price list pages for availability and pricing.

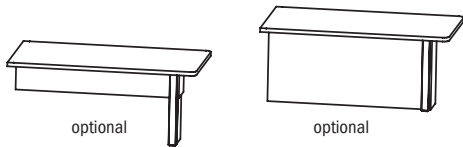

### Mini Shelf

Aluminum mini shelf is optional on the insert panel overhead cabinets. This option needs to be specified with the overhead cabinet.

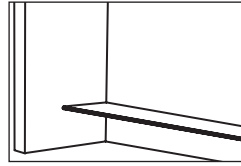

### Special Sizes and Construction

Apogee has various modular units to create many popular applications. Please contact Customer Service if you need help in creating a particular layout.

## Apogee™ Product Information

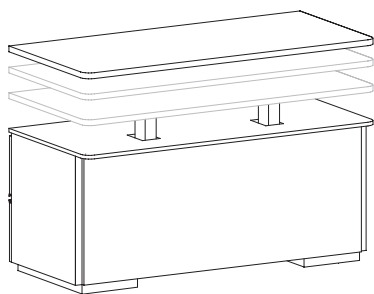

### Ergo Adjustable Work Height Mechanism

Our proprietary adjustable work height mechanism can be specified on many of the models in Apogee.

ERGO mechanism allows height adjustability to be added to the worksurface. Our solution uses a standardized design that minimizes the modifications required to standard desk, bridge or credenza models. The mechanism and control box are neatly concealed to maintain the appearance of the original elegance of the product. A push button control activates the electric powered lifting columns for adjustability from sitting height to a standing height. A  $\frac{3}{4}$ " thick finished sub top is added to the top of the desk chassis for a clean appearance when the surface is in the raised position. In the lowered position, please note that Ergo adds  $\frac{3}{4}$ " to the standard height of the desk and the installation will decrease kneespace depth by 8".

Automatic Collision Control is built in to each mechanism as a standard feature. When the system senses an obstacle obstructing the movement, the mechanism will reverse direction and retreat by 1".

When Ergo is added to a worksurface in an "L" or "U" group, all units in the configuration need to have a sub top added. These units are considered to be ERGO ADJACENT units. ERGO ADJACENT units must have a fixed height worksurface that matches the lowest position of the Ergo mechanism and the top. This is accomplished by adding a  $\frac{3}{4}$ " sub top between the chassis and the worksurface. This feature can also be specified for cabinets which may sit next to a unit with the Ergo mechanism.

Height adjustment starts at 30  $\frac{1}{4}$ ", to a standing height of 49  $\frac{3}{4}$ ", a range of 19  $\frac{1}{2}$ ".

**Note:** The kneespace depth is decreased when the ERGO mechanism is specified. Contact Customer Service for dimension information.

The Ergo mechanism and controls are warranted for a period of (1) year. The rest of the casegood unit(s) are warranted under the normal fifteen (15) year warranty.

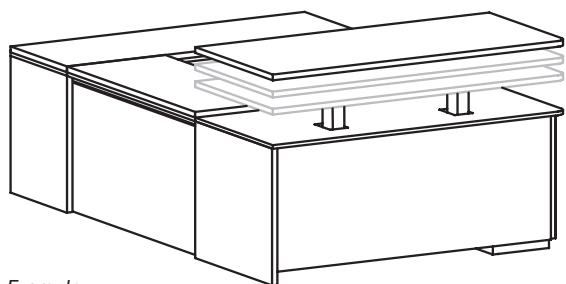

Example

AP1-SPR-1-3066L (with ERGO option) add \$4,223 to list  
 AP3-BMR-1-2250 (with ERGO ADJACENT option) add \$635 to list  
 AP2-OCP-1-2266R (with ERGO ADJACENT option) add \$635 to list

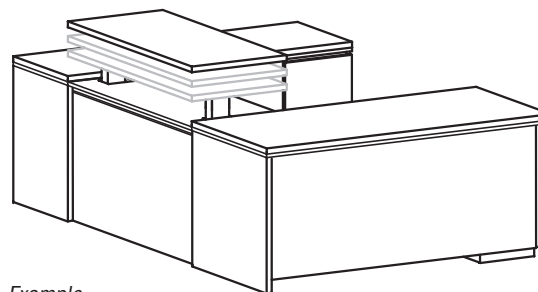

Example

AP1-SPR-1-3066L (with ERGO ADJACENT option) add \$635 to list  
 AP3-BMR-1-2250 (with ERGO option) add \$4,223 to list  
 AP2-OCP-1-2266R (with ERGO ADJACENT option) add \$635 to list

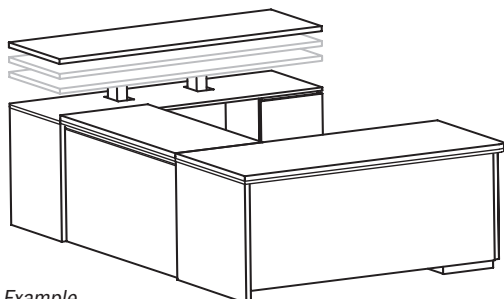

Example

AP1-SPR-1-3066L (with ERGO ADJACENT option) add \$635 to list  
 AP3-BMR-1-2250 (with ERGO ADJACENT option) add \$635 to list  
 AP2-OCP-1-2266R (with ERGO option) add \$4,223 to list

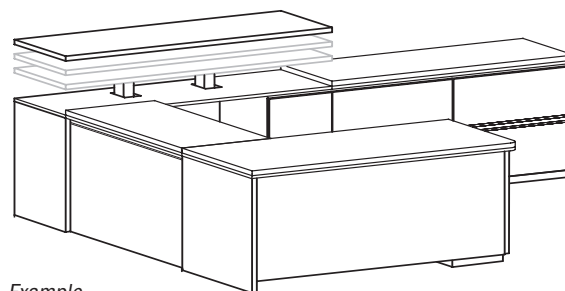

Example

AP1-SPR-1-3066L (with ERGO ADJACENT option) add \$635 to list  
 AP3-BMR-1-2250 (with ERGO ADJACENT option) add \$635 to list  
 AP2-OCP-1-2266R (with ERGO option) add \$4,223 to list  
 AP2-DST-1-2260 (with ERGO ADJACENT option) add \$635 to list

# Apogee™ Product Information

## Availability of Apogee Units with the Mechanism

The following models are available with the ERGO Adjustable Work Height Mechanism.

**Freestanding Units** - Units below do not require adjacent products; select ERGO option and add \$4,223 to the list price.

### Double Pedestal Desk

AP1-DPF-1-3066

AP1-DPF-1-3672

**Adjacent Connecting Units** - Select ERGO option for the model you wish to have height adjustment and add \$4,223 to the list price. For units, from this list, that are connecting to the ERGO model, you must select ERGO ADJACENT on each of these connecting models and add \$635 list to each model. \*If the connecting model is 24"x 48" or less, add \$542 list.

### Single Pedestal Desk

AP1-SPR-1-3066L

AP1-SPR-1-3066R

AP1-SPR-1-3666L

AP1-SPR-1-3666R

AP1-SPR-1-3672L

AP1-SPR-1-3672R

AP1-SPR-1-3678L

AP1-SPR-1-3678R

### Bridges

AP3-BMR-1-2244\*

AP3-BMR-1-2250\*

AP3-BMR-1-2256\*

**Note:** On bridges modesty panel will no longer be removable.

### Open Corner Credenzas

AP2-OCP-1-2260L\*

AP2-OCP-1-2260R\*

AP2-OCP-1-2266L\*

AP2-OCP-1-2266R\*

AP2-OCP-1-2272L\*

AP2-OCP-1-2272R\*

AP2-OCP-1L-2260L\*

AP2-OCP-1R-2260R\*

AP2-OCP-1L-2266L\*

AP2-OCP-1R-2266R\*

AP2-OCP-1L-2272L\*

AP2-OCP-1R-2272R\*

### Returns

AP3-RTP-1-2248L\*

AP3-RTP-1-2248R\*

AP3-RTP-1-2254L\*

AP3-RTP-1-2254R\*

AP3-RTP-1-2260L\*

AP3-RTP-1-2260R\*

AP3-RTP-1L-2248L\*

AP3-RTP-1R-2248R\*

AP3-RTP-1L-2254L\*

AP3-RTP-1R-2254R\*

AP3-RTP-1L-2260L\*

AP3-RTP-1R-2260R\*

# Apogee™ Product Information

## Quarter Cut Veneer Grain Direction

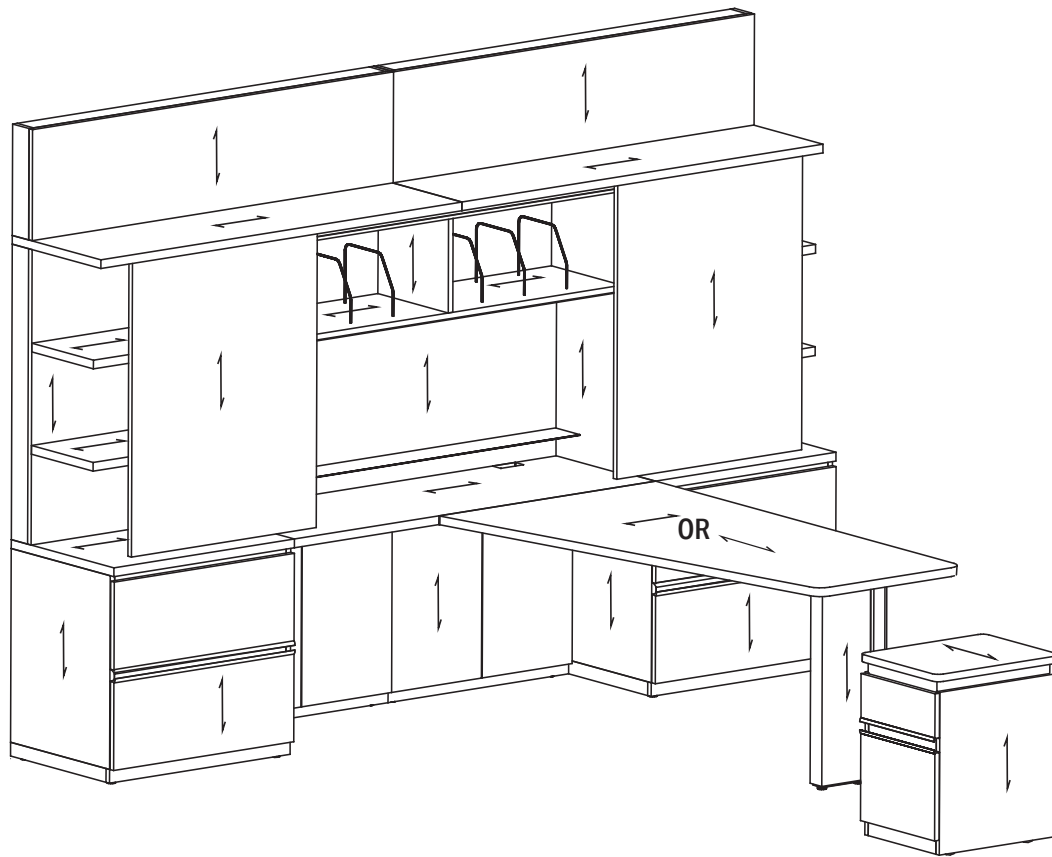

APOGEE™

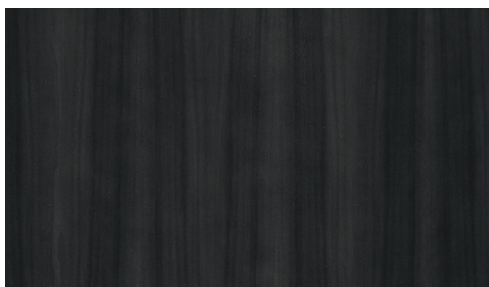

### Quarter Cut Veneer

Standard direction for quarter cut veneer on Apogee™ is vertical.

The log is cut into quarters prior to slicing. This method bisects annual growth rings and results in a straight grain or ribbon-striped appearance.

# Apogee™ Product Information

## Double Cut Veneer Grain Direction

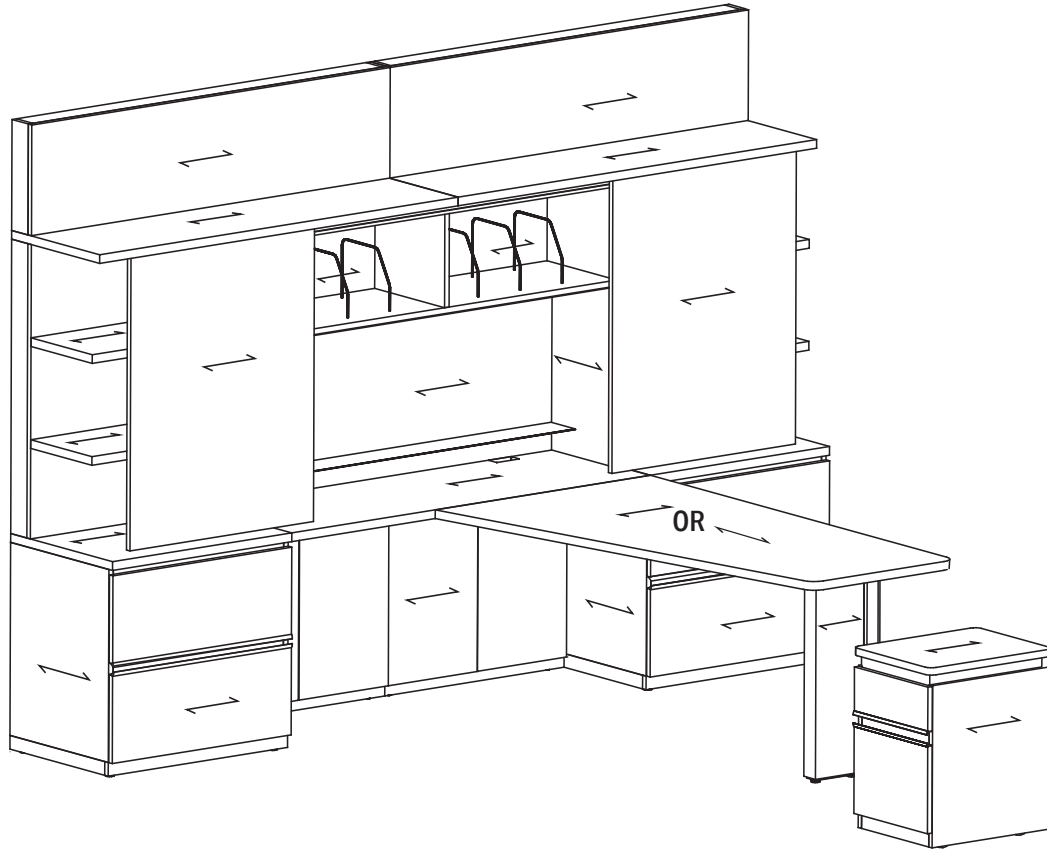

APOGEE™



### Double Cut Veneer

Standard direction for double cut veneer on Apogee™ is horizontal.

This veneer uses multiple layers of thin wood which is re-assembled, then re-cut in a factory, under controlled specifications. The veneer used in our program is a uniform straight grain pattern and is pre-stained for color consistency.

# Apogee™ Product Information

## Layouts

Two typical casegood layouts that can easily be created with Apogee™

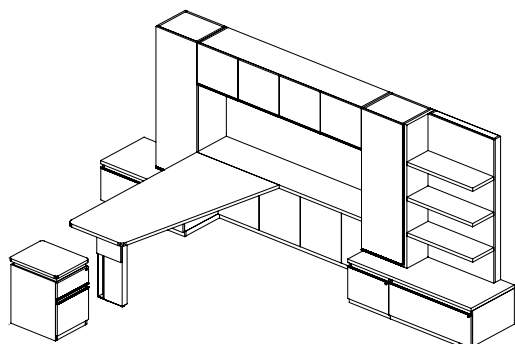

Casegood layout made up of modular components, Trapezoid Run-Off Desk, One-High Lateral with Full Height Wall Access, Towers, Wall Mount Overhead, and Asymmetric Shelf

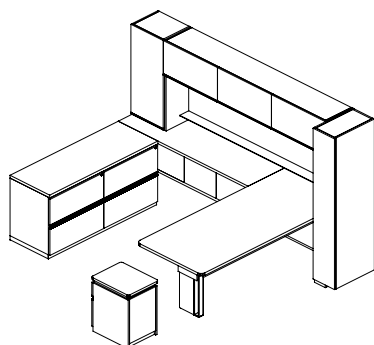

U-Group layout made up of built up, free standing casegood components, End Panel Desk, Full Height Access, Panel-Support Overhead, Tower, Wardrobe and Two-High Lateral

## Casegoods feature modular wall components including: storage overhead cabinets, asymmetric shelves and back panels

Two heights & two depths of wall components  
 Wall-mount or Panel-supported Overheads  
 Casegood worksurface tops specified separately

### 1 Overhead, Wall Mount

### 2 Wall Panel

Available in veneer, magnetic glass markerboard, paint or tackable fabric. Thin profile anodized aluminum frame is featured on the panels with the glass option.

### 3 Wall Panel with Mini Shelf

Available in veneer, magnetic glass markerboard, paint or tackable fabric. Thin profile anodized aluminum frame is featured on the panels with the glass option. 5" Mini shelf is finished in anodized aluminum.

### 4 Run-Off Desk

Has an option for partial or full modesty panels in veneer or paint.

### 5 Tops

Modular items can be attached together with common worksurface tops. Refer to the items, some tops may be included.

### 6 Low Storage: Two-High Lateral File

### 7 Low Storage: One-High Lateral File

### 8 Low Storage: Wall Access Panel (partial height)

Allow for wiring to pass through to building wall.

### 9 Storage Tower

### 10 Asymmetric Shelf

### 11 Accessories: Piling Shuttle (tops with shuttle tracks)

Shuttle slides back and forth on the track.

Apogee™ Product Information

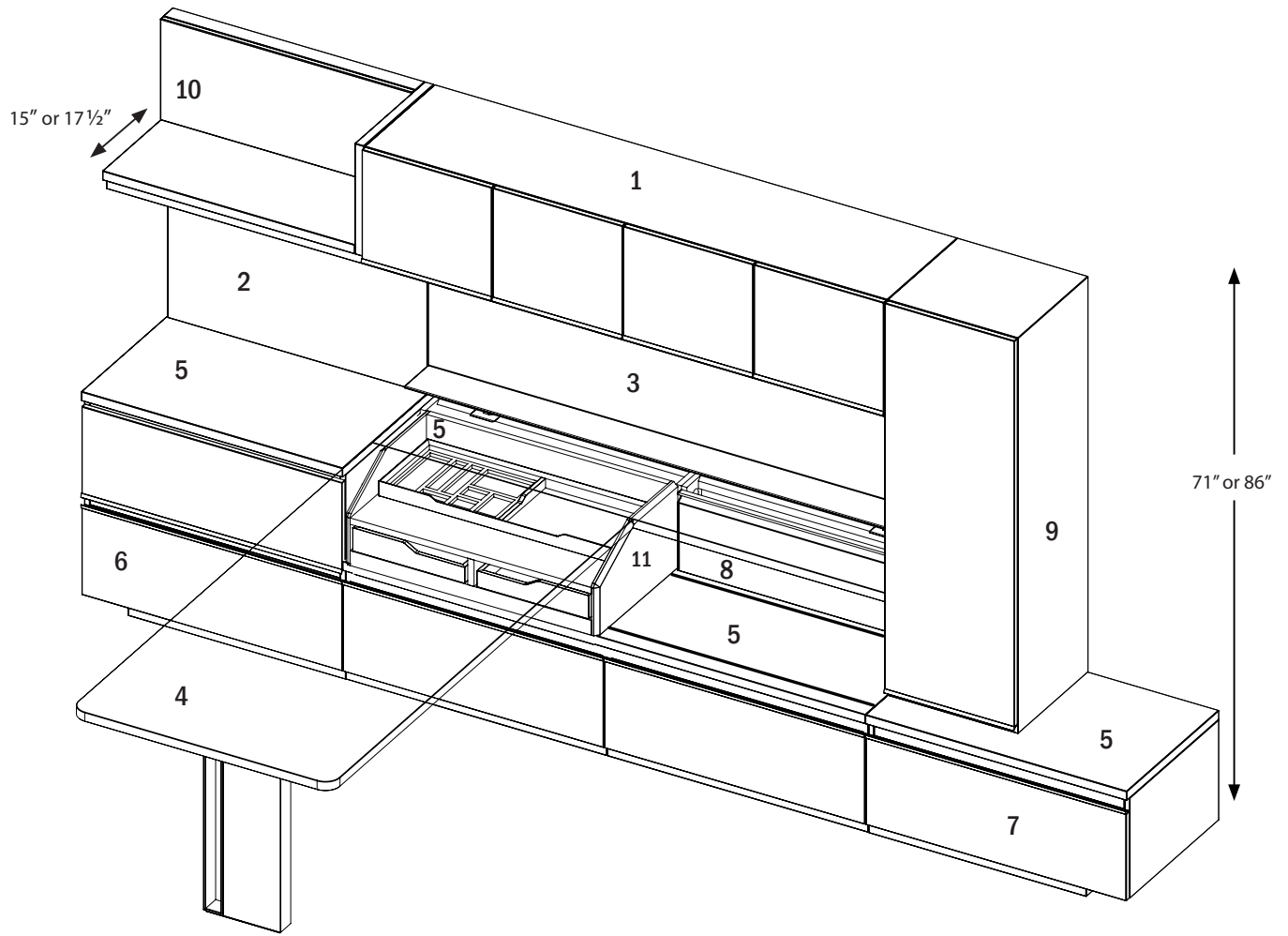

APOGEE™

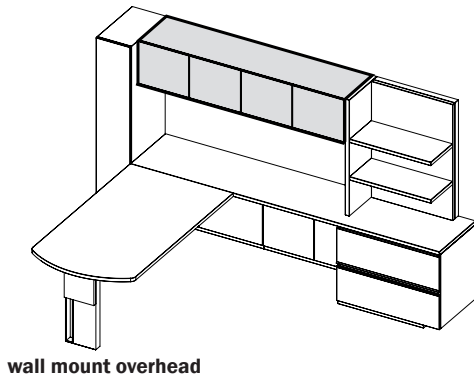

wall mount overhead

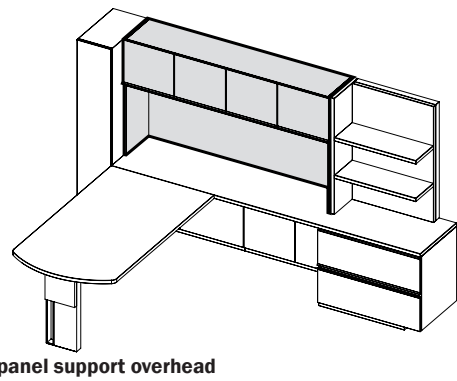

panel support overhead

# Apogee™ Product Information

## LAYOUTS

Two typical workwall layouts that can easily be created with Apogee™

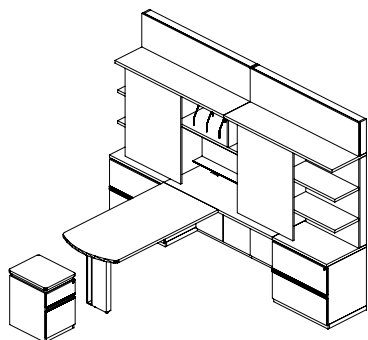

Workwall grouping with Arc End Runoff Desk, Two-High Lateral Files, Full Height Wall Access with two piece Workwall and Workcenter

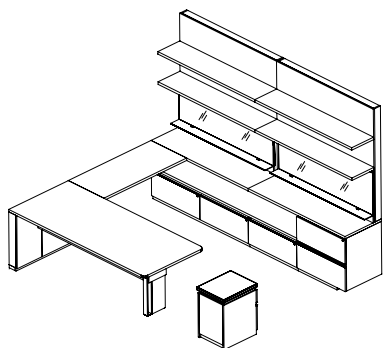

U-Group layout with End Panel Desk, Bridge Top, One-High and Two High Lateral Files, Partial Wall Access Panels, Open Workwall Shelves with Magnetic Back Painted Glass Markerboard

## Workwalls can be specified with Open Shelves or Workwall with Work Centers solutions

One height & one depth of workwall  
 Left and Right End Section specified as a set  
 Tops are included with each section of workwalls components

### 1 Sections of WorkWall

Doors available in veneer finish, paint, or back painted glass with or without magnetic feature. Wall attachment required.

### 2 Workcenter

Five different configurations: combination of shelves with wire dividers, lower cubby, glass markerboards, monitor opening, refer to pages 169-172.

### 3 Open Frame Desk with Return Console Feature

Frame available in two finishes, Bright White or Arctic Silver. Power & Data unit available as an option.

### 4 Tops (included with WorkWall components)

### 5 Partial Wall Access Panel

Tops included with some units.

### 6 Low Storage: One-High Lateral File

### 7 Low Storage: Console Connector with Hinged Door

Use in conjunction with return console, provides pass thru for wiring from the desk to the building wall.

### 8 Return Console

Sliding door opens up to lift out charging and organization trays lined in felt. Section under desk provides access to wire storage and includes a power strip.

### 9 Low Storage: Two-High Lateral File

### 10 Accessories: Leather Desk Pad



# Apogee™ Product Information

## Workwall Components

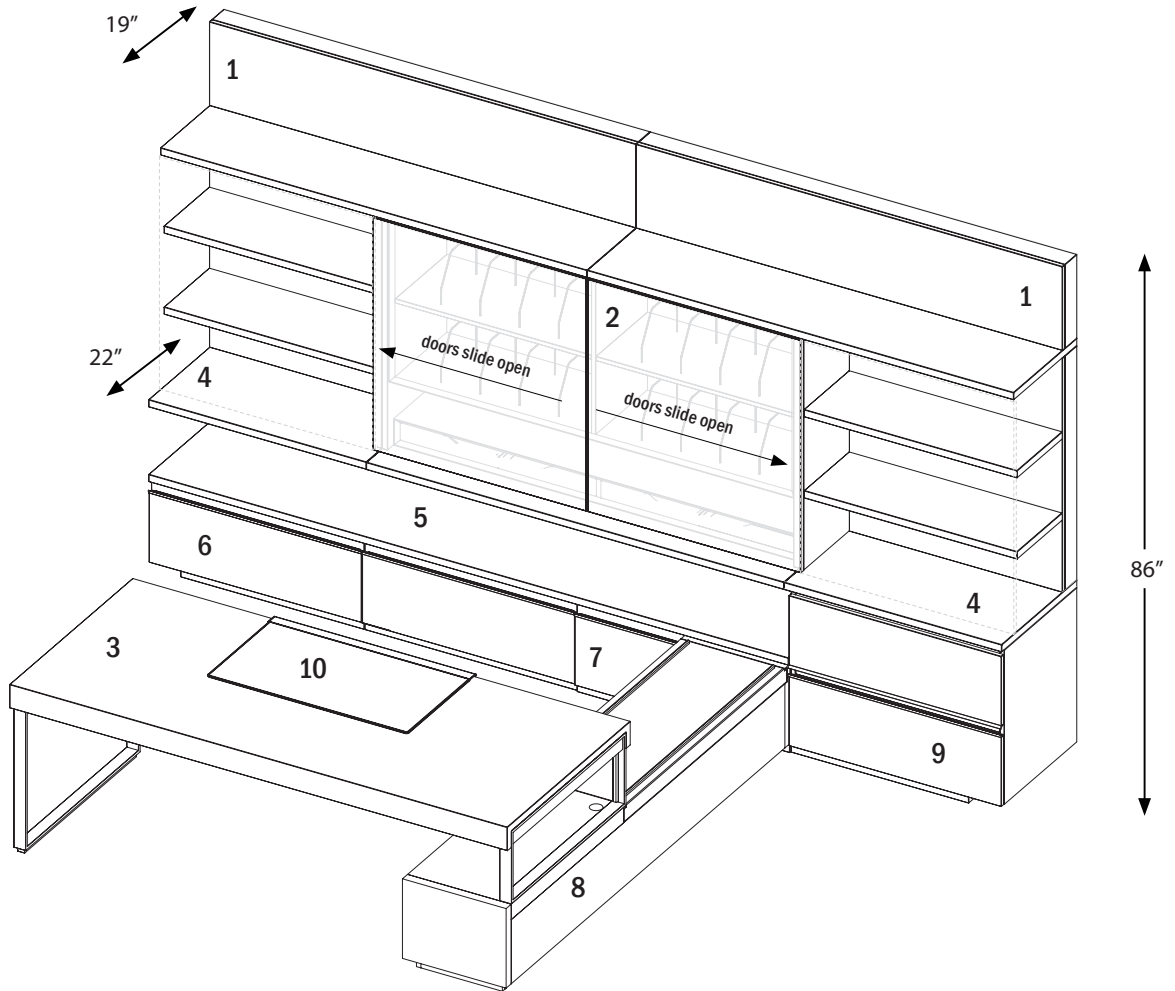

APOGEE™

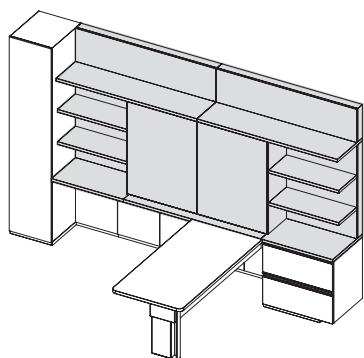

**workcenter workwall**

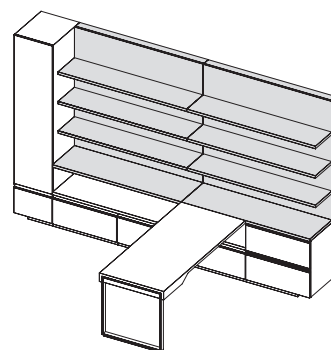

**open shelf workwall**

# Apogee™ Product Information

## Corner Details

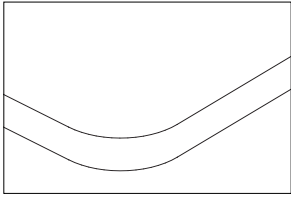

approach view of a standard desk corner

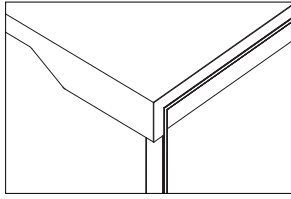

corner of an open frame end desk

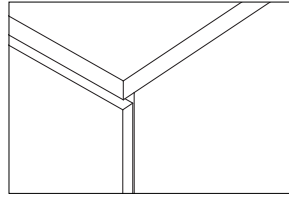

front corner of a credenza top

## Primary Worksurface Top Shapes

(diagrams show run-off tops)

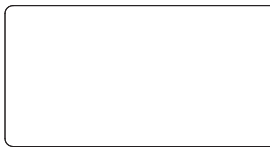

rectangle with radius corners

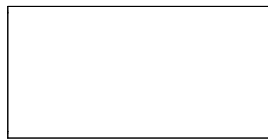

rectangular shape for open frame end



arc end

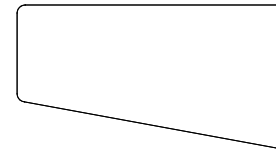

trapezoid

## Grain Direction on End Panel Desk

\*\*\* Grain direction choice is required at the time of ordering.

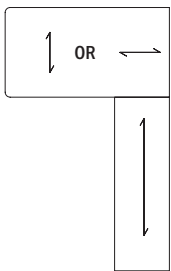

## Grain Direction on Run-Off Worksurface Top

\*\*\* Grain direction choice is required at the time of ordering these three shapes.

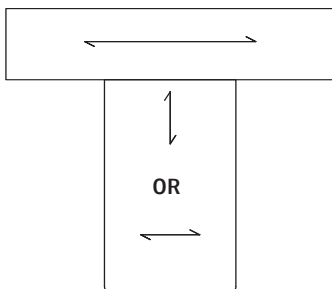

rectangular

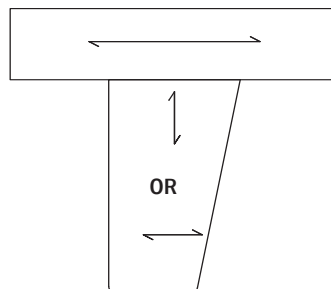

trapezoid

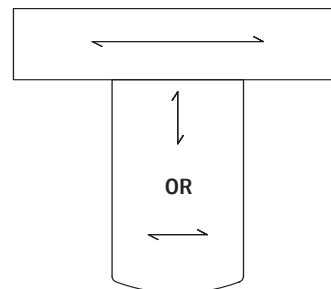

arc

\*\*\*The veneer grain on secondary worksurfaces always runs long grain. How the grain runs on peninsula style tops and how it mates to the secondary worksurface top is a design preference, on Apogee™ the specifier must choose a grain direction.

# Apogee™ Product Information

## Pull Orientation



utility/box/file drawer

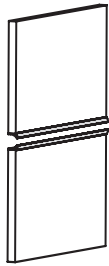

file/file drawer

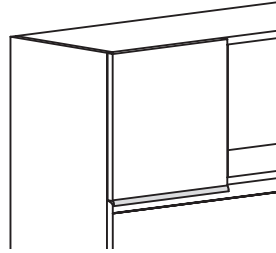

overhead

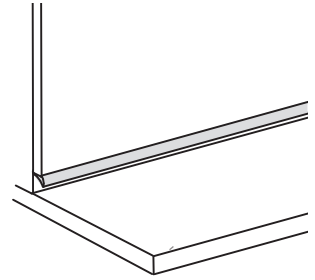

storage tower

Note: Wardrobe doors have a concealed bevel on the side to allow the door to open easily.

## Base Details

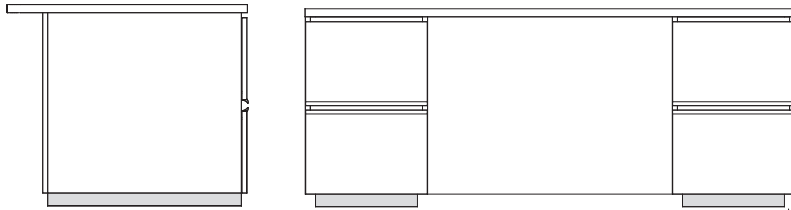

All bases on pedestal desks have 1 1/2" inset on both sides and 3/4" on the front and back base.

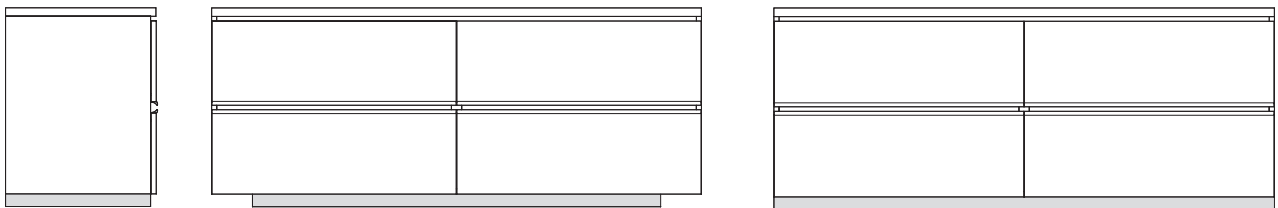

Stand alone laterals and credenzas are available with either a 6" inset base or a flush base; all have a 3/4" inset on the front base.

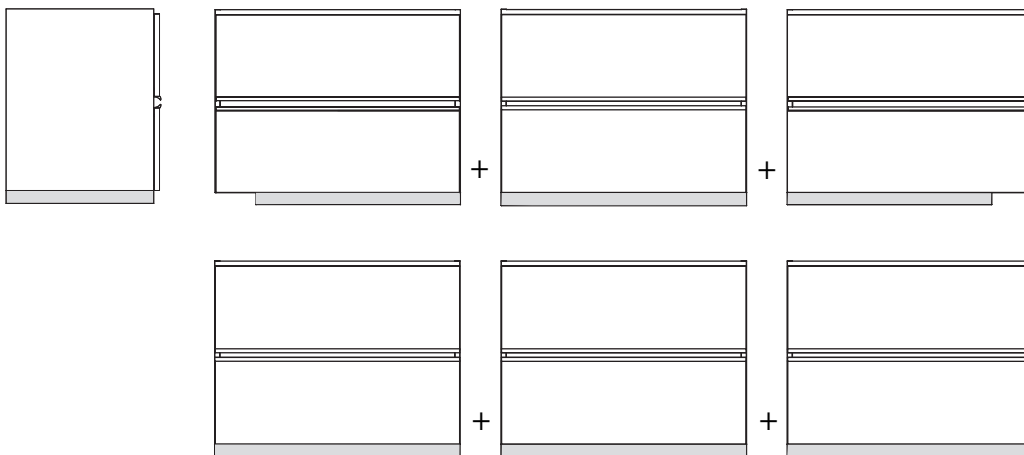

Modular units, storage cabinets, and wardrobes with bases are available with left inset, flush, or right inset.

Inset bases on the sides are 6", all have the front inset 3/4".

\*\*\* Specify the correct models to create the desired aesthetics.

# Apogee™ Product Information

## Standard Worksurface Grommet

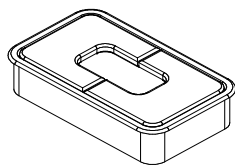

APOGEE™

### Primary Worksurfaces - Run-Off Tops, Panel Desks & Open Frame Desk

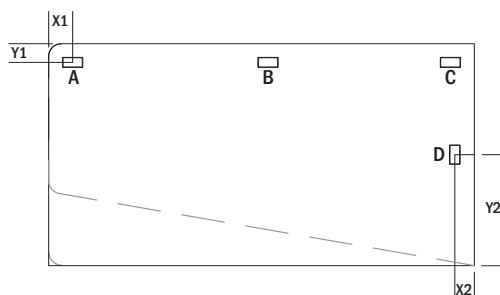

**Diagram: G1** Applies to all rectangular, rectangle with radius corner, and trapezoid tops. (diagram shows run-off tops)

	X1	Y1	X2	Y2
<b>A</b>	3 3/4" from end	3" from edge		
<b>B</b>	center	3" from edge		
<b>C</b>	3 3/4" from end	3" from edge		
<b>D</b>			3" from end	center

\* grommet for location D is not available on desk with open frame legs

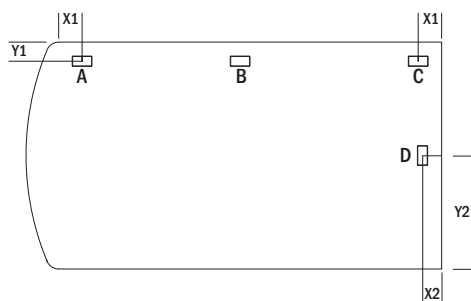

**Diagram: G2** Applies to all arc end tops.

	X1	Y1	X2	Y2
<b>A</b>	3 3/4" start of radius	3" from edge		
<b>B</b>	center	3" from edge		
<b>C</b>	3 3/4" from end	3" from edge		
<b>D</b>			3" from end	center

### Primary Worksurfaces - Pedestal Desks & Pedestal Run-Off Desks

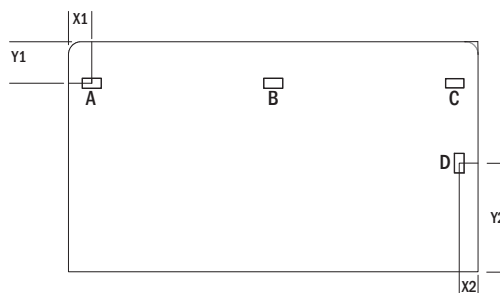

**Diagram: G3** Applies to all worksurface tops with pedestals. Grommets cannot be placed over the top of a pedestal.

	X1	Y1	X2	Y2
<b>A</b>	3 3/4" front end	6 1/2" from edge		
<b>B</b>	center	6 1/2" from edge		
<b>C</b>	3 3/4" from end	6 1/2" from edge		
<b>D*</b>			3" from end	center

\* grommet for location D applies only to Pedestal Run-Off Desks

# Apogee™ Product Information

## Bridges, Pedestal Returns and Shell Returns

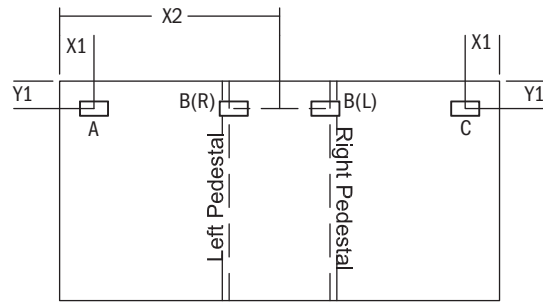
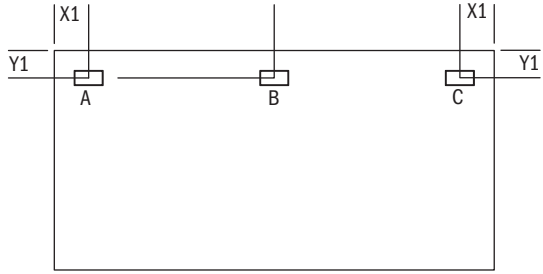
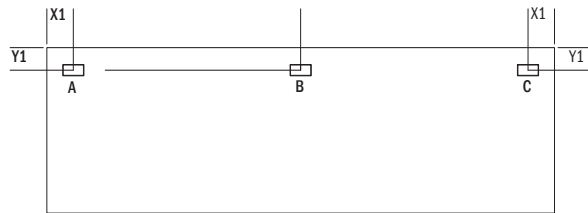

**Diagram: G4** Applies to all bridge or return tops.  
Grommets cannot be placed over the top of a pedestals.

	X1	Y1	X2
<b>A</b>	3 3/4" from end	3" from edge	
<b>B</b>	center	3" from edge	
<b>BL</b>		3" from edge	center plus 5"
<b>BR</b>		3" from edge	center minus 5"
<b>C</b>	3 3/4" from end	3" front edge	

APOGEE™

## Open Corner, Run-Off and Storage Credenza



**Diagram: G5** Applies to all credenza tops.  
Grommets cannot be placed over the top of a pedestals

	X1	Y1
<b>A</b>	3 3/4" from end	3" from edge
<b>B</b>	center	3" from edge
<b>C</b>	3 3/4" from end	3" front edge

## Workwall Tops with Wall Access

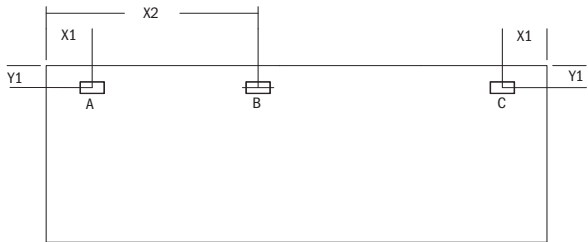

**Diagram: G6** Applies to all tops that span under the workwalls when using wall access panels.

	X1	Y1	X2
<b>A</b>	8" from end	3" from edge	
<b>B</b>		3" from edge	center minus 5"
<b>C</b>	8" from end	3" from edge	

# Apogee™ Product Information

## Access to Wall & Wire Management

### kneespace access panel, partial height

Doors flip down for access to building power and data outlets, use above one-high lateral.

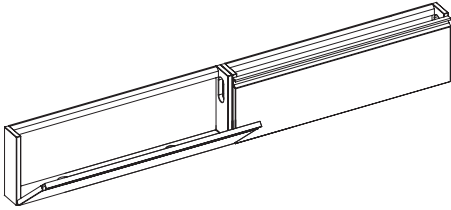

### kneespace access panel, full height

Doors swing open for access to building power and data outlets

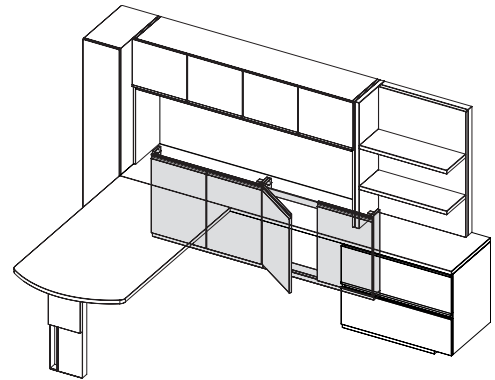
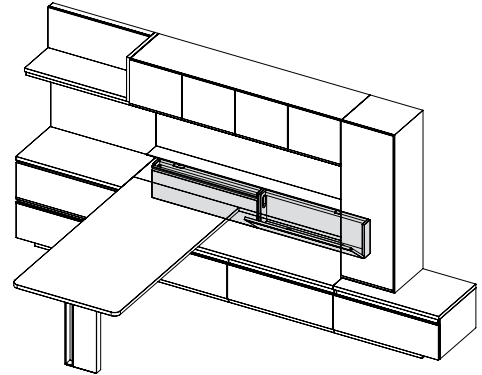
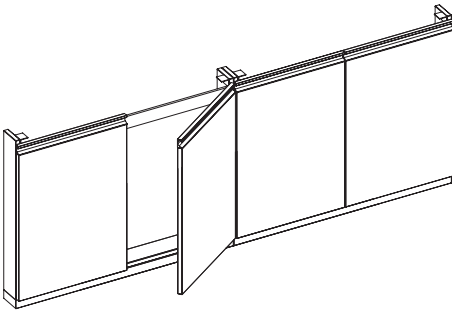

## Power Unit

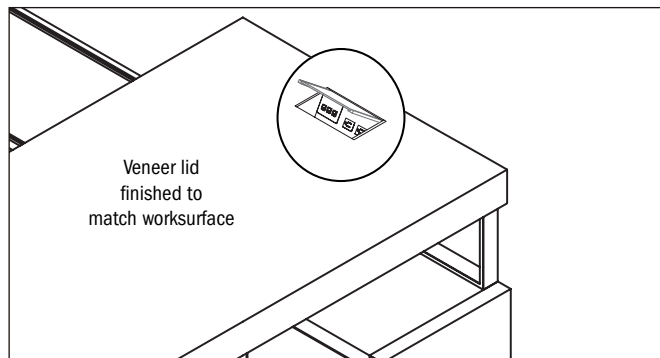

### PU01 - power and data surface access (EC18)

This accessory features two 110 device, one RJ12 jack and two CAT 6 jacks. This unit eliminates the need for a grommet, wires can easily pass thru to the underside of the top.

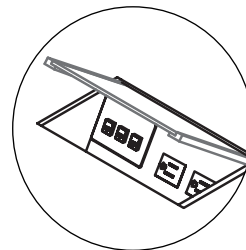
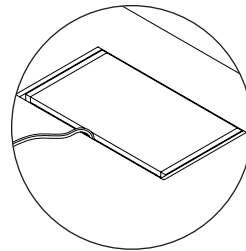

# Apogee™ Product Information

## Access to Wall & Wire Management

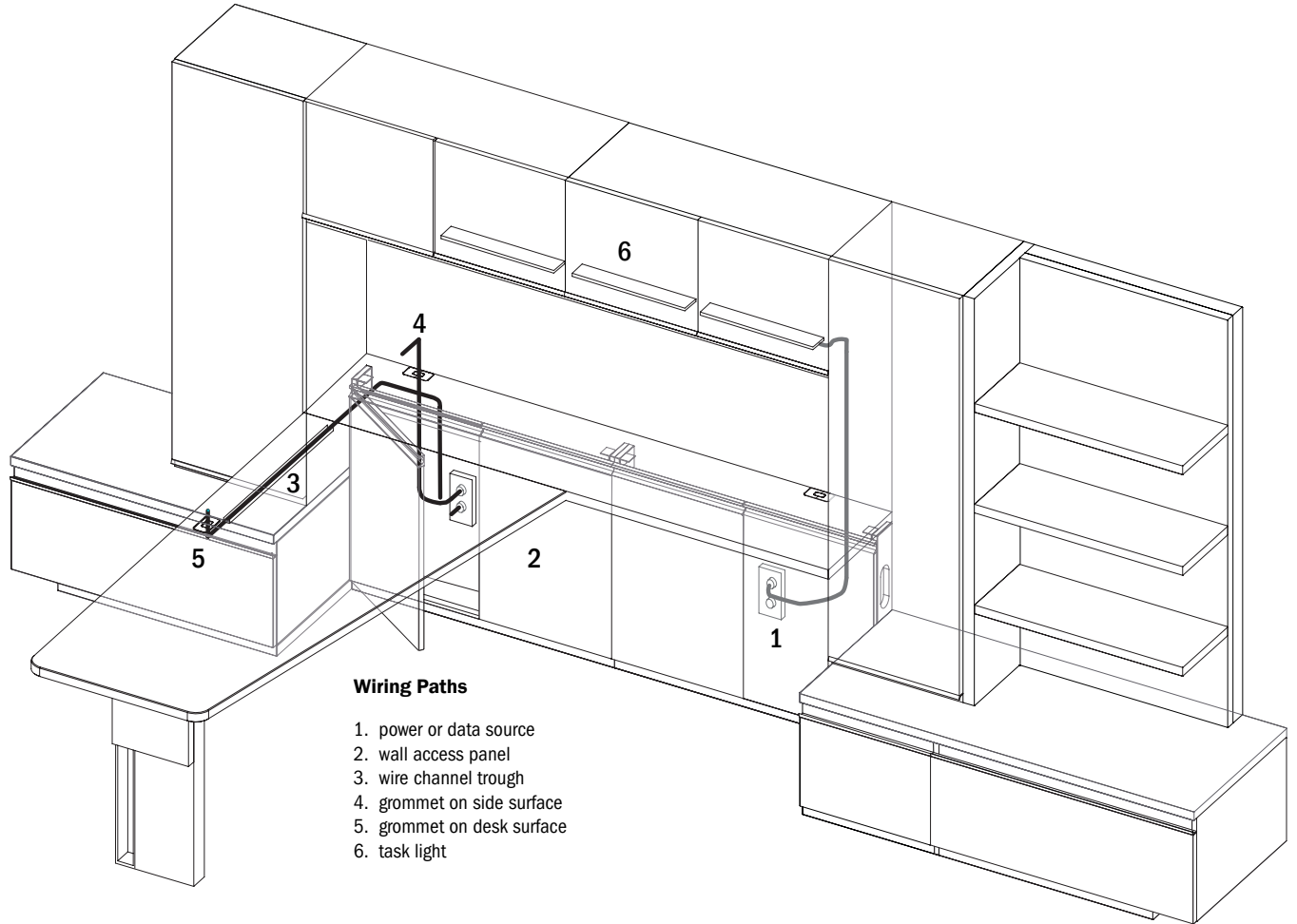

**Wiring Paths**

- 1. power or data source
- 2. wall access panel
- 3. wire channel trough
- 4. grommet on side surface
- 5. grommet on desk surface
- 6. task light

**Power or Data Source - Recommended Location**

**AM7-PAP-1-0472**

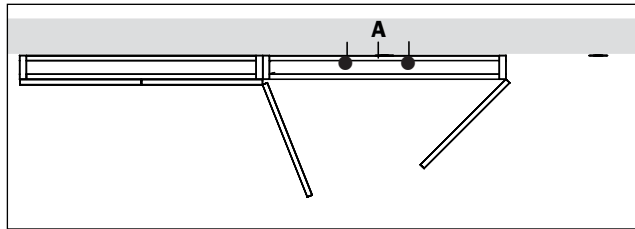

A - horizontal location + or - 5" from door center

**AM7-PAS-1-0472**

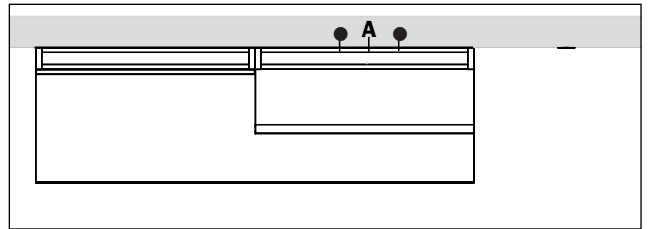

A - horizontal location + or - 5" from door center

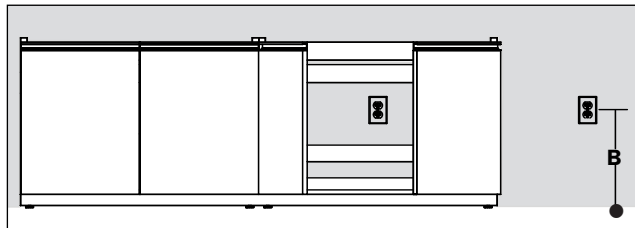

B - vertical location 15" to 24" AFF (above finish floor)

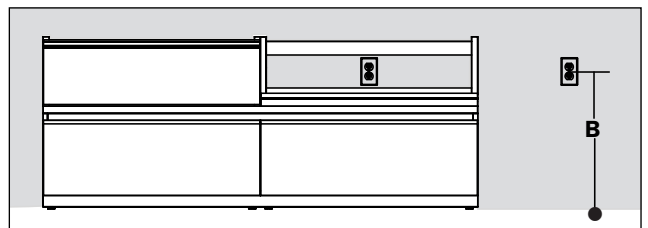

B - vertical location **REQUIRED** to be 24" AFF (above finish floor)

# Apogee™ Product Information

## 86" Overall Height

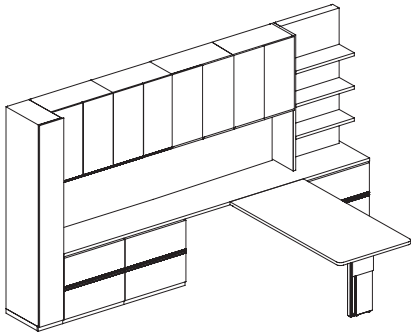

APOGEE™

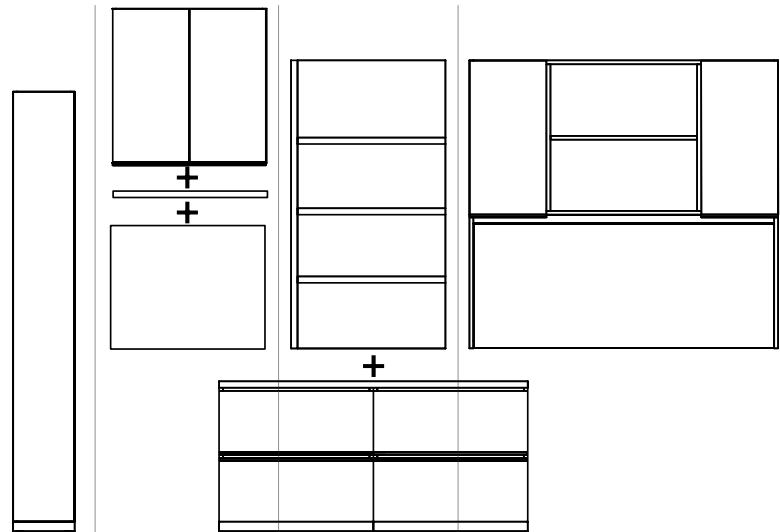

wardrobe	85 7/8"	overhead	30"	tower	56"	storage cabinet	56"
		valance	1 3/4"	credenza	29 1/2"	credenza	29 1/2"
		wall panel	24"				
		spacing	1/4"				
		credenza	29 1/2"				
overall*	86"		86"		86"		86"

\*overall height is rounded up, consideration for leveling tolerance is included.

## 71" Overall Height

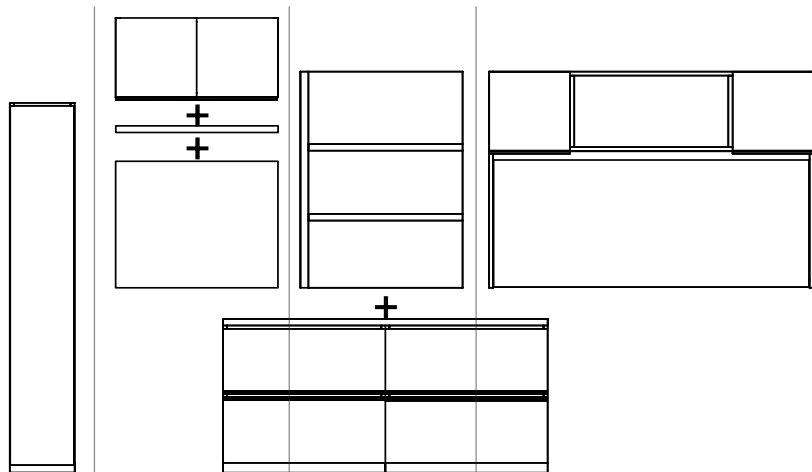
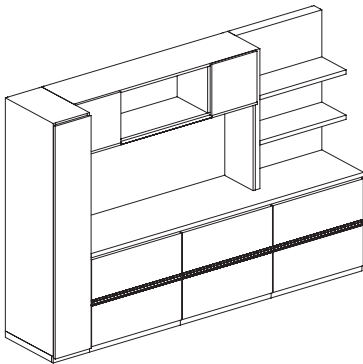

wardrobe	70 1/2"	overhead	15"	tower	41"	storage cabinet	41"
		valance	1 3/4"	credenza	29 1/2"	credenza	29 1/2"
		wall panel	24"				
		spacing	3/4"				
		credenza	29 1/2"				
overall*	71"		71"		71"		71"

\*overall height is rounded up, consideration for leveling tolerance is included.



# Apogee™ Product Information

## 86" Overall Height

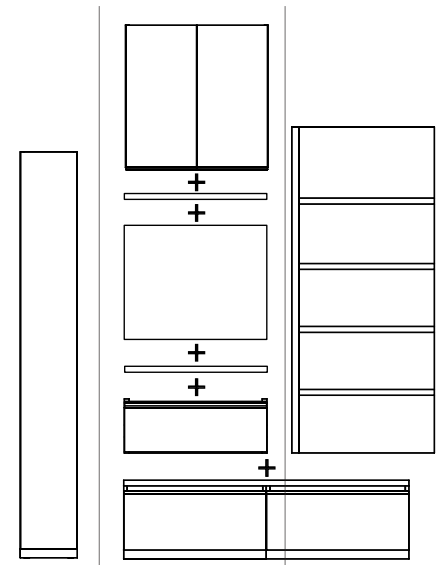
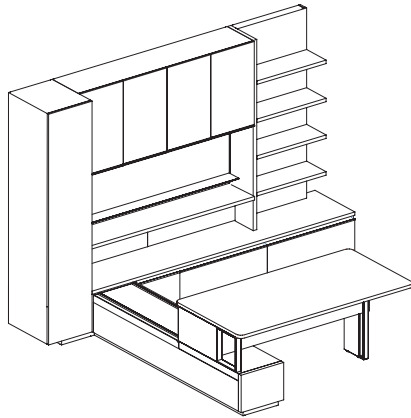

wardrobe	85 1/2"	overhead	30"	tower	68 1/2"
		valance	1 3/4"	credenza	16 7/8"
		wall panel	24"		
		spacing	1/4"		
		worksurface	1 1/8"		
		wall access	11 1/2"		
		credenza	16 7/8"		
overall*	86"		86"		86"

\*overall height is rounded up, consideration for leveling tolerance is included.

## 71" Overall Height

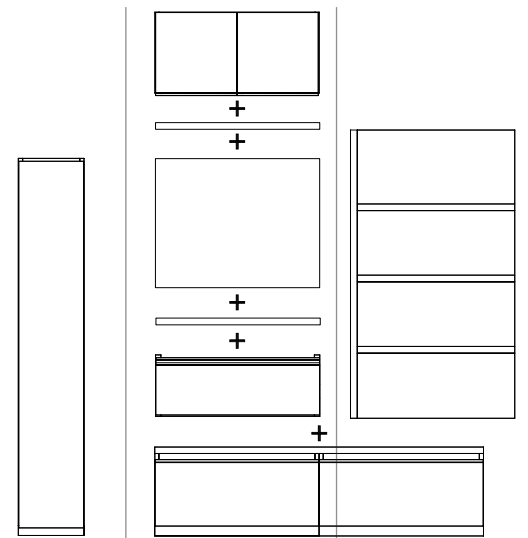
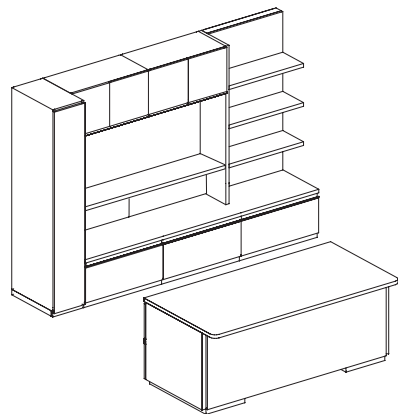

wardrobe	70 1/2"	overhead	15"	tower	53 5/8"
		valance	1 3/4"	credenza	16 7/8"
		wall panel	24"		
		spacing	3/4"		
		worksurface	1 1/8"		
		wall access	11 1/2"		
		credenza	16 7/8"		
overall*	71"		71"		71"

\*overall height is rounded up, consideration for leveling tolerance is included.

APOGEE™

# Apogee™ Product Information

## 86" Overall Height

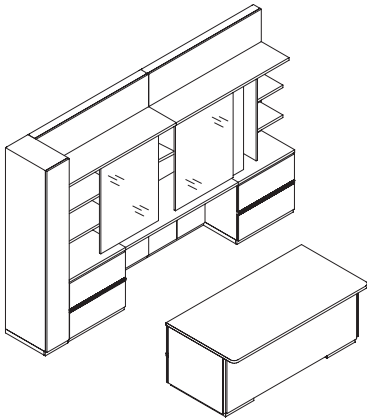

APOGEE™

**Important**

Tops are included with the work wall

Upper workwall component will not work with other overhead components

(Storage Overhead, Wall Mount Overheads, Towers and Asymmetric Shelves)

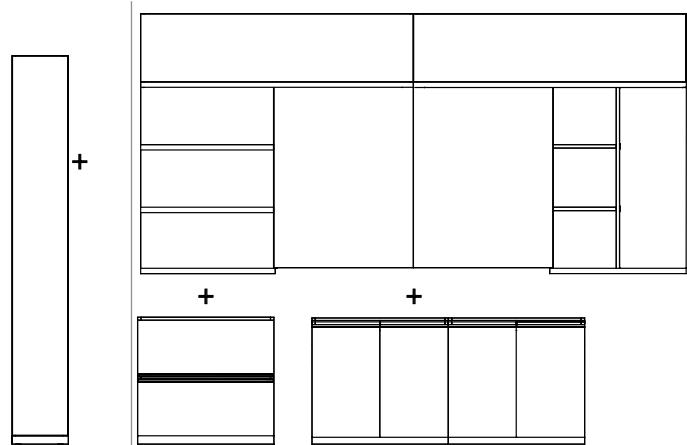

wardrobe	85 1/2"	workwall with sliding door	57"
		lateral without top and wall access panel	28 1/2"
overall*	86"		86"

\*overall height is rounded up, consideration for leveling tolerance is included.

## Apogee™ Product Information

- **1** Select an overall layout style (primary runoff, U grouping or freestanding table desk). Consider the overall width, Workwalls are available in 144" or 120" widths. Then determine the method of support for secondary workwall top, see page 59.
- **2** Choose the workwall, either full open shelves or units with an open center section and doors. When choosing the units with doors you must also select a workcenter, this is required and is specified as a separate model.

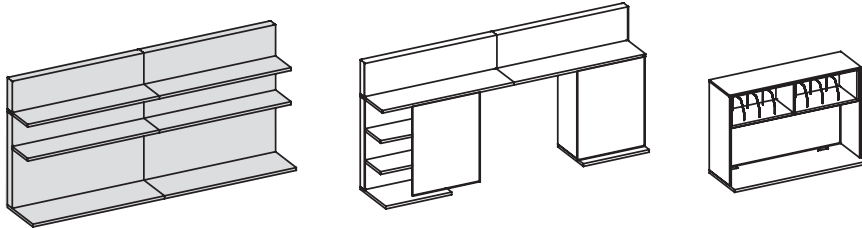

- **3** If using one-high storage/lateral, select the correct kneespace access unit. If side units such as wardrobe cabinets flank the workwall use the unit without the built in support extensions.

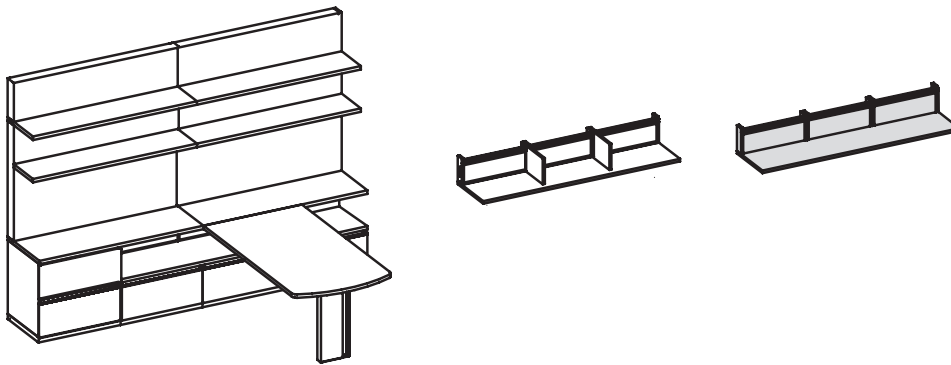

**Note:** These units are only needed when NOT using a workwall and without adjacent storage support

- **4** Choose the lower units to complete the workwall.

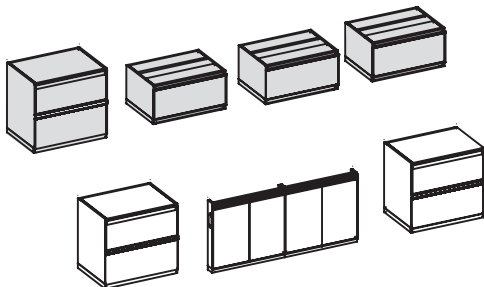

- **5** Choose run-off desk to finish the layout.

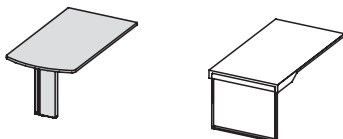

# Apogee™ Product Information

## End Panel Transition to Access Panel

End panel transition supports and creates a transition when using a standard end panel desk and bridge; turning the corner to a kneespace access panel. (This item can be flipped for left or right).

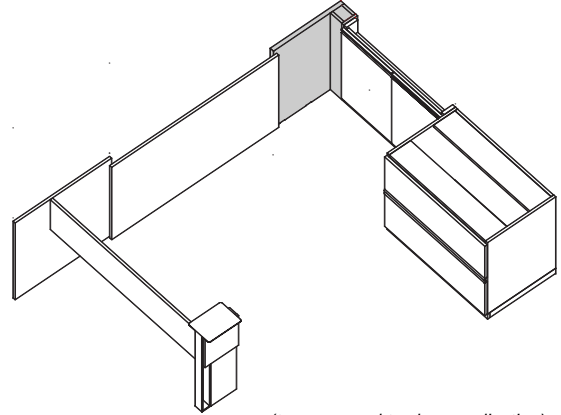
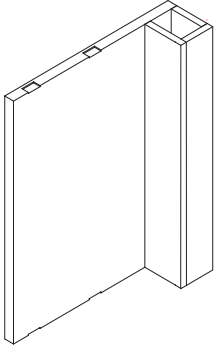

*(tops removed to show application)*

## End Support

End support can be used to end a run of modular units or to turn the corner. Front corners are mitered. (Unit can be used for left or right applications).

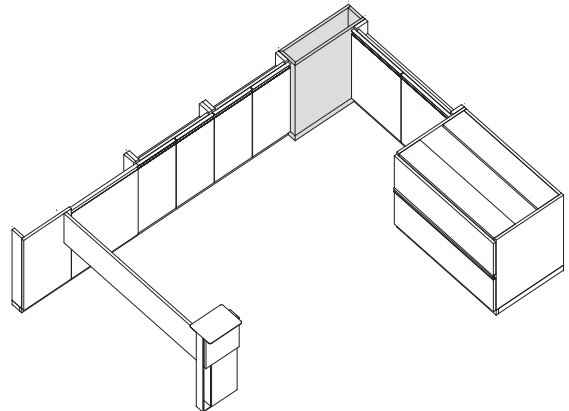
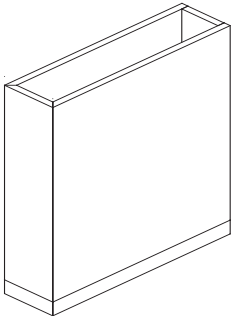

*(tops removed to show application)*

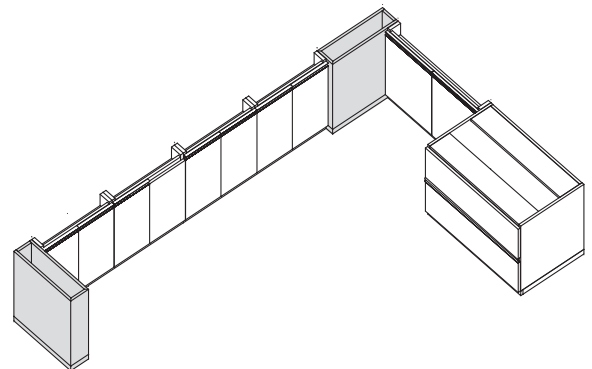

*(tops removed to show application)*

APOGEE™

# Apogee™ Product Information

## Floating Top Appearance

Partial height kneespace access panels are used above one-high storage units to support floating workwall tops. Depending on adjacent storage and support, different types of wall access panels are required.

If you are using a Workwall or have top support on both sides, you can use the Wall Access Panel. If you are not using a Workwall and do not have top support on both sides, a Wall Access Panel with Support Panels is required.

### Wall Access Panel with Support Panels

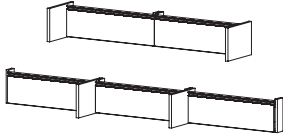

Use the partial wall access units with panel support when configuring examples 1, 2 & 3 see page 135.

#### Example 1

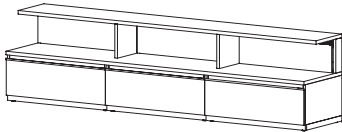

This example needs the additional support for the top, shown with a 15" deep top.

#### Example 2

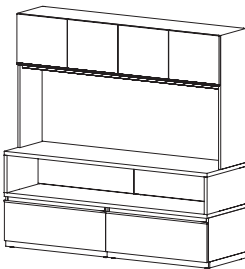

The wall access panel 72" wide has the support panel on the outside which supports the 22" deep top.

#### Example 3

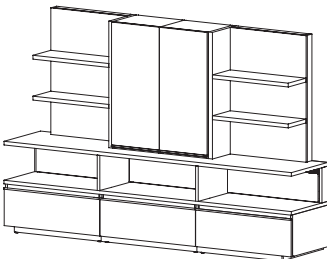

Support for this configuration is needed for the top and the asymmetric shelves and towers.

### Wall Access Panel

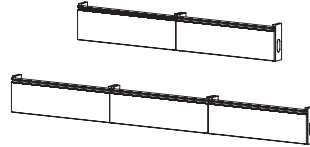

The partial wall access panels as shown above are used in configuration examples 4 & 5 see page 134.

#### Example 4

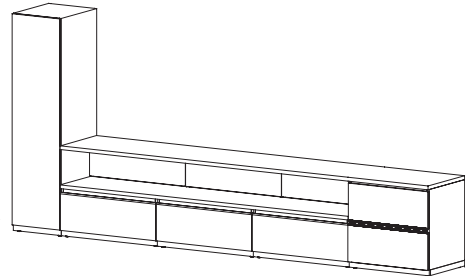

The top is supported from both sides, shown with a 22" deep top.

#### Example 5

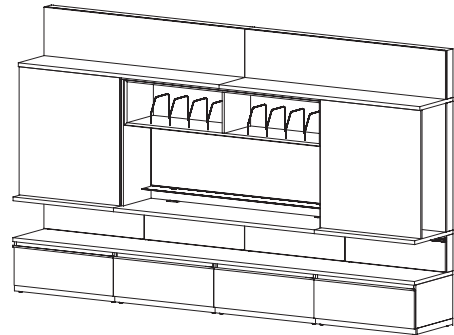

Tops are part of the wall hung workwall components. It is recommended the wall access panel be attached to the wall.

# Apogee™ Product Information

## Finish & Paint Scheme

(see page 62 for list finish options)

APOGEE™

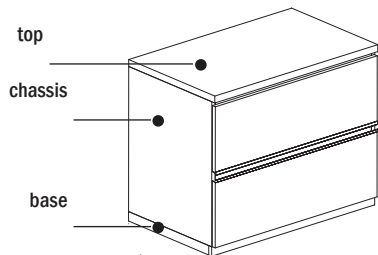

- tops** - veneer only
- chassis/drawer fronts** - veneer or paint
- base** - must match either top or chassis

can only choose one veneer finish and one paint per unit

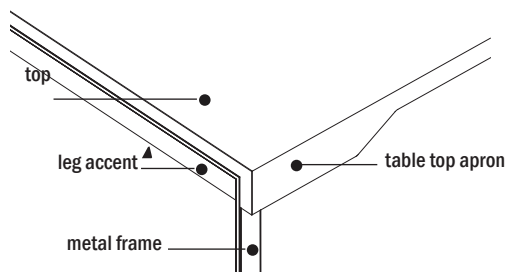

- top and table top apron** - veneer only
- leg accent** - veneer or paint
- metal frame** - arctic silver or bright white

can only choose one veneer finish and one paint per unit

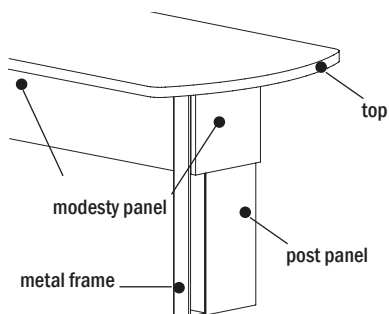

- top** - veneer only
- modesty panel** - veneer or paint
- post panel** - veneer or paint
- metal frame** - arctic silver or bright white

can only choose one veneer finish and one paint per unit

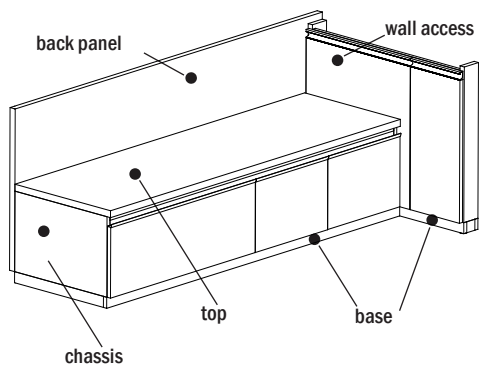

- top** - veneer only
- wall access unit, back panel and chassis/fronts** - veneer or paint
- base** - must match top or wall access unit, back panel and chassis/front

can only choose one veneer finish and one paint per unit

*optional cushions can be order to create a bench*

# Apogee™ Product Information

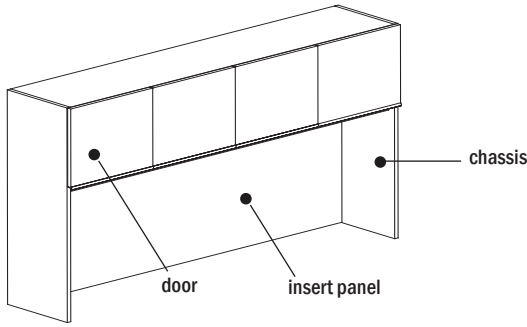

**chassis** - veneer or paint  
**doors** - veneer or paint  
**insert panel** - veneer, paint, magnetic back painted white glass or fabric  
*(requires a specification)*

can only choose one veneer finish and one paint per unit

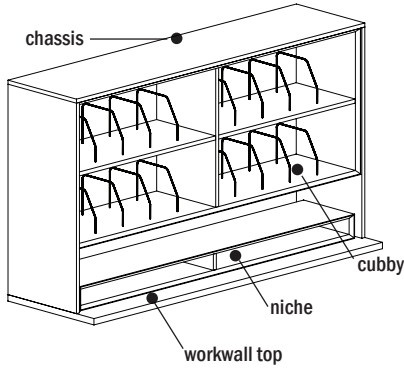

**workwall top** - veneer only  
**chassis** - veneer (same as workwall top) or paint  
**cubby** - paint only  
**divider** - silver  
**niche** - paint only

can only choose one veneer finish and one paint per unit

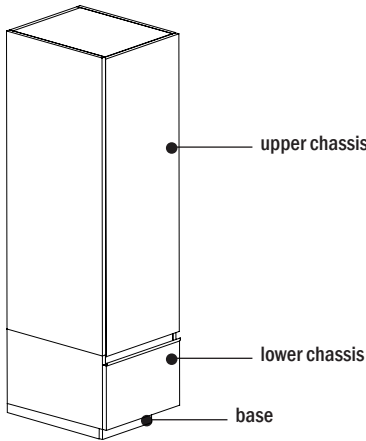

**upper chassis/door fronts** - veneer or paint  
**lower chassis/drawer fronts** - veneer or paint  
**base** - veneer or paint

can only choose one veneer finish and one paint per unit

*scheme allows one high modular components to match lower sections of wardrobe cabinets*

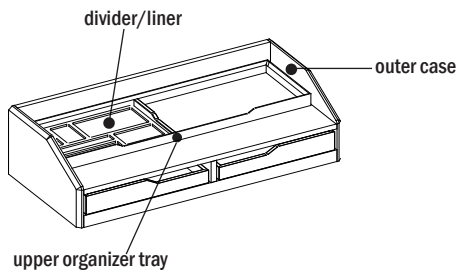

**outer case** - paint  
**divider/liner** - charcoal felt  
**upper organizer tray** - matches outer case  
**paper tray** - paint or veneer

can only choose one veneer finish and one paint per unit

# Apogee™ Product Information

## Finish and Reference Codes - Summary

<b>Select</b>	<b>Code</b>	<b>Paint Colors</b>	<b>Code</b>
<b>Veneer/Substrate</b>		Backdrop	BKD
Makore	MK2	Black Fox	BFX
Maple	MA2	Bright White	BWH
Walnut	WA2	Cargo Pants	CGP
Double Cut	DC1	Chatroom	CHT
<b>Finish</b>		French Roast	FRR
<b>Makore Finishes</b>		Greek Villa	GRV
Barley	BRL	Network Gray	NET
Bourbon Medium	BBM	Nonchalant White	NWH
Brighton Medium	BRM	Storm	STM
Classic	CLA	Tricorn Black	TRC
Collectors	CLL	<b>Metal Finishes</b>	
Earthy	EAR	Arctic Silver	ASL
Harvest	HRV	Bright White	BWH
Legacy	LGC		
Praline	PRL		
Saffron	SAF		
<b>Maples Finishes</b>			
Ale Medium	ALM		
Butterscotch	BUT		
Cinnamon	CIN		
Flax	FLX		
Venetian	VEN		
<b>Walnut Finishes</b>			
Auburn	AUB		
Espresso	ESP		
Mocha	MCH		
Night Owl	NTO		
Sienna	SIE		
Toffee	TOF		
Truffle	TRF		
<b>Double Cut Finishes</b>			
Coffee	COF		
Cremello	CRM		
Fossil	FOS		
Graphite	GRH		
Khaki	KHK		
Studio Teak	STU		

APOGEE™



# Apogee™ - Typical

## AP001

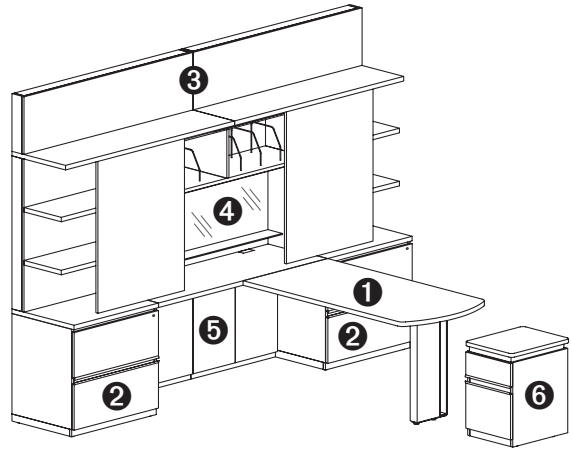
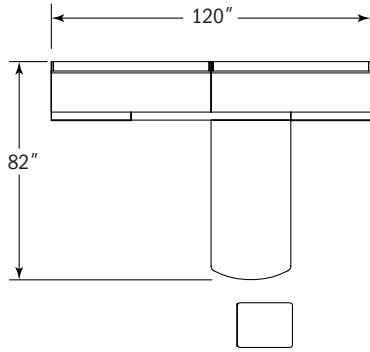

Model	Description	Qty	Price
1 AM1-LRA-1-3060R	arc end run-off desk with post, right	1	\$2,252
2 AM7-FLS-1-2230	2-high lateral file with flush base, no top	2	\$4,516
3 AM4-CWS-1-22120	120" w dual shelf workwall with sliding doors	1	\$13,685
4 AM4-CZW-02-22120	60" w workcenter with magnetic back painted white glass insert with mini shelf	1	\$6,678
5 AM7-PAP-1-0460	kneespace access panel, full height	1	\$2,018
6 AP6-MBP-C-2216	utility/file mobile pedestal with optional cushion, com	1	\$1,655
<b>Typical List Price</b>			<b>\$30,804</b>

## AP004

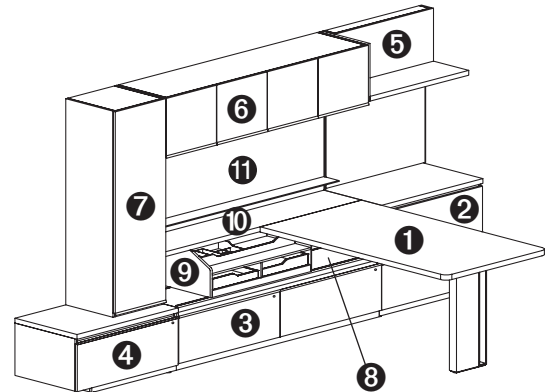
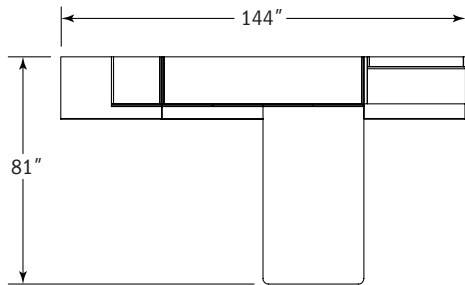

Model	Description	Qty	Price
1 AP1-LRR-1-3666R	run-off desk with post, right	1	\$2,284
2 AP6-FLS-1R-2236R	2-high lateral file with inset base, right	1	\$2,917
3 AM7-FLA-1-2272	1-high lateral file with flush base, no top	1	\$3,234
4 AP6-FLA-1L-2236L	1-high lateral file with inset base, left	1	\$2,221
5 AM4-BOW-ED-1736R	open end shelves (legal depth), right	1	\$1,751
6 AM4-BBW-1D-1872	wall mounted overhead storage (legal depth)	1	\$3,208
7 AP5-OCT-1D-1818L	53 1/2" h storage tower with door (legal depth), left	1	\$2,638
8 AM7-WTP-SH-2272	22" d workwall top with shuttle tracks and access panels	1	\$3,234
9 AM9-SHU-PM-1636	piling shuttle	1	\$1,619
10 AM7-WTU-1-1572	15" d workwall top	1	\$1,100
11 AM9-HVB-S-2472	72" w wall panel with shelf	1	\$2,297
12 AM9-HVB-1-2436	36" w wall panel	1	\$890
AP9-VLB-1-1636	36" w legal valance	1	\$409
AP9-VLB-1-1672	72" w legal valance	1	\$492
TL31LED-S	starter tasklight	1	\$713
TL31LED-A	adder tasklight	1	\$628
<b>Typical List Price</b>			<b>\$29,635</b>

APOGEE™

# Apogee™ - Typical

## AP005

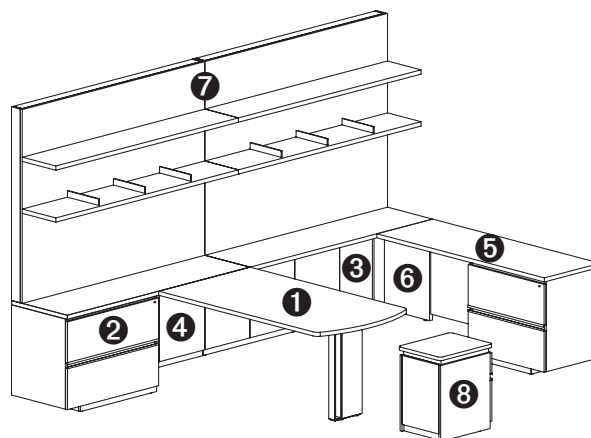
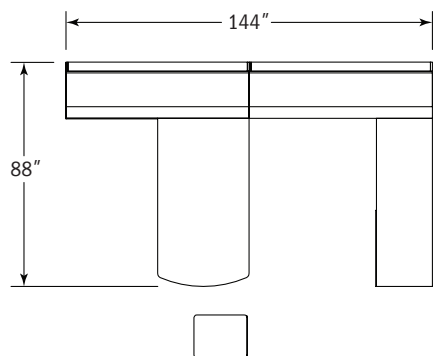

Model	Description	Qty	Price
1 AM1-LRA-1-3666L	arc end run-off desk with post, left	1	\$2,442
2 AM7-FLS-1L-2236L	2-high lateral file with inset base, no top	1	\$2,321
3 AM7-PAP-1-0436	36" w kneespace access panel, full height	1	\$1,512
4 AM7-PAP-1-0466	66" w kneespace access panel, full height	1	\$2,207
5 AP3-RTL-1R-2266R	lateral file return with inset base, right	1	\$3,551
6 AM7-EPT-1-2206	end panel transition to access panel	1	\$1,461
7 AM4-CWO-S2-22144	144" w dual open workwall with 2 shelves and veneer insert panel and 6 legal divider fins	1	\$15,929
8 AP6-MBP-C-2216	mobile pedestal with optional cushion, com	1	\$1,655
AP9-VLB-1-1472	letter valance	2	\$932
TL31LED-S	starter tasklight	2	\$1,426
TL31LED-A	adder tasklight	2	\$1,256

**Typical List Price**

**\$34,692**

## AP007

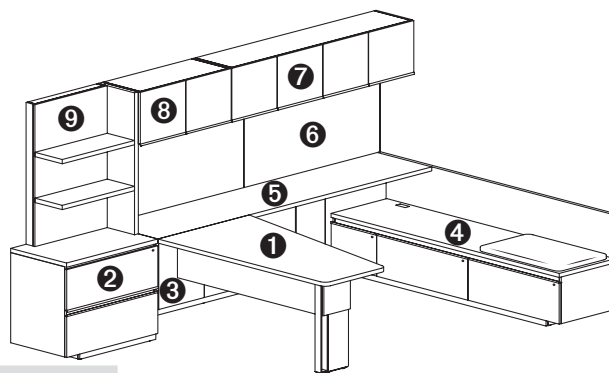
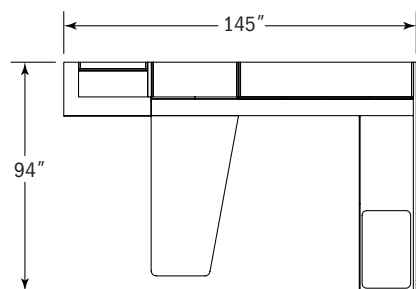

Model	Description	Qty	Price
1 AM1-LRT-1-3666L	trapezoid run-off desk with optional partial modesty panel, left	1	\$3,181
2 AP6-FLS-1L-2236L	2-high lateral file with inset base, left	1	\$2,917
3 AM7-PAP-1-0472	kneespace access panel, full height	1	\$2,397
4 AM2-ROC-8R-3790R	1-high run-off credenza with access door and inset base, right with optional single seat cushion, com	1	\$6,066
5 AM7-WTU-1-22108	22" d workwall top	1	\$1,821
6 AM9-HTB-1-24108	108" w wall mount tackboard, com	1	\$2,232
7 AM4-BBW-1-1572	72" w wall mounted overhead storage (letter depth)	1	\$3,083
8 AM4-BBW-1-1536	36" w wall mounted overhead storage (letter depth)	1	\$2,004
9 AP5-OAS-1-1430L	41" h asymmetric shelves, left	1	\$2,048
AP9-VLB-1-14108	valance for letter depth	1	\$573
TL31LED-S	starter tasklight	1	\$713
TL31LED-A	adder tasklight	1	\$628

**Typical List Price**

**\$27,663**

# Apogee™ - Typical

## AP010

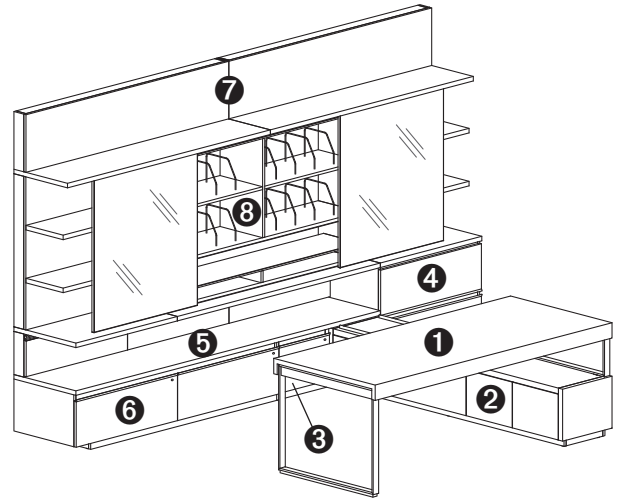
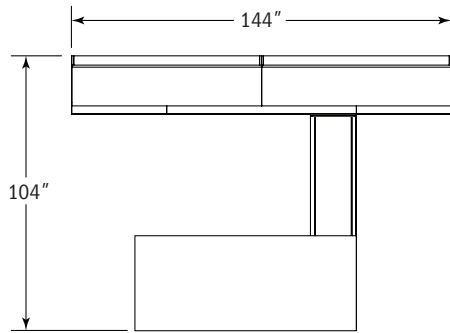

Model	Description	Qty	Price
1	AP1-LCR-T-3684R console desk with open frame leg, right	1	\$3,195
2	AP3-RCS-1-1883L low console bridge, left	1	\$4,437
3	AP7-CCR-1-2236L low console bridge connector with hinge door, left (no top)	1	\$1,695
4	AM7-FLS-1R-2236R 2-high lateral file with inset base, right (no top)	1	\$2,321
5	AM7-WTP-1-22108 kneespace access panel, partial height with workwall top	1	\$4,044
6	AM7-FLA-1L-2272L 1-high lateral file with inset base, left (no top)	1	\$3,234
7	AM4-CWS-1-22144 144" w dual shelf workwall with sliding doors, back painted white glass	1	\$16,743
8	AM4-CZW-05-22144 72" w workcenter with 2 cubbies and niche	1	\$4,995
<b>Typical List Price</b>			<b>\$40,664</b>

## AP013

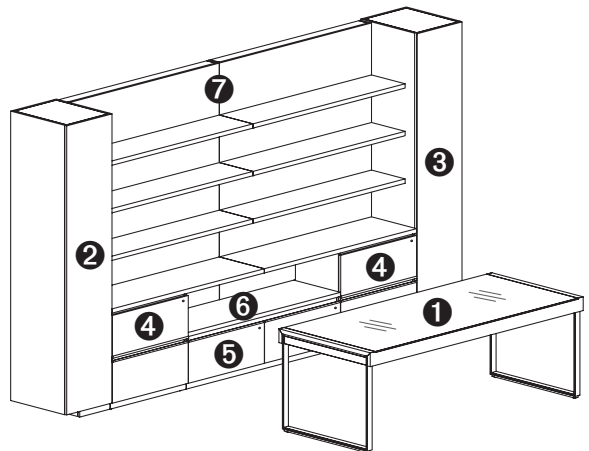
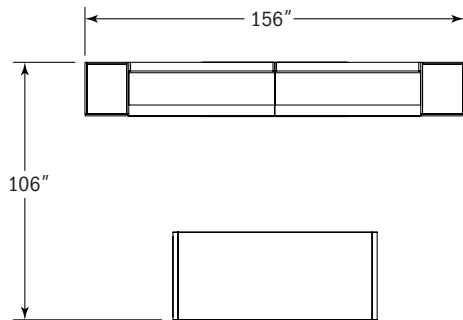

Model	Description	Qty	Price
1	AP1-TDR-1T-3684 table desk with open frame leg, glass top	1	\$5,768
2	AP6-ADT-1L-2218L 85 1/2" h wardrobe unit with inset base, left	1	\$3,701
3	AP6-ADT-1R-2218R 85 1/2" h wardrobe unit with inset base, right	1	\$3,701
4	AM7-FLS-1-2230 2-high lateral file with flush base, no top	2	\$4,516
5	AM7-FLA-1-2260 1-high lateral file with flush base, no top	1	\$3,106
6	AM7-WTP-1-2260 kneespace access panel, partial height with workwall top	1	\$2,930
7	AM4-CWO-S3-22120 120" w dual open workwall with 3 shelves	1	\$10,643
<b>Typical List Price</b>			<b>\$34,365</b>

APOGEE™

# Apogee™ - Typical

## AP015

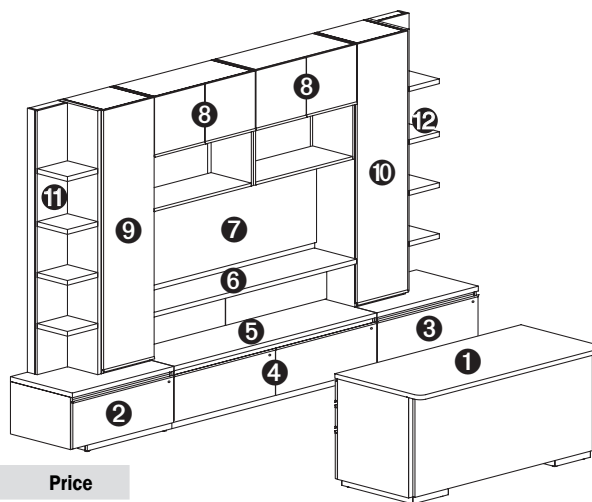
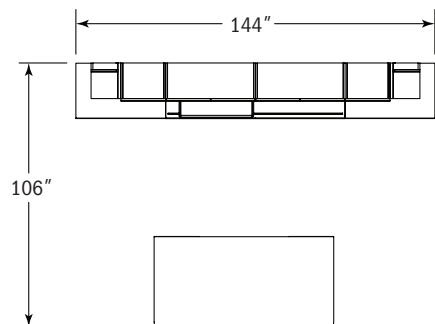

Model	Description	Qty	Price
1 AP1-DPF-1-3672	double pedestal desk with full modesty panel	1	\$5,039
2 AP6-FLA-1L-2236L	1-high lateral file with inset base, left	1	\$2,221
3 AP6-FLA-1R-2236R	1-high lateral file with inset base, right	1	\$2,221
4 AM7-FLA-1-2272	1-high lateral file with flush base, no top	1	\$3,234
5 AM7-WTP-1-2272	kneespace access panel, partial height with workwall top	1	\$3,144
6 AM7-WTU-1-1572	15"d workwall top	1	\$1,100
7 AM9-HTB-1-2472	72"w wall mount tackboard, com	1	\$1,549
8 AM4-BCX-1-1536	15"d double height wall mount overhead cabinet with 2 doors and open storage	2	\$5,100
9 AP5-OCT-T1-1518L	68 1/2"h storage tower, left (letter depth)	1	\$2,891
10 AP5-OCT-T1-1518R	68 1/2"h storage tower, right (letter depth)	1	\$2,891
11 AP5-OAT-T1-1412L	68 1/2"h asymmetrical shelves, left (letter depth)	1	\$1,897
12 AP5-OAT-T1-1412R	68 1/2"h asymmetrical shelves, right (letter depth)	1	\$1,897
AP9-VLB-1-1472	letter valance	1	\$466
TL17LED-S	starter task light	1	\$580
TL17LED-A	adder task light	1	\$397
<b>Typical List Price</b>			<b>\$34,627</b>

## AP017

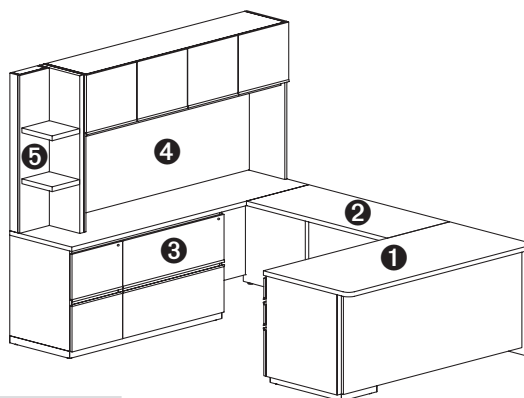
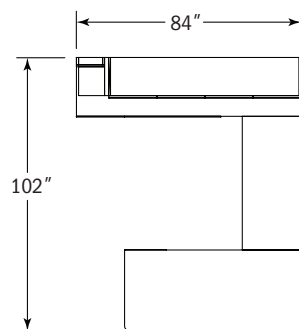

Model	Description	Qty	Price
1 AP1-SPR-1-3066R	single pedestal desk with full modesty panel, right	1	\$4,215
2 AP3-BTU-1-2250	bridge top	1	\$1,111
3 AP2-OBL-1-2284L	open corner credenza with flush base, left	1	\$5,576
4 AP4-BOS-1-1572	72"w storage overhead cabinet with 4 doors with veneer panel insert (letter depth)	1	\$4,652
5 AP5-OAS-1-1412L	41"h asymmetric shelves, left (letter depth)	1	\$1,668
<b>Typical List Price</b>			<b>\$17,222</b>

# Apogee™ - Typical

## AP018

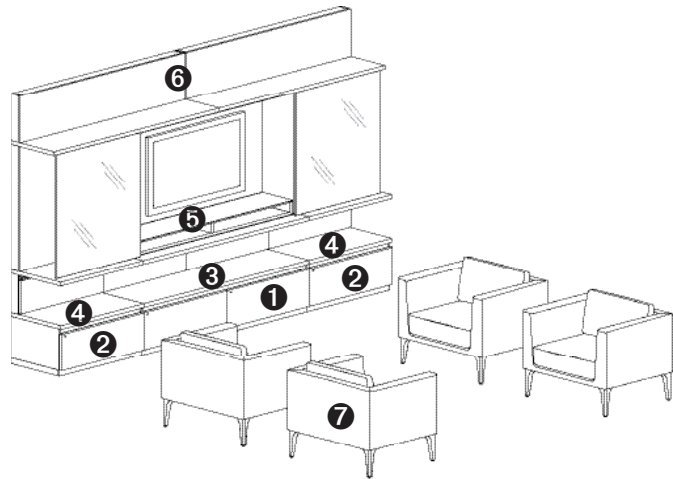
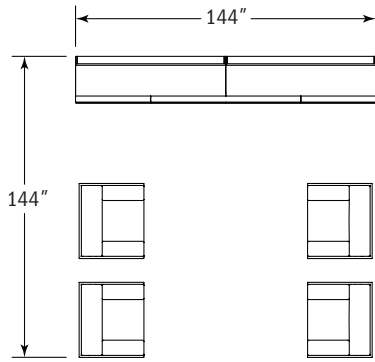

Model	Description	QTY	Price	
1	AM7-FLA-1-2272	1-high lateral file with flush base, no top	1	\$3,234
2	AM7-FLA-1-2236	1-high lateral file with flush base, no top	2	\$3,502
3	AM7-WTP-1-2272	kneespace access panel, partial height with workwall top	1	\$3,144
4	AM7-WTP-1-2236	kneespace access panel, partial height with workwall top	2	\$3,732
5	AM4-CZW-06-22144	72"w media workcenter with niche	1	\$3,094
6	AM4-CWD-1-22144	144"w dual display workwall with back painted white glass sliding doors	1	\$15,982
7	AW6011	Arwyn single seat lounge chair, COM	4	\$7,608
<b>Typical List Price</b>			<b>\$40,296</b>	

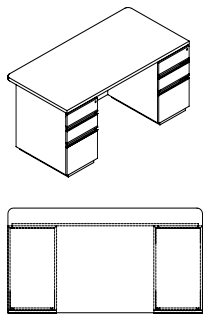
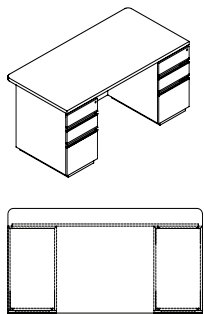
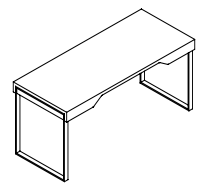
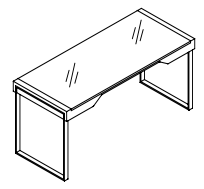
Description	D	W	H	CTN WT	CU FT	① Model	List Price
<b>72" w Double Pedestal Desk with Full Modesty</b>  <ul style="list-style-type: none"> <li>• 18" w utility/box/file pedestal left</li> <li>• 18" w utility/box/file pedestal right</li> <li>• utility drawer with box drawer front</li> <li>• soft close utility/box/file drawers</li> <li>• pedestal front locking</li> <li>• top long grain veneer direction</li> <li>• base on pedestals is inset</li> <li>• center drawer available, see page 173</li> <li>• grommet available, specify and add \$99 list each; see page 50</li> <li>• adjustable levelers/glides</li> <li>• kneespace width: 36"</li> <li>• kneespace height: 28 1/4"</li> <li>• 5 3/8" overhang on approach side</li> </ul>	36	72	29 1/2	369	53	<b>AP1-DPF-1-3672</b>	<b>\$5,039</b>
<b>66" w Double Pedestal Desk with Full Modesty</b>  <ul style="list-style-type: none"> <li>• 15 1/2" w utility/box/file pedestal left</li> <li>• 15 1/2" w utility/box/file pedestal right</li> <li>• utility drawer with box drawer front</li> <li>• soft close utility/box/file drawers</li> <li>• pedestal front locking</li> <li>• top long grain veneer direction</li> <li>• center drawer available, see page 173</li> <li>• grommet available, specify and add \$99 list each; see page 50</li> <li>• base on pedestals is inset</li> <li>• adjustable levelers/glides</li> <li>• kneespace width: 34 7/8"</li> <li>• kneespace height: 28 1/4"</li> <li>• 3 3/8" overhang on approach side</li> </ul>	30	66	29 1/2	308	41	<b>AP1-DPF-1-3066</b>	<b>\$4,849</b>
<b>Veneer Table Desk with Open Frame Leg</b>  <ul style="list-style-type: none"> <li>• veneer top with veneer wrapped apron</li> <li>• angled apron user side</li> <li>• top long grain veneer direction</li> <li>• legs are tubular steel structure with powder coated finish</li> <li>• recessed leveling guides</li> <li>• center drawer not available</li> <li>• grommet available, specify and add \$99 list each; see page 50 for diagram G1</li> <li>• kneespace height: 27 3/4"</li> <li>• -3684 kneespace width: 48"</li> <li>• -3672 &amp; -3066 kneespace width: 36"</li> </ul>	36	84	29 1/2	166	61	<b>AP1-TDR-1-3684</b>	<b>\$3,739</b>
	36	72	29 1/2	148	53	<b>AP1-TDR-1-3672</b>	<b>\$3,361</b>
	30	66	29 1/2	119	41	<b>AP1-TDR-1-3066</b>	<b>\$3,221</b>
<b>Glass Table Desk with Open Frame Leg</b>  <ul style="list-style-type: none"> <li>• glass top with veneer wrapped apron</li> <li>• angled apron user side</li> <li>• glossy low iron bright white back painted glass insert</li> <li>• recessed leveling guides</li> <li>• center drawer not available</li> <li>• kneespace height: 27 3/4"</li> <li>• -3684 kneespace width: 48"</li> <li>• -3672 &amp; -3066 kneespace width: 36"</li> </ul>	36	84	29 1/2	202	61	<b>AP1-TDR-1T-3684</b>	<b>\$5,768</b>
	36	72	29 1/2	179	53	<b>AP1-TDR-1T-3672</b>	<b>\$5,576</b>
	30	66	29 1/2	143	41	<b>AP1-TDR-1T-3066</b>	<b>\$5,450</b>

Description	D	W	H	CTN WT	CU FT	① Model	List Price
Single Pedestal Desk with Full Modesty	36	78	29 ½	298	57	AP1-SPR-1-3678R	\$4,471
	36	78	29 ½	298	57	AP1-SPR-1-3678L	\$4,471
	36	72	29 ½	286	53	AP1-SPR-1-3672R	\$4,405
	36	72	29 ½	286	53	AP1-SPR-1-3672L	\$4,405

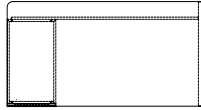
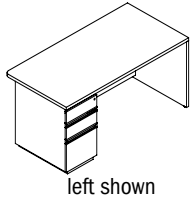

- 18" w utility/box/file pedestal
- utility drawer with box drawer front
- soft close utility/box/file drawers
- pedestal front locking
- top long grain veneer direction
- base on pedestal is inset
- adjustable levelers/glides
- center drawer available, see page 173
- grommet available, specify and add \$99 list each; see page 50
- kneespace height: 28 ¼"
- -3678 kneespace width: 58 ⅞"
- -3672 kneespace width: 52 ⅞"
- 5 ⅜" overhang on approach side

Single Pedestal Desk with Full Modesty	36	66	29 ½	266	49	AP1-SPR-1-3666R	\$4,279
	36	66	29 ½	266	49	AP1-SPR-1-3666L	\$4,279
	30	66	29 ½	237	41	AP1-SPR-1-3066R	\$4,215
	30	66	29 ½	237	41	AP1-SPR-1-3066L	\$4,215

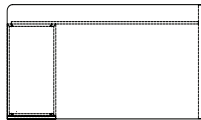
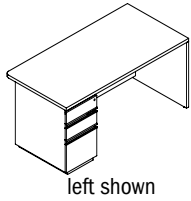

- 15 ½" w utility/box/file pedestal
- utility drawer with box drawer front
- soft close utility/box/file drawers
- pedestal front locking
- top long grain veneer direction
- base on pedestal is inset
- adjustable levelers/glides
- center drawer available, see page 173
- grommet available, specify and add \$99 list each; see page 50
- kneespace height: 28 ¼"
- kneespace width: 49 ¼"
- 5 ⅜" overhang on approach side

**To Order, Specify:**

- ① Model Number
- ② Wood Species on Top/Veneer Wrapped Apron - Makore (MK2), Maple (MA2), Walnut (WA2) or Double Cut (DC1) (see page 62)
- ③ Finish Color for Top/Veneer Wrapped Apron (see page 62)
- ④ Finish Color for Chassis/Drawer Fronts or Leg Accent
  - a.) Same as Top/Veneer Wrapped Apron
  - b.) Paint Color (see page 62)
- ⑤ Finish Color for Base
  - a.) Same as Top/Veneer Wrapped Apron
  - b.) Same as Chassis/Drawer Fronts or Paint (see page 62)

- ⑥ Metal Open Frame Color (see page 62)

Note: Only one wood finish and one paint color can be specified per unit

**Product Modifications:**

Pedestal Change - see page 39

Description	D	W	H	CTN WT	CU FT	① Model	List Price
End Panel Desk with Partial Modesty	36	84	29½	167	12	AP1-LER-1-3684R	\$2,987
	36	84	29½	167	12	AP1-LER-1-3684L	\$2,987
	36	78	29½	156	11	AP1-LER-1-3678R	\$2,790
	36	78	29½	156	11	AP1-LER-1-3678L	\$2,790
	36	72	29½	153	11	AP1-LER-1-3672R	\$2,721
	36	72	29½	153	11	AP1-LER-1-3672L	\$2,721
	36	66	29½	145	10	AP1-LER-1-3666R	\$2,676
	36	66	29½	145	10	AP1-LER-1-3666L	\$2,676
	30	66	29½	128	9	AP1-LER-1-3066R	\$2,612
	30	66	29½	128	9	AP1-LER-1-3066L	\$2,612

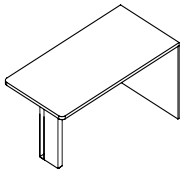

left shown

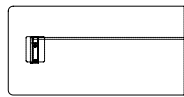

- must be used with a return or bridge
- end panel finished on back
- tubular metal post accent
- recessed leveling guides
- optional full modesty panel available, specify and add \$737 list for 84" w, \$713 list for 78" w, \$661 list for 72" w or \$635 list for 66" w
- grommet available, specify and add \$99 list each; see page 50
- kneespace height: 28 ¼"

Access End Panel Desk with Partial Modesty	36	84	29½	171	12	AP1-LER-W-3684R	\$3,493
	36	84	29½	171	12	AP1-LER-W-3684L	\$3,493
	36	78	29½	163	11	AP1-LER-W-3678R	\$3,296
	36	78	29½	163	11	AP1-LER-W-3678L	\$3,296
	36	72	29½	153	11	AP1-LER-W-3672R	\$3,228
	36	72	29½	153	11	AP1-LER-W-3672L	\$3,228
	36	66	29½	148	10	AP1-LER-W-3666R	\$3,184
	36	66	29½	148	10	AP1-LER-W-3666L	\$3,184
	30	66	29½	137	9	AP1-LER-W-3066R	\$3,120
	30	66	29½	137	9	AP1-LER-W-3066L	\$3,120

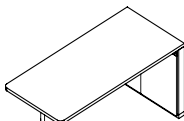

left shown

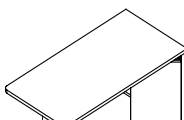

door open

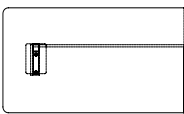

- must be used with a return shell with access panel or full height kneespace access panel
- end panel opened on back
- tubular metal post accent
- recessed leveling guides
- optional full modesty panel available, specify and add \$737 list for 84" w, \$713 list for 78" w, \$661 list for 72" w or \$635 list for 66" w
- due to back construction unit is intended to sit against wall for access
- grommet available, specify and add \$99 list each; see page 50
- kneespace height: 28 ¼"
- 36" d access door dimension: 21" w
- 30" d access door dimension: 18" w



Description	D	W	H	CTN WT	CU FT	① Model	List Price
Pedestal Run-Off Desk	36	72	29 ½	167	12	AM1-PRR-1-3672R	\$3,184
	36	72	29 ½	167	12	AM1-PRR-1-3672L	\$3,184

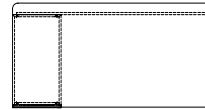
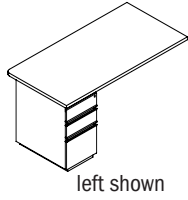

- base on pedestal is inset
- 18" w utility/box/file pedestal
- utility drawer with box drawer front
- soft close utility/box/file drawers
- pedestal front locking
- adjustable levelers/glides
- optional full modesty panel available, specify and add \$890 list and indicate depth of side workwall top; 15" d or 22" d
- optional partial modesty panel available, specify and add \$668 list and indicated depth of side workwall top; 15" d or 22" d
- grommet available, specify and add \$99 list each; see page 50
- kneespace height: 28 ¼"
- kneespace width: 54"
- 5 ¼" overhang on approach side

Pedestal Run-Off Desk	36	66	29 ½	189	8	AM1-PRR-1-3666R	\$3,120
	36	66	29 ½	189	8	AM1-PRR-1-3666L	\$3,120
	30	66	29 ½	165	7	AM1-PRR-1-3066R	\$3,057
	30	66	29 ½	165	7	AM1-PRR-1-3066L	\$3,057
	30	60	29 ½	159	7	AM1-PRR-1-3060R	\$2,994
	30	60	29 ½	159	7	AM1-PRR-1-3060L	\$2,994

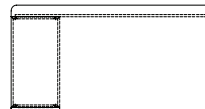
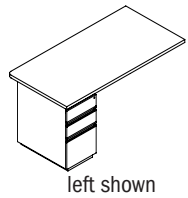

- base on pedestal is inset
- 15 ¼" w utility/box/file pedestal
- utility drawer with box drawer front
- soft close utility/box/file drawers
- pedestal front locking
- adjustable levelers/glides
- optional full modesty panel available, specify and add \$814 list for 66" w or \$737 list for 60" w and indicate depth of side workwall top; 15" d or 22" d
- optional partial modesty panel available, specify and add \$612 list for 66" w or \$554 list for 60" w and indicate depth of side workwall top; 15" d or 22" d
- grommet available, specify and add \$99 list each; see page 50
- kneespace height: 28 ¼"
- -3666 & -3066 kneespace width: 50 ¾"
- -3066 kneespace width: 44 ¾"
- 3 ¾" overhang on approach side

**To Order, Specify:**

- ① Model Number
- ② Wood Species on Top - Makore (MK2), Maple (MA2) Walnut (WA2) or Double Cut (DC1) (see page 62)
- ③ Finish Color for Top (see page 62)
- ④ Top Veneer Direction: long or short grain
- ⑤ Finish Color for Chassis/Drawer Fronts
  - a.) Same as Top
  - b.) Paint Color (see page 62)
- ⑥ Finish Color for Base
  - a.) Same as Top
  - b.) Same as Chassis/Drawer Fronts or Paint (see page 62)

**Product Modifications:**  
Pedestal Change - see page 39

- ⑦ Finish Color for Post Panel
  - a.) Same as Top
  - b.) Same as Chassis/Drawer Fronts or Paint Color (see page 62)
- ⑧ Metal Post Accent Color (see page 62)
- ⑨ Finish Color for Modesty Panel:
  - a.) Same as Top
  - b.) Same as Chassis/Drawer Fronts or Paint Color (see page 62)

Note: Only one wood finish and one paint color can be specified per unit

Description	D	W	H	CTN WT	CU FT	① Model	List Price
36" d Run-Off Table Desk with Open Frame Leg	36	66	29½	122	49	AM1-LRR-T-3666R	\$2,663
	36	66	29½	122	49	AM1-LRR-T-3666L	\$2,663
	36	60	29½	112	44	AM1-LRR-T-3660R	\$2,601
	36	60	29½	112	44	AM1-LRR-T-3660L	\$2,601

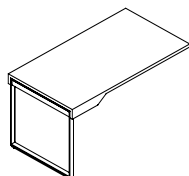

left shown

- veneer top with veneer wrapped apron
- angled apron both sides
- top long grain veneer direction
- legs are tubular steel structure with powder coated finish
- recessed leveling guides
- grommet available, specify and add \$99 list each; see page 50 for diagram G1
- kneespace height: 28 ¼"
- -3666 kneespace width: 47"
- -3660 kneespace width: 41"

30" d Run-Off Table Desk with Open Frame Leg	30	66	29½	101	41	AM1-LRR-T-3066R	\$2,535
	30	66	29½	101	41	AM1-LRR-T-3066L	\$2,535
	30	60	29½	99	37	AM1-LRR-T-3060R	\$2,473
	30	60	29½	99	37	AM1-LRR-T-3060L	\$2,473
	30	54	29½	91	34	AM1-LRR-T-3054R	\$2,409
	30	54	29½	91	34	AM1-LRR-T-3054L	\$2,409

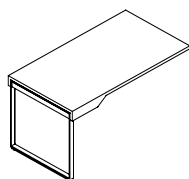

left shown

- veneer top with veneer wrapped apron
- angled apron both sides
- top long grain veneer direction
- legs are tubular steel structure with powder coated finish
- recessed leveling guides
- grommet available, specify and add \$99 list each; see page 50 for diagram G1
- kneespace height: 28 ¼"
- -3066 kneespace width: 47"
- -3060 kneespace width: 41"
- -3054 kneespace width: 35"

Run-Off Desk with Post	36	66	29½	125	10	AP1-LRR-1-3666R	\$2,284
	36	66	29½	125	10	AP1-LRR-1-3666L	\$2,284
	30	66	29½	112	9	AP1-LRR-1-3066R	\$2,221
	30	66	29½	112	9	AP1-LRR-1-3066L	\$2,221
	30	60	29½	106	9	AP1-LRR-1-3060R	\$2,157
	30	60	29½	106	9	AP1-LRR-1-3060L	\$2,157
	30	54	29½	100	8	AP1-LRR-1-3054R	\$2,094
	30	54	29½	100	8	AP1-LRR-1-3054L	\$2,094

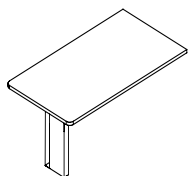

left shown

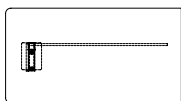

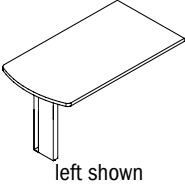
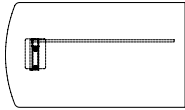

shown with optional modesty panel

- tubular metal post accent
- recessed leveling guides
- specify top veneer direction, long or short grain
- optional full modesty panel available, specify and add \$814 list for 66" w, \$737 list for 60" w or \$668 list for 54" w and indicate depth of side workwall; 15" d or 22" d
- optional partial modesty panel available, specify and add \$612 list for 66" w, \$554 list for 60" w or \$497 list for 54" w and indicate depth of side workwall; 15" d or 22" d
- grommet available, specify and add \$99 list each; see page 50
- kneespace height: 28 ¼"

Description	D	W	H	CTN WT	CU FT	① Model	List Price
 <p>left shown</p>  <p>shown with optional modesty panel</p>	36	66	29 ½	124	8	AM1-LRA-1-3666R	\$2,442
	36	66	29 ½	124	8	AM1-LRA-1-3666L	\$2,442
	36	60	29 ½	117	8	AM1-LRA-1-3660R	\$2,380
	36	60	29 ½	117	8	AM1-LRA-1-3660L	\$2,380
	30	66	29 ½	111	7	AM1-LRA-1-3066R	\$2,316
	30	66	29 ½	111	7	AM1-LRA-1-3066L	\$2,316
	30	60	29 ½	105	7	AM1-LRA-1-3060R	\$2,252
	30	60	29 ½	105	7	AM1-LRA-1-3060L	\$2,252
	30	54	29 ½	99	6	AM1-LRA-1-3054R	\$2,190
	30	54	29 ½	99	6	AM1-LRA-1-3054L	\$2,190

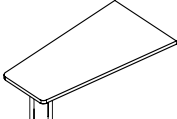
- tubular metal post accent
- recessed leveling guides
- specify top veneer direction, long or short grain
- optional full modesty panel available, specify and add \$814 list for 66" w, \$737 list for 60" w or \$668 list for 54" w and indicate depth of side workwall; 15" d or 22" d
- optional partial modesty panel available, specify and add \$612 list for 66" w, \$554 list for 60" w or \$497 list for 54" w and indicate depth of side workwall; 15" d or 22" d
- grommet available, specify and add \$99 list each; see page 50
- kneespace height: 28 ¼"

<p>Trapezoid Run-Off Desk with Post</p>  <p>left shown</p>  <p>shown with optional modesty panel</p>	36	66	29 ½	109	8	AM1-LRT-1-3666R	\$2,569
	36	66	29 ½	109	8	AM1-LRT-1-3666L	\$2,569
	36	60	29 ½	102	8	AM1-LRT-1-3660R	\$2,505
	36	60	29 ½	102	8	AM1-LRT-1-3660L	\$2,505
	36	54	29 ½	97	7	AM1-LRT-1-3654R	\$2,316
	36	54	29 ½	97	7	AM1-LRT-1-3654L	\$2,316

- tubular metal post accent
- recessed leveling guides
- specify top veneer direction, long or short grain
- optional full modesty panel available, specify and add \$814 list for 66" w, \$737 list for 60" w or \$668 list for 54" w and indicate depth of side workwall; 15" d or 22" d
- optional partial modesty panel available, specify and add \$612 list for 66" w, \$554 list for 60" w or \$497 list for 54" w and indicate depth of side workwall; 15" d or 22" d
- grommet available, specify and add \$99 list each; see page 50
- kneespace height: 28 ¼"

**To Order, Specify:**

- ① Model Number
- ② Wood Species on Top/Veneer Wrapped Apron - Makore (MK2), Maple (MA2), Walnut (WA2) or Double Cut (DC1) (see page 62)
- ③ Finish Color on Top/Veneer Wrapped Apron (see page 62)
- ④ Top Veneer Grain Direction: long or short grain (for desks with a post leg)
- ⑤ Leg Accent/Post Panel Accent Color
  - a.) Same as Top
  - b.) Paint (see page 62)
- ⑥ Metal Open Frame Color or Metal Post Accent Color (see page 62)

- ⑦ Finish Color for Modesty Panel:
  - a.) Same as Top
  - b.) Same as Chassis/Drawer Fronts or Paint Color (see page 62)

Note: Only one wood finish and one paint color can be specified per unit

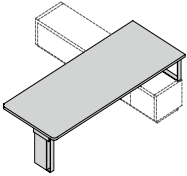
Description	D	W	H	CTN WT	CU FT	① Model	List Price
 right shown	36	90	29½	167	66	AP1-LCR-1-3690R	\$2,981
	36	90	29½	167	66	AP1-LCR-1-3690L	\$2,981
	36	84	29½	157	61	AP1-LCR-1-3684R	\$2,853
	36	84	29½	157	61	AP1-LCR-1-3684L	\$2,853
	36	72	29½	139	53	AP1-LCR-1-3672R	\$2,633
	36	72	29½	139	53	AP1-LCR-1-3672L	\$2,633
	30	66	29½	114	41	AP1-LCR-1-3066R	\$2,535
	30	66	29½	114	41	AP1-LCR-1-3066L	\$2,535

- use with low console
- top long grain veneer direction
- tubular metal post accent
- recessed leveling glides
- optional partial modesty panel available, specify and add \$827 list for 90"w, \$777 list for 84"w, \$668 list for 72"w and \$612 list for 66"w
- power access unit available, specify and add \$332 list
- grommet available, specify and add \$99 list each; see page 50 for diagram G1
- kneespace height: 28 ¼"
- -3690 & -3684 kneespace width: 48"
- -3072 & -3066 kneespace width: 36"

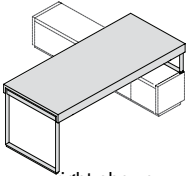
Description	D	W	H	CTN WT	CU FT	① Model	List Price
 right shown	36	90	29½	170	66	AP1-LCR-T-3690R	\$3,334
	36	90	29½	170	66	AP1-LCR-T-3690L	\$3,334
	36	84	29½	160	61	AP1-LCR-T-3684R	\$3,195
	36	84	29½	160	61	AP1-LCR-T-3684L	\$3,195
	36	72	29½	141	53	AP1-LCR-T-3672R	\$2,994
	36	72	29½	141	53	AP1-LCR-T-3672L	\$2,994
	30	66	29½	117	41	AP1-LCR-T-3066R	\$2,853
	30	66	29½	117	41	AP1-LCR-T-3066L	\$2,853

- use with low console
- veneer top with veneer wrapped apron
- top long grain veneer direction
- legs are tubular steel structure with powder coated finish
- power access unit available, specify and add \$332 list
- recessed leveling glides
- grommet available, specify and add \$99 list each; see page 50 for diagram G1
- kneespace height: 28 ¼"
- -3690 & -3684 kneespace width: 48"
- -3072 & -3066 kneespace width: 36"

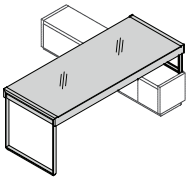
Description	D	W	H	CTN WT	CU FT	① Model	List Price
 right shown	36	90	29½	223	66	AP1-LCR-TT-3690R	\$5,514
	36	90	29½	223	66	AP1-LCR-TT-3690L	\$5,514
	36	84	29½	210	61	AP1-LCR-TT-3684R	\$5,221
	36	84	29½	210	61	AP1-LCR-TT-3684L	\$5,221
	36	72	29½	183	53	AP1-LCR-TT-3672R	\$5,019
	36	72	29½	183	53	AP1-LCR-TT-3672L	\$5,019
	30	66	29½	149	41	AP1-LCR-TT-3066R	\$4,881
	30	66	29½	149	41	AP1-LCR-TT-3066L	\$4,881

- use with low console
- glass top with veneer wrapped apron
- glossy low iron white back painted glass insert
- recessed leveling glides
- kneespace height: 28 ¼"
- -3690 & -3684 kneespace width: 48"
- -3072 & -3066 kneespace width: 36"

Description	D	W	H	CTN WT	CU FT	① Model	List Price
Low Console Bridge	18	83	15 ¾	200	18	AP3-RCS-1-1883R	\$4,437
	18	83	15 ¾	200	18	AP3-RCS-1-1883L	\$4,437
	18	77	15 ¾	190	17	AP3-RCS-1-1877R	\$3,930
	18	77	15 ¾	190	17	AP3-RCS-1-1877L	\$3,930

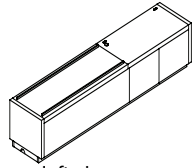

left shown

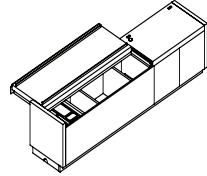

- 83" w console return must be used with 36" d console desk
- 77" w console return must be used with 30" d console desk
- includes electrical power unit with two power outlets, one each CAT6 data and phone jack, 10' long power cord and 14' long phone and data cords
- includes bright white charging tray and bright white organizer tray with felt liner
- hinge door unit for wire access only
- surface grommet
- internal wire pass thru to low console bridge connector
- sliding top locking
- locking doors available, specify and add \$123 list

Low Console Bridge Connector with Hinge Door	22	36	15 ¾	88	10	AP7-CCR-1-2236R	\$1,695
	22	36	15 ¾	88	10	AP7-CCR-1-2236L	\$1,695
	22	30	15 ¾	78	8	AP7-CCR-1-2230R	\$1,566
	22	30	15 ¾	78	8	AP7-CCR-1-2230L	\$1,566

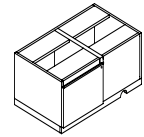

left shown

- use with console bridge only
- wall access pass thru
- locking door available, specify and add \$123 list

Freestanding Low Console Return	18	83	15 ¾	200	18	AP3-RCS-6-1883R	\$4,501
	18	83	15 ¾	200	18	AP3-RCS-6-1883L	\$4,501
	18	77	15 ¾	190	17	AP3-RCS-6-1877R	\$3,995
	18	77	15 ¾	190	17	AP3-RCS-6-1877L	\$3,995

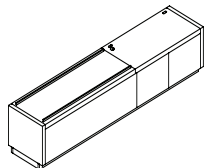

left shown

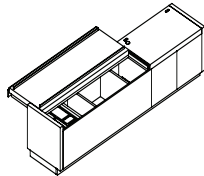

- 83" w console return must be used with 36" d console desk
- 77" w console return must be used with 30" d console desk
- includes electrical power unit with two power outlets, one each CAT6 data and phone jack, 10' long power cord and 14' long phone and data cords
- includes bright white charging tray and bright white organizer tray with felt liner
- hinge door unit for wire access only
- surface grommet
- sliding top locking
- locking doors available, specify and add \$123 list

**To Order, Specify:**

**Desk**

- ① Model Number
- ② Wood Species on Top/Veneer Wrapped Apron - Makore (MK2), Maple (MA2), Walnut (WA2) or Double Cut (DC1) (see page 62)
- ③ Finish Color for Top/Veneer Wrapped Apron (see page 62)
- ④ Leg Accent Finish
  - a.) Same as Top
  - b.) Paint (see page 62)

- ⑤ Finish Color for Post Panel
  - a.) Same as Top
  - b.) Paint (see page 62)
- ⑥ Metal Open Frame Color or Metal Post Accent Color (see page 62)
- ⑦ Finish Color for Modesty Panel:
  - a.) Same as Top
  - b.) Same as Chassis/Drawer Fronts or Paint Color (see page 62)

Note: Only one wood finish and one paint color can be specified per unit

**To Order, Specify:**

**Console**

- ① Model Number
- ② Species on Chassis/Drawers/Doors - Makore (MK2), Maple (MA2), Walnut (WA2), Double Cut (DC1) or Paint (PNT) (see page 62)
- ③ Finish Color for Chassis/Drawers/Doors (see page 62)
- ④ Finish Color for Base
  - a.) Same as Chassis/Drawers/Doors
  - b.) Paint (see page 62)

Description	D	W	H	CTN WT	CU FT	① Model	List Price
-------------	---	---	---	-----------	----------	---------	------------

<b>Meeting Table</b>	36	84	29½	174	61	<b>AP8-MTL-1-3684</b>	<b>\$2,981</b>
----------------------	----	----	-----	-----	----	-----------------------	----------------

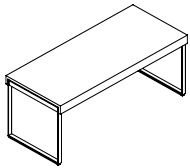

- veneer top with veneer wrapped apron
- straight apron both sides
- top long grain veneer direction
- grommet available, specify and add \$99 list each; see page 50 for diagram G1
- kneespace height: 25 ½"
- kneespace width between legs: 80"

<b>Bridge Top</b>	22	56	1⅝	42	3	<b>AP3-BTU-1-2256</b>	<b>\$1,131</b>
-------------------	----	----	----	----	---	-----------------------	----------------

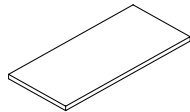

	22	50	1⅝	38	3	<b>AP3-BTU-1-2250</b>	<b>\$1,111</b>
	22	44	1⅝	34	3	<b>AP3-BTU-1-2244</b>	<b>\$1,093</b>

- short grain veneer direction
- flat bracket connectors included
- for mounting to open frame table desk order 6-AB angle bracket, see page 173
- grommet available, specify and add \$99 list each; see page 51

<b>Bridge with Modesty Panel</b>	22	56	29½	77	13	<b>AP3-BMR-1-2256</b>	<b>\$1,785</b>
----------------------------------	----	----	-----	----	----	-----------------------	----------------

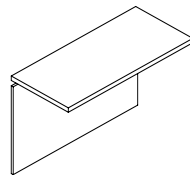

	22	50	29½	69	12	<b>AP3-BMR-1-2250</b>	<b>\$1,745</b>
	22	44	29½	61	10	<b>AP3-BMR-1-2244</b>	<b>\$1,707</b>

- top short grain veneer direction
- finished, removable inset back panel
- cannot be used with AM7-CSP-1-2206 or AM7-CSP-1-1506 end support
- adjustable levelers/glides
- grommet available, specify and add \$99 list each; see page 51
- kneespace height: 28 ¼"

Description	D	W	H	CTN WT	CU FT	① Model	List Price
Return with Flush Base	22	60	29 ½	179	28	AP3-RTP-1-2260R	\$2,910
	22	60	29 ½	179	28	AP3-RTP-1-2260L	\$2,910
	22	54	29 ½	169	25	AP3-RTP-1-2254R	\$2,861
	22	54	29 ½	169	25	AP3-RTP-1-2254L	\$2,861
	22	48	29 ½	158	23	AP3-RTP-1-2248R	\$2,808
	22	48	29 ½	158	23	AP3-RTP-1-2248L	\$2,808

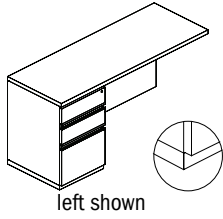

- base on pedestal is flush
- 15 ½" w utility/box/file pedestal
- utility drawer with box drawer front
- soft close utility/box/file drawers
- pedestal front locking
- top short grain veneer direction
- adjustable levelers/glides
- grommet available, specify and add \$99 list each; see page 51
- kneespace height: 28 ¼"
- -2260 kneespace width: 44 ½"
- -2254 kneespace width: 38 ½"
- -2248 kneespace width: 32 ½"

Return with Inset Base	22	60	29 ½	176	28	AP3-RTP-1R-2260R	\$2,910
	22	60	29 ½	176	28	AP3-RTP-1L-2260L	\$2,910
	22	54	29 ½	165	25	AP3-RTP-1R-2254R	\$2,861
	22	54	29 ½	165	25	AP3-RTP-1L-2254L	\$2,861
	22	48	29 ½	155	23	AP3-RTP-1R-2248R	\$2,808
	22	48	29 ½	155	23	AP3-RTP-1L-2248L	\$2,808

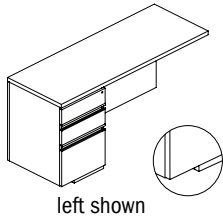

- base on pedestal is inset on one side
- 15 ½" w utility/box/file pedestal
- utility drawer with box drawer front
- soft close utility/box/file drawers
- pedestal front locking
- top short grain veneer direction
- adjustable levelers/glides
- grommet available, specify and add \$99 list each; see page 51
- kneespace height: 28 ¼"
- -2260 kneespace width: 44 ½"
- -2254 kneespace width: 38 ½"
- -2248 kneespace width: 32 ½"

**To Order, Specify:**

- ① Model Number
- ② Wood Species on Top/Veneer Wrapped Apron - Makore (MK2), Maple (MA2), Walnut (WA2) or Double Cut (DC1) (see page 62)
- ③ Finish Color for Top/Veneer Wrapped Apron (see page 62)
- ④ Chassis/Drawer Fronts Finish:
  - a.) Same as Top
  - b.) Paint (see page 62)
- ⑤ Leg Accent Finish
  - a.) Same as Top
  - b.) Paint (see page 62)

**Product Modifications:**

Pedestal Change - see page 39

- ⑥ Finish Color for Base
  - a.) Same as Top
  - b.) Paint (see page 62)
- ⑦ Metal Open Frame Color (see page 62)
- ⑧ Bridge Modesty Panel Finish:
  - a.) Same as Top
  - b.) Paint (see page 62)

Note: Only one wood finish and one paint color can be specified per unit

APOGEE™

Description	D	W	H	CTN WT	CU FT	① Model	List Price
Lateral File Return with Flush Base	22	72	29½	249	33	AP3-RTL-1-2272R	\$3,601
	22	72	29½	249	33	AP3-RTL-1-2272L	\$3,601
	22	66	29½	220	31	AP3-RTL-1-2266R	\$3,551
	22	66	29½	220	31	AP3-RTL-1-2266L	\$3,551
	22	60	29½	210	28	AP3-RTL-1-2260R	\$3,499
	22	60	29½	210	28	AP3-RTL-1-2260L	\$3,499

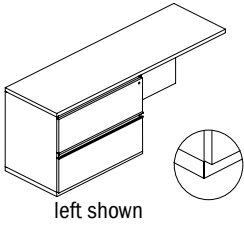

- base on pedestal is flush
- top short grain veneer direction
- pedestal front locking
- adjustable levelers/glides
- grommet available, specify and add \$99 list each; see page 51
- kneespace height: 28 ¼"
- -2272 lateral files: 36"w
- -2266 or -2260 lateral files: 30"w
- -2272 & -2266 kneespace width: 36"
- -2260 kneespace width: 30"

Lateral File Return with Inset Base	22	72	29½	246	33	AP3-RTL-1R-2272R	\$3,601
	22	72	29½	246	33	AP3-RTL-1L-2272L	\$3,601
	22	66	29½	217	31	AP3-RTL-1R-2266R	\$3,551
	22	66	29½	217	31	AP3-RTL-1L-2266L	\$3,551
	22	60	29½	207	28	AP3-RTL-1R-2260R	\$3,499
	22	60	29½	207	28	AP3-RTL-1L-2260L	\$3,499

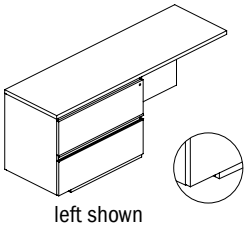

- base on pedestal is inset on one side
- top short grain veneer direction
- pedestal front locking
- adjustable levelers/glides
- grommet available, specify and add \$99 list each; see page 51
- kneespace height: 28 ¼"
- -2272 lateral files: 36"w
- -2266 or -2260 lateral files: 30"w
- -2272 & -2266 kneespace width: 36"
- -2260 kneespace width: 30"



Description	D	W	H	CTN WT	CU FT	① Model	List Price
Return Shell	22	72	29 ½	149	33	AP3-RTS-1-2272R	\$2,271
	22	72	29 ½	149	33	AP3-RTS-1-2272L	\$2,271
	22	66	29 ½	138	31	AP3-RTS-1-2266R	\$2,195
	22	66	29 ½	138	31	AP3-RTS-1-2266L	\$2,195
	22	60	29 ½	128	28	AP3-RTS-1-2260R	\$2,120
	22	60	29 ½	128	28	AP3-RTS-1-2260L	\$2,120

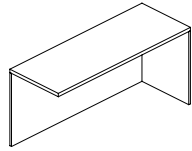

right shown

- use with end panel desk
- top short grain veneer direction
- finished back panel
- adjustable levelers/glides
- grommet available, specify and add \$99 list each; see page 51
- kneespace height: 28 ¼"

Return Shell with Wall Access Panel	22	72	29 ½	158	15	AP3-RTS-8-2272R	\$3,753
	22	72	29 ½	158	15	AP3-RTS-8-2272L	\$3,753
	22	66	29 ½	148	14	AP3-RTS-8-2266R	\$3,564
	22	66	29 ½	148	14	AP3-RTS-8-2266L	\$3,564
	22	60	29 ½	137	13	AP3-RTS-8-2260R	\$3,372
	22	60	29 ½	137	13	AP3-RTS-8-2260L	\$3,372

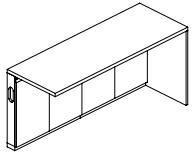

right shown

- use with access panel desk
- top short grain veneer direction
- access for outlets 18"-24" AFF (Above Finished Floor)
- wire pass thru holes
- hinge doors
- due to back construction unit is intended to sit against wall for wall access
- adjustable levelers/glides
- grommet available, specify and add \$99 list each; see page 51
- kneespace height: 28 ¼"

**To Order, Specify:**

- ① Model Number
- ② Wood Species on Top - Makore (MK2), Maple (MA2) Walnut (WA2) or Double Cut (DC1) (see page 62)
- ③ Finish Color for Top (see page 62)
- ④ Finish Color for Chassis/Drawer Fronts
  - a.) Same as Top
  - b.) Paint Color (see page 62)
- ⑤ Finish Color for Base
  - a.) Same as Top
  - b.) Same as Chassis/Drawer Fronts or Paint (see page 62)

Note: Only one wood finish and one paint color can be specified per unit

Description	D	W	H	CTN WT	CU FT	① Model	List Price
<b>Storage Credenza with Flush Base</b>	22	72	29½	377	33	<b>AP2-DSN-1-2272</b>	<b>\$6,084</b>

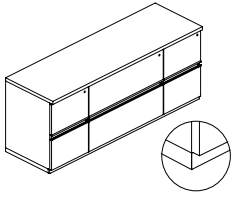

- base is flush
- top long grain veneer direction
- pedestal front locking
- two 36" w lateral files
- four 18" w file/file pedestals
- 18" w soft close file/file drawers
- adjustable levelers/glides

<b>Storage Credenza with Inset Base</b>	22	72	29½	370	33	<b>AP2-DSN-B-2272</b>	<b>\$6,084</b>
---	----	----	-----	-----	----	-----------------------	----------------

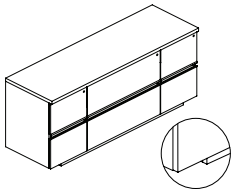

- base is inset on both sides
- top long grain veneer direction
- pedestal front locking
- two 36" w lateral files
- four 18" w file/file pedestals
- 18" w soft close file/file drawers
- adjustable levelers/glides

<b>Storage Credenza with Flush Base</b>	22	72	29½	347	33	<b>AP2-HPD-1-2272</b>	<b>\$5,545</b>
	22	60	29½	303	28	<b>AP2-HPD-1-2260</b>	<b>\$5,418</b>

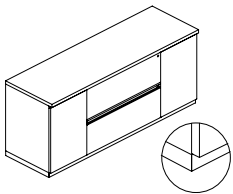

- base is flush
- top long grain veneer direction
- pedestal front locking
- locking doors available, specify and add \$246 list
- soft close hinge doors
- door top has concealed bevel for opening
- adjustable levelers/glides
- grommet available, specify and add \$99 list each; see page 51
- -2272 two hinged door compartments with adjustable shelf, 18" w
- -2272 two 36" w lateral files
- -2260 two hinged door compartments with adjustable shelf, 15" w
- -2260 two 30" w lateral files

<b>Storage Credenza with Inset Base</b>	22	72	29½	340	33	<b>AP2-HPD-B-2272</b>	<b>\$5,545</b>
	22	60	29½	297	28	<b>AP2-HPD-B-2260</b>	<b>\$5,418</b>

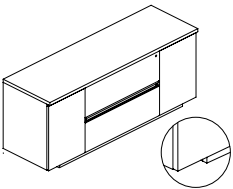

- base is inset on both sides
- top long grain veneer direction
- pedestal front locking
- locking doors available, specify and add \$246 list
- soft close hinge doors
- door top has concealed bevel for opening
- adjustable levelers/glides
- grommet available, specify and add \$99 list each; see page 51
- -2272 two hinged door compartments with adjustable shelf, 18" w
- -2272 two 36" w lateral files
- -2260 two hinged door compartments with adjustable shelf, 15" w
- -2260 two 30" w lateral files

Description	D	W	H	CTN WT	CU FT	① Model	List Price
Lateral File Credenza with Flush Base	22	72	29 ½	360	33	AP2-DST-1-2272	\$5,768
	22	60	29 ½	297	28	AP2-DST-1-2260	\$5,641

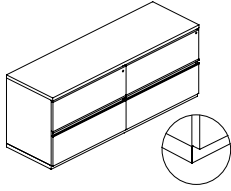

- base is flush
- top long grain veneer direction
- pedestal front locking
- adjustable levelers/ glides
- -2272 four 36" w lateral files
- -2260 four 30" w lateral files

Lateral File Credenza with Inset Base	22	72	29 ½	353	33	AP2-DST-B-2272	\$5,768
	22	60	29 ½	296	28	AP2-DST-B-2260	\$5,641

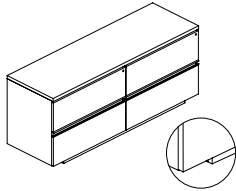

- base is inset on both sides
- top long grain veneer direction
- pedestal front locking
- adjustable levelers/ glides
- -2272 four 36" w lateral files
- -2260 four 30" w lateral files

APOGEE™

**To Order, Specify:**

- ① Model Number
- ② Wood Species on Top - Makore (MK2), Maple (MA2) Walnut (WA2) or Double Cut (DC1) (see page 62)
- ③ Finish Color for Top (see page 62)
- ④ Finish Color for Chassis/Drawer Fronts
  - a.) Same as Top
  - b.) Paint (see page 62)
- ⑤ Finish Color for Base
  - a.) Same as Top
  - b.) Same as Chassis/Drawer Fronts or Paint (see page 62)

Note: Only one wood finish and one paint color can be specified per unit

**Product Modifications:**

Pedestal Change - see page 39

Description	D	W	H	CTN WT	CU FT	① Model	List Price
<b>Open Corner Credenza with Flush Base</b>	22	72	29½	208	33	AP2-OCP-1-2272R	\$3,524
	22	72	29½	208	33	AP2-OCP-1-2272L	\$3,524
	22	66	29½	193	31	AP2-OCP-1-2266R	\$3,448
	22	66	29½	193	31	AP2-OCP-1-2266L	\$3,448
	22	60	29½	185	28	AP2-OCP-1-2260R	\$3,372
	22	60	29½	185	28	AP2-OCP-1-2260L	\$3,372

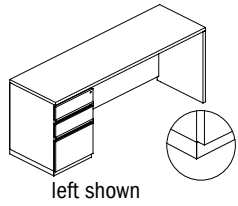

- base on pedestal is flush
- top long grain veneer direction
- pedestal front locking
- soft close utility/box/file drawers
- adjustable levelers/glides
- grommet available, specify and add \$99 list each; see page 51
- kneespace height: 28 ¼"
- -2272 utility/box/file pedestal, 18"w
- -2260 utility/box/file pedestal, 15 ½"w
- -2272 kneespace width: 52 ¾"
- -2266 kneespace width: 49 ¼"
- -2260 kneespace width: 43 ¼"

<b>Open Corner Credenza with Inset Base</b>	22	72	29½	204	33	AP2-OCP-1R-2272R	\$3,524
	22	72	29½	204	33	AP2-OCP-1L-2272L	\$3,524
	22	66	29½	190	31	AP2-OCP-1R-2266R	\$3,448
	22	66	29½	190	31	AP2-OCP-1L-2266L	\$3,448
	22	60	29½	181	28	AP2-OCP-1R-2260R	\$3,372
	22	60	29½	181	28	AP2-OCP-1L-2260L	\$3,372

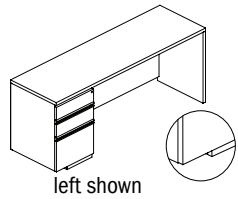

- base on pedestal is inset on one side
- top long grain veneer direction
- pedestal front locking
- soft close utility/box/file drawers
- adjustable levelers/glides
- grommet available, specify and add \$99 list each; see page 51
- kneespace height: 28 ¼"
- -2272 utility/box/file pedestal, 18"w
- -2260 utility/box/file pedestal, 15 ½"w
- -2272 kneespace width: 52 ¾"
- -2266 kneespace width: 49 ¼"
- -2260 kneespace width: 43 ¼"

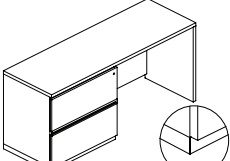
Description	D	W	H	CTN WT	CU FT	① Model	List Price
<b>Open Corner Lateral File Credenza with Flush Base</b>  left shown	22	72	29 ½	257	33	AP2-OCL-1-2272R	\$3,930
	22	72	29 ½	257	33	AP2-OCL-1-2272L	\$3,930
	22	66	29 ½	229	31	AP2-OCL-1-2266R	\$3,854
	22	66	29 ½	229	31	AP2-OCL-1-2266L	\$3,854
	22	60	29 ½	217	28	AP2-OCL-1-2260R	\$3,777
	22	60	29 ½	217	28	AP2-OCL-1-2260L	\$3,777

- base on pedestal is flush
- top long grain veneer direction
- pedestal front locking
- adjustable levelers/glides
- grommet available, specify and add \$99 list each; see page 51
- kneespace height: 28 ¼"
- -2272 file/file pedestal, 36"w
- -2266 & -2260 file/file pedestal, 30"w
- -2272 or -2266 kneespace width: 34 ⅞"
- -2260 kneespace width: 28 ⅞"

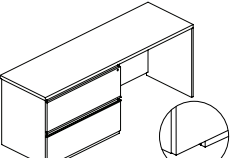
<b>Open Corner Lateral File Credenza with Inset Base</b>  left shown	22	72	29 ½	254	33	AP2-OCL-1R-2272R	\$3,930
	22	72	29 ½	254	33	AP2-OCL-1L-2272L	\$3,930
	22	66	29 ½	225	31	AP2-OCL-1R-2266R	\$3,854
	22	66	29 ½	225	31	AP2-OCL-1L-2266L	\$3,854
	22	60	29 ½	214	28	AP2-OCL-1R-2260R	\$3,777
	22	60	29 ½	214	28	AP2-OCL-1L-2260L	\$3,777

- base on pedestal is inset on one side
- top long grain veneer direction
- pedestal front locking
- adjustable levelers/glides
- grommet available, specify and add \$99 list each; see page 51
- kneespace height: 28 ¼"
- -2272 file/file pedestal, 36"w
- -2266 & -2260 file/file pedestal, 30"w
- -2272 or -2266 kneespace width: 34 ⅞"
- -2260 kneespace width: 28 ⅞"

**To Order, Specify:**

- ① Model Number
- ② Wood Species on Top - Makore (MK2), Maple (MA2) Walnut (WA2) or Double Cut (DC1) (see page 62)
- ③ Finish Color for Top (see page 62)
- ④ Finish Color for Chassis/Drawer Fronts
  - a.) Same as Top
  - b.) Paint (see page 62)
- ⑤ Finish Color for Base
  - a.) Same as Top
  - b.) Same as Chassis/Drawer Fronts or Paint (see page 62)

Note: Only one wood finish and one paint color can be specified per unit

**Product Modifications:**

Pedestal Change - see page 39

APOGEE™

Description	D	W	H	CTN WT	CU FT	① Model	List Price
Open Corner Credenza with Flush Base	22	84	29½	354	39	AP2-OBL-1-2284R	\$5,576
	22	84	29½	354	39	AP2-OBL-1-2284L	\$5,576
	22	78	29½	345	36	AP2-OBL-1-2278R	\$5,514
	22	78	29½	345	36	AP2-OBL-1-2278L	\$5,514

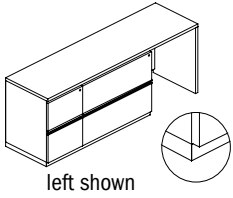

left shown

- base is flush
- top long grain veneer direction
- pedestal front locking
- 18" w file/file pedestal
- 36" w lateral file
- 18" w soft close file/file drawers
- adjustable levelers/glides
- grommet available, specify and add \$99 list each; see page 51
- kneespace height: 28 ¼"
- -2284 kneespace width: 28 7/8"
- -2278 kneespace width: 22 7/8"

Open Corner Credenza with Inset Base	22	84	29½	350	39	AP2-OBL-1R-2284R	\$5,576
	22	84	29½	350	39	AP2-OBL-1L-2284L	\$5,576
	22	78	29½	342	36	AP2-OBL-1R-2278R	\$5,514
	22	78	29½	342	36	AP2-OBL-1L-2278L	\$5,514

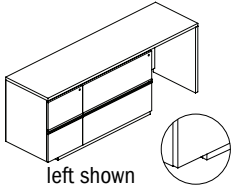

left shown

- base is inset on one side
- top long grain veneer direction
- pedestal front locking
- 18" w file/file pedestal
- 36" w lateral file
- 18" w soft close file/file drawers
- adjustable levelers/glides
- grommet available, specify and add \$99 list each; see page 51
- kneespace height: 28 ¼"
- -2284 kneespace width: 28 7/8"
- -2278 kneespace width: 22 7/8"

Freestanding

Description	D	W	H	CTN WT	CU FT	① Model	List Price
Two-High Lateral File with Flush Base	22	36	29 ½	182	17	AP6-FLS-1R-2236	\$2,917
	22	30	29 ½	154	14	AP6-FLS-1-2230	\$2,853

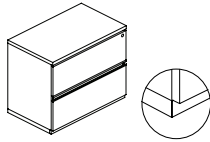

- base is flush
- top long grain veneer direction
- pedestal front locking
- adjustable levelers/glides

Two-High Lateral File with Inset Base	22	36	29 ½	179	17	AP6-FLS-1R-2236R	\$2,917
	22	36	29 ½	179	17	AP6-FLS-1L-2236L	\$2,917
	22	30	29 ½	150	14	AP6-FLS-1R-2230R	\$2,853
	22	30	29 ½	150	14	AP6-FLS-1L-2230L	\$2,853

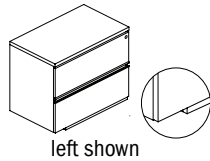

- base is inset on one side
- top long grain veneer direction
- pedestal front locking
- adjustable levelers/glides

One-High Lateral File with Flush Base	22	36	16 ⅞	131	10	AP6-FLA-1R-2236	\$2,221
	22	30	16 ⅞	111	9	AP6-FLA-1-2230	\$2,157

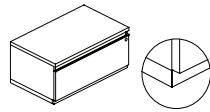

- base is flush
- top long grain veneer direction
- pedestal front locking
- adjustable levelers/glides

One-High Lateral File with Inset Base	22	36	16 ⅞	128	10	AP6-FLA-1R-2236R	\$2,221
	22	36	16 ⅞	128	10	AP6-FLA-1L-2236L	\$2,221
	22	30	16 ⅞	107	9	AP6-FLA-1R-2230R	\$2,157
	22	30	16 ⅞	107	9	AP6-FLA-1L-2230L	\$2,157

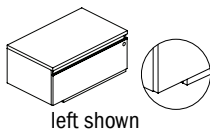

- base is inset on one side
- top long grain veneer direction
- pedestal front locking
- adjustable levelers/glides

To Order, Specify:

- Model Number
- Wood Species on Top - Makore (MK2), Maple (MA2) Walnut (WA2) or Double Cut (DC1) (see page 62)
- Finish Color for Top (see page 62)
- Finish Color for Chassis/Drawer Fronts
  - Same as Top
  - Paint (see page 62)
- Finish Color for Base
  - Same as Top
  - Same as Chassis/Drawer Fronts or Paint (see page 62)

Note: Only one wood finish and one paint color can be specified per unit

Product Modifications:

Pedestal Change - see page 39

Modular

Description	D	W	H	CTN WT	CU FT	① Model	List Price
Two-High Lateral File with Flush Base	22	72	28 3/8	307	32	AM7-FLS-1-2272	\$4,247
	22	60	28 3/8	253	27	AM7-FLS-1-2260	\$4,121

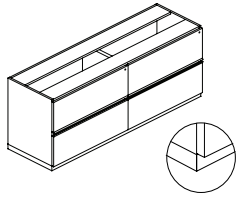

- without top
- base is flush
- pedestal front locking
- adjustable levelers/glides
- modular top required, see page 89
- -2272 four 36" w lateral files
- -2260 four 30" w lateral files

Two-High Lateral File with Inset Base	22	72	28 3/8	304	32	AM7-FLS-1R-2272R	\$4,247
	22	72	28 3/8	304	32	AM7-FLS-1L-2272L	\$4,247
	22	60	28 3/8	250	27	AM7-FLS-1R-2260R	\$4,121
	22	60	28 3/8	250	27	AM7-FLS-1L-2260L	\$4,121

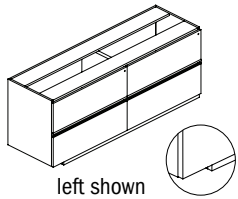

- without top
- base is inset on one side
- pedestal front locking
- adjustable levelers/glides
- modular top required, see page 89
- -2272 four 36" w lateral files
- -2260 four 30" w lateral files

Two-High Lateral File with Flush Base	22	36	28 3/8	157	17	AM7-FLS-1-2236	\$2,321
	22	30	28 3/8	129	14	AM7-FLS-1-2230	\$2,258

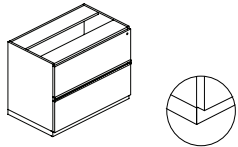

- without top
- base is flush
- pedestal front locking
- adjustable levelers/glides
- modular top required, see page 89

Two-High Lateral File with Inset Base	22	36	28 3/8	153	17	AM7-FLS-1R-2236R	\$2,321
	22	36	28 3/8	153	17	AM7-FLS-1L-2236L	\$2,321
	22	30	28 3/8	126	14	AM7-FLS-1R-2230R	\$2,258
	22	30	28 3/8	126	14	AM7-FLS-1L-2230L	\$2,258

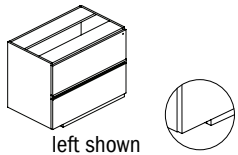

- without top
- base is inset on one side
- pedestal front locking
- adjustable levelers/glides
- modular top required, see page 89

APOGEE™

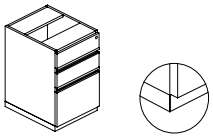
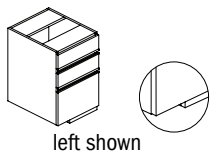
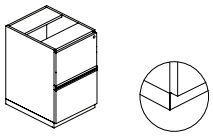
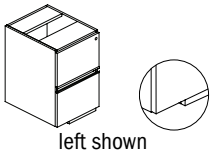

**Modular**

Description	D	W	H	CTN WT	CU FT	① Model	List Price
<b>Utility/Box/File Pedestal with Flush Base</b>  <ul style="list-style-type: none"> <li>without top</li> <li>base is flush</li> <li>utility drawer with box drawer front</li> <li>pedestal front locking</li> <li>soft close drawers</li> <li>adjustable levelers/glides</li> <li>modular top required, see page 89</li> </ul>	22	18	28 3/8	95	9	<b>AM7-PUN-1-2218</b>	<b>\$1,504</b>
<b>Utility/Box/File Pedestal with Inset Base</b>  <p>left shown</p> <ul style="list-style-type: none"> <li>without top</li> <li>base is inset on one side</li> <li>utility drawer with box drawer front</li> <li>pedestal front locking</li> <li>soft close drawers</li> <li>adjustable levelers/glides</li> <li>modular top required, see page 89</li> </ul> <p>Note: not a stand alone unit</p>	22	18	28 3/8	92	9	<b>AM7-PUN-1R-2218R</b>	<b>\$1,504</b>
	22	18	28 3/8	92	9	<b>AM7-PUN-1L-2218L</b>	<b>\$1,504</b>
<b>File/File Pedestal with Flush Base</b>  <ul style="list-style-type: none"> <li>without top</li> <li>base is flush</li> <li>pedestal front locking</li> <li>soft close drawers</li> <li>adjustable levelers/glides</li> <li>modular top required, see page 89</li> </ul>	22	18	28 3/8	95	9	<b>AM7-PUN-M-2218</b>	<b>\$1,504</b>
<b>File/File Pedestal with Inset Base</b>  <p>left shown</p> <ul style="list-style-type: none"> <li>without top</li> <li>base is inset on one side</li> <li>pedestal front locking</li> <li>soft close drawers</li> <li>adjustable levelers/glides</li> <li>modular top required, see page 89</li> </ul> <p>Note: not a stand alone unit</p>	22	18	28 3/8	92	9	<b>AM7-PUN-MR-2218R</b>	<b>\$1,504</b>
	22	18	28 3/8	92	9	<b>AM7-PUN-ML-2218L</b>	<b>\$1,504</b>

**To Order, Specify:**

- ① Model Number
- ② Wood Species/Paint on Chassis/Drawer Fronts -  
Makore (MK2), Maple (MA2), Walnut (WA2),  
Double Cut (DC1) or Paint (PNT)  
(see page 62)
- ③ Finish Color for Chassis/Drawer Fronts  
(see page 62)
- ④ Finish Color for Base
  - a.) Same as Chassis/Drawer Fronts
  - b.) Paint (see page 62)

Note: Only one wood finish and one paint color can be specified per unit

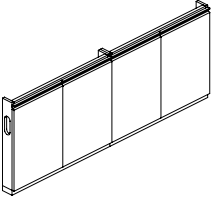
Description	D	W	H	CTN WT	CU FT	① Model	List Price
Kneespace Access Panel, Full Height 	4	72	28 3/8	80	8	AM7-PAP-1-0472	\$2,397
	4	66	28 3/8	74	7	AM7-PAP-1-0466	\$2,207
	4	60	28 3/8	69	7	AM7-PAP-1-0460	\$2,018
	4	54	28 3/8	64	6	AM7-PAP-1-0454	\$1,890
	4	48	28 3/8	58	5	AM7-PAP-1-0448	\$1,763
	4	42	28 3/8	46	5	AM7-PAP-1-0442	\$1,637
	4	36	28 3/8	40	4	AM7-PAP-1-0436	\$1,512
	4	30	28 3/8	34	3	AM7-PAP-1-0430	\$1,385
	4	24	28 3/8	29	3	AM7-PAP-1-0424	\$1,258

- hinge doors
- wire pass thru to allow access to the next unit
- access for outlets 18"-24" AFF (Above Finished Floor)
- cantilever bracket included
- adjustable levelers/glides
- due to back construction unit is intended to sit against wall for wall access
- recommend wall attachment

End Support	22	6	28 3/8	49	3	AM7-CSP-1-2206	\$1,314
	15	6	28 3/8	34	2	AM7-CSP-1-1506	\$1,176

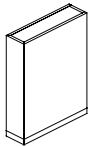

- use with modular components at the end of a run
- attachment bracket included
- non-handed, requires field boring for hardware
- adjustable levelers/glides

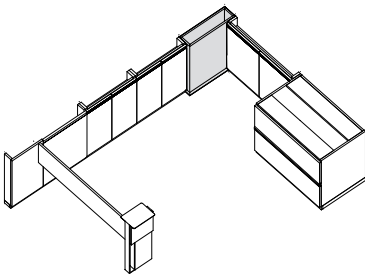

End Panel Transition to Access Panel	22	6	28 3/8	45	4	AM7-EPT-1-2206	\$1,461
	15	6	28 3/8	41	3	AM7-EPT-1-1506	\$1,263

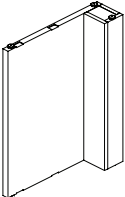

- creates the transition from 1 1/8" panel to 6" thick access panel
- top attachment hardware included
- non-handed, bored for left or right applications
- adjustable levelers/glides

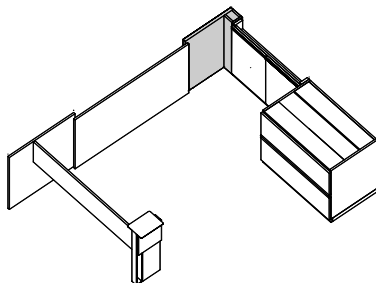

Description	D	W	H	CTN WT	CU FT	① Model	List Price
One-High Lateral File with Flush Base	22	72	15 ¾	205	19	AM7-FLA-1-2272	\$3,234
	22	60	15 ¾	170	16	AM7-FLA-1-2260	\$3,106

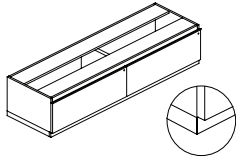

- without top
- base is flush
- pedestal front locking
- adjustable levelers/glides
- modular top required, see page 89

One-High Lateral File with Inset Base	22	72	15 ¾	202	19	AM7-FLA-1R-2272R	\$3,234
	22	72	15 ¾	202	19	AM7-FLA-1L-2272L	\$3,234
	22	60	15 ¾	166	16	AM7-FLA-1R-2260R	\$3,106
	22	60	15 ¾	166	16	AM7-FLA-1L-2260L	\$3,106

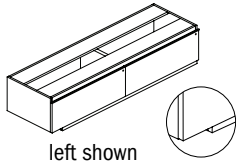

- without top
- base is inset on one side
- pedestal front locking
- adjustable levelers/glides
- modular top required, see page 89

One-High Lateral File with Flush Base	22	36	15 ¾	105	10	AM7-FLA-1-2236	\$1,751
	22	30	15 ¾	87	8	AM7-FLA-1-2230	\$1,687

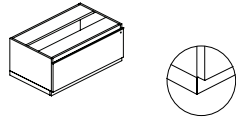

- without top
- base is flush
- pedestal front locking
- adjustable levelers/glides
- modular top required, see page 89

One-High Lateral File with Inset Base	22	36	15 ¾	102	10	AM7-FLA-1R-2236R	\$1,751
	22	36	15 ¾	102	10	AM7-FLA-1L-2236L	\$1,751
	22	30	15 ¾	84	8	AM7-FLA-1R-2230R	\$1,687
	22	30	15 ¾	84	8	AM7-FLA-1L-2230L	\$1,687

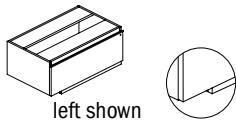

- without top
- base is inset on one side
- pedestal front locking
- adjustable levelers/glides
- modular top required, see page 89

**To Order, Specify:**

- ① Model Number
- ② Wood Species/Paint on Chassis/Drawer Fronts -  
Makore (MK2), Maple (MA2), Walnut (WA2),  
Double Cut (DC1) or Paint (PNT)  
(see page 62)
- ③ Finish Color for Chassis/Drawer Fronts  
(see page 62)
- ④ Finish Color for Base
  - a.) Same as Chassis/Drawer Front
  - b.) Paint (see page 62)

Note: Only one wood finish and one paint color can be specified per unit

Description	D	W	H	CTN WT	CU FT	① Model	List Price
One-High Pedestal with Flush Base	22	18	15 ¾	62	5	AM7-PUA-1-2218	\$1,226

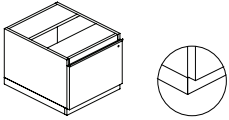

- without top
- base is flush
- soft close file drawer
- pedestal front locking
- adjustable levelers/glides
- modular top required, see page 89

APOGEE™

One-High Pedestal with Inset Base	22	18	15 ¾	58	5	AM7-PUA-1R-2218R	\$1,226
	22	18	15 ¾	58	5	AM7-PUA-1L-2218L	\$1,226

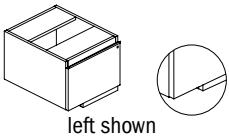

- without top
- base is inset on one side
- soft close file drawer
- pedestal front locking
- adjustable levelers/glides
- modular top required, see page 89

note: not a stand alone unit

Description	D	W	H	CTN WT	CU FT	① Model	List Price
Kneespace Access Panel, Partial Height with Workwall Top	22	108	12 5/8	135	24	AM7-WTP-1-22108	\$4,044
	22	90	12 5/8	114	20	AM7-WTP-1-2290	\$3,829

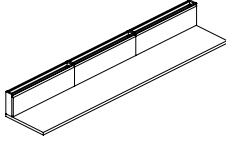

- use with one-high pedestals
- internal wire pass thru
- cantilever bracket included
- recommend wall attachment
- required access outlet 24" AFF (Above Finished Floor)

Kneespace Access Panel, Partial Height with Workwall Top	22	72	12 5/8	90	16	AM7-WTP-1-2272	\$3,144
	22	60	12 5/8	76	13	AM7-WTP-1-2260	\$2,930

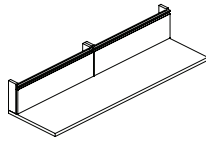

- use with one-high pedestals
- internal wire pass thru
- cantilever bracket included
- recommend wall attachment
- required access outlet 24" AFF (Above Finished Floor)

Kneespace Access Panel, Partial Height with Workwall Top	22	36	12 5/8	45	8	AM7-WTP-1-2236	\$1,866
	22	30	12 5/8	38	7	AM7-WTP-1-2230	\$1,725

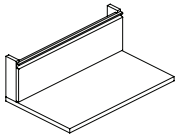

- use with one-high pedestals
- internal wire pass thru
- recommend wall attachment
- required access outlet 24" AFF (Above Finished Floor)

**To Order, Specify:**

**Pedestal**

- ① Model Number
- ② Wood Species/Paint on Chassis/Drawer Front - Makore (MK2), Maple (MA2), Walnut (WA2), Double Cut (DC1) or Paint (PNT) (see page 62)
- ③ Finish Color for Chassis/Drawer Fronts (see page 62)
- ④ Finish Color for Base
  - a.) Same as Chassis/Drawer Front
  - b.) Paint (see page 62)

**Access Panel**

- ① Model Number
- ② Wood Species on Top - Makore (MK2), Maple (MA2), Walnut (WA2) or Double Cut (DC1) (see page 62)
- ③ Finish Color for Top (see page 62)
- ④ Finish Color for Chassis/Door Front
  - a.) Same as Top
  - b.) Paint (see page 62)

Note: Only one wood finish and one paint color can be specified per unit

Description	D	W	H	CTN WT	CU FT	① Model	List Price
22" d Workwall Top with Shuttle Tracks and Access Panels	22	108	12 5/8	142	24	AM7-WTP-SH-22108	\$4,171
	22	90	12 5/8	120	20	AM7-WTP-SH-2290	\$3,937
	22	72	12 5/8	95	16	AM7-WTP-SH-2272	\$3,234
	22	60	12 5/8	80	13	AM7-WTP-SH-2260	\$3,010

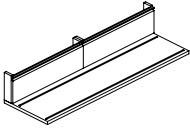

- use with one-high lateral files
- must be used between modular tower units or two-high units
- internal wire pass thru
- cantilever bracket included
- recommend wall attachment
- access outlet 24" AFF (Above Finished Floor)

Storage Shuttle	16	36	10 1/8	26	5	AM9-SHU-9-1636	\$661
	16	30	10 1/8	22	4	AM9-SHU-9-1630	\$650

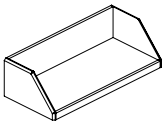

- must use with shuttle top
- available in painted finishes only

Piling Shuttle	16	36	10 1/8	48	5	AM9-SHU-PM-1636	\$1,619
	16	30	10 1/8	37	4	AM9-SHU-PM-1630	\$1,536

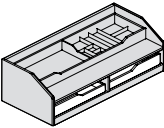

- must use with shuttle top
- shuttle and organizer trays available in painted finishes only
- paper trays available in wood or painted finishes
- -1636 consists of (1) organizer tray and (2) legal paper trays
- -1630 consists of (1) organizer tray and (2) letter paper trays

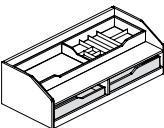

Description	D	W	H	CTN WT	CU FT	① Model	List Price
Kneespace Access Panel with 22"d Extensions, Partial Height with Workwall Top	22	108	12 5/8	150	24	AM7-WTP-EX-22108	\$3,557
	22	90	12 5/8	124	20	AM7-WTP-EX-2290	\$3,342

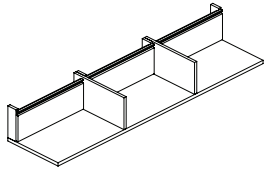

- use with one-high pedestals
- doors flip down for access to the wall
- internal wire pass thru
- access outlet 24" AFF (Above Finished Floor)
- due to back construction unit is intended to sit against wall for wall access
- 22"d extensions

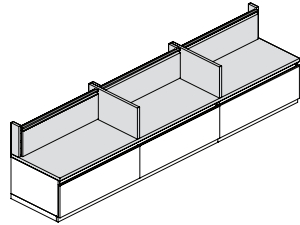

Kneespace Access Panel with 22"d Extensions, Partial Height with Workwall Top	22	72	12 5/8	95	16	AM7-WTP-EX-2272	\$2,910
	22	60	12 5/8	86	13	AM7-WTP-EX-2260	\$2,771

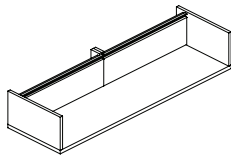

- use with one-high pedestals
- doors flip down for access to the wall
- internal wire pass thru
- access outlet 24" AFF (Above Finished Floor)
- due to back construction unit is intended to sit against wall for wall access
- 22"d extensions

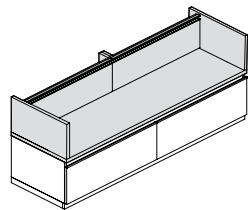

**To Order, Specify:**

- ① Model Number
- ② Wood Species on Top - Makore (MK2), Maple (MA2), Walnut (WA2) or Double Cut (DC1) (see page 62)
- ③ Finish Color for Top (see page 62)
- ④ Finish Color for Chassis/Door Front
  - a.) Same as Top
  - b.) Paint (see page 62)

Note: Only one wood finish and one paint color can be specified per unit

Description	D	W	H	CTN WT	CU FT	① Model	List Price
Kneespace Access Panel with 15"d Extensions, Partial Height with Workwall Top	22	108	12 5/8	145	24	AM7-WTP-ES-22108	\$3,493
	22	90	12 5/8	119	20	AM7-WTP-ES-2290	\$3,278

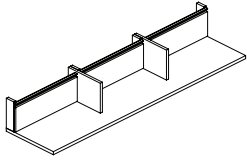

- use with one-high pedestals
- doors flip down for access to the wall
- internal wire pass thru
- access outlet 24" AFF (Above Finished Floor)
- due to back construction unit is intended to sit against wall for wall access
- 15"d extensions

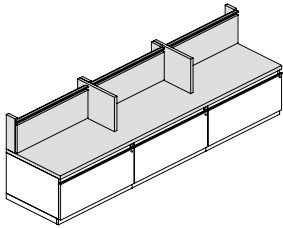

Kneespace Access Panel with 15"d Extensions, Partial Height with Workwall Top	22	72	12 5/8	95	16	AM7-WTP-ES-2272	\$2,848
	22	60	12 5/8	81	13	AM7-WTP-ES-2260	\$2,708

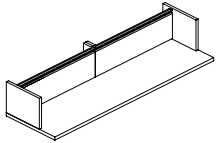

- use with one-high pedestals
- doors flip down for access to the wall
- internal wire pass thru
- access outlet 24" AFF (Above Finished Floor)
- due to back construction unit is intended to sit against wall for wall access
- 15"d extensions

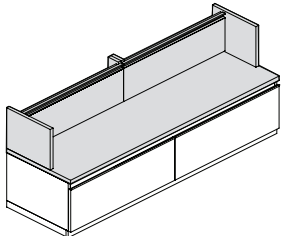

APOGEE™

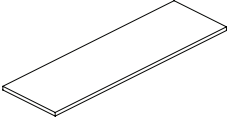

Description	D	W	H	CTN WT	CU FT	① Model	List Price
	22	120	1 1/8	89	7	AM7-WTU-1-22120	\$1,972
	22	114	1 1/8	85	7	AM7-WTU-1-22114	\$1,897
	22	108	1 1/8	80	6	AM7-WTU-1-22108	\$1,821
	22	102	1 1/8	76	6	AM7-WTU-1-22102	\$1,745
	22	96	1 1/8	71	6	AM7-WTU-1-2296	\$1,668
	22	90	1 1/8	67	5	AM7-WTU-1-2290	\$1,592
	22	84	1 1/8	62	5	AM7-WTU-1-2284	\$1,466
	22	78	1 1/8	58	5	AM7-WTU-1-2278	\$1,391
	22	72	1 1/8	53	4	AM7-WTU-1-2272	\$1,314
	22	66	1 1/8	49	4	AM7-WTU-1-2266	\$1,237
	22	60	1 1/8	45	4	AM7-WTU-1-2260	\$1,162
	22	54	1 1/8	40	3	AM7-WTU-1-2254	\$1,085
	22	48	1 1/8	36	3	AM7-WTU-1-2248	\$1,011
	22	42	1 1/8	32	3	AM7-WTU-1-2242	\$994
	22	36	1 1/8	27	2	AM7-WTU-1-2236	\$858
	22	30	1 1/8	23	2	AM7-WTU-1-2230	\$782

· long grain veneer direction

APOGEE™

**To Order, Specify:**

**Access Panel**

- ① Model Number
- ② Wood Species on Top - Makore (MK2), Maple (MA2), Walnut (WA2) or Double Cut (DC1) (see page 62)
- ③ Finish Color for Top (see page 62)
- ④ Finish Color for Chassis/Door Front
  - a.) Same as Top
  - b.) Paint (see page 62)

**Workwall Top**

- ① Model Number
- ② Wood Species - Makore (MK2), Maple (MA2), Walnut (WA2) or Double Cut (DC1) (see page 62)
- ③ Finish Color (see page 62)

Note: Only one wood finish and one paint color can be specified per unit

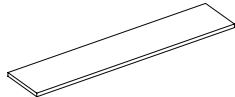
Description	D	W	H	CTN WT	CU FT	① Model	List Price
15"d Workwall Top 	15	120	1 7/8	61	5	AM7-WTU-1-15120	\$1,556
	15	114	1 7/8	58	5	AM7-WTU-1-15114	\$1,504
	15	108	1 7/8	55	4	AM7-WTU-1-15108	\$1,455
	15	102	1 7/8	52	4	AM7-WTU-1-15102	\$1,403
	15	96	1 7/8	49	4	AM7-WTU-1-1596	\$1,353
	15	90	1 7/8	46	4	AM7-WTU-1-1590	\$1,302
	15	84	1 7/8	43	3	AM7-WTU-1-1584	\$1,200
	15	78	1 7/8	40	3	AM7-WTU-1-1578	\$1,150
	15	72	1 7/8	37	3	AM7-WTU-1-1572	\$1,100
	15	66	1 7/8	34	3	AM7-WTU-1-1566	\$1,049
	15	60	1 7/8	31	3	AM7-WTU-1-1560	\$997
	15	54	1 7/8	28	2	AM7-WTU-1-1554	\$948
	15	48	1 7/8	25	2	AM7-WTU-1-1548	\$896
	15	42	1 7/8	22	2	AM7-WTU-1-1542	\$846
	15	36	1 7/8	19	2	AM7-WTU-1-1536	\$795
	15	30	1 7/8	15	1	AM7-WTU-1-1530	\$745

· long grain veneer direction

APOGEE™

Description	D	W	H	CTN WT	CU FT	① Model	List Price
Kneespace Access Panel, Partial Height	4	72	11 ½	33	4	AM7-PAS-1-0472	\$1,967
	4	60	11 ½	29	3	AM7-PAS-1-0460	\$1,751

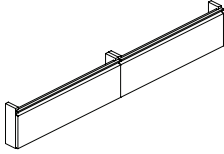

- use with one-high pedestals
- doors flip down for access to the wall
- internal wire pass thru
- cantilever bracket included
- recommended wall attachment
- access outlet 24" AFF (Above Finished Floor)

Kneespace Access Panel, Partial Height	4	36	11 ½	17	2	AM7-PAS-1-0436	\$1,320
	4	30	11 ½	15	2	AM7-PAS-1-0430	\$1,214
	4	18	11 ½	11	1	AM7-PAS-1-0418	\$1,105

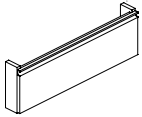

- use with one-high pedestals
- door flips down for access to the wall
- recommended wall attachment
- access outlet 24" AFF (Above Finished Floor)

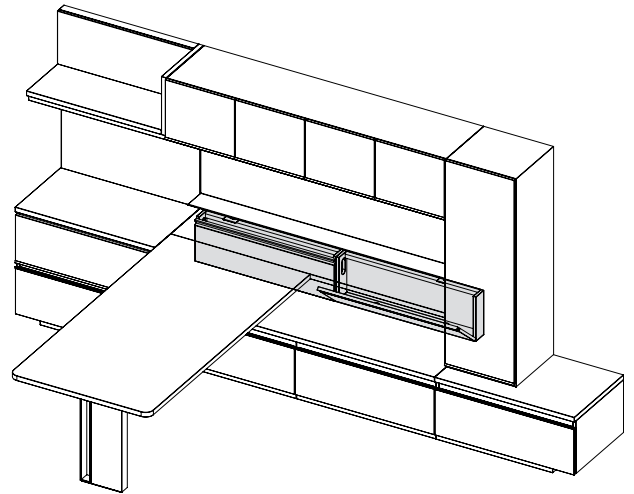

**To Order, Specify:**

**Workwall Top**

- ① Model Number
- ② Wood Species - Makore (MK2), Maple (MA2), Walnut (WA2) or Double Cut (DC1) (see page 62)
- ③ Finish Color (see page 62)

**Access Panel**

- ① Model Number
- ② Wood Species or Paint - Makore (MK2), Maple (MA2), Walnut (WA2), Double Cut (DC1) or Paint (PNT) (see page 62)
- ③ Finish Color (see page 62)

Note: Only one wood finish and one paint color can be specified per unit

Modular

Description	D	W	H	CTN WT	CU FT	① Model	List Price
Kneespace Access Panel with 22"d Extensions, Partial Height	22	72	11½	48	15	AM7-PAS-EX-2272	\$2,633
	22	60	11½	43	15	AM7-PAS-EX-2260	\$2,419

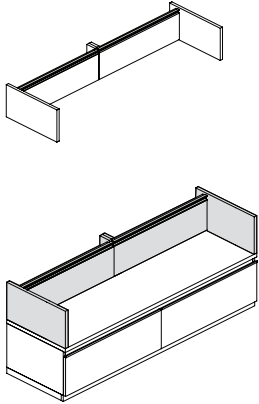

- use with 22"d worksurface top
- use with one-high pedestals with outside support units
- doors flip down for access to the wall
- wire pass thru to allow access to the next unit
- access outlet 24" AFF (Above Finished Floor)
- top mounting brackets included
- due to back construction unit is intended to sit against the wall for wall access

Kneespace Access Panel with 15"d Extensions, Partial Height	15	72	11½	41	11	AM7-PAS-ES-1572	\$2,569
	15	60	11½	36	9	AM7-PAS-ES-1560	\$2,353

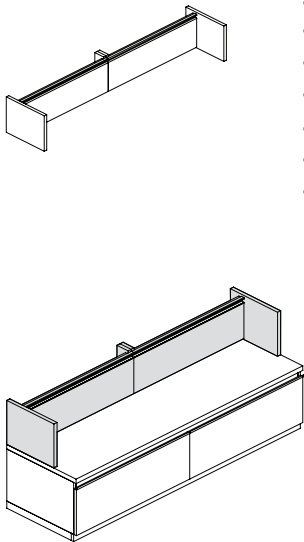

- use with 15"d worksurface top
- use with one-high pedestals with outside support units
- doors flip down for access to the wall
- wire pass thru to allow access to the next unit
- access outlet 24" AFF (Above Finished Floor)
- top mounting brackets included
- due to back construction unit is intended to sit against the wall for wall access

APOGEE™

Modular

Description	D	W	H	CTN WT	CU FT	① Model	List Price
Two-High Run-Off Lateral File Credenza with Flush Base	23	90	29 ½	475	43	AM2-ROC-7-2390R	\$4,139
	23	90	29 ½	475	43	AM2-ROC-7-2390L	\$4,139

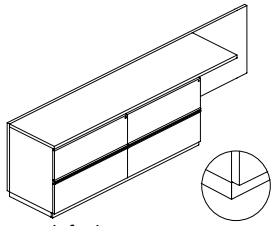

- use with 22" d workwall & kneespace access panel
- base is flush
- four 36" w lateral files
- pedestal front locking
- adjustable levelers/ glides
- grommet available, specify and add \$99 list each; see page 51
- kneespace height: 28 ¼"
- kneespace width: 18"

Two-High Run-Off Lateral File Credenza with Inset Base	23	90	29 ½	472	43	AM2-ROC-7R-2390R	\$4,139
	23	90	29 ½	472	43	AM2-ROC-7L-2390L	\$4,139

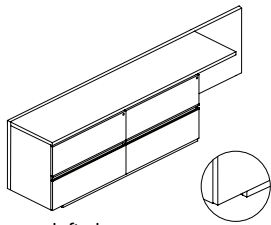

- use with 22" d workwall & kneespace access panel
- base is inset on one side
- four 36" w lateral files
- pedestal front locking
- adjustable levelers/ glides
- grommet available, specify and add \$99 list each; see page 51
- kneespace height: 28 ¼"
- kneespace width: 18"

To Order, Specify:

Access Panel

- ① Model Number
- ② Wood Species or Paint - Makore (MK2), Maple (MA2), Walnut (WA2), Double Cut (DC1) or Paint (PNT) (see page 62)
- ③ Finish Color (see page 62)

Credenza

- ① Model Number
- ② Wood Species on Top - Makore (MK2), Maple (MA2) Walnut (WA2) or Double Cut (DC1) (see page 62)
- ③ Finish Color for Top (see page 62)
- ④ Finish Color for Chassis/Drawer Fronts
  - a.) Same as Top
  - b.) Paint (see page 62)
- ⑤ Finish Color for Base
  - a.) Same as Top
  - b.) Same as Chassis/Drawer Fronts or Paint (see page 62)

Note: Only one wood finish and one paint color can be specified per unit

Description	D	W	H	CTN WT	CU FT	① Model	List Price
Two-High Run-Off Lateral File Credenza with Flush Base	23	72	29½	299	35	AM2-ROC-7-2372R	\$3,761
	23	72	29½	299	35	AM2-ROC-7-2372L	\$3,761
	23	66	29½	261	32	AM2-ROC-7-2366R	\$3,709
	23	66	29½	261	32	AM2-ROC-7-2366L	\$3,709

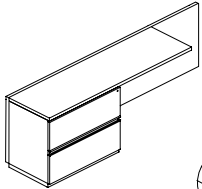

left shown



- use with 22"d workwall & kneespace access panel
- base is flush
- pedestal front locking
- adjustable levelers/glides
- grommet available, specify and add \$99 list each; see page 51
- kneespace height: 28¼"
- kneespace width: 36"
- -2372 lateral files: 36"w
- -2366 lateral files: 30"w

Two-High Run-Off Lateral File Credenza with Inset Base	23	72	29½	295	35	AM2-ROC-7R-2372R	\$3,761
	23	72	29½	295	35	AM2-ROC-7L-2372L	\$3,761
	23	66	29½	258	32	AM2-ROC-7R-2366R	\$3,709
	23	66	29½	258	32	AM2-ROC-7L-2366L	\$3,709

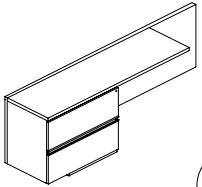

left shown

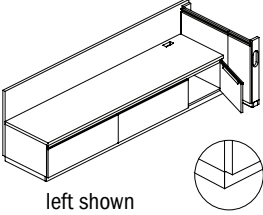
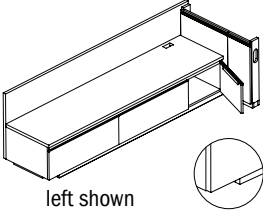

- use with 22"d workwall & kneespace access panel
- base is inset on one side
- pedestal front locking
- adjustable levelers/glides
- grommet available, specify and add \$99 list each; see page 51
- kneespace height: 28¼"
- kneespace width: 36"
- -2372 lateral files: 36"w
- -2366 lateral files: 30"w

Description	D	W	H	CTN WT	CU FT	① Model	List Price No Cushion	List Price With Cushion
One-High Run-Off Credenza with Access Door and Flush Base	37	94	29 ½	466	67	AM2-ROC-8-3790R	\$5,800	COM \$6,066
	37	94	29 ½	466	67	AM2-ROC-8-3790L		A \$6,080 B \$6,109 COL/C \$6,164 D \$6,229 E \$6,296 F \$6,397 G \$6,508 H \$6,626 I \$6,811 J \$7,032 L1 \$6,589 L2 \$6,722
 <p>left shown</p> <ul style="list-style-type: none"> <li>• base is flush</li> <li>• two 36" w lateral files</li> <li>• one hinged door</li> <li>• pedestal front locking</li> <li>• surface grommet</li> <li>• wire pass thru hole to allow access to the next unit</li> <li>• adjustable levelers/glides</li> <li>• bench height: 16 7/8"</li> <li>• optional 36" w cushion</li> <li>• com: 1 ¼</li> <li>• col sq ft: 22</li> </ul>								
One-High Run-Off Credenza with Access Door and Inset Base	37	94	29 ½	449	67	AM2-ROC-8R-3790R	\$5,800	COM \$6,066
	37	94	29 ½	449	67	AM2-ROC-8L-3790L		A \$6,080 B \$6,109 COL/C \$6,164 D \$6,229 E \$6,296 F \$6,397 G \$6,508 H \$6,626 I \$6,811 J \$7,032 L1 \$6,589 L2 \$6,722
 <p>left shown</p> <ul style="list-style-type: none"> <li>• base is inset on one side</li> <li>• two 36" w lateral files</li> <li>• one hinged door</li> <li>• pedestal front locking</li> <li>• surface grommet</li> <li>• wire pass thru hole to allow access to the next unit</li> <li>• adjustable levelers/glides</li> <li>• bench height: 16 7/8"</li> <li>• optional 36" w cushion</li> <li>• com: 1 ¼</li> <li>• col sq ft: 22</li> </ul>								

**To Order, Specify:**

- ① Model Number
- ② Wood Species on Top - Makore (MK2), Maple (MA2), Walnut (WA2) or Double Cut (DC1) (see page 62)
- ③ Finish Color for Top (see page 62)
- ④ Finish Color for Chassis/Drawer/Door Fronts
  - a.) Same as Top
  - b.) Paint (see page 62)
- ⑤ Finish Color for Base
  - a.) Same as Top
  - b.) Same as Chassis/Drawer/Door Fronts or Paint Color (see page 62)
- ⑥ Fabric - vendor, pattern, color

Note: Only one wood finish and one paint color can be specified per unit

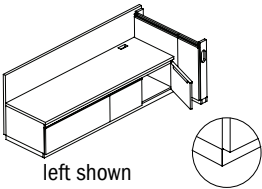
Description	D	W	H	CTN WT	CU FT	① Model	List Price No Cushion	List Price With Cushion
One-High Run-Off Credenza with Access Door and Flush Base	37	76	29½	389	54	AM2-ROC-8-3772R	\$5,039	COM \$5,305
	37	76	29½	389	54	AM2-ROC-8-3772L		A \$5,320
 <p>left shown</p> <ul style="list-style-type: none"> <li>· base is flush</li> <li>· one 36" w lateral file</li> <li>· one 18" w file drawer</li> <li>· one 18" w hinged door</li> <li>· pedestal front locking</li> <li>· surface grommet</li> <li>· wire pass thru hole to allow access to the next unit</li> <li>· adjustable levelers/glides</li> <li>· bench height: 16 7/8"</li> <li>· optional 36" w cushion</li> <li>· com ydg: 1 ¼</li> <li>· col sq ft: 22</li> </ul>								B \$5,348
								COL/C \$5,402
								D \$5,469
								E \$5,535
								F \$5,637
								G \$5,748
								H \$5,866
								I \$6,050
								J \$6,271
								L1 \$5,829
								L2 \$5,962

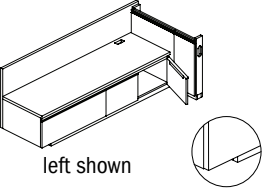
One-High Run-Off Credenza with Access Door and Inset Base	37	76	29½	373	54	AM2-ROC-8R-3772R	\$5,039	COM \$5,305
	37	76	29½	373	54	AM2-ROC-8L-3772L		A \$5,320
 <p>left shown</p> <ul style="list-style-type: none"> <li>· inset base one side</li> <li>· one 36" w lateral file</li> <li>· one 18" w file drawer</li> <li>· one 18" w hinged door</li> <li>· pedestal front locking</li> <li>· surface grommet</li> <li>· wire pass thru hole to allow access to the next unit</li> <li>· adjustable levelers/glides</li> <li>· bench height: 16 7/8"</li> <li>· optional 36" w cushion</li> <li>· com ydg: 1 ¼</li> <li>· col sq ft: 22</li> </ul>								B \$5,348
								COL/C \$5,402
								D \$5,469
								E \$5,535
								F \$5,637
								G \$5,748
								H \$5,866
								I \$6,050
								J \$6,271
								L1 \$5,829
								L2 \$5,962

APOGEE™

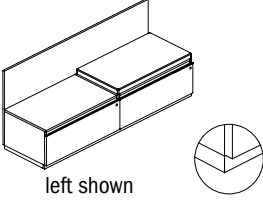

Description	D	W	H	CTN WT	CU FT	① Model	List Price No Cushion	List Price With Cushion
One-High Run-Off Credenza with Flush Base	23 ¼	72	29 ½	326	35	AP6-STC-1-2272R	\$4,279	COM \$4,544
	23 ¼	72	29 ½	326	35	AP6-STC-1-2272L		A \$4,561
 <p>left shown cushion optional</p> <ul style="list-style-type: none"> <li>base is flush</li> <li>36" w lateral files</li> <li>pedestal front locking</li> <li>adjustable levelers/glides</li> <li>bench height: 16 7/8"</li> <li>optional 36" w cushion</li> <li>com ydg: 1 ¼</li> <li>col sq ft: 22</li> </ul>								B \$4,591
								COL/C \$4,641
								D \$4,707
								E \$4,774
								F \$4,877
								G \$4,987
								H \$5,107
								I \$5,289
								J \$5,511
								L1 \$5,068
							L2 \$5,203	

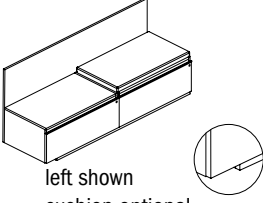
One-High Run-Off Credenza with Inset Base	23 ¼	72	29 ½	323	35	AP6-STC-1R-2272R	\$4,279	COM \$4,544
	23 ¼	72	29 ½	323	35	AP6-STC-1L-2272L		A \$4,561
 <p>left shown cushion optional</p> <ul style="list-style-type: none"> <li>base is inset on one side</li> <li>36" w lateral files</li> <li>pedestal front locking</li> <li>adjustable levelers/glides</li> <li>bench height: 16 7/8"</li> <li>optional 36" w cushion</li> <li>com ydg: 1 ¼</li> <li>col sq ft: 22</li> </ul>								B \$4,591
								COL/C \$4,641
								D \$4,707
								E \$4,774
								F \$4,877
								G \$4,987
								H \$5,107
								I \$5,289
								J \$5,511
								L1 \$5,068
							L2 \$5,203	

**To Order, Specify:**

- ① Model Number
- ② Wood Species on Top - Makore (MK2), Maple (MA2), Walnut (WA2) or Double Cut (DC1) (see page 62)
- ③ Finish Color for Top (see page 62)
- ④ Finish Color for Chassis/Drawer/Door Fronts
  - a.) Same as Top
  - b.) Paint (see page 62)
- ⑤ Finish Color for Base
  - a.) Same as Top
  - b.) Same as Chassis/Drawer/Door Fronts or Paint Color (see page 62)
- ⑥ Fabric - vendor, pattern, color

Note: Only one wood finish and one paint color can be specified per unit

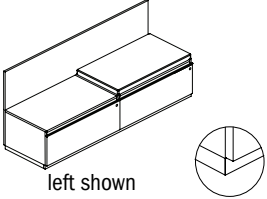
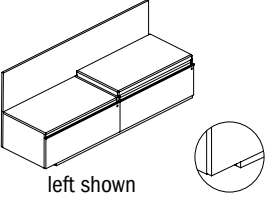
Description	D	W	H	CTN WT	CU FT	① Model	List Price No Cushion	List Price With Cushion
One-High Run-Off Credenza with Flush Base	23 ¼	60	29 ½	274	29	AP6-STC-1-2260R	\$4,153	COM \$4,418
	23 ¼	60	29 ½	274	29	AP6-STC-1-2260L		A \$4,434
 <p>left shown cushion optional</p> <ul style="list-style-type: none"> <li>• base is flush</li> <li>• 30" w lateral files</li> <li>• pedestal front locking</li> <li>• adjustable levelers/glides</li> <li>• bench height: 16 7/8"</li> <li>• optional 30" w cushion</li> <li>• com ydg: 1 ¼</li> <li>• col sq ft: 22</li> </ul>								B \$4,462
								COL/C \$4,515
								D \$4,580
								E \$4,647
								F \$4,751
								G \$4,862
								H \$4,979
								I \$5,164
								J \$5,384
								L1 \$4,941
								L2 \$5,076
	One-High Run-Off Credenza with Inset Base	23 ¼	60	29 ½	271	29	AP6-STC-1R-2260R	\$4,153
23 ¼		60	29 ½	271	29	AP6-STC-1L-2260L	A \$4,434	
 <p>left shown cushion optional</p> <ul style="list-style-type: none"> <li>• base is inset on one side</li> <li>• 30" w lateral files</li> <li>• pedestal front locking</li> <li>• adjustable levelers/glides</li> <li>• bench height: 16 7/8"</li> <li>• optional 30" w cushion</li> <li>• com ydg: 1 ¼</li> <li>• col sq ft: 22</li> </ul>								B \$4,462
								COL/C \$4,515
								D \$4,580
								E \$4,647
								F \$4,751
								G \$4,862
								H \$4,979
								I \$5,164
								J \$5,384
								L1 \$4,941
								L2 \$5,076

APOGEE™

Description	D	W	H	CTN WT	CU FT	① Model	List Price
Utility/File Mobile Pedestal	22	16	27 7/8	95	7	AP6-MBP-1-2216	\$1,630

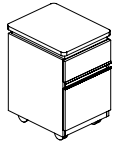

- utility drawer with box drawer front
- soft close drawers
- pedestal front locking

Description	D	W	H	CTN WT	CU FT	① Model	List Price Per Grade
Utility/File Mobile Pedestal with Cushion Top	22	16	27 7/8	95	7	AP6-MBP-C-2216	COM \$1,655

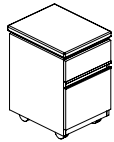

- utility drawer with box drawer front
- soft close drawers
- pedestal front locking
- cushion top
- com ydg: 1
- col sq ft: 15

- A \$1,666
- B \$1,688
- COL/C \$1,731
- D \$1,786
- E \$1,837
- F \$1,920
- G \$2,008
- H \$2,102
- I \$2,251
- J \$2,427
- L1 \$2,073
- L2 \$2,180

**To Order, Specify:**

**Credenza**

- ① Model Number
- ② Wood Species on Top - Makore (MK2), Maple (MA2), Walnut (WA2) or Double Cut (DC1) (see page 62)
- ③ Finish Color for Top (see page 62)
- ④ Finish Color for Chassis/Drawer Fronts
  - a.) Same as Top
  - b.) Paint (see page 62)
- ⑤ Finish Color for Base
  - a.) Same as Top
  - b.) Same as Chassis/Drawer Fronts or Paint Color (see page 62)
- ⑥ Fabric - vendor, pattern, color

**Mobile Pedestal**

- ① Model Number
- ② Wood Species on Top - Makore (MK2), Maple (MA2), Walnut (WA2) or Double Cut (DC1), (see page 62)
  - a.) Finish Color for Top, (see page 62)
- ③ Finish Color for Chassis/Drawer Fronts
  - a.) Same as Top
  - b.) Paint (see page 62)

**Mobile Pedestal with Cushion Top**

- ① Model Number
- ② Cushion
  1. Fabric - vendor, pattern, color
- ③ Chassis/Drawer Front Species - Makore (MK2), Maple (MA2), Walnut (WA2), Double Cut (DC1) or Paint (PNT), (see page 62)
- ④ Finish Color for Chassis/Drawer Fronts (see page 62)

Note: Only one wood finish and one paint color can be specified per unit

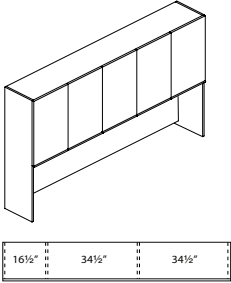
Description	D	W	H	CTN WT	CU FT	① Model	List Price	
18" d Double Height Storage Overhead Cabinet with 5 Doors	18	90	56	383	63	AP4-BOT-1D-1890R	VENEER PANEL \$6,337	
	18	90	56	383	63	AP4-BOT-1D-1890L	PAINT PANEL \$6,337	
 <p>left shown</p> <ul style="list-style-type: none"> <li>· chassis and doors available in veneer or paint or veneer/paint combination</li> <li>· required insert panel available in veneer, paint, magnetic back painted white glass or fabric, indicate selection on order and select appropriate list price</li> <li>· aluminum mini shelf available, specify and add \$990 list</li> <li>· glass insert panel has a thin aluminum frame</li> <li>· pack of 6 magnets come with magnetic glass option</li> <li>· task lights available, see pages 532-533</li> <li>· 1 1/2" wire access bottom across the bottom of back panel</li> <li>· legal depth</li> <li>· soft close hinge doors</li> <li>· adjustable shelves</li> <li>· aluminum valance rail</li> <li>· finished, flush back panel</li> <li>· fabric is railroaded</li> <li>· locking doors available, specify and add \$369 list</li> <li>· compartment height: 28 1/2"</li> <li>· compartment depth: 16 1/2"</li> <li>· worksurface to valance rail: 24 1/2"</li> <li>· com ydg: 2 3/4"</li> </ul>							GLASS PANEL \$8,688	
								FABRIC PANEL
								COM \$7,139
								A \$7,171
								B \$7,236
								C \$7,350
								D \$7,495
								E \$7,642
								F \$7,870
								G \$8,112
							H \$8,372	
							I \$8,777	
							J \$9,262	

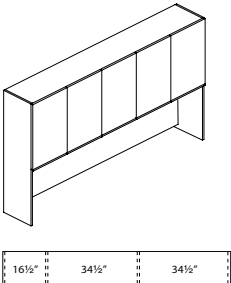
15" d Double Height Storage Overhead Cabinet with 5 Doors	15	90	56	355	53	AP4-BOT-1-1590R	VENEER PANEL \$6,210	
	15	90	56	355	53	AP4-BOT-1-1590L	PAINT PANEL \$6,210	
 <p>left shown</p> <ul style="list-style-type: none"> <li>· chassis and doors available in veneer or paint or veneer/paint combination</li> <li>· required insert panel available in veneer, paint, magnetic back painted white glass or fabric, indicate selection on order and select appropriate list price</li> <li>· aluminum mini shelf available, specify and add \$990 list</li> <li>· glass insert panel has a thin aluminum frame</li> <li>· pack of 6 magnets come with magnetic glass option</li> <li>· task lights available, see pages 532-533</li> <li>· 1 1/2" wire access bottom across the bottom of back panel</li> <li>· letter depth</li> <li>· soft close hinge doors</li> <li>· adjustable shelves</li> <li>· aluminum valance rail</li> <li>· finished, flush back panel</li> <li>· fabric is railroaded</li> <li>· locking doors available, specify and add \$369 list</li> <li>· compartment height: 28 1/2"</li> <li>· compartment depth: 13 1/2"</li> <li>· worksurface to valance rail: 24 1/2"</li> <li>· com ydg: 2 3/4"</li> </ul>							GLASS PANEL \$8,562	
								FABRIC PANEL
								COM \$7,012
								A \$7,045
								B \$7,109
								C \$7,223
								D \$7,370
								E \$7,514
								F \$7,743
								G \$7,986
							H \$8,244	
							I \$8,650	
							J \$9,136	

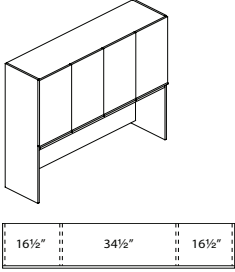
Description	D	W	H	CTN WT	CU FT	① Model	List Price
<b>18" d Double Height Storage Overhead Cabinet with 4 Doors</b> 	18	72	56	321	51	<b>AP4-BOT-1D-1872</b>	<b>VENEER PANEL \$5,603</b> <b>PAINT PANEL \$5,603</b> <b>GLASS PANEL \$7,583</b> <b>FABRIC PANEL</b> <b>COM \$6,221</b> <b>A \$6,248</b> <b>B \$6,301</b> <b>C \$6,394</b> <b>D \$6,512</b> <b>E \$6,632</b> <b>F \$6,818</b> <b>G \$7,017</b> <b>H \$7,229</b> <b>I \$7,561</b> <b>J \$7,957</b>
<ul style="list-style-type: none"> <li>chassis and doors available in veneer or paint or veneer/paint combination</li> <li>required insert panel available in veneer, paint, magnetic back painted white glass or fabric, indicate selection on order and select appropriate list price</li> <li>aluminum mini shelf available, specify and add \$948 list</li> <li>glass insert panel has a thin aluminum frame</li> <li>pack of 6 magnets come with magnetic glass option</li> <li>task lights available, see pages 532-533</li> <li>1 1/2" wire access bottom across the bottom of back panel</li> <li>legal depth</li> <li>soft close hinge doors</li> <li>adjustable shelves</li> <li>aluminum valance rail</li> <li>finished, flush back panel</li> <li>fabric is railroaded</li> <li>locking doors available, specify and add \$369 list</li> <li>compartment height: 28 1/2"</li> <li>compartment depth: 16 1/2"</li> <li>worksurface to valance rail: 24 1/2"</li> <li>com ydg: 2 1/4"</li> </ul>							

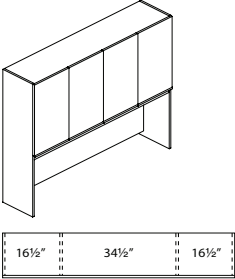
<b>15" d Double Height Storage Overhead Cabinet with 4 Doors</b> 	15	72	56	297	43	<b>AP4-BOT-1-1572</b>	<b>VENEER PANEL \$5,476</b> <b>PAINT PANEL \$5,476</b> <b>GLASS PANEL \$7,455</b> <b>FABRIC PANEL</b> <b>COM \$6,094</b> <b>A \$6,122</b> <b>B \$6,174</b> <b>C \$6,268</b> <b>D \$6,386</b> <b>E \$6,506</b> <b>F \$6,691</b> <b>G \$6,891</b> <b>H \$7,104</b> <b>I \$7,435</b> <b>J \$7,832</b>
<ul style="list-style-type: none"> <li>chassis and doors available in veneer or paint or veneer/paint combination</li> <li>required insert panel available in veneer, paint, magnetic back painted white glass or fabric, indicate selection on order and select appropriate list price</li> <li>aluminum mini shelf available, specify and add \$948 list</li> <li>glass insert panel has a thin aluminum frame</li> <li>pack of 6 magnets come with magnetic glass option</li> <li>task lights available, see pages 532-533</li> <li>1 1/2" wire access bottom across the bottom of back panel</li> <li>letter depth</li> <li>soft close hinge doors</li> <li>adjustable shelves</li> <li>aluminum valance rail</li> <li>finished, flush back panel</li> <li>fabric is railroaded</li> <li>locking doors available, specify and add \$369 list</li> <li>compartment height: 28 1/2"</li> <li>compartment depth: 13 1/2"</li> <li>worksurface to valance rail: 24 1/2"</li> <li>com ydg: 2 1/4"</li> </ul>							

**To Order, Specify:**

① Model Number

② Finish Application

- a.) All Veneer
  - 1.) Wood Species - Makore (MK2), Maple (MA2), Walnut (WA2) or Double Cut (DC1) (see page 62)
  - a.) Finish Color (see page 62)
- b.) All Paint (PNT)
  - 1.) Paint Color (see page 62)



c.) Veneer/Paint Combination

- 1.) Chassis Wood Species/Paint - Makore (MK2), Maple (MA2), Walnut (WA2), Double Cut (DC1) or Paint (PNT) (see page 62)
  - a.) Finish Color for Chassis (see page 62)
- 2.) Door Wood Species/Paint - Makore (MK2), Maple (MA2), Walnut (WA2), Double Cut (DC1) or Paint (PNT) (see page 62)
  - a.) Finish Color for Door (see page 62)

③ Insert Panel

- a.) Veneer
  - 1.) Wood Species - Makore (MK2), Maple (MA2), Walnut (WA2) or Double Cut (DC1) (see page 62)
  - A. Finish Color (see page 62)
- b.) Paint (PNT)
  - 1.) Paint Color (see page 62)
- c.) Back Painted Magnetic Glass
- d.) Fabric - vendor, pattern, color

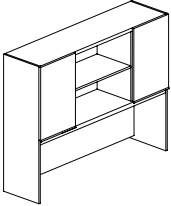
Note: Only one wood finish and one paint color can be specified per unit

Description	D	W	H	CTN WT	CU FT	① Model	List Price
<b>18"d Double Height Storage Overhead Cabinet with 2 Doors and Open Center Shelf</b>  	18	66	56	279	46	<b>AP4-BOT-4D-1866</b>	<b>VENEER PANEL \$4,754</b> <b>PAINT PANEL \$4,754</b> <b>GLASS PANEL \$6,469</b> <b>FABRIC PANEL</b> <b>COM \$5,358</b> <b>A \$5,381</b> <b>B \$5,428</b> <b>C \$5,511</b> <b>D \$5,617</b> <b>E \$5,723</b> <b>F \$5,888</b> <b>G \$6,066</b> <b>H \$6,253</b> <b>I \$6,549</b> <b>J \$6,903</b>
	<ul style="list-style-type: none"> <li>· chassis and doors available in veneer or paint or veneer/paint combination</li> <li>· required insert panel available in veneer, paint, magnetic back painted white glass or fabric, indicate selection on order and select appropriate list price</li> <li>· aluminum mini shelf available, specify and add \$903</li> <li>· glass insert panel has a thin aluminum frame</li> <li>· pack of 6 magnets come with magnetic glass option</li> <li>· task lights available, see pages 532-533</li> <li>· 1 1/2" wire access bottom across the bottom of back panel</li> <li>· legal depth</li> <li>· soft close hinge doors</li> <li>· adjustable shelves</li> <li>· aluminum valance rail</li> <li>· finished, flush back panel</li> <li>· fabric is railroaded</li> <li>· locking doors available, specify and add \$246 list</li> <li>· compartment height: 28 1/2"</li> <li>· compartment depth: 16 1/2"</li> <li>· worksurface to valance rail: 24 1/2"</li> <li>· com ydg: 2</li> </ul>						

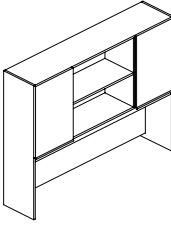
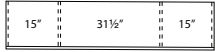
<b>15"d Double Height Storage Overhead Cabinet with 2 Doors and Open Center Shelf</b>  	15	66	56	256	39	<b>AP4-BOT-4-1566</b>	<b>VENEER PANEL \$4,628</b> <b>PAINT PANEL \$4,628</b> <b>GLASS PANEL \$6,342</b> <b>FABRIC PANEL</b> <b>COM \$5,230</b> <b>A \$5,254</b> <b>B \$5,302</b> <b>C \$5,384</b> <b>D \$5,490</b> <b>E \$5,597</b> <b>F \$5,762</b> <b>G \$5,939</b> <b>H \$6,127</b> <b>I \$6,422</b> <b>J \$6,777</b>
	<ul style="list-style-type: none"> <li>· chassis and doors available in veneer or paint or veneer/paint combination</li> <li>· required insert panel available in veneer, paint, magnetic back painted white glass or fabric, indicate selection on order and select appropriate list price</li> <li>· aluminum mini shelf available, specify and add \$903</li> <li>· glass insert panel has a thin aluminum frame</li> <li>· pack of 6 magnets come with magnetic glass option</li> <li>· task lights available, see pages 532-533</li> <li>· 1 1/2" wire access bottom across the bottom of back panel</li> <li>· letter depth</li> <li>· soft close hinge doors</li> <li>· adjustable shelves</li> <li>· aluminum valance rail</li> <li>· finished, flush back panel</li> <li>· fabric is railroaded</li> <li>· locking doors available, specify and add \$246 list</li> <li>· compartment height: 28 1/2"</li> <li>· compartment depth: 13 1/2"</li> <li>· worksurface to valance rail: 24 1/2"</li> <li>· com ydg: 2</li> </ul>						

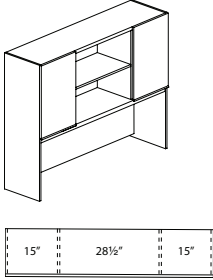
Description	D	W	H	CTN WT	CU FT	① Model	List Price
<b>18" d Double Height Storage Overhead Cabinet with 2 Doors and Open Center Shelf</b> 	18	60	56	261	42	AP4-BOT-4D-1860	<b>VENEER PANEL</b> \$4,597
							<b>PAINT PANEL</b> \$4,597
<ul style="list-style-type: none"> <li>chassis and doors available in veneer or paint or veneer/paint combination</li> <li>required insert panel available in veneer, paint, magnetic back painted white glass or fabric, indicate selection on order and select appropriate list price</li> <li>aluminum mini shelf available, specify and add \$853 list</li> <li>glass insert panel has a thin aluminum frame</li> <li>pack of 6 magnets come with magnetic glass option</li> <li>task lights available, see pages 532-533</li> <li>1 1/2" wire access bottom across the bottom of back panel</li> <li>legal depth</li> <li>soft close hinge doors</li> <li>adjustable shelves</li> <li>aluminum valance rail</li> <li>finished, flush back panel</li> <li>fabric is railroaded</li> <li>locking doors available, specify and add \$246 list</li> <li>compartment height: 28 1/2"</li> <li>compartment depth: 16 1/2"</li> <li>worksurface to valance rail: 24 1/2"</li> <li>com ydg: 2</li> </ul>							<b>GLASS PANEL</b> \$6,050
							<b>FABRIC PANEL</b>
							<b>COM</b> \$5,183
							<b>A</b> \$5,208
							<b>B</b> \$5,254
							<b>C</b> \$5,338
							<b>D</b> \$5,443
							<b>E</b> \$5,548
							<b>F</b> \$5,715
							<b>G</b> \$5,892
						<b>H</b> \$6,080	
						<b>I</b> \$6,376	
						<b>J</b> \$6,729	

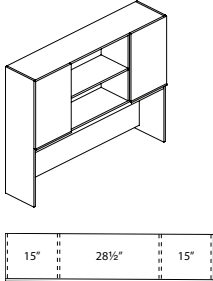
<b>15" d Double Height Storage Overhead Cabinet with 2 Doors and Open Center Shelf</b> 	15	60	56	239	36	AP4-BOT-4-1560	<b>VENEER PANEL</b> \$4,471
							<b>PAINT PANEL</b> \$4,471
<ul style="list-style-type: none"> <li>chassis and doors available in veneer or paint or veneer/paint combination</li> <li>required insert panel available in veneer, paint, magnetic back painted white glass or fabric, indicate selection on order and select appropriate list price</li> <li>aluminum mini shelf available, specify and add \$853 list</li> <li>glass insert panel has a thin aluminum frame</li> <li>pack of 6 magnets come with magnetic glass option</li> <li>task lights available, see pages 532-533</li> <li>1 1/2" wire access bottom across the bottom of back panel</li> <li>letter depth</li> <li>soft close hinge doors</li> <li>adjustable shelves</li> <li>aluminum valance rail</li> <li>finished, flush back panel</li> <li>fabric is railroaded</li> <li>locking doors available, specify and add \$246 list</li> <li>compartment height: 28 1/2"</li> <li>compartment depth: 13 1/2"</li> <li>worksurface to valance rail: 24 1/2"</li> <li>com ydg: 2</li> </ul>							<b>GLASS PANEL</b> \$5,923
							<b>FABRIC PANEL</b>
							<b>COM</b> \$5,057
							<b>A</b> \$5,081
							<b>B</b> \$5,128
							<b>C</b> \$5,211
							<b>D</b> \$5,317
							<b>E</b> \$5,421
							<b>F</b> \$5,588
							<b>G</b> \$5,765
						<b>H</b> \$5,953	
						<b>I</b> \$6,248	
						<b>J</b> \$6,603	

**To Order, Specify:**

① Model Number

② Finish Application

- a.) All Veneer
  - 1.) Wood Species - Makore (MK2), Maple (MA2), Walnut (WA2) or Double Cut (DC1) (see page 62)
  - a.) Finish Color (see page 62)
- b.) All Paint (PNT)
  - 1.) Paint Color (see page 62)

c.) Veneer/Paint Combination

- 1.) Chassis Wood Species/Paint - Makore (MK2), Maple (MA2), Walnut (WA2), Double Cut (DC1) or Paint (PNT) (see page 62)
  - a.) Finish Color for Chassis (see page 62)
- 2.) Door Wood Species/Paint - Makore (MK2), Maple (MA2), Walnut (WA2), Double Cut (DC1) or Paint (PNT) (see page 62)
  - a.) Finish Color for Door (see page 62)

③ Insert Panel

- a.) Veneer
  - 1.) Wood Species - Makore (MK2), Maple (MA2), Walnut (WA2) or Double Cut (DC1) (see page 62)
  - a.) Finish Color (see page 62)
- b.) Paint (PNT)
  - 1.) Paint Color (see page 62)
- c.) Back Painted Magnetic Glass
- d.) Fabric - vendor, pattern, color

Note: Only one wood finish and one paint color can be specified per unit

Description	D	W	H	CTN WT	CU FT	① Model	List Price
18" d Double Height Storage Overhead Cabinet with 5 Doors and Open Storage	18	90	56	357	63	AP4-BOT-SD-1890R	VENEER PANEL \$6,020
	18	90	56	357	63	AP4-BOT-SD-1890L	PAINT PANEL \$6,020

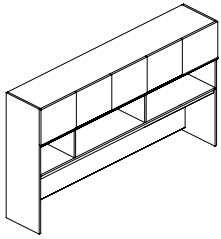

left shown

- chassis and doors available in veneer or paint or veneer/paint combination
- required insert panel available in veneer, paint, magnetic back painted white glass or fabric, indicate selection on order and select appropriate list price
- aluminum mini shelf available, specify and add \$990 list
- glass insert panel has a thin aluminum frame
- pack of 6 magnets come with magnetic glass option
- task lights available, see pages 532-533
- 1 1/2" wire access bottom across the bottom of back panel
- legal depth
- soft close hinge doors
- adjustable shelves
- aluminum valance rail
- finished, flush back panel
- fabric is railroaded
- locking doors available, specify and add \$369 list
- small outside closed binder section: 16 1/2" w x 16 1/2" d x 14 1/4" h
- large closed binder section: 34 1/2" w x 16 1/2" d x 14 1/4" h
- small outside open binder section: 16 1/2" w x 16 1/2" d x 14 1/4" h
- large open binder section: 34 1/2" w x 16 1/2" d x 14 1/4" h
- worksurface to valance rail: 24 1/2"
- com ydg: 2 3/4

GLASS PANEL	\$8,374
FABRIC PANEL	
COM	\$6,821
A	\$6,855
B	\$6,918
C	\$7,033
D	\$7,179
E	\$7,324
F	\$7,552
G	\$7,795
H	\$8,053
I	\$8,459
J	\$8,946

15" d Double Height Storage Overhead Cabinet with 5 Doors and Open Storage	15	90	56	329	53	AP4-BOT-S-1590R	VENEER PANEL \$5,895
	15	90	56	329	53	AP4-BOT-S-1590L	PAINT PANEL \$5,895

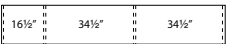
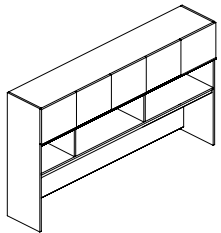

left shown

- chassis and doors available in veneer or paint or veneer/paint combination
- required insert panel available in veneer, paint, magnetic back painted white glass or fabric, indicate selection on order and select appropriate list price
- aluminum mini shelf available, specify and add \$990 list
- glass insert panel has a thin aluminum frame
- pack of 6 magnets come with magnetic glass option
- task lights available, see pages 532-533
- 1 1/2" wire access bottom across the bottom of back panel
- letter depth
- soft close hinge doors
- adjustable shelves
- aluminum valance rail
- finished, flush back panel
- fabric is railroaded
- locking doors available, specify and add \$369 list
- small outside closed binder section: 16 1/2" w x 13 1/2" d x 14 1/4" h
- large closed binder section: 34 1/2" w x 13 1/2" d x 14 1/4" h
- small outside open binder section: 16 1/2" w x 13 1/2" d x 14 1/4" h
- large open binder section: 34 1/2" w x 13 1/2" d x 14 1/4" h
- worksurface to valance rail: 24 1/2"
- com ydg: 2 3/4

GLASS PANEL	\$8,247
FABRIC PANEL	
COM	\$6,694
A	\$6,727
B	\$6,790
C	\$6,907
D	\$7,052
E	\$7,197
F	\$7,425
G	\$7,670
H	\$7,928
I	\$8,333
J	\$8,819

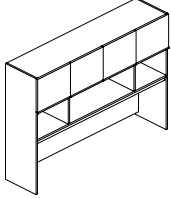
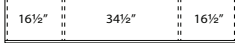

Description	D	W	H	CTN WT	CU FT	① Model	List Price
<b>18" d Double Height Storage Overhead Cabinet with 4 Doors and Open Storage</b>  	18	72	56	300	51	AP4-BOT-SD-1872	<b>VENEER PANEL</b> \$5,286
							<b>PAINT PANEL</b> \$5,286
<ul style="list-style-type: none"> <li>chassis and doors available in veneer or paint or veneer/paint combination</li> <li>required insert panel available in veneer, paint, magnetic back painted white glass or fabric, indicate selection on order and select appropriate list price</li> <li>aluminum mini shelf available, specify and add \$948 list</li> <li>glass insert panel has a thin aluminum frame</li> <li>pack of 6 magnets come with magnetic glass option</li> <li>task lights available, see pages 532-533</li> <li>1 1/2" wire access bottom across the bottom of back panel</li> <li>legal depth</li> <li>soft close hinge doors</li> <li>adjustable shelves</li> <li>aluminum valance rail</li> <li>finished, flush back panel</li> <li>fabric is railroaded</li> <li>locking doors available, specify and add \$369 list</li> <li>small outside closed binder section: 16 1/2" w x 16 1/2" d x 14 1/4" h</li> <li>large closed binder section: 34 1/2" w x 16 1/2" d x 14 1/4" h</li> <li>small outside open binder section: 16 1/2" w x 16 1/2" d x 14 1/4" h</li> <li>large open binder section: 34 1/2" w x 16 1/2" d x 14 1/4" h</li> <li>worksurface to valance rail: 24 1/2"</li> <li>com ydg: 2 1/4</li> </ul>	<b>GLASS PANEL</b> \$7,264						
	<b>FABRIC PANEL</b>						
	<b>COM</b> \$5,903						
	<b>A</b> \$5,932						
	<b>B</b> \$5,984						
	<b>C</b> \$6,078						
	<b>D</b> \$6,199						
	<b>E</b> \$6,316						
	<b>F</b> \$6,502						
	<b>G</b> \$6,701						
	<b>H</b> \$6,912						
	<b>I</b> \$7,244						
<b>J</b> \$7,643							

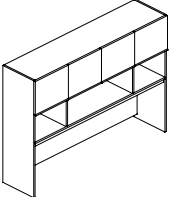
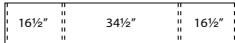
<b>15" d Double Height Storage Overhead Cabinet with 4 Doors and Open Storage</b>  	15	72	56	275	43	AP4-BOT-S-1572	<b>VENEER PANEL</b> \$5,159
							<b>PAINT PANEL</b> \$5,159
<ul style="list-style-type: none"> <li>chassis and doors available in veneer or paint or veneer/paint combination</li> <li>required insert panel available in veneer, paint, magnetic back painted white glass or fabric, indicate selection on order and select appropriate list price</li> <li>aluminum mini shelf available, specify and add \$948 list</li> <li>glass insert panel has a thin aluminum frame</li> <li>pack of 6 magnets come with magnetic glass option</li> <li>task lights available, see pages 532-533</li> <li>1 1/2" wire access bottom across the bottom of back panel</li> <li>letter depth</li> <li>soft close hinge doors</li> <li>adjustable shelves</li> <li>aluminum valance rail</li> <li>finished, flush back panel</li> <li>fabric is railroaded</li> <li>locking doors available, specify and add \$369 list</li> <li>small outside closed binder section: 16 1/2" w x 13 1/2" d x 14 1/4" h</li> <li>large closed binder section: 34 1/2" w x 13 1/2" d x 14 1/4" h</li> <li>small outside open binder section: 16 1/2" w x 13 1/2" d x 14 1/4" h</li> <li>large open binder section: 34 1/2" w x 13 1/2" d x 14 1/4" h</li> <li>worksurface to valance rail: 24 1/2"</li> <li>com ydg: 2 1/4</li> </ul>	<b>GLASS PANEL</b> \$7,139						
	<b>FABRIC PANEL</b>						
	<b>COM</b> \$5,778						
	<b>A</b> \$5,805						
	<b>B</b> \$5,858						
	<b>C</b> \$5,951						
	<b>D</b> \$6,071						
	<b>E</b> \$6,189						
	<b>F</b> \$6,376						
	<b>G</b> \$6,574						
	<b>H</b> \$6,785						
	<b>I</b> \$7,116						
<b>J</b> \$7,515							

**To Order, Specify:**

① Model Number

② Finish Application

- a.) All Veneer
  - 1.) Wood Species - Makore (MK2), Maple (MA2), Walnut (WA2) or Double Cut (DC1) (see page 62)
  - a.) Finish Color (see page 62)
- b.) All Paint (PNT)
  - 1.) Paint Color (see page 62)

c.) Veneer/Paint Combination

- 1.) Chassis Wood Species/Paint - Makore (MK2), Maple (MA2), Walnut (WA2), Double Cut (DC1) or Paint (PNT) (see page 62)
  - a.) Finish Color for Chassis (see page 62)
- 2.) Door Wood Species/Paint - Makore (MK2), Maple (MA2), Walnut (WA2), Double Cut (DC1) or Paint (PNT) (see page 62)
  - a.) Finish Color for Door (see page 62)

③ Insert Panel

- a.) Veneer
  - 1.) Wood Species - Makore (MK2), Maple (MA2), Walnut (WA2) or Double Cut (DC1) (see page 62)
  - a.) Finish Color (see page 62)
- b.) Paint (PNT)
  - 1.) Paint Color (see page 62)
- c.) Back Painted Magnetic Glass
- d.) Fabric - vendor, pattern, color

Note: Only one wood finish and one paint color can be specified per unit

Description	D	W	H	CTN WT	CU FT	① Model	List Price
18" d Storage Overhead Cabinet with 5 Doors	18	90	41	267	47	AP4-BOS-1D-1890R	VENEER PANEL \$5,768
	18	90	41	267	47	AP4-BOS-1D-1890L	PAINT PANEL \$5,768

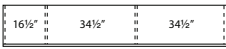
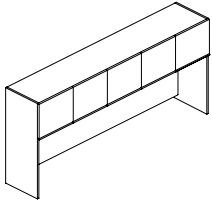

left shown

- chassis and doors available in veneer or paint or veneer/paint combination
- required insert panel available in veneer, paint, magnetic back painted white glass or fabric, indicate selection on order and select appropriate list price
- aluminum mini shelf available, specify and add \$990 list
- glass insert panel has a thin aluminum frame
- pack of 6 magnets come with magnetic glass option
- task lights available, see pages 532-533
- 1 1/2" wire access bottom across the bottom of back panel
- legal depth
- soft close hinge doors
- adjustable shelves
- aluminum valance rail
- finished, flush back panel
- fabric is railroaded
- locking doors available, specify and add \$369 list
- compartment height: 13 1/2"
- compartment depth: 16 1/2"
- worksurface to valance rail: 24 1/2"
- com ydg: 2 3/4"

- GLASS PANEL \$8,120
- FABRIC PANEL
- COM \$6,569
- A \$6,602
- B \$6,665
- C \$6,780
- D \$6,926
- E \$7,071
- F \$7,299
- G \$7,543
- H \$7,800
- I \$8,205
- J \$8,692

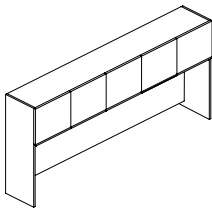

15" d Storage Overhead Cabinet with 5 Doors	15	90	41	249	40	AP4-BOS-1-1590R	VENEER PANEL \$5,641
	15	90	41	249	40	AP4-BOS-1-1590L	PAINT PANEL \$5,641



left shown

- chassis and doors available in veneer or paint or veneer/paint combination
- required insert panel available in veneer, paint, magnetic back painted white glass or fabric, indicate selection on order and select appropriate list price
- aluminum mini shelf available, specify and add \$990 list
- glass insert panel has a thin aluminum frame
- pack of 6 magnets come with magnetic glass option
- task lights available, see pages 532-533
- 1 1/2" wire access bottom across the bottom of back panel
- letter depth
- soft close hinge doors
- adjustable shelves
- aluminum valance rail
- finished, flush back panel
- fabric is railroaded
- locking doors available, specify and add \$369 list
- compartment height: 13 1/2"
- compartment depth: 16 1/2"
- worksurface to valance rail: 24 1/2"
- com ydg: 2 3/4"

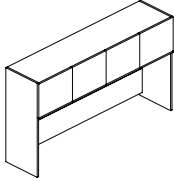
- GLASS PANEL \$7,993
- FABRIC PANEL
- COM \$6,442
- A \$6,474
- B \$6,538
- C \$6,653
- D \$6,799
- E \$6,945
- F \$7,172
- G \$7,416
- H \$7,675
- I \$8,079
- J \$8,564

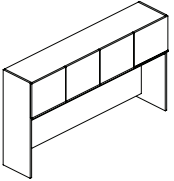
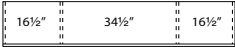
Description	D	W	H	CTN WT	CU FT	① Model	List Price
<b>18" d Storage Overhead Cabinet with 4 Doors</b>  	18	72	41	223	38	<b>AP4-BOS-1D-1872</b>	<b>VENEER PANEL \$4,779</b> <b>PAINT PANEL \$4,779</b> <b>GLASS PANEL \$6,757</b> <b>FABRIC PANEL</b> <b>COM \$5,398</b> <b>A \$5,425</b> <b>B \$5,478</b> <b>C \$5,571</b> <b>D \$5,690</b> <b>E \$5,810</b> <b>F \$5,996</b> <b>G \$6,195</b> <b>H \$6,406</b> <b>I \$6,738</b> <b>J \$7,137</b>
<ul style="list-style-type: none"> <li>chassis and doors available in veneer or paint or veneer/paint combination</li> <li>required insert panel available in veneer, paint, magnetic back painted white glass or fabric, indicate selection on order and select appropriate list price</li> <li>aluminum mini shelf available, specify and add \$948 list</li> <li>glass insert panel has a thin aluminum frame</li> <li>pack of 6 magnets come with magnetic glass option</li> <li>task lights available, see pages 532-533</li> <li>1 1/2" wire access bottom across the bottom of back panel</li> <li>legal depth</li> <li>soft close hinge doors</li> <li>adjustable shelves</li> <li>aluminum valance rail</li> <li>finished, flush back panel</li> <li>fabric is railroaded</li> <li>locking doors available, specify and add \$369 list</li> <li>compartment height: 13 1/2"</li> <li>compartment depth: 16 1/2"</li> <li>worksurface to valance rail: 24 1/2"</li> <li>com ydg: 2 1/4</li> </ul>							
<b>15" d Storage Overhead Cabinet with 4 Doors</b>  	15	72	41	207	32	<b>AP4-BOS-1-1572</b>	<b>VENEER PANEL \$4,652</b> <b>PAINT PANEL \$4,652</b> <b>GLASS PANEL \$6,631</b> <b>FABRIC PANEL</b> <b>COM \$5,270</b> <b>A \$5,299</b> <b>B \$5,350</b> <b>C \$5,444</b> <b>D \$5,565</b> <b>E \$5,684</b> <b>F \$5,868</b> <b>G \$6,068</b> <b>H \$6,280</b> <b>I \$6,611</b> <b>J \$7,010</b>
<ul style="list-style-type: none"> <li>chassis and doors available in veneer or paint or veneer/paint combination</li> <li>required insert panel available in veneer, paint, magnetic back painted white glass or fabric, indicate selection on order and select appropriate list price</li> <li>aluminum mini shelf available, specify and add \$948 list</li> <li>glass insert panel has a thin aluminum frame</li> <li>pack of 6 magnets come with magnetic glass option</li> <li>task lights available, see pages 532-533</li> <li>1 1/2" wire access bottom across the bottom of back panel</li> <li>letter depth</li> <li>soft close hinge doors</li> <li>adjustable shelves</li> <li>aluminum valance rail</li> <li>finished, flush back panel</li> <li>fabric is railroaded</li> <li>locking doors available, specify and add \$369 list</li> <li>compartment height: 13 1/2"</li> <li>compartment depth: 13 1/2"</li> <li>worksurface to valance rail: 24 1/2"</li> <li>com ydg: 2 1/4</li> </ul>							

**To Order, Specify:**

① Model Number

② Finish Application

- a.) All Veneer
  - 1.) Wood Species - Makore (MK2), Maple (MA2), Walnut (WA2) or Double Cut (DC1) (see page 62)
  - a.) Finish Color (see page 62)
- b.) All Paint (PNT)
  - 1.) Paint Color (see page 62)



c.) Veneer/Paint Combination

- 1.) Chassis Wood Species/Paint - Makore (MK2), Maple (MA2), Walnut (WA2), Double Cut (DC1) or Paint (PNT) (see page 62)
  - a.) Finish Color for Chassis (see page 62)
- 2.) Door Wood Species/Paint - Makore (MK2), Maple (MA2), Walnut (WA2), Double Cut (DC1) or Paint (PNT) (see page 62)
  - a.) Finish Color for Door (see page 62)



③ Insert Panel

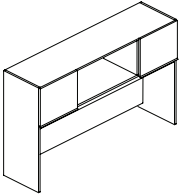

- a.) Veneer
  - 1.) Wood Species - Makore (MK2), Maple (MA2), Walnut (WA2) or Double Cut (DC1) (see page 62)
  - a.) Finish Color (see page 62)
- b.) Paint (PNT)
  - 1.) Paint Color (see page 62)
- c.) Back Painted Magnetic Glass
- d.) Fabric - vendor, pattern, color

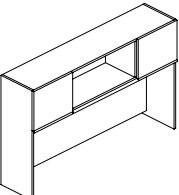
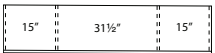
Note: Only one wood finish and one paint color can be specified per unit

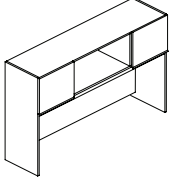
Description	D	W	H	CTN WT	CU FT	① Model	List Price
<b>18" d Storage Overhead Cabinet with 2 Doors and Open Center Shelf</b>  	18	66	41	197	35	AP4-BOS-4D-1866	<b>VENEER PANEL \$4,373</b> <b>PAINT PANEL \$4,373</b> <b>GLASS PANEL \$6,088</b> <b>FABRIC PANEL</b> <b>COM \$4,977</b> <b>A \$5,001</b> <b>B \$5,049</b> <b>C \$5,131</b> <b>D \$5,238</b> <b>E \$5,342</b> <b>F \$5,508</b> <b>G \$5,686</b> <b>H \$5,874</b> <b>I \$6,170</b> <b>J \$6,524</b>
<ul style="list-style-type: none"> <li>chassis and doors available in veneer or paint or veneer/paint combination</li> <li>required insert panel available in veneer, paint, magnetic back painted white glass or fabric, indicate selection on order and select appropriate list price</li> <li>aluminum mini shelf available, specify and add \$903 list</li> <li>glass insert panel has a thin aluminum frame</li> <li>pack of 6 magnets come with magnetic glass option</li> <li>task lights available, see pages 532-533</li> <li>1 1/2" wire access bottom across the bottom of back panel</li> <li>legal depth</li> <li>soft close hinge doors</li> <li>adjustable shelves</li> <li>aluminum valance rail</li> <li>finished, flush back panel</li> <li>fabric is railroaded</li> <li>locking doors available, specify and add \$246 list</li> <li>compartment height: 13 1/2"</li> <li>compartment depth: 16 1/2"</li> <li>worksurface to valance rail: 24 1/2"</li> <li>com ydg: 2</li> </ul>							

<b>15" d Storage Overhead Cabinet with 2 Doors and Open Center Shelf</b>  	15	66	41	182	29	AP4-BOS-4-1566	<b>VENEER PANEL \$4,247</b> <b>PAINT PANEL \$4,247</b> <b>GLASS PANEL \$5,962</b> <b>FABRIC PANEL</b> <b>COM \$4,850</b> <b>A \$4,875</b> <b>B \$4,922</b> <b>C \$5,004</b> <b>D \$5,110</b> <b>E \$5,215</b> <b>F \$5,381</b> <b>G \$5,560</b> <b>H \$5,747</b> <b>I \$6,044</b> <b>J \$6,396</b>
<ul style="list-style-type: none"> <li>chassis and doors available in veneer or paint or veneer/paint combination</li> <li>required insert panel available in veneer, paint, magnetic back painted white glass or fabric, indicate selection on order and select appropriate list price</li> <li>aluminum mini shelf available, specify and add \$903 list</li> <li>glass insert panel has a thin aluminum frame</li> <li>pack of 6 magnets come with magnetic glass option</li> <li>task lights available, see pages 532-533</li> <li>1 1/2" wire access bottom across the bottom of back panel</li> <li>letter depth</li> <li>soft close hinge doors</li> <li>adjustable shelves</li> <li>aluminum valance rail</li> <li>finished, flush back panel</li> <li>fabric is railroaded</li> <li>locking doors available, specify and add \$246 list</li> <li>compartment height: 13 1/2"</li> <li>compartment depth: 13 1/2"</li> <li>worksurface to valance rail: 24 1/2"</li> <li>com ydg: 2</li> </ul>							

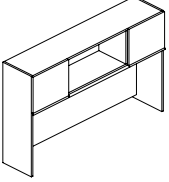
Description	D	W	H	CTN WT	CU FT	① Model	List Price
<b>18" d Storage Overhead Cabinet with 2 Doors and Open Center Shelf</b>  	18	60	41	183	32	<b>AP4-BOS-4D-1860</b>	<b>VENEER PANEL \$4,203</b> <b>PAINT PANEL \$4,203</b> <b>GLASS PANEL \$5,657</b> <b>FABRIC PANEL</b> <b>COM \$4,791</b> <b>A \$4,814</b> <b>B \$4,862</b> <b>C \$4,945</b> <b>D \$5,051</b> <b>E \$5,157</b> <b>F \$5,321</b> <b>G \$5,499</b> <b>H \$5,688</b> <b>I \$5,982</b> <b>J \$6,336</b>
	<ul style="list-style-type: none"> <li>chassis and doors available in veneer or paint or veneer/paint combination</li> <li>required insert panel available in veneer, paint, magnetic back painted white glass or fabric, indicate selection on order and select appropriate list price</li> <li>aluminum mini shelf available, specify and add \$853 list</li> <li>glass insert panel has a thin aluminum frame</li> <li>pack of 6 magnets come with magnetic glass option</li> <li>task lights available, see pages 532-533</li> <li>1 1/2" wire access bottom across the bottom of back panel</li> <li>legal depth</li> <li>soft close hinge doors</li> <li>adjustable shelves</li> <li>aluminum valance rail</li> <li>finished, flush back panel</li> <li>fabric is railroaded</li> <li>locking doors available, specify and add \$246 list</li> <li>compartment height: 13 1/2"</li> <li>compartment depth: 16 1/2"</li> <li>worksurface to valance rail: 24 1/2"</li> <li>com ydg: 2</li> </ul>						

<b>15" d Storage Overhead Cabinet with 2 Doors and Open Center Shelf</b>  	15	60	41	169	27	<b>AP4-BOS-4-1560</b>	<b>VENEER PANEL \$4,075</b> <b>PAINT PANEL \$4,075</b> <b>GLASS PANEL \$5,532</b> <b>FABRIC PANEL</b> <b>COM \$4,664</b> <b>A \$4,688</b> <b>B \$4,734</b> <b>C \$4,819</b> <b>D \$4,925</b> <b>E \$5,031</b> <b>F \$5,195</b> <b>G \$5,372</b> <b>H \$5,562</b> <b>I \$5,855</b> <b>J \$6,209</b>
	<ul style="list-style-type: none"> <li>chassis and doors available in veneer or paint or veneer/paint combination</li> <li>required insert panel available in veneer, paint, magnetic back painted white glass or fabric, indicate selection on order and select appropriate list price</li> <li>aluminum mini shelf available, specify and add \$853 list</li> <li>glass insert panel has a thin aluminum frame</li> <li>pack of 6 magnets come with magnetic glass option</li> <li>task lights available, see pages 532-533</li> <li>1 1/2" wire access bottom across the bottom of back panel</li> <li>letter depth</li> <li>soft close hinge doors</li> <li>adjustable shelves</li> <li>aluminum valance rail</li> <li>finished, flush back panel</li> <li>fabric is railroaded</li> <li>locking doors available, specify and add \$246 list</li> <li>compartment height: 13 1/2"</li> <li>compartment depth: 13 1/2"</li> <li>worksurface to valance rail: 24 1/2"</li> <li>com ydg: 2</li> </ul>						

**To Order, Specify:**

① Model Number

② Finish Application

- a.) All Veneer
  - 1.) Wood Species - Makore (MK2), Maple (MA2), Walnut (WA2) or Double Cut (DC1) (see page 62)
  - a.) Finish Color (see page 62)
- b.) All Paint (PNT)
  - 1.) Paint Color (see page 62)



c.) Veneer/Paint Combination



- 1.) Chassis Wood Species/Paint - Makore (MK2), Maple (MA2), Walnut (WA2), Double Cut (DC1) or Paint (PNT) (see page 62)
  - a.) Finish Color for Chassis (see page 62)
- 2.) Door Wood Species/Paint - Makore (MK2), Maple (MA2), Walnut (WA2), Double Cut (DC1) or Paint (PNT) (see page 62)
  - a.) Finish Color for Door (see page 62)

③ Insert Panel

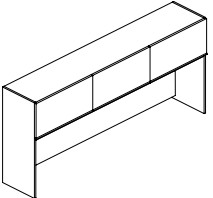
- a.) Veneer
  - 1.) Wood Species - Makore (MK2), Maple (MA2), Walnut (WA2) or Double Cut (DC1) (see page 62)
  - a.) Finish Color (see page 62)
- b.) Paint (PNT)
  - 1.) Paint Color (see page 62)
- c.) Back Painted Magnetic Glass
- d.) Fabric - vendor, pattern, color

Note: Only one wood finish and one paint color can be specified per unit

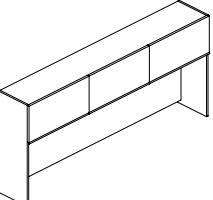
Description	D	W	H	CTN WT	CU FT	① Model	List Price	
<b>18" d Storage Overhead Cabinet with 3 Flipper Doors</b>	18	90	41	269	47	<b>AP4-BOS-FD-1890</b>	<b>VENEER PANEL \$6,020</b>	
  <ul style="list-style-type: none"> <li>· chassis and doors available in veneer or paint or veneer/paint combination</li> <li>· required insert panel available in veneer, paint, magnetic back painted white glass or fabric, indicate selection on order and select appropriate list price</li> <li>· aluminum mini shelf available, specify and add \$990 list</li> <li>· glass insert panel has a thin aluminum frame</li> <li>· task lights available, see pages 532-533</li> <li>· pack of 6 magnets come with magnetic glass option</li> <li>· 1 1/2" wire access bottom across the bottom of back panel</li> <li>· legal depth</li> <li>· vertical lift doors</li> <li>· aluminum valance rail</li> <li>· finished, flush back panel</li> <li>· fabric is railroaded</li> <li>· compartment height: 13 1/2"</li> <li>· compartment depth: 16 1/2"</li> <li>· worksurface to valance rail: 24 1/2"</li> <li>· com ydg: 2 3/4</li> </ul>							<b>PAINT PANEL \$6,020</b>	
								<b>GLASS PANEL \$8,374</b>
								<b>FABRIC PANEL</b>
								<b>COM \$6,821</b>
								<b>A \$6,855</b>
								<b>B \$6,918</b>
								<b>C \$7,033</b>
								<b>D \$7,179</b>
								<b>E \$7,324</b>
								<b>F \$7,552</b>
							<b>G \$7,795</b>	
							<b>H \$8,053</b>	
							<b>I \$8,459</b>	
							<b>J \$8,946</b>	

<b>15" d Storage Overhead Cabinet with 3 Flipper Doors</b>	15	90	41	251	40	<b>AP4-BOS-F-1590</b>	<b>VENEER PANEL \$5,895</b>	
  <ul style="list-style-type: none"> <li>· chassis and doors available in veneer or paint or veneer/paint combination</li> <li>· required insert panel available in veneer, paint, magnetic back painted white glass or fabric, indicate selection on order and select appropriate list price</li> <li>· aluminum mini shelf available, specify and add \$990 list</li> <li>· glass insert panel has a thin aluminum frame</li> <li>· pack of 6 magnets come with magnetic glass option</li> <li>· task lights available, see pages 532-533</li> <li>· 1 1/2" wire access bottom across the bottom of back panel</li> <li>· letter depth</li> <li>· vertical lift doors</li> <li>· aluminum valance rail</li> <li>· finished, flush back panel</li> <li>· fabric is railroaded</li> <li>· compartment height: 13 1/2"</li> <li>· compartment depth: 13 1/2"</li> <li>· worksurface to valance rail: 24 1/2"</li> <li>· com ydg: 2 3/4</li> </ul>							<b>PAINT PANEL \$5,895</b>	
								<b>GLASS PANEL \$8,247</b>
								<b>FABRIC PANEL</b>
								<b>COM \$6,694</b>
								<b>A \$6,727</b>
								<b>B \$6,790</b>
								<b>C \$6,907</b>
								<b>D \$7,052</b>
								<b>E \$7,197</b>
								<b>F \$7,425</b>
							<b>G \$7,670</b>	
							<b>H \$7,928</b>	
							<b>I \$8,333</b>	
							<b>J \$8,819</b>	

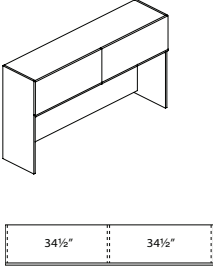
Description	D	W	H	CTN WT	CU FT	① Model	List Price
<b>18" d Storage Overhead Cabinet with 2 Flipper Doors</b> 	18	72	41	215	38	<b>AP4-BOS-FD-1872</b>	<b>VENEER PANEL</b> \$5,033
							<b>PAINT PANEL</b> \$5,033
<ul style="list-style-type: none"> <li>chassis and doors available in veneer or paint or veneer/paint combination</li> <li>required insert panel available in veneer, paint, magnetic back painted white glass or fabric, indicate selection on order and select appropriate list price</li> <li>aluminum mini shelf available, specify and add \$948 list</li> <li>glass insert panel has a thin aluminum frame</li> <li>pack of 6 magnets come with magnetic glass option</li> <li>task lights available, see pages 532-533</li> <li>1 1/2" wire access bottom across the bottom of back panel</li> <li>legal depth</li> <li>vertical lift doors</li> <li>aluminum valance rail</li> <li>finished, flush back panel</li> <li>fabric is railroaded</li> <li>compartment height: 13 1/2"</li> <li>compartment depth: 16 1/2"</li> <li>worksurface to valance rail: 24 1/2"</li> <li>com ydg: 2 1/4</li> </ul>							<b>GLASS PANEL</b> \$7,012
							<b>FABRIC PANEL</b>
							<b>COM</b> \$5,651
							<b>A</b> \$5,679
							<b>B</b> \$5,731
							<b>C</b> \$5,823
							<b>D</b> \$5,943
							<b>E</b> \$6,063
							<b>F</b> \$6,248
							<b>G</b> \$6,448
						<b>H</b> \$6,659	
						<b>I</b> \$6,990	
						<b>J</b> \$7,389	

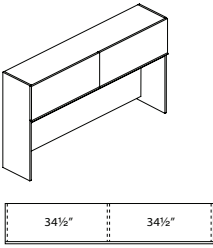
<b>15" d Storage Overhead Cabinet with 2 Flipper Doors</b> 	15	72	41	200	32	<b>AP4-BOS-F-1572</b>	<b>VENEER PANEL</b> \$4,905
							<b>PAINT PANEL</b> \$4,905
<ul style="list-style-type: none"> <li>chassis and doors available in veneer or paint or veneer/paint combination</li> <li>required insert panel available in veneer, paint, magnetic back painted white glass or fabric, indicate selection on order and select appropriate list price</li> <li>aluminum mini shelf available, specify and add \$948 list</li> <li>glass insert panel has a thin aluminum frame</li> <li>pack of 6 magnets come with magnetic glass option</li> <li>task lights available, see pages 532-533</li> <li>1 1/2" wire access bottom across the bottom of back panel</li> <li>letter depth</li> <li>vertical lift doors</li> <li>aluminum valance rail</li> <li>finished, flush back panel</li> <li>fabric is railroaded</li> <li>compartment height: 13 1/2"</li> <li>compartment depth: 13 1/2"</li> <li>worksurface to valance rail: 24 1/2"</li> <li>com ydg: 2 1/4</li> </ul>							<b>GLASS PANEL</b> \$6,885
							<b>FABRIC PANEL</b>
							<b>COM</b> \$5,523
							<b>A</b> \$5,550
							<b>B</b> \$5,605
							<b>C</b> \$5,697
							<b>D</b> \$5,817
							<b>E</b> \$5,936
							<b>F</b> \$6,122
							<b>G</b> \$6,321
						<b>H</b> \$6,533	
						<b>I</b> \$6,864	
						<b>J</b> \$7,262	

**To Order, Specify:**

① Model Number

② Finish Application

- a.) All Veneer
  - 1.) Wood Species - Makore (MK2), Maple (MA2), Walnut (WA2) or Double Cut (DC1) (see page 62)
  - a.) Finish Color (see page 62)
- b.) All Paint (PNT)
  - 1.) Paint Color (see page 62)

c.) Veneer/Paint Combination

- 1.) Chassis Wood Species/Paint - Makore (MK2), Maple (MA2), Walnut (WA2), Double Cut (DC1) or Paint (PNT) (see page 62)
  - a.) Finish Color for Chassis (see page 62)
- 2.) Door Wood Species/Paint - Makore (MK2), Maple (MA2), Walnut (WA2), Double Cut (DC1) or Paint (PNT) (see page 62)
  - a.) Finish Color for Door (see page 62)

③ Insert Panel

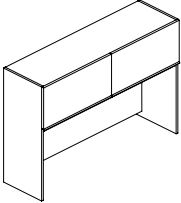
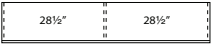

- a.) Veneer
  - 1.) Wood Species - Makore (MK2), Maple (MA2), Walnut (WA2) or Double Cut (DC1) (see page 62)
  - a.) Finish Color (see page 62)
- b.) Paint (PNT)
  - 1.) Paint Color (see page 62)
- c.) Back Painted Magnetic Glass
- d.) Fabric - vendor, pattern, color

Note: Only one wood finish and one paint color can be specified per unit

Description	D	W	H	CTN WT	CU FT	① Model	List Price
<b>18" d Storage Overhead Cabinet with 2 Flipper Doors</b>    	18	60	41	185	32	<b>AP4-BOS-FD-1860</b>	<b>VENEER PANEL \$4,837</b>
							<b>PAINT PANEL \$4,837</b>
<ul style="list-style-type: none"> <li>· chassis and doors available in veneer or paint or veneer/paint combination</li> <li>· required insert panel available in veneer, paint, magnetic back painted white glass or fabric, indicate selection on order and select appropriate list price</li> <li>· aluminum mini shelf available, specify and add \$853 list</li> <li>· glass insert panel has a thin aluminum frame</li> <li>· pack of 6 magnets come with magnetic glass option</li> <li>· task lights available, see pages 532-533</li> <li>· 1 1/2" wire access bottom across the bottom of back panel</li> <li>· legal depth</li> <li>· vertical lift doors</li> <li>· aluminum valance rail</li> <li>· finished, flush back panel</li> <li>· fabric is railroaded</li> <li>· compartment height: 13 1/2"</li> <li>· compartment depth: 16 1/2"</li> <li>· worksurface to valance rail: 24 1/2"</li> <li>· com ydg: 2</li> </ul>							<b>GLASS PANEL \$6,291</b>
							<b>FABRIC PANEL</b>
							<b>COM \$5,422</b>
							<b>A \$5,447</b>
							<b>B \$5,496</b>
							<b>C \$5,578</b>
							<b>D \$5,685</b>
							<b>E \$5,789</b>
							<b>F \$5,954</b>
							<b>G \$6,133</b>
							<b>H \$6,321</b>
							<b>I \$6,616</b>
							<b>J \$6,970</b>

APOGEE™

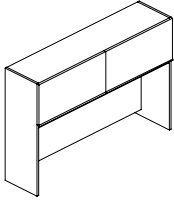

Description	D	W	H	CTN WT	CU FT	① Model	List Price
<b>15"d Storage Overhead Cabinet with 2 Flipper Doors</b>  	15	60	41	172	27	<b>AP4-BOS-F-1560</b>	<b>VENEER PANEL \$4,709</b> <b>PAINT PANEL \$4,709</b> <b>GLASS PANEL \$6,166</b> <b>FABRIC PANEL</b> <b>COM \$5,298</b> <b>A \$5,321</b> <b>B \$5,368</b> <b>C \$5,452</b> <b>D \$5,559</b> <b>E \$5,664</b> <b>F \$5,828</b> <b>G \$6,006</b> <b>H \$6,195</b> <b>I \$6,489</b> <b>J \$6,843</b>
<ul style="list-style-type: none"> <li>· chassis and doors available in veneer or paint or veneer/paint combination</li> <li>· required insert panel available in veneer, paint, magnetic back painted white glass or fabric, indicate selection on order and select appropriate list price</li> <li>· aluminum mini shelf available, specify and add \$853 list</li> <li>· glass insert panel has a thin aluminum frame</li> <li>· pack of 6 magnets come with magnetic glass option</li> <li>· task lights available, see pages 532-533</li> <li>· 1 1/2" wire access bottom across the bottom of back panel</li> <li>· letter depth</li> <li>· vertical lift doors</li> <li>· aluminum valance rail</li> <li>· finished, flush back panel</li> <li>· fabric is railroaded</li> <li>· compartment height: 13 1/2"</li> <li>· compartment depth: 13 1/2"</li> <li>· worksurface to valance rail: 24 1/2"</li> <li>· com ydg: 2</li> </ul>							

APOGEE™

**To Order, Specify:**

① Model Number

② Finish Application

a.) All Veneer

- 1.) Wood Species - Makore (MK2), Maple (MA2), Walnut (WA2) or Double Cut (DC1) (see page 62)

a.) Finish Color (see page 62)

b.) All Paint (PNT)

- 1.) Paint Color (see page 62)

c.) Veneer/Paint Combination

- 1.) Chassis Wood Species/Paint - Makore (MK2), Maple (MA2), Walnut (WA2), Double Cut (DC1) or Paint (PNT) (see page 62)

a.) Finish Color for Chassis (see page 62)

- 2.) Door Wood Species/Paint - Makore (MK2), Maple (MA2), Walnut (WA2), Double Cut (DC1) or Paint (PNT) (see page 62)

a.) Finish Color for Door (see page 62)

③ Insert Panel

a.) Veneer

- 1.) Wood Species - Makore (MK2), Maple (MA2), Walnut (WA2) or Double Cut (DC1) (see page 62)

a.) Finish Color (see page 62)

b.) Paint (PNT)

- 1.) Paint Color (see page 62)

c.) Back Painted Magnetic Glass

d.) Fabric - vendor, pattern, color

Note: Only one wood finish and one paint color can be specified per unit

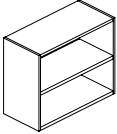
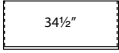
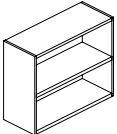
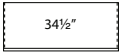
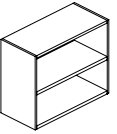
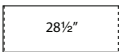
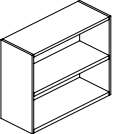
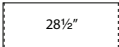
Description	D	W	H	CTN WT	CU FT	① Model	List Price
<b>17" d Double Height Wall Mount Overhead Cabinet with Open Storage</b>  	17	36	30	70	14	AM4-BOX-1D-1736	\$2,424
<ul style="list-style-type: none"> <li>· legal depth storage</li> <li>· mounting hardware included</li> <li>· valance rail highly recommended, see page 133</li> <li>· upper compartment height: 13 1/2"</li> <li>· lower compartment height: 14 1/4"</li> <li>· compartment depth: 16 1/4"</li> </ul>							
<b>14" d Double Height Wall Mount Overhead Cabinet with Open Storage</b>  	14	36	30	62	12	AM4-BOX-1-1436	\$2,297
<ul style="list-style-type: none"> <li>· letter depth storage</li> <li>· mounting hardware included</li> <li>· valance rail highly recommended, see page 133</li> <li>· upper compartment height: 13 1/2"</li> <li>· lower compartment height: 14 1/4"</li> <li>· compartment depth: 13 1/4"</li> </ul>							
<b>17" d Double Height Wall Mount Overhead Cabinet with Open Storage</b>  	17	30	30	62	12	AM4-BOX-1D-1730	\$2,348
<ul style="list-style-type: none"> <li>· legal depth storage</li> <li>· mounting hardware included</li> <li>· valance rail highly recommended, see page 133</li> <li>· upper compartment height: 13 1/2"</li> <li>· lower compartment height: 14 1/4"</li> <li>· compartment depth: 16 1/4"</li> </ul>							
<b>14" d Double Height Wall Mount Overhead Cabinet with Open Storage</b>  	14	30	30	54	10	AM4-BOX-1-1430	\$2,221
<ul style="list-style-type: none"> <li>· letter depth storage</li> <li>· mounting hardware included</li> <li>· valance rail highly recommended, see page 133</li> <li>· upper compartment height: 13 1/2"</li> <li>· lower compartment height: 14 1/4"</li> <li>· compartment depth: 13 1/4"</li> </ul>							

APOGEE™

Description	D	W	H	CTN WT	CU FT	① Model	List Price
<b>18"d Double Height Wall Mount Overhead Cabinet with 4 Doors</b>	18	72	30	203	28	<b>AM4-BBX-1D-1872</b>	<b>\$4,057</b>

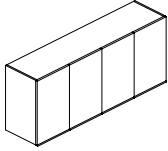

- legal depth storage
- mounting hardware included
- locking doors available, specify and add \$369 list
- valance rail highly recommended, see page 133
- compartment height: 28 ¼"
- compartment depth: 16 ½"

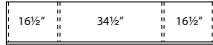

<b>15"d Double Height Wall Mount Overhead Cabinet with 4 Doors</b>	15	72	30	182	24	<b>AM4-BBX-1-1572</b>	<b>\$3,930</b>
--	----	----	----	-----	----	-----------------------	----------------

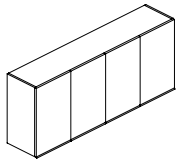

- letter depth storage
- mounting hardware included
- locking doors available, specify and add \$369 list
- valance rail highly recommended, see page 133
- compartment height: 28 ¼"
- compartment depth: 13 ½"

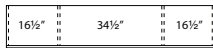

**To Order, Specify:**

**Open Storage**

- ① Model Number
- ② Wood Species/Paint - Makore (MK2), Maple (MA2), Walnut (WA2) or Double Cut (DC1) or Paint (PNT) (see page 62)
- ③ Finish Color (see page 62)

**Overhead Cabinet**

- ① Model Number
- ② Finish Application
  - a.) All Veneer
    - 1.) Wood Species - Makore (MK2), Maple (MA2), Walnut (WA2) or Double Cut (DC1) (see page 62)
      - a.) Finish Color (see page 62)
    - b.) All Paint (PNT)
      - 1.) Paint Color (see page 62)

- c.) Veneer/Paint Combination
  - 1.) Chassis Wood Species/Paint - Makore (MK2), Maple (MA2), Walnut (WA2), Double Cut (DC1) or Paint (PNT) (see page 62)
    - a.) Finish Color for Chassis (see page 62)
  - 2.) Door Wood Species/Paint - Makore (MK2), Maple (MA2), Walnut (WA2), Double Cut (DC1) or Paint (PNT) (see page 62)
    - a.) Finish Color for Door (see page 62)

Note: Only one wood finish and one paint color can be specified per unit

APOGEE™

Description	D	W	H	CTN WT	CU FT	① Model	List Price
<b>18" d Double Height Wall Mount Overhead Cabinet with 4 Doors</b>	18	60	30	179	24	<b>AM4-BBX-1D-1860</b>	<b>\$3,803</b>

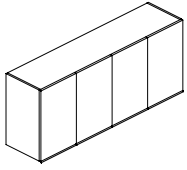

- legal depth storage
- mounting hardware included
- locking doors available, specify and add \$369 list
- valance rail highly recommended, see page 133
- compartment height: 28 1/2"
- compartment depth: 16 1/2"

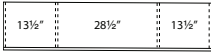

<b>15" d Double Height Wall Mount Overhead Cabinet with 4 Doors</b>	15	60	30	160	20	<b>AM4-BBX-1-1560</b>	<b>\$3,676</b>
---	----	----	----	-----	----	-----------------------	----------------

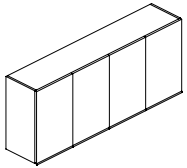

- letter depth storage
- mounting hardware included
- locking doors available, specify and add \$369 list
- valance rail highly recommended, see page 133
- compartment height: 28 1/2"
- compartment depth: 13 1/2"

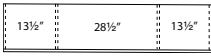

<b>18" d Double Height Wall Mount Overhead Cabinet with 3 Doors</b>	18	54	30	148	21	<b>AM4-BBX-1D-1854R</b>	<b>\$3,361</b>
	18	54	30	148	21	<b>AM4-BBX-1D-1854L</b>	<b>\$3,361</b>

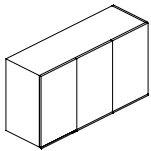

- legal depth storage
- mounting hardware included
- locking doors available, specify and add \$246 list
- valance rail highly recommended, see page 133
- compartment height: 28 1/2"
- compartment depth: 16 1/2"

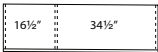

left shown

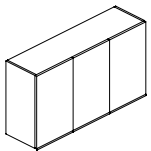

<b>15" d Double Height Wall Mount Overhead Cabinet with 3 Doors</b>	15	54	30	133	18	<b>AM4-BBX-1-1554R</b>	<b>\$3,234</b>
	15	54	30	133	18	<b>AM4-BBX-1-1554L</b>	<b>\$3,234</b>



- letter depth storage
- mounting hardware included
- locking doors available, specify and add \$246 list
- valance rail highly recommended, see page 133
- compartment height: 28 1/2"
- compartment depth: 13 1/2"

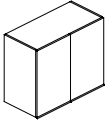
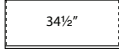
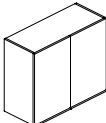
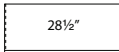
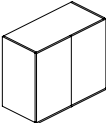
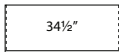
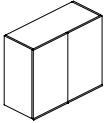

left shown

Description	D	W	H	CTN WT	CU FT	① Model	List Price
<b>18" d Double Height Wall Mount Overhead Cabinet with 2 Doors</b>  	18	36	30	94	15	<b>AM4-BBX-1D-1836</b>	<b>\$2,866</b>
<ul style="list-style-type: none"> <li>· legal depth storage</li> <li>· mounting hardware included</li> <li>· locking doors available, specify and add \$123 list</li> <li>· valance rail highly recommended, see page 133</li> <li>· compartment height: 28 1/2"</li> <li>· compartment depth: 16 1/2"</li> </ul>							
<b>15" d Double Height Wall Mount Overhead Cabinet with 2 Doors</b>  	15	36	30	84	12	<b>AM4-BBX-1-1536</b>	<b>\$2,739</b>
<ul style="list-style-type: none"> <li>· letter depth storage</li> <li>· mounting hardware included</li> <li>· locking doors available, specify and add \$123 list</li> <li>· valance rail highly recommended, see page 133</li> <li>· compartment height: 28 1/2"</li> <li>· compartment depth: 13 1/2"</li> </ul>							
<b>18" d Double Height Wall Mount Overhead Cabinet with 2 Doors</b>  	18	30	30	81	12	<b>AM4-BBX-1D-1830</b>	<b>\$2,790</b>
<ul style="list-style-type: none"> <li>· legal depth storage</li> <li>· mounting hardware included</li> <li>· locking doors available, specify and add \$123 list</li> <li>· valance rail highly recommended, see page 133</li> <li>· compartment height: 28 1/2"</li> <li>· compartment depth: 16 1/2"</li> </ul>							
<b>15" d Double Height Wall Mount Overhead Cabinet with 2 Doors</b>  	15	30	30	73	10	<b>AM4-BBX-1-1530</b>	<b>\$2,663</b>
<ul style="list-style-type: none"> <li>· letter depth storage</li> <li>· mounting hardware included</li> <li>· locking doors available, specify and add \$123 list</li> <li>· valance rail highly recommended, see page 133</li> <li>· compartment height: 28 1/2"</li> <li>· compartment depth: 13 1/2"</li> </ul>							

**To Order, Specify:**

- ① Model Number
- ② Finish Application
  - a.) All Veneer
    - 1.) Wood Species - Makore (MK2), Maple (MA2), Walnut (WA2) or Double Cut (DC1) (see page 62)
      - a.) Finish Color (see page 62)
    - b.) All Paint (PNT)
      - 1.) Paint Color (see page 62)
  - c.) Veneer/Paint Combination
    - 1.) Chassis Wood Species/Paint - Makore (MK2), Maple (MA2), Walnut (WA2), Double Cut (DC1) or Paint (PNT) (see page 62)
      - a.) Finish Color for Chassis (see page 62)
    - 2.) Door Wood Species/Paint - Makore (MK2), Maple (MA2), Walnut (WA2), Double Cut (DC1) or Paint (PNT) (see page 62)
      - a.) Finish Color for Door (see page 62)

Note: Only one wood finish and one paint color can be specified per unit

Description	D	W	H	CTN WT	CU FT	① Model	List Price
-------------	---	---	---	--------	-------	---------	------------

**18" d Double Height Wall Mount Overhead Cabinet with 4 Doors and Open Storage**

18	72	30	182	28	AM4-BDX-1D-1872	\$3,676
----	----	----	-----	----	-----------------	---------

- legal depth storage
- mounting hardware included
- locking doors available, specify and add \$369 list
- valance rail highly recommended, see page 133
- upper compartment height: 13 1/2"
- lower compartment height: 14 1/4"
- compartment depth: 16 1/4"

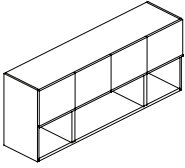

**15" d Double Height Wall Mount Overhead Cabinet with 4 Doors and Open Storage**

15	72	30	161	24	AM4-BCX-1-1572	\$3,551
----	----	----	-----	----	----------------	---------

- letter depth storage
- mounting hardware included
- locking doors available, specify and add \$369 list
- valance rail highly recommended, see page 133
- upper compartment height: 13 1/2"
- lower compartment height: 14 1/4"
- compartment depth: 13 1/4"

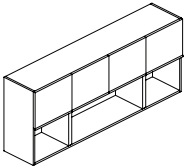

**18" d Double Height Wall Mount Overhead Cabinet with 4 Doors and Open Storage**

18	60	30	161	24	AM4-BDX-1D-1860	\$3,424
----	----	----	-----	----	-----------------	---------

- legal depth storage
- mounting hardware included
- locking doors available, specify and add \$369 list
- valance rail highly recommended, see page 133
- upper compartment height: 13 1/2"
- lower compartment height: 14 1/4"
- compartment depth: 16 1/4"

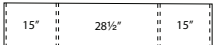
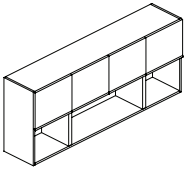

**15" d Double Height Wall Mount Overhead Cabinet with 4 Doors and Open Storage**

15	60	30	143	20	AM4-BCX-1-1560	\$3,296
----	----	----	-----	----	----------------	---------

- letter depth storage
- mounting hardware included
- locking doors available, specify and add \$369 list
- valance rail highly recommended, see page 133
- upper compartment height: 13 1/2"
- lower compartment height: 14 1/4"
- compartment depth: 13 1/4"

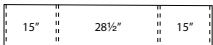
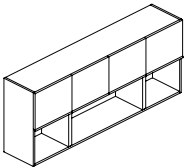

APOGEE™

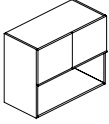
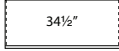
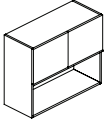
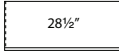
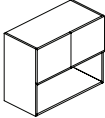
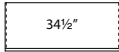
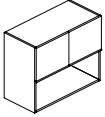
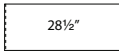
Description	D	W	H	CTN WT	CU FT	① Model	List Price
<b>18" d Double Height Wall Mount Overhead Cabinet with 2 Doors and Open Storage</b>  	18	36	30	83	15	<b>AM4-BDX-1D-1836</b>	<b>\$2,676</b>
<ul style="list-style-type: none"> <li>• legal depth storage</li> <li>• mounting hardware included</li> <li>• locking doors available, specify and add \$123 list</li> <li>• valance rail highly recommended, see page 133</li> <li>• upper compartment height: 13 1/2"</li> <li>• lower compartment height: 14 1/4"</li> <li>• compartment depth: 16 1/4"</li> </ul>							
<b>15" d Double Height Wall Mount Overhead Cabinet with 2 Doors and Open Storage</b>  	15	36	30	74	12	<b>AM4-BCX-1-1536</b>	<b>\$2,550</b>
<ul style="list-style-type: none"> <li>• letter depth storage</li> <li>• mounting hardware included</li> <li>• locking doors available, specify and add \$123 list</li> <li>• valance rail highly recommended, see page 133</li> <li>• upper compartment height: 13 1/2"</li> <li>• lower compartment height: 14 1/4"</li> <li>• compartment depth: 13 1/4"</li> </ul>							
<b>18" d Double Height Wall Mount Overhead Cabinet with 2 Doors and Open Storage</b>  	18	30	30	72	12	<b>AM4-BDX-1D-1830</b>	<b>\$2,601</b>
<ul style="list-style-type: none"> <li>• legal depth storage</li> <li>• mounting hardware included</li> <li>• locking doors available, specify and add \$123 list</li> <li>• valance rail highly recommended, see page 133</li> <li>• upper compartment height: 13 1/2"</li> <li>• lower compartment height: 14 1/4"</li> <li>• compartment depth: 16 1/4"</li> </ul>							
<b>15" d Double Height Wall Mount Overhead Cabinet with 2 Doors and Open Storage</b>  	15	30	30	64	10	<b>AM4-BCX-1-1530</b>	<b>\$2,473</b>
<ul style="list-style-type: none"> <li>• letter depth storage</li> <li>• mounting hardware included</li> <li>• locking doors available, specify and add \$123 list</li> <li>• valance rail highly recommended, see page 133</li> <li>• upper compartment height: 13 1/2"</li> <li>• lower compartment height: 14 1/4"</li> <li>• compartment depth: 13 1/4"</li> </ul>							

**To Order, Specify:**

- ① Model Number
- ② Finish Application
  - a.) All Veneer
    - 1.) Wood Species - Makore (MK2), Maple (MA2), Walnut (WA2) or Double Cut (DC1) (see page 62)
      - a.) Finish Color (see page 62)
    - b.) All Paint (PNT)
      - 1.) Paint Color (see page 62)
  - c.) Veneer/Paint Combination
    - 1.) Chassis Wood Species/Paint - Makore (MK2), Maple (MA2), Walnut (WA2), Double Cut (DC1) or Paint (PNT) (see page 62)
      - a.) Finish Color for Chassis (see page 62)
    - 2.) Door Wood Species/Paint - Makore (MK2), Maple (MA2), Walnut (WA2), Double Cut (DC1) or Paint (PNT) (see page 62)
      - a.) Finish Color for Door (see page 62)

Note: Only one wood finish and one paint color can be specified per unit

Description	D	W	H	CTN WT	CU FT	① Model	List Price
<b>17" d Wall Mount Overhead Cabinet with Open Storage</b>	17	36	15	42	8	<b>AM4-BOW-1D-1736</b>	<b>\$1,942</b>

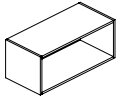

- legal depth storage
- mounting hardware included
- valance rail highly recommended, see page 133
- compartment height: 13 1/2"
- compartment depth: 16 1/4"

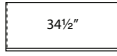

APOGEE™

<b>14" d Wall Mount Overhead Cabinet with Open Storage</b>	14	36	15	36	6	<b>AM4-BOW-1-1436</b>	<b>\$1,816</b>
--	----	----	----	----	---	-----------------------	----------------

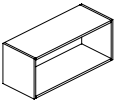

- letter depth storage
- mounting hardware included
- valance rail highly recommended, see page 133
- compartment height: 13 1/2"
- compartment depth: 13 1/4"

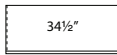

<b>17" d Wall Mount Overhead Cabinet with Open Storage</b>	17	30	15	36	6	<b>AM4-BOW-1D-1730</b>	<b>\$1,866</b>
--	----	----	----	----	---	------------------------	----------------

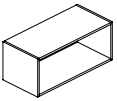

- legal depth storage
- mounting hardware included
- valance rail highly recommended, see page 133
- compartment height: 13 1/2"
- compartment depth: 16 1/4"

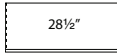

<b>14" d Wall Mount Overhead Cabinet with Open Storage</b>	14	30	15	32	5	<b>AM4-BOW-1-1430</b>	<b>\$1,739</b>
--	----	----	----	----	---	-----------------------	----------------

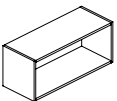

- letter depth storage
- mounting hardware included
- valance rail highly recommended, see page 133
- compartment height: 13 1/2"
- compartment depth: 13 1/4"





Description	D	W	H	CTN WT	CU FT	① Model	List Price
18"d Wall Mount Overhead Cabinet with 4 Doors	18	72	15	116	15	AM4-BBW-1D-1872	\$3,208

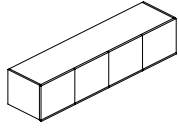

- legal depth storage
- mounting hardware included
- locking doors available, specify and add \$369 list
- valance rail highly recommended, see page 133
- compartment height: 13 1/2"
- compartment depth: 16 1/4"



15"d Wall Mount Overhead Cabinet with 4 Doors	15	72	15	104	13	AM4-BBW-1-1572	\$3,083
---	----	----	----	-----	----	----------------	---------

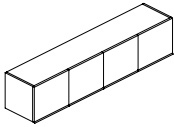

- letter depth storage
- mounting hardware included
- locking doors available, specify and add \$369 list
- valance rail highly recommended, see page 133
- compartment height: 13 1/2"
- compartment depth: 13 1/4"

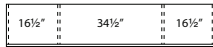

**To Order, Specify:**

**Open Storage**

- ① Model Number
- ② Wood Species/Paint - Makore (MK2), Maple (MA2), Walnut (WA2) or Double Cut (DC1) or Paint (PNT) (see page 62)
- ③ Finish Color (see page 62)

Note: Only one wood finish and one paint color can be specified per unit

**Overhead Cabinet**

- ① Model Number
- ② Finish Application
  - a.) All Veneer
    - 1.) Wood Species - Makore (MK2), Maple (MA2), Walnut (WA2) or Double Cut (DC1) (see page 62)
      - a.) Finish Color (see page 62)
    - b.) All Paint (PNT)
      - 1.) Paint Color (see page 62)

- c.) Veneer/Paint Combination
  - 1.) Chassis Wood Species/Paint - Makore (MK2), Maple (MA2), Walnut (WA2), Double Cut (DC1) or Paint (PNT) (see page 62)
    - a.) Finish Color for Chassis (see page 62)
  - 2.) Door Wood Species/Paint - Makore (MK2), Maple (MA2), Walnut (WA2), Double Cut (DC1) or Paint (PNT) (see page 62)
    - a.) Finish Color for Door (see page 62)

Description	D	W	H	CTN WT	CU FT	① Model	List Price
<b>18" d Wall Mount Overhead Cabinet with 4 Doors</b>	18	60	15	102	13	AM4-BBW-1D-1860	\$3,018

- legal depth storage
- mounting hardware included
- locking doors available, specify and add \$369 list
- valance rail highly recommended, see page 133
- compartment height: 13 1/2"
- compartment depth: 16 1/4"

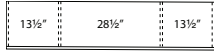
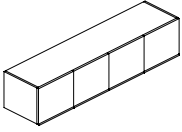

APOGEE™

<b>15" d Wall Mount Overhead Cabinet with 4 Doors</b>	15	60	15	91	11	AM4-BBW-1-1560	\$2,891
---	----	----	----	----	----	----------------	---------

- letter depth storage
- mounting hardware included
- locking doors available, specify and add \$369 list
- valance rail highly recommended, see page 133
- compartment height: 13 1/2"
- compartment depth: 13 1/4"

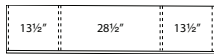
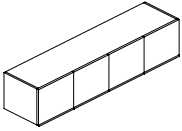

<b>18" d Wall Mount Overhead Cabinet with 3 Doors</b>	18	54	15	85	12	AM4-BBW-1D-1854R	\$2,575
	18	54	15	85	12	AM4-BBW-1D-1854L	\$2,575

- legal depth storage
- mounting hardware included
- locking doors available, specify and add \$246 list
- valance rail highly recommended, see page 133
- compartment height: 13 1/2"
- compartment depth: 16 1/4"

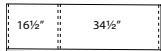
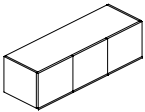



left shown

<b>15" d Wall Mount Overhead Cabinet with 3 Doors</b>	15	54	15	76	10	AM4-BBW-1-1554R	\$2,449
	15	54	15	76	10	AM4-BBW-1-1554L	\$2,449

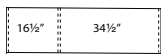
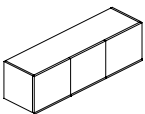
- letter depth storage
- mounting hardware included
- locking doors available, specify and add \$246 list
- valance rail highly recommended, see page 133
- compartment height: 13 1/2"
- compartment depth: 13 1/4"

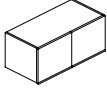
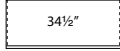
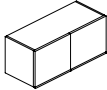

left shown

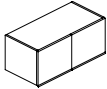
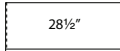
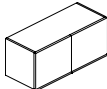
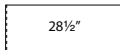
Description	D	W	H	CTN WT	CU FT	① Model	List Price
<b>18" d Wall Mount Overhead Cabinet with 2 Doors</b>  	18	36	15	54	8	AM4-BBW-1D-1836	\$2,131
<ul style="list-style-type: none"> <li>· legal depth storage</li> <li>· mounting hardware included</li> <li>· locking doors available, specify and add \$123 list</li> <li>· valance rail highly recommended, see page 133</li> <li>· compartment height: 13 1/2"</li> <li>· compartment depth: 16 1/4"</li> </ul>							
<b>15" d Wall Mount Overhead Cabinet with 2 Doors</b>  	15	36	15	49	7	AM4-BBW-1-1536	\$2,004
<ul style="list-style-type: none"> <li>· letter depth storage</li> <li>· mounting hardware included</li> <li>· locking doors available, specify and add \$123 list</li> <li>· valance rail highly recommended, see page 133</li> <li>· compartment height: 13 1/2"</li> <li>· compartment depth: 13 1/4"</li> </ul>							
<b>18" d Wall Mount Overhead Cabinet with 2 Doors</b>  	18	30	15	47	7	AM4-BBW-1D-1830	\$2,004
<ul style="list-style-type: none"> <li>· legal depth storage</li> <li>· mounting hardware included</li> <li>· locking doors available, specify and add \$123 list</li> <li>· valance rail highly recommended, see page 133</li> <li>· compartment height: 13 1/2"</li> <li>· compartment depth: 16 1/4"</li> </ul>							
<b>15" d Wall Mount Overhead Cabinet with 2 Doors</b>  	15	30	15	42	6	AM4-BBW-1-1530	\$1,878
<ul style="list-style-type: none"> <li>· letter depth storage</li> <li>· mounting hardware included</li> <li>· locking doors available, specify and add \$123 list</li> <li>· valance rail highly recommended, see page 133</li> <li>· compartment height: 13 1/2"</li> <li>· compartment depth: 13 1/4"</li> </ul>							

**To Order, Specify:**

- ① Model Number
- ② Finish Application
  - a.) All Veneer
    - 1.) Wood Species - Makore (MK2), Maple (MA2), Walnut (WA2) or Double Cut (DC1) (see page 62)
    - a.) Finish Color (see page 62)
  - b.) All Paint (PNT)
    - 1.) Paint Color (see page 62)
  - c.) Veneer/Paint Combination
    - 1.) Chassis Wood Species/Paint - Makore (MK2), Maple (MA2), Walnut (WA2), Double Cut (DC1) or Paint (PNT) (see page 62)
      - a.) Finish Color for Chassis (see page 62)
    - 2.) Door Wood Species/Paint - Makore (MK2), Maple (MA2), Walnut (WA2), Double Cut (DC1) or Paint (PNT) (see page 62)
      - a.) Finish Color for Door (see page 62)

Note: Only one wood finish and one paint color can be specified per unit

Description	D	W	H	CTN WT	CU FT	① Model	List Price
<b>18" d Wall Mount Overhead Cabinet with 2 Flipper Doors</b>	18	72	15	108	15	<b>AM4-BBW-FD-1872</b>	<b>\$3,462</b>

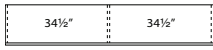
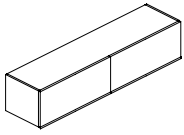

- legal depth storage
- vertical lift doors
- mounting hardware included
- valance rail highly recommended, see page 133
- compartment height: 13 1/2"
- compartment depth: 16 1/4"

<b>15" d Wall Mount Overhead Cabinet with 2 Flipper Doors</b>	15	72	15	97	13	<b>AM4-BBW-F-1572</b>	<b>\$3,334</b>
---	----	----	----	----	----	-----------------------	----------------

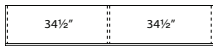
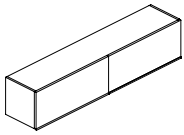

- letter depth storage
- vertical lift doors
- mounting hardware included
- valance rail highly recommended, see page 133
- compartment height: 13 1/2"
- compartment depth: 13 1/2"

<b>18" d Wall Mount Overhead Cabinet with 2 Flipper Doors</b>	18	60	15	94	13	<b>AM4-BBW-FD-1860</b>	<b>\$3,271</b>
---	----	----	----	----	----	------------------------	----------------

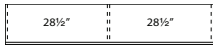
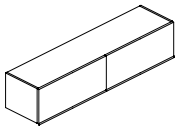

- legal depth storage
- vertical lift doors
- mounting hardware included
- valance rail highly recommended, see page 133
- compartment height: 13 1/2"
- compartment depth: 16 1/4"

<b>15" d Wall Mount Overhead Cabinet with 2 Flipper Doors</b>	15	60	15	84	11	<b>AM4-BBW-F-1560</b>	<b>\$3,144</b>
---	----	----	----	----	----	-----------------------	----------------

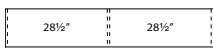
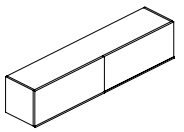

- letter depth storage
- vertical lift doors
- mounting hardware included
- valance rail highly recommended, see page 133
- compartment height: 13 1/2"
- compartment depth: 13 1/2"

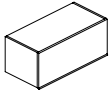
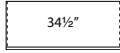
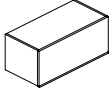
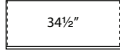
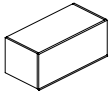
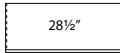
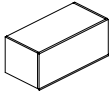
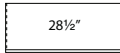
Description	D	W	H	CTN WT	CU FT	① Model	List Price
<b>18" d Wall Mount Overhead Cabinet with Flipper Door</b>  	18	36	15	54	8	AM4-BBW-FD-1836	\$2,258
<ul style="list-style-type: none"> <li>· legal depth storage</li> <li>· vertical lift doors</li> <li>· mounting hardware included</li> <li>· valance rail highly recommended, see page 133</li> <li>· compartment height: 13 1/2"</li> <li>· compartment depth: 16 1/4"</li> </ul>							
<b>15" d Wall Mount Overhead Cabinet with Flipper Door</b>  	15	36	15	49	7	AM4-BBW-F-1536	\$2,131
<ul style="list-style-type: none"> <li>· letter depth storage</li> <li>· vertical lift doors</li> <li>· mounting hardware included</li> <li>· valance rail highly recommended, see page 133</li> <li>· compartment height: 13 1/2"</li> <li>· compartment depth: 13 1/2"</li> </ul>							
<b>18" d Wall Mount Overhead Cabinet with Flipper Door</b>  	18	30	15	47	7	AM4-BBW-FD-1830	\$2,195
<ul style="list-style-type: none"> <li>· legal depth storage</li> <li>· vertical lift doors</li> <li>· mounting hardware included</li> <li>· valance rail highly recommended, see page 133</li> <li>· compartment height: 13 1/2"</li> <li>· compartment depth: 16 1/4"</li> </ul>							
<b>15" d Wall Mount Overhead Cabinet with Flipper Door</b>  	15	30	15	43	6	AM4-BBW-F-1530	\$2,068
<ul style="list-style-type: none"> <li>· letter depth storage</li> <li>· vertical lift doors</li> <li>· mounting hardware included</li> <li>· valance rail highly recommended, see page 133</li> <li>· compartment height: 13 1/2"</li> <li>· compartment depth: 13 1/2"</li> </ul>							

**To Order, Specify:**

- ① Model Number
- ② Finish Application
  - a.) All Veneer
    - 1.) Wood Species - Makore (MK2), Maple (MA2), Walnut (WA2) or Double Cut (DC1) (see page 62)
    - a.) Finish Color (see page 62)
  - b.) All Paint (PNT)
    - 1.) Paint Color (see page 62)
- c.) Veneer/Paint Combination
  - 1.) Chassis Wood Species/Paint - Makore (MK2), Maple (MA2), Walnut (WA2), Double Cut (DC1) or Paint (PNT) (see page 62)
    - a.) Finish Color for Chassis (see page 62)
  - 2.) Door Wood Species/Paint - Makore (MK2), Maple (MA2), Walnut (WA2), Double Cut (DC1) or Paint (PNT) (see page 62)
    - a.) Finish Color for Door (see page 62)

Note: Only one wood finish and one paint color can be specified per unit

Description	D	W	H	CTN WT	CU FT	① Model	List Price
17" d Open End Shelves	17	36	29¼	121	14	AM4-BOX-ED-1736R	\$2,232
	17	36	29¼	121	14	AM4-BOX-ED-1736L	\$2,232
	17	30	29¼	104	12	AM4-BOX-ED-1730R	\$2,157
	17	30	29¼	104	12	AM4-BOX-ED-1730L	\$2,157

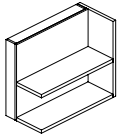

left shown

- use with overhead cabinet
- match with legal depth storage
- wall mounted
- mounting hardware included
- valance rail highly recommended
- shelf depth: 12 ½"

14" d Open End Shelves	14	36	29¼	115	12	AM4-BOX-E-1436R	\$2,105
	14	36	29¼	115	12	AM4-BOX-E-1436L	\$2,105
	14	30	29¼	98	10	AM4-BOX-E-1430R	\$2,030
	14	30	29¼	98	10	AM4-BOX-E-1430L	\$2,030

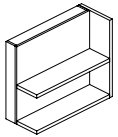

left shown

- use with overhead cabinet
- match with letter depth storage
- wall mounted
- mounting hardware included
- valance rail highly recommended
- shelf depth: 10"

17" d Open End Shelf	17	36	15	70	8	AM4-BOW-ED-1736R	\$1,751
	17	36	15	70	8	AM4-BOW-ED-1736L	\$1,751
	17	30	15	59	6	AM4-BOW-ED-1730R	\$1,675
	17	30	15	59	6	AM4-BOW-ED-1730L	\$1,675

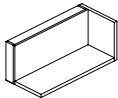

left shown

- use with overhead cabinet
- match with legal depth storage
- wall mounted
- mounting hardware included
- valance rail highly recommended
- shelf depth: 12 ½"

14" d Open End Shelf	14	36	15	63	6	AM4-BOW-E-1436R	\$1,624
	14	36	15	63	6	AM4-BOW-E-1436L	\$1,624
	14	30	15	54	5	AM4-BOW-E-1430R	\$1,549
	14	30	15	54	5	AM4-BOW-E-1430L	\$1,549

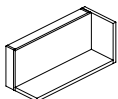

left shown

- use with overhead cabinet
- match with letter depth storage
- wall mounted
- mounting hardware included
- valance rail highly recommended
- shelf depth: 10"

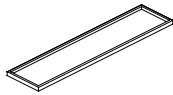
Description	D	W	H	CTN WT	CU FT	① Model	List Price
<b>Legal Valance</b> 	16	108	1 ¾	16	5	AP9-VLB-1-16108	\$598
	16	102	1 ¾	16	5	AP9-VLB-1-16102	\$586
	16	96	1 ¾	15	5	AP9-VLB-1-1696	\$549
	16	90	1 ¾	14	5	AP9-VLB-1-1690	\$534
	16	72	1 ¾	12	4	AP9-VLB-1-1672	\$492
	16	60	1 ¾	9	3	AP9-VLB-1-1660	\$466
	16	54	1 ¾	9	2	AP9-VLB-1-1654	\$453
	16	36	1 ¾	7	2	AP9-VLB-1-1636	\$409
	16	30	1 ¾	6	2	AP9-VLB-1-1630	\$396

- use with legal wall mounted storage only
- anodized aluminum

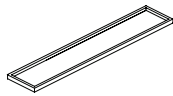
<b>Letter Valance</b> 	14	108	1 ¾	15	5	AP9-VLB-1-14108	\$573
	14	102	1 ¾	15	5	AP9-VLB-1-14102	\$560
	14	96	1 ¾	14	5	AP9-VLB-1-1496	\$523
	14	90	1 ¾	13	4	AP9-VLB-1-1490	\$509
	14	72	1 ¾	10	3	AP9-VLB-1-1472	\$466
	14	60	1 ¾	9	3	AP9-VLB-1-1460	\$440
	14	54	1 ¾	8	2	AP9-VLB-1-1454	\$428
	14	36	1 ¾	7	2	AP9-VLB-1-1436	\$382
	14	30	1 ¾	5	1	AP9-VLB-1-1430	\$372

- use with letter wall mounted storage only
- anodized aluminum

<b>Overhead Support End Panel</b> 	17	85	85 ½	79	85	AM7-FEP-1D-1785	\$1,232
	17	70	70 ½	60	58	AM7-FEP-1D-1770	\$1,105
	14	85	85 ½	67	71	AM7-FEP-1-1485	\$1,194
	14	70	70 ½	51	49	AM7-FEP-1-1470	\$1,067

- 17"d use with legal depth storage
- 14"d use with letter depth storage

**To Order, Specify:**

- ① Model Number
- ② Wood Species/Paint - Makore (MK2), Maple (MA2)  
Walnut (WA2), Double Cut (DC1) or Paint (PNT)  
(see page 62)
- ③ Finish Color

Note: Only one wood finish and one paint color can be specified per unit

APOGEE™

Description	D	W	H	CTN WT	CU FT	① Model	Veneer	Paint	Magnetic Back Painted Glass
-------------	---	---	---	-----------	----------	---------	--------	-------	--------------------------------

Wall Panel	1 ¾	108	24	64	6	AM9-HVB-1-24108	\$1,649	\$1,649	\$4,175
------------	-----	-----	----	----	---	-----------------	---------	---------	---------

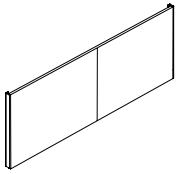

- use with wall mounted overhead storage
- wall mounted
- requires a valance, see page 133
- glass option has a thin aluminum frame
- pack of 6 magnets come with magnetic glass option

Wall Panel	1 ¾	90	24	53	5	AM9-HVB-1-2490	\$1,523	\$1,523	\$3,655
------------	-----	----	----	----	---	----------------	---------	---------	---------

	1 ¾	72	24	43	4	AM9-HVB-1-2472	\$1,143	\$1,143	\$2,852
--	-----	----	----	----	---	----------------	---------	---------	---------

	1 ¾	60	24	37	4	AM9-HVB-1-2460	\$1,049	\$1,049	\$2,564
--	-----	----	----	----	---	----------------	---------	---------	---------

	1 ¾	54	24	33	3	AM9-HVB-1-2454	\$985	\$985	\$2,232
--	-----	----	----	----	---	----------------	-------	-------	---------

	1 ¾	36	24	22	2	AM9-HVB-1-2436	\$890	\$890	\$2,001
--	-----	----	----	----	---	----------------	-------	-------	---------

	1 ¾	30	24	20	2	AM9-HVB-1-2430	\$827	\$827	\$1,805
--	-----	----	----	----	---	----------------	-------	-------	---------

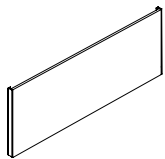

- use with wall mounted overhead storage
- wall mounted
- requires a valance, see page 133
- glass option has a thin aluminum frame
- pack of 6 magnets come with magnetic glass option

Wall Panel with Shelf	6 ¾	108	24	86	15	AM9-HVB-S-24108	\$2,905	\$2,905	\$5,069
-----------------------	-----	-----	----	----	----	-----------------	---------	---------	---------

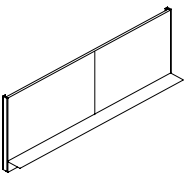

- use with wall mounted overhead storage
- wall mounted
- requires a valance, see page 133
- glass option has a thin aluminum frame
- pack of 6 magnets come with magnetic glass option
- anodized aluminum shelf

Wall Panel with Shelf	6 ¾	90	24	69	13	AM9-HVB-S-2490	\$2,753	\$2,753	\$4,551
-----------------------	-----	----	----	----	----	----------------	---------	---------	---------

	6 ¾	72	24	55	10	AM9-HVB-S-2472	\$2,297	\$2,297	\$3,747
--	-----	----	----	----	----	----------------	---------	---------	---------

	6 ¾	60	24	49	8	AM9-HVB-S-2460	\$2,176	\$2,176	\$3,323
--	-----	----	----	----	---	----------------	---------	---------	---------

	6 ¾	54	24	44	8	AM9-HVB-S-2454	\$2,025	\$2,025	\$3,042
--	-----	----	----	----	---	----------------	---------	---------	---------

	6 ¾	36	24	30	5	AM9-HVB-S-2436	\$1,897	\$1,897	\$2,790
--	-----	----	----	----	---	----------------	---------	---------	---------

	6 ¾	30	24	26	4	AM9-HVB-S-2430	\$1,751	\$1,751	\$2,556
--	-----	----	----	----	---	----------------	---------	---------	---------

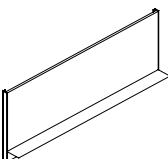

- use with wall mounted overhead storage
- wall mounted
- requires a valance see page 133
- glass option has a thin aluminum frame
- pack of 6 magnets come with magnetic glass option
- anodized aluminum shelf

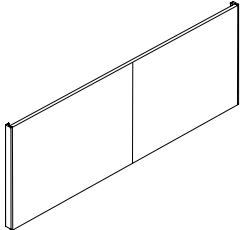

Description	D	W	H	CTN WT	CU FT	① Model	List Price Per Grade
<b>108" w Wall Mount Tackboard</b>	1 ¾	108	24	42	6	<b>AM9-HTB-1-24108</b>	<b>COM \$2,232</b>
 <ul style="list-style-type: none"> <li>· use with wall mount overhead storage cabinet</li> <li>· wall mounted</li> <li>· requires a valance, see page 133</li> <li>· fabric is railroaded</li> <li>· com ydg: 3 ¼</li> </ul>	A						\$2,272
	B						\$2,349
	C						\$2,483
	D						\$2,654
	E						\$2,829
	F						\$3,096
	G						\$3,385
	H						\$3,690
	I						\$4,169
	J						\$4,744

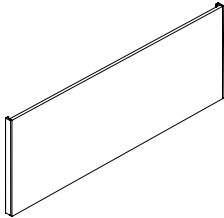
<b>90" w Wall Mount Tackboard</b>	1 ¾	90	24	35	5	<b>AM9-HTB-1-2490</b>	<b>COM \$2,004</b>
 <ul style="list-style-type: none"> <li>· use with wall mount overhead storage cabinet</li> <li>· wall mounted</li> <li>· requires a valance, see page 133</li> <li>· fabric is railroaded</li> <li>· com ydg: 2 ¾</li> </ul>	A						\$2,038
	B						\$2,102
	C						\$2,218
	D						\$2,363
	E						\$2,508
	F						\$2,735
	G						\$2,979
	H						\$3,237
	I						\$3,642
	J						\$4,129

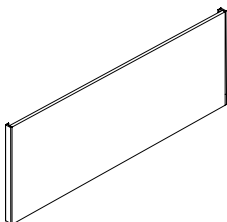
<b>72" w Wall Mount Tackboard</b>	1 ¾	72	24	28	4	<b>AM9-HTB-1-2472</b>	<b>COM \$1,549</b>
 <ul style="list-style-type: none"> <li>· use with wall mount overhead storage cabinet</li> <li>· wall mounted</li> <li>· requires a valance, see page 133</li> <li>· fabric is railroaded</li> <li>· com ydg: 2 ¼</li> </ul>	A						\$1,579
	B						\$1,628
	C						\$1,721
	D						\$1,840
	E						\$1,961
	F						\$2,147
	G						\$2,347
	H						\$2,557
	I						\$2,888
	J						\$3,287

**To Order, Specify:**

**Wall Panel**

- ① Model Number
- ② Finish Application
  - a.) All Veneer
    - 1.) Wood Species - Makore (MK2), Maple (MA2), Walnut (WA2) or Double Cut (DC1) (see page 62)
    - a.) Finish Color (see page 62)
  - b.) All Paint (PNT)
    - 1.) Paint Color (see page 62)
  - c.) Magnetic Back Painted Glass

**Tackboard**

- ① Model Number
- ② Fabric - vendor, pattern, color

APOGEE™

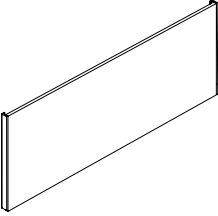
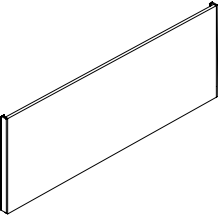
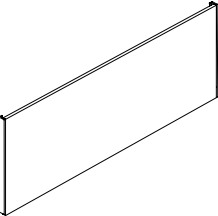
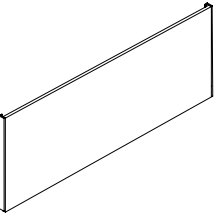
Description	D	W	H	CTN WT	CU FT	① Model	List Price Per Grade
<b>60" w Wall Mount Tackboard</b>  <ul style="list-style-type: none"> <li>· use with wall mount overhead storage cabinet</li> <li>· wall mounted</li> <li>· requires a valance rail, see page 133</li> <li>· fabric is railroaded</li> <li>· com ydg: 2</li> </ul>	1 ¾	60	24	25	4	<b>AM9-HTB-1-2460</b>	<b>COM \$1,471</b> A \$1,496 B \$1,545 C \$1,627 D \$1,733 E \$1,838 F \$2,003 G \$2,181 H \$2,369 I \$2,666 J \$3,018
<b>54" w Wall Mount Tackboard</b>  <ul style="list-style-type: none"> <li>· use with wall mount overhead storage cabinet</li> <li>· wall mounted</li> <li>· requires a valance rail, see page 133</li> <li>· fabric is railroaded</li> <li>· com ydg: 1 ¾</li> </ul>	1 ¾	54	24	22	3	<b>AM9-HTB-1-2454</b>	<b>COM \$1,396</b> A \$1,418 B \$1,460 C \$1,531 D \$1,624 E \$1,717 F \$1,863 G \$2,017 H \$2,182 I \$2,439 J \$2,750
<b>36" w Wall Mount Tackboard</b>  <ul style="list-style-type: none"> <li>· use with wall mount overhead storage cabinet</li> <li>· wall mounted</li> <li>· requires a valance rail, see page 133</li> <li>· fabric is railroaded</li> <li>· com ydg: 1 ¼</li> </ul>	1 ¾	36	24	15	2	<b>AM9-HTB-1-2436</b>	<b>COM \$1,320</b> A \$1,336 B \$1,365 C \$1,417 D \$1,485 E \$1,551 F \$1,654 G \$1,763 H \$1,883 I \$2,066 J \$2,288
<b>30" w Wall Mount Tackboard</b>  <ul style="list-style-type: none"> <li>· use with wall mount overhead storage cabinet</li> <li>· wall mounted</li> <li>· requires a valance rail, see page 133</li> <li>· fabric is railroaded</li> <li>· com ydg: 1</li> </ul>	1 ¾	30	24	13	2	<b>AM9-HTB-1-2430</b>	<b>COM \$1,244</b> A \$1,258 B \$1,280 C \$1,322 D \$1,376 E \$1,429 F \$1,512 G \$1,598 H \$1,694 I \$1,840 J \$2,018

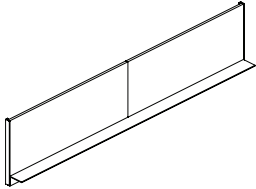
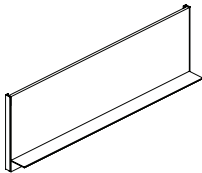
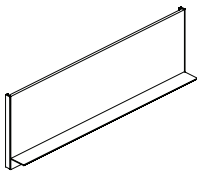
Description	D	W	H	CTN WT	CU FT	① Model	List Price Per Grade		
<b>108" w Wall Mount Tackboard with Shelf</b>  <ul style="list-style-type: none"> <li>· use with wall mount overhead storage cabinet</li> <li>· wall mounted</li> <li>· requires a valance, see page 133</li> <li>· anodized aluminum shelf</li> <li>· fabric is railroaded</li> <li>· com ydg: 3 ¼</li> </ul>	6 ¾	108	24	57	15	<b>AM9-HTB-S-24108</b>	<b>COM \$3,331</b> A \$3,369 B \$3,446 C \$3,580 D \$3,753 E \$3,927 F \$4,194 G \$4,481 H \$4,787 I \$5,267 J \$5,843		
	<b>90" w Wall Mount Tackboard with Shelf</b>  <ul style="list-style-type: none"> <li>· use with wall mount overhead storage cabinet</li> <li>· wall mounted</li> <li>· requires a valance, see page 133</li> <li>· anodized aluminum shelf</li> <li>· fabric is railroaded</li> <li>· com ydg: 2 ¾</li> </ul>	6 ¾	90	24	48	13	<b>AM9-HTB-S-2490</b>	<b>COM \$3,084</b> A \$3,117 B \$3,181 C \$3,294 D \$3,440 E \$3,586 F \$3,813 G \$4,057 H \$4,315 I \$4,723 J \$5,208	
		<b>72" w Wall Mount Tackboard with Shelf</b>  <ul style="list-style-type: none"> <li>· use with wall mount overhead storage cabinet</li> <li>· wall mounted</li> <li>· requires a valance, see page 133</li> <li>· anodized aluminum shelf</li> <li>· fabric is railroaded</li> <li>· com ydg: 2 ¼</li> </ul>	6 ¾	72	24	38	10	<b>AM9-HTB-S-2472</b>	<b>COM \$2,587</b> A \$2,616 B \$2,669 C \$2,761 D \$2,880 E \$3,000 F \$3,187 G \$3,386 H \$3,597 I \$3,928 J \$4,326

**To Order, Specify:**

- ① Model Number
- ② Fabric - vendor, pattern, color

APOGEE™

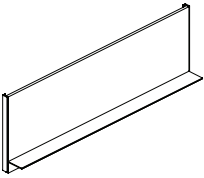
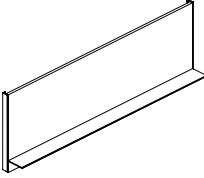
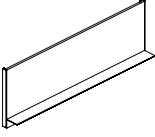
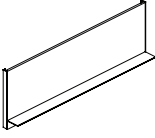
Description	D	W	H	CTN WT	CU FT	① Model	List Price Per Grade			
<b>60" w Wall Mount Tackboard with Shelf</b>  <ul style="list-style-type: none"> <li>· use with wall mount overhead storage cabinet</li> <li>· wall mounted</li> <li>· requires a valance, see page 133</li> <li>· anodized aluminum shelf</li> <li>· fabric is railroaded</li> <li>· com ydg: 2</li> </ul>	6 ¾	60	24	32	8	<b>AM9-HTB-S-2460</b>	<b>COM \$2,473</b> A \$2,498 B \$2,545 C \$2,629 D \$2,733 E \$2,840 F \$3,004 G \$3,183 H \$3,369 I \$3,667 J \$4,020			
	<b>54" w Wall Mount Tackboard with Shelf</b>  <ul style="list-style-type: none"> <li>· use with wall mount overhead storage cabinet</li> <li>· wall mounted</li> <li>· requires a valance, see page 133</li> <li>· anodized aluminum shelf</li> <li>· fabric is railroaded</li> <li>· com ydg: 1 ¾</li> </ul>	6 ¾	54	24	30	8	<b>AM9-HTB-S-2454</b>	<b>COM \$2,328</b> A \$2,350 B \$2,391 C \$2,463 D \$2,556 E \$2,649 F \$2,794 G \$2,948 H \$3,114 I \$3,369 J \$3,679		
		<b>36" w Wall Mount Tackboard with Shelf</b>  <ul style="list-style-type: none"> <li>· use with wall mount overhead storage cabinet</li> <li>· wall mounted</li> <li>· requires a valance, see page 133</li> <li>· anodized aluminum shelf</li> <li>· fabric is railroaded</li> <li>· com ydg: 1 ¼</li> </ul>	6 ¾	36	24	20	5	<b>AM9-HTB-S-2436</b>	<b>COM \$2,163</b> A \$2,179 B \$2,207 C \$2,260 D \$2,327 E \$2,393 F \$2,495 G \$2,606 H \$2,725 I \$2,908 J \$3,130	
			<b>30" w Wall Mount Tackboard with Shelf</b>  <ul style="list-style-type: none"> <li>· use with wall mount overhead storage cabinet</li> <li>· wall mounted</li> <li>· requires a valance, see page 133</li> <li>· anodized aluminum shelf</li> <li>· fabric is railroaded</li> <li>· com ydg: 1</li> </ul>	6 ¾	30	24	17	4	<b>AM9-HTB-S-2430</b>	<b>COM \$2,100</b> A \$2,113 B \$2,136 C \$2,177 D \$2,230 E \$2,284 F \$2,366 G \$2,454 H \$2,549 I \$2,697 J \$2,873

Description	D	W	H	CTN WT	CU FT	① Model	List Price
56" h Storage Tower with Doors	18	30	56	165	22	AP5-OCS-TD-1830	\$3,676

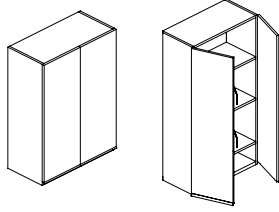

- use with 56" overhead and two-high storage
- legal depth storage
- top shelf adjustable
- two fixed shelves
- stand-up wire dividers
- soft close hinge doors
- locking doors available, specify and add \$123 list

56" h Storage Tower with Doors	15	30	56	151	19	AP5-OCS-T1-1530	\$3,551
--------------------------------	----	----	----	-----	----	-----------------	---------

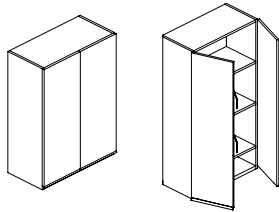

- use with 56" overhead and two-high storage
- letter depth storage
- top shelf adjustable
- two fixed shelves
- stand-up wire dividers
- soft close hinge doors
- locking doors available, specify and add \$123 list

**To Order, Specify:**

**Wall Mount Tackboard**

- ① Model Number
- ② Fabric - vendor, pattern, color

**Storage Tower**

- ① Model Number
- ② Finish Application
  - a.) All Veneer
    - 1.) Wood Species - Makore (MK2), Maple (MA2), Walnut (WA2) or Double Cut (DC1) (see page 62)
      - a.) Finish Color (see page 62)
  - b.) All Paint (PNT)
    - 1.) Paint Color (see page 62)

- c.) Veneer/Paint Combination
  - 1.) Chassis Wood Species/Paint - Makore (MK2), Maple (MA2), Walnut (WA2), Double Cut (DC1) or Paint (PNT) (see page 62)
    - a.) Finish Color for Chassis (see page 62)
  - 2.) Door Wood Species/Paint - Makore (MK2), Maple (MA2), Walnut (WA2), Double Cut (DC1) or Paint (PNT) (see page 62)
    - a.) Finish Color for Door (see page 62)

Note: Only one wood finish and one paint color can be specified per unit

Description	D	W	H	CTN WT	CU FT	① Model	List Price
56" h Storage Tower with Door	18	18	56	113	14	AP5-OCS-TD-1818R	\$2,790
	18	18	56	113	14	AP5-OCS-TD-1818L	\$2,790

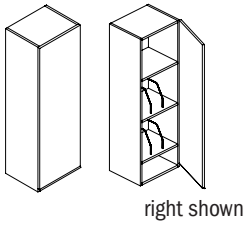

- use with 56" h overhead and two-high storage
- legal depth storage
- top shelf adjustable
- two fixed shelves
- stand-up wire dividers
- soft close hinge doors
- locking door available, specify and add \$123 list

56" h Storage Tower with Door	15	18	56	102	12	AP5-OCS-T1-1518R	\$2,663
	15	18	56	102	12	AP5-OCS-T1-1518L	\$2,663

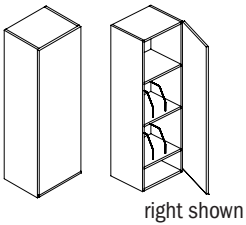

- use with 56" h overhead and two-high storage
- letter depth storage
- top shelf adjustable
- two fixed shelves
- stand-up wire dividers
- soft close hinge doors
- locking door available, specify and add \$123 list

41" h Storage Tower with Doors	18	30	41	126	16	AP5-OCS-1D-1830	\$3,424
--------------------------------	----	----	----	-----	----	-----------------	---------

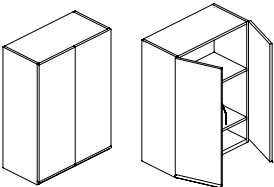

- use with 41" h overhead and two-high storage
- legal depth storage
- top shelf adjustable
- one fixed shelf
- stand-up wire dividers
- soft close hinge doors
- locking door available, specify and add \$123 list

41" h Storage Tower with Doors	15	30	41	115	14	AP5-OCS-1-1530	\$3,296
--------------------------------	----	----	----	-----	----	----------------	---------

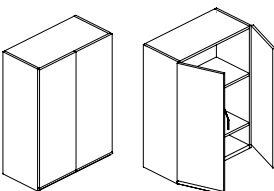

- use with 41" h overhead and two-high storage
- letter depth storage
- top shelf adjustable
- one fixed shelf
- stand-up wire dividers
- soft close hinge doors
- locking door available, specify and add \$123 list

Description	D	W	H	CTN WT	CU FT	① Model	List Price
41" h Storage Tower with Door	18	18	41	86	10	AP5-OCS-1D-1818R	\$2,535
	18	18	41	86	10	AP5-OCS-1D-1818L	\$2,535

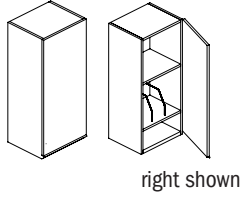

- use with 41" h overhead and two-high storage
- legal depth storage
- top shelf adjustable
- one fixed shelf
- stand-up wire dividers
- soft close hinge doors
- locking door available, specify and add \$123 list

41" h Storage Tower with Door	15	18	41	78	9	AP5-OCS-1-1518R	\$2,409
	15	18	41	78	9	AP5-OCS-1-1518L	\$2,409

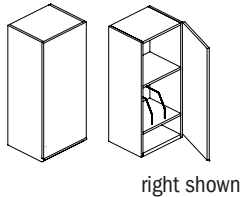

- use with 41" h overhead and two-high storage
- letter depth storage
- top shelf adjustable
- one fixed shelf
- stand-up wire dividers
- soft close hinge doors
- locking door available, specify and add \$123 list

**To Order, Specify:**

- ① Model Number
- ② Finish Application
  - a.) All Veneer
    - 1.) Wood Species - Makore (MK2), Maple (MA2), Walnut (WA2) or Double Cut (DC1) (see page 62)
    - a.) Finish Color (see page 62)
  - b.) All Paint (PNT)
    - 1.) Paint Color (see page 62)
  - c.) Veneer/Paint Combination
    - 1.) Chassis Wood Species/Paint - Makore (MK2), Maple (MA2), Walnut (WA2), Double Cut (DC1) or Paint (PNT) (see page 62)
      - a.) Finish Color for Chassis (see page 62)
    - 2.) Door Wood Species/Paint - Makore (MK2), Maple (MA2), Walnut (WA2), Double Cut (DC1) or Paint (PNT) (see page 62)
      - a.) Finish Color for Door (see page 62)

Note: Only one wood finish and one paint color can be specified per unit

Description	D	W	H	CTN WT	CU FT	① Model	List Price
68½" Storage Tower with Doors	18	30	68½	200	26	AP5-OCT-TD-1830	\$3,651

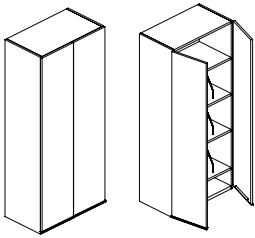

- use with 56" overhead and one-high storage
- legal depth storage
- top shelf adjustable
- three fixed shelves
- stand-up wire dividers
- soft close hinge doors
- locking door available, specify and add \$123 list

68½" Storage Tower with Doors	15	30	68½	183	23	AP5-OCT-T1-1530	\$3,524
-------------------------------	----	----	-----	-----	----	-----------------	---------

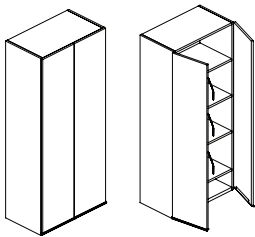

- use with 56" overhead and one-high storage
- letter depth storage
- top shelf adjustable
- three fixed shelves
- stand-up wire dividers
- soft close hinge doors
- locking door available, specify and add \$123 list

68½" Storage Tower with Door	18	18	68½	137	17	AP5-OCT-TD-1818R	\$3,018
	18	18	68½	137	17	AP5-OCT-TD-1818L	\$3,018

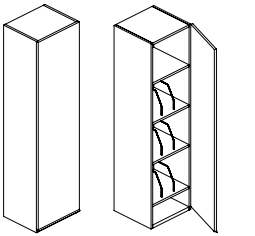

right shown

- use with 56" overhead and one-high storage
- legal depth storage
- top shelf adjustable
- three fixed shelves
- stand-up wire dividers
- soft close hinge doors
- locking door available, specify and add \$123 list

68½" Storage Tower with Door	15	18	68½	124	14	AP5-OCT-T1-1518R	\$2,891
	15	18	68½	124	14	AP5-OCT-T1-1518L	\$2,891

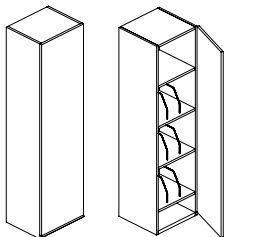

right shown

- use with 56" overhead and one-high storage
- letter depth storage
- top shelf adjustable
- three fixed shelves
- stand-up wire dividers
- soft close hinge doors
- locking door available, specify and add \$123 list



Description	D	W	H	CTN WT	CU FT	① Model	List Price
53 ½" h Storage Tower with Doors	18	30	53 ½	161	21	AP5-OCT-1D-1830	\$3,271

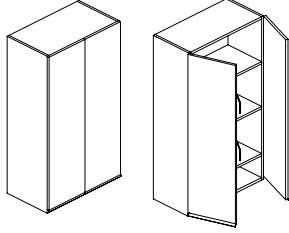

- use with 41" h overhead and one-high storage
- legal depth storage
- top shelf adjustable
- two fixed shelves
- stand-up wire dividers
- soft close hinge doors
- locking doors available, specify and add \$123 list

53 ½" h Storage Tower with Doors	15	30	53 ½	146	18	AP5-OCT-1-1530	\$3,144
----------------------------------	----	----	------	-----	----	----------------	---------

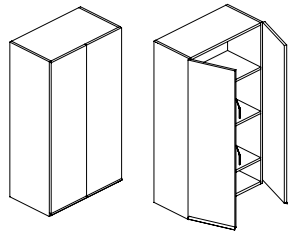

- use with 41" h overhead and one-high storage
- letter depth storage
- top shelf adjustable
- two fixed shelves
- stand-up wire dividers
- soft close hinge doors
- locking doors available, specify and add \$123 list

**To Order, Specify:**

- ① Model Number
- ② Finish Application
  - a.) All Veneer
    - 1.) Wood Species - Makore (MK2), Maple (MA2), Walnut (WA2) or Double Cut (DC1) (see page 62)
      - a.) Finish Color (see page 62)
  - b.) All Paint (PNT)
    - 1.) Paint Color (see page 62)
  - c.) Veneer/Paint Combination
    - 1.) Chassis Wood Species/Paint - Makore (MK2), Maple (MA2), Walnut (WA2), Double Cut (DC1) or Paint (PNT) (see page 62)
      - a.) Finish Color for Chassis (see page 62)
    - 2.) Door Wood Species/Paint - Makore (MK2), Maple (MA2), Walnut (WA2), Double Cut (DC1) or Paint (PNT) (see page 62)
      - a.) Finish Color for Door (see page 62)

Note: Only one wood finish and one paint color can be specified per unit

Description	D	W	H	CTN WT	CU FT	① Model	List Price
53½" Storage Tower with Doors	18	18	53½	110	13	AP5-OCT-1D-1818R	\$2,638
	18	18	53½	110	13	AP5-OCT-1D-1818L	\$2,638

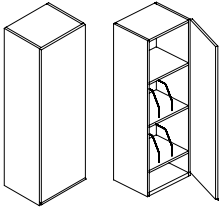

right shown

- use with 41" overhead and one-high storage
- legal depth storage
- top shelf adjustable
- two fixed shelves
- stand-up wire dividers
- soft close hinge doors
- locking door available, specify and add \$123 list

53½" Storage Tower with Doors	15	18	53½	99	11	AP5-OCT-1-1518R	\$2,511
	15	18	53½	99	11	AP5-OCT-1-1518L	\$2,511

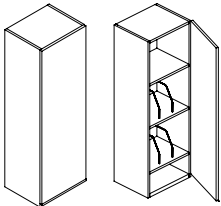

right shown

- use with 41" overhead and one-high storage
- letter depth storage
- top shelf adjustable
- two fixed shelves
- stand-up wire dividers
- soft close hinge doors
- locking door available, specify and add \$123 list

APOGEE™

Description	D	W	H	CTN WT	CU FT	❶ Model	List Price
56" h Asymmetric Shelves	17	30	56	109	21	AP5-OAS-TD-1730R	\$2,366
	17	30	56	109	21	AP5-OAS-TD-1730L	\$2,366

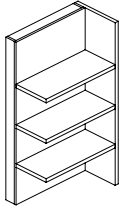

left shown

- use with 56" h overhead and two-high storage
- match with legal depth storage
- shelf depth: 12 1/2"

56" h Asymmetric Shelves	14	30	56	100	17	AP5-OAS-T1-1430R	\$2,239
	14	30	56	100	17	AP5-OAS-T1-1430L	\$2,239

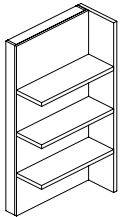

left shown

- use with 56" h overhead and two-high storage
- match with letter depth storage
- shelf depth: 10"

**To Order, Specify:**

**Storage Tower**

- ❶ Model Number
- ❷ Finish Application
  - a.) All Veneer
    - 1.) Wood Species - Makore (MK2), Maple (MA2), Walnut (WA2) or Double Cut (DC1) (see page 62)
    - a.) Finish Color (see page 62)
  - b.) All Paint (PNT)
    - 1.) Paint Color (see page 62)

c.) Veneer/Paint Combination

- 1.) Chassis Wood Species/Paint - Makore (MK2), Maple (MA2), Walnut (WA2), Double Cut (DC1) or Paint (PNT) (see page 62)
  - a.) Finish Color for Chassis (see page 62)
- 2.) Door Wood Species/Paint - Makore (MK2), Maple (MA2), Walnut (WA2), Double Cut (DC1) or Paint (PNT) (see page 62)
  - a.) Finish Color for Door (see page 62)

**Shelves**

- ❶ Model Number
- ❷ Wood Species/Paint - Makore (MK2), Maple (MA2) Walnut (WA2), Double Cut (DC1) or Paint (PNT) (see page 62)
- ❸ Finish Color

Note: Only one wood finish and one paint color can be specified per unit

Description	D	W	H	CTN WT	CU FT	① Model	List Price
56" h Asymmetric Shelves	17	12	56	57	9	AP5-OAS-TD-1712R	\$1,986
	17	12	56	57	9	AP5-OAS-TD-1712L	\$1,986

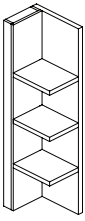

left shown

- use with 56 1/2" h overhead and two-high storage
- match with legal depth storage
- shelf depth: 12 1/2"

56" h Asymmetric Shelves	14	12	56	49	8	AP5-OAS-T1-1412R	\$1,859
	14	12	56	49	8	AP5-OAS-T1-1412L	\$1,859

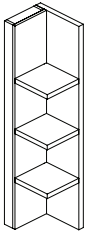

left shown

- use with 56" h overhead and two-high storage
- match with letter depth storage
- shelf depth: 10"

41" h Asymmetric Shelves	17	30	41	78	15	AP5-OAS-1D-1730R	\$2,176
	17	30	41	78	15	AP5-OAS-1D-1730L	\$2,176

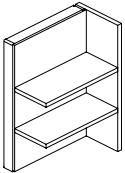

left shown

- use with 41" h overhead and two-high storage
- match with legal depth storage
- shelf depth: 12 1/2"

41" h Asymmetric Shelves	14	30	41	73	13	AP5-OAS-1-1430R	\$2,048
	14	30	41	73	13	AP5-OAS-1-1430L	\$2,048

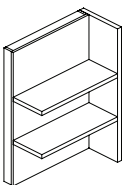

left shown

- use with 41" h overhead and two-high storage
- match with letter depth storage
- shelf depth: 10"

Description	D	W	H	CTN WT	CU FT	❶ Model	List Price
41" h Asymmetric Shelves	17	12	41	46	7	AP5-OAS-1D-1712R	\$1,795
	17	12	41	46	7	AP5-OAS-1D-1712L	\$1,795

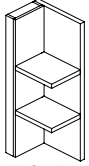

left shown

- use with 41" h overhead and two-high storage
- match with legal depth storage
- shelf depth: 12 1/2"

41" h Asymmetric Shelves	14	12	41	41	6	AP5-OAS-1-1412R	\$1,668
	14	12	41	41	6	AP5-OAS-1-1412L	\$1,668

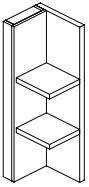

left shown

- use with 41" h overhead and two-high storage
- match with letter depth storage
- shelf depth: 10"

**To Order, Specify:**

- ❶ Model Number
- ❷ Wood Species/Paint - Makore (MK2), Maple (MA2)  
Walnut (WA2), Double Cut (DC1) or Paint (PNT)  
(see page 62)
- ❸ Finish Color

Note: Only one wood finish and one paint color can be specified per unit

Description	D	W	H	CTN WT	CU FT	① Model	List Price
68 1/2" h Asymmetric Shelves	17	30	68 1/2	140	25	AP5-OAT-TD-1730R	\$2,467
	17	30	68 1/2	140	25	AP5-OAT-TD-1730L	\$2,467

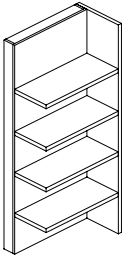

left shown

- use with 56" h overhead and one-high storage
- match with legal depth storage
- shelf depth: 12 1/2"

68 1/2" h Asymmetric Shelves	14	30	68 1/2	129	21	AP5-OAT-T1-1430R	\$2,340
	14	30	68 1/2	129	21	AP5-OAT-T1-1430L	\$2,340

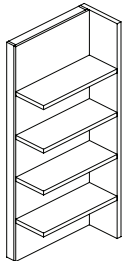

left shown

- use with 56" h overhead and one-high storage
- match with letter depth storage
- shelf depth: 10"

68 1/2" h Asymmetric Shelves	17	12	68 1/2	70	11	AP5-OAT-TD-1712R	\$2,025
	17	12	68 1/2	70	11	AP5-OAT-TD-1712L	\$2,025

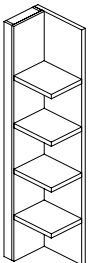

left shown

- use with 56" h overhead and one-high storage
- match with legal depth storage
- shelf depth: 12 1/2"

68 1/2" h Asymmetric Shelves	14	12	68 1/2	63	9	AP5-OAT-T1-1412R	\$1,897
	14	12	68 1/2	63	9	AP5-OAT-T1-1412L	\$1,897

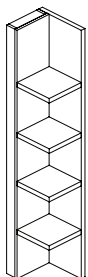

left shown

- use with 56" h overhead and one-high storage
- match with letter depth storage
- shelf depth: 10"

Description	D	W	H	CTN WT	CU FT	① Model	List Price
53 ½" h Asymmetric Shelves	17	30	53 ½	109	20	AP5-OAT-1D-1730R	\$2,214
	17	30	53 ½	109	20	AP5-OAT-1D-1730L	\$2,214

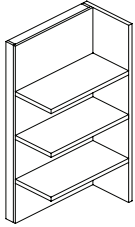

left shown

- use with 41" h overhead and one-high storage
- match with legal depth storage
- shelf depth: 12 ½"

53 ½" h Asymmetric Shelves	14	30	53 ½	103	17	AP5-OAT-1-1430R	\$2,088
	14	30	53 ½	103	17	AP5-OAT-1-1430L	\$2,088

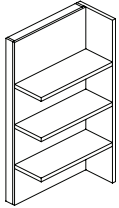

left shown

- use with 41" h overhead and one-high storage
- match with legal depth storage
- shelf depth: 10"

53 ½" h Asymmetric Shelves	17	12	53 ½	57	9	AP5-OAT-1D-1712R	\$1,834
	17	12	53 ½	57	9	AP5-OAT-1D-1712L	\$1,834

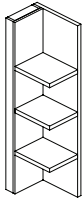

left shown

- use with 41" h overhead and one-high storage
- match with legal depth storage
- shelf depth: 12 ½"

53 ½" Asymmetric Shelves	14	12	53 ½	52	7	AP5-OAT-1-1412R	\$1,707
	14	12	53 ½	52	7	AP5-OAT-1-1412L	\$1,707

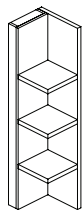

left shown

- use with 41" h overhead and one-high storage
- match with legal depth storage
- shelf depth: 10"

**To Order, Specify:**

- ① Model Number
- ② Wood Species/Paint - Makore (MK2), Maple (MA2)  
Walnut (WA2), Double Cut (DC1) or Paint (PNT)  
(see page 62)
- ③ Finish Color

Note: Only one wood finish and one paint color can be specified per unit

APOGEE™

Description	D	W	H	CTN WT	CU FT	① Model	List Price
85½" h Storage Unit with Drawer and Flush Base	22	18	85½	214	25	AP6-DDT-B-2218R	\$4,691
	22	18	85½	214	25	AP6-DDT-B-2218L	\$4,691

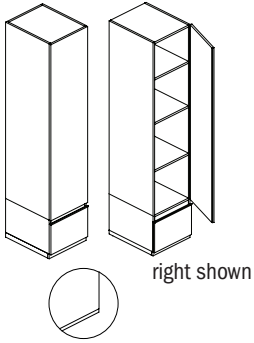

- base is flush
- three adjustable shelves
- pedestal front locking
- door side has concealed bevel for opening
- soft close hinge door
- locking door available, specify and add \$123 list
- adjustable levelers/glides

APOGEE™

85½" h Storage Unit with Drawer and Inset Base	22	18	85½	211	25	AP6-DDT-BR-2218R	\$4,691
	22	18	85½	211	25	AP6-DDT-BL-2218L	\$4,691

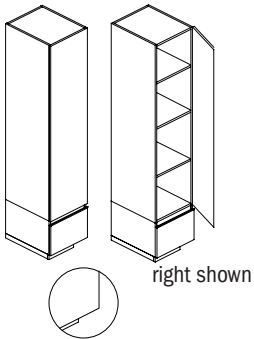

- base is inset on one side
- three adjustable shelves
- pedestal front locking
- door side has concealed bevel for opening
- soft close hinge door
- locking door available, specify and add \$123 list
- adjustable levelers/glides

must be mounted



Description	D	W	H	CTN WT	CU FT	① Model	List Price
85 ½" h Wardrobe Unit with Drawer and Flush Base	22	18	85 ½	201	25	AP6-DDT-A-2218R	\$4,462
	22	18	85 ½	201	25	AP6-DDT-A-2218L	\$4,462

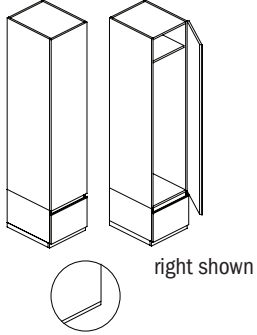

- base is flush
- fixed shelf
- hanging bar
- pedestal front locking
- door side has concealed bevel for opening
- soft close hinge door
- locking door available, specify and add \$123 list
- adjustable leveler/glides

85 ½" h Wardrobe Unit with Drawer and Inset Base	22	18	85 ½	198	25	AP6-DDT-AR-2218R	\$4,462
	22	18	85 ½	198	25	AP6-DDT-AL-2218L	\$4,462

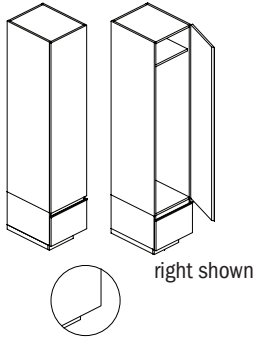

- base is inset on one side
- fixed shelf
- hanging bar
- pedestal front locking
- door side has concealed bevel for opening
- soft close hinge door
- locking door available, specify and add \$123 list
- adjustable leveler/glides

must be mounted

**To Order, Specify:**

① Model Number

② Finish Application

a.) All Veneer

- 1.) Wood Species - Makore (MK2), Maple (MA2), Walnut (WA2) or Double Cut (DC1) (see page 62)

a.) Finish Color (see page 62)

b.) All Paint (PNT)

- 1.) Paint Color (see page 62)

c.) Veneer/Paint Combination

- 1.) Upper Chassis Wood Species/Paint - Makore (MK2), Maple (MA2), Walnut (WA2), Double Cut (DC1) or Paint (PNT) (see page 62)

a.) Finish Color for Upper Chassis (see page 62)

- 2.) Lower Chassis Wood Species/Paint - Makore (MK2), Maple (MA2), Walnut (WA2), Double Cut (DC1) or Paint (PNT) (see page 62)

a.) Finish Color for Lower Chassis (see page 62)

3.) Finish Color for Base

a.) Same as Upper Chassis

b.) Same as Lower Chassis

c.) Paint

Note: Only one wood finish and one paint color can be specified per unit

Description	D	W	H	CTN WT	CU FT	① Model	List Price
85 1/2" h Storage Unit with Flush Base	22	18	85 1/2	195	25	AP6-ADT-2-2218R	\$4,005
	22	18	85 1/2	195	25	AP6-ADT-2-2218L	\$4,005

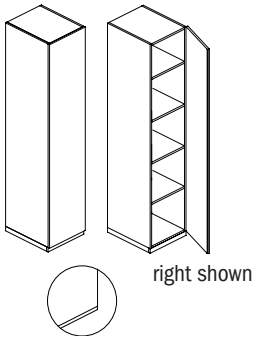

- base is flush
- four adjustable shelves
- door side has concealed bevel for opening
- soft close hinge door
- locking door available, specify and add \$123 list
- adjustable levelers/glides

85 1/2" h Storage Unit with Inset Base	22	18	85 1/2	192	25	AP6-ADT-2R-2218R	\$4,005
	22	18	85 1/2	192	25	AP6-ADT-2L-2218L	\$4,005

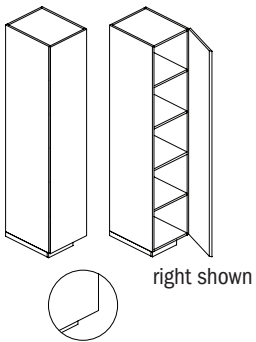

- base is inset on one side
- four adjustable shelves
- door side has concealed bevel for opening
- soft close hinge door
- locking door available, specify and add \$123 list
- adjustable levelers/glides

must be mounted

85 1/2" h Wardrobe Unit with Flush Base	22	18	85 1/2	176	25	AP6-ADT-1-2218R	\$3,701
	22	18	85 1/2	176	25	AP6-ADT-1-2218L	\$3,701

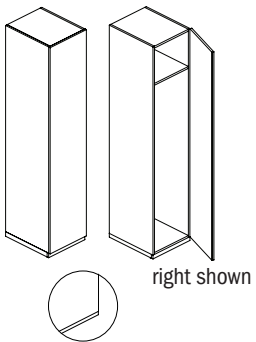

- base is flush
- fixed shelf
- hanging bar
- door side has concealed bevel for opening
- soft close hinge door
- locking door available, specify and add \$123 list
- adjustable leveler/glides

85 1/2" h Wardrobe Unit with Inset Base	22	18	85 1/2	172	25	AP6-ADT-1R-2218R	\$3,701
	22	18	85 1/2	172	25	AP6-ADT-1L-2218L	\$3,701

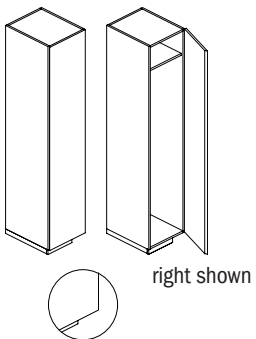

- base is inset on one side
- fixed shelf
- hanging bar
- door side has concealed bevel for opening
- soft close hinge door
- locking door available, specify and add \$123 list
- adjustable leveler/glides

must be mounted

Description	D	W	H	CTN WT	CU FT	① Model	List Price
85 ½" h Wardrobe Unit with Flush Base	22	12	85 ½	141	17	AP6-ADT-1-2212R	\$3,258
	22	12	85 ½	141	17	AP6-ADT-1-2212L	\$3,258

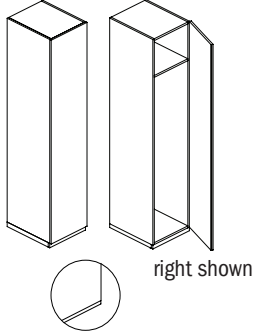

- base is flush
- fixed shelf
- coat hook
- door side has concealed bevel for opening
- soft close hinge door
- locking door available, specify and add \$123 list
- adjustable leveler/glides

must be mounted  
 Note: Not a Freestanding Unit

85 ½" h Wardrobe Unit with Inset Base	22	12	85 ½	138	17	AP6-ADT-1R-2212R	\$3,258
	22	12	85 ½	138	17	AP6-ADT-1L-2212L	\$3,258

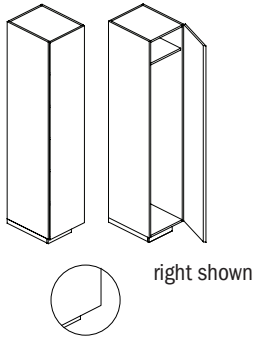

- base is inset on one side
- fixed shelf
- coat hook
- door side has concealed bevel for opening
- soft close hinge door
- locking door available, specify and add \$123 list
- adjustable leveler/glides

must be mounted  
 Note: Not a Freestanding Unit

**To Order, Specify:**

- ① Model Number
- ② Wood Species/Paint on Chassis/Door Fronts -  
 Makore (MK2), Maple (MA2), Walnut (WA2),  
 Double Cut (DC1) or Paint (PNT)  
 (see page 62)
- ③ Finish Color for Chassis/Door Fronts  
 (see page 62)
- ④ Finish Color for Base
  - a.) Same as Chassis/Drawer Front
  - b.) Paint (see page 62)

Note: Only one wood finish and one paint color can be specified per unit

Description	D	W	H	CTN WT	CU FT	① Model	List Price
70½" h Storage Unit with Drawer and Flush Base	22	18	70½	182	20	AP6-DDS-B-2218R	\$4,234
	22	18	70½	182	20	AP6-DDS-B-2218L	\$4,234

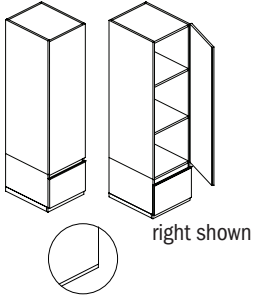

- base is flush
- two adjustable shelves
- pedestal front locking
- door side has concealed bevel for opening
- soft close hinge door
- locking door available, specify and add \$123 list
- adjustable levelers/glides

70½" h Storage Unit with Drawer and Inset Base	22	18	70½	179	20	AP6-DDS-BR-2218R	\$4,234
	22	18	70½	179	20	AP6-DDS-BL-2218L	\$4,234

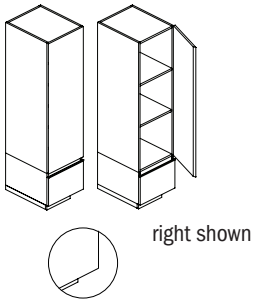

- base is inset on one side
- two adjustable shelves
- pedestal front locking
- door side has concealed bevel for opening
- soft close hinge door
- locking door available, specify and add \$123 list
- adjustable levelers/glides

must be mounted

70½" h Storage Unit with Flush Base	22	18	70½	163	20	AP6-ADS-2-2218R	\$3,551
	22	18	70½	163	20	AP6-ADS-2-2218L	\$3,551

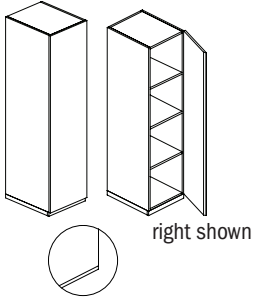

- base is flush
- three adjustable shelves
- door side has concealed bevel for opening
- soft close hinge door
- locking door available, specify and add \$123 list
- adjustable levelers/glides

70½" h Storage Unit with Inset Base	22	18	70½	160	20	AP6-ADS-2R-2218R	\$3,551
	22	18	70½	160	20	AP6-ADS-2L-2218L	\$3,551

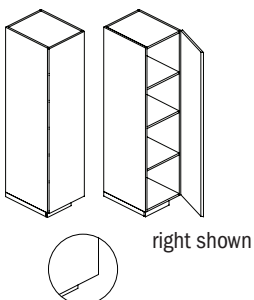

- base is inset on one side
- three adjustable shelves
- door side has concealed bevel for opening
- soft close hinge door
- locking door available, specify and add \$123 list
- adjustable levelers/glides

must be mounted

Description	D	W	H	CTN WT	CU FT	① Model	List Price
70 ½" h Wardrobe Unit with Flush Base	22	18	70 ½	150	20	AP6-ADS-1-2218R	\$3,323
	22	18	70 ½	150	20	AP6-ADS-1-2218L	\$3,323

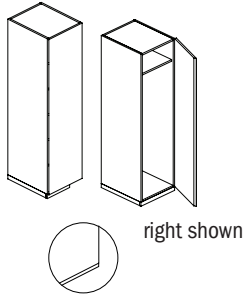

- base is flush
- fixed shelf
- hanging bar
- door side has concealed bevel for opening
- soft close hinge door
- locking door available, specify and add \$123 list
- adjustable leveler/glides

70 ½" h Wardrobe Unit with Inset Base	22	18	70 ½	147	20	AP6-ADS-1R-2218R	\$3,323
	22	18	70 ½	147	20	AP6-ADS-1L-2218L	\$3,323

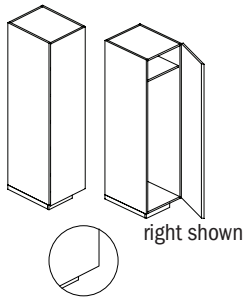

- base is inset on one side
- fixed shelf
- hanging bar
- door side has concealed bevel for opening
- soft close hinge door
- locking door available, specify and add \$123 list
- adjustable leveler/glides

must be mounted

**To Order, Specify:**

① Model Number

② Finish Application

a.) All Veneer

- 1.) Wood Species - Makore (MK2), Maple (MA2), Walnut (WA2) or Double Cut (DC1) (see page 62)

a.) Finish Color (see page 62)

b.) All Paint (PNT)

- 1.) Paint Color (see page 62)

c.) Veneer/Paint Combination

- 1.) Upper Chassis Wood Species/Paint - Makore (MK2), Maple (MA2), Walnut (WA2), Double Cut (DC1) or Paint (PNT) (see page 62)

a.) Finish Color for Upper Chassis (see page 62)

- 2.) Lower Chassis Wood Species/Paint - Makore (MK2), Maple (MA2), Walnut (WA2), Double Cut (DC1) or Paint (PNT) (see page 62)

a.) Finish Color for Lower Chassis (see page 62)

- 3.) Finish Color for Base -

a.) Same as Upper Chassis

b.) Same as Lower Chassis

c.) Paint

Note: Only one wood finish and one paint color can be specified per unit

Description	D	W	H	CTN WT	CU FT	① Model	List Price
70½" h Wardrobe Unit with Flush Base	22	12	70½	120	14	AP6-ADS-1-2212R	\$2,942
	22	12	70½	120	14	AP6-ADS-1-2212L	\$2,942

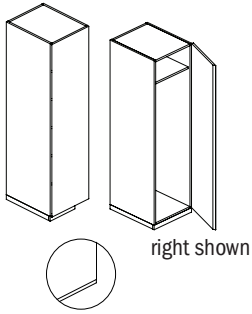

- base is flush
- fixed shelf
- coat hook
- door side has concealed bevel for opening
- soft close hinge door
- locking door available, specify and add \$123 list
- adjustable leveler/glides

must be mounted

70½" h Wardrobe Unit with Inset Base	22	12	70½	117	14	AP6-ADS-1R-2212R	\$2,942
	22	12	70½	117	14	AP6-ADS-1L-2212L	\$2,942

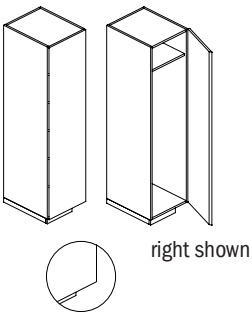

- base is inset on one side
- fixed shelf
- coat hook
- door side has concealed bevel for opening
- soft close hinge door
- locking door available, specify and add \$123 list
- adjustable leveler/glides

**To Order, Specify:**

- ① Model Number
- ② Wood Species/Paint on Chassis/Door Fronts -  
Makore (MK2), Maple (MA2), Walnut (WA2),  
Double Cut (DC1) or Paint (PNT)  
(see page 62)
- ③ Finish Color for Chassis/Door Fronts  
(see page 62)
- ④ Finish Color for Base
  - a.) Same as Chassis/Drawer Front
  - b.) Paint (see page 62)

Note: Only one wood finish and one paint color can be specified per unit

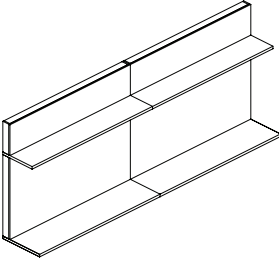
Description	D	W	H	CTN WT	CU FT	① Model	List Price
<b>144" w Dual Open Workwall with Shelf</b>  <ul style="list-style-type: none"> <li>• wall mounted</li> <li>• workwall top included (17 ¾" deep)</li> <li>• one fixed shelf</li> <li>• shipped in four sections</li> <li>• finish scheme                             <ul style="list-style-type: none"> <li>-workwall top - veneer only</li> <li>-chassis and shelves - veneer or paint</li> </ul> </li> <li>• two grommets 31" off center of each section of the workwall available, specify and add \$196 list</li> <li>• aluminum mini shelf available, specify and add \$1,890 list; an insert back panel is required when ordering a mini shelf</li> <li>• back insert panel between shelf and top available, indicate selection on order and select appropriate list price; panel reduces workwall by 1"                             <ul style="list-style-type: none"> <li>-veneer panel</li> <li>-paint panel</li> <li>-magnetic back painted white glass with thin aluminum frame and 6 magnets</li> <li>-tackable fabric panel - com ydg: 5</li> </ul> </li> </ul> <p>Note: use insert panel when wanting to add contrast</p>	22	144	57	568	124	AM4-CWO-SP-22144	<b>W/O PANEL \$13,279</b> <b>VENEER PANEL \$15,229</b> <b>PAINT PANEL \$15,229</b> <b>GLASS PANEL \$19,190</b> <b>FABRIC PANEL</b> <b>COM \$14,515</b> <b>A \$14,577</b> <b>B \$14,692</b> <b>C \$14,901</b> <b>D \$15,168</b> <b>E \$15,430</b> <b>F \$15,843</b> <b>G \$16,287</b> <b>H \$16,759</b> <b>I \$17,496</b> <b>J \$18,380</b>

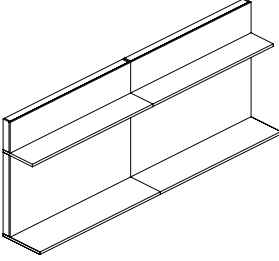
<b>120" w Dual Open Workwall with Shelf</b>  <ul style="list-style-type: none"> <li>• wall mounted</li> <li>• workwall top included (17 ¾" deep)</li> <li>• one fixed shelf</li> <li>• shipped in four sections</li> <li>• finish scheme                             <ul style="list-style-type: none"> <li>-workwall top - veneer only</li> <li>-chassis and shelves - veneer or paint</li> </ul> </li> <li>• two grommets 25" off center of each section of the workwall available, specify and add \$196 list</li> <li>• aluminum mini shelf available, specify and add \$1,818 list; an insert back panel is required when ordering a mini shelf</li> <li>• back insert panel between shelf and top available, indicate selection on order and select appropriate list price; panel reduces workwall by 1"                             <ul style="list-style-type: none"> <li>-veneer panel</li> <li>-paint panel</li> <li>-magnetic back painted white glass with thin aluminum frame and 6 magnets</li> <li>-tackable fabric panel - com ydg: 4 ½"</li> </ul> </li> </ul> <p>Note: use insert panel when wanting to add contrast</p>	22	120	57	474	104	AM4-CWO-SP-22120	<b>W/O PANEL \$12,367</b> <b>VENEER PANEL \$14,090</b> <b>PAINT PANEL \$14,090</b> <b>GLASS PANEL \$17,114</b> <b>FABRIC PANEL</b> <b>COM \$13,544</b> <b>A \$13,599</b> <b>B \$13,703</b> <b>C \$13,891</b> <b>D \$14,130</b> <b>E \$14,366</b> <b>F \$14,740</b> <b>G \$15,138</b> <b>H \$15,559</b> <b>I \$16,224</b> <b>J \$17,020</b>
---	----	-----	----	-----	-----	------------------	---

**To Order, Specify:**

- ① Model Number
- ② Wood Species on Top - Makore (MK2), Maple (MA2)  
Walnut (WA2) or Double Cut (DC1)  
(see page 62)
- ③ Finish Color for Top (see page 62)
- ④ Finish Color for Chassis/Shelves
  - a.) Same as Top
  - b.) Paint Color (see page 62)
- ⑤ Insert Panel
  - a.) Veneer
    - 1.) Wood Species - Makore (MK2), Maple (MA2), Walnut (WA2) or Double Cut (DC1)  
(see page 62)
    - a.) Finish Color (see page 62)
  - b.) Paint (PNT)
    - 1.) Paint Color (see page 62)
  - c.) Back Painted Magnetic Glass
  - d.) Fabric - vendor, pattern, color

Note: Only one wood finish and one paint color can be specified per unit

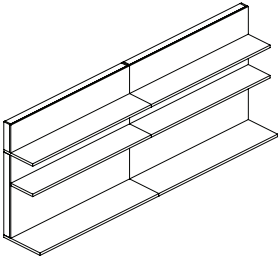
Description	D	W	H	CTN WT	CU FT	① Model	List Price
<b>144" w Dual Open Workwall with 2 Shelves</b>  <ul style="list-style-type: none"> <li>· wall mounted</li> <li>· workwall top included (17 ¾" deep)</li> <li>· two fixed shelves</li> <li>· shipped in four sections</li> <li>· finish scheme                             <ul style="list-style-type: none"> <li>-workwall top - veneer only</li> <li>-chassis and shelves - veneer or paint</li> </ul> </li> <li>· eight letter divider fins available, specify and add \$762 list</li> <li>· six legal divider fins available, specify and add \$573 list</li> <li>· two grommets 31" off center of each section of the workwall available, specify and add \$196 list</li> <li>· aluminum mini shelf available, specify and add \$1,890 list; an insert back panel is required when ordering a mini shelf</li> <li>· back insert panel between bottom shelf and top available, indicate selection on order and select appropriate list price; panel reduces workwall by 1"                             <ul style="list-style-type: none"> <li>-veneer panel</li> <li>-paint panel</li> <li>-magnetic back painted white glass with thin aluminum frame and 6 magnets</li> <li>-tackable fabric panel - com ydg: 5</li> </ul> </li> </ul>	22	144	57	610	124	AM4-CWO-S2-22144	<b>W/O PANEL \$13,406</b> <b> veneer panel \$15,356</b> <b> paint panel \$15,356</b> <b> glass panel \$19,316</b> <b> fabric panel</b> <b> COM \$14,644</b> <b> A \$14,705</b> <b> B \$14,819</b> <b> C \$15,027</b> <b> D \$15,294</b> <b> E \$15,556</b> <b> F \$15,972</b> <b> G \$16,414</b> <b> H \$16,886</b> <b> I \$17,623</b> <b> J \$18,507</b>

Note: use insert panel when wanting to add contrast

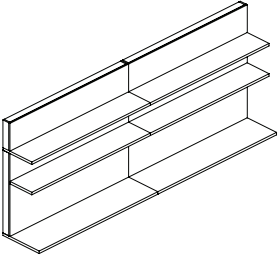
<b>120" w Dual Open Workwall with 2 Shelves</b>  <ul style="list-style-type: none"> <li>· wall mounted</li> <li>· workwall top included (17 ¾" deep)</li> <li>· two fixed shelves</li> <li>· shipped in four sections</li> <li>· finish scheme                             <ul style="list-style-type: none"> <li>-workwall top - veneer only</li> <li>-chassis and shelves - veneer or paint</li> </ul> </li> <li>· six letter divider fins available, specify and add \$573 list</li> <li>· six legal divider fins available, specify and add \$573 list</li> <li>· two grommets 25" off center of each section of the workwall available, specify and add \$196 list</li> <li>· aluminum mini shelf available, specify and add \$1,818 list; an insert back panel is required when ordering a mini shelf</li> <li>· back insert panel between bottom shelf and top available, indicate selection on order and select appropriate list price; panel reduces workwall by 1"                             <ul style="list-style-type: none"> <li>-veneer panel</li> <li>-paint panel</li> <li>-magnetic back painted white glass with thin aluminum frame and 6 magnets</li> <li>-tackable fabric panel - com ydg: 4 ½</li> </ul> </li> </ul>	22	120	57	508	104	AM4-CWO-S2-22120	<b>W/O PANEL \$12,494</b> <b> veneer panel \$14,332</b> <b> paint panel \$14,332</b> <b> glass panel \$17,241</b> <b> fabric panel</b> <b> COM \$13,670</b> <b> A \$13,726</b> <b> B \$13,830</b> <b> C \$14,017</b> <b> D \$14,256</b> <b> E \$14,493</b> <b> F \$14,867</b> <b> G \$15,264</b> <b> H \$15,685</b> <b> I \$16,351</b> <b> J \$17,147</b>
---	----	-----	----	-----	-----	------------------	--

Note: use insert panel when wanting to add contrast



Description	D	W	H	CTN WT	CU FT	① Model	List Price
144" w Dual Open Workwall with 3 Shelves	22	144	57	678	124	AM4-CW0-S3-22144	\$11,455

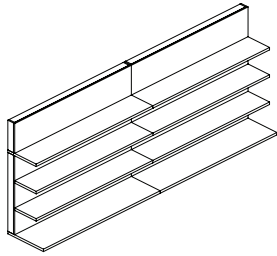

- wall mounted
- workwall top included (17 ¾" deep)
- three fixed shelves
- shipped in four sections
- finish scheme
  - workwall top - veneer only
  - chassis and shelves - veneer or paint
- eight letter divider fins available, specify and add \$762 list
- six legal divider fins available, specify and add \$573
- two grommets 31" off center of each section of the workwall available, specify and add \$196 list

120" w Dual Open Workwall with 3 Shelves	22	120	57	566	104	AM4-CW0-S3-22120	\$10,643
--	----	-----	----	-----	-----	------------------	----------

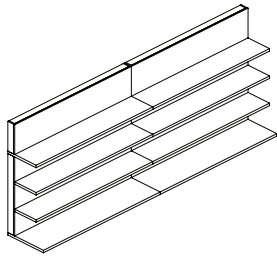

- wall mounted
- workwall top included (17 ¾" deep)
- three fixed shelves
- shipped in four sections
- finish scheme
  - workwall top - veneer only
  - chassis and shelves - veneer or paint
- six letter divider fins available, specify and add \$573 list
- six legal divider fins available, specify and add \$573 list
- two grommets 25" off center of each section of the workwall available, specify and add \$196 list

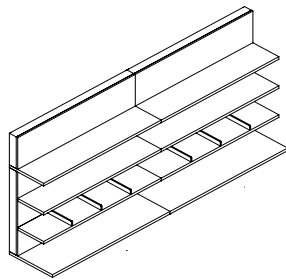

divider fins shown optional

**To Order, Specify:**

- ① Model Number
- ② Wood Species on Top - Makore (MK2), Maple (MA2) Walnut (WA2) or Double Cut (DC1) (see page 62)
- ③ Finish Color for Top (see page 62)
- ④ Finish Color for Chassis/Shelves
  - a.) Same as Top
  - b.) Paint Color (see page 62)
- ⑤ Insert Panel
  - a.) Veneer
    - 1.) Wood Species - Makore (MK2), Maple (MA2), Walnut (WA2) or Double Cut (DC1) (see page 62)
    - a.) Finish Color (see page 62)
  - b.) Paint (PNT)
    - 1.) Paint Color (see page 62)
  - c.) Back Painted Magnetic Glass
  - d.) Fabric - vendor, pattern, color

Note: Only one wood finish and one paint color can be specified per unit

Description	D	W	H	CTN WT	CU FT	① Model	List Price
<b>144" w Dual Wardrobe Workwall with Sliding Doors</b>	22	144	57	588	140	<b>AM4-CWW-1-22144</b>	<b>\$17,689</b>

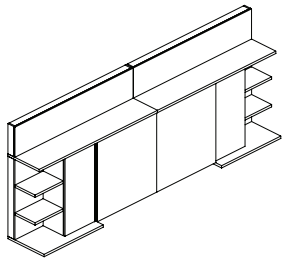

- must order work center section, see pages 169-172
- wall mounted
- workwall top included
- shipped in four sections
- left and right side
  - 18" w fixed outer shelves
  - 18" w storage/wardrobe (sliding interior bi-pass door) adjustable shelves and coat hook
- finish scheme
  - workwall top - veneer only
  - chassis, interior sliding doors and shelves
    - veneer
    - paint
  - exterior 36" w sliding doors
    - veneer
    - paint
    - back painted white glass with thin aluminum frame, add \$2,373 list
    - magnetic back painted white glass with thin aluminum frame and 6 magnets, add \$2,790 list

<b>120" w Dual Wardrobe Workwall with Sliding Doors</b>	22	120	57	448	118	<b>AM4-CWW-1-22120</b>	<b>\$16,725</b>
---	----	-----	----	-----	-----	------------------------	-----------------

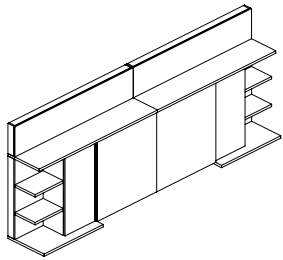

- must order work center section, see pages 169-172
- wall mounted
- workwall top included
- shipped in four sections
- left and right side
  - 15" w fixed outer shelves
  - 15" w storage/wardrobe (sliding interior bi-pass door) adjustable shelves and coat hook
- finish scheme
  - workwall top - veneer only
  - chassis, interior sliding doors and shelves
    - veneer
    - paint
  - exterior 30" w sliding doors
    - veneer
    - paint
    - back painted white glass with thin aluminum frame, add \$2,186 list
    - magnetic back painted white glass with thin aluminum frame and 6 magnets, add \$2,564 list

Description	D	W	H	CTN WT	CU FT	① Model	List Price
<b>144" w Wardrobe Workwall and Shelf Workwall with Sliding Doors</b>	22	144	57	572	138	<b>AM4-CWC-WS-22144</b>	<b>\$16,029</b>

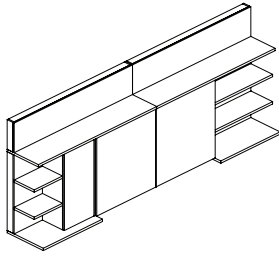

- must order work center section, see pages 169-172
- wall mounted
- workwall top included
- shipped in four sections
- left side
  - 18" w fixed outer shelves
  - 18" w storage/wardrobe (sliding interior bi-pass door) adjustable shelves and coat hook
- right side
  - 36" w fixed outer shelves
- finish scheme
  - workwall top - veneer only
  - chassis, interior sliding doors and shelves
    - veneer
    - paint
  - exterior 36" w sliding doors
    - veneer
    - paint
    - back painted white glass with thin aluminum frame, add \$2,373 list
    - magnetic back painted white glass with thin aluminum frame and 6 magnets, add \$2,790 list

<b>120" w Wardrobe Workwall and Shelf Workwall with Sliding Door</b>	22	120	57	434	115	<b>AM4-CWC-WS-22120</b>	<b>\$15,204</b>
--	----	-----	----	-----	-----	-------------------------	-----------------

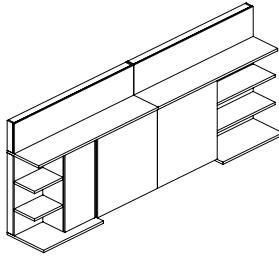

- must order work center section, see pages 169-172
- wall mounted
- workwall top included
- shipped in four sections
- left side
  - 15" w fixed outer shelves
  - 15" w storage/wardrobe (sliding interior bi-pass door) adjustable shelves and coat hook
- right side
  - 30" w fixed outer shelves
- finish scheme
  - workwall top - veneer only
  - chassis, interior sliding doors and shelves
    - veneer
    - paint
  - exterior 30" w sliding doors
    - veneer
    - paint
    - back painted white glass with thin aluminum frame, add \$2,186 list
    - magnetic back painted white glass with thin aluminum frame and 6 magnets, add \$2,564 list

**To Order, Specify:**

- ① Model Number Note: Only one wood finish and one paint color can be specified
- ② Wood Species on Top - Makore (MK2), Maple (MA2) per unit  
Walnut (WA2) or Double Cut (DC1)  
(see page 62)
- ③ Finish Color for Top (see page 62)
- ④ Finish Color for Chassis, Interior Sliding Doors and Shelves
  - a.) Same as Top
  - b.) Paint Color (see page 62)
- ⑤ Exterior Sliding Doors
  - a.) Same as Top
  - b.) Paint Color (see page 62)
  - c.) Glass

APOGEE™

Description	D	W	H	CTN WT	CU FT	① Model	List Price
<b>144" w Shelf Workwall and Wardrobe Workwall with Sliding Doors</b>	22	144	57	572	138	<b>AM4-CWC-SW-22144</b>	<b>\$16,029</b>

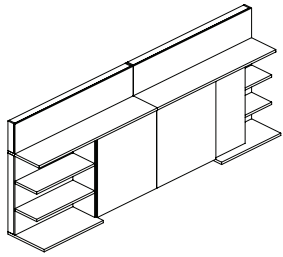

- must order work center section, see pages 169-172
- wall mounted
- workwall top included
- shipped in four sections
- left side
  - 36" w fixed outer shelves
- right side
  - 18" w fixed outer shelves
  - 18" w storage/wardrobe (sliding interior bi-pass door) adjustable shelves and coat hook
- finish scheme
  - workwall top - veneer only
  - chassis, interior sliding doors and shelves
    - veneer
    - paint
  - exterior 36" w sliding doors
    - veneer
    - paint
    - back painted white glass with thin aluminum frame, add \$2,373 list
    - magnetic back painted white glass with thin aluminum frame and 6 magnets, add \$2,790 list

<b>120" w Shelf Workwall and Wardrobe Workwall with Sliding Doors</b>	22	120	57	434	115	<b>AM4-CWC-SW-22120</b>	<b>\$15,204</b>
---	----	-----	----	-----	-----	-------------------------	-----------------

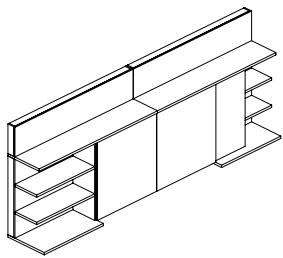

- must order work center section, see pages 169-172
- wall mounted
- workwall top included
- shipped in four sections
- left side
  - 30" w fixed outer shelves
- right side
  - 15" w fixed outer shelves
  - 15" w storage/wardrobe (sliding interior bi-pass door) adjustable shelves and coat hook
- finish scheme
  - workwall top - veneer only
  - chassis, interior sliding doors and shelves
    - veneer
    - paint
  - exterior 36" w sliding doors
    - veneer
    - paint
    - back painted white glass with thin aluminum frame, add \$2,186 list
    - magnetic back painted white glass with thin aluminum frame and 6 magnets, add \$2,564 list

Description	D	W	H	CTN WT	CU FT	① Model	List Price
<b>144" w Wardrobe Workwall and Display Workwall with Sliding Doors</b>	22	144	57	550	138	<b>AM4-CWC-WD-22144</b>	<b>\$15,649</b>

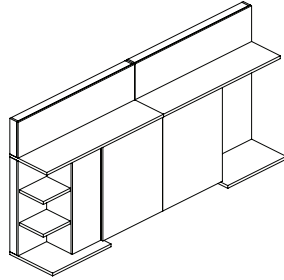

- must order work center section, see pages 169-172
- wall mounted
- workwall top included
- shipped in four sections
- left side
  - 18" w fixed outer shelves
  - 18" w storage/wardrobe (sliding interior bi-pass door) adjustable shelves and coat hook
- right side
  - 36" w open display area
- finish scheme
  - workwall top - veneer only
  - chassis, interior sliding door and shelves
    - veneer
    - paint
  - exterior 36" w sliding doors
    - veneer
    - paint
    - back painted white glass with thin aluminum frame, add \$2,373 list
    - magnetic back painted white glass with thin aluminum frame and 6 magnets, add \$2,548 list

<b>120" w Wardrobe Workwall and Display Workwall with Sliding Doors</b>	22	120	57	417	115	<b>AM4-CWC-WD-22120</b>	<b>\$14,825</b>
---	----	-----	----	-----	-----	-------------------------	-----------------

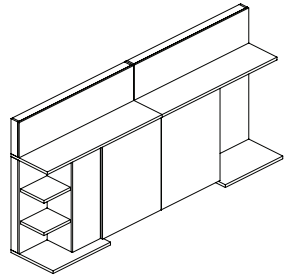

- must order work center section, see pages 169-172
- wall mounted
- workwall top included
- shipped in four sections
- left side
  - 15" w fixed outer shelves
  - 15" w storage/wardrobe (sliding interior bi-pass door) adjustable shelves and coat hook
- right side
  - 30" w open display area
- finish scheme
  - workwall top - veneer only
  - chassis, interior sliding door and shelves
    - veneer
    - paint
  - exterior 30" w sliding doors
    - veneer
    - paint
    - back painted white glass with thin aluminum frame, add \$2,186 list
    - magnetic back painted white glass with thin aluminum frame and 6 magnets, add \$2,564 list

**To Order, Specify:**

- ① Model Number
  - ② Wood Species on Top - Makore (MK2), Maple (MA2) Walnut (WA2) or Double Cut (DC1) (see page 62)
  - ③ Finish Color for Top (see page 62)
  - ④ Finish Color for Chassis, Interior Sliding Doors and Shelves
    - a.) Same as Top
    - b.) Paint Color (see page 62)
  - ⑤ Exterior Sliding Doors
    - a.) Same as Top
    - b.) Paint Color (see page 62)
    - b.) Glass
- Note: Only one wood finish and one paint color can be specified per unit

APOGEE™

Description	D	W	H	CTN WT	CU FT	① Model	List Price
<b>144" w Display Workwall and Wardrobe Workwall with Sliding Doors</b>	22	144	57	550	138	<b>AM4-CWC-DW-22144</b>	<b>\$15,649</b>

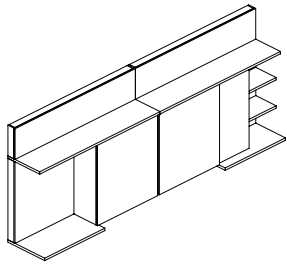

- must order work center section, see pages 169-172
- wall mounted
- workwall top included
- shipped in four sections
- left side
  - 36" w open display area
- right side
  - 18" w fixed outer shelves
  - 18" w storage/wardrobe (sliding interior bi-pass door) adjustable shelves and coat hook
- finish scheme
  - workwall top - veneer only
  - chassis, interior sliding door and shelves
    - veneer
    - paint
  - exterior 36" w sliding doors
    - veneer
    - paint
    - back painted white glass with thin aluminum frame, add \$2,373 list
    - magnetic back painted white glass with thin aluminum frame and 6 magnets, add \$2,790 list

<b>120" w Display Workwall and Wardrobe Workwall with Sliding Doors</b>	22	120	57	417	115	<b>AM4-CWC-DW-22120</b>	<b>\$14,825</b>
---	----	-----	----	-----	-----	-------------------------	-----------------

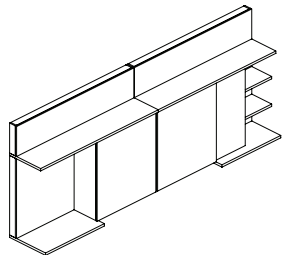

- must order work center section, see pages 169-172
- wall mounted
- workwall top included
- shipped in four sections
- left side
  - 30" w open display area
- right side
  - 15" w fixed outer shelves
  - 15" w storage/wardrobe (sliding interior bi-pass door) adjustable shelves and coat hook
- finish scheme
  - workwall top - veneer only
  - chassis, interior sliding door and shelves
    - veneer
    - paint
  - exterior 30" w sliding doors
    - veneer
    - paint
    - back painted white glass with thin aluminum frame, add \$2,186 list
    - magnetic back painted white glass with thin aluminum frame and 6 magnets, add \$2,564 list

Description	D	W	H	CTN WT	CU FT	① Model	List Price
144" w Dual Shelf Workwall with Sliding Doors	22	144	57	556	136	AM4-CWS-1-22144	\$14,370

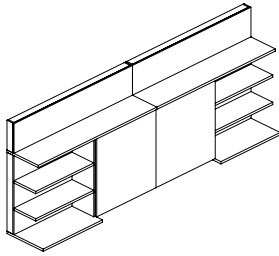

- must order work center section, see pages 169-172
- wall mounted
- workwall top included
- shipped in four sections
- left and right side
  - 36" w fixed outer shelves
- finish scheme
  - workwall top - veneer only
  - chassis and shelves
    - veneer
    - paint
  - exterior 36" w sliding doors
    - veneer
    - paint
  - back painted white glass with thin aluminum frame, add \$2,373 list
  - magnetic back painted white glass with thin aluminum frame and 6 magnets, add \$2,790 list

120" w Dual Shelf Workwall with Sliding Doors	22	120	57	420	112	AM4-CWS-1-22120	\$13,685
---	----	-----	----	-----	-----	-----------------	----------

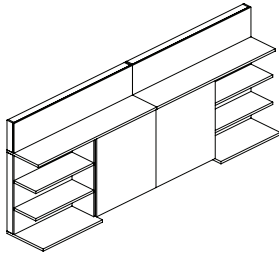

- must order work center section, see pages 169-172
- wall mounted
- workwall top included
- shipped in four sections
- left and right side
  - 30" w fixed outer shelves
- finish scheme
  - workwall top - veneer only
  - chassis and shelves
    - veneer
    - paint
  - exterior 30" w sliding doors
    - veneer
    - paint
  - back painted white glass with thin aluminum frame, add \$2,186 list
  - magnetic back painted white glass with thin aluminum frame and 6 magnets, add \$2,564 list

**To Order, Specify:**

- ① Model Number
- ② Wood Species on Top - Makore (MK2), Maple (MA2) Walnut (WA2) or Double Cut (DC1) (see page 62)
- ③ Finish Color for Top (see page 62)
- ④ Finish Color for Chassis, Interior Sliding Doors and Shelves
  - a.) Same as Top
  - b.) Paint Color (see page 62)

- ⑤ Exterior Sliding Doors
  - a.) Same as Top
  - b.) Paint Color (see page 62)
  - c.) Glass

Note: Only one wood finish and one paint color can be specified per unit

Description	D	W	H	CTN WT	CU FT	① Model	List Price
<b>144" w Shelf Workwall and Display Workwall with Sliding Doors</b>	22	144	57	534	136	<b>AM4-CWC-SD-22144</b>	<b>\$13,988</b>

- must order work center section, see pages 169-172
- wall mounted
- workwall top included
- shipped in four sections
- left side
  - 36" w fixed outer shelves
- right side
  - 36" w display area
- finish scheme
  - workwall top - veneer only
  - chassis and shelves
    - veneer
    - paint
  - exterior 36" w sliding doors
    - veneer
    - paint
    - back painted white glass with thin aluminum frame, add \$2,373 list
    - magnetic back painted white glass with thin aluminum frame and 6 magnets, add \$2,790 list

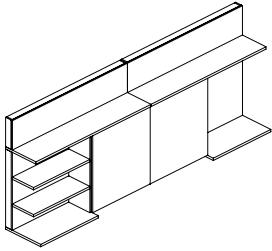

APOGEE™

<b>120" w Shelf Workwall and Display Workwall with Sliding Doors</b>	22	120	57	403	112	<b>AM4-CWC-SD-22120</b>	<b>\$13,304</b>
--	----	-----	----	-----	-----	-------------------------	-----------------

- must order work center section, see pages 169-172
- wall mounted
- workwall top included
- shipped in four sections
- left side
  - 30" w fixed outer shelves
- right side
  - 30" w display area
- finish scheme
  - workwall top - veneer only
  - chassis and shelves
    - veneer
    - paint
  - exterior 30" w sliding doors
    - veneer
    - paint
    - back painted white glass with thin aluminum frame, add \$2,186 list
    - magnetic back painted white glass with thin aluminum frame and 6 magnets, add \$2,564 list

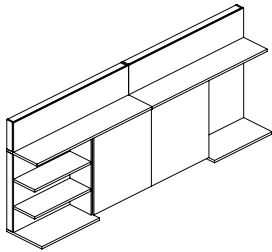



Description	D	W	H	CTN WT	CU FT	① Model	List Price
<b>144" w Display Workwall and Shelf Workwall with Sliding Doors</b>	22	144	57	534	136	<b>AM4-CWC-DS-22144</b>	<b>\$13,988</b>

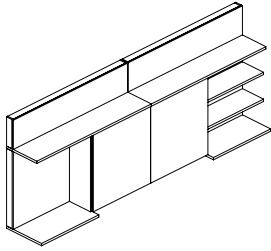

- must order work center section, see pages 169-172
- wall mounted
- workwall top included
- shipped in four sections
- left side
  - 36" w display area
- right side
  - 36" w outer fixed shelves
- finish scheme
  - workwall top - veneer only
  - chassis and shelves
    - veneer
    - paint
  - exterior 36" w sliding doors
    - veneer
    - paint
  - back painted white glass with thin aluminum frame, add \$2,373 list
  - magnetic back painted white glass with thin aluminum frame and 6 magnets, add \$2,790 list

<b>120" w Display Workwall and Shelf Workwall with Sliding Doors</b>	22	120	57	403	112	<b>AM4-CWC-DS-22120</b>	<b>\$13,304</b>
--	----	-----	----	-----	-----	-------------------------	-----------------

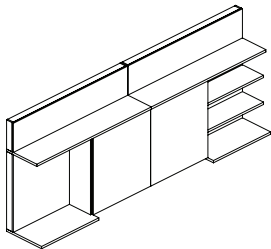

- must order work center section, see pages 169-172
- wall mounted
- workwall top included
- shipped in four sections
- left side
  - 30" w display area
- right side
  - 30" w outer fixed shelves
- finish scheme
  - workwall top - veneer only
  - chassis and shelves
    - veneer
    - paint
  - exterior 30" w sliding doors
    - veneer
    - paint
  - back painted white glass with thin aluminum frame, add \$2,186 list
  - magnetic back painted white glass with thin aluminum frame and 6 magnets, add \$2,564 list

**To Order, Specify:**

- ① Model Number Note: Only one wood finish and one paint color can be specified
- ② Wood Species on Top - Makore (MK2), Maple (MA2) per unit  
Walnut (WA2) or Double Cut (DC1)  
(see page 62)
- ③ Finish Color for Top (see page 62)
- ④ Finish Color for Chassis, Interior Sliding Doors and Shelves
  - a.) Same as Top
  - b.) Paint Color (see page 62)
- ⑤ Exterior Sliding Doors
  - a.) Same as Top
  - b.) Paint Color (see page 62)
  - c.) Glass

APOGEE™

Description	D	W	H	CTN WT	CU FT	① Model	List Price
-------------	---	---	---	-----------	----------	---------	------------

144" w Dual Display Workwall with Sliding Doors

22	144	57	512	136	AM4-CWD-1-22144	\$13,609
----	-----	----	-----	-----	-----------------	----------

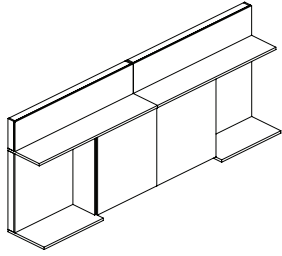

- must order work center section, see pages 169-172
- wall mounted
- workwall top included
- shipped in four sections
- left and right side
  - 36" w display area
- finish scheme
  - workwall top - veneer only
  - chassis and shelves
    - veneer
    - paint
  - exterior 36" w sliding doors
    - veneer
    - paint
    - back painted white glass with thin aluminum frame, add \$2,373 list
    - magnetic back painted white glass with thin aluminum frame and 6 magnets, add \$2,790 list

120" w Dual Display Workwall with Sliding Doors

22	120	57	386	112	AM4-CWD-1-22120	\$12,925
----	-----	----	-----	-----	-----------------	----------

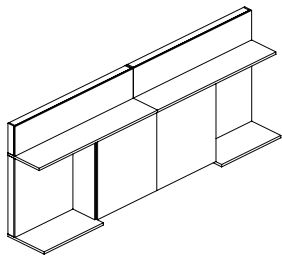

- must order work center section, see pages 169-172
- wall mounted
- workwall top included
- shipped in four sections
- left and right side
  - 30" w display area
- finish scheme
  - workwall top - veneer only
  - chassis and shelves
    - veneer
    - paint
  - exterior 30" w sliding doors
    - veneer
    - paint
    - back painted white glass with thin aluminum frame, add \$2,186 list
    - magnetic back painted white glass with thin aluminum frame and 6 magnets, add \$2,564 list

Description	D	W	H	CTN WT	CU FT	① Model	List Price
Workcenter	22	72	41	362	45	AM4-CZW-05-22144	\$4,995
	22	60	41	302	38	AM4-CZW-05-22120	\$4,792

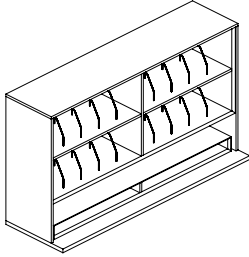

- -22144 use with 144" w workwall with sliding doors
- -22120 use with 120" w workwall with sliding doors
- wall mounted
- workwall top included
- wire pass thru
- -22144 cubby opening 34" w each
- -22120 cubby opening 28" w each

Media Workcenter with Cubby and Two Niches	22	72	41	291	45	AM4-CZW-06-22144	\$3,094
	22	60	41	243	38	AM4-CZW-06-22120	\$2,967

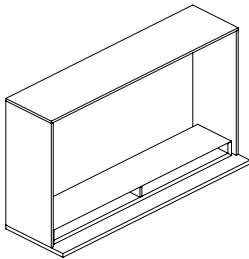

- -22144 use with 144" w workwall with sliding doors
- -22120 use with 120" w workwall with sliding doors
- wall mounted
- workwall top included
- wire pass thru
- -22144 cubby opening 34" w each
- -22120 cubby opening 28" w each
- -22144: TV dimension not to exceed 68" w x 32" h to allow proper mounting clearance and air circulation
- -22120: TV dimension not to exceed 56" w x 32" h to allow proper mounting clearance and air circulation

**To Order, Specify:**

**Workwall**

- ① Model Number
- ② Wood Species on Top - Makore (MK2), Maple (MA2) Walnut (WA2) or Double Cut (DC1) (see page 62)
- ③ Finish Color for Top (see page 62)
- ④ Finish Color for Chassis and Shelves
  - a.) Same as Top
  - b.) Paint Color (see page 62)
- ⑤ Exterior Sliding Doors
  - a.) Same as Top
  - b.) Paint Color (see page 62)
  - c.) Glass

**Workcenter**

- ① Model Number
- ② Wood Species on Top - Makore (MK2), Maple (MA2) Walnut (WA2) or Double Cut (DC1) (see page 62)
- ③ Finish Color for Top (see page 62)
- ④ Finish Color for Chassis
  - a.) Same as Top
  - b.) Paint Color (see page 62)
- ⑤ Cubby and Niche Paint Color

Note: Only one wood finish and one paint color can be specified per unit

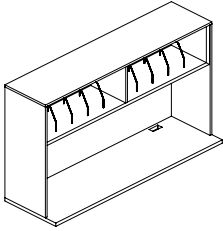
Description	D	W	H	CTN WT	CU FT	① Model	List Price
 <ul style="list-style-type: none"> <li>· use with 144" w workwall with sliding doors</li> <li>· wall mounted</li> <li>· LED task lights auto on off door switch</li> <li>· required insert panel available in veneer, paint, magnetic back painted white glass or fabric, indicate selection on order and select appropriate list price</li> <li>· glass insert panel has a thin aluminum frame</li> <li>· glass not factory installed</li> <li>· pack of 6 magnets come with magnetic glass option</li> <li>· worksurface grommets</li> <li>· com ydg: 5</li> </ul>	22	72	41	273	45	<b>AM4-CZW-01-22144</b>	<b>VENEER PANEL \$4,324</b>
							<b>PAINT PANEL \$4,324</b>
							<b>GLASS PANEL \$6,302</b>
							<b>FABRIC PANEL</b>
							<b>COM \$3,966</b>
							<b>A \$4,026</b>
							<b>B \$4,143</b>
							<b>C \$4,350</b>
							<b>D \$4,615</b>
							<b>E \$4,881</b>
							<b>F \$5,293</b>
							<b>G \$5,737</b>
							<b>H \$6,207</b>
						<b>I \$6,945</b>	
						<b>J \$7,828</b>	

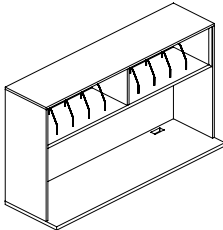
 <ul style="list-style-type: none"> <li>· use with 120" w workwall with sliding doors</li> <li>· wall mounted</li> <li>· LED task lights auto on off door switch</li> <li>· required insert panel available in veneer, paint, magnetic back painted white glass or fabric, indicate selection on order and select appropriate list price</li> <li>· glass insert panel has a thin aluminum frame</li> <li>· glass not factory installed</li> <li>· pack of 6 magnets come with magnetic glass option</li> <li>· worksurface grommets</li> <li>· com ydg: 5</li> </ul>	22	60	41	228	38	<b>AM4-CZW-01-22120</b>	<b>VENEER PANEL \$4,063</b>
							<b>PAINT PANEL \$4,063</b>
							<b>GLASS PANEL \$5,517</b>
							<b>FABRIC PANEL</b>
							<b>COM \$3,733</b>
							<b>A \$3,793</b>
							<b>B \$3,910</b>
							<b>C \$4,117</b>
							<b>D \$4,382</b>
							<b>E \$4,647</b>
							<b>F \$5,060</b>
							<b>G \$5,503</b>
							<b>H \$5,974</b>
						<b>I \$6,711</b>	
						<b>J \$7,594</b>	

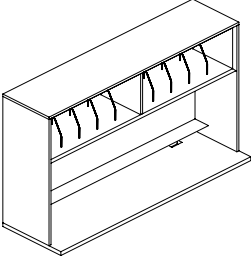
Description	D	W	H	CTN WT	CU FT	① Model	List Price	
 <ul style="list-style-type: none"> <li>• use with 144" w workwall with sliding doors</li> <li>• wall mounted</li> <li>• aluminum mini shelf</li> <li>• LED task light auto on off door switch</li> <li>• required insert panel available in veneer, paint, magnetic back painted white glass or fabric, indicate selection on order and select appropriate list price</li> <li>• glass insert panel has a thin aluminum frame</li> <li>• glass not factory installed</li> <li>• pack of 6 magnets come with magnetic glass option</li> <li>• worksurface grommets</li> <li>• com ydg; 4 ½</li> </ul>	72" w Workcenter	22	72	41	290	45	<b>AM4-CZW-02-22144</b>	<b>VENEER PANEL</b> \$5,583 <b>PAINT PANEL</b> \$5,583 <b>GLASS PANEL</b> \$7,562 <b>FABRIC PANEL</b> <b>COM</b> \$5,227 <b>A</b> \$5,281 <b>B</b> \$5,385 <b>C</b> \$5,572 <b>D</b> \$5,811 <b>E</b> \$6,050 <b>F</b> \$6,421 <b>G</b> \$6,818 <b>H</b> \$7,243 <b>I</b> \$7,907 <b>J</b> \$8,703

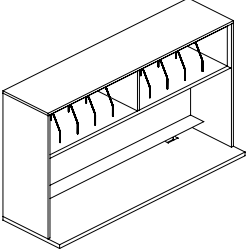
 <ul style="list-style-type: none"> <li>• use with 120" w workwall with sliding doors</li> <li>• wall mounted</li> <li>• aluminum mini shelf</li> <li>• LED task light auto on off door switch</li> <li>• required insert panel available in veneer, paint, magnetic back painted white glass or fabric, indicate selection on order and select appropriate list price</li> <li>• glass insert panel has a thin aluminum frame</li> <li>• glass not factory installed</li> <li>• pack of 6 magnets come with magnetic glass option</li> <li>• worksurface grommets</li> <li>• com ydg; 4 ½</li> </ul>	60" w Workcenter	22	60	41	242	38	<b>AM4-CZW-02-22120</b>	<b>VENEER PANEL</b> \$5,221 <b>PAINT PANEL</b> \$5,221 <b>GLASS PANEL</b> \$6,678 <b>FABRIC PANEL</b> <b>COM</b> \$4,893 <b>A</b> \$4,946 <b>B</b> \$5,052 <b>C</b> \$5,239 <b>D</b> \$5,476 <b>E</b> \$5,716 <b>F</b> \$6,087 <b>G</b> \$6,485 <b>H</b> \$6,909 <b>I</b> \$7,572 <b>J</b> \$8,370
---	------------------	----	----	----	-----	----	-------------------------	--

**To Order, Specify:**

- ① Model Number
- ② Wood Species on Workwall Top - Makore (MK2), Maple (MA2)  
Walnut (WA2) or Double Cut (DC1)  
(see page 62)
- ③ Finish Color for Workwall Top (see page 62)
- ④ Finish Color for Chassis
  - a.) Same as Workwall Top
  - b.) Paint (see page 62)
- ⑤ Cubby Paint Color

Note: Only one wood finish and one paint color can be specified per unit

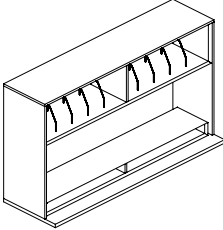
Description	D	W	H	CTN WT	CU FT	① Model	List Price
 <ul style="list-style-type: none"> <li>· use with 144" w workwall with sliding doors</li> <li>· wall mounted</li> <li>· LED task light auto on off door switch</li> <li>· wire pass thru</li> <li>· required insert panel available in veneer, paint, magnetic back painted white glass or fabric, indicate selection on order and select appropriate list price</li> <li>· glass insert panel has a thin aluminum frame</li> <li>· glass not factory installed</li> <li>· pack of 6 magnets come with magnetic glass option</li> <li>· worksurface grommets</li> <li>· cubby accepts (4) legal paper trays</li> <li>· cubby opening 34" w each</li> <li>· com ydg; 5</li> </ul>	22	72	41	323	45	AM4-CZW-03-22144	<b>VENEER PANEL</b> \$5,197 <b>PAINT PANEL</b> \$5,197 <b>GLASS PANEL</b> \$7,189 <b>FABRIC PANEL</b> <b>COM</b> \$4,852 <b>A</b> \$4,913 <b>B</b> \$5,031 <b>C</b> \$5,238 <b>D</b> \$5,503 <b>E</b> \$5,768 <b>F</b> \$6,180 <b>G</b> \$6,623 <b>H</b> \$7,093 <b>I</b> \$7,831 <b>J</b> \$8,715

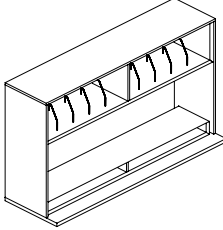
 <ul style="list-style-type: none"> <li>· use with 120" w workwall with sliding doors</li> <li>· wall mounted</li> <li>· LED task light auto on off door switch</li> <li>· wire pass thru</li> <li>· required insert panel available in veneer, paint, magnetic back painted white glass or fabric, indicate selection on order and select appropriate list price</li> <li>· glass insert panel has a thin aluminum frame</li> <li>· glass not factory installed</li> <li>· pack of 6 magnets come with magnetic glass option</li> <li>· worksurface grommets</li> <li>· cubby accepts (4) letter paper trays</li> <li>· cubby opening 28" w each</li> <li>· com ydg; 4 1/2</li> </ul>	22	60	41	269	38	AM4-CZW-03-22120	<b>VENEER PANEL</b> \$4,951 <b>PAINT PANEL</b> \$4,951 <b>GLASS PANEL</b> \$6,405 <b>FABRIC PANEL</b> <b>COM</b> \$4,618 <b>A</b> \$4,674 <b>B</b> \$4,779 <b>C</b> \$4,965 <b>D</b> \$5,205 <b>E</b> \$5,443 <b>F</b> \$5,815 <b>G</b> \$6,212 <b>H</b> \$6,635 <b>I</b> \$7,300 <b>J</b> \$8,097
---	----	----	----	-----	----	------------------	--

**To Order, Specify:**

- ① Model Number
- ② Wood Species on Top - Makore (MK2), Maple (MA2)  
Walnut (WA2) or Double Cut (DC1)  
(see page 62)
- ③ Finish Color for Top (see page 62)
- ④ Finish Color for Chassis
  - a.) Same as Top
  - b.) Paint (see page 62)
- ⑤ Cubby and Niche Paint Color

Note: Only one wood finish and one paint color can be specified per unit

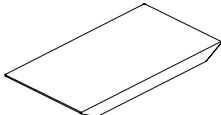
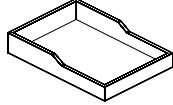
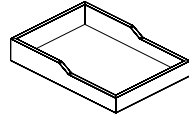
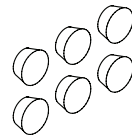
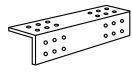
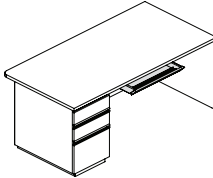
Description	D	W	H	CTN WT	CU FT	① Model	List Price
<b>Leather Desk Pad</b>  <ul style="list-style-type: none"> <li>· use on worksurfaces</li> <li>· col sq ft: 12</li> <li>· col list price \$524</li> </ul>	20	34		15	1	<b>AP9-LDP-1-2034</b>	L1 \$1,412 L2 \$1,623
<b>Letter Paper Tray</b>  <ul style="list-style-type: none"> <li>· select veneer or paint</li> </ul>	10 ¼	13	2 ¾	3	1	<b>AM9-PPT-1-1013</b>	\$396
<b>Legal Paper Tray</b>  <ul style="list-style-type: none"> <li>· select veneer or paint</li> </ul>	11 ½	16 ¼	2 ¾	3	1	<b>AM9-PPT-1-1216</b>	\$440
<b>Magnets</b>  <ul style="list-style-type: none"> <li>· may be used with magnetic glass panels</li> <li>· white</li> <li>· pack of 6</li> </ul>				3	1	<b>GP9-MAG-1-0101</b>	\$82
<b>Angle Bracket</b>  <ul style="list-style-type: none"> <li>· use when connecting a bridge to an open frame table desk</li> <li>· shipped with screws</li> </ul>	1	6	1	2	1	<b>6-AB</b>	\$356
<b>Angled Front Center Drawer</b>  <ul style="list-style-type: none"> <li>· not available on table desk with apron</li> <li>· not available in makore or double cut</li> <li>· wood drawer</li> <li>· non-locking</li> </ul>	17 ¾	24 ½	2 ½	20	1	<b>GP9CDRC-1524</b>	\$356

**To Order, Specify:**

- ① Model Number
- ② Wood Species - Cherry (CH1), Maple (MA2) or Walnut (WA2) (see page 62)
- ③ Leather - vendor, pattern, color

APOGEE™





## Bourne Product Information



BOURNE

Standard Height Tables . . . . .	188
Counter Height Tables . . . . .	192
Bar Height Tables . . . . .	196
Storage . . . . .	198

## Bourne Tables Order Check List:



**Specify:**

- 1. Model Number
- 2. Top Material
  - a.) Veneer
    - 1.) Wood Species - Cherry (CH1), Maple (MA1), Walnut (WA1) or Double Cut (DC1)
    - 2.) Wood Finish
  - b.) Laminate
    - 1.) Laminate Color
  - c.) Solid Surface
    - 1.) Solid Surface Color - Armadillo (ARM), Pebble Pearl (PEB), or Pure White (PUR)
- 3. Legs/Apron Wood Species
  - a.) Maple (M)
    - 1.) Wood or Paint Color
  - b.) Walnut (W) (upcharge applies)
    - 1.) Wood Finish
- 4. Metal Legs/Foot Rail Color - Arctic Silver (ASL), Matte Black (MBK), Pewter (PEW) or Soft Nickel (SNK)
- 5. Optional Accessory Hooks - four hooks; specify and add \$172 list
- 6. Optional Power Unit - units must be ordered separately
  - EC26 - worksurface power, specify cut-out on order - specify Black (B), or White (W)
  - EC27 - under surface power - specify Black (B), or White (W)

BOURNE

**Example:**

BU2448-17TTWL (model #)	WA1 (veneer species)	MCH (wood finish)	W (legs/apron species)	ESP (wood finish)	ASL (metal color)
----------------------------	-------------------------	----------------------	---------------------------	----------------------	----------------------

**1. Model Number**

**2. Top Material Selection:**

Veneer

**Cherry (CH1)**

- BRL Barley
- BBM Bourbon Medium
- BRM Brighton Medium
- CLA Classic
- CLL Collectors\*
- EAR Earthy
- HRV Harvest\*
- LGC Legacy
- PRL Praline\*
- SAF Saffron

*Flat Cut*

**Maple (MA1)**

- ALM Ale Medium
- BUT Butterscotch
- CIN Cinnamon
- FLX Flax
- VEN Venetian

**Walnut (WA1)**

- AUB Auburn
- ESP Espresso
- MCH Mocha\*
- NTO Night Owl\*
- SIE Sienna\*
- TOF Toffee
- TRF Truffle\*

**Double Cut (DC1)**

- COF Coffee
- CRM Cremello
- FOS Fossil
- GRH Graphite
- KHK Khaki
- STU Studio Teak

\*finishes have coordinating laminate top

**Top Material Selection (continued):**

Laminate

Veneer Grain Pattern Laminates

- |                     |                     |
|---------------------|---------------------|
| AGA Aged Ash        | CLL Collectors      |
| ALL Ale Light       | FLO Florence Walnut |
| BLO Blonde Echo     | GRH Graphite        |
| BOL Bourbon Light   | HGL High Line       |
| BZW Brazilwood      | OAT Oatmeal Cookie  |
| BGL Brighton Light  | PIN Pinnacle Walnut |
| CLL Collectors      | STU Studio Teak     |
| FLO Florence Walnut | VIN Vintage         |
| GRH Graphite        | WLH Walnut Heights  |
| HGL High Line       | WEA Weathered Ash   |

Solid Laminates

- |                    |                |
|--------------------|----------------|
| ALB Alabaster      | SHD Shadow     |
| BBL Bridal Blanco  | SLG Slate Grey |
| DWH Designer White |                |

Laminate Match to Veneer

- |               |              |
|---------------|--------------|
| AUB Auburn    | PRL Praline  |
| BRL Barley    | SAF Saffron  |
| CIN Cinnamon  | SIE Sienna   |
| CLA Classic   | TOF Toffee   |
| LGC Legacy    | TRF Truffle  |
| MCH Mocha     | VEN Venetian |
| NTO Night Owl |              |

**Solid Surface**

- |                 |                  |
|-----------------|------------------|
| ARM Armadillo   | PUR Pure White   |
| BLP Black Pearl | PEB Pebble Pearl |

**3. Legs/Apron Selection:**

**Maple (MA1)**

Wood Finish:

CAG Aged Ash Coordinate	CGR Graphite Coordinate
ALM Ale Medium	HRV Harvest
AUB Auburn	CHL High Line Coordinate
BRL Barley	CKC Khaki Coordinate
CBE Blonde Echo Coordinate	LGC Legacy
BBM Bourbon Medium	MCH Mocha
CBZ Brazilwood Coordinate	NTO Night Owl
BRM Brighton Medium	COA Oatmeal Cookie Coordinate
BUT Butterscotch	CPI Pinnacle Walnut Coordinate
CIN Cinnamon	PRL Praline
CLA Classic	SAF Saffron
CLL Collectors	SIE Sienna
CCF Coffee Coordinate	CST Studio Teak Coordinate
CCR Cremello Coordinate	TOF Toffee
EAR Earthy	TRF Truffle
ESP Espresso	VEN Venetian
FLX Flax	CVI Vintage Coordinate
CFL Florence Walnut Coordinate	CWH Walnut Heights Coordinate
CFO Fossil Coordinate	CWE Weathered Ash Coordinate

Paint Color:

BKD Backdrop	GRV Greek Villa
BFX Black Fox	NET Network Gray
BWH Bright White	NWH Nonchalant White
CGP Cargo Pants	STM Storm
CHT Chatroom	TRC Tricorn Black
FRR French Roast	

**Walnut (WA1) (upcharge applies)**

Wood Finish:

AUB Auburn	SIE Sienna
ESP Espresso	TOF Toffee
MCH Mocha	TRF Truffle
NTO Night Owl	

**4. Metal Legs/Foot Rail Color:**

ASL Arctic Silver	PEW Pewter
MBK Matte Black	SNK Soft Nickel

**5. Optional Accessory Hooks - four hooks; specify and add \$172 list**

**6. Power Unit - Power Units can be specified**

**Worksurface - EC26** - Two 110 outlets and a dual USB port with a 120" power cord - Black (B) or White (W); see page 199.

**Under Surface - EC27** - Two 110 outlets and a dual USB port with a 120" power cord - Black (B) or White (W); see page 199.

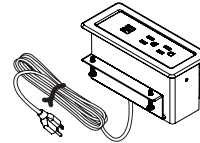

**EC26**

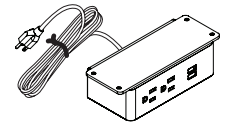

**EC27**

**Table Order Check List**

a. worksurface - veneer, laminate, or solid surface choice

(choose one)

- cherry
- maple
- walnut
- double cut
- laminate
- solid surface

finish, laminate or solid surface color:

(see previous page for choices) \_\_\_\_\_

b. legs/apron

(choose one)

- maple
- walnut (upcharge applies)

legs/apron finish/paint color:

(see above for choices) \_\_\_\_\_

c. metal legs/foot rail color (if applicable)

(choose one)

- arctic silver
- matte black
- pewter
- soft nickel

d. optional accessory hooks (add \$172 list)

- four hooks

e. optional power units

- EC26 - worksurface power unit; must be ordered separately
- EC27 - under surface power unit; must be ordered separately

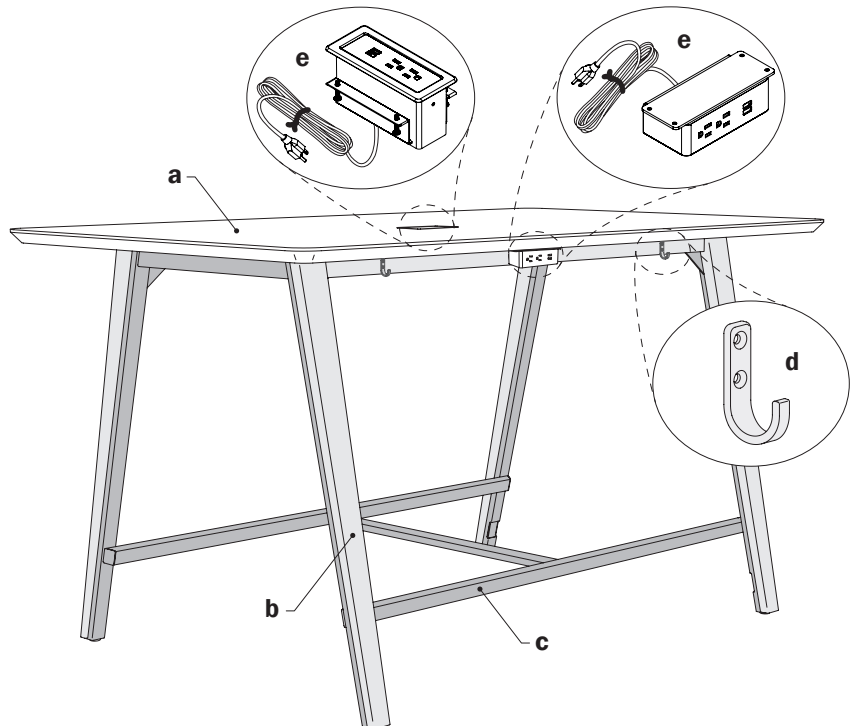

## Bourne Storage Order Check List:



**Specify:**

- 1. Model Number
- 2. Chassis Species - Cherry (CH1), Maple (MA1), Walnut (WA1) or Double Cut (DC1)
- 3. Base Wood Species:
  - a.) Maple (M) - Standard (finish will be same as chassis)
  - b.) Walnut (W) - Upcharge Applies (only available when walnut chassis is specified, finish will be same as chassis)
- 4. Chassis/Base Finish
- 5. Door Finish
  - a.) Same as Chassis
  - b.) Paint
    - 1.) Paint Color

**Examples:**

<b>BU1830-42STWL</b> (model #)	<b>MA1</b> (chassis species)	<b>M</b> (base species)	<b>ALM</b> (chassis/base finish)	<b>NET</b> (door paint color)
-----------------------------------	---------------------------------	----------------------------	-------------------------------------	----------------------------------

**1. Model Number**

**2. Chassis Species:**

*Flat Cut*

**Cherry (CH1)**

- BRL Barley
- BBM Bourbon Medium
- BRM Brighton Medium
- CLA Classic
- CLL Collectors
- EAR Earthy
- HRV Harvest
- LGC Legacy
- PRL Praline
- SAF Saffron

**Maple (MA1)**

- ALM Ale Medium
- BUT Butterscotch
- CIN Cinnamon
- FLX Flax
- VEN Venetian

**Walnut (WA1)**

- AUB Auburn
- ESP Espresso
- MCH Mocha
- NTO Night Owl
- SIE Sienna
- TOF Toffee
- TRF Truffle

**Double Cut (DC1)**

- COF Coffee
- CRM Cremello
- FOS Fossil
- GRH Graphite
- KHK Khaki
- STU Studio Teak

**3. Base Wood Species:**

**Maple (MA1)**

Wood Finish:  
Same as Chassis

**Walnut (WA1) (upcharge applies)**

Wood Finish:  
Same as Chassis

**4. Chassis/Base Finish:**

Wood Finish:

See list of finishes under **2. Chassis Species**  
(Base Finish same as Chassis)

**5. Door Finish Selection:**

Wood Finish:

**Same as Chassis**

Paint Color:

- |                  |                      |
|------------------|----------------------|
| BKD Backdrop     | GRV Greek Villa      |
| BFX Black Fox    | NET Network Gray     |
| BWH Bright White | NWH Nonchalant White |
| CGP Cargo Pants  | STM Storm            |
| CHT Chatroom     | TRC Tricorn Black    |
| FRR French Roast |                      |

BOURNE

**Storage Order Check List**

a. chassis species

(choose one)

- cherry
- maple
- walnut
- double cut

finish color:

(see previous page for finish choices) \_\_\_\_\_

b. base species

(choose one)

- maple (*finish will be same as chassis*)
- walnut (*upcharge applies*) (*only available when walnut chassis is specified, finish will be same as chassis*)

c. door finish

(choose one)

- same as chassis

paint color:

(see previous page for choices) \_\_\_\_\_

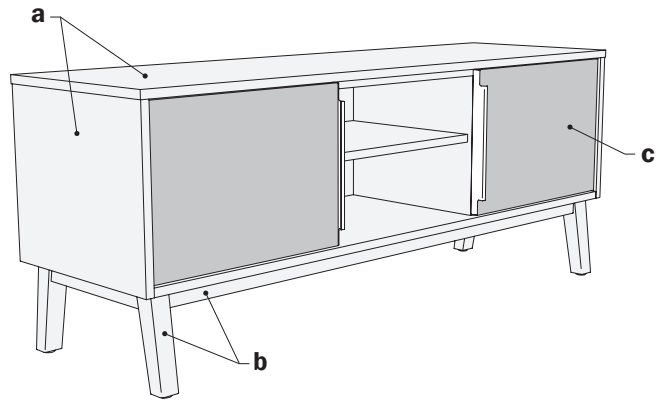

## Bourne Tables and Storage Product Information

### Exterior Wood Materials

Exterior surfaces are made from the finest selected veneers to achieve clarity and consistency in the Bourne product line. To attain a pleasing, symmetrical pattern, all veneers in Bourne are book-matched. All exterior solid lumber is matched to coordinate with the veneer.

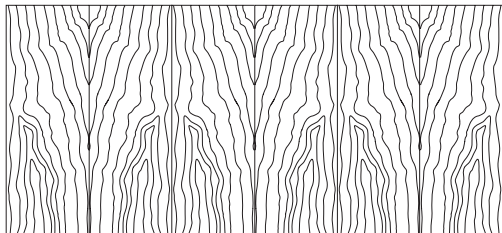

#### Book Matched Example

Alternating pieces of veneer are flipped over so they face each other like the pages within a book.

Bourne is available in flat cut cherry, maple and walnut veneer. A wide range of wood stains have been formulated to enhance the beauty of the veneer.

Double Cut veneer is another choice on Bourne Veneer product. This veneer is a processed product that has at least two cuttings to create the final veneers. These cuts of veneer strands are dyed and layered into a block to create variation of patterns from a very tight grain pattern to an exotic figure grain pattern.

The diagram below shows the tight pattern used on Bourne Double Cut Veneer.

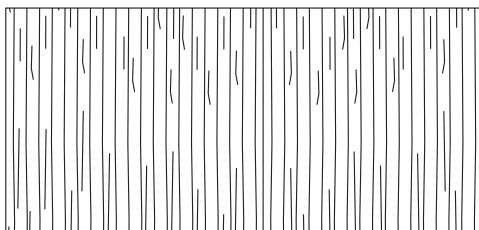

### Worksurface Construction

#### Veneer and Laminate Worksurface

Worksurfaces are 1 3/8" thick and are manufactured with 3-ply balanced construction. Surfaces are available in wood veneer or high pressure laminate. MDF edges on table tops have an undercut bevel profile and are painted to match top.

#### Solid Surface Worksurface

Solid surface worksurfaces are constructed with a 1/2" thick solid surface top and a 1/4" thick wood sub-top. Total thickness of this mixed material worksurface is 1 3/8". MDF edges on sub-top have an undercut bevel profile and are painted to match top.

### JSI Quickship Program

Laminates available on the quickship program include the following: Aged Ash (AGA), Ale Light (ALL), Bourbon Light (BOL), Brighton Light (BGL), Collectors (CLL), Designer White (DWH), Florence Walnut (FLO), Graphite (GRH), Pinnacle Walnut (PIN), Slate Grey (SLG), Studio Teak (STU), Vintage (VIN) and Walnut Heights (WLH).

Bourne Veneer species available on the quickship program include Cherry, Maple, Walnut and the following Double Cut veneers: Graphite (GRH), Khaki (KHK) and Studio Teak (STU).

Solid Surface tops available on the quickship program are available in Pure White (PUR) only.

### Casework Construction

Casework tops are made up of layers of hardwood veneers molded to shape and RF cured. Outer veneers are matched for uniform grain patterns. All casework tops are 3/4" thick plywood.

Casework chassis, doors and drawer fronts consist of veneer over composite wood core; all wood core components are 3/4" thick.

Cabinet doors have 110° swing hinges to allow adequate access into the interior of the cabinet.

### Drawers

The 9ply unidirectional hardwood sides of the drawer box are 7/16" thick assembled with English dovetail construction at each corner of the box. The drawer bottom panel is 1/4" thick fitting into a groove machined into the side of the box. Interiors are sanded and coated with clear U.V. finish to protect against shrinking, swelling or warping, and to provide a clean, smooth feel and appearance.

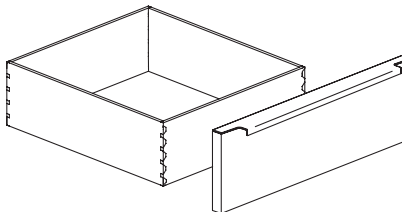

### Drawer Suspension

The high quality black drawer suspensions carry a lifetime warranty. Slides feature steel ball bearings for longer life with cushioned in/out stops. File and box drawers have 100% full extension with over travel.

### Finish - Stain/Colors

We offer a variety of wood stains and paint colors on Bourne. Please see the chart below. Samples are available upon request.

<b>CH1 Cherry</b>	<i>Flat Cut Veneer</i>	
BRL Barley		EAR Earthy
BBM Bourbon Medium		HRV Harvest
BRM Brighton Medium		LGC Legacy
CLA Classic		PRL Praline
CLL Collectors		SAF Saffron

<b>MA1 Maple</b>	<i>Flat Cut Veneer</i>	
ALM Ale Medium		FLX Flax
BUT Butterscotch		VEN Venetian
CIN Cinnamon		

<b>WA1 Walnut</b>	<i>Flat Cut Veneer</i>	
AUB Auburn		SIE Sienna
ESP Espresso		TOF Toffee
MCH Mocha		TRF Truffle
NTO Night Owl		

<b>DC1 Double Cut Veneer</b>		
COF Coffee		GRH Graphite
CRM Cremello		KHK Khaki
FOS Fossil		STU Studio Teak

<b>PNT Paint</b>		
BKD Backdrop		GRV Greek Villa
BFX Black Fox		NET Network Gray
BWH Bright White		NWH Nonchalant White

## Bourne Tables and Storage Product Information

### Finish - Stain/Colors (continued)

#### PNT Paint (continued)

CGP Cargo Pants	STM Storm
CHT Chatroom	TRC Tricorn Black
FRR French Roast	

### Protective Top Coat

DuraTex™ offers exceptional hardness along with abrasion and impact resistance, it has been formulated to eliminate hazardous and harmful gases that are normally associated with wood finish.

### DuraTex™ Features

**Safety** - Significantly reduces hazardous formaldehyde emissions, which help improve the quality of the of the indoor air we breathe.  
**Quality** - Developed to be tough and durable with special attention to appearance. The DuraTex™ finish preserves the natural beauty of wood.  
**Durability** - Designed to meet a wide range of demanding performance and environmental standards to withstand even the highest wear and tear.

To reduce hazardous formaldehyde emission we use our proprietary special-ly design top coat, DuraTex™. We are proud that our finish is GreenGuard certified.

### Care of Wood Edges and Veneer Surfaces

Clean all surfaces frequently with water dampened soft cloth, moving the cloth with the grain direction. Immediately remove any liquids that come in contact with wood surfaces, with a blotting action to absorb liquid. Buff dry. Lift objects to move them, never pull them across the finished surface. Avoid exposure of furniture to extremes of heat, cold, and wide variance of humidity. Avoid exposure of furniture to strong sunlight. Avoid exposure of furniture to harsh solvents such as nail polish remover, acetates, etc., as it will cause finish deterioration.

### Metal Components

Wipe smooth powder coat finishes and textured metals with a damp cloth. For stubborn stains and grease marks, use soap and water. Lightly brush textured metals with a soft, dry brush to remove dirt.

## Top Edge Details

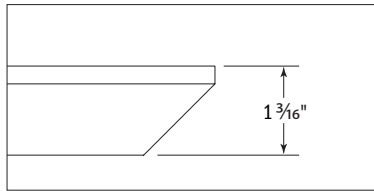

Knife Edge - Veneer & Laminate

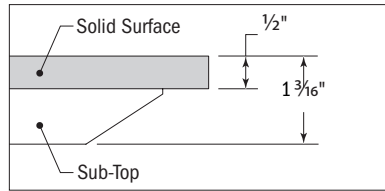

Painted Knife Edge with Solid Surface Top

## Optional Power Units

### Worksurface Surface Power

Optional Worksurface Power (EC26) is available on standard, counter and bar height tables. Indicate "to accommodate Worksurface Power" on your purchase order. When this option is specified the worksurface will have one cut out in the center. One EC26 Worksurface Power unit must be ordered separately, see page 199. Length of cord is 10 feet.

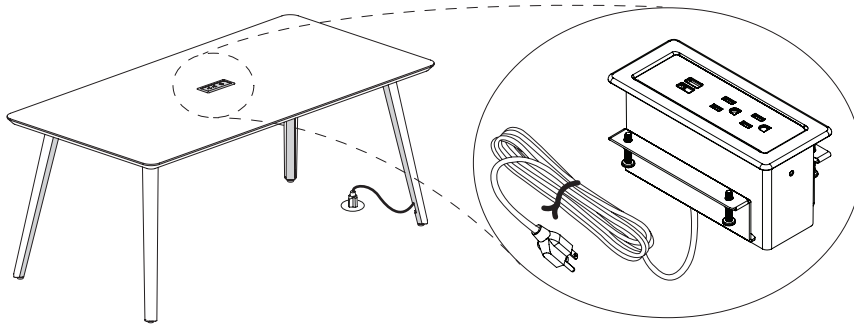

### Under Surface Power

Under Surface Power (EC27) may be ordered for standard, counter and bar height tables. The EC27 Under Surface Power Unit(s) must be ordered separately, see page 199. This unit is field installed. Length of cord is 10 feet.

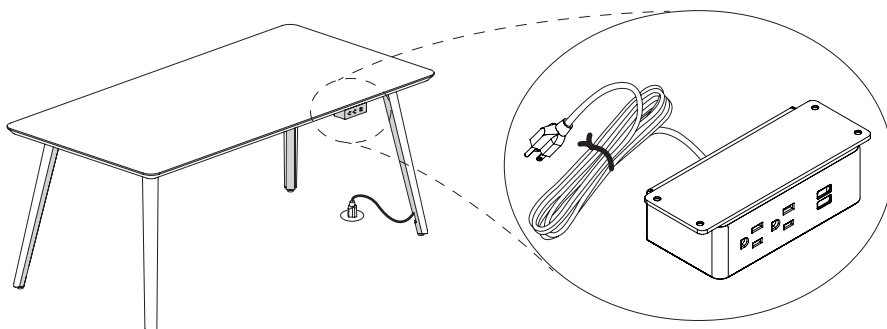

## Bourne Tables and Casework Product Information

### Wire Management - Standard and Counter Height Tables

Standard and counter height tables with metal legs contain one leg with a wire management channel/exit cutout which is accessed and concealed with a wood cap. This wire management leg can be attached to any corner of the table during assembly. Predetermining which corner of table cord exit is desired and assembly accordingly.

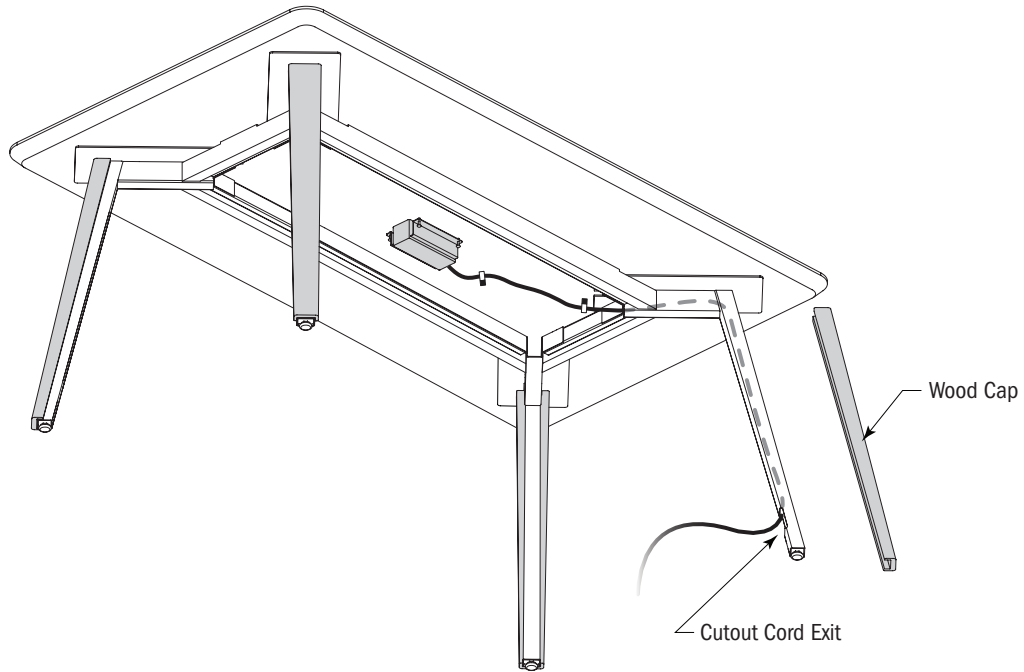

### Wire Management - Bar Height Tables

Bar height tables with metal legs has a set of legs on one side of table with wire management channel and exit cutout. The management channels are accessed and concealed with wood caps.

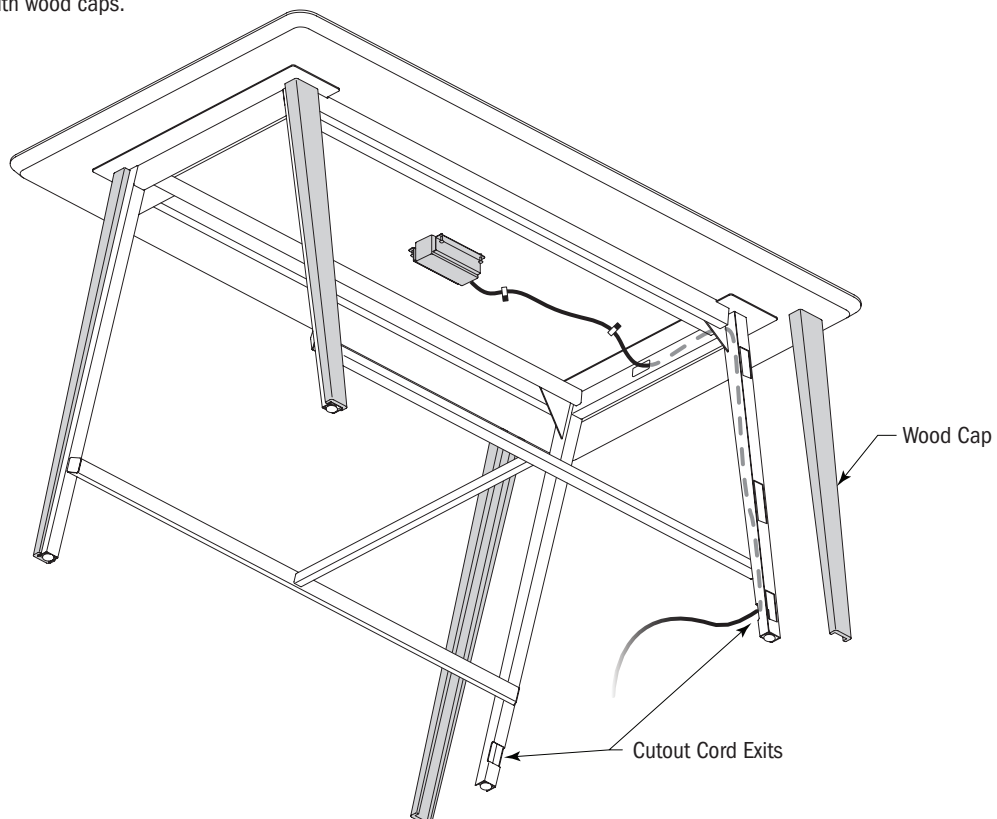



## Bourne Tables and Casework Product Information

### Optional Accessory Hooks

Optional satin stainless steel accessory hooks are available on the 30"h, 36"h and 40"h tables.

Four Hooks - add \$172 list

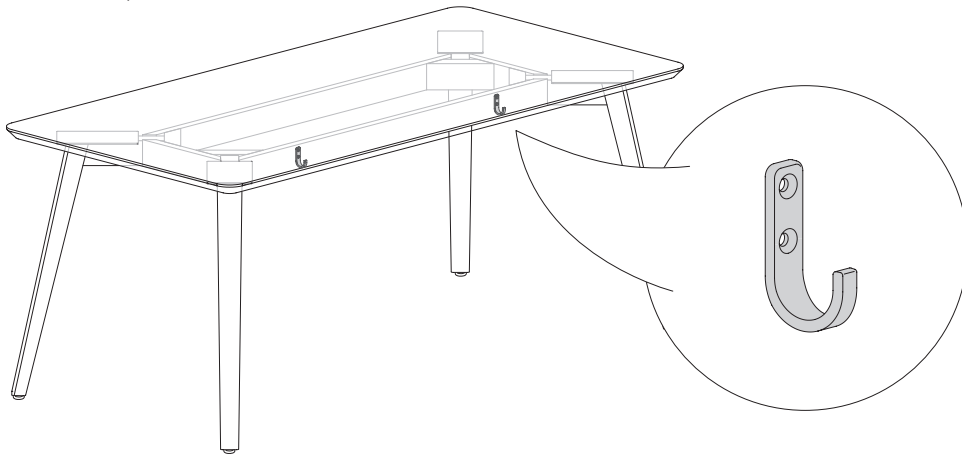

### Integrated Metal Pull

Storage Units offer integrated clear anodized aluminum pulls standard.

Low Storage

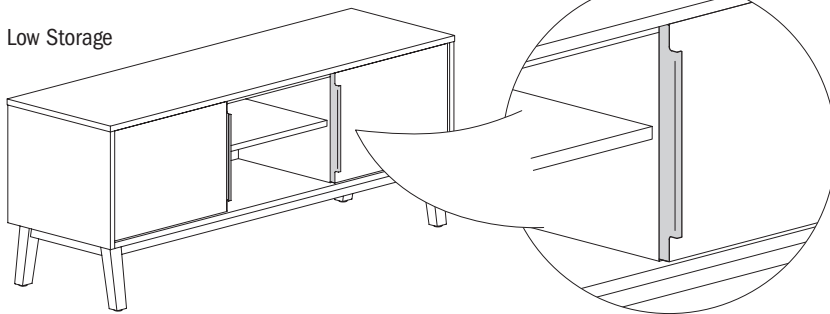

Tall Storage

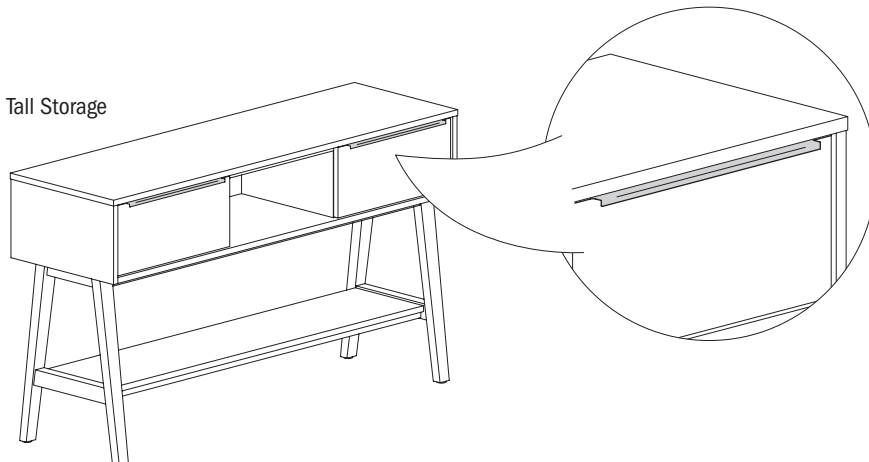

# Bourne Product Information

## Product Overview

Bourne Seating and Occasional Tables below can be found in the JSI Seating Price List

### Seating



Guest Chair  
Single Fabric



Guest Chair  
Dual Fabric



Lounge Chair  
Single Fabric



Lounge Chair  
Dual Fabric



Ottoman



Counter Height  
Stool



Bar Stool

### Occasional Tables



Rectangular  
Coffee Table



Square  
Coffee Table



Round  
Coffee Table



Triangular  
Coffee Table



Square  
Side Table



Round  
Side Table

### Standard and Counter Height Tables

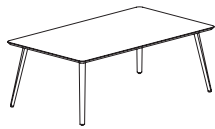

Rectangular Table  
with Wood Legs



Racetrack Table  
with Wood Legs



Square Table  
with Wood Legs



Round Table  
with Wood Legs

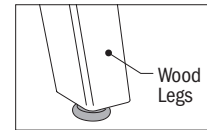

Rectangular Table  
with Wood/Metal Legs



Racetrack Table  
with Wood/Metal Legs



Square Table  
with Wood/Metal Legs



Round Table  
with Wood/Metal Legs

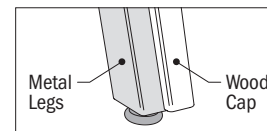

### Bar Height Tables

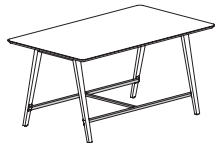

Rectangular Table with Wood Legs

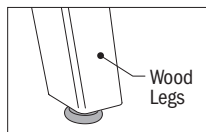

Rectangular Table with Wood/Metal Legs

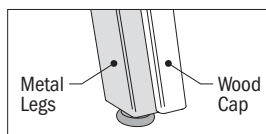

### Storage

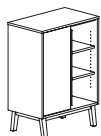

Tall Storage



Mid Storage



Low Storage

# Bourne Product Information

## Table Heights

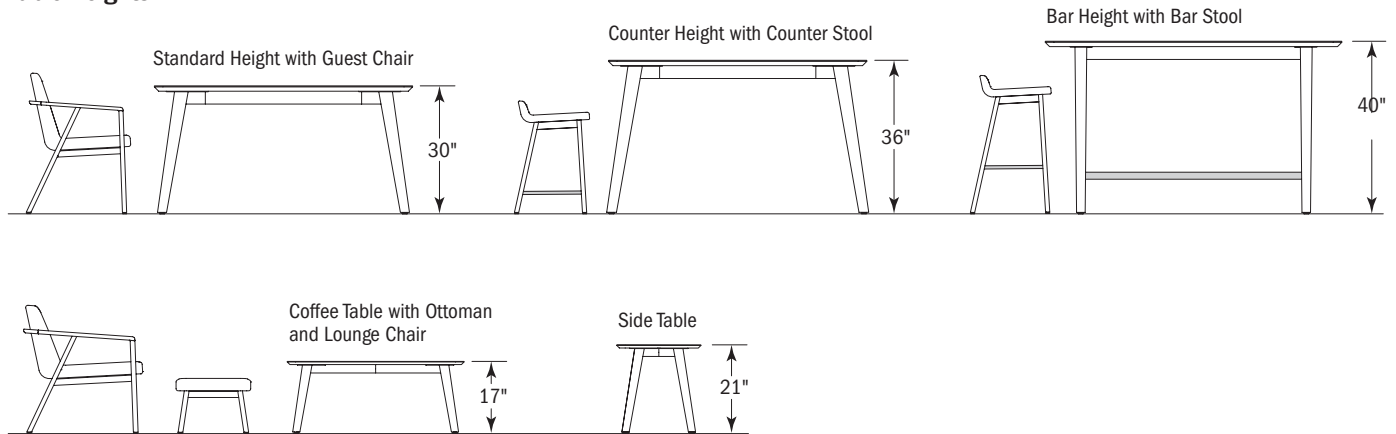

## Table Shapes



**rectangular**

sizes available:

- 48" x 90"
- 42" x 90"
- 48" x 84"
- 42" x 84"
- 48" x 72"
- 42" x 72"
- 36" x 72"

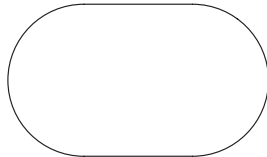

**racetrack**

sizes available:

- 48" x 90"
- 42" x 90"
- 48" x 84"
- 42" x 84"
- 48" x 72"
- 42" x 72"
- 42" x 60"

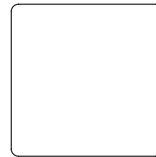

**square**

sizes available:

- 60" x 60"
- 48" x 48"
- 42" x 42"

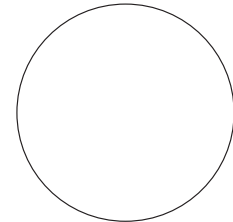

**round**

size: 60" dia.

BOURNE

Bourne Occasional Tables below can be found in the JSI Seating Price List

## Coffee Table Shapes



**rectangular**

size: 24" x 48"

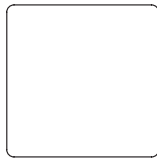

**square**

size: 42" x 42"

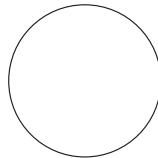

**round**

sizes available:  
42" dia.  
36" dia.

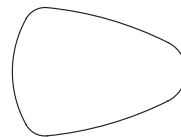

**triangular**

size: 36" x 48"

## Side Table Shapes



**square**

size: 20" x 20"



**round**

size: 24" dia.

**Typicals:  
BU001**

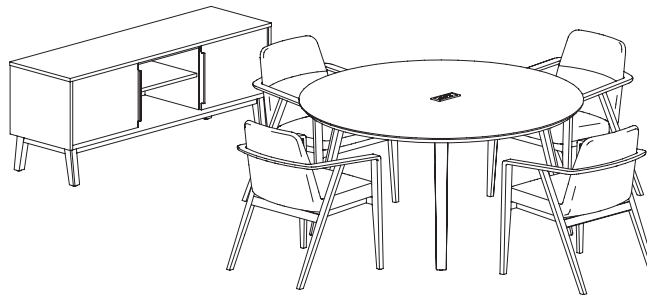
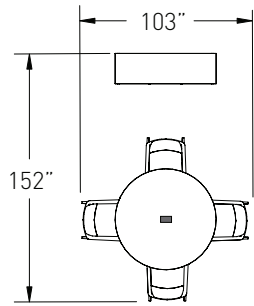

	Model	Description	Qty	List Price
1	BU60-30RDML	30"h round table with wood/metal legs	1	\$4,401
2	BU7511E	guest chair - dual textile	4	\$1,386
3	BU1860-24SCHD	low storage	1	\$3,222
4	EC26	worksurface power	1	\$606
<b>Typical List Price</b>				<b>\$13,773</b>

**BU002**

BOURNE

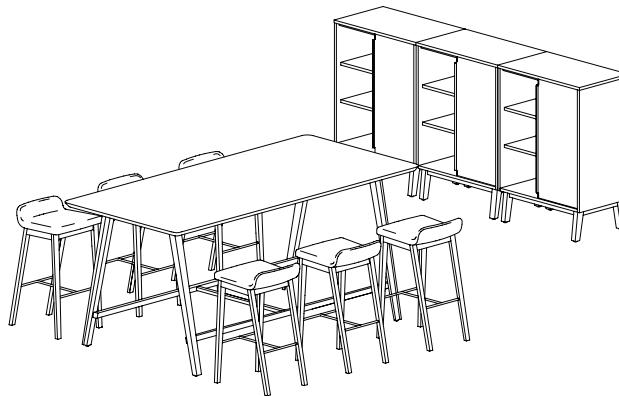
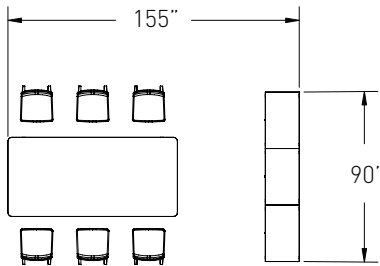

	Model	Description	Qty	List Price
1	BU4290-40TTMLH	40"h rectangular table with wood/metal legs	1	\$5,869
2	BU7518D	bar stool	6	\$1,149
3	BU1830-42STWR	tall storage	3	\$2,964
<b>Typical List Price</b>				<b>\$21,655</b>

**BU003**

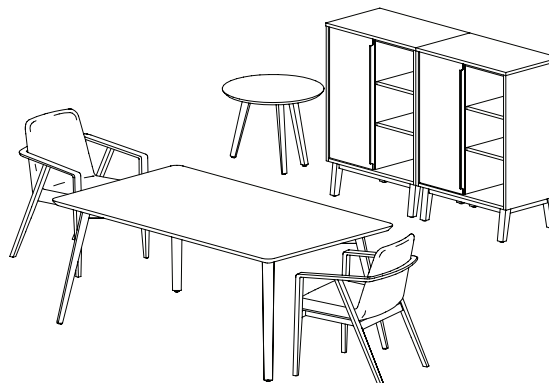
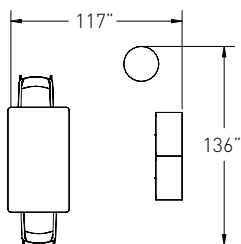

	Model	Description	Qty	List Price
1	BU4272-30TTWL	30"h rectangular table with wood legs	1	\$2,544
2	BU7511D	guest chair - single textile	2	\$1,325
3	BU1830-42STWL	tall storage	2	\$2,964
4	BU24-21RDWL	round side table	1	\$1,323
<b>Typical List Price</b>				<b>\$12,445</b>

**Typicals:  
BU004**

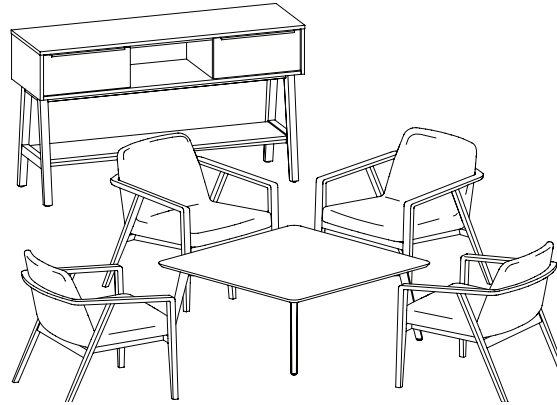
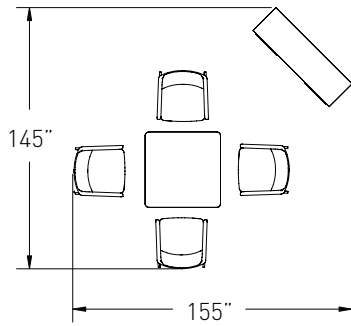

Model	Description	Qty	List Price
1 BU4242-17TTWL	square coffee table	1	\$1,522
2 BU7521D	lounge chair - single textile	4	\$1,561
3 BU1860-34SCD	mid storage	1	\$3,367
<b>Typical List Price</b>			<b>\$11,133</b>

**BU005**

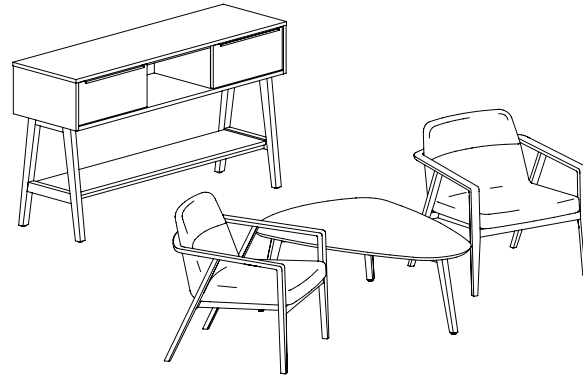
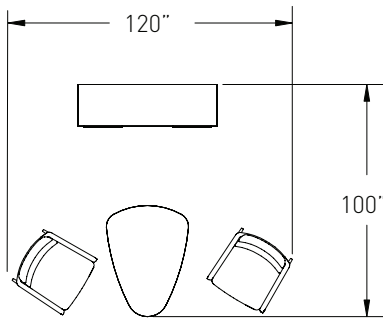

Model	Description	Qty	List Price
1 BU3648-17PKWL	triangular coffee table	1	\$1,447
2 BU7521E	lounge chair - dual textile	2	\$1,625
3 BU1860-34SCD	mid storage	1	\$3,367
<b>Typical List Price</b>			<b>\$8,064</b>

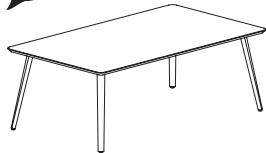
Description	D	W	H	CTN WT	CU FT	① Model	Flat Cut or HPL Laminate Top	Double Cut Top	Solid Surface Top
<b>30" h Rectangular Table with Wood Legs</b> 	48	90	30	210	38	BU4890-30TTWL	\$2,970	\$3,032	\$7,617
	48	90	30	200	35	BU4884-30TTWL	\$2,911	\$2,971	\$7,556
	48	72	30	180	30	BU4872-30TTWL	\$2,693	\$2,754	\$5,185
	42	90	30	191	33	BU4290-30TTWL	\$2,876	\$2,937	\$7,522
	42	84	30	183	31	BU4284-30TTWL	\$2,716	\$2,775	\$7,324
	42	72	30	165	27	BU4272-30TTWL	\$2,544	\$2,604	\$5,013
	36	72	30	151	23	BU3672-30TTWL	\$2,438	\$2,499	\$4,906

- ships KD
- optional accessory hooks (four hooks) available, specify and add \$172 list, see page 183
- EC26 worksurface power available, specify "to accommodate worksurface power" on your purchase order; one EC26 unit must be ordered separately, see page 199
- EC27 under surface power available, see page 199
- knife edge
- maple legs/apron standard
- walnut legs/apron available, specify and add \$486 list; not available on Quickship

BOURNE

<b>30" h Racetrack Table with Wood Legs</b> 	48	90	30	193	38	BU4890-30RTWL	\$2,940	\$3,000	\$7,585
	48	84	30	183	35	BU4884-30RTWL	\$2,877	\$2,938	\$7,523
	48	72	30	163	30	BU4872-30RTWL	\$2,659	\$2,719	\$5,149
	42	90	30	178	33	BU4290-30RTWL	\$2,849	\$2,909	\$7,494
	42	84	30	170	31	BU4284-30RTWL	\$2,687	\$2,749	\$7,294
	42	72	30	152	27	BU4272-30RTWL	\$2,514	\$2,573	\$4,980
	42	60	30	135	23	BU4260-30RTWL	\$2,373	\$2,434	\$4,843

- ships KD
- optional accessory hooks (four hooks) available, specify and add \$172 list, see page 183
- EC26 worksurface power available, specify "to accommodate worksurface power" on your purchase order; one EC26 unit must be ordered separately, see page 199
- EC27 under surface power available, see page 199
- knife edge
- maple legs/apron standard
- walnut legs/apron available, specify and add \$486 list; not available on Quickship

**NOW!**  
Need it.  
JSI Quickship

When ordering Quickship products, place a "Q" in front of model number.  
Example: QBU60-30RDWL

Description	D	W	H	CTN WT	CU FT	Model	Flat Cut or HPL Laminate Top	Double Cut Top	Solid Surface Top
30" Square Table with Wood Legs	60	60	30	185	32	BU6060-30TTWL	\$2,788	\$2,848	\$5,317
	48	48	30	141	21	BU4848-30TTWL	\$2,365	\$2,426	\$4,309
	42	42	30	122	16	BU4242-30TTWL	\$2,262	\$2,323	\$4,207



- ships KD
- optional accessory hooks (four hooks) available, specify and add \$172 list, see page 183
- EC26 worksurface power available, specify "to accommodate worksurface power" on your purchase order; one EC26 unit must be ordered separately, see page 199
- EC27 under surface power available, see page 199
- knife edge
- maple legs/apron standard
- walnut legs/apron available, specify and add \$486 list; not available on Quickship

30" Round Table with Wood Legs	60	60	30	159	32	BU60-30RDWL	\$2,735	\$2,796	\$5,266
--------------------------------	----	----	----	-----	----	-------------	---------	---------	---------



- ships KD
- optional accessory hooks (four hooks) available, specify and add \$172 list, see page 183
- EC26 worksurface power available, specify "to accommodate worksurface power" on your purchase order; one EC26 unit must be ordered separately, see page 199
- EC27 under surface power available, see page 199
- knife edge
- maple legs/apron standard
- walnut legs/apron available, specify and add \$486 list; not available on Quickship

**To Order, Specify:**

- Model Number
- Top Material:
  - Veneer
    - Wood Species - Cherry (CH1), Maple (MA1), Walnut (WA1) or Double Cut (DC1)
  - Finish Color
- Laminate
  - Laminate Color
- Solid Surface - Armadillo (ARM), Pebble Pearl (PEB), or Pure White (PUR)
- Legs/Apron Species:
  - Maple (M)
    - Finish Color - cherry, maple, walnut or paint color on maple legs/apron
  - Walnut (W) - upcharge applies
    - Finish Color - walnut finishes only on walnut legs/apron
- Optional Accessory Hooks - four hooks; specify and add \$172 list, (see page 183)
- Optional Power Units:
  - Work Surface Power; specify with EC26 cut-out. EC26 must be ordered separately, (see page 199)
  - Under Surface Power; mounts under top. EC27 must be ordered separately, (see page 199)

**2a Veneer Top Finish Options:**

Cherry	Maple	Walnut
BRL Barley	ALM Ale Medium	AUB Auburn
BBM Bourbon Medium	BUT Butterscotch	ESP Espresso
BRM Brighton Medium	CIN Cinnamon	MCH Mocha*
CLA Classic	FLX Flax	NTO Night Owl*
CLL Collectors*	VEN Venetian	SIE Sienna*
EAR Earthy		TOF Toffee
HRV Harvest*		TRF Truffle*
LGC Legacy		
PRL Praline*	*finishes with coordinating	
SAF Saffron	laminated top option	

**2b Laminate Top Options:**

Veneer Grain Pattern Laminates			
AGA Aged Ash	CLL Collectors	SAF Saffron	
ALL Ale Light	FLO Florence Walnut	SIE Sienna	
AUB Auburn	GRH Graphite	STU Studio Teak	
BRL Barley	HGL High Line	TOF Toffee	
BLO Blonde Echo	LGC Legacy	TRF Truffle	
BOL Bourbon Light	MCH Mocha	VEN Venetian	
BZW Brazilwood	NTO Night Owl	VIN Vintage	
BGL Brighton Light	OAT Oatmeal Cookie	WLH Walnut Heights	
CIN Cinnamon	PIN Pinnacle Walnut	WEA Weathered Ash	
CLA Classic	PRL Praline		

**Solid Laminates**

ALB Alabaster	SHD Shadow
BBL Bridal Blanco	SLG Slate Grey
DWH Designer White	

**2c Solid Surface Top Options:**

ARM Armadillo	PEB Pebble Pearl
BLP Black Pearl	PUR Pure White

**3a Maple Legs/Apron Finish Options:**

CAG Aged Ash Coordinate	CGR Graphite Coordinate
ALM Ale Medium	HRV Harvest
AUB Auburn	CHL High Line Coordinate
BRL Barley	CKC Khaki Coordinate
CBE Blonde Echo Coordinate	LGC Legacy
BBM Bourbon Medium	MCH Mocha
CBZ Brazilwood Coordinate	NTO Night Owl
BRM Brighton Medium	COA Oatmeal Cookie Coordinate
BUT Butterscotch	CPI Pinnacle Walnut Coordinate
CIN Cinnamon	PRL Praline
CLA Classic	SAF Saffron
CCF Coffee Coordinate	SIE Sienna
CCF Coffee Coordinate	CST Studio Teak Coordinate
CCL Collectors	TOF Toffee
EAR Earthy	TRF Truffle
ESP Espresso	VEN Venetian
FLX Flax	CWI Vintage Coordinate
CFL Florence Walnut Coordinate	CWH Walnut Heights Coordinate
CFO Fossil Coordinate	CWE Weathered Ash Coordinate

**Paint Colors (Maple only)**

BKD Backdrop	GRV Greek Villa
BFX Black Fox	NET Network Gray
BWH Bright White	NWH Nonchalant White
CGP Cargo Pants	STM Storm
CHT Chatroom	TRC Tricorn Black
FRR French Roast	

**3b Walnut Legs/Apron Finish Options:**

AUB Auburn
ESP Espresso
MCH Mocha
NTO Night Owl
SIE Sienna
TOF Toffee
TRF Truffle

Description	D	W	H	CTN WT	CU FT	① Model	Flat Cut or HPL Laminate Top	Double Cut Top	Solid Surface Top
<b>30" h Rectangular Table with Wood/Metal Legs</b> 	48	90	30	222	38	BU4890-30TTML	\$4,980	\$5,041	\$9,627
	48	84	30	212	35	BU4884-30TTML	\$4,877	\$4,937	\$9,522
	48	72	30	192	30	BU4872-30TTML	\$4,616	\$4,677	\$7,110
	42	90	30	203	33	BU4290-30TTML	\$4,825	\$4,885	\$9,470
	42	84	30	195	31	BU4284-30TTML	\$4,624	\$4,683	\$9,230
	42	72	30	177	27	BU4272-30TTML	\$4,409	\$4,471	\$6,877
	36	72	30	162	23	BU3672-30TTML	\$4,270	\$4,329	\$6,738

- ships KD
- metal legs with removable wood surround to access and manage wires
- optional accessory hooks (four hooks) available, specify and add \$172 list, see page 183
- EC26 worksurface power available, specify "to accommodate worksurface power" on your purchase order; one EC26 unit must be ordered separately, see page 199
- EC27 under surface power available, see page 199
- knife edge
- maple legs/apron standard
- walnut legs/apron available, specify and add \$335 list; not available on Quickship

<b>30" h Racetrack Table with Wood/Metal Legs</b> 	48	90	30	205	38	BU4890-30RTML	\$4,798	\$4,858	\$9,444
	48	84	30	195	35	BU4884-30RTML	\$4,685	\$4,745	\$9,330
	48	72	30	175	30	BU4872-30RTML	\$4,405	\$4,465	\$6,898
	42	90	30	190	33	BU4290-30RTML	\$4,674	\$4,734	\$9,319
	42	84	30	182	31	BU4284-30RTML	\$4,465	\$4,526	\$9,073
	42	72	30	164	27	BU4272-30RTML	\$4,231	\$4,291	\$6,699
	42	60	30	147	23	BU4260-30RTML	\$4,020	\$4,080	\$6,488

- ships KD
- metal legs with removable wood surround to access and manage wires
- optional accessory hooks (four hooks) available, specify and add \$172 list, see page 183
- EC26 worksurface power available, specify "to accommodate worksurface power" on your purchase order; one EC26 unit must be ordered separately, see page 199
- EC27 under surface power available, see page 199
- knife edge
- maple legs/apron standard
- walnut legs/apron available, specify and add \$335 list; not available on Quickship

BOURNE

**NOW!**  
Need it.  
JSI Quickship

When ordering Quickship products, place a "Q" in front of model number.  
Example: QBU60-30RDWL



Description	D	W	H	CTN WT	CU FT	Model	Flat Cut or HPL Laminate Top	Double Cut Top	Solid Surface Top
30" Square Table with Wood/Metal Legs	60	60	30	197	32	BU6060-30TTML	\$4,694	\$4,754	\$7,223
	48	48	30	153	21	BU4848-30TTML	\$4,159	\$4,218	\$6,105
	42	42	30	134	16	BU4242-30TTML	\$3,927	\$3,988	\$5,871

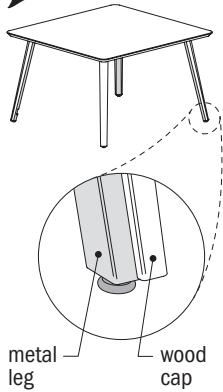

- ships KD
- metal legs with removable wood surround to access and manage wires
- optional accessory hooks (four hooks) available, specify and add \$172 list, see page 183
- EC26 worksurface power available, specify "to accommodate worksurface power" on your purchase order; one EC26 unit must be ordered separately, see page 199
- EC27 under surface power available, see page 199
- knife edge
- maple legs/apron standard
- walnut legs/apron available, specify and add \$335 list; not available on Quickship

30" Round Table with Wood/Metal Legs	60	60	30	170	32	BU60-30RDML	\$4,401	\$4,460	\$6,918
--------------------------------------	----	----	----	-----	----	-------------	---------	---------	---------

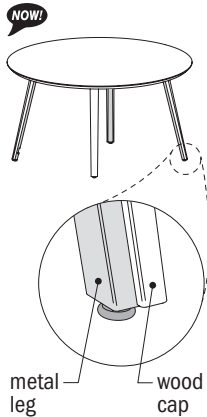

- ships KD
- metal legs with removable wood surround to access and manage wires
- optional accessory hooks (four hooks) available, specify and add \$172 list, see page 183
- EC26 worksurface power available, specify "to accommodate worksurface power" on your purchase order; one EC26 unit must be ordered separately, see page 199
- EC27 under surface power available, see page 199
- knife edge
- maple legs/apron standard
- walnut legs/apron available, specify and add \$335 list; not available on Quickship

**To Order, Specify:**

- Model Number
- Top Material:
  - Veneer
    - Wood Species - Cherry (CH1), Maple (MA1), Walnut (WA1) or Double Cut (DC1)
    - Finish Color
  - Laminate
    - Laminate Color
  - Solid Surface - Armadillo (ARM), Pebble Pearl (PEB), or Pure White (PUR)
- Legs/Apron Species:
  - Maple (M)
    - Finish Color - cherry, maple, walnut or paint color on maple legs/apron
  - Walnut (W) - upcharge applies
    - Finish Color - walnut finishes only on walnut legs/apron
- Metal Leg Color - Arctic Silver (ASL), Matte Black (MBK), Pewter (PEW) or Soft Nickel (SNK)
- Optional Accessory Hooks - four hooks; specify and add \$172 list, (see page 183)
- Optional Power Units:
  - Work Surface Power; specify with EC26 cut-out. EC26 must be ordered separately, (see page 199)
  - Under Surface Power; mounts under top. EC27 must be ordered separately, (see page 199)

**2a Veneer Top Finish Options:**

Cherry	Maple	Walnut
BRL Barley	ALM Ale Medium	AUB Auburn
BBM Bourbon Medium	BUT Butterscotch	ESP Espresso
BRM Brighton Medium	CIN Cinnamon	MCH Mocha
CLA Classic	FLX Flax	NTO Night Owl
CLL Collectors	VEN Venetian	SIE Sienna
EAR Earthy		TOF Toffee
HRV Harvest		TRF Truffle
LGC Legacy		
PRL Praline	*finishes with coordinating laminate top option	
SAF Saffron		

**Double Cut**

COF Coffee	GRH Graphite
CRM Cremello	KHK Khaki
FOS Fossil	STU Studio Teak

**2b Laminate Top Options:**

**Veneer Grain Pattern Laminates**

AGA Aged Ash	CLL Collectors	SAF Saffron
ALL Ale Light	FLO Florence Walnut	SIE Sienna
AUB Auburn	GRH Graphite	STU Studio Teak
BRL Barley	HGL High Line	TOF Toffee
BLO Blonde Echo	LGC Legacy	TRF Truffle
BOL Bourbon Light	MCH Mocha	VEN Venetian
BZW Brazilwood	NTO Night Owl	VIN Vintage
BGL Brighton Light	OAT Oatmeal Cookie	WLH Walnut Heights
CIN Cinnamon	PIN Pinnacle Walnut	WEA Weathered Ash
CLA Classic	PRL Praline	

**Solid Laminates**

ALB Alabaster	SHD Shadow
BBL Bridal Blanco	SLG Slate Grey
DWH Designer White	

**2c Solid Surface Top Options:**

ARM Armadillo	PEB Pebble Pearl
BLP Black Pearl	PUR Pure White

**3a Maple Legs/Apron Finish Options:**

CAG Aged Ash Coordinate	CGR Graphite Coordinate
ALM Ale Medium	HRV Harvest
AUB Auburn	CHL High Line Coordinate
BRL Barley	CKC Khaki Coordinate
CBE Blonde Echo Coordinate	LGC Legacy
BBM Bourbon Medium	MCH Mocha
CBZ Brazilwood Coordinate	NTO Night Owl
BRM Brighton Medium	COA Oatmeal Cookie Coordinate
BUT Butterscotch	CPI Pinnacle Walnut Coordinate
CIN Cinnamon	PRL Praline
CLA Classic	SAF Saffron
CCF Coffee Coordinate	CLA Classic
CCF Coffee Coordinate	SIE Sienna
CCL Collectors	CST Studio Teak Coordinate
EAR Earthy	TOF Toffee
ESP Espresso	TRF Truffle
FLX Flax	VEN Venetian
CFL Florence Walnut Coordinate	CVI Vintage Coordinate
CFO Fossil Coordinate	CWH Walnut Heights Coordinate
	CWE Weathered Ash Coordinate

**Paint Colors (Maple only)**

BKD Backdrop	GRV Greek Villa
BFX Black Fox	NET Network Gray
BWH Bright White	NWH Nonchalant White
CGP Cargo Pants	STM Storm
CHT Chatroom	TRC Tricorn Black
FRR French Roast	

**3b Walnut Legs/Apron Finish Options:**

AUB Auburn
ESP Espresso
MCH Mocha
NTO Night Owl
SIE Sienna
TOF Toffee
TRF Truffle

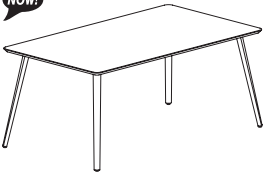
Description	D	W	H	CTN WT	CU FT	① Model	Flat Cut or HPL Laminate Top	Double Cut Top	Solid Surface Top
<b>36" h Rectangular Table with Wood Legs</b> 	48	90	36	202	38	BU4890-36TTWL	\$3,122	\$3,183	\$7,768
	48	84	36	192	35	BU4884-36TTWL	\$3,063	\$3,123	\$7,708
	48	72	36	172	30	BU4872-36TTWL	\$2,844	\$2,905	\$5,337
	42	90	36	184	33	BU4290-36TTWL	\$3,028	\$3,088	\$7,674
	42	84	36	175	31	BU4284-36TTWL	\$2,867	\$2,927	\$7,474
	42	72	36	158	27	BU4272-36TTWL	\$2,694	\$2,755	\$5,164
	36	72	36	143	23	BU3672-36TTWL	\$2,589	\$2,650	\$5,058

- ships KD
- optional accessory hooks (four hooks) available, specify and add \$172 list, see page 183
- EC26 worksurface power available, specify "to accommodate worksurface power" on your purchase order; one EC26 unit must be ordered separately, see page 199
- EC27 under surface power available, see page 199
- knife edge
- maple legs/apron standard
- walnut legs/apron available, specify and add \$577 list; not available on Quickship

BOURNE

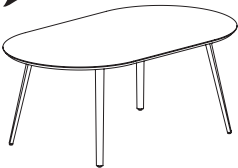
<b>36" h Racetrack Table with Wood Legs</b> 	48	90	36	185	38	BU4890-36RTWL	\$3,091	\$3,152	\$7,737
	48	84	36	175	35	BU4884-36RTWL	\$3,029	\$3,090	\$7,675
	48	72	36	155	30	BU4872-36RTWL	\$2,808	\$2,870	\$5,301
	42	90	36	171	33	BU4290-36RTWL	\$3,000	\$3,061	\$7,646
	42	84	36	162	31	BU4284-36RTWL	\$2,837	\$2,898	\$7,446
	42	72	36	145	27	BU4272-36RTWL	\$2,663	\$2,723	\$5,131
	42	60	36	127	23	BU4260-36RTWL	\$2,525	\$2,586	\$4,995

- ships KD
- optional accessory hooks (four hooks) available, specify and add \$172 list, see page 183
- EC26 worksurface power available, specify "to accommodate worksurface power" on your purchase order; one EC26 unit must be ordered separately, see page 199
- EC27 under surface power available, see page 199
- knife edge
- maple legs/apron standard
- walnut legs/apron available, specify and add \$577 list; not available on Quickship;

**NOW!**  
Need it.  
JSI Quickship

When ordering Quickship products, place a "Q" in front of model number.  
Example: QBU60-30RDWL

Description	D	W	H	CTN WT	CU FT	Model	Flat Cut or HPL Laminate Top	Double Cut Top	Solid Surface Top
36" Square Table with Wood Legs <b>NOW!</b>	60	60	36	177	32	BU6060-36TTWL	\$2,938	\$2,999	\$5,468
	48	48	36	133	21	BU4848-36TTWL	\$2,517	\$2,576	\$4,459
	42	42	36	114	16	BU4242-36TTWL	\$2,413	\$2,473	\$4,358

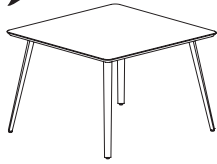

- ships KD
- optional accessory hooks (four hooks) available, specify and add \$172 list, see page 183
- EC26 worksurface power available, specify "to accommodate worksurface power" on your purchase order; one EC26 unit must be ordered separately, see page 199
- EC27 under surface power available, see page 199
- knife edge
- maple legs/apron standard
- walnut legs/apron available, specify and add \$577 list; not available on Quickship

36" Round Table with Wood Legs <b>NOW!</b>	60	60	36	151	32	BU60-36RDWL	\$2,886	\$2,946	\$5,416
---	----	----	----	-----	----	-------------	---------	---------	---------



- ships KD
- optional accessory hooks (four hooks) available, specify and add \$172 list, see page 183
- EC26 worksurface power available, specify "to accommodate worksurface power" on your purchase order; one EC26 unit must be ordered separately, see page 199
- EC27 under surface power available, see page 199
- knife edge
- maple legs/apron standard
- walnut legs/apron available, specify and add \$577 list; not available on Quickship

**To Order, Specify:**

- Model Number
- Top Material:
  - Veneer
    - Wood Species - Cherry (CH1), Maple (MA1), Walnut (WA1) or Double Cut (DC1)
    - Finish Color
  - Laminate
    - Laminate Color
  - Solid Surface - Armadillo (ARM), Pebble Pearl (PEB), or Pure White (PUR)
- Legs/Apron Species:
  - Maple (M)
    - Finish Color - cherry, maple, walnut or paint color on maple legs/apron
  - Walnut (W) - upcharge applies
    - Finish Color - walnut finishes only on walnut legs/apron
- Optional Accessory Hooks - four hooks; specify and add \$172 list, (see page 183)
- Optional Power Units:
  - Work Surface Power; specify with EC26 cut-out. EC26 must be ordered separately, (see page 199)
  - Under Surface Power; mounts under top. EC27 must be ordered separately, (see page 199)

**2a Veneer Top Finish Options:**

Cherry	Maple	Walnut
BRL Barley	ALM Ale Medium	AUB Auburn
BBM Bourbon Medium	BUT Butterscotch	ESP Espresso
BRM Brighton Medium	CIN Cinnamon	MCH Mocha*
CLA Classic	FLX Flax	NTO Night Owl*
CLL Collectors*	VEN Venetian	SIE Sienna*
EAR Earthy		TOF Toffee
HRV Harvest*		TRF Truffle*
LGC Legacy		
PRL Praline*		
SAF Saffron		

\*finishes with coordinating laminate top option

**2b Laminate Top Options:**

Veneer	Grain	Pattern	Laminates
AGA Aged Ash	CLL Collectors	SAF Saffron	
ALL Ale Light	FLO Florence Walnut	SIE Sienna	
AUB Auburn	GRH Graphite	STU Studio Teak	
BRL Barley	HGL High Line	TOF Toffee	
BLO Blonde Echo	LGC Legacy	TRF Truffle	
BOL Bourbon Light	MCH Mocha	VEN Venetian	
BZW Brazilwood	NTO Night Owl	VIN Vintage	
BRM Brighton Light	OAT Oatmeal Cookie	WLH Walnut Heights	
CIN Cinnamon	PIN Pinnacle Walnut	WEA Weathered Ash	
CLA Classic	PRL Praline		

**Solid Laminates**

ALB Alabaster	SHD Shadow
BBL Bridal Blanco	SLG Slate Grey
DWH Designer White	

**2c Solid Surface Top Options:**

ARM Armadillo	PEB Pebble Pearl
BLP Black Pearl	PUR Pure White

**3a Maple Legs/Apron Finish Options:**

CAG Aged Ash Coordinate	CGR Graphite Coordinate
ALM Ale Medium	HRV Harvest
AUB Auburn	CHL High Line Coordinate
BRL Barley	CKC Khaki Coordinate
CBE Blonde Echo Coordinate	LGC Legacy
BBM Bourbon Medium	MCH Mocha
CBZ Brazilwood Coordinate	NTO Night Owl
BRM Brighton Medium	COA Oatmeal Cookie Coordinate
BUT Butterscotch	CPI Pinnacle Walnut Coordinate
CIN Cinnamon	PRL Praline
CLA Classic	SAF Saffron
CCF Coffee Coordinate	SIE Sienna
CCF Coffee Coordinate	CST Studio Teak Coordinate
CCL Collectors	TOF Toffee
EAR Earthy	TRF Truffle
ESP Espresso	VEN Venetian
FLX Flax	CVI Vintage Coordinate
CFL Florence Walnut Coordinate	CWH Walnut Heights Coordinate
CFO Fossil Coordinate	CWE Weathered Ash Coordinate

**Paint Colors (Maple only)**

BKD Backdrop	GRV Greek Villa
BFX Black Fox	NET Network Gray
BWH Bright White	NWH Nonchalant White
CGP Cargo Parts	STM Storm
CHT Chatroom	TRC Tricorn Black
FRR French Roast	

**3b Walnut Legs/Apron Finish Options:**

AUB Auburn
ESP Espresso
MCH Mocha
NTO Night Owl
SIE Sienna
TOF Toffee
TRF Truffle

Description	D	W	H	CTN WT	CU FT	① Model	Flat Cut or HPL Laminate Top	Double Cut Top	Solid Surface Top
<b>36" h Rectangular Table with Wood/Metal Legs</b> 	48	90	36	230	38	BU4890-36TTML	\$5,162	\$5,221	\$9,807
	48	84	36	220	35	BU4884-36TTML	\$5,058	\$5,118	\$9,703
	48	72	36	200	30	BU4872-36TTML	\$4,799	\$4,859	\$7,292
	42	90	36	212	33	BU4290-36TTML	\$5,005	\$5,066	\$9,651
	42	84	36	203	31	BU4284-36TTML	\$4,804	\$4,864	\$9,411
	42	72	36	186	27	BU4272-36TTML	\$4,592	\$4,650	\$7,057
	36	72	36	171	23	BU3672-36TTML	\$4,449	\$4,511	\$6,918

- ships KD
- metal legs with removable wood surround to access and manage wires
- optional accessory hooks (four hooks) available, specify and add \$172 list, see page 183
- EC26 worksurface power available, specify "to accommodate worksurface power" on your purchase order; one EC26 unit must be ordered separately, see page 199
- EC27 under surface power available, see page 199
- knife edge
- maple legs/apron standard
- walnut legs/apron available, specify and add \$426 list; not available on Quickship

<b>36" h Racetrack Table with Wood/Metal Legs</b> 	48	90	36	213	38	BU4890-36RTML	\$4,978	\$5,039	\$9,624
	48	84	36	203	35	BU4884-36RTML	\$4,866	\$4,927	\$9,512
	48	72	36	183	30	BU4872-36RTML	\$4,584	\$4,646	\$7,078
	42	90	36	199	33	BU4290-36RTML	\$4,856	\$4,916	\$9,501
	42	84	36	190	31	BU4284-36RTML	\$4,646	\$4,706	\$9,255
	42	72	36	173	27	BU4272-36RTML	\$4,411	\$4,473	\$6,879
	42	60	36	155	23	BU4260-36RTML	\$4,200	\$4,261	\$6,668

- ships KD
- metal legs with removable wood surround to access and manage wires
- optional accessory hooks (four hooks) available, specify and add \$172 list, see page 183
- EC26 worksurface power available, specify "to accommodate worksurface power" on your purchase order; one EC26 unit must be ordered separately, see page 199
- EC27 under surface power available, see page 199
- knife edge
- maple legs/apron standard
- walnut legs/apron available, specify and add \$426 list; not available on Quickship

BOURNE

**NOW!**  
Need it.  
JSI Quickship

When ordering Quickship products, place a "Q" in front of model number.  
Example: QBU60-30RDWL

Description	D	W	H	CTN WT	CU FT	Model	Flat Cut or HPL Laminate Top	Double Cut Top	Solid Surface Top
36" Square Table with Wood/Metal Legs	60	60	36	205	32	BU6060-36TTML	\$4,875	\$4,935	\$7,404
	48	48	36	161	21	BU4848-36TTML	\$4,340	\$4,401	\$6,285
	42	42	36	142	16	BU4242-36TTML	\$4,109	\$4,168	\$6,052

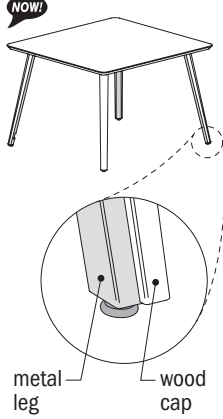

- ships KD
- metal legs with removable wood surround to access and manage wires
- optional accessory hooks (four hooks) available, specify and add \$172 list, see page 183
- EC26 worksurface power available, specify "to accommodate worksurface power" on your purchase order; one EC26 unit must be ordered separately, see page 199
- EC27 under surface power available, see page 199
- knife edge
- maple legs/apron standard
- walnut legs/apron available, specify and add \$426 list; not available on Quickship

36" Round Table with Wood/Metal Legs	60	60	36	179	32	BU60-36RDML	\$4,580	\$4,641	\$7,101
--------------------------------------	----	----	----	-----	----	-------------	---------	---------	---------

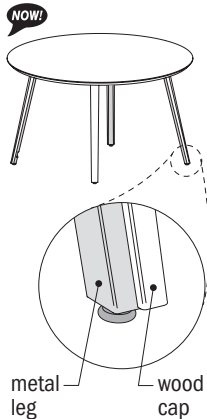

- ships KD
- metal legs with removable wood surround to access and manage wires
- optional accessory hooks (four hooks) available, specify and add \$172 list, see page 183
- EC26 worksurface power available, specify "to accommodate worksurface power" on your purchase order; one EC26 unit must be ordered separately, see page 199
- EC27 under surface power available, see page 199
- knife edge
- maple legs/apron standard
- walnut legs/apron available, specify and add \$426 list; not available on Quickship

**To Order, Specify:**

- Model Number
- Top Material:
  - Veneer
    - Wood Species - Cherry (CH1), Maple (MA1), Walnut (WA1) or Double Cut (DC1)
    - Finish Color
  - Laminate
    - Laminate Color
  - Solid Surface - Armadillo (ARM), Pebble Pearl (PEB), or Pure White (PUR)
- Legs/Apron Species:
  - Maple (M)
    - Finish Color - cherry, maple, walnut or paint color on maple legs/apron
  - Walnut (W) - upcharge applies
    - Finish Color - walnut finishes only on walnut legs/apron
- Metal Leg Color - Arctic Silver (ASL), Matte Black (MBK), Pewter (PEW) or Soft Nickel (SNK)
- Optional Accessory Hooks - four hooks; specify and add \$172 list, (see page 183)
- Optional Power Units:
  - Work Surface Power; specify with EC26 cut-out. EC26 must be ordered separately, (see page 199)
  - Under Surface Power; mounts under top. EC27 must be ordered separately, (see page 199)

**2a Veneer Top Finish Options:**

Cherry	Maple	Walnut
BRL Barley	ALM Ale Medium	AUB Auburn
BBM Bourbon Medium	BUT Butterscotch	ESP Espresso
BRM Brighton Medium	CIN Cinnamon	MCH Mocha*
CLA Classic	FLX Flax	NTO Night Owl*
CLL Collectors*	VEN Venetian	SIE Sienna*
EAR Earthy		TOF Toffee
HRV Harvest*		TRF Truffle*
LGC Legacy		
PRL Praline*	*finishes with coordinating laminate top option	
SAF Saffron		

**2b Laminate Top Options:**

Veneer	Grain	Pattern	Laminates
AGA Aged Ash	CLL Collectors	SAF Saffron	
ALL Ale Light	FLO Florence Walnut	SIE Sienna	
AUB Auburn	GRH Graphite	STU Studio Teak	
BRL Barley	HGL High Line	TOF Toffee	
BLO Blonde Echo	LGC Legacy	TRF Truffle	
BOL Bourbon Light	MCH Mocha	VEN Venetian	
BZW Brazilwood	NTO Night Owl	VIN Vintage	
BGL Brighton Light	OAT Oatmeal Cookie	WLH Walnut Heights	
CIN Cinnamon	PIN Pinnacle Walnut	WEA Weathered Ash	
CLA Classic	PRL Praline		

**Solid Laminates**

ALB Alabaster	SHD Shadow
BBL Bridal Blanco	SLG Slate Grey
DWH Designer White	

**2c Solid Surface Top Options:**

ARM Armadillo	PEB Pebble Pearl
BLP Black Pearl	PUR Pure White

**3a Maple Legs/Apron Finish Options:**

CAG Aged Ash Coordinate	CGR Graphite Coordinate
ALM Ale Medium	HRV Harvest
AUB Auburn	CHL High Line Coordinate
BRL Barley	CKC Khaki Coordinate
CBE Blonde Echo Coordinate	LGC Legacy
BBM Bourbon Medium	MCH Mocha
CBZ Brazilwood Coordinate	NTO Night Owl
BRM Brighton Medium	COA Oatmeal Cookie Coordinate
BUT Butterscotch	CPI Pinnacle Walnut Coordinate
CIN Cinnamon	PRL Praline
CLA Classic	SAF Saffron
CCF Coffee Coordinate	CLA Classic
CCF Coffee Coordinate	CST Studio Teak Coordinate
CCL Collectors	TOF Toffee
EAR Earthy	TRF Truffle
ESP Espresso	VEN Venetian
FLX Flax	CVI Vintage Coordinate
CFL Florence Walnut Coordinate	CWH Walnut Heights Coordinate
CFO Fossil Coordinate	CWE Weathered Ash Coordinate

**Paint Colors (Maple only)**

BKD Backdrop	GRV Greek Villa
BFX Black Fox	NET Network Gray
BWH Bright White	NWH Nonchalant White
CGP Cargo Pants	STM Storm
CHT Chatroom	TRC Tricorn Black
FRR French Roast	

**3b Walnut Legs/Apron Finish Options:**

AUB Auburn
ESP Espresso
MCH Mocha
NTO Night Owl
SIE Sienna
TOF Toffee
TRF Truffle

Description	D	W	H	CTN WT	CU FT	① Model	Flat Cut or HPL Laminate Top	Double Cut Top	Solid Surface Top
40" h Rectangular Table with Wood Legs 	48	90	40	219	38	BU4890-40TTWLH	\$4,153	\$4,212	\$8,798
	48	84	40	209	35	BU4884-40TTWLH	\$4,038	\$4,098	\$8,683
	48	72	40	189	30	BU4872-40TTWLH	\$3,793	\$3,853	\$6,285
	42	90	40	200	33	BU4290-40TTWLH	\$4,068	\$4,128	\$8,713
	42	84	40	192	31	BU4284-40TTWLH	\$3,863	\$3,924	\$8,472
	42	72	40	174	27	BU4272-40TTWLH	\$3,681	\$3,742	\$6,149

- ships KD
- optional accessory hooks (four hooks) available, specify and add \$172 list, see page 183
- EC26 worksurface power available, specify "to accommodate worksurface power" on your purchase order; one EC26 unit must be ordered separately, see page 199
- EC27 under surface power available, see page 199
- metal foot rail
- knife edge
- maple legs/apron standard
- walnut legs/apron available, specify and add \$666 list; not available on Quickship

**NOW!**  
Need it.  
JSI Quickship

When ordering Quickship products, place a "Q" in front of model number.  
Example: QBU60-30RDWL

Description	D	W	H	CTN WT	CU FT	① Model	Flat Cut or HPL Laminate Top	Double Cut Top	Solid Surface Top
40" h Rectangular Table with Wood/Metal Legs <b>NOW!</b>	48	90	40	247	38	BU4890-40TTMLH	\$5,956	\$6,016	\$10,601
	48	84	40	237	35	BU4884-40TTMLH	\$5,811	\$5,871	\$10,457
	48	72	40	217	30	BU4872-40TTMLH	\$5,482	\$5,542	\$7,976
	42	90	40	228	33	BU4290-40TTMLH	\$5,869	\$5,931	\$10,516
	42	84	40	220	31	BU4284-40TTMLH	\$5,607	\$5,667	\$10,215
	42	72	40	202	27	BU4272-40TTMLH	\$5,353	\$5,413	\$7,821

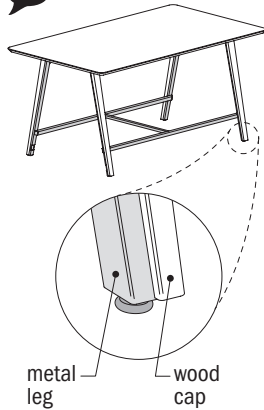

- ships KD
- metal legs with removable wood surround to access and manage wires
- optional accessory hooks (four hooks) available, specify and add \$172 list, see page 183
- EC26 worksurface power available, specify "to accommodate worksurface power" on your purchase order; one EC26 unit must be ordered separately, see page 199
- EC27 under surface power available, see page 199
- metal foot rail, color will be same as the metal leg
- knife edge
- maple legs/apron standard
- walnut legs/apron available, specify and add \$500 list; not available on Quickship

**To Order, Specify:**

- ① Model Number
- ② Top Material:
  - a.) Veneer
    - 1.) Wood Species - Cherry (CH1), Maple (MA1), Walnut (WA1) or Double Cut (DC1)
    - a.) Finish Color
  - b.) Laminate
    - 1.) Laminate Color
  - c.) Solid Surface - Armadillo (ARM), Pebble Pearl (PEB), or Pure White (PUR)
- ③ Legs/Apron Species:
  - a.) Maple (M)
    - 1.) Finish Color - cherry, maple, walnut or paint color on maple legs/apron
  - b.) Walnut (W) - upcharge applies
    - 1.) Finish Color - walnut finishes only on walnut legs/apron
- ④ Metal Leg Color - Arctic Silver (ASL), Matte Black (MBK), Pewter (PEW) or Soft Nickel (SNK)
- ⑤ Optional Accessory Hooks - four hooks; specify and add \$172 list, (see page 183)
- ⑥ Optional Power Units:
  - a.) Work Surface Power; specify with EC26 cut-out. EC26 must be ordered separately, (see page 199)
  - b.) Under Surface Power; mounts under top. EC27 must be ordered separately, (see page 199)

**② Veneer Top Finish Options:**

Cherry		Maple		Walnut	
BRL	Barley	ALM	Ale Medium	AUB	Auburn
BBM	Bourbon Medium	BUT	Butterscotch	ESP	Espresso
BRM	Brighton Medium	CIN	Cinnamon	MCH	Mocha*
CLA	Classic	FLX	Flax	NTO	Night Owl*
CLL	Collectors	VEN	Venetian	SIE	Sienna*
EAR	Earthy			TOF	Toffee
HRV	Harvest			TRF	Truffle*
LGC	Legacy				
PRL	Praline				
SAF	Saffron				

Double Cut		Laminate	
COF	Coffee	GRH	Graphite
CRM	Cremello	KHK	Khaki
FOS	Fossil	STU	Studio Teak

**② Laminate Top Options:**

Veneer Grain Pattern Laminates			
AGA	Aged Ash	CLL	Collectors
ALL	Ale Light	FLO	Florence Walnut
AUB	Auburn	GRH	Graphite
BRL	Barley	HGL	High Line
BLO	Blonde Echo	LGC	Legacy
BOL	Bourbon Light	MCH	Mocha
BZW	Brazilwood	NTO	Night Owl
BGL	Brighton Light	OAT	Oatmeal Cookie
CIN	Cinnamon	PIN	Pinnacle Walnut
CLA	Classic	PRL	Praline

SAF	Saffron	SIE	Sienna
STU	Studio Teak	TOF	Toffee
TRF	Truffle	VEN	Venetian
VIN	Vintage	WLH	Walnut Heights
WEA	Weathered Ash		

**Solid Laminates**

ALB	Alabaster	SHD	Shadow
BBL	Bridal Blanco	SLG	Slate Grey
DWH	Designer White		

**② Solid Surface Top Options:**

ARM	Armadillo	PEB	Pebble Pearl
BLP	Black Pearl	PUR	Pure White

**③ Maple Legs/Apron Finish Options:**

CAG	Aged Ash Coordinate	CGR	Graphite Coordinate
ALM	Ale Medium	HRV	Harvest
AUB	Auburn	CHL	High Line Coordinate
BRL	Barley	CKC	Khaki Coordinate
CBE	Blonde Echo Coordinate	LGC	Legacy
BBM	Bourbon Medium	MCH	Mocha
CBZ	Brazilwood Coordinate	NTO	Night Owl
BRM	Brighton Medium	COA	Oatmeal Cookie Coordinate
BUT	Butterscotch	CPI	Pinnacle Walnut Coordinate
CIN	Cinnamon	PRL	Praline
CLA	Classic	SAF	Saffron
CCF	Coffee Coordinate	CLA	Classic
CCF	Coffee Coordinate	SIE	Sienna
CCL	Collectors	CST	Studio Teak Coordinate
EAR	Earthy	TOF	Toffee
ESP	Espresso	TRF	Truffle
FLX	Flax	VEN	Venetian
CFL	Florence Walnut Coordinate	CVI	Vintage Coordinate
CFO	Fossil Coordinate	CWH	Walnut Heights Coordinate
		CWE	Weathered Ash Coordinate

**Paint Colors (Maple only)**

BKD	Backdrop	GRV	Greek Villa
BFX	Black Fox	NET	Network Gray
BWH	Bright White	NWH	Nonchalant White
CGP	Cargo Pants	STM	Storm
CHT	Chatroom	TRC	Tricorn Black
FRR	French Roast		

**③ Walnut Legs/Apron Finish Options:**

AUB	Auburn
ESP	Espresso
MCH	Mocha
NTO	Night Owl
SIE	Sienna
TOF	Toffee
TRF	Truffle

Description	D	W	H	CTN WT	CU FT	① Model	Flat Cut Top	Double Cut Top
Tall Storage	18	30	42	115	6	BU1830-42STWR	\$2,964	\$3,144
	18	30	42	115	6	BU1830-42STWL	\$2,964	\$3,144

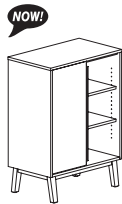

left shown

- hinged door cabinet contains two coat hooks standard
- open cabinet contains two adjustable shelves
- integrated clear anodized aluminum pull
- maple base standard
- walnut base available when walnut chassis is specified, specify and add \$153 list; not available on Quickship
- laminate top not available

Mid Storage	18	60	34	151	11	BU1860-34SCD	\$3,367	\$3,548
-------------	----	----	----	-----	----	--------------	---------	---------



- two drawers
- open center cabinet
- veneer lower shelf
- integrated clear anodized aluminum pulls
- maple base standard
- walnut base available when walnut chassis is specified, specify and add \$244 list; not available on Quickship
- laminate top not available

Low Storage	18	60	24	145	11	BU1860-24SCHD	\$3,222	\$3,403
-------------	----	----	----	-----	----	---------------	---------	---------



- two single hinged door cabinets - both contain one adjustable shelf
- open center cabinet has one adjustable shelf
- integrated clear anodized aluminum pulls
- maple base standard
- walnut base available when walnut chassis is specified, specify and add \$215 list; not available on Quickship
- laminate top not available

BOURNE

**NOW!**  
Need it.  
JSI Quickship

When ordering Quickship products, place a "Q" in front of model number.  
Example: QBUE60-30RDWL



Description	D	W	H	CTN WT	CU FT	1 Model	List Price
Worksurface Power	2 7/8	6 3/8	3	3	1	EC26	\$606

**NOW!**

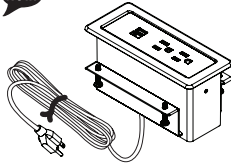

- two power receptacles - 120 volt; 15 amp dual powered USB
- 120" power cord with molded plug
- White (W) or Black (B) finish available, specify when ordering
- UL recognized
- meets UL spill requirements

Under Surface Power	3	6 1/2	1 13/16	2	1	EC27	\$577
---------------------	---	-------	---------	---	---	------	-------

**NOW!**

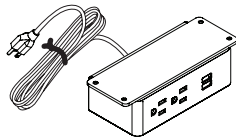

- two power receptacles - 120 volt; 15 amp dual powered USB
- 120" power cord with molded plug
- White (W) or Black (B) finish available, specify when ordering
- UL recognized

BOURNE

**To Order, Specify:**

- 1 Model Number
- 2 Chassis Species - Cherry (CH1), Maple (MA1), Walnut (WA1) or Double Cut (DC1)
- 3 Base Species:
  - a.) Maple (M) - standard (finish same as chassis)
  - b.) Walnut (W) - upcharge applies; only available when walnut chassis is specified (finish same as chassis)
- 4 Chassis/Base Finish:
  - a.) Finish Color - cherry, maple, walnut, or double cut
- 5 Door Finish
  - a.) Wood Finish - same as chassis
  - b.) Paint Color

**4a Chassis Finish Options:**

Cherry		Maple		Walnut	
BRL	Barley	ALM	Ale Medium	AUB	Auburn
BBM	Bourbon Medium	BUT	Butterscotch	ESP	Espresso
BRM	Brighton Medium	CIN	Cinnamon	MCH	Mocha
CLA	Classic	FLX	Flax	NTO	Night Owl
CLL	Collectors	VEN	Venetian	SIE	Sienna
EAR	Earthy	TOF	Toffee		
HRV	Harvest	TRF	Truffle		
LGC	Legacy				
PRL	Praline				
SAF	Saffron				
<b>Double Cut</b>					
COF	Coffee				
CRM	Cremello				
FOS	Fossil				
GRH	Graphite				
KHK	Khaki				
STU	Studio Teak				

**5b Door Paint Color Options:**

BKD	Backdrop	GRV	Greek Villa
BFX	Black Fox	NET	Network Gray
BWH	Bright White	NWH	Nonchalant White
CGP	Cargo Pants	STM	Storm
CHT	Chatroom	TRC	Tricorn Black
FRR	French Roast		



# Bravado Conference Product Information



BRAVADO

## Bravado Conference Product Information

### Exterior Wood Materials

Exterior surfaces are made from the finest selected veneers to achieve clarity and consistency in the Bravado product line. To attain a pleasing, symmetrical pattern, all cherry, maple and walnut veneers are book-matched. All exterior solid lumber is matched to coordinate with the veneer.

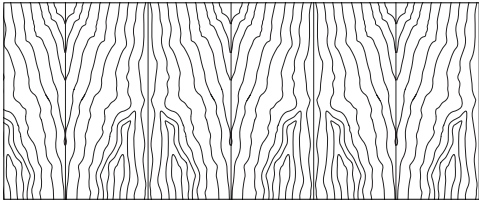

#### Book-Matched Example

Alternating pieces of veneer are flipped over so they face each other like the pages within a book.

Bravado is available in flat cut cherry, maple and walnut veneer. A wide range of wood stains have been formulated to enhance the beauty of the veneer.

Double Cut veneer is another choice on Bravado product. This veneer is a processed product that has at least two cuttings to create the final veneers. These cuts of veneer strands are dyed and layered into a block to create variation of patterns from a very tight grain pattern to an exotic figure grain pattern. The diagram below shows the tight pattern used on Bravado. Use appropriate pricing column when specifying Double Cut veneer.

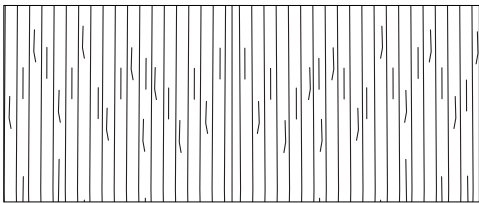

### Conference Top Construction

Cherry, Maple, Walnut Flat Cut Veneer

Table tops are 1 3/16" thick, 3-ply construction with matching external lumber edgeband on all sides and reverse bevel profile. Grain runs side to side (short grain).

Double Cut Veneer

Table tops are 1 3/16" thick, 3-ply construction with matching veneer edgeband on all sides and reverse bevel profile. Grain runs side to side (short grain).

Optional metal inlay is 1/8" wide and has a minimal (3/32") rise above the top surface.

### Conference Base and Stretcher Construction

Table bases feature 3/4" thick 3-ply panels and an aluminum extrusion corner detail. Bases are constructed using mortise and tenon joinery, along with wood cleats and screws. Each base includes adjustable leveling glides. Stretcher panels between bases provide additional support. Stretcher are 1 3/16" thick hardwood.

### Credenza and Media Unit Construction

Tops and chassis components are 3/4" thick 3-ply construction. Panels are joined together using mortise and tenon construction reinforced with wood cleats, metal brackets and screws. Cabinet legs are metal and have adjustable leveling glides. Credenza and media cabinet doors have 110 degree hinges to allow adequate access into the interior of the cabinet. Media wall mounted cabinets use piano-style hinges to allow door to swing open fully.

### Drawers

Drawer sides and backs are solid lumber beech 7/16" thick. Drawer fronts are 3-ply construction, 3/4" thick. Drawer bottoms are of 3-ply hardwood construction. Drawers are assembled with dovetail construction in all four corners of the drawer box. Fronts are securely mounted onto the drawer box. Drawer pulls are standard on pedestals. There are two finish options available Matte Black and Anodized Aluminum.

### Drawer Suspension

High quality black drawer suspension carries a lifetime warranty. File and box drawers have 100% full extension with over travel. Slides feature steel ball bearings for longer wear and positive, cushioned in/out stops.

### Locking

Units are shipped randomly keyed as standard. Key alike units are available upon request for no additional charges. Removable cores for in-field re-keying are standard.

## Bravado Conference Product Information

### Finish - Stain/Colors

We offer a variety of wood stains on Bravado. Please see the chart below. Samples are available upon request.

#### CH1 Cherry *Flat Cut Veneer*

BRL Barley	EAR Earthy
BBM Bourbon Medium	HRV Harvest
BRM Brighton Medium	LGC Legacy
CLA Classic	PRL Praline
CLL Collectors	SAF Saffron

#### MA1 Maple *Flat Cut Veneer*

ALM Ale Medium	FLX Flax
BUT Butterscotch	VEN Venetian
CIN Cinnamon	

#### WA1 Walnut *Flat Cut Veneer*

AUB Auburn	SIE Sienna
ESP Espresso	TOF Toffee
MCH Mocha	TRF Truffle
NTO Night Owl	

#### DC1 Double Cut Veneer

COF Coffee	GRH Graphite
CRM Cremello	KHK Khaki
FOS Fossil	STU Studio Teak

### Protective Top Coat

DuraTex™ offers exceptional hardness along with abrasion and impact resistance, it has been formulated to eliminate hazardous and harmful gases that are normally associated with wood finish.

### DuraTex™ Features

**Safety** - Significantly reduces hazardous formaldehyde emissions which help improve the quality of the indoor air we breathe. **Quality** - Developed to be tough and durable with special attention to appearance. The DuraTex™ finish preserves the natural beauty of wood. **Durability** - Designed to meet a wide range of demanding performance and environmental standards to withstand even the highest wear and tear.

### Product Modifications

#### Special Finishes

Special finishes can be requested by following the instruction in the general introduction section, page 5. There is a one time charge of \$332 list per order.

#### Species Change

For species changes contact customer service for a quote.

# Bravado Conference Product Information

## Edge Profile

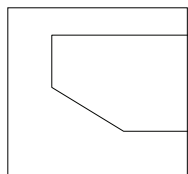

**Reverse Bevel**

## Pull Style

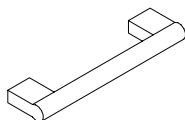

**Bravado Pull**

Anodized Aluminum (AAL)  
Matte Black (MBK)

## Conference Top Shapes and Sizes | Grain Direction

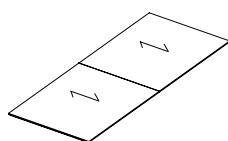

### rectangular panel bases

288" x 54"	6 bases	seats 24
264" x 54"	6 bases	seats 22
240" x 54"	5 bases	seats 20
216" x 54"	5 bases	seats 18
192" x 54"	4 bases	seats 16

288" x 48"	6 bases	seats 24
264" x 48"	6 bases	seats 22
240" x 48"	5 bases	seats 20
216" x 48"	5 bases	seats 18
192" x 48"	4 bases	seats 16
168" x 48"	4 bases	seats 14
144" x 48"	3 bases	seats 12
120" x 48"	3 bases	seats 10
96" x 48"	2 bases	seats 8

### square bases

288" x 54"	5 bases	seats 24
264" x 54"	4 bases	seats 22
240" x 54"	4 bases	seats 20
216" x 54"	4 bases	seats 18
192" x 54"	3 bases	seats 16

288" x 48"	5 bases	seats 24
264" x 48"	5 bases	seats 22
240" x 48"	4 bases	seats 20
216" x 48"	4 bases	seats 18
192" x 48"	4 bases	seats 16
168" x 48"	3 bases	seats 14
144" x 48"	3 bases	seats 12
120" x 48"	2 bases	seats 10
96" x 48"	2 bases	seats 8

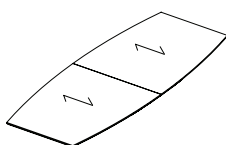

### boat panel bases

288" x 54"	6 bases	seats 24
264" x 54"	6 bases	seats 22
240" x 54"	5 bases	seats 20
216" x 54"	5 bases	seats 18
192" x 54"	4 bases	seats 16

288" x 48"	6 bases	seats 24
264" x 48"	6 bases	seats 22
240" x 48"	5 bases	seats 20
216" x 48"	5 bases	seats 18
192" x 48"	4 bases	seats 16
168" x 48"	4 bases	seats 14
144" x 48"	3 bases	seats 12
120" x 48"	3 bases	seats 10
96" x 48"	2 bases	seats 8

### square bases

288" x 54"	5 bases	seats 24
264" x 54"	4 bases	seats 22
240" x 54"	4 bases	seats 20
216" x 54"	4 bases	seats 18
192" x 54"	3 bases	seats 16

288" x 48"	5 bases	seats 24
264" x 48"	5 bases	seats 22
240" x 48"	4 bases	seats 20
216" x 48"	4 bases	seats 18
192" x 48"	4 bases	seats 16
168" x 48"	3 bases	seats 14
144" x 48"	3 bases	seats 12
120" x 48"	2 bases	seats 10
96" x 48"	2 bases	seats 8

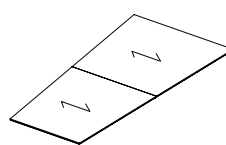

### view panel bases

240" x 84"	5 bases	seats 19-21
216" x 78"	5 bases	seats 17-19
192" x 72"	4 bases	seats 15-17
168" x 66"	4 bases	seats 13-15
144" x 60"	3 bases	seats 11-13
120" x 60"	3 bases	seats 9-11
96" x 54"	2 bases	seats 7-9
72" x 48"	2 bases	seats 5-7

### square bases

240" x 84"	4 bases	seats 19-21
216" x 78"	4 bases	seats 17-19
192" x 72"	3 bases	seats 15-17
168" x 66"	3 bases	seats 13-15
144" x 60"	3 bases	seats 11-13
120" x 60"	2 bases	seats 9-11
96" x 54"	2 bases	seats 7-9

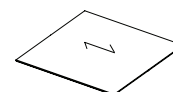

### square\*

60" sq.	seats 8
54" sq.	seats 6
48" sq.	seats 4
42" sq.	seats 4

\*requires 1 base

BRAVADO

## Optional Metal Inlay

Bravado offers an optional 1/8" w metal inlay available in Arctic Silver (ASL) or Matte Black (MBK), see models for pricing.

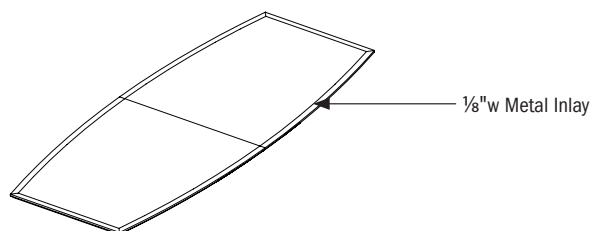

## Bravado Conference Product Information

### Bases

Panel bases are 7" wide in 18", 24" and 30" depths. Square bases are available in 18", 24" and 30" sizes. All are 28 1/4" high.

Metal trim on all base corners must be specified in either Arctic Silver (ASL) or Matte Black (MBK).

Leveling glides are set into hardwood blocks, which helps to prevent the leveling glide from tear outs.

Access cut-out is 1 7/8" x 3 1/4".

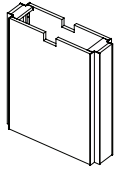

**Panel Base**

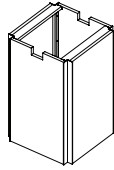

**Square Base**

### Access Door

Bases can be specified with an optional access door; add \$249 list per base. Option must be specified when placing order. For View tables indicate which base or bases (A-E) are to have the access door on your order. See below diagram(s).

Note: Access door is non-handed.

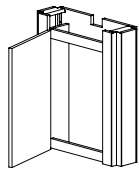

**Panel Base with Access Door**

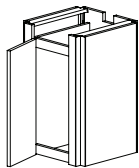
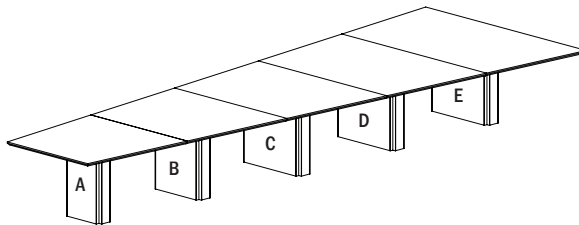

**Square Base with Access Door**

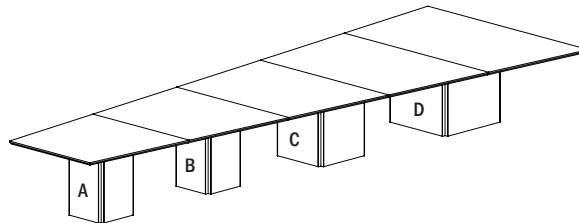

## Bravado Conference Product Information

### Finish and Reference Codes - Summary

<b>Select</b>	<b>Code</b>
<b>Veneer/Substrate</b>	
Cherry	CH1
Maple	MA1
Walnut	WA1
Double Cut	DC1
<b>Finish</b>	
Cherry Finishes	
Barley	BRL
Bourbon Medium	BBM
Brighton Medium	BRM
Classic	CLA
Collectors	CLL
Earthy	EAR
Harvest	HRV
Legacy	LGC
Praline	PRL
Saffron	SAF
Maples Finishes	
Ale Medium	ALM
Butterscotch	BUT
Cinnamon	CIN
Flax	FLX
Venetian	VEN
Walnut Finishes	
Auburn	AUB
Espresso	ESP
Mocha	MCH
Night Owl	NTO
Sienna	SIE
Toffee	TOF
Truffle	TRF
Double Cut Finishes	
Coffee	COF
Cremello	CRM
Fossil	FOS
Graphite	GRH
Khaki	KHK
Studio Teak	STU
<b>Metal Colors</b>	
Arctic Silver	ASL
Matte Black	MBK
<b>Pull Colors</b>	
Anodized Aluminum	AAL
Matte Black	MBK



## Bravado Conference Product Information

### BV001

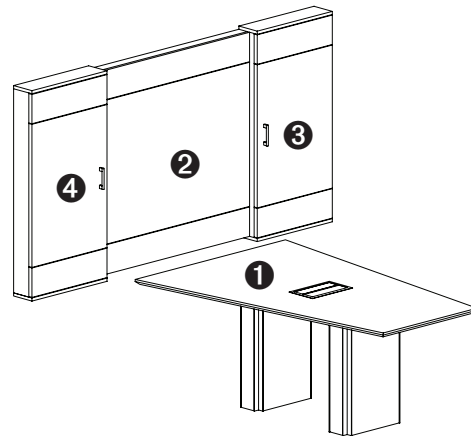
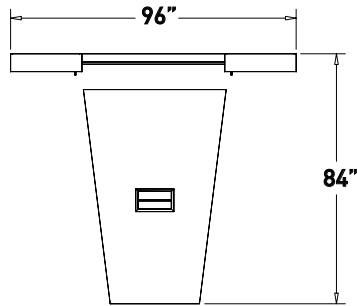

Model	Description	Qty	Price
1 BV4872VT-2PB	view table with panel bases	1	\$5,163
2 BV4802-50CDW	center wall panel	1	\$2,010
3 BV2406-50MWR	24"w media wall cabinet, right	1	\$2,789
4 BV2406-50MWL	24"w media wall cabinet, left	1	\$2,789
EC13	dual power and data tilt up unit	1	\$1,130
<b>Typical List Price</b>			<b>\$13,881</b>

### BV002

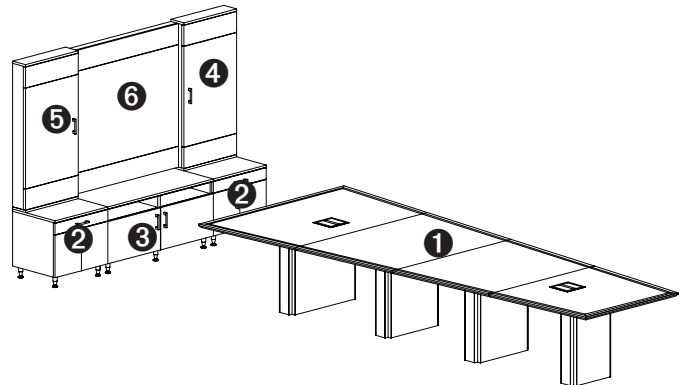
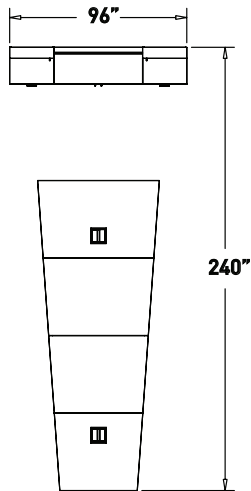

Model	Description	Qty	Price
1 BV66168VT-4PB	view table with panel bases and metal inlay	1	\$12,799
2 BV2024-24SC	24"h media cabinet	2	\$5,338
3 BV2048-24MCCS	24"h media cabinet	1	\$3,726
4 BV2406-50MWR	24"w media wall cabinet, right	1	\$2,789
5 BV2406-50MWL	24"w media wall cabinet, left	1	\$2,789
6 BV4802-50CDW	center wall panel	1	\$2,010
EC13	dual power and data tilt up unit	2	\$2,260
<b>Typical List Price</b>			<b>\$31,711</b>

## Bravado Conference Product Information

### BV003

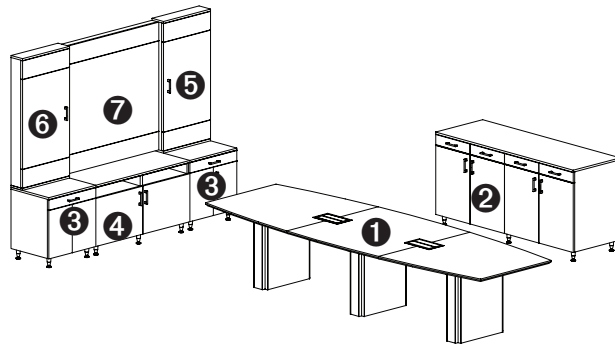
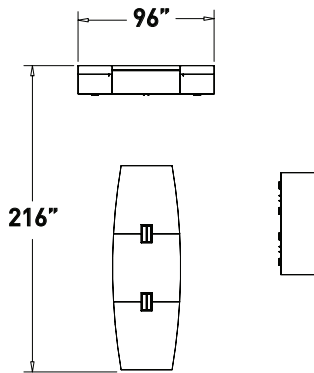

Model	Description	Qty	Price
1 BV48144BT-3PB	boat shape table with panel bases	1	\$7,521
2 BV2472-36BSC	buffet credenza	1	\$5,881
3 BV2024-28SC	28"h media cabinet	2	\$5,278
4 BV2048-28MCCS	28"h media cabinet	1	\$3,718
5 BV2406-50MWR	24"w media wall cabinet, right	1	\$2,789
6 BV2406-50MWL	24"w media wall cabinet, left	1	\$2,789
7 BV4802-50CDW	center wall panel	1	\$2,010
EC13	dual power and data tilt up unit	2	\$2,260
<b>Typical List Price</b>			<b>\$32,246</b>

### BV004

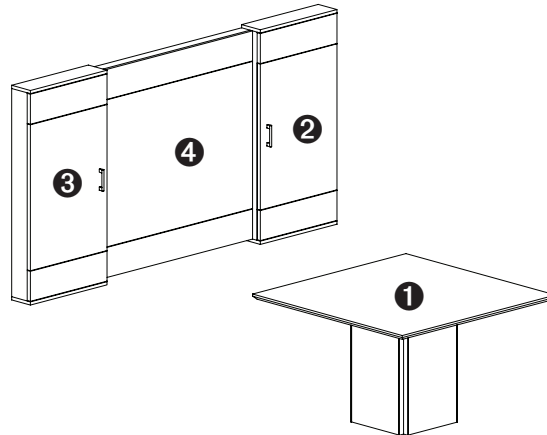
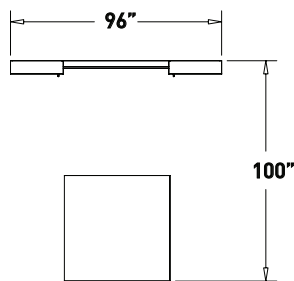

Model	Description	Qty	Price
1 BV4848TT-1SB	square conference table	1	\$4,142
2 BV2406-50MWR	24"w media wall cabinet, right	1	\$2,789
3 BV2406-50MWL	24"w media wall cabinet, left	1	\$2,789
4 BV4802-50CDW	center wall panel	1	\$2,010
<b>Typical List Price</b>			<b>\$11,730</b>

## Bravado Conference Product Information

### BV005

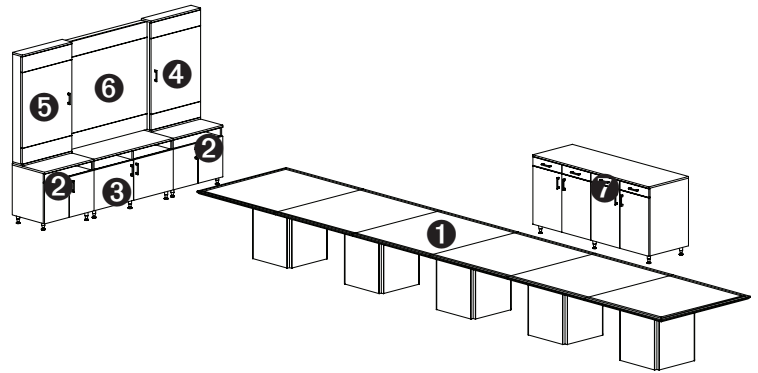
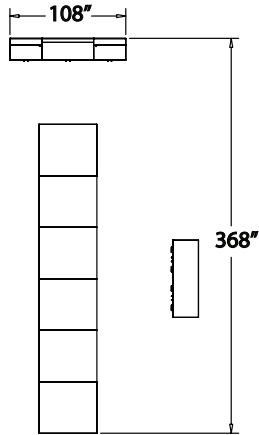

Model	Description	Qty	Price
1 BV54288TT-5SB	rectangular table with square bases and metal inlay	1	\$22,766
2 BV2030-28MC	28"h media cabinet	2	\$5,146
3 BV2048-28MCCS	28"h media cabinet	1	\$3,718
4 BV3006-50MWR	30"w media wall cabinet, right	1	\$2,890
5 BV3006-50MWL	30"w media wall cabinet, left	1	\$2,890
6 BV4802-50CDW	center wall panel	1	\$2,010
7 BV2472-36BSC	buffet credenza	1	\$5,881
<b>Typical List Price</b>			<b>\$45,301</b>

### BV006

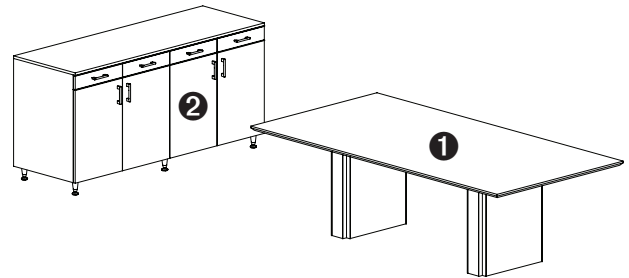
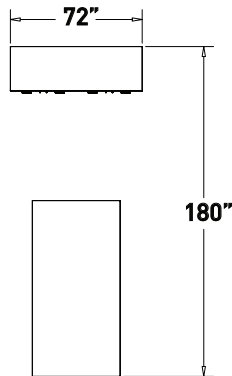

Model	Description	Qty	Price
1 BV4896TT-2PB	rectangular table with panel bases	1	\$5,688
2 BV2472-36BSC	buffet credenza	1	\$5,881
<b>Typical List Price</b>			<b>\$11,569</b>

Description	D	W	H	CTN WT	CU FT	Model	Flat Cut List Price	Double Cut List Price
Rectangular Table with Panel Bases	54	288	30	920	78	BV54288TT-6PB	\$19,895	\$21,884

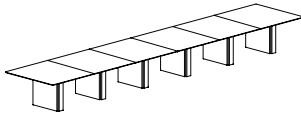

- six piece top
- six panel bases
- bases; 6-30"d x 7"w
- 42" between bases, 18" at ends
- metal inlay available - specify and add \$3,584 list, see page 204
- access door available, specify and add \$249 list per base; see page 205

Rectangular Table with Panel Bases	54	264	30	866	72	BV54264TT-6PB	\$18,999	\$20,899
------------------------------------	----	-----	----	-----	----	---------------	----------	----------

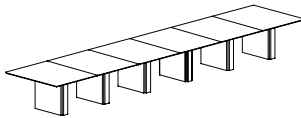

- six piece top
- six panel bases
- bases; 6-30"d x 7"w
- 37 3/16" between bases, 18" at ends
- metal inlay available - specify and add \$3,423 list, see page 204
- access door available, specify and add \$249 list per base; see page 205

Rectangular Table with Panel Bases	54	240	30	767	65	BV54240TT-5PB	\$16,581	\$18,239
------------------------------------	----	-----	----	-----	----	---------------	----------	----------

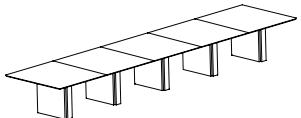

- five piece top
- five panel bases
- bases; 5-30"d x 7"w
- 42 1/4" between bases, 18" at ends
- metal inlay available - specify and add \$2,987 list, see page 204
- access door available, specify and add \$249 list per base; see page 205

Rectangular Table with Panel Bases	54	216	30	713	60	BV54216TT-5PB	\$14,304	\$15,734
------------------------------------	----	-----	----	-----	----	---------------	----------	----------

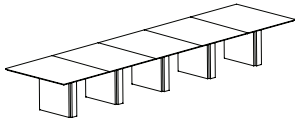

- five piece top
- five panel bases
- bases; 5-30"d x 7"w
- 36 1/4" between bases, 18" at ends
- metal inlay available - specify and add \$2,577 list, see page 204
- access door available, specify and add \$249 list per base; see page 205

Rectangular Table with Panel Bases	54	192	30	614	52	BV54192TT-4PB	\$12,311	\$13,542
------------------------------------	----	-----	----	-----	----	---------------	----------	----------

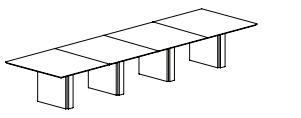

- four piece top
- four panel bases
- bases; 4-30"d x 7"w
- 42 1/16" between bases, 18" at ends
- metal inlay available - specify and add \$2,218 list, see page 204
- access door available, specify and add \$249 list per base; see page 205

BRAVADO

Description	D	W	H	CTN WT	CU FT	① Model	Flat Cut List Price	Double Cut List Price
Rectangular Table with Panel Bases	48	288	30	828	66	BV48288TT-6PB	\$17,793	\$19,574

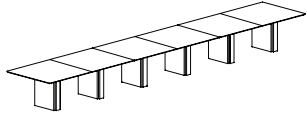

- six piece top
- six panel bases
- bases; 6-24" d x 7" w
- 42" between bases, 18" at ends
- metal inlay available - specify and add \$3,203 list, see page 204
- access door available, specify and add \$249 list per base; see page 205

Rectangular Table with Panel Bases	48	264	30	778	66	BV48264TT-6PB	\$16,988	\$18,688
------------------------------------	----	-----	----	-----	----	---------------	----------	----------

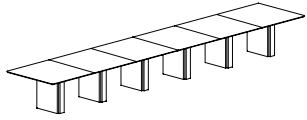

- six piece top
- six panel bases
- bases; 6-24" d x 7" w
- 37 3/16" between bases, 18" at ends
- metal inlay available - specify and add \$3,060 list, see page 204
- access door available, specify and add \$249 list per base; see page 205

Rectangular Table with Panel Bases	48	240	30	690	55	BV48240TT-5PB	\$14,202	\$15,622
------------------------------------	----	-----	----	-----	----	---------------	----------	----------

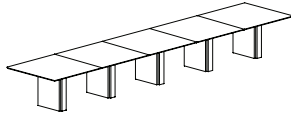

- five piece top
- five panel bases
- bases; 5-24" d x 7" w
- 42 1/4" between bases, 18" at ends
- metal inlay available - specify and add \$2,560 list, see page 204
- access door available, specify and add \$249 list per base; see page 205

**To Order, Specify:**

- ① Model Number
- ② Wood Species - Cherry (CH1), Maple (MA1) or Walnut (WA1) or Double Cut (DC1) (see page 206)
- ③ Finish Color (see page 206)
- ④ Metal Color (see page 206)
- ⑤ Power and Data Options (see pages 519-535)
- ⑥ Other Product Options

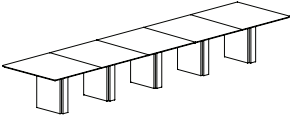
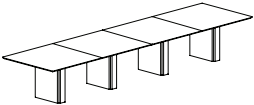
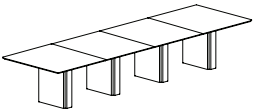
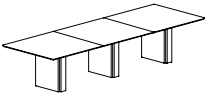
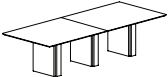
Description	D	W	H	CTN WT	CU FT	Model	Flat Cut List Price	Double Cut List Price
<b>Rectangular Table with Panel Bases</b>  <ul style="list-style-type: none"> <li>· five piece top</li> <li>· five panel bases</li> <li>· bases; 5-24"d x 7"w</li> <li>· 36 1/4" between bases, 18" at ends</li> <li>· metal inlay available - specify and add \$2,200 list, see page 204</li> <li>· access door available, specify and add \$249 list per base; see page 205</li> </ul>	48	216	30	640	55	<b>BV48216TT-5PB</b>	\$12,208	\$13,430
<b>Rectangular Table with Panel Bases</b>  <ul style="list-style-type: none"> <li>· four piece top</li> <li>· four panel bases</li> <li>· bases; 4-24"d x 7"w</li> <li>· 42 1/4" between bases, 18" at ends</li> <li>· metal inlay available - specify and add \$1,869 list, see page 204</li> <li>· access door available, specify and add \$249 list per base; see page 205</li> </ul>	48	192	30	552	44	<b>BV48192TT-4PB</b>	\$10,370	\$11,406
<b>Rectangular Table with Panel Bases</b>  <ul style="list-style-type: none"> <li>· four piece top</li> <li>· four panel bases</li> <li>· bases; 4-24"d x 7"w</li> <li>· 34 1/4" between bases, 18" at ends</li> <li>· metal inlay available - specify and add \$1,744 list, see page 204</li> <li>· access door available, specify and add \$249 list per base; see page 205</li> </ul>	48	168	30	502	44	<b>BV48168TT-4PB</b>	\$9,672	\$10,639
<b>Rectangular Table with Panel Bases</b>  <ul style="list-style-type: none"> <li>· three piece top</li> <li>· three panel bases</li> <li>· bases; 3-24"d x 7"w</li> <li>· 43 1/2" between bases, 18" at ends</li> <li>· metal inlay available - specify and add \$1,348 list, see page 204</li> <li>· access door available, specify and add \$249 list per base; see page 205</li> </ul>	48	144	30	414	33	<b>BV48144TT-3PB</b>	\$7,474	\$8,223
<b>Rectangular Table with Panel Bases</b>  <ul style="list-style-type: none"> <li>· two piece top</li> <li>· three panel bases</li> <li>· bases; 3-24"d x 7"w</li> <li>· 31 1/2" between bases, 18" at ends</li> <li>· metal inlay available - specify and add \$1,194 list, see page 204</li> <li>· access door available, specify and add \$249 list per base; see page 205</li> </ul>	48	120	30	364	31	<b>BV48120TT-3PB</b>	\$6,614	\$7,278

Description	D	W	H	CTN WT	CU FT	① Model	Flat Cut List Price	Double Cut List Price
Rectangular Table with Panel Bases	48	96	30	260	22	BV4896TT-2PB	\$5,688	\$6,258

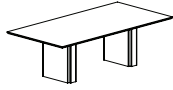

- one piece top
- two panel bases
- bases; 2-24"d x 7"w
- 46" between bases, 18" at ends
- metal inlay available - specify and add \$1,027 list, see page 204
- access door available, specify and add \$249 list per base; see page 205

**To Order, Specify:**

- ① Model Number
- ② Wood Species - Cherry (CH1), Maple (MA1) or Walnut (WA1) or Double Cut (DC1) (see page 206)
- ③ Finish Color (see page 206)
- ④ Metal Color (see page 206)
- ⑤ Power and Data Options (see pages 519-535)
- ⑥ Other Product Options

Description	D	W	H	CTN WT	CU FT	Model	Flat Cut List Price	Double Cut List Price
-------------	---	---	---	--------	-------	-------	---------------------	-----------------------

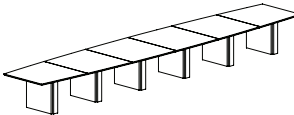
<b>Boat Shape Table with Panel Bases</b>  <ul style="list-style-type: none"> <li>· six piece top</li> <li>· tapers to 42" on ends</li> <li>· six panel bases</li> <li>· bases; 6-30"d x 7"w</li> <li>· 42" between bases, 18" at ends</li> <li>· metal inlay available - specify and add \$3,570 list, see page 204</li> <li>· access door available, specify and add \$249 list per base; see page 205</li> </ul>	54	288	30	856	78	<b>BV54288BT-6PB</b>	\$19,817	\$21,798
---	----	-----	----	-----	----	----------------------	----------	----------

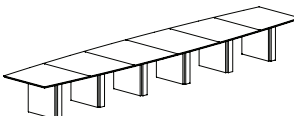
<b>Boat Shape Table with Panel Bases</b>  <ul style="list-style-type: none"> <li>· six piece top</li> <li>· tapers to 42" on ends</li> <li>· six panel bases</li> <li>· bases; 6-30"d x 7"w</li> <li>· 37<sup>3</sup>/<sub>16</sub>" between bases, 18" at ends</li> <li>· metal inlay available - specify and add \$3,408 list, see page 204</li> <li>· access door available, specify and add \$249 list per base; see page 205</li> </ul>	54	264	30	806	72	<b>BV54264BT-6PB</b>	\$18,917	\$20,810
---	----	-----	----	-----	----	----------------------	----------	----------

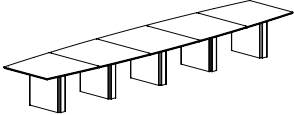
<b>Boat Shape Table with Panel Bases</b>  <ul style="list-style-type: none"> <li>· five piece top</li> <li>· tapers to 42" on ends</li> <li>· five panel bases</li> <li>· bases; 5-30"d x 7"w</li> <li>· 42 1/4" between bases, 18" at ends</li> <li>· metal inlay available - specify and add \$2,978 list, see page 204</li> <li>· access door available, specify and add \$249 list per base; see page 205</li> </ul>	54	240	30	711	65	<b>BV54240BT-5PB</b>	\$16,531	\$18,183
---	----	-----	----	-----	----	----------------------	----------	----------

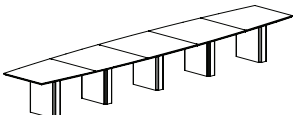
<b>Boat Shape Table with Panel Bases</b>  <ul style="list-style-type: none"> <li>· five piece top</li> <li>· tapers to 42" on ends</li> <li>· five panel bases</li> <li>· bases; 5-30"d x 7"w</li> <li>· 36 1/4" between bases, 18" at ends</li> <li>· metal inlay available - specify and add \$2,608 list, see page 204</li> <li>· access door available, specify and add \$249 list per base; see page 205</li> </ul>	54	216	30	586	60	<b>BV54216BT-5PB</b>	\$14,476	\$15,925
---	----	-----	----	-----	----	----------------------	----------	----------

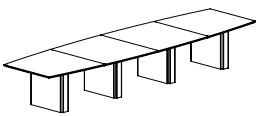
<b>Boat Shape Table with Panel Bases</b>  <ul style="list-style-type: none"> <li>· four piece top</li> <li>· tapers to 42" on ends</li> <li>· four panel bases</li> <li>· bases; 4-30"d x 7"w</li> <li>· 42 1/16" between bases, 18" at ends</li> <li>· metal inlay available - specify and add \$2,211 list, see page 204</li> <li>· access door available, specify and add \$249 list per base; see page 205</li> </ul>	54	192	30	566	52	<b>BV54192BT-4PB</b>	\$12,263	\$13,491
--	----	-----	----	-----	----	----------------------	----------	----------

BRAVADO

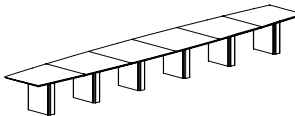

Description	D	W	H	CTN WT	CU FT	① Model	Flat Cut List Price	Double Cut List Price
-------------	---	---	---	-----------	----------	---------	------------------------	--------------------------

<b>Boat Shape Table with Panel Bases</b>  <ul style="list-style-type: none"> <li>· six piece top</li> <li>· tapers to 36" on ends</li> <li>· six panel bases</li> <li>· bases; 6-24"d x 7"w</li> <li>· 42" between bases, 18" at ends</li> <li>· metal inlay available - specify and add \$3,203 list, see page 204</li> <li>· access door available, specify and add \$249 list per base; see page 205</li> </ul>	48	288	30	764	66	<b>BV48288BT-6PB</b>	\$17,778	\$19,556
--	----	-----	----	-----	----	----------------------	----------	----------

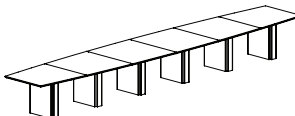
<b>Boat Shape Table with Panel Bases</b>  <ul style="list-style-type: none"> <li>· six piece top</li> <li>· tapers to 36" on ends</li> <li>· six panel bases</li> <li>· bases; 6-24"d x 7"w</li> <li>· 37 3/16" between bases, 18" at ends</li> <li>· metal inlay available - specify and add \$3,059 list, see page 204</li> <li>· access door available, specify and add \$249 list per base; see page 205</li> </ul>	48	264	30	718	66	<b>BV48264BT-6PB</b>	\$16,978	\$18,675
---	----	-----	----	-----	----	----------------------	----------	----------

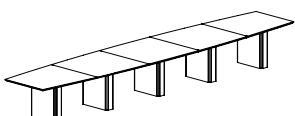
<b>Boat Shape Table with Panel Bases</b>  <ul style="list-style-type: none"> <li>· five piece top</li> <li>· tapers to 36" on ends</li> <li>· five panel bases</li> <li>· bases; 5-24"d x 7"w</li> <li>· 42 1/4" between bases, 18" at ends</li> <li>· metal inlay available - specify and add \$2,561 list, see page 204</li> <li>· access door available, specify and add \$249 list per base; see page 205</li> </ul>	48	240	30	634	55	<b>BV48240BT-5PB</b>	\$14,210	\$15,632
---	----	-----	----	-----	----	----------------------	----------	----------

**To Order, Specify:**

- ① Model Number
- ② Wood Species - Cherry (CH1), Maple (MA1) or Walnut (WA1) or Double Cut (DC1) (see page 206)
- ③ Finish Color (see page 206)
- ④ Metal Color (see page 206)
- ⑤ Power and Data Options (see pages 519-535)
- ⑥ Other Product Options

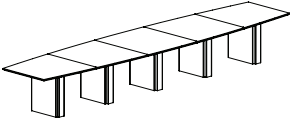
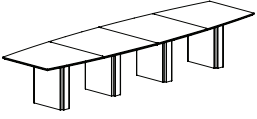
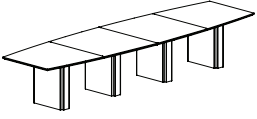
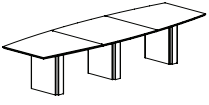
Description	D	W	H	CTN WT	CU FT	Model	Flat Cut List Price	Double Cut List Price
<b>Boat Shape Table with Panel Bases</b>  <ul style="list-style-type: none"> <li>· five piece top</li> <li>· tapers to 36" on ends</li> <li>· five panel bases</li> <li>· bases; 5-24"d x 7"w</li> <li>· 36 1/4" between bases, 18" at ends</li> <li>· metal inlay available - specify and add \$2,180 list, see page 204</li> <li>· access door available, specify and add \$249 list per base; see page 205</li> </ul>	48	216	30	588	55	<b>BV48216BT-5PB</b>	\$12,096	\$13,306
<b>Boat Shape Table with Panel Bases</b>  <ul style="list-style-type: none"> <li>· four piece top</li> <li>· tapers to 36" on ends</li> <li>· four panel bases</li> <li>· bases; 4-24"d x 7"w</li> <li>· 42 1/16" between bases, 18" at ends</li> <li>· metal inlay available - specify and add \$1,873 list, see page 204</li> <li>· access door available, specify and add \$249 list per base; see page 205</li> </ul>	48	192	30	504	44	<b>BV48192BT-4PB</b>	\$10,398	\$11,437
<b>Boat Shape Table with Panel Bases</b>  <ul style="list-style-type: none"> <li>· four piece top</li> <li>· tapers to 36" on ends</li> <li>· four panel bases</li> <li>· bases; 4-24"d x 7"w</li> <li>· 34 1/16" between bases, 18" at ends</li> <li>· metal inlay available - specify and add \$1,732 list, see page 204</li> <li>· access door available, specify and add \$249 list per base; see page 205</li> </ul>	48	168	30	458	44	<b>BV48168BT-4PB</b>	\$9,609	\$10,571
<b>Boat Shape Table with Panel Bases</b>  <ul style="list-style-type: none"> <li>· three piece top</li> <li>· tapers to 36" on ends</li> <li>· three panel bases</li> <li>· bases; 3-24"d x 7"w</li> <li>· 43 1/2" between bases, 18" at ends</li> <li>· metal inlay available - specify and add \$1,356 list, see page 204</li> <li>· access door available, specify and add \$249 list per base; see page 205</li> </ul>	48	144	30	374	33	<b>BV48144BT-3PB</b>	\$7,521	\$8,272

BRAVADO

Description	D	W	H	CTN WT	CU FT	① Model	Flat Cut List Price	Double Cut List Price
-------------	---	---	---	-----------	----------	---------	------------------------	--------------------------

Boat Shape Table with Panel Bases

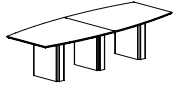

- two piece top
- tapers to 36" on ends
- three panel bases
- bases; 3-24"d x 7"w
- 31 1/2" between bases, 18" at ends
- metal inlay available - specify and add \$1,197 list, see page 204
- access door available, specify and add \$249 list per base; see page 205

	48	120	30	328	31	<b>BV48120BT-3PB</b>	\$6,639	\$7,302
--	----	-----	----	-----	----	----------------------	---------	---------

Boat Shape Table with Panel Bases

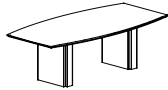

- one piece top
- tapers to 36" on ends
- two panel bases
- bases; 2-24"d x 7"w
- 46" between bases, 18" at ends
- metal inlay available - specify and add \$1,028 list, see page 204
- access door available, specify and add \$249 list per base; see page 205

	48	96	30	245	20	<b>BV4896BT-2PB</b>	\$5,696	\$6,265
--	----	----	----	-----	----	---------------------	---------	---------

**To Order, Specify:**

- ① Model Number
- ② Wood Species - Cherry (CH1), Maple (MA1) or Walnut (WA1) or Double Cut (DC1) (see page 206)
- ③ Finish Color (see page 206)
- ④ Metal Color (see page 206)
- ⑤ Power and Data Options (see pages 519-535)
- ⑥ Other Product Options

Description	D	W	H	CTN WT	CU FT	Model	Flat Cut List Price	Double Cut List Price
-------------	---	---	---	-----------	----------	-------	------------------------	--------------------------

View Table with Panel Bases	84	240	30	803	77	<b>BV84240VT-5PB</b>	\$14,410	\$15,852
-----------------------------	----	-----	----	-----	----	----------------------	----------	----------

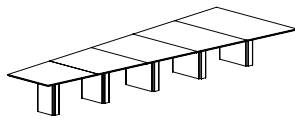

- top size: 240"w x 42/84"d
- five piece top
- five panel bases
- bases L to R; 18"d x 7"w, 24"d x 7"w, 30"d x 7"w, 30"d x 7"w, 30"d x 7"w
- 42 1/4" between bases, 18" at ends
- metal inlay available - specify and add \$2,597 list, see page 204
- access door available, specify and add \$249 list per base; see page 205

View Table with Panel Bases	78	216	30	756	72	<b>BV78216VT-5PB</b>	\$13,599	\$14,961
-----------------------------	----	-----	----	-----	----	----------------------	----------	----------

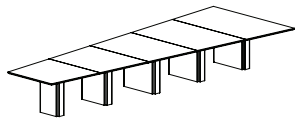

- top size: 216"w x 42/78"d
- five piece top
- five panel bases
- bases L to R; 18"d x 7"w, 24"d x 7"w, 30"d x 7"w, 30"d x 7"w, 30"d x 7"w
- 36 1/4" between bases, 18" at ends
- metal inlay available - specify and add \$2,450 list, see page 204
- access door available, specify and add \$249 list per base; see page 205

View Table with Panel Bases	72	192	30	668	57	<b>BV72192VT-4PB</b>	\$11,598	\$12,759
-----------------------------	----	-----	----	-----	----	----------------------	----------	----------

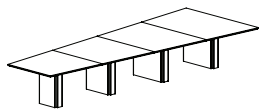

- top size: 192"w x 42/72"d
- four piece top
- four panel bases
- bases L to R; 18"d x 7"w, 24"d x 7"w, 30"d x 7"w, 30"d x 7"w
- 42 1/6" between bases, 18" at ends
- metal inlay available - specify and add \$2,089 list, see page 204
- access door available, specify and add \$249 list per base; see page 205

View Table with Panel Bases	66	168	30	588	48	<b>BV66168VT-4PB</b>	\$10,844	\$11,928
-----------------------------	----	-----	----	-----	----	----------------------	----------	----------

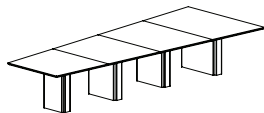

- top size: 168"w x 42/66"d
- four piece top
- four panel bases
- bases L to R; 18"d x 7"w, 24"d x 7"w, 24"d x 7"w, 30"d x 7"w
- 34 1/6" between bases, 18" at ends
- metal inlay available - specify and add \$1,955 list, see page 204
- access door available, specify and add \$249 list per base; see page 205

View Table with Panel Bases	60	144	30	435	39	<b>BV60144VT-3PB</b>	\$8,656	\$9,521
-----------------------------	----	-----	----	-----	----	----------------------	---------	---------

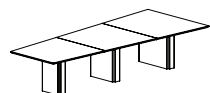

- top size: 144"w x 42/60"d
- three piece top
- three panel bases
- bases L to R; 18"d x 7"w, 24"d x 7"w, 30"d x 7"w
- 43 1/2" between bases, 18" at ends
- metal inlay available - specify and add \$1,560 list, see page 204
- access door available, specify and add \$249 list per base; see page 205

BRAVADO

Description	D	W	H	CTN WT	CU FT	① Model	Flat Cut List Price	Double Cut List Price
-------------	---	---	---	-----------	----------	---------	------------------------	--------------------------

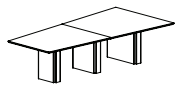

- |                             |    |     |    |     |    |               |         |         |
|-----------------------------|----|-----|----|-----|----|---------------|---------|---------|
| View Table with Panel Bases | 60 | 120 | 30 | 373 | 33 | BV60120VT-3PB | \$7,379 | \$8,117 |
|-----------------------------|----|-----|----|-----|----|---------------|---------|---------|
- top size: 120"w x 42/60"d
  - two piece top
  - three panel bases
  - bases L to R; 18"d x 7"w, 24"d x 7"w, 30"d x 7"w
  - 31 1/2" between bases, 18" at ends
  - metal inlay available - specify and add \$1,331 list, see page 204
  - access door available, specify and add \$249 list per base; see page 205

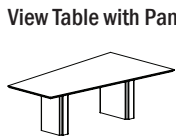

- |                             |    |    |    |     |    |              |         |         |
|-----------------------------|----|----|----|-----|----|--------------|---------|---------|
| View Table with Panel Bases | 54 | 96 | 30 | 303 | 22 | BV5496VT-2PB | \$5,988 | \$6,587 |
|-----------------------------|----|----|----|-----|----|--------------|---------|---------|
- top size: 96"w x 36/54"d
  - one piece top
  - two panel bases
  - bases L to R; 18"d x 7"w, 24"d x 7"w
  - 46" between bases, 18" at ends
  - metal inlay available - specify and add \$1,080 list, see page 204
  - access door available, specify and add \$249 list per base; see page 205

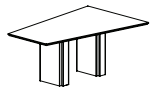

- |                             |    |    |    |     |    |              |         |         |
|-----------------------------|----|----|----|-----|----|--------------|---------|---------|
| View Table with Panel Bases | 48 | 72 | 30 | 218 | 17 | BV4872VT-2PB | \$5,163 | \$5,679 |
|-----------------------------|----|----|----|-----|----|--------------|---------|---------|
- top size: 72"w x 30/48"d
  - one piece top
  - two panel bases
  - bases L to R; 18"d x 7"w, 18"d x 7"w
  - 22" between bases, 18" at ends
  - metal inlay available - specify and add \$932 list, see page 204
  - access door available, specify and add \$249 list per base; see page 205

**To Order, Specify:**

- ① Model Number
- ② Wood Species - Cherry (CH1), Maple (MA1) or Walnut (WA1) or Double Cut (DC1) (see page 206)
- ③ Finish Color (see page 206)
- ④ Metal Color (see page 206)
- ⑤ Power and Data Options (see pages 519-535)
- ⑥ Other Product Options

Description	D	W	H	CTN WT	CU FT	Model	Flat Cut List Price	Double Cut List Price
Rectangular Table with Square Bases	54	288	30	875	102	BV54288TT-5SB	\$19,292	\$21,220

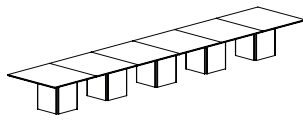

- six piece top
- five square bases
- bases; 5-24"d x 24"w
- 33" between bases, 18" at ends
- metal inlay available - specify and add \$3,474 list, see page 204
- access door available, specify and add \$249 list per base; see page 205

Rectangular Table with Square Bases	54	264	30	821	84	BV54264TT-4SB	\$17,646	\$19,411
-------------------------------------	----	-----	----	-----	----	---------------	----------	----------

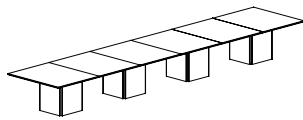

- six piece top
- four square bases
- bases; 4-24"d x 24"w
- 44" between bases, 18" at ends
- metal inlay available - specify and add \$3,179 list, see page 204
- access door available, specify and add \$249 list per base; see page 205

Rectangular Table with Square Bases	54	240	30	767	83	BV54240TT-4SB	\$15,988	\$17,587
-------------------------------------	----	-----	----	-----	----	---------------	----------	----------

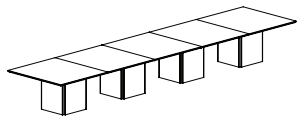

- five piece top
- four square bases
- bases; 4-24"d x 24"w
- 36" between bases, 18" at ends
- metal inlay available - specify and add \$2,881 list, see page 204
- access door available, specify and add \$249 list per base; see page 205

Rectangular Table with Square Bases	54	216	30	668	78	BV54216TT-4SB	\$14,111	\$15,522
-------------------------------------	----	-----	----	-----	----	---------------	----------	----------

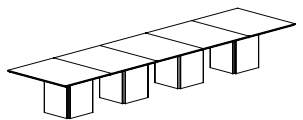

- five piece top
- four square bases
- bases; 4-24"d x 24"w
- 28" between bases, 18" at ends
- metal inlay available - specify and add \$2,542 list, see page 204
- access door available, specify and add \$249 list per base; see page 205

Rectangular Table with Square Bases	54	192	30	614	64	BV54192TT-3SB	\$11,750	\$12,924
-------------------------------------	----	-----	----	-----	----	---------------	----------	----------

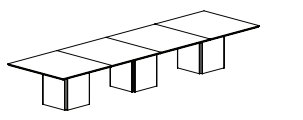

- four piece top
- three square bases
- bases; 3-24"d x 24"w
- 42" between bases, 18" at ends
- metal inlay available - specify and add \$2,118 list, see page 204
- access door available, specify and add \$249 list per base; see page 205

Description	D	W	H	CTN WT	CU FT	① Model	Flat Cut List Price	Double Cut List Price
Rectangular Table with Square Bases	48	288	30	828	96	BV48288TT-5SB	\$17,002	\$18,702

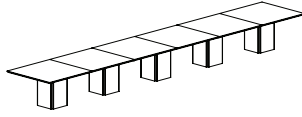

- six piece top
- five square bases
- bases; 5-18"d x 18"w
- 40 1/2" between bases, 18" at ends
- metal inlay available - specify and add \$3,062 list, see page 204
- access door available, specify and add \$249 list per base; see page 205

Rectangular Table with Square Bases	48	264	30	778	96	BV48264TT-5SB	\$16,203	\$17,823
-------------------------------------	----	-----	----	-----	----	---------------	----------	----------

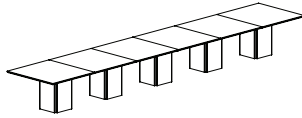

- six piece top
- five square bases
- bases; 5-18"d x 18"w
- 34 1/2" between bases, 18" at ends
- metal inlay available - specify and add \$2,919 list, see page 204
- access door available, specify and add \$249 list per base; see page 205

Rectangular Table with Square Bases	48	240	30	690	78	BV48240TT-4SB	\$13,516	\$14,869
-------------------------------------	----	-----	----	-----	----	---------------	----------	----------

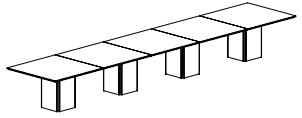

- five piece top
- four square bases
- bases; 4-18"d x 18"w
- 44" between bases, 18" at ends
- metal inlay available - specify and add \$2,435 list, see page 204
- access door available, specify and add \$249 list per base; see page 205

Rectangular Table with Square Bases	48	216	30	640	78	BV48216TT-4SB	\$11,589	\$12,749
-------------------------------------	----	-----	----	-----	----	---------------	----------	----------

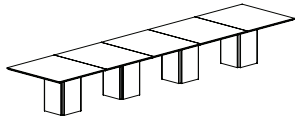

- five piece top
- four square bases
- bases; 4-18"d x 18"w
- 36" between bases, 18" at ends
- metal inlay available - specify and add \$2,088 list, see page 204
- access door available, specify and add \$249 list per base; see page 205

**To Order, Specify:**

- ① Model Number
- ② Wood Species - Cherry (CH1), Maple (MA1) or Walnut (WA1) or Double Cut (DC1) (see page 206)
- ③ Finish Color (see page 206)
- ④ Metal Color (see page 206)
- ⑤ Power and Data Options (see pages 519-535)
- ⑥ Other Product Options

Description	D	W	H	CTN WT	CU FT	Model	Flat Cut List Price	Double Cut List Price
-------------	---	---	---	--------	-------	-------	---------------------	-----------------------

<b>Rectangular Table with Square Bases</b>	48	192	30	592	72	<b>BV48192TT-4SB</b>	<b>\$10,277</b>	<b>\$11,305</b>
--	----	-----	----	-----	----	----------------------	-----------------	-----------------

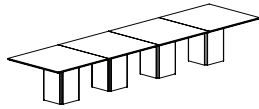

- four piece top
- four square bases
- bases; 4-18"d x 18"w
- 28" between bases, 18" at ends
- metal inlay available - specify and add \$1,852 list, see page 204
- access door available, specify and add \$249 list per base; see page 205

<b>Rectangular Table with Square Bases</b>	48	168	30	542	60	<b>BV48168TT-3SB</b>	<b>\$9,140</b>	<b>\$10,055</b>
--	----	-----	----	-----	----	----------------------	----------------	-----------------

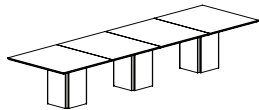

- four piece top
- three square bases
- bases; 3-18"d x 18"w
- 39" between bases, 18" at ends
- metal inlay available - specify and add \$1,648 list, see page 204
- access door available, specify and add \$249 list per base; see page 205

<b>Rectangular Table with Square Bases</b>	48	144	30	444	54	<b>BV48144TT-3SB</b>	<b>\$7,352</b>	<b>\$8,089</b>
--	----	-----	----	-----	----	----------------------	----------------	----------------

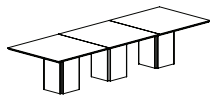

- three piece top
- three square bases
- bases; 3-18"d x 18"w
- 27" between bases, 18" at ends
- metal inlay available - specify and add \$1,326 list, see page 204
- access door available, specify and add \$249 list per base; see page 205

<b>Rectangular Table with Square Bases</b>	48	120	30	394	40	<b>BV48120TT-2SB</b>	<b>\$6,390</b>	<b>\$7,028</b>
--	----	-----	----	-----	----	----------------------	----------------	----------------

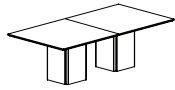

- two piece top
- two square bases
- bases; 2-18"d x 18"w
- 48" between bases, 18" at ends
- metal inlay available - specify and add \$1,152 list, see page 204
- access door available, specify and add \$249 list per base; see page 205

BRVAVADO



Description	D	W	H	CTN WT	CU FT	① Model	Flat Cut List Price	Double Cut List Price
Rectangular Table with Square Bases	48	96	30	272	36	BV4896TT-2SB	\$5,803	\$6,383

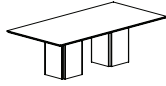

- one piece top
- two square bases
- bases; 2-18"d x 18"w
- 24" between bases, 18" at ends
- metal inlay available - specify and add \$1,046 list, see page 204
- access door available, specify and add \$249 list per base; see page 205

**To Order, Specify:**

- ① Model Number
- ② Wood Species - Cherry (CH1), Maple (MA1) or Walnut (WA1) or Double Cut (DC1) (see page 206)
- ③ Finish Color (see page 206)
- ④ Metal Color (see page 206)
- ⑤ Power and Data Options (see pages 519-535)
- ⑥ Other Product Options

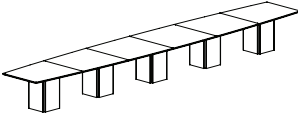
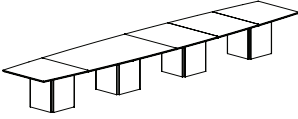
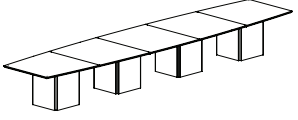
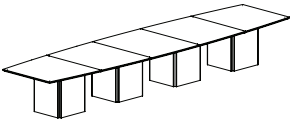
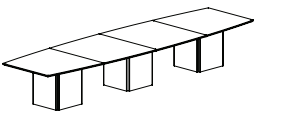
Description	D	W	H	CTN WT	CU FT	Model	Flat Cut List Price	Double Cut List Price
<b>Boat Shape Table with Square Bases</b>  <ul style="list-style-type: none"> <li>· six piece top</li> <li>· tapers to 42" on ends</li> <li>· five square bases</li> <li>· bases; 5-24"d x 24"w</li> <li>· 33" between bases, 18" at ends</li> <li>· metal inlay available - specify and add \$3,457 list, see page 204</li> <li>· access door available, specify and add \$249 list per base; see page 205</li> </ul>	54	288	30	876	102	<b>BV54288BT-5SB</b>	\$19,187	\$21,106
<b>Boat Shape Table with Square Bases</b>  <ul style="list-style-type: none"> <li>· six piece top</li> <li>· tapers to 42" on ends</li> <li>· four square bases</li> <li>· bases; 4-24"d x 24"w</li> <li>· 44" between bases, 18" at ends</li> <li>· metal inlay available - specify and add \$3,184 list, see page 204</li> <li>· access door available, specify and add \$249 list per base; see page 205</li> </ul>	54	264	30	826	84	<b>BV54264BT-4SB</b>	\$17,685	\$19,454
<b>Boat Shape Table with Square Bases</b>  <ul style="list-style-type: none"> <li>· five piece top</li> <li>· tapers to 42" on ends</li> <li>· four square bases</li> <li>· bases; 4-24"d x 24"w</li> <li>· 36" between bases, 18" at ends</li> <li>· metal inlay available - specify and add \$2,896 list, see page 204</li> <li>· access door available, specify and add \$249 list per base; see page 205</li> </ul>	54	240	30	776	83	<b>BV54240BT-4SB</b>	\$16,080	\$17,687
<b>Boat Shape Table with Square Bases</b>  <ul style="list-style-type: none"> <li>· five piece top</li> <li>· tapers to 42" on ends</li> <li>· four square bases</li> <li>· bases; 4-24"d x 24"w</li> <li>· 28" between bases, 18" at ends</li> <li>· metal inlay available - specify and add \$2,505 list, see page 204</li> <li>· access door available, specify and add \$249 list per base; see page 205</li> </ul>	54	216	30	666	78	<b>BV54216BT-4SB</b>	\$13,906	\$15,296
<b>Boat Shape Table with Square Bases</b>  <ul style="list-style-type: none"> <li>· four piece top</li> <li>· tapers to 42" on ends</li> <li>· three square bases</li> <li>· bases; 3-24"d x 24"w</li> <li>· 42" between bases, 18" at ends</li> <li>· metal inlay available - specify and add \$2,139 list, see page 204</li> <li>· access door available, specify and add \$249 list per base; see page 205</li> </ul>	54	192	30	616	64	<b>BV54192BT-3SB</b>	\$11,872	\$13,059

BRAVADO

Description	D	W	H	CTN WT	CU FT	① Model	Flat Cut List Price	Double Cut List Price
-------------	---	---	---	-----------	----------	---------	------------------------	--------------------------

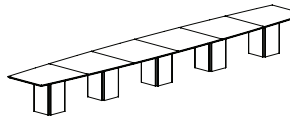
<b>Boat Shape Table with Square Bases</b>  <ul style="list-style-type: none"> <li>• six piece top</li> <li>• tapers to 36" on ends</li> <li>• five square bases</li> <li>• bases; 5-18"d x 18"w</li> <li>• 40 1/2" between bases, 18" at ends</li> <li>• metal inlay available - specify and add \$3,060 list, see page 204</li> <li>• access door available, specify and add \$249 list per base; see page 205</li> </ul>	48	288	30	816	96	<b>BV48288BT-5SB</b>	\$16,986	\$18,686
--	----	-----	----	-----	----	----------------------	----------	----------

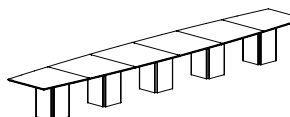
<b>Boat Shape Table with Square Bases</b>  <ul style="list-style-type: none"> <li>• six piece top</li> <li>• tapers to 36" on ends</li> <li>• five square bases</li> <li>• bases; 5-18"d x 18"w</li> <li>• 34 1/2" between bases, 18" at ends</li> <li>• metal inlay available - specify and add \$2,917 list, see page 204</li> <li>• access door available, specify and add \$249 list per base; see page 205</li> </ul>	48	264	30	770	96	<b>BV48264BT-5SB</b>	\$16,191	\$17,810
--	----	-----	----	-----	----	----------------------	----------	----------

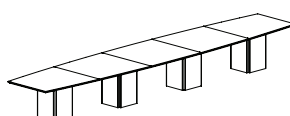
<b>Boat Shape Table with Square Bases</b>  <ul style="list-style-type: none"> <li>• five piece top</li> <li>• tapers to 36" on ends</li> <li>• four square bases</li> <li>• bases; 4-18"d x 18"w</li> <li>• 44" between bases, 18" at ends</li> <li>• metal inlay available - specify and add \$2,442 list, see page 204</li> <li>• access door available, specify and add \$249 list per base; see page 205</li> </ul>	48	240	30	676	78	<b>BV48240BT-4SB</b>	\$13,552	\$14,908
--	----	-----	----	-----	----	----------------------	----------	----------

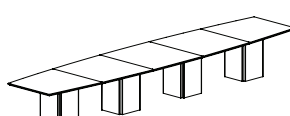
<b>Boat Shape Table with Square Bases</b>  <ul style="list-style-type: none"> <li>• five piece top</li> <li>• tapers to 36" on ends</li> <li>• four square bases</li> <li>• bases; 4-18"d x 18"w</li> <li>• 36" between bases, 18" at ends</li> <li>• metal inlay available - specify and add \$2,099 list, see page 204</li> <li>• access door available, specify and add \$249 list per base; see page 205</li> </ul>	48	216	30	630	78	<b>BV48216BT-4SB</b>	\$11,648	\$12,812
---	----	-----	----	-----	----	----------------------	----------	----------

**To Order, Specify:**

- ① Model Number
- ② Wood Species - Cherry (CH1), Maple (MA1) or Walnut (WA1) or Double Cut (DC1) (see page 206)
- ③ Finish Color (see page 206)
- ④ Metal Color (see page 206)
- ⑤ Power and Data Options (see pages 519-535)
- ⑥ Other Product Options

BRAVADO

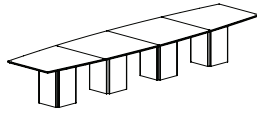
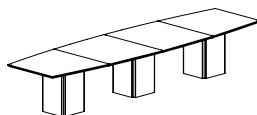
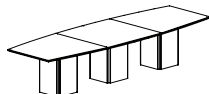
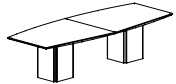
Description	D	W	H	CTN WT	CU FT	Model	Flat Cut List Price	Double Cut List Price
<b>Boat Shape Table with Square Bases</b>  <ul style="list-style-type: none"> <li>· four piece top</li> <li>· tapers to 36" on ends</li> <li>· four square bases</li> <li>· bases; 4-18"d x 18"w</li> <li>· 28" between bases, 18" at ends</li> <li>· metal inlay available - specify and add \$1,857 list, see page 204</li> <li>· access door available, specify and add \$249 list per base; see page 205</li> </ul>	48	192	30	536	72	<b>BV48192BT-4SB</b>	\$10,303	\$11,332
<b>Boat Shape Table with Square Bases</b>  <ul style="list-style-type: none"> <li>· four piece top</li> <li>· tapers to 36" on ends</li> <li>· three square bases</li> <li>· bases; 3-18"d x 18"w</li> <li>· 39" between bases, 18" at ends</li> <li>· metal inlay available - specify and add \$1,665 list, see page 204</li> <li>· access door available, specify and add \$249 list per base; see page 205</li> </ul>	48	168	30	490	60	<b>BV48168BT-3SB</b>	\$9,237	\$10,161
<b>Boat Shape Table with Square Bases</b>  <ul style="list-style-type: none"> <li>· three piece top</li> <li>· tapers to 36" on ends</li> <li>· three square bases</li> <li>· bases; 3-18"d x 18"w</li> <li>· 27" between bases, 18" at ends</li> <li>· metal inlay available - specify and add \$1,333 list, see page 204</li> <li>· access door available, specify and add \$249 list per base; see page 205</li> </ul>	48	144	30	396	54	<b>BV48144BT-3SB</b>	\$7,394	\$8,133
<b>Boat Shape Table with Square Bases</b>  <ul style="list-style-type: none"> <li>· two piece top</li> <li>· tapers to 36" on ends</li> <li>· two square bases</li> <li>· bases; 2-18"d x 18"w</li> <li>· 48" between bases, 18" at ends</li> <li>· metal inlay available - specify and add \$1,167 list, see page 204</li> <li>· access door available, specify and add \$249 list per base; see page 205</li> </ul>	48	120	30	350	40	<b>BV48120BT-2SB</b>	\$6,476	\$7,123

BRAVADO

Description	D	W	H	CTN WT	CU FT	① Model	Flat Cut List Price	Double Cut List Price
Boat Shape Table with Square Bases	48	96	30	257	36	BV4896BT-2SB	\$5,810	\$6,393

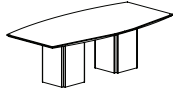

- one piece top
- tapers to 36" on ends
- two square bases
- bases; 2-18"d x 18"w
- 24" between bases, 18" at ends
- metal inlay available - specify and add \$1,048 list, see page 204
- access door available, specify and add \$249 list per base; see page 205

**To Order, Specify:**

- ① Model Number
- ② Wood Species - Cherry (CH1), Maple (MA1) or Walnut (WA1) or Double Cut (DC1) (see page 206)
- ③ Finish Color (see page 206)
- ④ Metal Color (see page 206)
- ⑤ Power and Data Options (see pages 519-535)
- ⑥ Other Product Options

Description	D	W	H	CTN WT	CU FT	Model	Flat Cut List Price	Double Cut List Price
-------------	---	---	---	--------	-------	-------	---------------------	-----------------------

View Table with Square Bases	84	240	30	852	105	<b>BV84240VT-4SB</b>	\$19,177	\$21,095
------------------------------	----	-----	----	-----	-----	----------------------	----------	----------

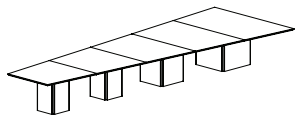

- top size: 240"w x 42/84"d
- five piece top
- four square bases
- bases L to R; 18"d x 18"w, 18"d x 18"w, 24"d x 24"w, 30"d x 30"w
- 38" between bases, 18" at ends
- metal inlay available - specify and add \$3,456 list, see page 204
- access door available, specify and add \$249 list per base; see page 205

View Table with Square Bases	78	216	30	764	100	<b>BV78216VT-4SB</b>	\$15,093	\$16,603
------------------------------	----	-----	----	-----	-----	----------------------	----------	----------

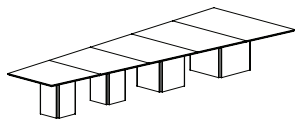

- top size: 216"w x 42/78"d
- five piece top
- four square bases
- bases L to R; 18"d x 18"w, 18"d x 18"w, 24"d x 24"w, 30"d x 30"w
- 30" between bases, 18" at ends
- metal inlay available - specify and add \$2,719 list, see page 204
- access door available, specify and add \$249 list per base; see page 205

View Table with Square Bases	72	192	30	714	79	<b>BV72192VT-3SB</b>	\$12,366	\$13,604
------------------------------	----	-----	----	-----	----	----------------------	----------	----------

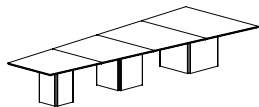

- top size: 192"w x 42/72"d
- four piece top
- three square bases
- bases L to R; 18"d x 18"w, 24"d x 24"w, 30"d x 30"w
- 42" between bases, 18" at ends
- metal inlay available - specify and add \$2,229 list, see page 204
- access door available, specify and add \$249 list per base; see page 205

View Table with Square Bases	66	168	30	574	71	<b>BV66168VT-3SB</b>	\$11,002	\$12,102
------------------------------	----	-----	----	-----	----	----------------------	----------	----------

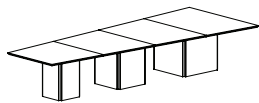

- top size: 168"w x 42/66"d
- four piece top
- three square bases
- bases L to R; 18"d x 18"w, 24"d x 24"w, 30"d x 30"w
- 30" between bases, 18" at ends
- metal inlay available - specify and add \$1,982 list
- access door available, specify and add \$249 list per base; see page 205

View Table with Square Bases	60	144	30	466	60	<b>BV60144VT-3SB</b>	\$8,624	\$9,485
------------------------------	----	-----	----	-----	----	----------------------	---------	---------

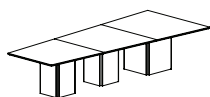

- top size: 144"w x 42/60"d
- three piece top
- three square bases
- bases L to R; 18"d x 18"w, 18"d x 18"w, 24"d x 24"w
- 24" between bases, 18" at ends
- metal inlay available - specify and add \$1,553 list, see page 204
- access door available, specify and add \$249 list per base; see page 205

BRAVADO

Description	D	W	H	CTN WT	CU FT	① Model	Flat Cut List Price	Double Cut List Price
View Table with Square Bases	60	120	30	368	42	BV60120VT-2SB	\$7,135	\$7,849

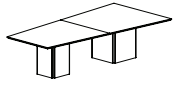

- top size: 120"w x 42/60"d
- two piece top
- two square bases
- bases L to R; 18"d x 18"w, 24"d x 24"w
- 42" between bases, 18" at ends
- metal inlay available - specify and add \$1,287 list, see page 204
- access door available, specify and add \$249 list per base; see page 205

View Table with Square Bases	54	96	30	316	37	BV5496VT-2SB	\$6,039	\$6,644
------------------------------	----	----	----	-----	----	--------------	---------	---------

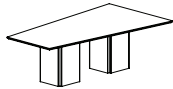

- top size: 96"w x 36/54"d
- one piece top
- two square bases
- bases L to R; 18"d x 18"w, 18"d x 18"w
- 24" between bases, 18" at ends
- metal inlay available - specify and add \$1,090 list, see page 204
- access door available, specify and add \$249 list per base; see page 205

**To Order, Specify:**

- ① Model Number
- ② Wood Species - Cherry (CH1), Maple (MA1) or Walnut (WA1) or Double Cut (DC1) (see page 206)
- ③ Finish Color (see page 206)
- ④ Metal Color (see page 206)
- ⑤ Power and Data Options (see pages 519-535)
- ⑥ Other Product Options

Description	D	W	H	CTN WT	CU FT	Model	Flat Cut List Price	Double Cut List Price
-------------	---	---	---	-----------	----------	-------	------------------------	--------------------------

Square Conference Table	60	60	30	160	28	BV6060TT-1SB	\$4,915	\$5,406
-------------------------	----	----	----	-----	----	--------------	---------	---------

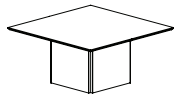

- base; 30"d x 30"w
- metal inlay available - specify and add \$886 list, see page 204
- access door available, specify and add \$249 list per base; see page 205

Square Conference Table	54	54	30	138	20	BV5454TT-1SB	\$4,569	\$5,028
-------------------------	----	----	----	-----	----	--------------	---------	---------

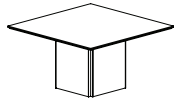

- base; 24"d x 24"w
- metal inlay available - specify and add \$824 list, see page 204
- access door available, specify and add \$249 list per base; see page 205

Square Conference Table	48	48	30	111	18	BV4848TT-1SB	\$4,142	\$4,557
-------------------------	----	----	----	-----	----	--------------	---------	---------

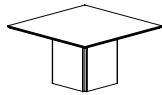

- base; 18"d x 18"w
- metal inlay available - specify and add \$748 list, see page 204
- access door available, specify and add \$249 list per base; see page 205

Square Conference Table	42	42	30	96	17	BV4242TT-1SB	\$4,024	\$4,428
-------------------------	----	----	----	----	----	--------------	---------	---------

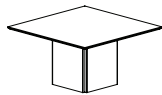

- base; 18"d x 18"w
- metal inlay available - specify and add \$726 list, see page 204
- access door available, specify and add \$249 list per base; see page 205



Description	D	W	H	CTN WT	CU FT	① Model	Flat Cut List Price	Double Cut List Price
Buffet Credenza	24	72	36	370	43	BV2472-36BSC	\$5,881	\$6,470
	24	66	36	340	39	BV2466-36BSC	\$5,550	\$6,105

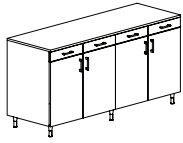

- four drawers
- four hinged doors concealing two storage compartments each with an adjustable shelf
- locking drawer and doors not available
- 72" storage compartments: 22 7/16" d x 34 1/16" w x 25 1/2" h each
- 66" storage compartments: 22 7/16" d x 31 1/16" w x 25 1/2" h each

**To Order, Specify:**

- ① Model Number
- ② Wood Species - Cherry (CH1), Maple (MA1) or Walnut (WA1) or Double Cut (DC1) (see page 206)
- ③ Finish Color (see page 206)
- ④ Metal Color (see page 206)
- ⑤ Pull Color (see page 206)
- ⑥ Power and Data Options (see pages 519-535)
- ⑦ Other Product Options

Description	D	W	H	CTN WT	CU FT	Model	Flat Cut List Price	Double Cut List Price
-------------	---	---	---	--------	-------	-------	---------------------	-----------------------

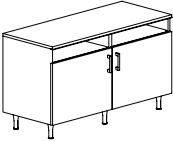
 <ul style="list-style-type: none"> <li>· two open storage compartments</li> <li>· two hinged doors with one adjustable shelf in each section</li> <li>· locking doors available, specify and add \$123</li> <li>· open compartment opening: 18<sup>7</sup>/<sub>16</sub>"d x 22<sup>11</sup>/<sub>16</sub>"w x 4"h each</li> <li>· storage compartments: 18<sup>7</sup>/<sub>16</sub>"d x 22<sup>11</sup>/<sub>16</sub>"w x 16<sup>13</sup>/<sub>16</sub>"h each</li> </ul>	20	48	28	185	20	BV2048-28MCCS	\$3,718	\$4,091
--	----	----	----	-----	----	---------------	---------	---------

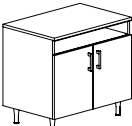
 <ul style="list-style-type: none"> <li>· open storage compartment</li> <li>· two hinged doors with one storage compartment with an adjustable shelf</li> <li>· locking doors available, specify and add \$123</li> <li>· open compartment opening: 18<sup>7</sup>/<sub>16</sub>"d x 28<sup>1</sup>/<sub>2</sub>"w x 4"h</li> </ul>	20	30	28	115	13	BV2030-28MC	\$2,573	\$2,830
---	----	----	----	-----	----	-------------	---------	---------

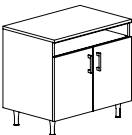
 <ul style="list-style-type: none"> <li>· open storage compartment</li> <li>· two hinged doors with one storage compartment with an adjustable shelf</li> <li>· locking doors available, specify and add \$123</li> <li>· open compartment opening: 18<sup>7</sup>/<sub>16</sub>"d x 22<sup>1</sup>/<sub>2</sub>"w x 4"h</li> <li>· storage compartment: 18<sup>7</sup>/<sub>16</sub>"d x 22<sup>1</sup>/<sub>2</sub>"w x 16<sup>13</sup>/<sub>16</sub>"h</li> </ul>	20	24	28	92	10	BV2024-28MC	\$2,389	\$2,630
---	----	----	----	----	----	-------------	---------	---------

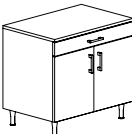
 <ul style="list-style-type: none"> <li>· storage drawer</li> <li>· two hinged doors with one storage compartment with an adjustable shelf</li> <li>· locking doors available, specify and add \$123</li> <li>· locking drawer not available</li> <li>· storage compartment: 18<sup>7</sup>/<sub>16</sub>"d x 28<sup>1</sup>/<sub>2</sub>"w x 16<sup>13</sup>/<sub>16</sub>"h</li> </ul>	20	30	28	123	13	BV2030-28SC	\$2,811	\$3,093
--	----	----	----	-----	----	-------------	---------	---------

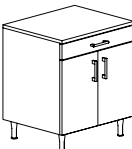
 <ul style="list-style-type: none"> <li>· storage drawer</li> <li>· two hinged doors with one storage compartment with an adjustable shelf</li> <li>· locking doors available, specify and add \$123</li> <li>· locking drawer not available</li> <li>· storage compartment: 18<sup>7</sup>/<sub>16</sub>"d x 22<sup>1</sup>/<sub>2</sub>"w x 16<sup>13</sup>/<sub>16</sub>"h</li> </ul>	20	24	28	120	10	BV2024-28SC	\$2,639	\$2,903
--	----	----	----	-----	----	-------------	---------	---------

BRAVADO

Description	D	W	H	CTN WT	CU FT	① Model	Flat Cut List Price	Double Cut List Price
-------------	---	---	---	-----------	----------	---------	------------------------	--------------------------

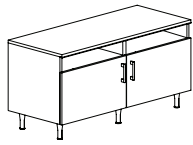

- two open storage compartments
- two hinged doors with one adjustable shelf in each section
- locking doors available, specify and add \$123
- open compartment opening: 18 7/16" d x 22 1/4" w x 4" h each
- storage compartments: 18 7/16" d x 22 1/4" w x 12 13/16" h each

24" h Media Cabinet	20	30	24	105	11	BV2030-24MC	\$2,534	\$2,787
---------------------	----	----	----	-----	----	-------------	---------	---------

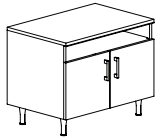

- open storage compartment
- two hinged doors with one storage compartment with an adjustable shelf
- locking doors available, specify and add \$123
- open compartment opening: 18 7/16" d x 28 1/2" w x 4" h
- storage compartment: 18 7/16" d x 28 1/2" w x 12 13/16" h

24" h Media Cabinet	20	24	24	88	9	BV2024-24MC	\$2,353	\$2,587
---------------------	----	----	----	----	---	-------------	---------	---------

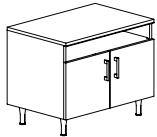

- open storage compartment
- two hinged doors with one storage compartment with an adjustable shelf
- locking doors available, specify and add \$123
- open compartment opening: 18 7/16" d x 22 1/2" w x 4" h
- storage compartment: 18 7/16" d x 22 1/2" w x 12 13/16" h

24" h Media Cabinet	20	30	24	113	11	BV2030-24SC	\$2,863	\$3,149
	20	24	24	110	9	BV2024-24SC	\$2,669	\$2,934

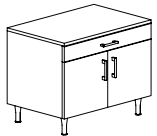

- storage drawer
- two hinged doors with one storage compartment with an adjustable shelf
- locking doors available, specify and add \$123
- locking drawer not available
- 30" w storage compartment: 18 7/16" d x 28 1/2" w x 12 13/16" h
- 24" w storage compartment: 18 7/16" d x 22 1/2" w x 12 13/16" h

**To Order, Specify:**

- ① Model Number
- ② Wood Species - Cherry (CH1), Maple (MA1) or Walnut (WA1) or Double Cut (DC1) (see page 206)
- ③ Finish Color (see page 206)
- ④ Metal Color (see page 206)
- ⑤ Pull Color (see page 206)
- ⑥ Power and Data Options (see pages 519-535)
- ⑦ Other Product Options

Description	D	W	H	CTN WT	CU FT	Model	Flat Cut List Price	Double Cut List Price
Center Wall Panel	4	48	50	70	7	BV4802-50CDW	\$2,010	\$2,212

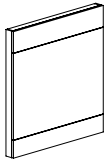

- use for mounting flat screen television
- can accommodate a 47" screen
- mounting hardware included
- flat screen mounting hardware sold separately

				List Price
Mounting Hardware		2	BV3300TVM	\$430

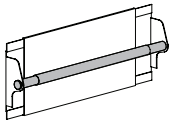

- flat screen mounting hardware ONLY
- black metal
- mount is tilt adjustable, built-in level, wire management and safety lock bar

Description	D	W	H	CTN WT	CU FT	① Model	Flat Cut List Price	Double Cut List Price
30" w Media Wall Cabinet	6	30	50	63	8	BV3006-50MWR	\$2,890	\$3,179
	6	30	50	63	8	BV3006-50MWL	\$2,890	\$3,179

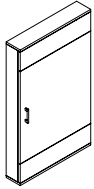

right shown

- use above 30" w media cabinet
- door conceals markerboard writing surface

24" w Media Wall Cabinet	6	24	50	50	7	BV2406-50MWR	\$2,789	\$3,067
	6	24	50	50	7	BV2406-50MWL	\$2,789	\$3,067

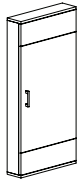

right shown

- use above 24" w media cabinet
- door conceals markerboard writing surface

**To Order, Specify:**

- ① Model Number
- ② Wood Species - Cherry (CH1), Maple (MA1) or Walnut (WA1) or Double Cut (DC1) (see page 206)
- ③ Finish Color (see page 206)
- ④ Metal Color (see page 206)
- ⑤ Pull Color (see page 206)



**Brogan Modular**



Shells . . . . . 244  
 Corner Unit . . . . . 245  
 Peninsula Shell Applications . . . . . 245  
 Bridge Applications . . . . . 245  
 Modular Pedestals . . . . . 246  
 Modular Drawers . . . . . 247

## Brogan Modular - Overview

### Shells

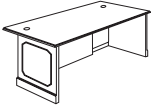

Modular Desk Shell  
with Overhang  
Page 244

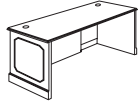

Modular Desk Shell  
Page 244

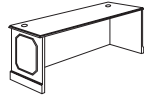

Modular Credenza  
Shell  
Page 244

### Corner Unit



Modular Executive Corner Unit  
Page 245

### Peninsula Shell Applications

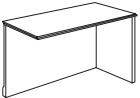

Modular Executive Return Shell  
Page 245

### Bridge Applications

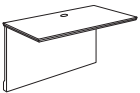

Modular Executive Bridge  
Page 245



## Brogan Modular - Overview

### Components - Modular



25" and 19" Deep Modular  
Box/Box/File Pedestal  
Page 246



25" and 19" Deep Modular  
File/File Pedestal  
Page 246



19" Deep Modular  
Lateral File Pedestal  
Page 246

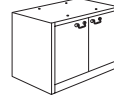

19" Deep Modular  
Storage Cabinet  
Page 246

---

### Drawers

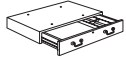

Modular Center Drawer  
Page 247

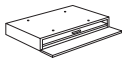

Modular Keyboard Drawer  
Page 247

## Brogan Modular Product Information

### Brogan Modular / Brogan Freestanding

Brogan Modular units are not designed to be attached to models from Brogan, such as desks, bridges, return, credenzas and shells. They are two separate series.

### Exterior Wood Materials

Exterior surfaces are made from the finest selected veneers to achieve clarity and consistency in the Brogan product line. To attain a pleasing, symmetrical pattern, all veneers in Brogan are book-matched. All exterior solid lumber is matched to coordinate with the veneer.

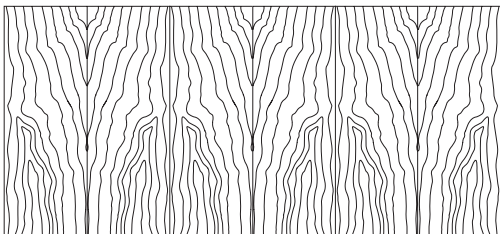

Alternating pieces of veneer are flipped over so they face each other like the pages within a book.

Brogan is available in flat cut cherry and walnut veneer. A wide range of wood stains have been formulated to enhance the beauty of the veneer.

Cherry and Walnut veneer species are available on the  quickship program on select models.

### Work Surface Construction

Tops are 5-ply balanced construction, 1 3/16" thick with solid matching hardwood edges.

Coordinating high pressure laminate in a veneer grain pattern can be applied to the top surface and is available at no additional charge.

Modular Desks, Credenzas, Corner, Returns & Bridges units feature metal threaded inserts in the underside of the top for quick mounting and reconfiguration of modular storage components.

### Case Construction

All construction is a combination of full mortise and tenon, reinforced with screws. Leveling glides are set in solid hardwood to prevent glides tear out.

Outside End Panels are 1 3/16" thick with 3-ply construction and rimmed with veneer bands.

Pedestals are mortise and tenon construction reinforced with screws for increased stability. All modular storage units feature full top panels with holes for mounting to shell inserts.

### Drawer Construction

Drawers are assembled using four corner, dovetailed box and 1/4" thick drawer bottom panel construction with exterior front attached separately. Sides and backs are 9-ply, 7/16" thick unidirectional hardwood. Interiors are sanded and finished with clear catalyzed varnish to protect against shrinking, swelling or warping, and to provide a clean, smooth feel and appearance.

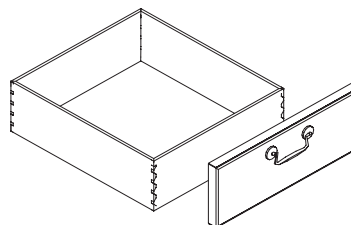

### Drawer Suspension

The high quality black drawer suspensions carry a lifetime warranty. Slides feature steel ball bearings for longer life with cushioned in/out stops. All drawers, including file and box drawers, fully extend past the pedestal chassis allowing full access to the drawer box.

### Filing Hardware

All file drawers are constructed with a custom designed filing system in place to allow for hanging folders.

### Locking

All storage pedestals and cabinets feature front pedestal locking.

Units are shipped randomly keyed as standard. Key alike units are available upon request for no additional charges. Removable cores for in-field re-keying are standard.

# Brogan Modular Product Information

## Finish - Stain/Colors

We offer a variety of wood stains and paint colors on Brogan. Please see the chart below. Samples are available upon request.

<b>CH1 Cherry</b> <i>Flat Cut Veneer</i>	
BRL Barley	EAR Earthy
BBM Bourbon Medium	HRV Harvest*
BRM Brighton Medium	LGC Legacy
CLA Classic	PRL Praline*
CLL Collectors*	SAF Saffron

<b>WA1 Walnut</b> <i>Flat Cut Veneer</i>	
AUB Auburn	SIE Sienna*
ESP Espresso	TOF Toffee
MCH Mocha*	TRF Truffle*
NTO Night Owl*	

\*finishes with coordinating laminate tops.

## Protective Top Coat

DuraTex™ offers exceptional hardness along with abrasion and impact resistance, it has been formulated to eliminate hazardous and harmful gases that are normally associated with wood finish.

## DuraTex™ Features

- Safety - Significantly reduces hazardous formaldehyde emissions, which help improve the quality of the of the indoor air we breathe.
- Quality - Developed to be tough and durable with special attention to appearance. The DuraTex™ finish preserves the natural beauty of wood.
- Durability - Designed to meet a wide range of demanding performance and environmental standards to withstand even the highest wear and tear.

## Product Modification

### Laminate Tops

Work surface only, no additional upcharge if Brogan's coordinating wood grain laminate is specified. Contact Customer Service for any other laminate request. Listed below are finishes that have coordinating wood grain HPL laminates.

Cherry Finishes	Walnut Finishes
Collectors	Mocha
Harvest	Night Owl
Praline	Sienna
	Truffle

### Special Finishes

Special finishes can be requested by following the instruction in the general introduction section, page 5. There is a one time charge of \$332 list per order.

### Special Veneer

Upon request standard veneer can be changed to a special veneer contact Customer Service for availability and pricing.

## Product Modification

### Trim Molding

Angled Trim molding is standard on all Brogan products.

Without molding or Scalloped Trim molding can be specified at the time of order placement.

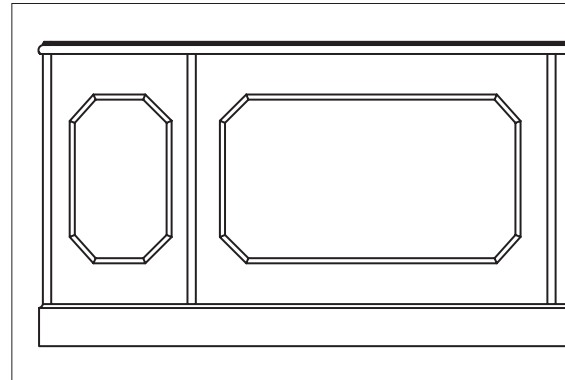

**Angled Trim**  
standard

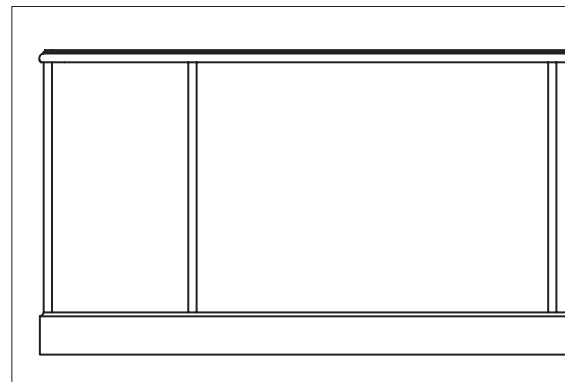

**Base Molding Only** (without trim)  
optional at no charge

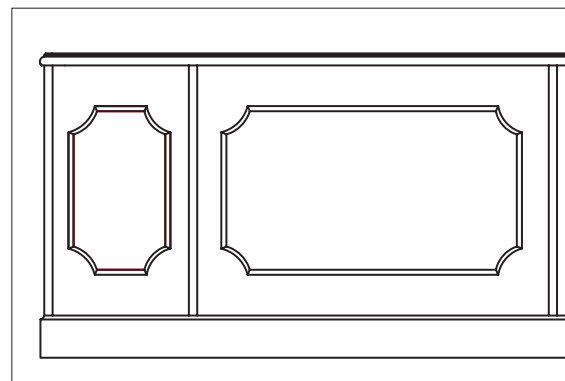

**Scalloped Trim**  
optional with upcharge to list for each item  
\$130 for all desk shells  
\$67 for all other product with standard trim molding

# Brogan Modular Product Information

## Edge and Hardware

Brogan offers a traditional edge profile and two drawer pulls. Hardware is available in antique brass or antique pewter.

### Edge Profile

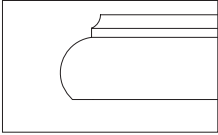

**Brogan Edge Profile**  
Accepts Laminate Top

### Drawer Hardware

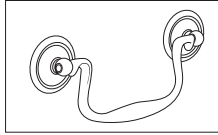

**Brogan Hardware**  
Antique Brass (ANB)  
Antique Pewter (ANP)

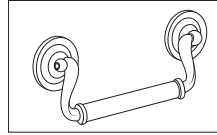

**Gala Hardware**  
Antique Brass (ANB)  
Antique Pewter (ANP)

## Worksurface Grommets

Worksurface grommets are standard on all modular shells. Additional worksurface grommets can be specified in different location on veneer/laminate work-surfaces. The grommet location must be approved by JSI manufacturing, contact Customer Service.

Add \$99 to the list for each additional grommet.

Models with an Antique Brass pull will receive an Antique Brass grommet, those with an Antique Pewter pull will receive a Black grommet.

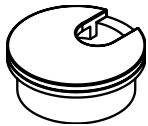

Antique Brass  
Black

## 3-Piece Leather Inlay

Brogan Modular can be enhanced with a 3-Piece Leather Inlay, which may be added to the worksurface on the modular desk shells for a \$2,225 list price upcharge.

Models  
BG3672MD  
BG3066MD



**Cortina Leather Options**  
Caprone  
Old English

Leather Inlay is limited to specific style and thickness of leather. Call Customer Service for more information. Visit [jsifurniture.com](http://jsifurniture.com) for leather colors.

## Brogan Modular Product Information

### Finish and Product Reference Codes

Select	Code
--------	------

#### Veneer

Cherry	CH1
Walnut	WA1

#### Finish

##### Cherry Finishes

Barley	BRL
Bourbon Medium	BBM
Brighton Medium	BRM
Classic	CLA
Collectors	CLA
Earthy	EAR
Harvest	HRV
Legacy	LGC
Praline	PRL
Saffron	SAF

##### Walnut Finishes

Auburn	AUB
Espresso	ESP
Mocha	MCH
Night Owl	NTO
Sienna	SIE
Toffee	TOF
Truffle	TRF

#### Laminate Coordinates

##### Cherry Finishes

Collectors	CLL
Harvest	HRV
Praline	PRL

##### Walnut Finishes

Mocha	MCH
Night Owl	NTO
Sienna	SIE
Truffle	TRF

Select	Code
--------	------

#### Top Edge Profile

Traditional Edge

#### Pull/Hardware Finish

Brogan

Antique Brass	ANB
Antique Pewter	ANP

Gala

Antique Brass	ANB
Antique Pewter	ANP

#### Molding Trim

Angled Trim

Base Molding Only

Scalloped Trim

*see page 29 price add-on*

#### Top Grommet Finish

2" dia. Antique Brass

2" dia. Black

Description	D	W	H	CTN WT	CU FT	① Model	List Price
-------------	---	---	---	-----------	----------	---------	------------

<b>Modular Desk Shell</b>	36	72	30	208	52	<b>BG3672MD</b>	<b>\$3,163</b>
---------------------------	----	----	----	-----	----	-----------------	----------------

**NOW!**

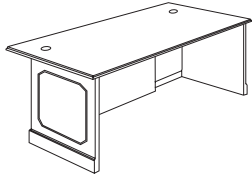

- two surface grommets standard
- can be freestanding or part of L or U configuration
- can't be used with regular Brogan
- metal threaded inserts for pedestal and drawer installation
- desk shell ships assembled
- 3-piece leather inlay available, specify and add \$2,225 list
- optional pedestals and drawers sold separately, see pages 246-247
- 6" overhang on approach side
- chassis - 30" x 72"
- 68 1/8" inside dimension

<b>Modular Desk Shell</b>	30	66	30	175	42	<b>BG3066MD</b>	<b>\$3,007</b>
---------------------------	----	----	----	-----	----	-----------------	----------------

**NOW!**

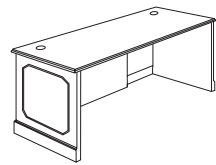

- two surface grommets standard
- can be freestanding or part of L or U configuration
- can't be used with regular Brogan
- metal threaded inserts for pedestal and drawer installation
- desk shell ships assembled
- 3-piece leather inlay available, specify and add \$2,225 list
- optional pedestals and drawers sold separately, see pages 246-247
- 62 1/8" inside dimension

<b>Modular Credenza Shell</b>	24	72	30	161	32	<b>BG2472MC</b>	<b>\$2,697</b>
-------------------------------	----	----	----	-----	----	-----------------	----------------

**NOW!**

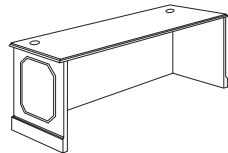

- two surface grommets standard
- can be freestanding or part of L or U configuration
- can't be used with regular Brogan
- metal threaded inserts for pedestal and drawer installation
- credenza shell ships assembled
- optional pedestals and drawers sold separately, see pages 246-247
- 68 1/8" inside dimension for BG2472MC
- 62 1/8" inside dimension for BG2466MC

Description	D	W	H	CTN WT	CU FT	① Model	List Price
<b>Modular Executive Corner Unit</b>	42	42	30	150	40	<b>BG4242MEC</b>	<b>\$2,959</b>
<b>NOW!</b>	36	36	30	130	29	<b>BG3636MEC</b>	<b>\$2,726</b>

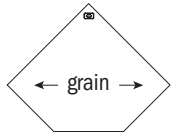

- angle grain direction on tops
- one surface grommet standard
- cannot be used as a freestanding unit
- corner units ships assembled
- optional keyboard and center drawer sold separately, see page 247
- not for use with regular Brogan

<b>Modular Shell Executive Return</b>	24	48	30	92	11	<b>BG2448MR</b>	<b>\$1,745</b>
<b>NOW!</b>	24	42	30	85	10	<b>BG2442MR</b>	<b>\$1,636</b>

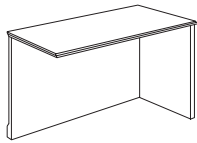

- one modesty grommet standard
- long grain direction
- metal threaded inserts for pedestal and drawer installation
- return units ship KD
- optional pedestals and drawers sold separately, see pages 246-247
- non-handed construction for left or right return applications
- not for use with regular Brogan

<b>Modular Executive Bridge</b>	24	48	30	70	4	<b>BG2448MEB</b>	<b>\$1,648</b>
<b>NOW!</b>	24	42	30	65	3	<b>BG2442MEB</b>	<b>\$1,517</b>
	24	36	30	60	3	<b>BG2436MEB</b>	<b>\$1,419</b>

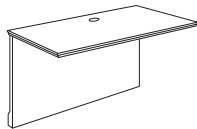

- one surface grommet standard
- one modesty panel grommet standard
- long grain direction
- metal threaded inserts for drawer installation
- bridge units ship KD
- optional keyboard and center drawers sold separately, see page 247
- not for use with regular Brogan

**To Order, Specify:**

- ① Model Number
- ② Wood Species - Cherry (CH1) or Walnut (WA1) (see page 243)
- ③ Finish Color (see page 243)
- ④ Other Product Options (see page 242)
- ⑤ Accessories, Power and Data (see pages 519-535)

When ordering Quickship products, place a "Q" in front of model number.  
Example: QBG3672MD

**NOW!**  
*Need it.*  
JSI Quickship

Description	D	W	H	CTN WT	CU FT	① Model	List Price
Modular Box/Box/File Pedestal	24 ½	15 ½	28 ½	103	9	BG1625MBBF	\$1,706

**NOW!**



- box/box/file pedestal
- insert mount to top of modular desk shells
- letter width pedestal
- pedestal front locking
- coordinates with 30" deep shell
- not for use with regular Brogan

Modular Box/Box/File Pedestal	19	15 ½	28 ½	82	7	BG1619MBBF	\$1,493
-------------------------------	----	------	------	----	---	------------	---------

**NOW!**



- box/box/file pedestal
- insert mount to top of modular shells
- letter width pedestal
- pedestal front locking
- coordinates with 24" deep shell
- not for use with regular Brogan

Modular File/File Pedestal	24 ½	15 ½	28 ½	103	9	BG1625MFF	\$1,706
----------------------------	------	------	------	-----	---	-----------	---------

**NOW!**



- file/file pedestal
- insert mount to top of modular desk shells
- letter width pedestal
- pedestal front locking
- coordinates with 30" deep shell
- not for use with regular Brogan

Modular File/File Pedestal	19	15 ½	28 ½	82	7	BG1619MFF	\$1,493
----------------------------	----	------	------	----	---	-----------	---------

**NOW!**



- file/file pedestal
- insert mount to top of modular shells
- letter width pedestal
- pedestal front locking
- coordinates with 24" deep shell
- not for use with regular Brogan

Modular Lateral File Pedestal	19	34 ¾	28 ½	160	15	BG3519MLF	\$2,224
-------------------------------	----	------	------	-----	----	-----------	---------

**NOW!**

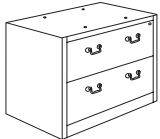

- insert mount to top of modular shells
- pedestal front locking
- coordinates with 24" deep shell
- two units will not fit in credenza shell
- not for use with regular Brogan



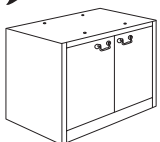

Modular Storage Cabinet	19	34 ¾	28 ½	105	15	BG3519MSC	\$1,454
-------------------------	----	------	------	-----	----	-----------	---------

**NOW!**

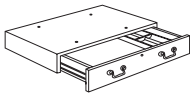

- insert mount to top of modular shells
- locking doors available, specify and add \$123 list
- coordinates with 24" deep shell
- two units will not fit in credenza shell
- not for use with regular Brogan

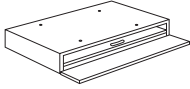

Description	D	W	H	CTN WT	CU FT	① Model	List Price
<b>Modular Center Drawer</b> 	18	24	4 ¾	30	2	BG2416MCD	\$558
 <ul style="list-style-type: none"> <li>• insert mount to top of modular shells, 42" corner units, returns or bridge units</li> <li>• front locking</li> <li>• not for use with regular Brogan</li> </ul>							
<b>Modular Keyboard Drawer</b> 	18	26	4 ¾	28	3	BG2616MKD	\$752
 <ul style="list-style-type: none"> <li>• insert mount to top of modular shells, 42" corner units, returns or bridge units</li> <li>• front locking</li> <li>• not for use with regular Brogan</li> </ul>							

### To Order, Specify:

- ① Model Number
- ② Wood Species - Cherry (CH1) or Walnut (WA1) (see page 243)
- ③ Finish Color (see page 243)
- ④ Pull Style and Color (see page 243)
- ⑤ Other Product Options (see page 242)

When ordering Quickship products, place a "Q" in front of model number.  
 Example: QBG3672MD

**NOW!**  
*Need it.*  
 JSI Quickship





Desks . . . . .	268
Modesty Panels . . . . .	271, 273
Returns and Bridges . . . . .	274
Credenzas . . . . .	276
Modular Pedestals . . . . .	278
Overhead Cabinets . . . . .	280
Wall Mount Storage . . . . .	283
Tackboards . . . . .	283
Transaction Counters . . . . .	284
Bookcases . . . . .	285
Lateral Files . . . . .	286
Storage Cabinets . . . . .	287
Freestanding Tables . . . . .	288

# Brogan - Overview

## Desks

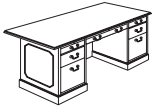

Executive Double Pedestal Desk  
Page 268

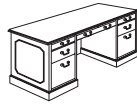

Double Pedestal Desk  
Page 268



Table Desk  
Page 269



Electric Adjustable Height Table Desk  
Page 270



Pneumatic Adjustable Height Table Desk  
Page 270

## Desk Applications

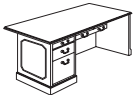

Single Pedestal Desk  
Page 272

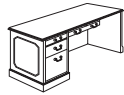

Single Pedestal Desk  
Page 272

## Peninsula Desks

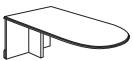

Bullet Peninsula Desk  
Page 273



P-Top Peninsula Desk  
Page 273

## Peninsula Desk Bases and Modesty Panels



Column Base  
Page 273

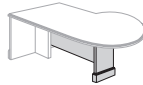

3/4 Modesty Panel  
Page 273

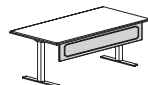

Adjustable Table Modesty Panel  
Page 271

## Return and Corner Unit Applications

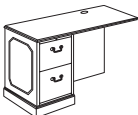

File/File Return  
Page 274



Lateral File Return  
Page 274

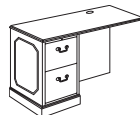

File/File Corner  
Page 275



Lateral File Corner Return  
Page 275



Corner Unit  
Page 274

## Bridge Applications

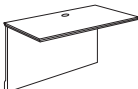

Executive Bridge  
Page 275

## Brogan - Overview

### Credenzas

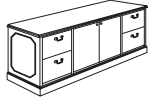

Storage Credenza  
Page 276

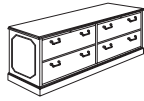

Lateral File Credenza  
Page 276

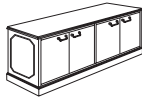

Four Door Credenza  
Page 276



Two Door Credenza  
Page 276

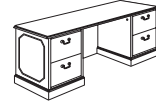

Kneespace Credenza  
Page 276

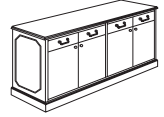

Buffet Credenza  
Page 276

### Credenza Applications

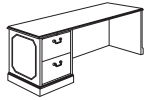

File/File Pedestal  
Credenza  
Page 277

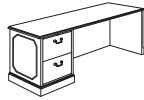

File/File Reception  
Pedestal Credenza  
Page 277

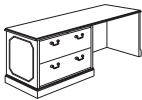

Lateral File Pedestal  
Credenza  
Page 277



Multi-File Pedestal  
Credenza  
Page 277

### Modular Applications

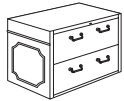

Modular Lateral File  
Page 278

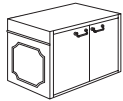

Modular Storage Cabinet  
Page 278

### Credenza Tops and Bases



Modular Credenza Tops  
Page 278



Modular Credenza Bases  
Page 278

### Modular Bookcases

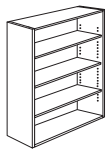

Modular Open Bookcase  
Page 279

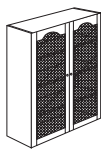

Modular Grille Door Bookcase  
Page 279

### Modular Bookcase Tops



Modular Bookcase Tops  
Page 279

# Brogan - Overview

## Overhead Cabinets



Open Storage Overhead Cabinet  
Page 280



Storage Overhead Cabinet with Four Doors  
Page 280



Storage Overhead Cabinet with Clear Glass  
Page 282

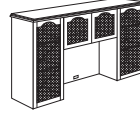

Storage Overhead Cabinet with Glass/Grille  
Page 282

## Tackboards



Tackboard for Storage Overhead Cabinet  
Pages 280-281

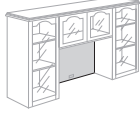

Tackboard for Storage Overhead Cabinet  
Page 282

## Wall Mount Storage

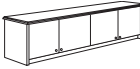

Wall Mount Overhead with Four Doors  
Page 283

## Tackboards

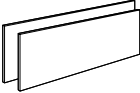

Wall Mount Tackboards  
Page 283

## Transaction Counters

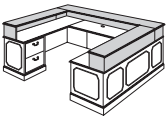

Transaction Counter for U Unit  
Page 284

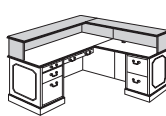

Transaction Counter for L Unit  
Page 284

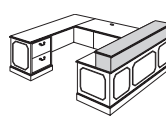

Transaction Counter  
Page 284

## Bookcases

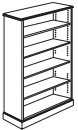

Bookcase  
Page 285

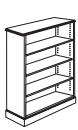

Bookcase  
Page 285



Bookcase  
Page 285

## Lateral Files



Lateral File  
Page 286



Lateral File  
Page 286

# Brogan - Overview

## Storage Cabinets

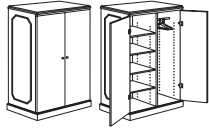

Wardrobe  
Page 287



Hanging Bar to Shelves  
Conversion Kit  
Page 287

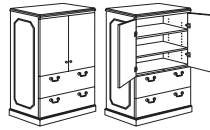

File/File Lateral  
Storage Cabinet  
Page 287

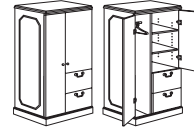

File/File Storage  
Wardrobe  
Page 287

## Printer Stand



Printer Stand  
Page 288

## Corner Unit



Corner Unit  
Page 288

## Tables



Sofa Table  
Page 289



Magazine Table  
Page 289



End Table  
Page 289



End Table  
Page 289

## Optional Center Drawer

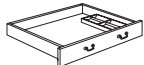

Center Drawer  
Page 289

## Task Lights

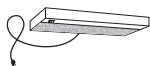

48" w Task Light  
Page 532



24" w Task Light  
Page 532



31" w LED Starter  
Task Light  
Page 532



31" w LED Linking  
Adder Task Light  
Page 532



17" w LED Starter  
Task Light  
Page 533



17" w LED Linking  
Adder Task Light  
Page 533



Motion Sensor  
for Task Lights  
Page 533

# Brogan Product Information

## Exterior Wood Materials

Exterior surfaces are made from the finest selected veneers to achieve clarity and consistency in the Brogan product line. To attain a pleasing, symmetrical pattern, all veneers in Brogan are book-matched. All exterior solid lumber is matched to coordinate with the veneer.

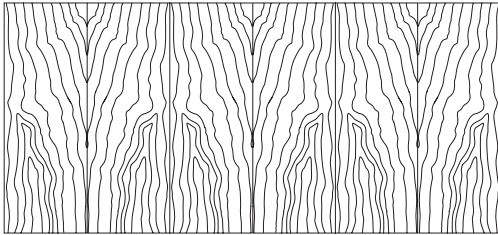

Alternating pieces of veneer are flipped over so they face each other like the pages within a book.

Brogan is available in flat cut cherry and walnut veneer. A wide range of wood stains have been formulated to enhance the beauty of the veneer.

Cherry and Walnut veneer species are available on the **NOW!** quickship program on select models.

## Work Surface Construction

Tops are 5-ply balanced construction, 1 3/16" thick with solid matching hardwood edges.

Coordinating high pressure laminate in a veneer grain pattern can be applied to the top surface and is available at no additional charge.

## Case Construction

All construction is a combination of full mortise and tenon, reinforced with screws. Leveling glides are set in solid hardwood to prevent glides tear out.

Outside End Panels are 1 3/16" thick with 3-ply construction and rimmed with veneer bands.

## Drawer Construction

Drawers are assembled using four corner, dovetailed box and 1/4" thick drawer bottom panel construction with exterior front attached separately. Sides and backs are 9-ply, 7/16" thick unidirectional hardwood. Interiors are sanded and finished with clear catalyzed varnish to protect against shrinking, swelling or warping, and to provide a clean, smooth feel and appearance.

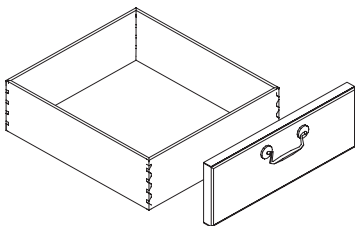

## Drawer Suspension

The high quality black drawer suspensions carry a lifetime warranty. Slides feature steel ball bearings for longer life with cushioned in/out stops. All drawers, including file and box drawers, fully extend past the pedestal chassis allowing full access to the drawer box.

## Filing Hardware

All file drawers are constructed with a custom designed filing system in place to allow for hanging folders. Filing diagram on pages 262-263.

## Locking

All desk, and lateral files feature central locking. Credenza and returns feature pedestal locking.

Units are shipped randomly keyed as standard. Key alike units are available upon request for no additional charges. Removable cores for in-field re-keying are standard.

## Finish - Stain/Colors

We offer a variety of wood stains and paint colors on Brogan. Please see the chart below. Samples are available upon request.

<b>CH1 Cherry</b>		<i>Flat Cut Veneer</i>	
BRL Barley	EAR Earthy		
BBM Bourbon Medium	HRV Harvest*		
BRM Brighton Medium	LGC Legacy		
CLA Classic	PRL Praline*		
CLL Collectors*	SAF Saffron		

<b>WA1 Walnut</b>		<i>Flat Cut Veneer</i>	
AUB Auburn	SIE Sienna*		
ESP Espresso	TOF Toffee		
MCH Mocha*	TRF Truffle*		
NTO Night Owl*			

**\*finishes have coordinating laminate top**

## Protective Top Coat

DuraTex™ offers exceptional hardness along with abrasion and impact resistance, it has been formulated to eliminate hazardous and harmful gases that are normally associated with wood finish.

## DuraTex™ Features

**Safety** - Significantly reduces hazardous formaldehyde emissions, which help improve the quality of the indoor air we breathe.

**Quality** - Developed to be tough and durable with special attention to appearance. The DuraTex™ finish preserves the natural beauty of wood.

**Durability** - Designed to meet a wide range of demanding performance and environmental standards to withstand even the highest wear and tear.



# Brogan Product Information

## Product Modification

### Laminate Tops

Work surface only, no additional upcharge if Brogan's coordinating wood grain laminate is specified. Contact Customer Service for any other laminate request. Listed below are finishes that have coordinating wood grain HPL laminates.

Cherry Finishes	Walnut Finishes
Collectors	Mocha
Harvest	Night Owl
Praline	Sienna
	Truffle

### Special Finishes

Special finishes can be requested by following the instruction in the general introduction section, page 5. There is a one time charge of \$332 list per order.

### Special Veneer

Upon request standard veneer can be changed to a special veneer contact Customer Service for availability and pricing.

### Pedestal Configuration Change

Writing shelf-tray-box-file drawer configuration standard on desk pedestals. Desk pedestal only can be switched out to a file-file configuration. Must be specified at the time of order with an additional \$178 list per pedestal.

Changing to a file-file pedestal configuration will eliminate the writing shelf (arm slide).

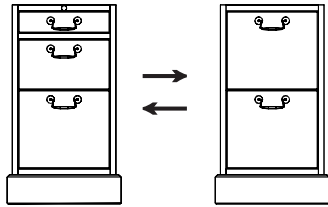

### Desk Dictation Slide

The approach side of the desk in the center break front area has an option of a center pullout dictation slide. Add \$430 to the list price of the desk.

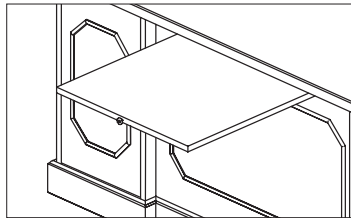

## Product Modification

### Trim Molding

Angled Trim molding is standard on all Brogan products.

Without molding or Scalloped Trim molding can be specified at the time of order placement.

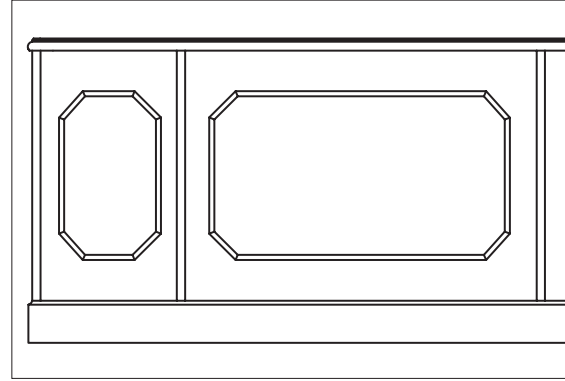

**Angled Trim**  
standard

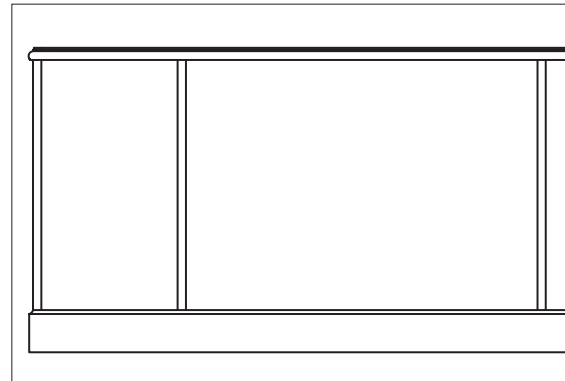

**Base Molding Only** (without trim)  
optional at no charge

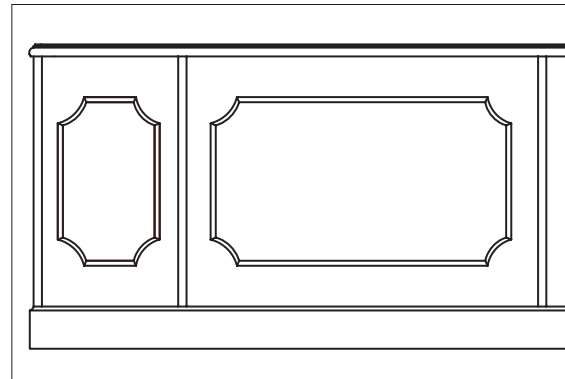

### Scalloped Trim

optional with upcharge to list for each item

\$130 for all desk

\$67 for all other product with standard trim molding

## Brogan Product Information

BROGAN

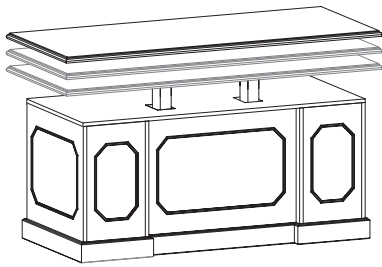

### ERGO Adjustable Work Height Mechanism

Our proprietary adjustable work height mechanism can be specified on many of the models in Brogan.

ERGO mechanism allows height adjustability to be added to the worksurface. Our solution uses a standardized design that minimizes the modifications required to standard desk, bridge, or credenza models. The mechanism and control box are neatly concealed to maintain the appearance of the original elegance of the product. A push button activates the electric powered lifting columns for adjustability from sitting height to a standing height. A  $\frac{3}{4}$ " thick finished sub top is added to the top of the desk chassis for a clean appearance when the surface is in the raised position. In the lowered position, please note that ERGO adds  $\frac{3}{4}$ " to the standard height of the desk and the installation will decrease kneespace depth by 8".

Automatic Collision Control is built into each mechanism as a standard feature. When the system senses an obstacle obstructing the movement, the mechanism will reverse direction and retreat by 1".

When ERGO is added to a desk worksurface in a "L" or "U" group, the unit that connects to the desk also needs to have a sub top added. These units are considered to be ERGO ADJACENT units. ERGO ADJACENT units must have a fixed height worksurface that matches the lowest position of the ERGO mechanism and the top. This is accomplished by adding a  $\frac{3}{4}$ " sub top between the chassis and the worksurface. This feature can also be specified for cabinets which may sit next to a unit with the ERGO mechanism.

Height adjustment starts at 30  $\frac{3}{4}$ ", to a standing height of 50  $\frac{1}{4}$ ", a range of 19  $\frac{1}{2}$ ".

To specify the unit that has the mechanism, add **ERGO** to the end of the model number.  
To specify the connecting or adjacent units add, **ERGO ADJACENT** to the end of the model number.

**Note:** The kneespace depth is decreased when the ERGO mechanism is specified. Contact Customer Service for dimension information.

The Ergo mechanism and controls are warranted for a period of (1) year. The rest of the casegood unit(s) are warranted under the normal fifteen (15) year warranty.

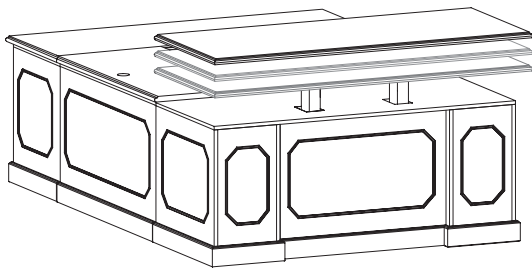

Example

BG3672LD-ERGO	add \$4,223 to list
BG2448EB-ERGO ADJACENT	add \$542 to list
BG2472RC-ERGO ADJACENT	add \$635 to list

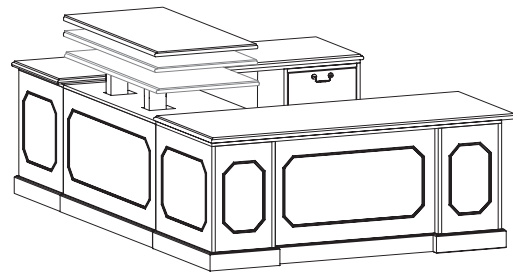

Example

BG3672LD-ERGO ADJACENT	add \$635 to list
BG2448EB-ERGO	add \$4,223 to list
BG2472RC-ERGO ADJACENT	add \$635 to list

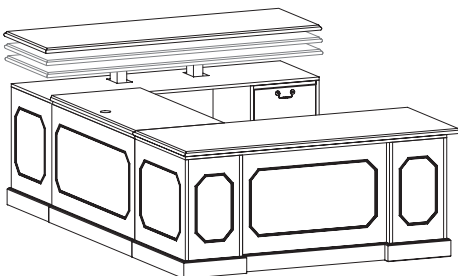

Example

BG3672LD-ERGO ADJACENT	add \$635 to list
BG2448EB-ERGO ADJACENT	add \$542 to list
BG2472RC-ERGO	add \$4,223 to list

## Brogan Product Information

### Availability of Brogan Units with the Mechanism

The following models are available with the ERGO Adjustable Work Height Mechanism. When specifying add "ERGO" to the end of the model number.

**Adjacent Connecting Units** - Models below require adjacent products to create "L" or "U" layouts; add \$4,223 to the list price.

#### Single Pedestal Desk

BG3672LD  
BG3672RD  
BG3072LD  
BG3072RD  
BG3066LD  
BG3066RD

#### Bridges

BG2448EB  
BG2442EB  
BG2436EB

#### Credenzas

BG2472LC  
BG2472RC  
BG2466LC  
BG2466RC

#### Returns

BG2448ELCR  
BG2448ERCR  
BG2448ELR  
BG2448ERR  
BG2442ELCR  
BG2442ERCR  
BG2442ELR  
BG2442ERR

#### Corner Units

BG4242CU  
BG4242ELCU  
BG4242ERCU

**Freestanding Units** - Models below do not require adjacent products; add \$4,223 to the list price.

#### Double Pedestal Desk

BG4284ED  
BG4278ED  
BG3672ED  
BG3672DD  
BG3072DD  
BG3066DD  
BG3060DD

#### Credenzas

BG2472KC  
BG2466KC

### Connecting or Adjacent Units to Match Starting Height

All the units listed above can be specified as connecting or adjacent units. Other Brogan units could also be used as connecting units. Please contact Customer Service for additional items and pricing. When specifying, please add "ERGO ADJACENT" to the end of the model number.

Pricing for Standard Connecting or Adjacent Units

Tops larger than 24" x 48" add \$635 to the list price.

Tops 24" x 48" or smaller add \$542 to the list price.

# Brogan Product Information

## Edge and Hardware

Brogan offers a traditional edge profile and three drawer pulls. Hardware is available in antique brass or antique pewter.

### Edge Profile

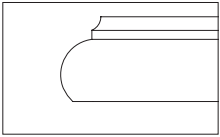

**Brogan Edge Profile**  
Accepts Laminate Top

### Drawer Hardware

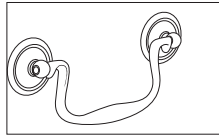

**Brogan Hardware**  
Antique Brass (ANB)  
Antique Pewter (ANP)

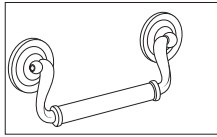

**Gala Hardware**  
Antique Brass (ANB)  
Antique Pewter (ANP)

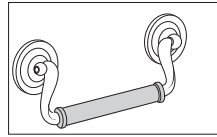

**Gala Leather Wrapped Hardware**  
Antique Brass (ANB)  
Antique Pewter (ANP)

Optional matching leather wrapped pulls available for desk with leather inlay or other coordinating units. Specify leather wrapped pulls, add \$52 list upcharge per pull. Indicate Antique Brass (ANB) or Antique Pewter (ANP) pull.

## Worksurface Grommets

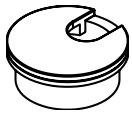

**Worksurface Grommet**  
Antique Brass (ANB)  
Black (BLK)

Worksurface grommets are standard on bridges, corner units, returns and the backs of overheads. Additional worksurface grommets can be specified on desks, credenzas, and other types of veneer/laminate worksurfaces. The grommet location must be approved by JSI manufacturing, contact Customer Service.

Add \$99 to the list for each additional grommet.

Models with an Antique Brass pull will receive an Antique Brass grommet, those with an Antique Pewter pull will receive a Black grommet.

### BG4284ED

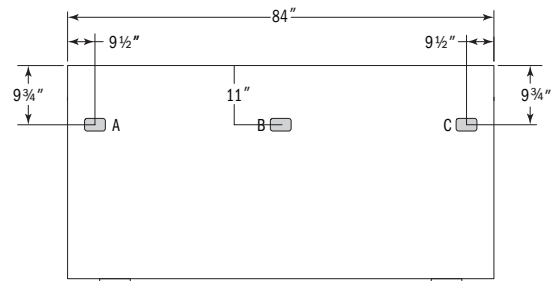

### BG4278ED and BG3672ED

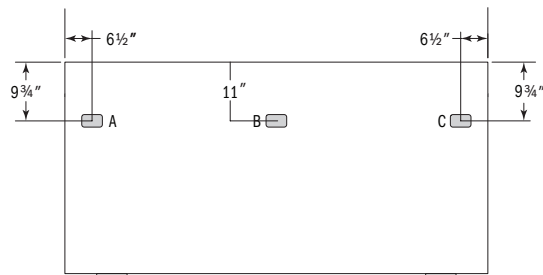

### BG3672RD and BG3672LD



# Brogan Product Information

## Grommet and Color Options Continued

### Desk without Overhang

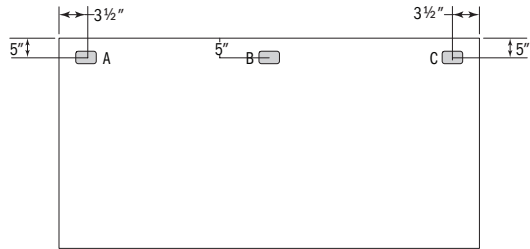

### Support End and Run-Off Desks

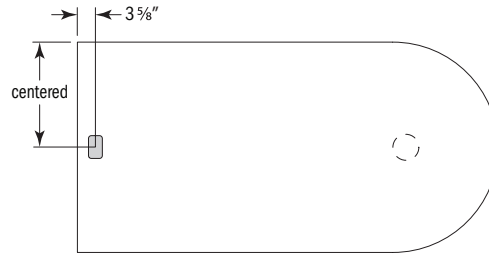

### Bridges, Returns and Credenzas

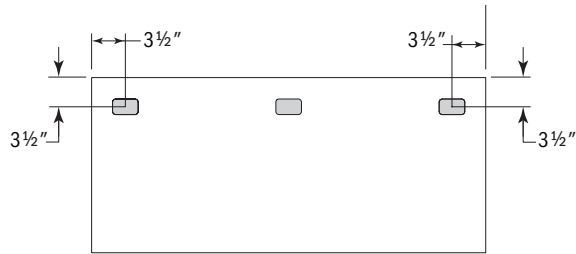

## Brogan Product Information

### Decorative Doors

Brogan offers four overhead cabinet models with two door styles, 72" & 66" wide overhead with clear glass doors and 72" & 66" wide overhead with open glass/grille mesh in two finishes, Antique Brass and Antique Pewter.

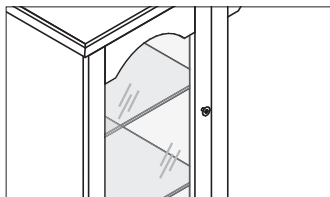

Clear Glass (not low iron)  
with clear glass shelves

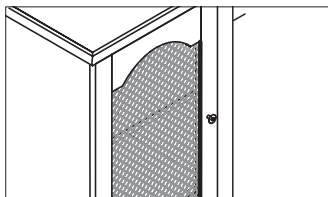

Glass/Grille  
Antique Brass (ANB)  
Antique Pewter (ANP)

### 3-Piece Leather Inlay

Brogan can be enhanced with a 3-Piece Leather Inlay, which may be added to the worksurface of any freestanding desk excluding the adjustable height table desk for a \$2,225 list price upcharge.

#### Models

BG4284ED	BG3672DD	BG3672TD	BG3672RD	BG3066RD
BG4278ED	BG3072DD	BG3066TD	BG3672LD	BG3066LD
BG3672ED	BG3066DD		BG3072RD	
	BG3060DD		BG3072LD	

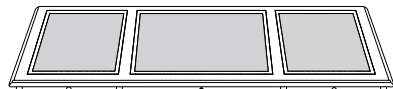

#### Cortina Leather Options

Caprone  
Old English

Leather Inlay is limited to specific style and thickness of leather.  
Call Customer Service for more information.  
Visit [jsifurniture.com](http://jsifurniture.com) for leather colors.

# Brogan Product Information

## Finish and Product Reference Codes

Select	Code
<b>Veneer</b>	
Cherry	CH1
Walnut	WA1

Select	Code
<b>Finish</b>	
Cherry Finishes	
Barley	BRL
Bourbon Medium	BBM
Brighton Medium	BRM
Classic	CLA
Collectors*	CLL
Earthy	EAR
Harvest*	HRV
Legacy	LGC
Praline*	PRL
Saffron	SAF

Walnut Finishes	
Auburn	AUB
Espresso	ESP
Mocha*	MCH
Night Owl*	NTO
Sienna*	SIE
Toffee	TOF
Truffle*	TRF

### \*Laminate Coordinates

Cherry Finishes	
Collectors	CLL
Harvest	HRV
Praline	PRL

Walnut Finishes	
Mocha	MCH
Night Owl	NTO
Sienna	SIE
Truffle	TRF

Select	Code
<b>Top Edge Profile</b>	
Traditional Edge	

Select	Code
<b>Pull/Hardware Finish</b>	
Brogan	
Antique Brass	ANB
Antique Pewter	ANP

Gala	
Antique Brass	ANB
Antique Pewter	ANP

Select	Code
<b>Molding Trim</b>	
Angled Trim	
Base Molding Only	
Scalloped Trim	see page 255 price add-on

Select	Code
<b>Top Grommet Finish</b>	
2" dia. Antique Brass	
2" dia. Black	

# Brogan Product Information

## Standard Filing Option & Interior Drawer Sizes

- Models  
 BG4284ED Desk  
 BG4278ED Desk  
 BG3672ED Desk  
 BG3672DD Desk

	D	W	H
Tray	21"	14 7/8"	1 7/8"
Box	21"	14 7/8"	4 1/4"
File	21"	14 7/8"	9 3/8"

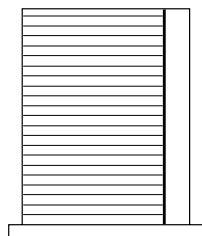

Legal  
Front to Back

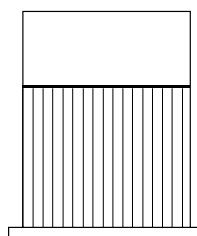

Letter  
Side to Side

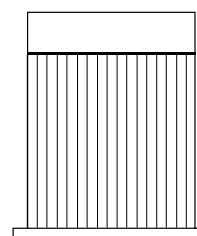

Legal  
Side to Side Only

- Models  
 BG3072DD Desk  
 BG3066DD Desk  
 BG3060DD Desk  
 BG3672RD Desk  
 BG3672LD Desk  
 BG3072RD Desk  
 BG3072LD Desk  
 BG3066RD Desk  
 BG3066LD<sup>1</sup> Desk

	D	W	H
Tray	21"	11 7/8"	1 7/8"
Box	21"	11 7/8"	4 1/4"
File	21"	11 7/8"	9 3/8"

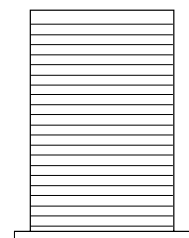

Letter  
Front to Back

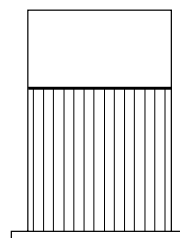

Letter  
Side to Side

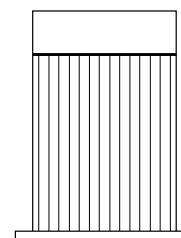

Legal  
Front to Back Only

- Models  
 BG2472SC Storage Credenza  
 BG2466SC Storage Credenza  
 BG2472KC Kneespace Credenza  
 BG2466KC Kneespace Credenza

	D	W	H
File	21"	11 7/8"	9 3/8"

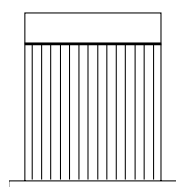

Letter  
Side to Side

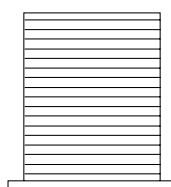

Legal  
Front to Back

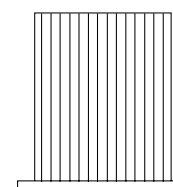

Legal  
Side to Side

- Models  
 BG2472LFC Lateral File Credenza  
 BG3654LF Lateral File Cabinet  
 BG3630LF Lateral File Cabinet

	D	W	H
Lateral File	15 1/4"	31"	9 3/8"

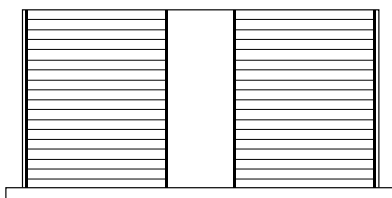

Letter  
Double Front to Back

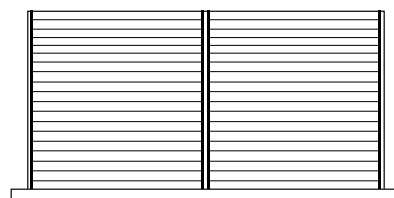

Legal  
Double Front to Back

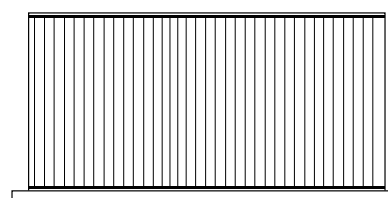

Legal  
Side to Side



# Brogan Product Information

## Models

BG2448ERR	Return
BG2448ELR	Return
BG2448ERCR	Return
BG2448ELCR	Return
BG2442ERR	Return
BG2442ELR	Return
BG2442ERCR	Return
BG2442ELCR	Return
BG2448LRR	Return
BG2448LLR	Return
BG2448LLR	Return
BG2448LRCR	Return
BG2448LLCR	Return
BG3672SWLF	Storage Cabinet
BG2472SWR	Storage Cabinet
BG2472SWL	Storage Cabinet

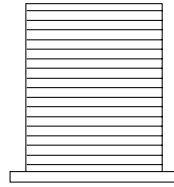

Letter  
Front to Back

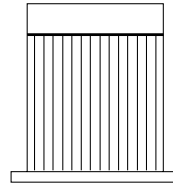

Letter  
Side to Side

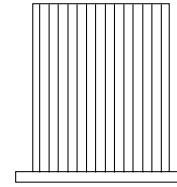

Legal  
Side to Side Only

	D	W	H
File	15 1/4"	11 7/8"	9 3/8"
Lateral	15 1/4"	31"	9 3/8"

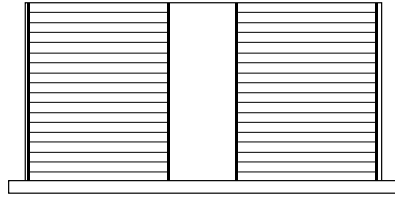

Letter  
Double Front to Back

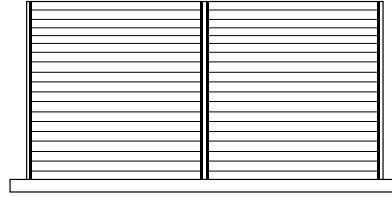

Legal  
Double Front to Back

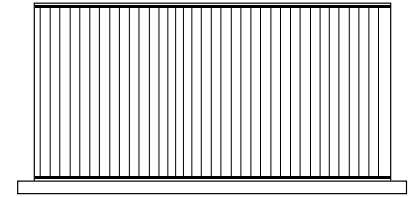

Legal  
Side to Side

## Models

BG2472RC	Credenza
BG2472LC	Credenza
BG2466RC	Credenza
BG2466LC	Credenza
BG2472RCR	Credenza
BG2472LCR	Credenza
BG2472LRC	Credenza
BG2472LLC	Credenza
BG2472MRC	Credenza
BG2472MLC	Credenza

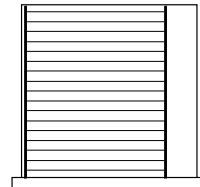

Legal  
Front to Back

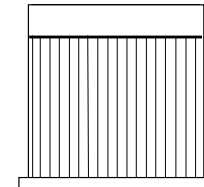

Letter  
Side to Side

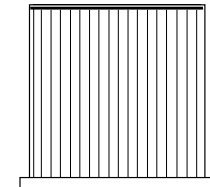

Legal  
Side to Side

	D	W	H
File	15 1/4"	14 7/8"	9 3/8"
Lateral	15 1/4"	31"	9 3/8"

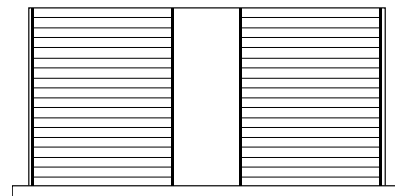

Letter  
Double Front to Back

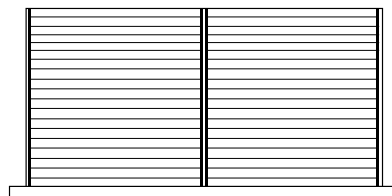

Legal  
Double Front to Back

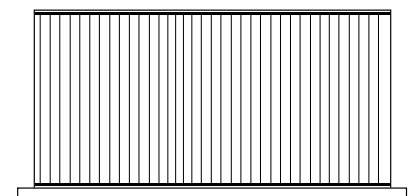

Legal  
Side to Side

## Other Models

BG2472BSC	Buffet Credenza
BG3672TD & BD3066TD	Table Desk
BG1826CDB	Center Drawer

Drawer Type	D	W	H
Box Drawer	15 1/4"	14 3/16"	4 1/4"
Pencil Drawer	19 7/16"	23"	1 7/8"
Pencil Drawer	16"	26"	1 7/8"

## Brogan - Typical

### BG001

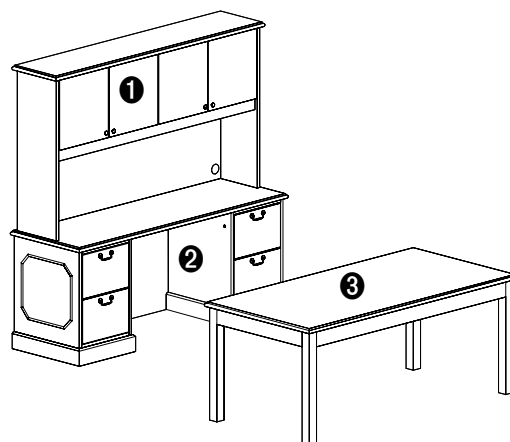
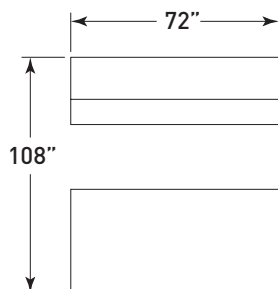

Model	Description	Qty	Price
1 BG1572S0	storage overhead cabinet	1	\$3,202
2 BG2472KC	72"w kneespace credenza, angled molding	1	\$4,000
3 BG3672TD	72"w x 36"d table desk	1	\$3,387
<b>Typical List Price</b>			<b>\$10,589</b>

### BG002

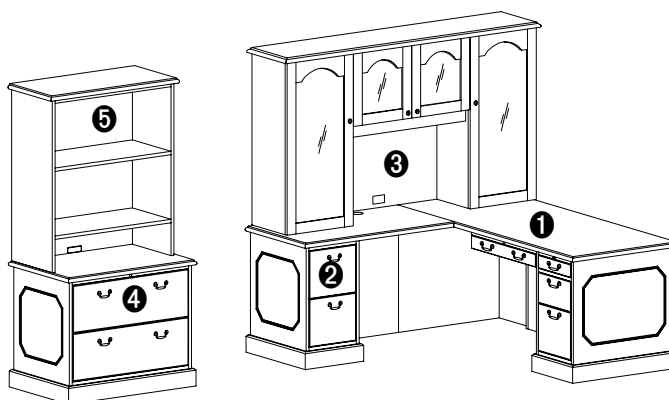
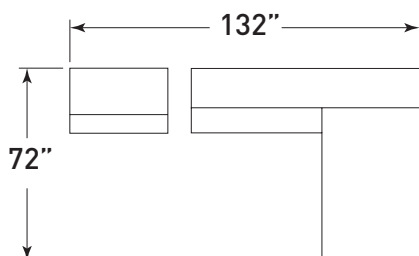

Model	Description	Qty	Price
1 BG3072RD	30"w pedestal desk, right angled molding	1	\$3,939
2 BG2442ELR	42"w executive return, left, angled molding	1	\$2,714
3 BG1572C0	72"w storage overhead cabinet w/ glass doors	1	\$4,536
4 BG3630LF	36"w lateral file, angled molding	1	\$2,620
5 BG1536B0	42"h bookcase overhead	1	\$1,304
<b>Typical List Price</b>			<b>\$15,113</b>

## Brogan - Typical

### BG003

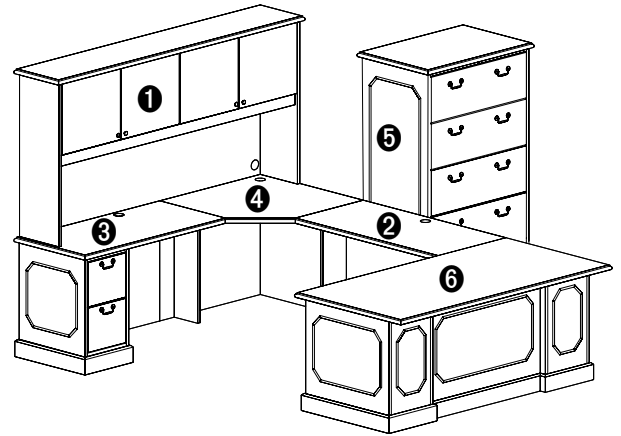
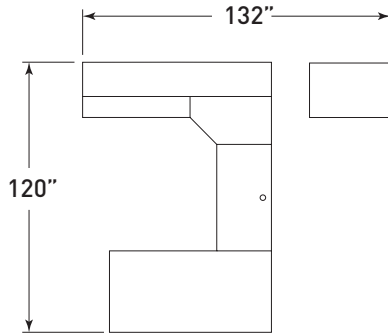

Model	Description	QTY	Price
1 BG1584SO	storage overhead cabinet	1	\$3,330
2 BG2448EB	executive bridge	1	\$1,432
3 BG2448ELR	executive return, left, angled molding	1	\$2,817
4 BG3636ELCU	executive corner unit, left	1	\$2,622
5 BG3654LF	lateral file, angled molding	1	\$3,960
6 BG3672RD	pedestal desk, right, angled molding	1	\$4,075
<b>Typical List Price</b>			<b>\$18,236</b>

### BG004

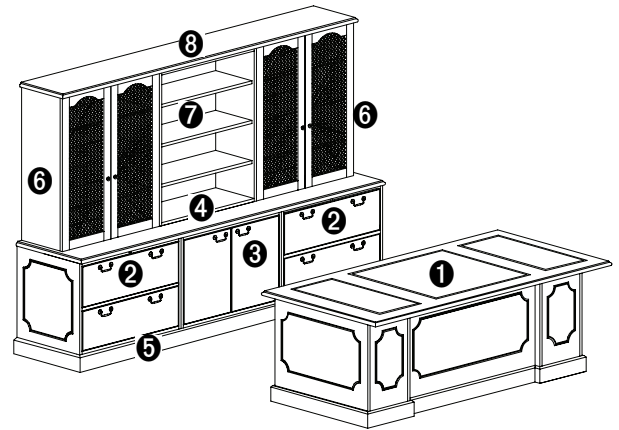
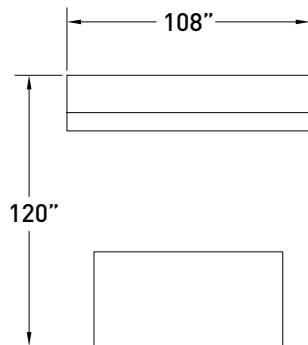

Model	Description	Qty	Price
1 BG4284ED	executive desk with leather inlay, scalloped molding	1	\$8,581
2 BG2436MLF	modular lateral file, scalloped molding	2	\$4,898
3 BG2436MSC	modular storage cabinet	1	\$2,001
4 BG24108MCT	modular credenza top	1	\$1,407
5 BG24108MCB	modular credenza base	1	\$732
6 BG1542MGBC	modular grille door bookcase	2	\$5,184
7 BG1542MBC	modular open bookcase	1	\$1,443
8 BG15108MCT	modular bookcase top	1	\$986
<b>Typical List Price</b>			<b>\$25,232</b>

## Brogan - Typical

### BG005

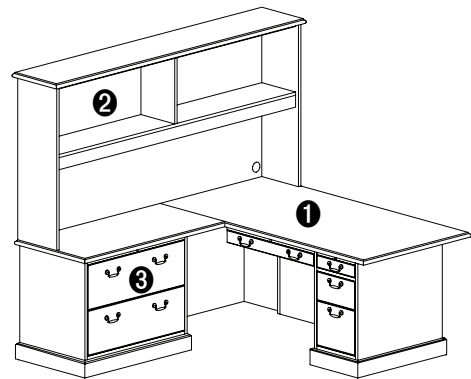
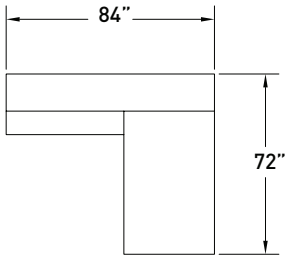

Model	Description	Qty	Price
1 BG3672RD	36"w pedestal desk, right	1	\$4,075
2 BG158400	open storage overhead cabinet	1	\$3,164
3 BG2448LLR	lateral file return, left	1	\$3,431
<b>Typical List Price</b>			<b>\$10,670</b>

### BG006

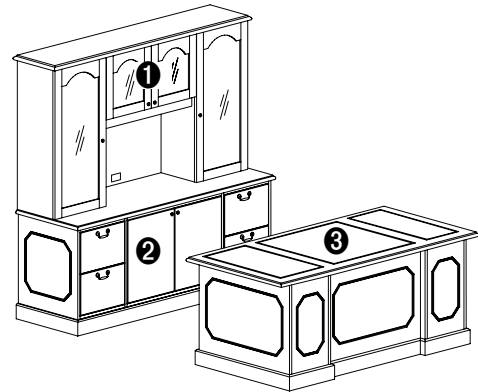
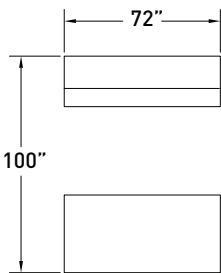

Model	Description	Qty	Price
1 BG1572C0	storage overhead cabinet w/glass doors	1	\$4,536
2 BG2472SC	storage credenza w/hinged doors, angled molding	1	\$4,248
3 BG3672DD	double ped desk with leather inlay, angled molding	1	\$7,020
<b>Typical List Price</b>			<b>\$15,804</b>

### BG007

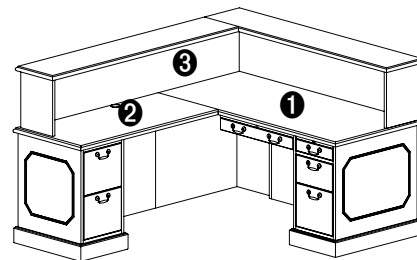
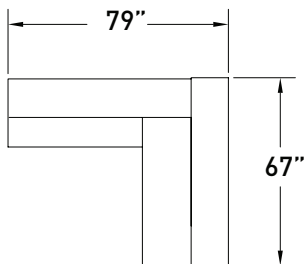

Model	Description	Qty	Price
1 BG3066RD	single pedestal desk, angled molding	1	\$3,803
2 BG2448ELR	executive return, left, angled molding	1	\$2,817
3 BG13114LTC	transaction counter for "L" unit	1	\$1,883
<b>Typical List Price</b>			<b>\$8,503</b>

## Brogan - Typical

### BG008

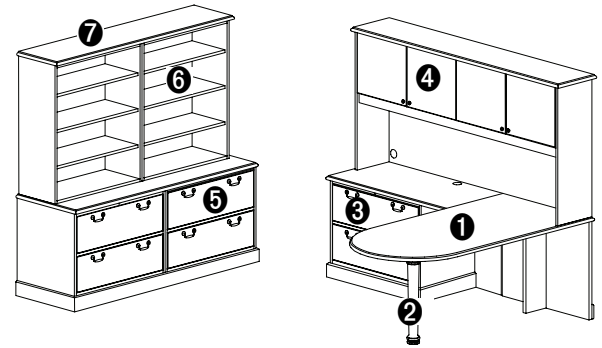
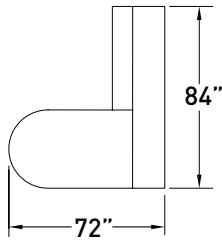
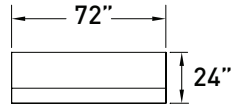

Model	Description	QTY	Price
1	BG3672RB bullet peninsula desk, right	1	\$4,322
2	04WB wood column base	1	\$754
3	BG2448LLR lateral file return, left	1	\$3,431
4	BG1584SO storage overhead cabinet w/four doors	1	\$3,330
5	BG2472LFC lateral file credenza	1	\$4,419
6	BG1542MBC modular open bookcase	2	\$2,886
7	BG1572MCT modular bookcase top	1	\$666
<b>Typical List Price</b>			<b>\$19,808</b>

### BG009

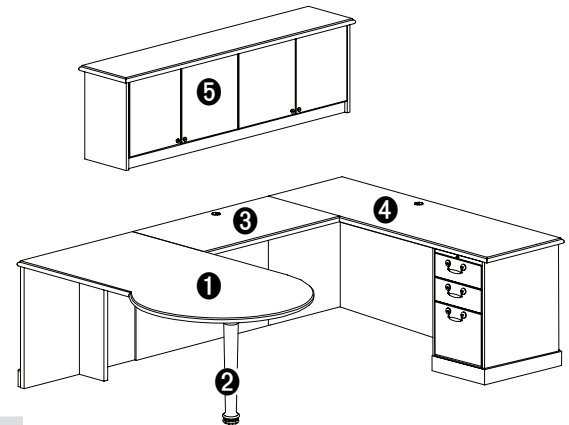
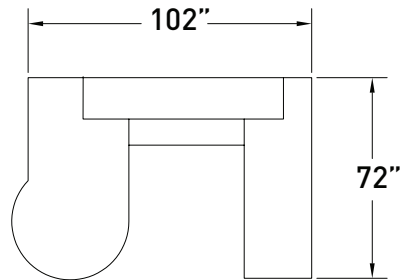

Model	Description	QTY	Price
1	BG4272LP p-top peninsula desk, left	1	\$4,331
2	04WB wood column base	1	\$754
3	BG2442EB executive bridge	1	\$1,320
4	BG2472RC pedestal credenza, right	1	\$3,662
5	BG1572WSO wall mount overhead w/four doors	1	\$3,037
<b>Typical List Price</b>			<b>\$13,104</b>

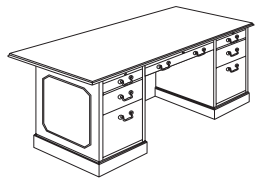
Description	D	W	H	CTN WT	CU FT	① Model	List Price
Executive Desk 	42	84	30	480	71	BG4284ED	\$6,226
	42	78	30	460	66	BG4278ED	\$5,554
	36	72	30	340	53	BG3672ED	\$4,324

- locking center drawer
- central locking
- writing shelf/tray/box/file
- 3-piece leather inlay available, specify and add \$2,225 list
- BG4284ED has a 6" overhang on each end and 6" overhang on the approach side
- BG4278ED & BG3672ED has a 3" overhang on each end and 6" overhang on the approach side
- BG4284ED & BG4278ED have legal width pedestals
- BG3672ED has letter width pedestals
- BG4284ED chassis - 36" x 72"
- BG4278ED chassis - 36" x 72"
- BG3672ED chassis - 30" x 66"
- BG4284ED kneespace - 33"
- BG4278ED kneespace - 33"
- BG3672ED kneespace - 33"
- 24 7/8" clearance from floor to bottom of center drawer

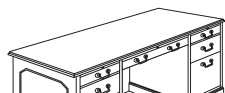
Double Pedestal Desk 	36	72	30	435	53	BG3672DD	\$4,795
	30	72	30	320	44	BG3072DD	\$4,199
	30	66	30	310	41	BG3066DD	\$4,075
	30	60	30	300	37	BG3060DD	\$3,803

- writing shelf/tray/box/file
- letter width pedestals
- locking center drawer
- central locking
- 3-piece leather inlay available, specify and add \$2,225 list
- BG3672DD chassis - 36" x 72"
- BG3072DD chassis - 30" x 72"
- BG3066DD chassis - 30" x 66"
- BG3060DD chassis - 30" x 60"
- BG3672DD, BG3072DD and BG3066DD kneespace - 33"
- BG3060DD kneespace - 27"
- 24 7/8" clearance from floor to bottom of center drawer

BROGAN

Description	D	W	H	CTN WT	CU FT	① Model	List Price
Table Desk	36	72	30	170	53	BG3672TD	\$3,387
<b>NOW!</b>	30	66	30	150	41	BG3066TD	\$2,973



- locking center drawer
- 24 7/8" clearance from floor to bottom of center drawer
- 3-piece leather inlay available, specify and add \$2,225 list

BROGAN

**To Order, Specify:**

- ① Model Number
- ② Wood Species - Cherry (CH1) or Walnut (WA1) (see page 261)
- ③ Finish Color (see page 261)
- ④ Pull Style and Color (see page 261)
- ⑤ Other Product Options (see page 260)
- ⑥ Accessories, Power and Data (see pages 519-535)

When ordering Quickship products, place a "Q" in front of model number.  
Example: QBG3072DD

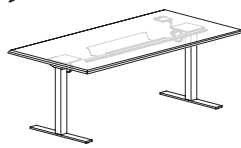

Description	D	W	H	CTN WT	CU FT	① Model	List Price
<b>Electric Adjustable Height Table Desk</b> 	36	72	Adj.	194	18	BG3672AHTD-EL	\$2,745
	30	72	Adj.	175	16	BG3072AHTD-EL	\$2,640
	30	66	Adj.	168	15	BG3066AHTD-EL	\$2,610
	30	60	Adj.	160	14	BG3060AHTD-EL	\$2,578
	24	72	Adj.	151	12	BG2472AHTD-EL	\$2,534
	24	66	Adj.	146	11	BG2466AHTD-EL	\$2,509
	24	60	Adj.	140	10	BG2460AHTD-EL	\$2,485

- 22 ½" - 49" height adjustment
- top edge profile on user and approach sides
- push button control pad mounted right or left
- maximum weight rating 140 lbs. (evenly distributed load)
- key pad features height display with three memory settings
- display will reference position to the nearest ½"
- 120" power cord
- specify Matte Black (MBK) or Arctic Silver (STS) base finish
- ships KD

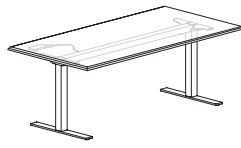
<b>Pneumatic Adjustable Height Table Desk</b> 	36	72	Adj.	194	18	BG3672AHTD-PN	\$4,808
	30	72	Adj.	175	16	BG3072AHTD-PN	\$4,601
	30	66	Adj.	168	15	BG3066AHTD-PN	\$4,466
	30	60	Adj.	160	14	BG3060AHTD-PN	\$4,325
	24	72	Adj.	151	12	BG2472AHTD-PN	\$4,308
	24	66	Adj.	146	11	BG2466AHTD-PN	\$4,233
	24	60	Adj.	140	10	BG2460AHTD-PN	\$4,142

- 27 ½" - 44 ½" height adjustment
- top edge profile on all sides
- release lever mounts under edge of top
- 225 lb. max load
- specify Matte Black or Alloy base finish
- ships KD

BROGAN



Description	D	W	H	CTN WT	CU FT	① Model	List Price
Modesty Panels for Adjustable Height Tables	¾	64	12	18	2	BG0964TDM	\$708
	¾	58	12	16	2	BG0958TDM	\$685
	¾	52	12	14	2	BG0952TDM	\$667

**NOW!**

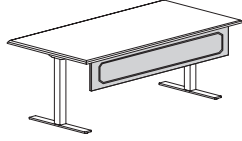

- BG0964TDM use with 72" wide adjustable height desk
- BG0958TDM use with 66" wide adjustable height desk
- BG0952TDM use with 60" wide adjustable height desk
- flat edge detail
- modesty panel bracket is available in Black Sandtex (BSX) or Stardust Silver (STS)

**To Order, Specify:**

- ① Model Number
- ② Wood Species - Cherry (CH1), or Walnut (WA1) (see page 261)
- ③ Finish Color (see page 261)
- ④ Edge Profile (see page 261)
- ⑤ Metal Color (see page 261)
- ⑥ Other Product Options (see page 260)

When ordering Quickship products, place a "Q" in front of model number.  
Example: QBG3072DD

**NOW!**  
*Need it.*  
JSI Quickship

## Desk Applications

### Executive L

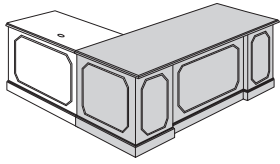

### Executive U

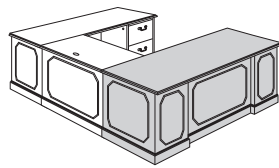

### Computer U

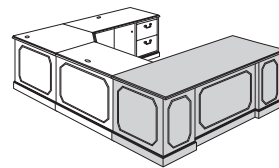

#### Description

#### Single Pedestal Desk

**NOW!**

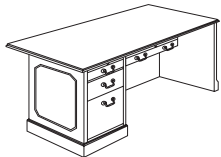

left shown

	D	W	H	CTN WT	CU FT	① Model	List Price
	36	72	30	270	53	<b>BG3672RD</b>	\$4,075
	36	72	30	270	53	<b>BG3672LD</b>	\$4,075

- 6" overhang on approach side
- chassis - 30" x 72"
- writing shelf/tray/box/file
- letter width pedestals
- locking center drawer
- central locking
- 3-piece leather inlay available, specify and add \$2,225 list
- not for use with Brogan Modular

#### Single Pedestal Desk

**NOW!**

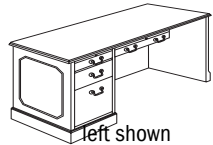

left shown

	30	72	30	260	44	<b>BG3072RD</b>	\$3,939
	30	72	30	260	44	<b>BG3072LD</b>	\$3,939
	30	66	30	240	41	<b>BG3066RD</b>	\$3,803
	30	66	30	240	41	<b>BG3066LD</b>	\$3,803

- writing shelf/tray/box/file
- letter width pedestals
- locking center drawer
- central locking
- 3-piece leather inlay available, specify and add \$2,225 list
- not for use with Brogan Modular

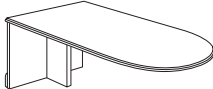
Description	D	W	H	CTN WT	CU FT	① Model	List Price
Bullet Peninsula Desk	36	72	30	185	53	BG3672RB	\$4,322
<b>NOW!</b>	36	72	30	185	53	BG3672LB	\$4,322
	30	72	30	177	44	BG3072RB	\$4,208
	30	72	30	177	44	BG3072LB	\$4,208

right shown

- not recommended for freestanding use
- bases must be purchased separately; see below for options
- not for use with Brogan Modular

P-Top Peninsula Desk	42	72	30	210	58	BG4272RP	\$4,331
<b>NOW!</b>	42	72	30	210	58	BG4272LP	\$4,331

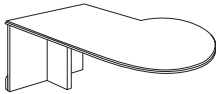

right shown

- 42" at widest point
- 36" at end panel
- not recommended for freestanding use
- bases must be purchased separately; see below for options
- not for use with Brogan Modular

**Bases Options and Modesty Panels for Peninsula Tops**  
(these bases must be ordered separately from the desks listed above)

**NOW!**

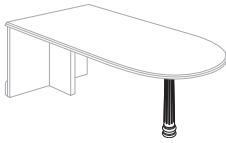

Wood Column Base  
· 04WB - Wood \$754

Base:  
· 4" diameter

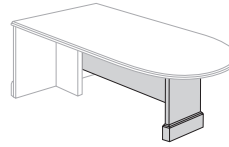
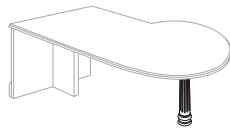

3/4 Modesty Panel  
· BG2454RMP - right \$911  
· BG2454LMP - left \$911

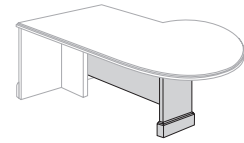

**To Order, Specify:**

- ① Model Number
- ② Wood Species - Cherry (CH1) or Walnut (WA1) (see page 261)
- ③ Finish Color (see page 261)
- ④ Pull Style and Color (see page 261)
- ⑤ Other Product Options (see page 260)
- ⑥ Accessories, Power and Data (see pages 519-535)

When ordering Quickship products, place a "Q" in front of model number.  
Example: QBG3072DD

**NOW!**  
*Need it.*  
JSI Quickship

Return Applications - Executive L

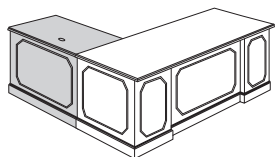

Description	D	W	H	CTN WT	CU FT	① Model	List Price
Executive Return	24	48	30	145	25	BG2448ERR	\$2,817
<b>NOW!</b>	24	48	30	145	25	BG2448ELR	\$2,817
	24	42	30	140	22	BG2442ERR	\$2,714
	24	42	30	140	22	BG2442ELR	\$2,714

· one surface grommet  
 · short grain direction  
 · letter width file/file pedestal  
 · pedestal locking  
 · not for use with Brogan Modular



left shown

Lateral File Return	24	48	30	170	25	BG2448LRR	\$3,431
<b>NOW!</b>	24	48	30	170	25	BG2448LLR	\$3,431

· 36" width lateral file  
 · no grommet  
 · short grain direction  
 · pedestal locking  
 · not for use with Brogan Modular

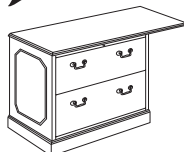

left shown

Corner Unit Applications - Computer U

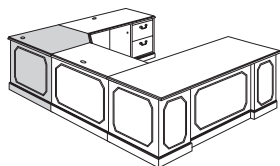

Description	D	W	H	CTN WT	CU FT	① Model	List Price
Executive Corner Unit	42	42	30	165	36	BG4242ERCU	\$2,846
<b>NOW!</b>	42	42	30	165	36	BG4242ELCU	\$2,846
	36	36	30	148	27	BG3636ERCU	\$2,622
	36	36	30	148	27	BG3636ELCU	\$2,622

· straight grain top; direction determined by right and left units  
 · not for freestanding use  
 · use with pedestal return  
 · one surface grommet  
 · not for use with Brogan Modular

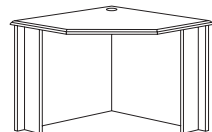

right shown

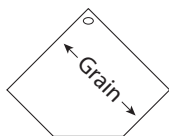

Corner Return Applications - Computer U

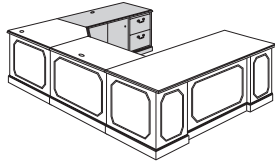

Description	D	W	H	CTN WT	CU FT	① Model	List Price
Executive Corner Return	24	48	30	145	25	BG2448ERCR	\$2,817
<b>NOW!</b>	24	48	30	145	25	BG2448ELCR	\$2,817
	24	42	30	140	22	BG2442ERCR	\$2,714
	24	42	30	140	22	BG2442ELCR	\$2,714

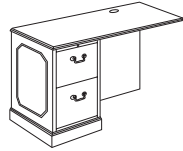

left shown

- use with corner unit
- one surface grommet
- long grain direction
- letter width file/file pedestal
- pedestal locking
- not for use with Brogan Modular

Lateral File Corner Return	24	48	30	170	25	BG2448LRCR	\$3,431
<b>NOW!</b>	24	48	30	170	25	BG2448LLCR	\$3,431



left shown

- use with corner unit
- 36" width lateral file
- anti-tip interlock mechanism
- no grommet
- long grain direction
- pedestal locking
- not for use with Brogan Modular

Bridge Applications - Executive U

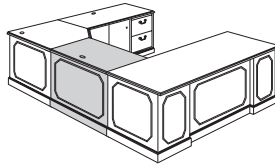

Description	D	W	H	CTN WT	CU FT	① Model	List Price
Executive Bridge	24	48	30	105	4	BG2448EB	\$1,432
<b>NOW!</b>	24	42	30	95	3	BG2442EB	\$1,320
	24	36	30	85	3	BG2436EB	\$1,229

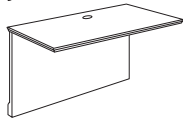

- one surface grommet
- short grain direction
- not for use with Brogan Modular









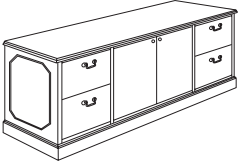

To Order, Specify:

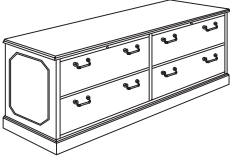
- ① Model Number
- ② Wood Species - Cherry (CH1) or Walnut (WA1) (see page 261)
- ③ Finish Color (see page 261)
- ④ Pull Style and Color (see page 261)
- ⑤ Other Product Options (see page 260)
- ⑥ Accessories, Power and Data (see pages 519-535)

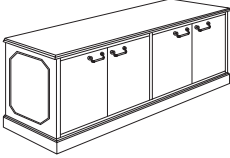
When ordering Quickship products, place a "Q" in front of model number.  
Example: QBG3072DD

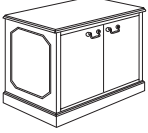
**NOW!**  
Need it.  
JSI Quickship

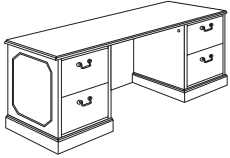
BROGAN

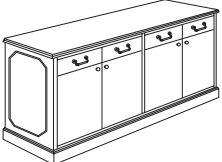
Description	D	W	H	CTN WT	CU FT	① Model	List Price
Storage Credenza Hinged Doors 	24	72	30	290	36	BG2472SC	\$4,248
	24	66	30	270	33	BG2466SC	\$4,000
 <ul style="list-style-type: none"> <li>· legal width file/file pedestals</li> <li>· adjustable shelf in center storage</li> <li>· grommet located in top center of back panel</li> <li>· pedestal locking</li> <li>· locking doors available, specify and add \$123 list</li> </ul>							
	<hr/>						
Lateral File Credenza 	24	72	30	300	36	BG2472LFC	\$4,419
 <ul style="list-style-type: none"> <li>· two drawer lateral files side by side</li> <li>· anti-tip interlock mechanism</li> <li>· pedestal locking</li> </ul>							
	<hr/>						
Four Door Credenza 	24	72	30	310	33	BG2472DSC	\$4,248
 <ul style="list-style-type: none"> <li>· adjustable shelves</li> <li>· locking doors available, specify and add \$246 list</li> </ul>							
	<hr/>						
Two Door Credenza 	24	36	30	90	15	BG3630SC	\$2,191
 <ul style="list-style-type: none"> <li>· one adjustable shelf</li> <li>· locking doors available, specify and add \$123 list</li> </ul>							
	<hr/>						
Kneespace Credenza 	24	72	30	240	36	BG2472KC	\$4,000
	24	66	30	220	33	BG2466KC	\$3,740
 <ul style="list-style-type: none"> <li>· legal width file/file pedestals</li> <li>· grommet located in top center of back panel</li> <li>· pedestal locking</li> <li>· kneespace for BG2472KC - 33"</li> <li>· kneespace for BG2466KC - 27"</li> </ul>							
	<hr/>						
Buffet Credenza 	24	72	36	330	43	BG2472BSC	\$5,523
 <ul style="list-style-type: none"> <li>· four door credenza</li> <li>· four box drawers above doors</li> <li>· locking not available</li> <li>· adjustable shelf in storage cabinet</li> </ul>							

BROGAN

Credenza Applications - Executive U

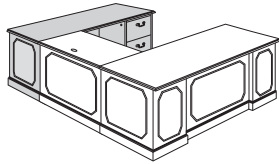

Description	D	W	H	CTN WT	CU FT	1 Model	List Price
Pedestal Credenza	24	72	30	220	36	BG2472RC	\$3,662
<b>NOW!</b>	24	72	30	220	36	BG2472LC	\$3,662
	24	66	30	210	33	BG2466RC	\$3,332
	24	66	30	210	33	BG2466LC	\$3,332

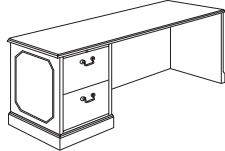

left shown

- grommet located in top center of back panel
- legal width file/file pedestal
- pedestal locking
- not for use with Brogan Modular

Reception Pedestal Credenza	24	72	30	220	36	BG2472RCR	\$3,662
<b>NOW!</b>	24	72	30	220	36	BG2472LCR	\$3,662

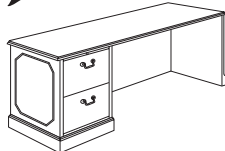

left shown

- no grommet
- legal width file/file pedestal
- pedestal locking
- not for use with Brogan Modular

Lateral Pedestal Credenza	24	72	30	230	36	BG2472LRC	\$4,170
<b>NOW!</b>	24	72	30	230	36	BG2472LLC	\$4,170

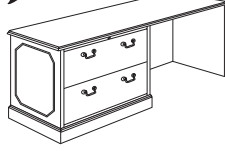

left shown

- no grommet
- pedestal locking
- not for use with Brogan Modular

Multi-File Pedestal Credenza	24	72	30	265	36	BG2472MRC	\$4,334
<b>NOW!</b>	24	72	30	265	36	BG2472MLC	\$4,334

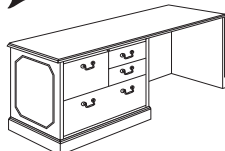

left shown

- no grommet
- pedestal locking
- not for use with Brogan Modular

To Order, Specify:

- 1 Model Number
- 2 Wood Species - Cherry (CH1) or Walnut (WA1) (see page 261)
- 3 Finish Color (see page 261)
- 4 Pull Style and Color (see page 261)
- 5 Other Product Options (see page 260)
- 6 Accessories, Power and Data (see pages 519-535)

When ordering Quickship products, place a "Q" in front of model number.  
Example: QBG3072DD

**NOW!**  
Need it.  
JSI Quickship

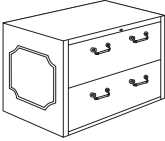
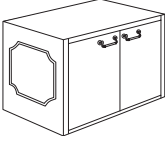
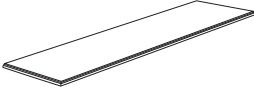
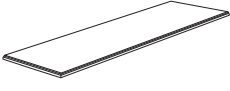
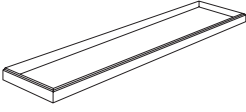
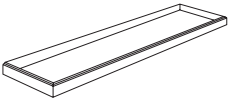
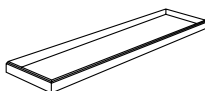
Description	D	W	H	CTN WT	CU FT	① Model	List Price
<b>Modular Lateral File</b>  <ul style="list-style-type: none"> <li>· anti-tip interlock mechanism</li> <li>· pedestal locking</li> <li>· no molding, molding on left, molding on right</li> <li>· top and base required, see below</li> </ul>	23 ¼	34 ¾	24 ¼	120	15	BG2436MLF	\$2,382
<b>Modular Storage Cabinet</b>  <ul style="list-style-type: none"> <li>· one adjustable shelf</li> <li>· non-locking</li> <li>· no molding, molding on left, molding on right</li> <li>· top and base required, see below</li> </ul>	23 ¼	34 ¾	24 ¼	90	15	BG2436MSC	\$2,001
<b>Modular Credenza Top</b>  <ul style="list-style-type: none"> <li>· for use with three modular units; BG2436MLF or BG2436MSC</li> </ul>	24	105 ¾	1 ¾	45	6	BG24108MCT	\$1,407
<b>Modular Credenza Top</b>  <ul style="list-style-type: none"> <li>· for use with two modular units; BG2436MLF or BG2436MSC</li> </ul>	24	72	1 ¾	30	4	BG2472MCT	\$949
<b>Modular Credenza Base</b>  <ul style="list-style-type: none"> <li>· for use with three modular units; BG2436MLF or BG2436MSC</li> </ul>	23 ¾	105	4 ¼	60	7	BG24108MCB	\$732
<b>Modular Credenza Base</b>  <ul style="list-style-type: none"> <li>· for use with two modular units; BG2436MLF or BG2436MSC</li> </ul>	23 ¾	70 ¾	4 ¼	30	4	BG2472MCB	\$522
<b>Modular Credenza Base</b> 	23 ¾	35 ¾	4 ¼	20	3	BG2436MCB	\$372



Description	D	W	H	CTN WT	CU FT	1 Model	List Price
<b>Modular Open Bookcase</b>	15	34 1/2	40 13/16	105	17	<b>BG1542MBC</b>	<b>\$1,443</b>

**NOW!**

- two adjustable shelves

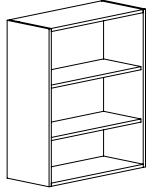

<b>Modular Glass/Grille Door Bookcase</b>	15	34 1/2	40 13/16	105	17	<b>BG1542MGBC</b>	<b>\$2,592</b>
---	----	--------	----------	-----	----	-------------------	----------------

**NOW!**

- two adjustable shelves
- non-locking
- specify grille color - antique brass (ANB) or antique pewter (ANP)

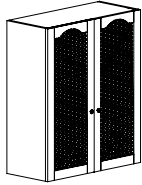

<b>Modular Bookcase Top</b>	15 7/8	105	1 3/16	73	5	<b>BG15108MCT</b>	<b>\$986</b>
-----------------------------	--------	-----	--------	----	---	-------------------	--------------

**NOW!**

- for use with three single bookcases; BG1542MGBC or BG1542MBC

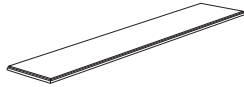

<b>Modular Bookcase Top</b>	15 7/8	70 1/2	1 3/16	48	3	<b>BG1572MCT</b>	<b>\$666</b>
-----------------------------	--------	--------	--------	----	---	------------------	--------------

**NOW!**

- for use with two single bookcases; BG1542MGBC or BG1542MBC

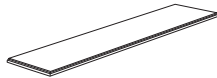

<b>Modular Bookcase Top</b>	15 7/8	36	1 3/16	23	2	<b>BG1536MCT</b>	<b>\$380</b>
-----------------------------	--------	----	--------	----	---	------------------	--------------

**NOW!**

- for use with a single bookcase; BG1542MGBC or BG1542MBC



**To Order, Specify:**

- 1 Model Number
- 2 Wood Species - Cherry (CH1) or Walnut (WA1) (see page 261)
- 3 Finish Color (see page 261)
- 4 Pull Style and Color (see page 261)
- 5 Other Product Options (see page 260)

When ordering Quickship products, place a "Q" in front of model number.  
Example: QBG3072DD

**NOW!**  
*Need it.*  
JSI Quickship

Description	D	W	H	CTN WT	CU FT	① Model	List Price
Open Storage Overhead Cabinet <b>NOW!</b>	15 7/8	84	42	220	39	BG158400	\$3,164
	15 7/8	78	42	205	37	BG157800	\$3,105
	15 7/8	72	42	190	33	BG157200	\$3,042
	15 7/8	66	42	170	30	BG156600	\$2,908

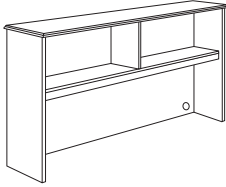

- tackboard available, see below and page 281
- task lights available, see pages 532-533
- grommet located bottom left and right and top center of back panel
- clearance opening for BG158400 - 19 1/2" h x 79 7/8" w
- clearance opening for BG157800 - 19 1/2" h x 73 7/8" w
- clearance opening for BG157200 - 19 1/2" h x 67 7/8" w
- clearance opening for BG156600 - 19 1/2" h x 61 7/8" w

Storage Overhead Cabinet with Four Doors <b>NOW!</b>	15 7/8	84	42	240	39	BG1584S0	\$3,330
	15 7/8	78	42	215	37	BG1578S0	\$3,266
	15 7/8	72	42	190	33	BG1572S0	\$3,202
	15 7/8	66	42	170	30	BG1566S0	\$3,067

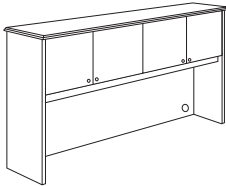

- tackboard available, see below and page 281
- task lights available, see pages 532-533
- grommet located bottom left and right and top center of back panel
- non-locking
- locking doors available, specify and add \$246 list
- clearance opening for BG1584S0 - 19 1/2" h x 79 7/8" w
- clearance opening for BG1578S0 - 19 1/2" h x 73 7/8" w
- clearance opening for BG1572S0 - 19 1/2" h x 67 7/8" w
- clearance opening for BG1566S0 - 19 1/2" h x 61 7/8" w

Description	D	W	H	CTN WT	CU FT	① Model	List Price Per Grade
Tackboard for 84" w Storage Overhead Cabinet <b>NOW!</b>	3/8	79 1/2	15 3/4	3	4	BG84TK	COM \$357
							A \$391
							B \$456
							C \$569
							D \$716
							E \$860
							F \$1,087
							G \$1,333
							H \$1,590
							I \$1,997
							J \$2,483

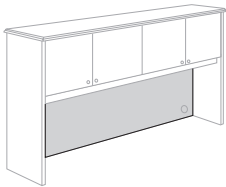

- for use with 84" wide storage overhead cabinet
- fabrics available, see pages 19-26 for selection
- com ydg: 2 3/4

Tackboard for 78" w Storage Overhead Cabinet <b>NOW!</b>	3/8	73 1/2	15 3/4	3	4	BG78TK	COM \$352
							A \$382
							B \$441
							C \$546
							D \$679
							E \$811
							F \$1,016
							G \$1,237
							H \$1,473
							I \$1,841
							J \$2,286

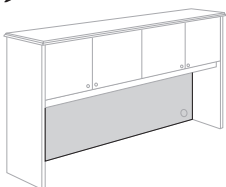

- for use with 78" wide storage overhead cabinet
- fabrics available, see pages 19-26 for selection
- com ydg: 2 1/2

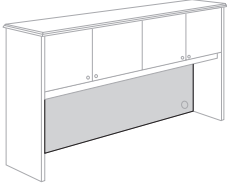
Description	D	W	H	CTN WT	CU FT	1 Model	List Price Per Grade
<b>Tackboard for 72" w Storage Overhead Cabinet</b> 	3/8	67 3/4	15 3/4	2	3	BG72TK	COM \$331 A \$359 B \$412 C \$505 D \$624 E \$744 F \$929 G \$1,128 H \$1,339 I \$1,672 J \$2,069

- for use with 72" wide storage overhead cabinet
- fabrics available, see pages 19-26 for selection
- com ydg: 2 1/4

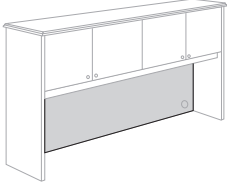
<b>Tackboard for 66" w Storage Overhead Cabinet</b> 	3/8	61 3/4	15 3/4	2	3	BG66TK	COM \$311 A \$335 B \$380 C \$465 D \$569 E \$677 F \$841 G \$1,019 H \$1,205 I \$1,502 J \$1,856
--	-----	--------	--------	---	---	--------	---

- for use with 66" wide storage overhead cabinet
- fabrics available, see pages 19-26 for selection
- com ydg: 2

**To Order, Specify:**

- 1 Model Number
- 2 Wood Species - Cherry (CH1) or Walnut (WA1) (see page 261)
- 3 Finish Color (see page 261)
- 4 Pull Color (see page 261)
- 5 Fabric Selection: vendor, pattern, color
- 6 Other Product Options (see page 260)
- 7 Accessories, Power and Data (see pages 519-535)

When ordering Quickship products, place a "Q" in front of model number.  
 Example: QBG3072DD

**NOW!**  
*Need it.*  
 JSI Quickship

Description	D	W	H	CTN WT	CU FT	① Model	List Price
Storage Overhead Cabinet with Clear Glass	15 <sup>7</sup> / <sub>8</sub>	72	42	200	33	BG1572CO	\$4,536
	15 <sup>7</sup> / <sub>8</sub>	66	42	180	30	BG1566CO	\$4,305

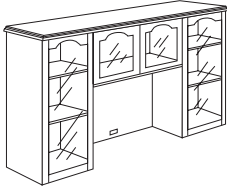

- four adjustable glass shelves
- grommets located in top and bottom center of back panel
- locking not available
- tackboards available, see below
- task lights available, see pages 532-533
- BG1572CO clearance opening - 23 1/2" h x 33" w
- BG1566CO clearance opening - 23 1/2" h x 27" w
- interior lighting with 3 LED lights and on/off switch available, specify and add \$544

Storage Overhead Cabinet with Glass/Grille	15 <sup>7</sup> / <sub>8</sub>	72	42	200	33	BG1572GO	\$4,899
	15 <sup>7</sup> / <sub>8</sub>	66	42	180	30	BG1566GO	\$4,560

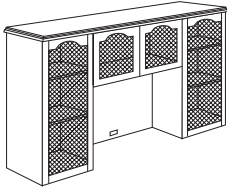

- four adjustable glass shelves
- grommets located in top and bottom center of back panel
- locking not available
- tackboards available, see below
- task lights available, see pages 532-533
- BG1572GO clearance opening - 23 1/2" h x 33" w
- BG1566GO clearance opening - 23 1/2" h x 27" w
- interior lighting with 3 LED lights and on/off switch available, specify and add \$544
- specify grille color - antique brass or antique pewter

Description	D	W	H	CTN WT	CU FT	① Model	List Price Per Grade
Tackboard for 72" w Storage Overhead Cabinet	3/8	32 <sup>7</sup> / <sub>8</sub>	20 <sup>5</sup> / <sub>16</sub>	3	2	BG34TK	COM \$229
							A \$246
							B \$275
							C \$326
							D \$393
							E \$459
							F \$562
							G \$674
							H \$792
							I \$976
							J \$1,197

**NOW!**

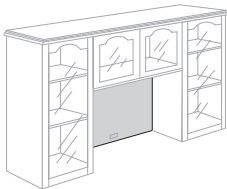

- for use with 72" wide storage overhead cabinet
- fabrics available, see pages 19-26 for selection
- com ydg: 1 1/4

Tackboard for 66" w Storage Overhead Cabinet	3/8	26 <sup>7</sup> / <sub>8</sub>	20 <sup>5</sup> / <sub>16</sub>	3	2	BG28TK	COM \$206
							A \$219
							B \$241
							C \$283
							D \$338
							E \$390
							F \$472
							G \$560
							H \$655
							I \$801
							J \$980

**NOW!**

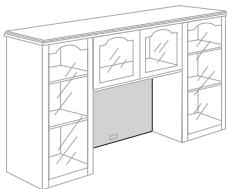

- for use with 66" wide storage overhead cabinet
- fabrics available, see pages 19-26 for selection
- com ydg: 1 1/4

Description	D	W	H	CTN WT	CU FT	① Model	List Price
Wall Mount Overhead with Four Doors	15 7/8	72	22	200	22	BG1572WSO	\$3,037
	15 7/8	66	22	190	20	BG1566WSO	\$2,904

**NOW!**

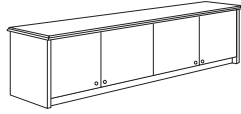

- tackboard available, see below
- task lights available, see pages 532-533
- locking doors available, specify and add \$246 list

Description	D	W	H	CTN WT	CU FT	① Model	List Price Per Grade
72" w Wall Mount Tackboard	1 1/2	70	17	2	3	BG7220WT	COM \$402

**NOW!**

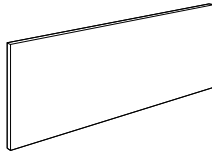

- for use with 72" wide wall mount overhead cabinet
- fabrics available, see pages 19-26 for selection
- four 3/8" deep x 2" wide vertical channels in back of panel allow wire management
- com ydg: 2 1/4

- A \$431
- B \$482
- C \$578
- D \$697
- E \$816
- F \$1,002
- G \$1,200
- H \$1,412
- I \$1,744
- J \$2,141

66" w Wall Mount Tackboard	1 1/2	64	17	2	3	BG6620WT	COM \$380
----------------------------	-------	----	----	---	---	----------	-----------

**NOW!**

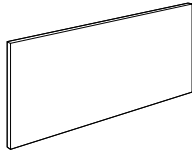

- for use with 66" wide wall mount overhead cabinet
- fabrics available, see pages 19-26 for selection
- four 3/8" deep x 2" wide vertical channels in back of panel allow wire management
- com ydg: 2

- A \$405
- B \$452
- C \$534
- D \$641
- E \$747
- F \$912
- G \$1,087
- H \$1,278
- I \$1,572
- J \$1,925

**To Order, Specify:**

- ① Model Number
- ② Wood Species - Cherry (CH1) or Walnut (WA1) (see page 261)
- ③ Finish Color (see page 261)
- ④ Pull Color (see page 261)
- ⑤ Fabric Selection: vendor, pattern, color
- ⑥ Other Product Options (see page 260)
- ⑦ Accessories, Power and Data (see pages 519-535)

When ordering Quickship products, place a "Q" in front of model number.  
Example: QBG3072DD

**NOW!**  
*Need it.*  
JSI Quickship

Description	D	W	H	CTN WT	CU FT	① Model	List Price
Transaction Counter for U Unit	13	90	17 <sup>3</sup> / <sub>16</sub>	145	12	<b>BG13186TC</b> coordinates with BG2472RCR, BG2472LCR, and BG2442EB	\$2,415

**NOW!**

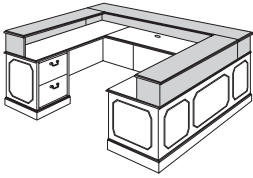

- for U units
- 16" vertical clearance from worksurface to bottom of transaction top

Transaction Counter for L Unit	13	66	17 <sup>3</sup> / <sub>16</sub>	110	9	<b>BG13114RTC</b> coordinates with BG3066LD BG2448ERR	\$1,883
--------------------------------	----	----	---------------------------------	-----	---	---	---------

**NOW!**

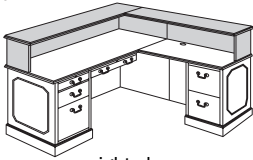

right shown

- for L units
- 16" vertical clearance from worksurface to bottom of transaction top

Transaction Counter	13	72	17 <sup>3</sup> / <sub>16</sub>	87	9	<b>BG1372TC</b> coordinates with a 72" surface	\$1,352
---------------------	----	----	---------------------------------	----	---	---	---------

**NOW!**

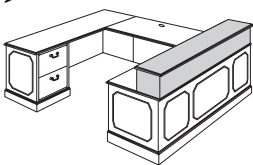

	13	66	17 <sup>3</sup> / <sub>16</sub>	79	8	<b>BG1366TC</b> coordinates with a 66" surface	\$1,291
--	----	----	---------------------------------	----	---	---	---------

- 16" vertical clearance from worksurface to bottom of transaction top

Description	D	W	H	CTN WT	CU FT	① Model	List Price
-------------	---	---	---	-----------	----------	---------	------------

Bookcase	15	36	72	165	28	BG3672BC	\$2,596
----------	----	----	----	-----	----	----------	---------

**NOW!**

- one fixed shelf
- three adjustable shelves



Bookcase	15	36	54	135	21	BG3654BC	\$1,951
----------	----	----	----	-----	----	----------	---------

**NOW!**

- three adjustable shelves



Bookcase	15	36	30	75	12	BG3630BC	\$1,300
----------	----	----	----	----	----	----------	---------

**NOW!**

- one adjustable shelf



Bookcase Overhead	15	36	42	85	20	BG1536B0	\$1,304
-------------------	----	----	----	----	----	----------	---------

**NOW!**

- for use with BG3630LF and BG3630SC
- one adjustable shelf
- one fixed shelf
- one back panel grommet standard



**To Order, Specify:**

- ① Model Number
- ② Wood Species - Cherry (CH1) or Walnut (WA1) (see page 261)
- ③ Finish Color (see page 261)
- ④ Other Product Options (see page 260)

When ordering Quickship products, place a "Q" in front of model number.  
Example: QBG3072DD

**NOW!**  
Need it.  
JSI Quickship

BROGAN

Description	D	W	H	CTN WT	CU FT	① Model	List Price
Lateral File	24	36	54	280	33	BG3654LF	\$3,960

**NOW!**



- four drawers
- edge profile on three sides
- anti-tip interlock mechanism
- pedestal locking

Lateral File	24	36	30	175	19	BG3630LF	\$2,620
--------------	----	----	----	-----	----	----------	---------

**NOW!**

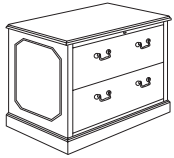

- two drawers
- edge profile on three sides
- anti-tip interlock mechanism
- pedestal locking



Description	D	W	H	CTN WT	CU FT	① Model	List Price
72" h Wardrobe	24	34 5/8	72	360	43	BG3672W	\$3,565

**NOW!**

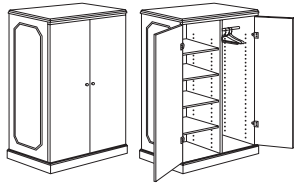

- chrome hanging bar on right
- shelves on left (second from bottom fixed)
- locking doors available; specify and add \$246 list

Hanging Bar to Shelves Conversion Kit			3/4	56	2	BG1824SK	\$767
---------------------------------------	--	--	-----	----	---	----------	-------

**NOW!**

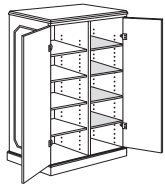

- four shelves
- for 36" wide wardrobe

72" h File/File Lateral Storage Cabinet	24	36	72	360	43	BG3672SWLF	\$4,986
---	----	----	----	-----	----	------------	---------

**NOW!**

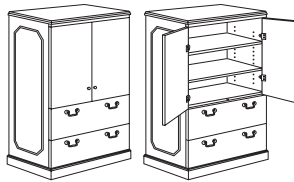

- two adjustable shelves
- locking doors available; specify and add \$123 list
- file/file lateral
- pedestal locking

72" h File/File Storage Wardrobe	24	23 5/8	72	340	30	BG2472SWR	\$3,457
	24	23 5/8	72	340	30	BG2472SWL	\$3,457

**NOW!**

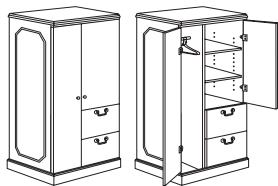

- chrome hanging bar
- two adjustable shelves
- bottom shelf fixed
- file/file pedestal
- locking not available

left shown

**To Order, Specify:**

- ① Model Number
- ② Wood Species - Cherry (CH1) or Walnut (WA1) (see page 261)
- ③ Finish Color (see page 261)
- ④ Pull Style and Color (see page 261)
- ⑤ Other Product Options (see page 260)

When ordering Quickship products, place a "Q" in front of model number.  
Example: QBG3072DD

**NOW!**  
Need it.  
JSI Quickship

Description	D	W	H	CTN WT	CU FT	① Model	List Price
Printer Stand	24	30	30	125	16	BG2430PS	\$2,019

**NOW!**

- fixed 11" deep shelf

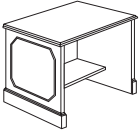

Corner Unit	D	W	H	CTN WT	CU FT	Model	List Price
	42	42	30	165	36	BG4242CU	\$2,846
	36	36	30	148	27	BG3636CU	\$2,622

**NOW!**

- angle grain direction on top
- one surface grommet
- freestanding
- keyboard tray or mouse pad cannot be used with BG3636CU

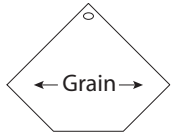
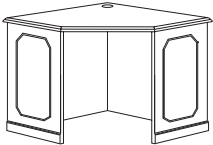

BROGAN

Description	D	W	H	CTN WT	CU FT	1 Model	List Price
Sofa Table	18	60	30	81	4	BG1860ST	\$1,136

**NOW!**

• ships KD in one carton

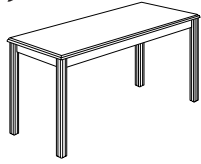

Magazine Table	20	42	16	63	4	BG2042MT	\$956
----------------	----	----	----	----	---	----------	-------

**NOW!**

• ships KD in one carton

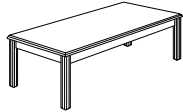

End Table	24	24	20	43	3	BG2424ET	\$811
-----------	----	----	----	----	---	----------	-------

**NOW!**

• ships KD in one carton

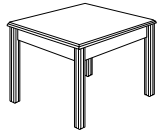

End Table	20	28	20	43	3	BG2028ET	\$807
-----------	----	----	----	----	---	----------	-------

**NOW!**

• ships KD in one carton

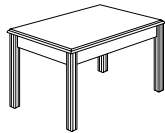

Center Drawer	16	24 1/4	3	12	2	BG1826CDB	\$417
---------------	----	--------	---	----	---	-----------	-------

**NOW!**

• non-locking

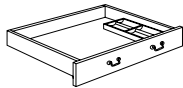

**To Order, Specify:**

- 1 Model Number
- 2 Wood Species - Cherry (CH1) or Walnut (WA1)  
(see page 261)
- 3 Finish Color (see page 261)
- 4 Pull Style and Color (see page 261)
- 5 Other Product Options (see page 260)
- 6 Accessories, Power and Data (see pages 519-535)

When ordering Quickship products, place a "Q" in front of model number.  
Example: QBG3072DD

**NOW!**  
*Need it.*  
JSI Quickship

BROGAN



## Brogan Conference Product Information



# Brogan Conference Product Information

## Exterior Wood Materials

Exterior surfaces are made from the finest selected veneers to achieve clarity and consistency in the Brogan product line. To attain a pleasing, symmetrical pattern, all veneers in Brogan are book-matched. All exterior solid lumber is matched to coordinate with the veneer.

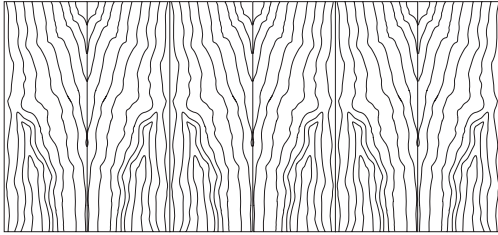

### Book Matched Example

Alternating pieces of veneer are flipped over so they face each other like the pages within a book.

Brogan is available in flat cut cherry and walnut veneer. A wide range of wood stains have been formulated to enhance the beauty of the veneer.

Cherry and Walnut veneer species are available on the  quickship program on select models.

## Work Surface Construction

Tops are 5-ply balanced construction, 1 3/16" thick with solid matching hardwood edges. Tops are available in one edge profile.

Matching or coordinating high pressure laminate in a veneer grain can be applied to the top surface and is available at no additional charge.

## Base Construction

Panels are joined together by mortise and tenon construction. In addition to mortise and tenon joint construction. Leveling glides are set into solid hardwood with t-nut inserts, which helps to prevent the leveling glide from tear out. Tops are secured to the bases with top fastening cleats screwed to the inside of the panels.

## Drawers

The 9ply unidirectional hardwood sides of the drawer box are 7/16" thick assembled with English dovetail construction at each corner of the box. The drawer bottom panel is 1/4" thick fitting into a groove machined into the side of the box. Interiors are sanded and coated with clear U.V. finish to protect against shrinking, swelling or warping, and to provide a clean, smooth feel and appearance.

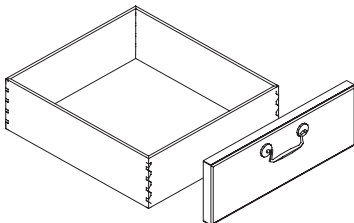

## Drawer Suspension

The high quality black drawer suspensions carry a lifetime warranty. Slides feature steel ball bearings for longer life with cushioned in/out stops. File and box drawers have 100% full extension.

## Finish - Stain/Colors

We offer a variety of wood stains and paint colors on Brogan. Please see the chart below. Samples are available upon request.

<b>CH1 Cherry</b> <i>Flat Cut Veneer</i>	
BRL Barley	EAR Earthy
BBM Bourbon Medium	HRV Harvest*
BRM Brighton Medium	LGC Legacy
CLA Classic	PRL Praline*
CLL Collectors*	SAF Saffron

<b>WA1 Walnut</b> <i>Flat Cut Veneer</i>	
AUB Auburn	SIE Sienna*
ESP Espresso	TOF Toffee
MCH Mocha*	TRF Truffle*
NTO Night Owl*	

\*finishes have coordinating laminate top

## Protective Top Coat

DuraTex™ offers exceptional hardness along with abrasion and impact resistance, it has been formulated to eliminate hazardous and harmful gases that are normally associated with wood finish.

## DuraTex™ Features

**Safety** - Significantly reduces hazardous formaldehyde emissions, which help improve the quality of the of the indoor air we breathe.

**Quality** - Developed to be tough and durable with special attention to appearance. The DuraTex™ finish preserves the natural beauty of wood.

**Durability** - Designed to meet a wide range of demanding performance and environmental standards to withstand even the highest wear and tear.

# Brogan Conference Product Information

## Product Modification

### Laminate Tops

Worksurface only, no additional upcharge if coordinating wood grain laminate is specified. Contact Customer Service for any other laminate request. Listed below are finishes that have coordinating wood grain HPL laminates.

Cherry Finishes	Walnut Finishes
Collectors	Mocha
Harvest	Night Owl
Praline	Sienna
	Truffle

### Special Finishes

Special finishes can be requested by following the instruction in the general introduction section, page 5. There is a one time charge of \$332 list per order.

### Species Change

For species changes contact customer service for a quote.

## Product Modification

### Trim Molding

Angled Trim molding is standard on all Brogan products.

Without molding or Scalloped Trim molding can be specified at the time of order placement. (diagram below show the molding options)

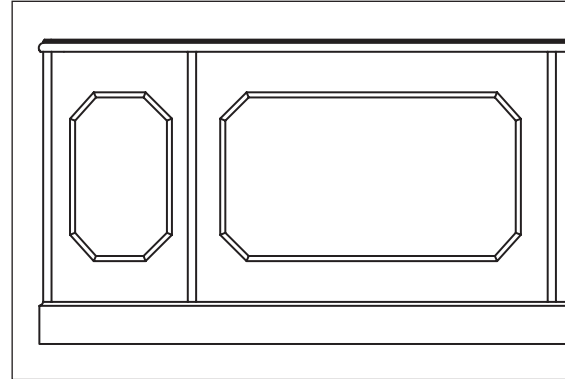

**Angled Trim**  
standard

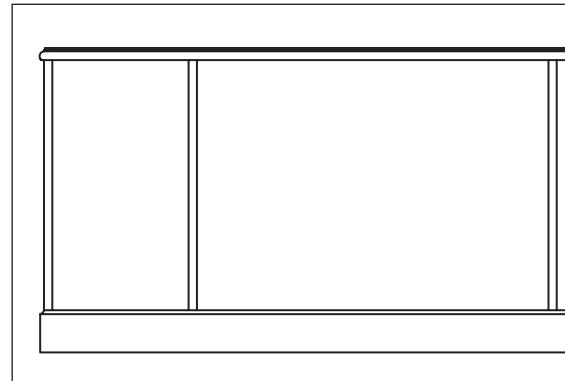

**Base Molding Only** (without trim)  
optional at no charge

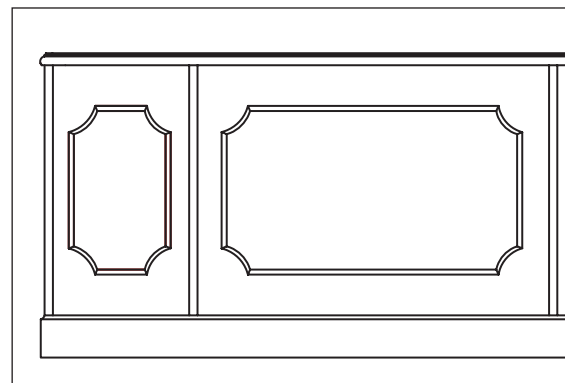

**Scalloped Trim**  
optional with upcharge to list for each item  
\$60 list per base

# Brogan Conference Product Information

## Edge and Hardware

Brogan offers a traditional edge profile and the Brogan drawer pull in antique brass or antique pewter finish.

### Edge Profile

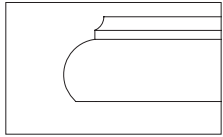

**Federal Edge Profile (C3)**  
Accepts Laminate Top

### Drawer Hardware

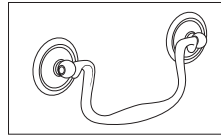

**Brogan Hardware**  
Antique Brass (ANB)  
Antique Pewter (ANP)

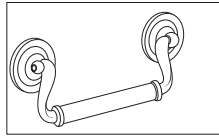

**Gala Hardware**  
Antique Brass (ANB)  
Antique Pewter (ANP)

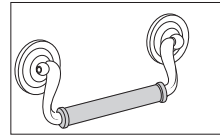

**Gala Leather Wrapped Hardware**  
Antique Brass (ANB)  
Antique Pewter (ANP)

Optional matching leather wrapped pulls available for desk with leather inlay or other coordinating units. Specify leather wrapped pulls, add \$52 list upcharge per pull. Indicate Antique Brass (ANB) or Antique Pewter (ANP) pull.

### Top Shapes - size - base requirement - seating capacity

top sizes 108" through 192" are 2 pieces

top sizes above 192" are 3 pieces

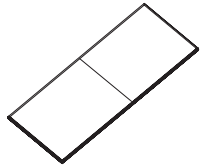

Size	Base Requirement	Seating Capacity
264" x 54"	4 bases	seats 22
240" x 54"	4 bases	seats 20
216" x 54"	4 bases	seats 18
192" x 54"	3 bases	seats 16
264" x 48"	4 bases	seats 22
240" x 48"	4 bases	seats 20
216" x 48"	4 bases	seats 18
192" x 48"	3 bases	seats 16
168" x 48"	3 bases	seats 14
144" x 48"	3 bases	seats 12
120" x 48"	2-3* bases	seats 8
120" x 42"	2-3* bases	seats 8
108" x 42"	2 bases	seats 8
96" x 42"	2 bases	seats 8
72" x 36"	2 bases	seats 6



Size	Base Requirement	Seating Capacity
264" x 54"	4 bases	seats 22
240" x 54"	4 bases	seats 20
216" x 54"	4 bases	seats 18
192" x 54"	3 bases	seats 16
264" x 48"	4 bases	seats 22
240" x 48"	4 bases	seats 20
216" x 48"	4 bases	seats 18
192" x 48"	3 bases	seats 16
168" x 48"	3 bases	seats 14
144" x 48"	3 bases	seats 12
120" x 48"	2-3* bases	seats 8
120" x 42"	2-3* bases	seats 8
108" x 42"	2 bases	seats 8
96" x 42"	2 bases	seats 8
72" x 36"	2 bases	seats 6

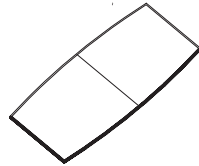

Size	Base Requirement	Seating Capacity
264" x 54"	4 bases	seats 22
240" x 54"	4 bases	seats 20
216" x 54"	4 bases	seats 18
192" x 54"	3 bases	seats 16
264" x 48"	4 bases	seats 22
240" x 48"	4 bases	seats 20
216" x 48"	4 bases	seats 18
192" x 48"	3 bases	seats 16
168" x 48"	3 bases	seats 14
144" x 48"	3 bases	seats 12
120" x 48"	2-3* bases	seats 8
120" x 42"	2-3* bases	seats 8
108" x 42"	2 bases	seats 8
96" x 42"	2 bases	seats 8
72" x 36"	2 bases	seats 6



Size	Base Requirement	Seating Capacity
60" dia.	Seats 6	
54" dia.	Seats 6	
48" dia.	Seats 4	
42" dia.	Seats 4	
36" dia.	Seats 4	

\*requires 1 base

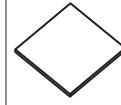

Size	Base Requirement	Seating Capacity
60" sq.	seats 8	
54" sq.	seats 6	
48" sq.	seats 4	
42" sq.	seats 4	
36" sq.	seats 4	
30" sq.	seats 4	

\*requires 1 base

### Base (units with access panel in the base for wire management are available, order this feature with the appropriate model number.)

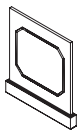

panel base  
30" and 24" width

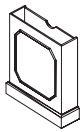

rectangular base  
30" and 24" width



square base  
24" width

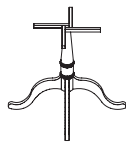

cabriole base  
33" width

### Grommet

Brogan Grommets

Work surface grommets can be specified work surfaces. The grommet location must be approved by JSI manufacturing; contact Customer Service.

Add \$99 to the list for each grommet.

Grommet color must be specified, select Antique Brass or Matte Black. Lock cores will match grommet color.

Matte Black (MBK)  
Antique Brass (ANB)

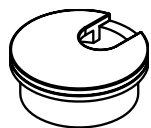



# Brogan Conference Product Information

## Finish and Product Reference Codes

Select	Code
--------	------

### Veneer

Cherry Flat Cut	CH1
Walnut Flat Cut	WA1

### Finish

#### Cherry Finishes

Barley	BRL
Bourbon Medium	BBM
Brighton Medium	BRM
Classic	CLA
Collectors*	CLL
Earthy	EAR
Harvest*	HRV
Legacy	LGC
Praline*	PRL
Saffron	SAF

\*finishes have coordinating laminate top

Select	Code
--------	------

### Finish *(continued)*

#### Walnut Finishes

Auburn	AUB
Espresso	ESP
Mocha*	MCH
Night Owl*	NTO
Sienna*	SIE
Toffee	TOF
Truffle*	TRF

\*finishes have coordinating laminate top

### Pull & Finishes Codes

Brogan Pull-Antique Brass	ANB
Brogan Pull-Pewter	PTR

### Grommet Finish Codes

Antique Brass	ANB
Matte Black	MBK

Select	Code
--------	------

### Laminate Coordinates

#### Cherry Wood Grain Patterns

Collectors	CLL
Harvest	HRV
Praline	PRL

#### Walnut Wood Grain Patterns

Mocha	MCH
Night Owl	NTO
Sienna	SIE
Truffle	TRF

## Order Check List:

Specify:

- 1. Model Number
- 2. Finish
- 3. Wood Species - cherry - walnut
- 4. Top Options - standard veneer - laminate surface (see page 293)
- 5. Pull Section **if applicable**
- 6. Other Product Options
- 7. Power and Data Accessories (*drawing showing location and orientation must accompany order*)
- 8. Side Mark Information (*i.e. room number, East Conference Room*)
- 9. Shipping Address (*contact name and phone number*)
- 10. Special Delivery Instructions (*i.e. call before delivery, deliver to job site*)

Description	D	W	H	Seating Capacity	CTN WT	CU FT	① Model	List Price
Conference Table	42	96	30	8			<b>BG4296CTP</b>	\$5,126

**NOW!**

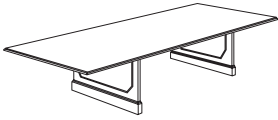

- ships KD in four cartons
- one piece top
- price reflects two bases
- includes BG0655SP stretcher panel

	172	15	Consists of:		
	59 ea.	4 ea.	BG4296TT - Table Top	\$3,512	
			BG2428PB - Panel Bases (2)	\$807 ea.	

Conference Table	36	72	30	6			<b>BG3672CTP</b>	\$3,872
------------------	----	----	----	---	--	--	------------------	---------

**NOW!**

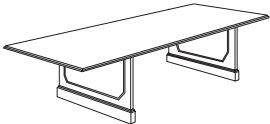

- ships KD in four cartons
- one piece top
- price reflects two bases
- includes BG0631SP stretcher panel

	110	10	Consists of:		
	59 ea.	4 ea.	BG3672TT - Table Top	\$2,258	
			BG2428PB - Panel Bases (2)	\$807 ea.	

Round Conference Table	48	48	30	4			<b>BG48CTC</b>	\$2,987
------------------------	----	----	----	---	--	--	----------------	---------

**NOW!**

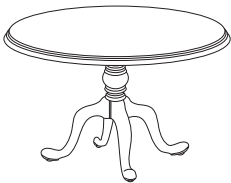

- ships KD in two cartons

	73	7	Consists of:		
	30	16	BG48TT - Table Top	\$1,758	
			BG33CB - Cabriole Base	\$1,229	

Round Conference Table	42	42	30	4			<b>BG42CTC</b>	\$2,573
------------------------	----	----	----	---	--	--	----------------	---------

**NOW!**

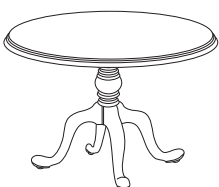

- ships KD in two cartons

	56	5	Consists of:		
	30	16	BG42TT - Table Top	\$1,344	
			BG33CB - Cabriole Base	\$1,229	

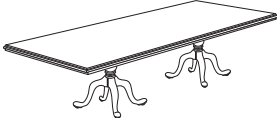
Description	D	W	H	Seating Capacity	CTN WT	CU FT	① Model	List Price
Conference Table	42	96	30	8			<b>BG4296CTC</b>	\$5,970
 <p><b>NOW!</b></p> <ul style="list-style-type: none"> <li>· ships KD in three cartons</li> <li>· one piece top</li> <li>· price reflects two bases</li> </ul>					172	15	Consists of:	
					30 ea.	16 ea.	BG4296TT - Table Top	\$3,512
							BG33CB - Cabriole Bases (2)	\$1,229 ea

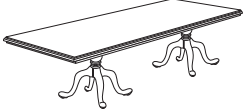

Conference Table	36	72	30	6			<b>BG3672CTC</b>	\$4,716
 <p><b>NOW!</b></p> <ul style="list-style-type: none"> <li>· ships KD in three cartons</li> <li>· one piece top</li> <li>· price reflects two bases</li> </ul>					110	10	Consists of:	
					30 ea.	16 ea.	BG3672TT - Table Top	\$2,258
							BG33CB - Cabriole Bases (2)	\$1,229 ea

**To Order, Specify:**

- ① Model Number
- ② Wood Species
- ③ Finish Color
  - A Worksurface Finish
  - B. Chassis Finish
- ④ Power and Data Options (see pages 519-535)
- ⑤ Other Product Options

When ordering Quickship products, place a "Q" in front of model number.  
Example: QBG3072DD

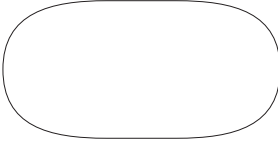

Description	① Model	W	L	Seat Capacity	Top Pieces	Bases Required	CTN WT	CU FT	List Price
<b>Rectangular Tops</b> 	BG60264TT	60	264	24	3	4	673	57	\$14,818
	BG60240TT	60	240	22	3	4	613	51	\$13,471
	BG60216TT	60	216	20	3	4	552	48	\$12,128
	BG60192TT	60	192	18	2	3	490	42	\$10,777
	BG54264TT	54	264	22	3	4	609	52	\$12,350
	BG54240TT	54	240	20	3	4	554	50	\$11,227
	BG54216TT	54	216	18	3	4	498	43	\$10,106
	BG54192TT	54	192	16	2	3	441	38	\$8,983
	BG48264TT	48	264	22	3	4	548	47	\$10,981
	BG48240TT	48	240	20	3	4	498	43	\$9,984
	BG48216TT	48	216	18	3	4	447	38	\$8,983
	BG48192TT	48	192	16	2	3	396	33	\$7,987
	BG48168TT	48	168	14	2	3	346	30	\$6,989
	BG48144TT	48	144	12	2	3	296	28	\$5,991
	BG48120TT**	48	120	8	2	2	245	22	\$4,995
	BG4896TT	48	96	8	1	2	197	17	\$4,013
	BG42120TT**	42	120	8	2	2	217	19	\$4,370
	BG42108TT	42	108	8	2	2	195	17	\$3,936
	BG4296TT 	42	96	8	1	2	172	15	\$3,512
	BG4284TT	42	84	8	1	2	151	13	\$3,057
BG3672TT 	36	72	6	1	2	110	10	\$2,258	
<b>Racetrack Tops</b> 	BG60264RT	60	264	24	3	4	646	57	\$17,511
	BG60240RT	60	240	22	3	4	589	51	\$15,920
	BG60216RT	60	216	20	3	4	530	48	\$14,331
	BG60192RT	60	192	18	2	3	471	42	\$12,740
	BG54264RT	54	264	22	3	4	586	52	\$14,592
	BG54240RT	54	240	20	3	4	530	50	\$13,267
	BG54216RT	54	216	18	3	4	474	43	\$11,942
	BG54192RT	54	192	16	2	3	417	38	\$10,615
	BG48264RT	48	264	22	3	4	529	47	\$12,973
	BG48240RT	48	240	20	3	4	479	43	\$11,795
	BG48216RT	48	216	18	3	4	428	38	\$10,615
	BG48192RT	48	192	16	2	3	377	33	\$9,436
	BG48168RT	48	168	14	2	3	327	30	\$8,159
	BG48144RT	48	144	12	2	3	277	28	\$7,080
	BG48120RT**	48	120	8	2	2	226	22	\$5,903
	BG4896RT	48	96	8	1	2	185	17	\$4,724
	BG42120RT**	42	120	8	2	2	203	19	\$5,164
	BG42108RT	42	108	8	2	2	180	17	\$4,648
	BG4296RT	42	96	8	1	2	157	15	\$4,131
	BG4284RT	42	84	8	1	2	142	13	\$3,632
BG3672RT	36	72	6	1	2	100	10	\$2,662	

BROGAN

\*\*When ordering RECTANGLE or PANEL BASES - BG48120 and BG42120 require (3) panel bases and additional stretchers. Stretchers will be included as required.

\*\*When ordering RECTANGLE or PANEL BASES - BG48120 and BG42120 require (3) panel bases and additional stretchers. Stretchers will be included as required.

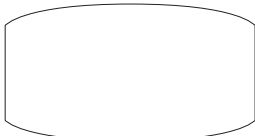
Description	① Model	W	L	Seat Capacity	Top Pieces	Bases Required	CTN WT	CU FT	List Price	
<b>Boat Shape Tops</b> 	BG60264BT	60	264	24	3	4	646	57	\$17,511	
	BG60240BT	60	240	22	3	4	589	51	\$15,920	
	BG60216BT	60	216	20	3	4	530	48	\$14,331	
	BG60192BT	60	192	18	2	3	471	42	\$12,740	
	BG54264BT	54	264	22	3	4	586	52	\$14,592	
	BG54240BT	54	240	20	3	4	530	50	\$13,267	
	BG54216BT	54	216	18	3	4	474	43	\$11,942	
	BG54192BT	54	192	16	2	3	417	38	\$10,615	
	Stretchers will be included as required.	BG48264BT	48	264	22	3	4	529	47	\$12,973
		BG48240BT	48	240	20	3	4	479	43	\$11,795
		BG48216BT	48	216	18	3	4	428	38	\$10,615
		BG48192BT	48	192	16	2	3	377	33	\$9,436
		BG48168BT	48	168	14	2	3	327	30	\$8,159
		BG48144BT	48	144	12	2	3	277	28	\$7,080
		BG48120BT**	48	120	8	2	2	226	22	\$5,903
		BG4896BT	48	96	8	1	2	185	17	\$4,724
BG42120BT**		42	120	8	2	2	203	19	\$5,164	
BG42108BT		42	108	8	2	2	180	17	\$4,648	
BG4296BT	42	96	8	1	2	157	15	\$4,131		
BG4284BT	42	84	8	1	2	142	13	\$3,632		
BG3672BT	36	72	6	1	2	100	10	\$2,662		

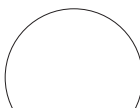
Description	① Model	W	L	Seat Capacity	Top Pieces	Bases Required	CTN WT	CU FT	List Price
<b>Round Tops</b> 	BG60TT	60	N/A	6	1	1	112	10	\$2,971
	BG54TT	54	N/A	6	1	1	92	8	\$2,231
	BG48TT	48	N/A	4	1	1	73	7	\$1,758
	BG42TT	42	N/A	4	1	1	56	5	\$1,344
	BG36TT	36	N/A	3	1	1	42	4	\$1,183

Description	① Model	W	L	Seat Capacity	Top Pieces	Bases Required	CTN WT	CU FT	List Price
<b>Square Tops</b> 	BG6060TT	60	60	8	1	1	154	10	\$2,722
	BG5454TT	54	54	6	1	1	125	8	\$2,062
	BG4848TT	48	48	4	1	1	99	7	\$1,627
	BG4242TT	42	42	4	1	1	77	5	\$1,248
	BG3636TT	36	36	4	1	1	56	4	\$1,126

**To Order, Specify:**

- ① Model Number
- ② Wood Species
- ③ Finish Color
- ④ Power and Data Options (see pages 519-535)
- ⑤ Other Product Options

When ordering Quickship products, place a "Q" in front of model number.  
 Example: QBG3072DD

**NOW!**  
*Need it.*  
 JSI Quickship

BROGAN

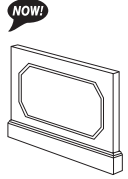
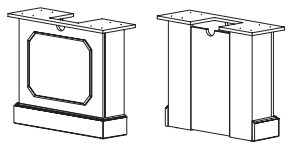
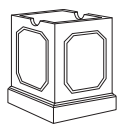
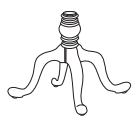
Description	D	W	H	CTN WT	CU FT	① Model	List Price
<b>Panel Base</b> 	2 5/16	36	28 3/4	88	6	<b>BG3628PB</b> · for use with 60" width top	\$1,055
	2 5/16	30	28 3/4	73	5	<b>BG3028PB</b> · for use with 54" width top	\$932
	2 5/16	24	28 3/4	59	4	<b>BG2428PB</b> · for use with 36", 42", and 48" width top · (3) bases are required when ordering BG48120 or BG42120	\$807
<b>Rectangle Base</b> 	7 5/8	36	28 3/4	74	7	<b>BG3628PBA</b> · for use with 60" width top · access panel	\$1,489
	7 5/8	30	28 3/4	66	6	<b>BG3028PBA</b> · for use with 54" width top · access panel	\$1,423
	7 5/8	24	28 3/4	56	5	<b>BG2428PBA</b> · for use with 36", 42", and 48" width top · access panel	\$1,355
<b>Square Base</b> 	30	30	28 3/4	73	16	<b>BG30SB</b> · for use with 60" width top	\$1,336
	30	30	28 3/4	73	16	<b>BG30SBA</b> · for use with 60" width top · access panel	\$1,462
	24	24	28 3/4	74	12	<b>BG24SB</b> · for use with 54" width top	\$1,210
	24	24	28 3/4	74	12	<b>BG24SBA</b> · for use with 54" width top · access panel	\$1,339
	18	18	28 3/4	45	7	<b>BG18SB</b> · for use with 36", 42" and 48" width top	\$1,082
	18	18	28 3/4	45	7	<b>BG18SBA</b> · for use with 36", 42" and 48" width top · access panel	\$1,214
<b>Cabriole Base</b> 	33	33	28 3/4	30	16	<b>BG33CB</b> · for use with 36", 42" and 48" width top	\$1,229

BROGAN

Description	D	W	H	Seating Capacity	CTN WT	CU FT	① Model	List Price
Conference Lectern	23	27	48	250	23		BG2723LEC	\$3,112

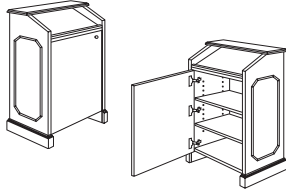

- two adjustable shelves
- four concealed, locking casters
- door is non-locking
- standard door is hinged on left
- round grommet in bottom panel
- notches in adjustable shelves allow wires to pass through

Visual Board	3½	48	48	125	8		BG4848VB	\$3,749
--------------	----	----	----	-----	---	--	----------	---------

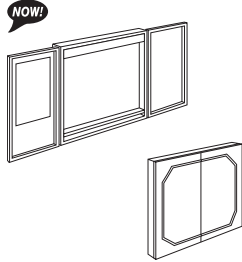

- corkboard on left and right doors; paper pad on left only
- marker board in center
- four markers and eraser included
- locking not available

Buffet Credenza	24	72	36	330	43		BG2472BSC	\$5,523
-----------------	----	----	----	-----	----	--	-----------	---------

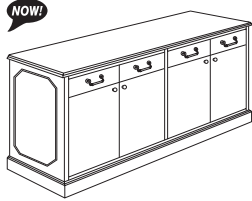

- four door credenza
- four box drawers above doors
- locking not available
- adjustable shelf in storage cabinet

Buffet Credenza - Flat Screen Support	24	72	36	330	43		BG2472BSCT	\$5,974
---------------------------------------	----	----	----	-----	----	--	------------	---------

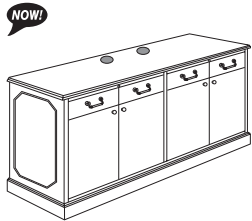

- four door credenza
- four box drawers above doors
- locking not available
- adjustable shelf in storage cabinet
- flat screen mounting grommets in top
- back panel includes cord exit grommets

Flat Screen Mounting Frame	2	14	55	35	4		FSTV	\$1,494
----------------------------	---	----	----	----	---	--	------	---------

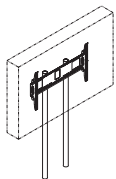

- round 2" tube frame with cable management to inside of credenza
- mounting bracket for TV provided (see page 531)
- available in black (B) or silver (S)
- TV not included
- TV dimension not to exceed 70"w x 38"h to allow proper mounting clearance
- coordinates with BG2472BSCT

**To Order, Specify:**

- ① Model Number
- ② Wood Species
- ③ Finish Color
- ④ Hardware Color - Antique Brass or Pewter
- ⑤ Power and Data Options (see pages 519-535)
- ⑥ Other Product Options

When ordering Quickship products, place a "Q" in front of model number.  
Example: QBG3072DD

**NOW!**  
Need it.  
JSI Quickship

Description	D	W	H	CTN WT	CU FT	① Model	List Price
72" h File/File Lateral Storage Cabinet	24	36	72	360	43	BG3672SWLF	\$4,986

**NOW!**

- two adjustable shelves
- locking doors available; specify and add \$123 list
- file/file lateral
- pedestal locking

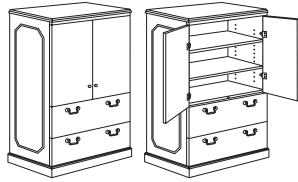

BROGAN

72" h Wardrobe	24	34 3/8	72	360	43	BG3672W	\$3,565
----------------	----	--------	----	-----	----	---------	---------

**NOW!**

- chrome hanging bar on right
- shelves on left (second from bottom fixed)
- locking doors available; specify and add \$246 list

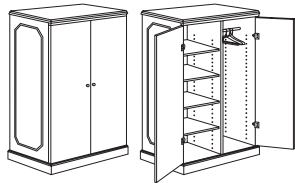



Description	D	W	H	Seating Capacity	CTN WT	CU FT	① Model	List Price
72" h File/File Storage Wardrobe	24	23 5/8	72	340	30		BG2472SWR	\$3,457
	24	23 5/8	72	340	30		BG2472SWL	\$3,457

**NOW!**

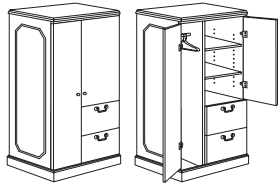

left shown

- chrome hanging bar
- two adjustable shelves
- bottom shelf fixed
- file/file pedestal
- locking not available

Hanging Bar to Shelves Conversion Kit				3/4	56	2	BG1824SK	\$767
---------------------------------------	--	--	--	-----	----	---	----------	-------

**NOW!**

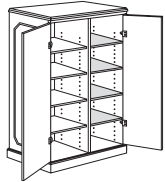

- four shelves
- for 36" wide wardrobe

**To Order, Specify:**

- ① Model Number
- ② Wood Species
- ③ Finish Color
- ④ Pull Style and Color (see page 294)
- ⑤ Power and Data Options (see pages 519-535)
- ⑥ Other Product Options

When ordering Quickship products, place a "Q" in front of model number.  
Example: QBG3072DD

**NOW!**  
*Need it.*  
JSI Quickship



## Collective Conference Tables Product Information



COLLECTIVE CONFERENCE

## Collective Conference Tables Product Information

### Exterior Wood Materials

Exterior surfaces are made from the finest selected veneers to achieve clarity and consistency in the Collective Conference product line. To attain a pleasing, symmetrical pattern, all veneers in Collective Conference are book-matched. All exterior solid lumber is matched to coordinate with the veneer.

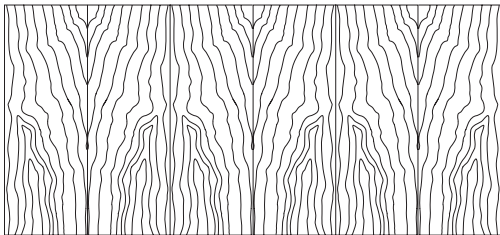

#### Book Matched Example

Alternating pieces of veneer are flipped over so they face each other like the pages within a book.

Collective Conference is available in flat cut cherry, maple, and walnut veneer. A wide range of wood stains have been formulated to enhance the beauty of the veneer.

Solid painted finishes on MDF are also offered on bases, drawer and door fronts to provide an accent to the Collective Conference product.

### Work Surface Construction

All tops are 1 3/16" thick with 3-ply construction and trimmed off with matching 1.5mm rims.

Tops are available in wood veneer, applied glass or laminate surfaces. No additional charges for laminate when selecting standard coordinating laminate as listed on the top of the next page.

### Chassis Construction

The chassis consists of cherry, maple or walnut book-matched veneer. Mortise and tenon construction. Adjustable leveling glides ensure proper leveling of unit.

### Extruded Aluminum Components

Telescopic Feet, Edge Trim Rails, Center Console Components, and Spacers all are made from an alloy aluminum compound, made up of 10% post consumer scrap, 60% post industrial scrap and 30% primary aluminum. The aluminum meets or exceeds the guidelines of USGBC - LEED V2.2. The parts are precisely machined and then processed in a clear anodized finish for a natural aluminum appearance.

### Fabricated or Casted Metal Components

Base Trims, Base Pans, Scones and Wire Pans are made up of high grade metals. The metal is laser cut, bent to shape and robotically welded to the exact specifications, polished and powder coated to blend with the anodized aluminum.

### Finish - Stain/Colors

We offer a variety of wood stains and paint colors on Collective Conference. Please see the chart below. Samples are available upon request, through our website or by contacting Customer Service.

<b>CH1 Cherry</b> <i>Flat Cut Veneer</i>	
BRL Barley	EAR Earthy
BBM Bourbon Medium	HRV Harvest*
BRM Brighton Medium	LGC Legacy
CLA Classic	PRL Praline*
CLL Collectors*	SAF Saffron

<b>MA1 Maple</b> <i>Flat Cut Veneer</i>	
ALM Ale Medium	FLX Flax
BUT Butterscotch	VEN Venetian
CIN Cinnamon	

<b>WA1 Walnut</b> <i>Flat Cut Veneer</i>	
AUB Auburn	SIE Sienna*
ESP Espresso	TOF Toffee
MCH Mocha*	TRF Truffle*
NTO Night Owl*	

<b>PNT Paint</b> <i>MDF Board</i>	
BKD Backdrop	GRV Greek Villa
BFX Black Fox	NET Network Gray
BWH Bright White	NWH Nonchalant White
CGP Cargo Pants	STM Storm
CHT Chatroom	TRC Tricorn Black
FRR French Roast	

\*finishes with coordinating laminate tops.

### Protective Top Coat

DuraTex™ offers exceptional hardness along with abrasion and impact resistance, it has been formulated to eliminate hazardous and harmful gases that are normally associated with wood finish.

### DuraTex™ Features

**Safety** - Significantly reduces hazardous formaldehyde emissions which help improve the quality of the indoor air we breathe.

**Quality** - Developed to be tough and durable with special attention to appearance. The DuraTex™ finish preserves the natural beauty of wood.

**Durability** - Designed to meet a wide range of demanding performance and environmental standards to withstand even the highest wear and tear.

## Collective Conference Tables Product Information

### Product Modification

#### Laminate Tops

Work surface only, no additional upcharge if coordinating wood grain laminate is specified. Contact Customer Service for any other laminate request.

Cherry Finishes	Maple Finishes	Walnut Finishes
<i>Barley</i>	<i>Ale Light</i>	<i>Auburn</i>
<i>Bourbon Light</i>	<i>Cinnamon</i>	<i>Mocha</i>
<i>Brighton Light</i>	<i>Venetian</i>	<i>Night Owl</i>
<i>Classic</i>		<i>Sienna</i>
<i>Collectors</i>		<i>Toffee</i>
<i>Harvest</i>		<i>Truffle</i>
<i>Legacy</i>		
<i>Praline</i>		
<i>Saffron</i>		

#### Special Finishes

Special finishes can be requested by following the instructions in the general introduction section, page 3. There is a one time charge of \$332 list per order.

#### Special Top Sizes and Cabinets

Collective Conference offers a large offering of table tops shapes and sizes, along with the Collective Presentation products to create a perfect meeting room. Contact Customer Service if you are having trouble finding the right units to complete the desired configuration. Special sizes and cabinet variations need to be approved by JSI engineering.

## Collective Conference Tables Product Information

### Top Edge Profiles

Collective Conference offer two edges profiles, along with optional details.

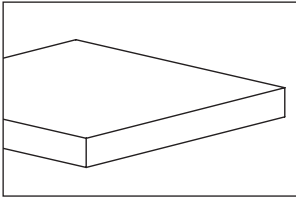

#### Straight Edge - Veneer

Standard on conference tables and casegoods products.

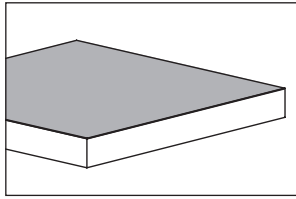

#### Straight Edge - Laminate

Straight edge with laminate surface available for conference tables and casegood products. See page 307 for standard wood grain laminate.

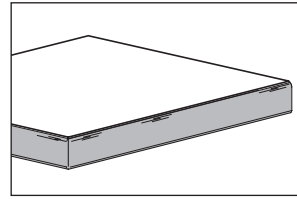

#### Aluminum Trim Edge Detail

Aluminum trim edge available only on Veneer rectangular shape conference tops. The trim edge is finished in clear anodized finish.

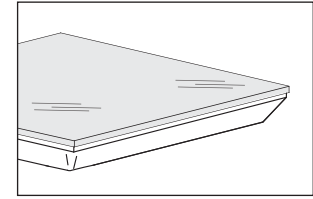

#### Thin Profile Edge - Glass

Reverse Bevel edge is available with low iron white back painted glass in glossy or frosted surface. Available only on conference table tops.

### Base Types

Collective Conference offers five base styles: open cable, closed cable, rectangular, panel and arc end.

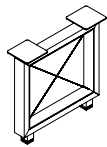

Open Cable Base

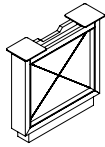

Closed Cable Base

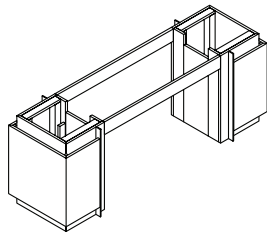

Rectangular Base with Apron Rails

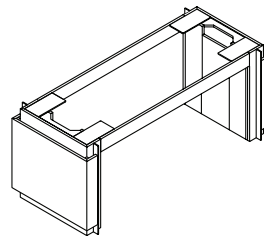

Panel Base with Apron Rails

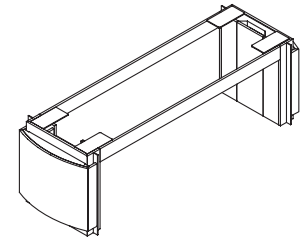

Arc End Base with Apron Rails

### Foot/Plinth Style Base

Collective Conference Open Cable Base and Casegoods features an anodized aluminum foot. For a more classic feel, units may be specified with a wood plinth style base. Rectangular, Panel and Arc End Bases are available only with a plinth base.

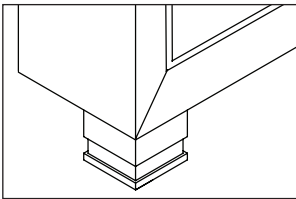

#### Foot Style

Anodized Aluminum Finish

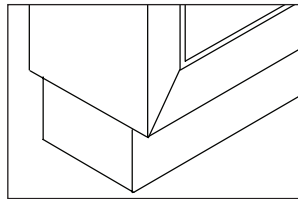

#### Plinth Base

Concealed leveling glide

### Foot Leveling Details

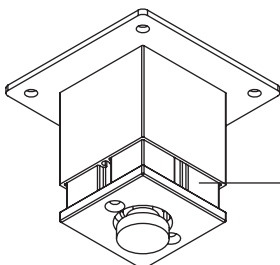

Telescopic cover can slide up to provide access for leveling adjustment

# Collective Conference Tables Product Information

## Conference Top Shapes and Sizes

Collective Conference offer six top shapes and sizes start at 216" in length. Note size 120" and above are two piece tops.

rectangular	arc end	racetrack	boat	ellipse	view
216" x 60" Seats 18/20 192" x 60" Seats 16/18 168" x 60" Seats 14/16 144" x 60" Seats 10/12 216" x 48" Seats 16/18 192" x 48" Seats 14/16 168" x 48" Seats 12/14 144" x 48" Seats 8/10 120" x 48" Seats 6/8 96" x 48" Seats 6/8 84" x 42" Seats 4/6 72" x 36" Seats 4/6	216" x 60" Seats 16/18 192" x 60" Seats 14/16 168" x 60" Seats 12/14 144" x 60" Seats 10/12 216" x 48" Seats 16/18 192" x 48" Seats 14/16 168" x 48" Seats 12/14 144" x 48" Seats 8/10 120" x 48" Seats 6/8 96" x 48" Seats 6/8 84" x 42" Seats 4/6 72" x 36" Seats 4/6	216" x 60" Seats 18/20 192" x 60" Seats 16/18 168" x 60" Seats 14/16 144" x 60" Seats 10/12 216" x 48" Seats 16/18 192" x 48" Seats 14/16 168" x 48" Seats 12/14 144" x 48" Seats 8/10 120" x 48" Seats 6/8 96" x 48" Seats 6/8 84" x 42" Seats 4/6 72" x 36" Seats 4/6	216" x 60" Seats 16/18 192" x 60" Seats 14/16 168" x 60" Seats 12/14 144" x 48" Seats 8/10 120" x 48" Seats 6/8 96" x 48" Seats 6/8	144" x 60" Seats 10/12 120" x 54" Seats 8/10 96" x 48" Seats 6/8	168" x 60" Seats 12/14 144" x 60" Seats 10/12 120" x 60" Seats 9/10 96" x 60" Seats 7/8  <i>This shape top is only available with bases</i>

## Open Cable Bases

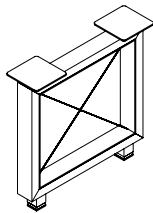

The open cable base features a 1<sup>3</sup>/<sub>16</sub>" X-shaped stainless steel cable accent. Open cable bases provide no wire management compartment. The outer frame is wood with a metal inner frame in silver powder coat. Telescopic feet provide 1<sup>1</sup>/<sub>2</sub>" leveling adjustment.

Configured tables with cable bases in this price list include support rails for the top.

Cable bases are not for use with 60"d tops. When specifying cable bases and tops separately, support rails may need to be included. Call Customer Service for more information.

## Closed Cable Bases

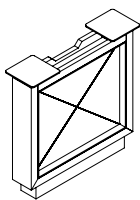

Outside Base  
side 1 (approach)

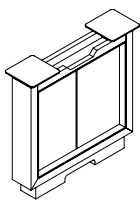

side 2

Closed cable bases include a hinged door compartment and plinth base for wire management.

The outside closed cable base features a visible 1<sup>3</sup>/<sub>16</sub>" X-shaped stainless steel cable accent on the side opposite the hinge door. Wires pass through an opening above hinged doors. The base is wood with a silver powder coated inner frame.

The middle closed cable base features a wood panel on the side opposite the side hinged door. Wires pass through an opening at the top of both sides.

Configured tables with cable bases in this price list include support rails for the top.

Cable bases are not for use with 60"d tops. When specifying cable bases and tops separately, support rails may need to be included. Call Customer Service for more information.

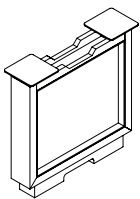

Middle Base  
side 1

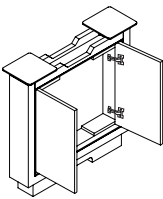

side 2

# Collective Conference Tables Product Information

## Panel Bases

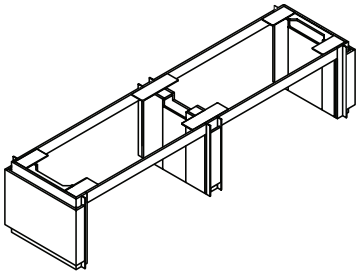

The panel base features slim wood pedestals surrounded by a wood accent. Each pedestal has a hinged door for wire management access and features a silver powder coat metal fin detail.

The panel base is standard with rectilinear end bases. Arc end bases may be specified as an option.

## Arc End Bases

*(an option to the panel base)*

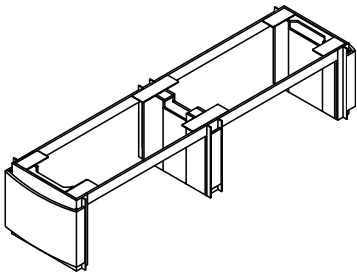

COLLECTIVE CONFERENCE

## Rectangular Bases

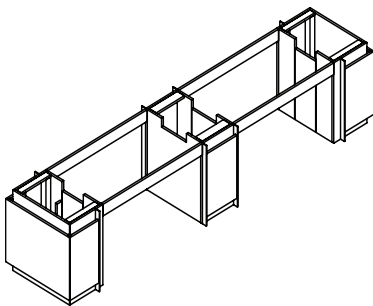

The rectangular base features wide wood pedestals surrounded by a wood accent. Each pedestal has a hinged door for wire management access, an ample storage compartment, and features a silver powder coat metal fin detail.



# Collective Conference Tables Product Information

## Open Cable Base

The open cable base is available in veneer only.

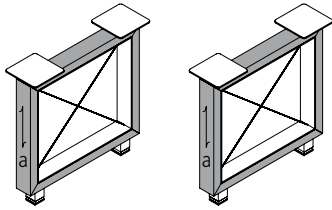

Open Cable Base

a. outer frame - veneer only

## Closed Cable Base

There are two material options for the closed cable base. The outer frame and plinth are always veneer. The inner panel/door can be specified in the matching veneer or in a contrasting paint.

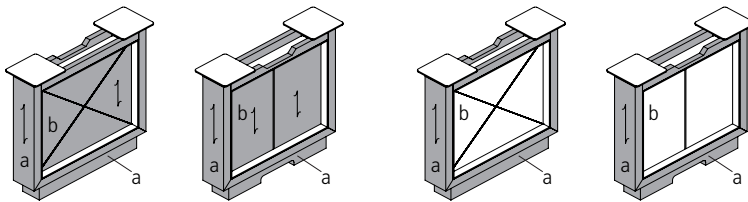

a. outer frame/plinth - veneer  
b. inner panel/door - veneer

a. outer frame/plinth - veneer  
b. inner panel/door - paint

*photo copy or scan, submit with quote/order*

### Cable Base Ordering Worksheet

#### Open Cable Base

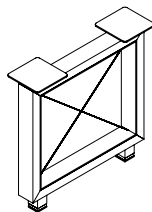

outer frame (a) - veneer only

wood species (choose one)

- cherry
- maple
- walnut

finish color - outer frame (a) \_\_\_\_\_  
(see page 306 for finish choices)

base

- feet
- plinth (veneer and finish matches outer frame)

metal frame / cable - arctic silver (standard)

#### Closed Cable Base

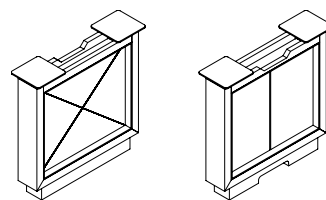

outer frame (a) - veneer only

wood species (choose one)

- cherry
- maple
- walnut

finish color - outer frame (a) \_\_\_\_\_  
(see page 306 for finish choices)

plinth style base only (veneer and finish matches outer frame)

inner panel/doors (b) - paint or veneer

- veneer (veneer and finish matches outer frame)
- paint

color - inner panel/doors (b) \_\_\_\_\_  
(see page 306 for paint choices)

metal frame / cable - arctic silver (standard)

# Collective Conference Tables Product Information

## Panel and Rectangular Base Material Options

There are four finish schemes available for the panel (flat or arc) and rectangular bases.

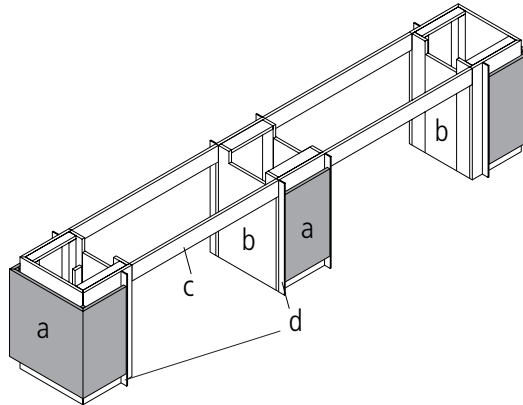
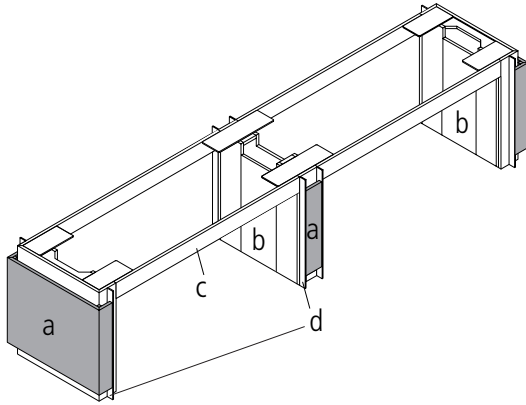

### Table Base - Panel Style Parts

- a. accent panel and middle trim
- b. base cabinet
- c. apron
- d. metal trim fin

### Table Base - Rectangular Style Parts

- a. accent surround and middle trim
- b. base cabinet
- c. apron
- d. metal trim fin

### Finish Schemes

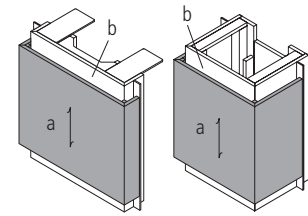
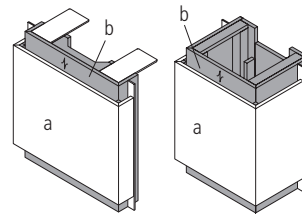
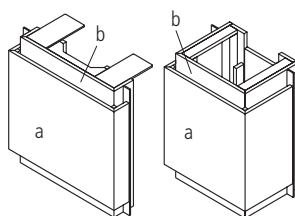
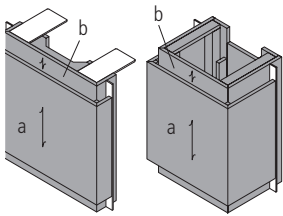

#### Scheme 1 - all veneer

- a. accent panel or surround - veneer
- b. base pedestal - veneer
- c. apron (shown below) - veneer

#### Scheme 2 - all paint

- a. accent panel or surround - paint
- b. base pedestal - paint
- c. apron (shown below) - paint

#### Scheme 3 - veneer and paint

- a. accent panel or surround - paint
- b. base pedestal - veneer
- c. apron (shown below) - veneer

#### Scheme 4 - paint and veneer

- a. accent panel or surround - veneer
- b. base pedestal - paint
- c. apron (shown below) - paint

photo copy or scan, submit with quote/order

### Table Base Ordering Worksheet

part a - veneer or paint choice

(choose one)

cherry

maple

walnut

paint (MDF board)

finish or paint color - see page 306 for finish and paint choices) (part a) \_\_\_\_\_

part b & c- veneer or paint choice

(choose one)

cherry

maple

walnut

paint (MDF board)

finish or paint color - see page 306 for finish and paint choices) (part b) \_\_\_\_\_

part d - metal fin trim - arctic silver (standard)

## Collective Conference Tables Product Information

### Round Meeting Tables and Bases

Collective Conference offers three styles of round meeting tables in several diameter sizes.

#### Glass Top with Column Disc Base

Available Tables - 48" dia - 42" dia - 36" dia (seats 3 to 4)

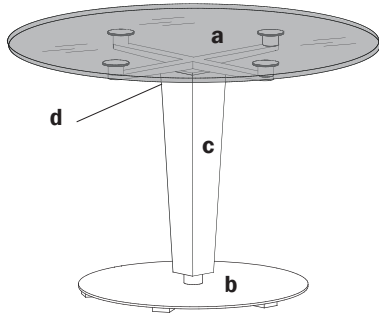

- a Top - ½" glass - frosted glass - acid etch underside
- b Base - 26" dia - cast aluminum - arctic silver powder coat
- c Column - veneer  
cherry, maple, and walnut - (choice of one)
- d Spider Armature - glass puck (ultra-violet glue attachment) - arctic silver powder coat

#### Veneer Top with Column Disc Base

Available Tables - 48" dia - 42" dia - 36" dia - 30" dia (seats 3 to 4)

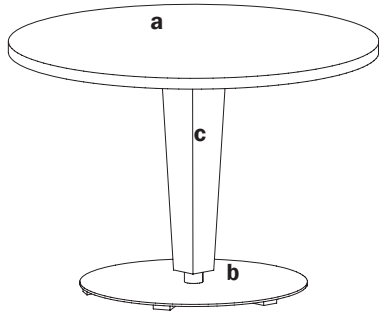

- a Top - 1½" veneer top (laminated surface available see page 307) -
- b Base - 26" dia - cast aluminum - arctic silver powder coat
- c Column - veneer  
cherry, maple, and walnut - (choice of one)

#### Veneer Top with Cylinder Base

Available Tables - 48" dia - 42" dia (seats 3 to 4)

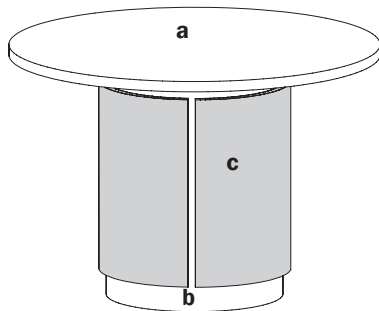

- a Top - 1½" veneer top (laminated surface available see page 307)
- b Cylinder Base - 24" dia - drum style construction
- c Accent Panel - veneer (choice of one)  
cherry, maple and walnut  
paint - (see page 306 for color choices)

## Collective Conference Tables Product Information

### Center Console Overview

The continuous center console supports a variety of functional and aesthetic options. A Collective Conference table with center console includes: the center spine assembly which houses 4", 8", 12" and 16" modules, ordered separately, the understructure of the console, and wire management tray as illustrated below.

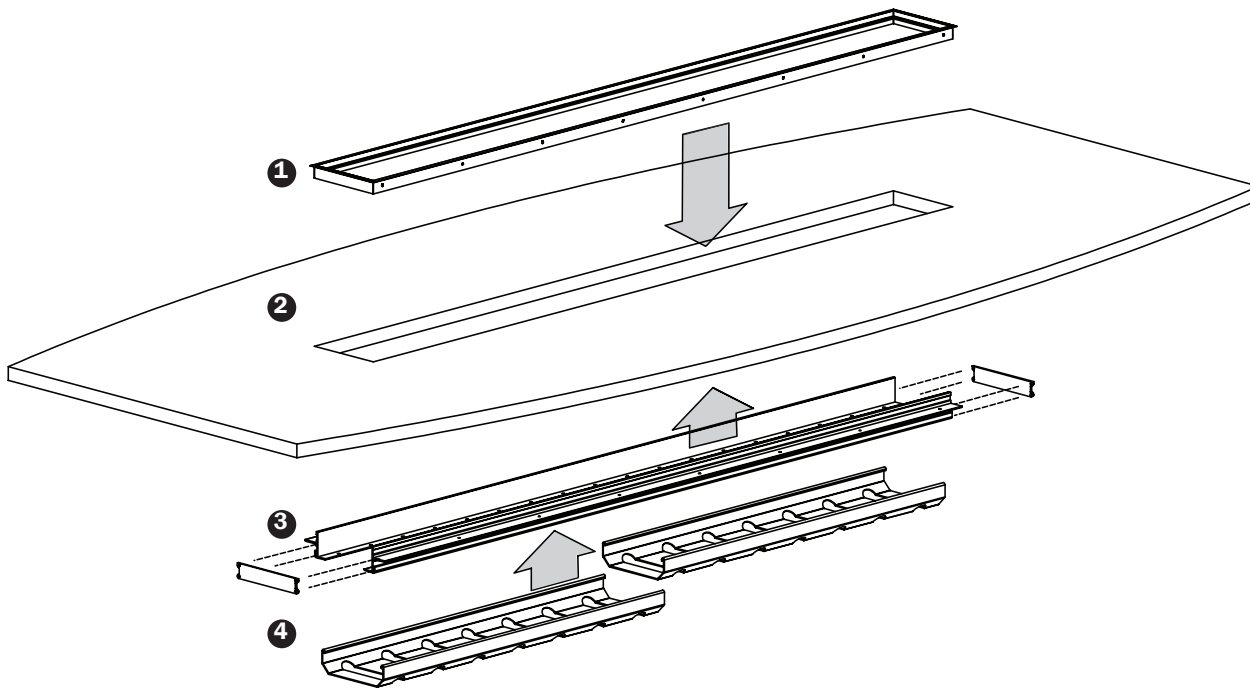

- 1 Center Spine Bezel Assembly**  
The center spine bezel assembly accepts the 4", 8", 12" and 16" modules shown on pages 315, 390-391 of the pricing section of this price list.

- 3 Center Spine Structural Extrusion Assembly**  
When a table with center console is specified, the center spine structural extrusion assembly is attached to the underside of the table top.

- 2 Table Top**  
Tops are available in several shapes including rectangular, racetrack, ellipse, arc end, boat and view. They come with or without center console.

- 4 Wire Management Tray**  
When using power/data and lamp modules, the wire management tray channels the cords to the panel or rectangular bases.

# Collective Conference Tables Product Information

## Center Console Components

Collective Conference is available with a center console for storage, power/data and accessories. The center console is offered in lengths of: 48", 72", 96", 120", 144" & 160". The accessories are offered in 4" increments. When designing your center console the accessories selected must equal the length of your console. The center console is factory installed.

**You must specify the order in which you want the accessories to appear using the chart on the bottom of the page.**

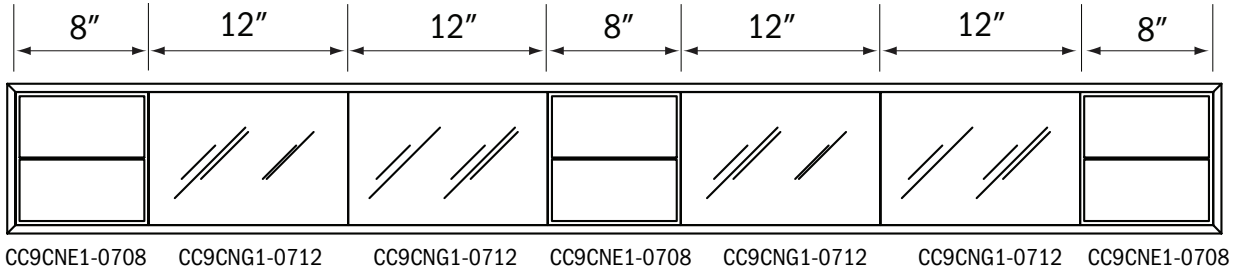

### Center Console Accessories

#### Storage

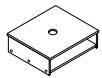

CC9CNS1-0708  
8"

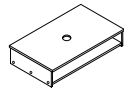

CC9CNS1-0712  
12"

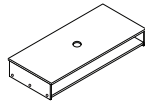

CC9CNS1-0716  
16"

#### Glass Panels



CC9CNG1-0708  
8"

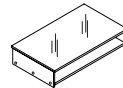

CC9CNG1-0712  
12"

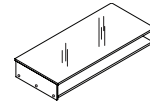

CC9CNG1-0716  
16"

#### Lamp

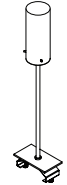

CC9CML1-0704  
4"

#### Vase



CC9CNV1-0704  
4"

#### Accessory Shelf



CC9CNA1-1516  
16"

#### Coaster

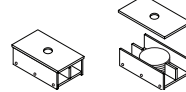

CC9CNC1-0704  
4"

#### Power Data Module

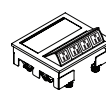

CC9CNE1-0708  
8"

*photo copy or scan, submit with quote/order*

### Center Console Worksheet - Order Sheet

**A** Use the following chart to determine the console length.

Table Length	Console Length
216"	160"
192"	144"
168"	120"
144"	96"
120"	72"
96"	48"

**B** List out the order in which you want the accessories to appear in the console.

Console Length \_\_\_\_\_

Item	Length	Item	Length
1. _____	_____	11. _____	_____
2. _____	_____	12. _____	_____
3. _____	_____	13. _____	_____
4. _____	_____	14. _____	_____
5. _____	_____	15. _____	_____
6. _____	_____	16. _____	_____
7. _____	_____	17. _____	_____
8. _____	_____	18. _____	_____
9. _____	_____	19. _____	_____
10. _____	_____	20. _____	_____

\*Total length of accessory items must equal total length of console. \_\_\_\_\_

## Collective Conference Tables Product Information

### Finish and Product Reference Codes

Select	Code	Select	Code	Select	Code
<b>Veneer</b>		Walnut Finishes		<b>Laminate Coordinates</b>	
Cherry	CH1	Auburn	AUB	Cherry Wood Grain Patterns	
Maple	MA1	Espresso	ESP	Collectors	CLL
Walnut	WA1	Mocha	MCH	Harvest	HRV
<b>Finish</b>		Night Owl	NTO	Praline	PRL
Cherry		Sienna	SIE	Walnut Wood Grain Patterns	
Barley	BRL	Toffee	TOF	Mocha	MCH
Bourbon Medium	BBM	Truffle	TRF	Night Owl	NTO
Brighton Medium	BRM	Paint Finishes		Sienna	SIE
Classic	CLA	Backdrop	BKD	Truffle	TRF
Collectors	CLL	Black Fox	BFX	<b>Metal Finish</b>	
Earthy	EAR	Bright White	BWH	Arctic Silver	ASL
Harvest	HRV	Cargo Pants	CGP	Anodized Aluminum	AAL
Legacy	LGC	Chatroom	CHT		
Praline	PRL	French Roast	FRR		
Saffron	SAF	Greek Villa	GRV		
Maple Finishes		Network Gray	NET		
Ale Medium	ALM	Nonchalant White	NWH		
Butterscotch	BUT	Storm	STM		
Cinnamon	CIN	Tricorn Black	TRC		
Flax	FLX				
Venetian	VEN				

COLLECTIVE CONFERENCE

### Order Check List:

Specify:

- 1. Model Number
- 2. Finish Scheme/Color (see pages 311-313)
- 3. Wood Species - cherry - maple - walnut
- 4. Top Options - standard veneer - laminate surface (see page 306) - back painted white glass (glossy or frosted surface)
- 5. Aluminum Trim (rectangular tops only) - **if applicable**
- 6. Console Insert Accessories - **if applicable - order items separately**
- 7. Other Product Options
- 8. Power and Data Accessories (*drawing showing location and orientation must accompany order*)
- 9. Side Mark Information (*i.e. room number, East Conference Room*)
- 10. Shipping Address (*contact name and phone number*)
- 11. Special Delivery Instructions (*i.e. call before delivery, deliver to job site*)



Description	① Model	D	L	H	Seat Capacity	Top Pieces	Bases Required	CTN WT	CU FT	Veneer	Glass Top
-------------	---------	---	---	---	---------------	------------	----------------	--------	-------	--------	-----------

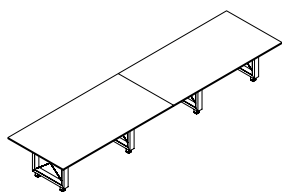

<b>Rectangular Table with Open Cable Base</b>	<b>CC8JRX1-48192</b>	48	192	29	14	2	4	561	32	\$25,151	\$36,505
---	----------------------	----	-----	----	----	---	---	-----	----	----------	----------

- short grain veneer direction
- base (4) CC8NC01-0427
- telescopic feet are anodized aluminum
- telescopic feet provide 1 1/2" leveling
- top is 1 1/4" thick and in two sections
- laminate worksurface, no charge if standard laminate is selected
- glass worksurface with reverse bevel edge, (see page 308)
- aluminum edge available on veneer and laminate tops, specify and add \$5,289 list

Rectangular Table with Open Cable Base

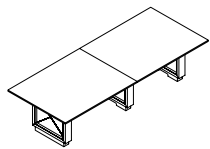

	<b>CC8JRX1-48168</b>	48	168	29	12	2	3	460	26	\$19,764	\$29,701
	<b>CC8JRX1-48144</b>	48	144	29	8	2	3	421	24	\$18,280	\$26,796
	<b>CC8JRX1-48120</b>	48	120	29	6	2	3	381	21	\$17,082	\$23,756

- short grain veneer direction
- base (3) CC8NC01-0427
- telescopic feet are anodized aluminum
- telescopic feet provide 1 1/2" leveling
- top is 1 1/4" thick and in two sections
- laminate worksurface, no charge if standard laminate is selected
- glass worksurface with reverse bevel edge, (see page 308)
- aluminum edge available on veneer and laminate tops, specify and add \$4,762 list for CC8JRX1-48168, \$4,232 list for CC8JRX1-48144 and \$3,704 list for CC8JRX1-48120

Rectangular Table with Open Cable Base

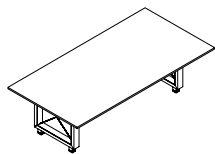

<b>Rectangular Table with Open Cable Base</b>	<b>CC8JRX1-4896</b>	48	96	29	6	1	2	281	16	\$11,704	\$17,044
---	---------------------	----	----	----	---	---	---	-----	----	----------	----------

- long grain veneer direction
- base (2) CC8NC01-0427
- telescopic feet are anodized aluminum
- telescopic feet provide 1 1/2" leveling
- top is 1 1/4" thick
- laminate worksurface, no charge if standard laminate is selected
- glass worksurface with reverse bevel edge, (see page 308)
- aluminum edge available on veneer and laminate tops, specify and add \$3,176 list

Rectangular Table with Open Cable Base

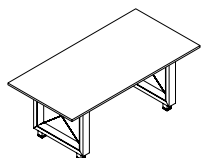

<b>Rectangular Table with Open Cable Base</b>	<b>CC8JRX1-4284</b>	42	84	29	4	1	2	219	14	\$9,520	\$13,608
	<b>CC8JRX1-3672</b>	36	72	29	4	1	2	189	12	\$8,802	\$11,806

- long grain veneer direction
- base (2) CC8NC01-0423
- telescopic feet are anodized aluminum
- telescopic feet provide 1 1/2" leveling
- top is 1 1/4" thick
- laminate worksurface, no charge if standard laminate is selected
- glass worksurface with reverse bevel edge, (see page 308)
- aluminum edge available on veneer and laminate tops, specify and add \$2,779 list for CC8JRX1-4284, \$2,383 list for CC8JRX1-3672

COLLECTIVE CONFERENCE



Description	① Model	D	L	H	Seat Capacity	Top Pieces	Bases Required	CTN WT	CU FT	Veneer	Glass Top
Arc End Table with Open Cable Base	<b>CC8JAX1-48192</b>	48	192	29	14	2	4	561	32	\$25,679	\$37,033
	<ul style="list-style-type: none"> <li>• short grain veneer direction</li> <li>• base (4) CC8NC01-0427</li> <li>• telescopic feet are anodized aluminum</li> <li>• telescopic feet provide 1 1/2" leveling</li> <li>• top is 1 1/4" thick and in two sections</li> <li>• laminate worksurface, no charge if standard laminate is selected</li> <li>• glass worksurface with reverse bevel edge, (see page 308)</li> </ul>										

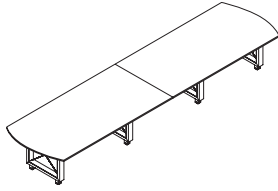

Arc End Table with Open Cable Base	<b>CC8JAX1-48168</b>	48	168	29	12	2	3	460	26	\$20,216	\$30,151
	<b>CC8JAX1-48144</b>	48	144	29	8	2	3	421	24	\$18,658	\$27,173
	<b>CC8JAX1-48120</b>	48	120	29	6	2	3	381	21	\$17,390	\$24,063

- short grain veneer direction
- base (3) CC8NC01-0427
- telescopic feet are anodized aluminum
- telescopic feet provide 1 1/2" leveling
- top is 1 1/4" thick and in two sections
- laminate worksurface, no charge if standard laminate is selected
- glass worksurface with reverse bevel edge, (see page 308)

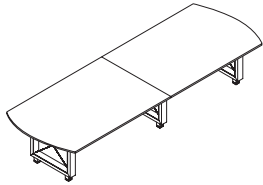

Arc End Table with Open Cable Base	<b>CC8JAX1-4896</b>	48	96	29	6	1	2	281	16	\$11,927	\$17,267
------------------------------------	---------------------	----	----	----	---	---	---	-----	----	----------	----------

- long grain veneer direction
- base (2) CC8NC01-0427
- telescopic feet are anodized aluminum
- telescopic feet provide 1 1/2" leveling
- top is 1 1/4" thick
- laminate worksurface, no charge if standard laminate is selected
- glass worksurface with reverse bevel edge, (see page 308)

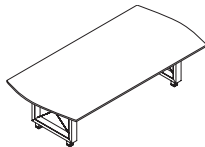

Arc End Table with Open Cable Base	<b>CC8JAX1-4284</b>	42	84	29	4	1	2	219	14	\$9,681	\$13,770
	<b>CC8JAX1-3672</b>	36	72	29	4	1	2	189	12	\$8,918	\$11,922

- long grain veneer direction
- base (2) CC8NC01-0423
- telescopic feet are anodized aluminum
- telescopic feet provide 1 1/2" leveling
- top is 1 1/4" thick
- laminate worksurface, no charge if standard laminate is selected
- glass worksurface with reverse bevel edge, (see page 308)





**To Order, Specify:**

**Rectangular Table with Open Cable Base**

- ① Model Number
- ② Wood Species
- ③ Finish Color
- ④ Worksurface Option
  - A. Veneer
  - B. Laminate
  - C. Glossy Low Iron White Back Painted Glass
  - D. Frosted Low Iron White Back Painted Glass (see page 308)
- ⑤ Edge Detail
  - A. Straight
  - B. Aluminum Trim
- ⑥ Power and Data Options (see pages 519-535)
- ⑦ Other Product Options

**Arc End Table with Open Cable Base**

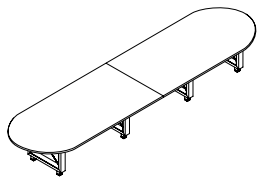
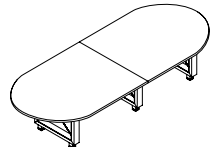
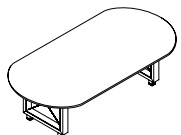
- ① Model Number
- ② Wood Species
- ③ Finish Color
- ④ Worksurface Option
  - A. Veneer
  - B. Laminate
  - C. Glossy Low Iron White Back Painted Glass
  - D. Frosted Low Iron White Back Painted Glass (see page 308)
- ⑤ Power and Data Options (see pages 519-535)
- ⑦ Other Product Options

Description	① Model	D	L	H	Seat Capacity	Top Pieces	Bases Required	CTN WT	CU FT	Veneer	Glass Top
Racetrack Table with Open Cable Base 	<b>CC8J0X1-48192</b>	48	192	29	14	2	4	535	42	\$25,854	\$37,208
	<ul style="list-style-type: none"> <li>· short grain veneer direction</li> <li>· base (4) CC8NC01-0427</li> <li>· telescopic feet are anodized aluminum</li> <li>· telescopic feet provide 1 ½" leveling</li> <li>· top is 1 ¼" thick and in two sections</li> <li>· laminate worksurface, no charge if standard laminate is selected</li> <li>· glass worksurface with reverse bevel edge, (see page 308)</li> </ul>										
Racetrack Table with Open Cable Base 	<b>CC8J0X1-48168</b>	48	168	29	12	2	3	453	26	\$20,367	\$30,304
	<b>CC8J0X1-48144</b>	48	144	29	8	2	3	405	24	\$18,784	\$27,299
	<b>CC8J0X1-48120</b>	48	120	29	6	2	3	365	21	\$17,495	\$24,168
<ul style="list-style-type: none"> <li>· short grain veneer direction</li> <li>· base (3) CC8NC01-0427</li> <li>· telescopic feet are anodized aluminum</li> <li>· telescopic feet provide 1 ½" leveling</li> <li>· top is 1 ¼" thick and in two sections</li> <li>· laminate worksurface, no charge if standard laminate is selected</li> <li>· glass worksurface with reverse bevel edge, (see page 308)</li> </ul>											
Racetrack Table with Open Cable Base 	<b>CC8J0X1-4896</b>	48	96	29	6	1	2	256	16	\$12,002	\$17,342
	<ul style="list-style-type: none"> <li>· long grain veneer direction</li> <li>· base (2) CC8NC01-0427</li> <li>· telescopic feet are anodized aluminum</li> <li>· telescopic feet provide 1 ½" leveling</li> <li>· top is 1 ¼" thick</li> <li>· laminate worksurface, no charge if standard laminate is selected</li> <li>· glass worksurface with reverse bevel edge, (see page 308)</li> </ul>										
Racetrack Table with Open Cable Base 	<b>CC8J0X1-4284</b>	42	84	29	4	1	2	206	14	\$9,737	\$13,826
	<b>CC8J0X1-3672</b>	36	72	29	4	1	2	180	12	\$8,959	\$11,962
<ul style="list-style-type: none"> <li>· long grain veneer direction</li> <li>· base (2) CC8NC01-0423</li> <li>· telescopic feet are anodized aluminum</li> <li>· telescopic feet provide 1 ½" leveling</li> <li>· top is 1 ¼" thick</li> <li>· laminate worksurface, no charge if standard laminate is selected</li> <li>· glass worksurface with reverse bevel edge, (see page 308)</li> </ul>											

COLLECTIVE CONFERENCE

Description	① Model	D	L	H	Seat Capacity	Top Pieces	Bases Required	CTN WT	CU FT	Veneer	Glass Top
Boat Shape Table with Open Cable Base	CC8JBX1-48144	48	144	29	8	2	3	393	24	\$20,321	\$28,836
	CC8JBX1-48120	48	120	29	6	2	3	358	21	\$18,749	\$25,422

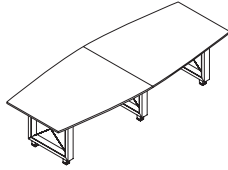

- short grain veneer direction
- base (3) CC8NC01-0427
- telescopic feet are anodized aluminum
- telescopic feet provide 1 1/2" leveling
- top is 1 1/4" thick
- laminate worksurface, no charge if standard laminate is selected
- glass worksurface with reverse bevel edge, (see page 308)

Boat Shape Table with Open Cable Base	CC8JBX1-4896	48	96	29	6	1	2	262	16	\$12,942	\$18,282
---------------------------------------	--------------	----	----	----	---	---	---	-----	----	----------	----------

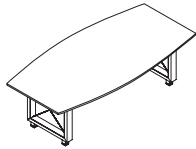

- long grain veneer direction
- base (2) CC8NC01-0427
- telescopic feet are anodized aluminum
- telescopic feet provide 1 1/2" leveling
- top is 1 1/4" thick
- laminate worksurface, no charge if standard laminate is selected
- glass worksurface with reverse bevel edge, (see page 308)

Ellipse Table with Open Cable Base	CC8JEX1-54120	54	120	29	8	2	3	354	23	\$19,386	\$26,892
------------------------------------	---------------	----	-----	----	---	---	---	-----	----	----------	----------

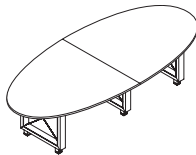

- long grain veneer direction
- base (3) CC8NC01-0427
- telescopic feet are anodized aluminum
- telescopic feet provide 1 1/2" leveling
- top is 1 1/4" thick and in two sections
- laminate worksurface, no charge if standard laminate is selected
- glass worksurface with reverse bevel edge, (see page 308)

Ellipse Table with Open Cable Base	CC8JEX1-4896	48	96	29	6	1	2	244	16	\$13,379	\$18,719
------------------------------------	--------------	----	----	----	---	---	---	-----	----	----------	----------

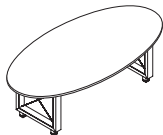

- long grain veneer direction
- base (2) CC8NC01-0423
- telescopic feet are anodized aluminum
- telescopic feet provide 1 1/2" leveling
- top is 1 1/4" thick
- laminate worksurface, no charge if standard laminate is selected
- glass worksurface with reverse bevel edge, (see page 308)

**To Order, Specify:**

**Racetrack Table with Open Cable Base**

- ① Model Number
- ② Wood Species
- ③ Finish Color
- ④ Worksurface Option
  - A. Veneer
  - B. Laminate
  - C. Glossy Low Iron White Back Painted Glass
  - D. Frosted Low Iron White Back Painted Glass (see page 308)
- ⑤ Power and Data Options (see pages 519-535)
- ⑥ Other Product Options

**Boat Shape or Ellipse Table with Open Cable Base**

- ① Model Number
- ② Wood Species
- ③ Finish Color
- ④ Worksurface Option
  - A. Veneer
  - B. Laminate
  - C. Glossy Low Iron White Back Painted Glass
  - D. Frosted Low Iron White Back Painted Glass (see page 308)
- ⑤ Power and Data Options (see pages 519-535)
- ⑥ Other Product Options

Description	① Model	D	L	H	Seat Capacity	Top Pieces	Bases Required	CTN WT	CU FT	Veneer	Glass Top
-------------	---------	---	---	---	---------------	------------	----------------	--------	-------	--------	-----------

Rectangular Table with Closed Cable Base	<b>CC8JRY1-48192</b>	48	192	29	14	2	4	601	32	\$21,834	\$33,188
	<ul style="list-style-type: none"> <li>· short grain veneer direction</li> <li>· bases (2) CC8NCC1-0527 outside and (2) CC8NCM1-0527 middle</li> <li>· plinth base</li> <li>· top is 1 1/4" thick and in two sections</li> <li>· laminate worksurface, no charge if standard laminate is selected</li> <li>· glass worksurface with reverse bevel edge, (see page 308)</li> <li>· aluminum edge available on veneer and laminate tops, specify and add \$5,289 list</li> </ul>										

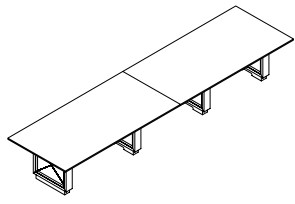

Rectangular Table with Closed Cable Base	<b>CC8JRY1-48168</b>	48	168	29	12	2	3	490	26	\$18,505	\$28,441
	<b>CC8JRY1-48144</b>	48	144	29	8	2	3	451	24	\$17,021	\$25,537
	<b>CC8JRY1-48120</b>	48	120	29	6	2	3	411	21	\$15,824	\$22,498

<ul style="list-style-type: none"> <li>· short grain veneer direction</li> <li>· bases (2) CC8NCC1-0527 outside and (1) CC8NCM1-0527 middle</li> <li>· plinth base</li> <li>· top is 1 1/4" thick and in two sections</li> <li>· laminate worksurface, no charge if standard laminate is selected</li> <li>· glass worksurface with reverse bevel edge, (see page 308)</li> <li>· aluminum edge available on veneer and laminate tops, specify and add \$4,762 list for CC8JRY1-48168, \$4,232 list for CC8JRY1-48144 and \$3,704 list for CC8JRY1-48120</li> </ul>										
---	--	--	--	--	--	--	--	--	--	--

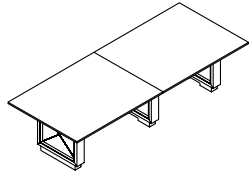

Rectangular Table with Closed Cable Base	<b>CC8JRY1-4896</b>	48	96	29	6	1	2	301	16	\$12,503	\$17,844
--	---------------------	----	----	----	---	---	---	-----	----	----------	----------

<ul style="list-style-type: none"> <li>· long grain veneer direction</li> <li>· bases (2) CC8NCC1-0527</li> <li>· plinth base</li> <li>· top is 1 1/4" thick</li> <li>· laminate worksurface, no charge if standard laminate is selected</li> <li>· glass worksurface with reverse bevel edge, (see page 308)</li> <li>· aluminum edge available on veneer and laminate tops, specify and add \$3,176 list</li> </ul>										
---	--	--	--	--	--	--	--	--	--	--

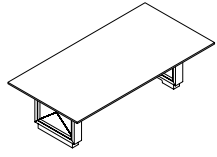

Rectangular Table with Closed Cable Base	<b>CC8JRY1-4284</b>	42	84	29	4	1	2	245	14	\$10,543	\$14,632
	<b>CC8JRY1-3672</b>	36	72	29	4	1	2	213	12	\$9,825	\$12,827

<ul style="list-style-type: none"> <li>· long grain veneer direction</li> <li>· bases (2) CC8NCC1-0523</li> <li>· plinth base</li> <li>· top is 1 1/4" thick</li> <li>· laminate worksurface, no charge if standard laminate is selected</li> <li>· glass worksurface with reverse bevel edge, (see page 308)</li> <li>· aluminum edge available on veneer and laminate tops, specify and add \$2,779 list for CC8JRY1-4284, \$2,383 list for CC8JRY1-3672</li> </ul>										
---	--	--	--	--	--	--	--	--	--	--

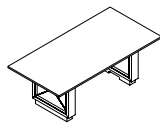

COLLECTIVE CONFERENCE

Description	① Model	D	L	H	Seat Capacity	Top Pieces	Bases Required	CTN WT	CU FT	Veneer	Glass Top
-------------	---------	---	---	---	---------------	------------	----------------	--------	-------	--------	-----------

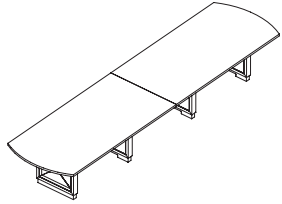
<b>Arc End Table with Closed Cable Base</b> 	<b>CC8JAY1-48192</b>	48	192	29	14	2	4	601	32	\$22,362	\$33,717
	<ul style="list-style-type: none"> <li>• short grain veneer direction</li> <li>• bases (2) CC8NCC1-0527 outside and (2) CC8NCM1-0527 middle</li> <li>• plinth base</li> <li>• top is 1 1/4" thick</li> <li>• laminate worksurface, no charge if standard laminate is selected</li> <li>• glass worksurface with reverse bevel edge, (see page 308)</li> </ul>										

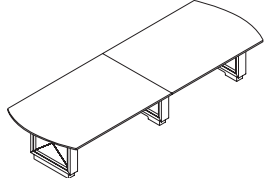
<b>Arc End Table with Closed Cable Base</b> 	<b>CC8JAY1-48168</b>	48	168	29	12	2	3	490	26	\$18,959	\$28,895
	<b>CC8JAY1-48144</b>	48	144	29	8	2	3	451	24	\$17,397	\$25,913
	<b>CC8JAY1-48120</b>	48	120	29	6	2	3	411	21	\$16,131	\$22,805
<ul style="list-style-type: none"> <li>• short grain veneer direction</li> <li>• bases (2) CC8NCC1-0527 outside and (1) CC8NCM1-0527 middle</li> <li>• plinth base</li> <li>• top is 1 1/4" thick</li> <li>• laminate worksurface, no charge if standard laminate is selected</li> <li>• glass worksurface with reverse bevel edge, (see page 308)</li> </ul>											

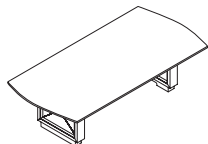
<b>Arc End Table with Closed Cable Base</b> 	<b>CC8JAY1-4896</b>	48	96	29	6	1	2	301	16	\$12,727	\$18,066
<ul style="list-style-type: none"> <li>• long grain veneer direction</li> <li>• bases (2) CC8NCC1-0527</li> <li>• plinth base</li> <li>• top is 1 1/4" thick</li> <li>• laminate worksurface, no charge if standard laminate is selected</li> <li>• glass worksurface with reverse bevel edge, (see page 308)</li> </ul>											

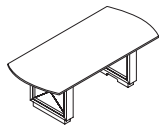
<b>Arc End Table with Closed Cable Base</b> 	<b>CC8JAY1-4284</b>	42	84	29	4	1	2	245	14	\$10,707	\$14,797
	<b>CC8JAY1-3672</b>	36	72	29	4	1	2	213	12	\$9,944	\$12,946
<ul style="list-style-type: none"> <li>• long grain veneer direction</li> <li>• bases (2) CC8NCC1-0523</li> <li>• plinth base</li> <li>• top is 1 1/4" thick</li> <li>• laminate worksurface, no charge if standard laminate is selected</li> <li>• glass worksurface with reverse bevel edge, (see page 308)</li> </ul>											

**To Order, Specify:**

**Rectangular Table with Closed Cable Base**

- ① Model Number
- ② Wood Species
- ③ Finish Color
- ④ Worksurface Option
  - A. Veneer
  - B. Laminate
  - C. Glossy Low Iron White Back Painted Glass
  - D. Frosted Low Iron White Back Painted Glass (see page 308)
- ⑤ Edge Detail
  - A. Straight
  - B. Aluminum Trim
- ⑥ Power and Data Options (see pages 519-535)
- ⑦ Other Product Options

**Arc End Table with Closed Cable Base**

- ① Model Number
- ② Wood Species
- ③ Finish Color
- ④ Worksurface Option
  - A. Veneer
  - B. Laminate
  - C. Glossy Low Iron White Back Painted Glass
  - D. Frosted Low Iron White Back Painted Glass (see page 308)
- ⑥ Power and Data Options (see pages 519-535)
- ⑦ Other Product Options

Description	① Model	D	L	H	Seat Capacity	Top Pieces	Bases Required	CTN WT	CU FT	Veneer	Glass Top
-------------	---------	---	---	---	---------------	------------	----------------	--------	-------	--------	-----------

Racetrack Table with Closed Cable Base	<b>CC8JOY1-48192</b>	48	192	29	14	2	4	585	32	\$22,538	\$33,892
--	----------------------	----	-----	----	----	---	---	-----	----	----------	----------

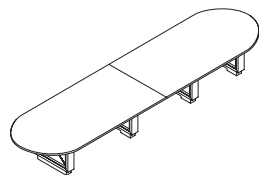

- short grain veneer direction
- bases (2) CC8NCC1-0527 outside and (2) CC8NCM1-0527 middle
- plinth base
- top is 1 1/4" thick and in two sections
- laminate worksurface, no charge if standard laminate is selected
- glass worksurface with reverse bevel edge, (see page 308)

Racetrack Table with Closed Cable Base	<b>CC8JOY1-48168</b>	48	168	29	12	2	3	483	26	\$19,111	\$29,047
--	----------------------	----	-----	----	----	---	---	-----	----	----------	----------

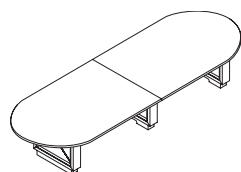

	<b>CC8JOY1-48144</b>	48	144	29	8	2	3	435	24	\$17,525	\$26,041
--	----------------------	----	-----	----	---	---	---	-----	----	----------	----------

	<b>CC8JOY1-48120</b>	48	120	29	6	2	3	395	21	\$16,233	\$22,907
--	----------------------	----	-----	----	---	---	---	-----	----	----------	----------

- short grain veneer direction
- bases (2) CC8NCC1-0527 outside and (1) CC8NCM1-0527 middle
- plinth base
- top is 1 1/4" thick and in two sections
- laminate worksurface, no charge if standard laminate is selected
- glass worksurface with reverse bevel edge, (see page 308)

Racetrack Table with Closed Cable Base	<b>CC8JOY1-4896</b>	48	96	29	6	1	2	276	16	\$12,801	\$18,139
--	---------------------	----	----	----	---	---	---	-----	----	----------	----------

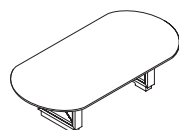

- long grain veneer direction
- bases (2) CC8NCC1-0527
- plinth base
- top is 1 1/4" thick
- laminate worksurface, no charge if standard laminate is selected
- glass worksurface with reverse bevel edge, (see page 308)

Racetrack Table with Closed Cable Base	<b>CC8JOY1-4284</b>	42	84	29	4	1	2	232	14	\$10,760	\$14,848
--	---------------------	----	----	----	---	---	---	-----	----	----------	----------



	<b>CC8JOY1-3672</b>	36	72	29	4	1	2	213	12	\$9,983	\$12,985
--	---------------------	----	----	----	---	---	---	-----	----	---------	----------

- long grain veneer direction
- bases (2) CC8NCC1-0523
- plinth base
- top is 1 1/4" thick
- laminate worksurface, no charge if standard laminate is selected
- glass worksurface with reverse bevel edge, (see page 308)

COLLECTIVE CONFERENCE

Description	① Model	D	L	H	Seat Capacity	Top Pieces	Bases Required	CTN WT	CU FT	Veneer	Glass Top
Boat Shape Table with Closed Cable Base	CC8JBY1-48144	48	144	29	8	2	3	423	24	\$19,061	\$27,576
	CC8JBY1-48120	48	120	29	6	2	3	388	21	\$17,488	\$24,160

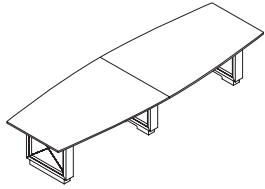

- short grain veneer direction
- bases (2) CC8NCC1-0527 outside and (1) CC8NCM1-0527 middle
- plinth base
- top is 1 1/4" thick and in two sections
- laminate worksurface, no charge if standard laminate is selected
- glass worksurface with reverse bevel edge, (see page 308)

Boat Shape Table with Closed Cable Base	CC8JBY1-4896	48	96	29	6	1	2	282	16	\$13,742	\$19,081
---	--------------	----	----	----	---	---	---	-----	----	----------	----------

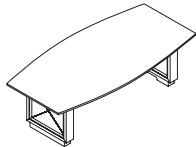

- long grain veneer direction
- bases (2) CC8NCC1-0527
- plinth base
- top is 1 1/4" thick
- laminate worksurface, no charge if standard laminate is selected
- glass worksurface with reverse bevel edge, (see page 308)

Ellipse Table with Closed Cable Base	CC8JEY1-54120	54	120	29	8	2	3	384	23	\$18,125	\$25,633
--------------------------------------	---------------	----	-----	----	---	---	---	-----	----	----------	----------

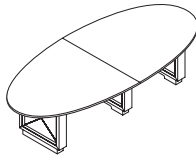

- short grain veneer direction
- bases (2) CC8NCC1-0527 outside and (1) CC8NCM1-0527 middle
- plinth base
- top is 1 1/4" thick and in two sections
- laminate worksurface, no charge if standard laminate is selected
- glass worksurface with reverse bevel edge, (see page 308)

Ellipse Table with Closed Cable Base	CC8JEY1-4896	48	96	29	6	1	2	264	16	\$14,179	\$19,519
--------------------------------------	--------------	----	----	----	---	---	---	-----	----	----------	----------

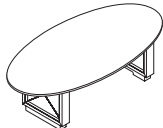

- long grain veneer direction
- base (2) CC8NCC1-0527
- plinth base
- top is 1 1/4" thick
- laminate worksurface, no charge if standard laminate is selected
- glass worksurface with reverse bevel edge, (see page 308)

**To Order, Specify:**

- ① Model Number
- ② Wood Species
- ③ Finish Color
- ④ Worksurface Option
  - A. Veneer
  - B. Laminate
  - C. Glossy Low Iron White Back Painted Glass
  - D. Frosted Low Iron White Back Painted Glass (see page 308)
- ⑤ Power and Data Options (see pages 519-535)
- ⑥ Other Product Options

COLLECTIVE CONFERENCE

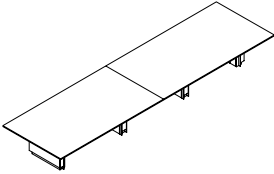
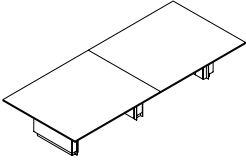
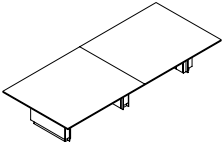
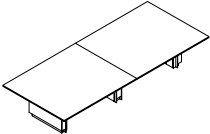
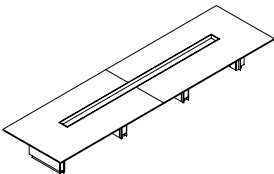
Description	① Model	D	L	H	Seat Capacity	Top Pieces	Bases Required	CTN WT	CU FT	Veneer	Glass Top
Rectangular Table with Panel Base 	<b>CC8JRP2-60216</b>	60	216	29	18	2	4	813	47	\$27,583	\$43,551
	<ul style="list-style-type: none"> <li>• short grain veneer direction</li> <li>• base CC8NPC2-32174</li> <li>• plinth base</li> <li>• top is 1 1/4" thick and in two sections</li> <li>• laminate worksurface, no charge if standard laminate is selected</li> <li>• base front arc panel, add \$594 to list, arc is only outside bases</li> <li>• glass worksurface with reverse bevel edge, (see page 308)</li> <li>• aluminum edge available on veneer and laminate tops, specify and add \$6,080 list</li> </ul>										
Rectangular Table with Panel Base 	<b>CC8JRP2-60192</b>	60	192	29	16	2	3	682	39	\$21,469	\$35,661
	<ul style="list-style-type: none"> <li>• short grain veneer direction</li> <li>• base CC8NPC2-32156</li> <li>• plinth base</li> <li>• top is 1 1/4" thick and in two sections</li> <li>• laminate worksurface, no charge if standard laminate is selected</li> <li>• base front arc panel, add \$594 to list, arc is only outside bases</li> <li>• glass worksurface with reverse bevel edge, (see page 308)</li> <li>• aluminum edge available on veneer and laminate tops, specify and add \$5,554 list</li> </ul>										
Rectangular Table with Panel Base 	<b>CC8JRP2-60168</b>	60	168	29	14	2	3	630	36	\$19,276	\$31,696
	<ul style="list-style-type: none"> <li>• short grain veneer direction</li> <li>• base CC8NPC2-32132</li> <li>• plinth base</li> <li>• top is 1 1/4" thick and in two sections</li> <li>• laminate worksurface, no charge if standard laminate is selected</li> <li>• base front arc panel, add \$594 to list, arc is only outside bases</li> <li>• glass worksurface with reverse bevel edge, (see page 308)</li> <li>• aluminum edge available on veneer and laminate tops, specify and add \$5,027 list</li> </ul>										
Rectangular Table with Panel Base 	<b>CC8JRP2-60144</b>	60	144	29	10	2	3	578	33	\$17,530	\$28,175
	<ul style="list-style-type: none"> <li>• short grain veneer direction</li> <li>• base CC8NPC2-32108</li> <li>• plinth base</li> <li>• top is 1 1/4" thick and in two sections</li> <li>• laminate worksurface, no charge if standard laminate is selected</li> <li>• base front arc panel, add \$594 to list, arc is only outside bases</li> <li>• glass worksurface with reverse bevel edge, (see page 308)</li> <li>• aluminum edge available on veneer and laminate tops, specify and add \$4,496 list</li> </ul>										
Rectangular Table with Panel Base and Center Console 	<b>CC8JRP2-60216</b>	60	216	29	18	2	4	814	55	\$33,910	\$49,878
	<ul style="list-style-type: none"> <li>• short grain veneer direction</li> <li>• base CC8NPC2-32174</li> <li>• plinth base</li> <li>• top is 1 1/4" thick and in two sections</li> <li>• anodized aluminum center console 160" long</li> <li>• laminate worksurface, no charge if standard laminate is selected</li> <li>• base front arc panel, add \$594 to list, arc is only outside bases</li> <li>• glass worksurface with reverse bevel edge, (see page 308)</li> <li>• aluminum edge available on veneer and laminate tops, specify and add \$6,080 list</li> </ul>										



Description	① Model	D	L	H	Seat Capacity	Top Pieces	Bases Required	CTN WT	CU FT	Veneer	Glass Top
-------------	---------	---	---	---	---------------	------------	----------------	--------	-------	--------	-----------

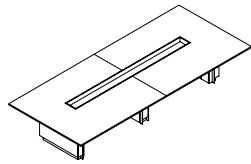

- short grain veneer direction
- base CC8NPC2-32156
- plinth base
- top is 1 1/4" thick and in two sections
- anodized aluminum center console 144" long
- laminate worksurface, no charge if standard laminate is selected
- base front arc panel, add \$594 to list, arc is only outside bases
- glass worksurface with reverse bevel edge, (see page 308)
- aluminum edge available on veneer and laminate tops, specify and add \$5,554 list

Rectangular Table with Panel Base and Center Console

<b>CC8JRP-60168</b>	60	168	29	14	2	3	631	42	\$23,879	\$36,298
---------------------	----	-----	----	----	---	---	-----	----	----------	----------

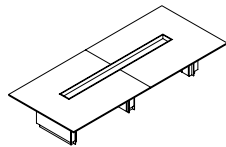

- short grain veneer direction
- base CC8NPC2-32132
- plinth base
- top is 1 1/4" thick and in two sections
- anodized aluminum center console 120" long
- laminate worksurface, no charge if standard laminate is selected
- base front arc panel, add \$594 to list, arc is only outside bases
- glass worksurface with reverse bevel edge, (see page 308)
- aluminum edge available on veneer and laminate tops, specify and add \$5,027 list

Rectangular Table with Panel Base and Center Console

<b>CC8JRP-60144</b>	60	144	29	10	2	3	578	39	\$21,268	\$31,913
---------------------	----	-----	----	----	---	---	-----	----	----------	----------

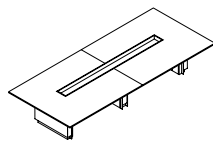

- short grain veneer direction
- base CC8NPC2-32108
- plinth base
- top is 1 1/4" thick and in two sections
- anodized aluminum center console 96" long
- laminate worksurface, no charge if standard laminate is selected
- base front arc panel, add \$594 to list, arc is only outside bases
- glass worksurface with reverse bevel edge, (see page 308)
- aluminum edge available on veneer and laminate tops, specify and add \$4,496 list

**To Order, Specify:**

**Rectangular Table**

- ① Model Number
- ② Wood Species
- ③ Finish Scheme
  - A. Accent Surround - Veneer or Paint
  - B. Base Pedestal - Veneer or Paint  
(see page 312 - apron follows base pedestal)
- ④ Worksurface Option
  - A. Veneer
  - B. Laminate
  - C. Glossy Low Iron White Back Painted Glass
  - D. Frosted Low Iron White Back Painted Glass  
(see page 308)
- ⑤ Power and Data Options (see pages 519-535)
- ⑥ Other Product Options

**Rectangular Table with Center Console**

- ① Model Number
- ② Wood Species
- ③ Finish Scheme
  - A. Accent Surround - Veneer or Paint
  - B. Base Pedestal - Veneer or Paint  
(see page 312 - apron follows base pedestal)
- ④ Worksurface Option
  - A. Veneer
  - B. Laminate
  - C. Glossy Low Iron White Back Painted Glass
  - D. Frosted Low Iron White Back Painted Glass  
(see page 308)
- ⑤ Power and Data Options (see pages 519-535)
- ⑥ Other Product Option
- ⑦ Center Console Accessories (see pages 390-391 - order separately)

Description	① Model	D	L	H	Seat Capacity	Top Pieces	Bases Required	CTN WT	CU FT	Veneer	Glass Top
-------------	---------	---	---	---	---------------	------------	----------------	--------	-------	--------	-----------

Rectangular Table with Panel Base	<b>CC8JRP2-48216</b>	48	216	29	16	2	4	702	38	\$23,426	\$36,200
-----------------------------------	----------------------	----	-----	----	----	---	---	-----	----	----------	----------

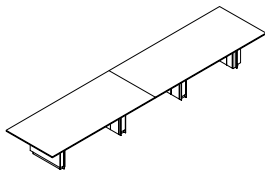

- short grain veneer direction
- base CC8NPC2-27174
- plinth base
- top is 1 1/4" thick and in two sections
- laminate worksurface, no charge if standard laminate is selected
- base front arc panel, add \$594 to list, arc is only outside bases
- glass worksurface with reverse bevel edge, (see page 308)
- aluminum edge available on veneer and laminate tops, specify and add \$5,818 list

Rectangular Table with Panel Base	<b>CC8JRP2-48192</b>	48	192	29	14	2	3	581	32	\$18,002	\$29,356
-----------------------------------	----------------------	----	-----	----	----	---	---	-----	----	----------	----------

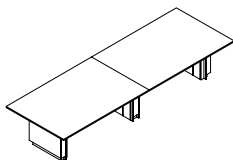

- short grain veneer direction
- base CC8NPC2-27156
- plinth base
- top is 1 1/4" thick and in two sections
- laminate worksurface, no charge if standard laminate is selected
- base front arc panel, add \$594 to list, arc is only outside bases
- glass worksurface with reverse bevel edge, (see page 308)
- aluminum edge available on veneer and laminate tops, specify and add \$5,289 list

Rectangular Table with Panel Base	<b>CC8JRP2-48168</b>	48	168	29	12	2	3	538	29	\$16,215	\$26,151
-----------------------------------	----------------------	----	-----	----	----	---	---	-----	----	----------	----------

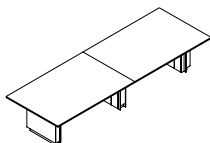

- short grain veneer direction
- base CC8NPC2-27132
- plinth base
- top is 1 1/4" thick and in two sections
- laminate worksurface, no charge if standard laminate is selected
- base front arc panel, add \$594 to list, arc is only outside bases
- glass worksurface with reverse bevel edge, (see page 308)
- aluminum edge available on veneer and laminate tops, specify and add \$4,762 list

Rectangular Table with Panel Base	<b>CC8JRP2-48144</b>	48	144	29	8	2	3	497	27	\$14,849	\$23,367
-----------------------------------	----------------------	----	-----	----	---	---	---	-----	----	----------	----------

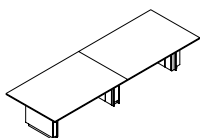

- short grain veneer direction
- base CC8NPC2-27108
- plinth base
- top is 1 1/4" thick and in two sections
- laminate worksurface, no charge if standard laminate is selected
- base front arc panel, add \$594 to list, arc is only outside bases
- glass worksurface with reverse bevel edge, (see page 308)
- aluminum edge available on veneer and laminate tops, specify and add \$4,232 list

Description	① Model	D	L	H	Seat Capacity	Top Pieces	Bases Required	CTN WT	CU FT	Veneer	Glass Top
Rectangular Table with Panel Base	<b>CC8JRP2-48120</b>	48	120	29	6	2	2	375	20	\$9,654	\$16,327

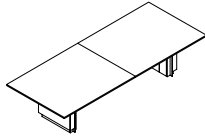

- short grain veneer direction
- base CC8NPC2-2784
- plinth base
- top is 1 1/4" thick and in two sections
- laminate worksurface, no charge if standard laminate is selected
- base front arc panel, add \$594 to list, arc is only outside bases
- glass worksurface with reverse bevel edge, (see page 308)
- aluminum edge available, specify and add \$3,704 list

Rectangular Table with Panel Base	<b>CC8JRP2-4896</b>	48	96	29	6	1	2	334	18	\$8,128	\$13,468
-----------------------------------	---------------------	----	----	----	---	---	---	-----	----	---------	----------

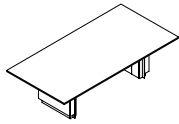

- long grain veneer direction
- base CC8NPC2-2760
- plinth base
- top is 1 1/4" thick
- laminate worksurface, no charge if standard laminate is selected
- base front arc panel, add \$594 to list, arc is only outside bases
- glass worksurface with reverse bevel edge, (see page 308)
- aluminum edge available, specify and add \$3,176 list

**To Order, Specify:**

- ① Model Number
- ② Wood Species
- ③ Finish Scheme
  - A. Accent Surround - Veneer or Paint
  - B. Base Pedestal - Veneer or Paint  
(see page 312 - apron follows base pedestal)
- ④ Edge Detail
  - A. Straight
  - B. Aluminum Trim
- ⑤ Worksurface Option
  - A. Veneer
  - B. Laminate
  - C. Glossy Low Iron White Back Painted Glass
  - D. Frosted Low Iron White Back Painted Glass  
(see page 308)
- ⑥ Power and Data Options (see pages 519-535)
- ⑦ Other Product Options

Description	① Model	D	L	H	Seat Capacity	Top Pieces	Bases Required	CTN WT	CU FT	Veneer	Glass Top
-------------	---------	---	---	---	---------------	------------	----------------	--------	-------	--------	-----------

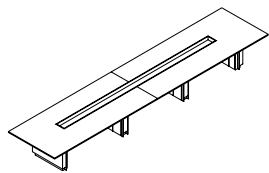

<b>Rectangular Table with Panel Base and Center Console</b>	<b>CC8JRPM-48216</b>	48	216	29	16	2	4	702	44	\$29,750	\$42,524
---	----------------------	----	-----	----	----	---	---	-----	----	----------	----------

- short grain veneer direction
- base CC8NPC2-27174
- plinth base
- top is 1 1/4" thick and in two sections
- anodized aluminum center console 160" long
- laminate worksurface, no charge if standard laminate is selected
- base front arc panel, add \$594 to list, arc is only outside bases
- glass worksurface with reverse bevel edge, (see page 308)
- aluminum edge available, specify and add \$5,818 list

<b>Rectangular Table with Panel Base and Center Console</b>	<b>CC8JRPM-48192</b>	48	192	29	14	2	4	581	37	\$23,468	\$34,822
---	----------------------	----	-----	----	----	---	---	-----	----	----------	----------

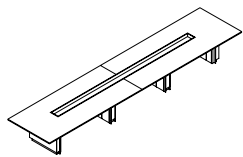

<b>Rectangular Table with Panel Base and Center Console</b>	<b>CC8JRPM-48192</b>	48	192	29	14	2	4	581	37	\$23,468	\$34,822
---	----------------------	----	-----	----	----	---	---	-----	----	----------	----------

- short grain veneer direction
- base CC8NPC2-27156
- plinth base
- top is 1 1/4" thick and in two sections
- anodized aluminum center console 144" long
- laminate worksurface, no charge if standard laminate is selected
- base front arc panel, add \$594 to list, arc is only outside bases
- glass worksurface with reverse bevel edge, (see page 308)
- aluminum edge available, specify and add \$5,289 list

<b>Rectangular Table with Panel Base and Center Console</b>	<b>CC8JRPM-48168</b>	48	168	29	12	2	4	539	34	\$20,815	\$30,751
---	----------------------	----	-----	----	----	---	---	-----	----	----------	----------

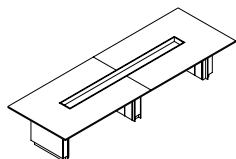

<b>Rectangular Table with Panel Base and Center Console</b>	<b>CC8JRPM-48168</b>	48	168	29	12	2	4	539	34	\$20,815	\$30,751
---	----------------------	----	-----	----	----	---	---	-----	----	----------	----------

- short grain veneer direction
- base CC8NPC2-27132
- plinth base
- top is 1 1/4" thick and in two sections
- anodized aluminum center console 120" long
- laminate worksurface, no charge if standard laminate is selected
- base front arc panel, add \$594 to list, arc is only outside bases
- glass worksurface with reverse bevel edge, (see page 308)
- aluminum edge available, specify and add \$4,762 list

<b>Rectangular Table with Panel Base and Center Console</b>	<b>CC8JRPM-48144</b>	48	144	29	8	2	3	497	31	\$18,589	\$27,105
---	----------------------	----	-----	----	---	---	---	-----	----	----------	----------

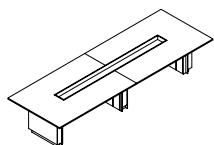

<b>Rectangular Table with Panel Base and Center Console</b>	<b>CC8JRPM-48144</b>	48	144	29	8	2	3	497	31	\$18,589	\$27,105
---	----------------------	----	-----	----	---	---	---	-----	----	----------	----------

- short grain veneer direction
- base CC8NPC2-27108
- plinth base
- top is 1 1/4" thick and in two sections
- anodized aluminum center console 96" long
- laminate worksurface, no charge if standard laminate is selected
- base front arc panel, add \$594 to list, arc is only outside bases
- glass worksurface with reverse bevel edge, (see page 308)
- aluminum edge available, specify and add \$4,232 list

COLLECTIVE CONFERENCE

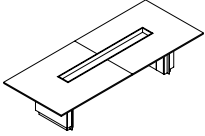
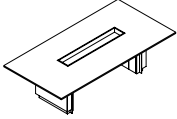
Description	① Model	D	L	H	Seat Capacity	Top Pieces	Bases Required	CTN WT	CU FT	Veneer	Glass Top
<b>Rectangular Table with Panel Base and Center Console</b> 	<b>CC8JRPM-48120</b>	48	120	29	6	2	2	376	24	\$12,533	\$19,206
	<ul style="list-style-type: none"> <li>· short grain veneer direction</li> <li>· base CC8NPC2-2784</li> <li>· plinth base</li> <li>· top is 1 1/4" thick and in two sections</li> <li>· anodized aluminum center console 72" long</li> <li>· laminate worksurface, no charge if standard laminate is selected</li> <li>· base front arc panel, add \$594 to list, arc is only outside bases</li> <li>· glass worksurface with reverse bevel edge, (see page 308)</li> <li>· aluminum edge available, specify and add \$3,704 list</li> </ul>										
<b>Rectangular Table with Panel Base and Center Console</b> 	<b>CC8JRPM-4896</b>	48	96	29	6	1	2	334	21	\$10,145	\$15,483
	<ul style="list-style-type: none"> <li>· long grain veneer direction</li> <li>· base CC8NPC2-2760</li> <li>· plinth base</li> <li>· top is 1 1/4" thick</li> <li>· anodized aluminum center console 48" long</li> <li>· laminate worksurface, no charge if standard laminate is selected</li> <li>· base front arc panel, add \$594 to list, arc is only outside bases</li> <li>· glass worksurface with reverse bevel edge, (see page 308)</li> <li>· aluminum edge available, specify and add \$3,176 list</li> </ul>										

COLLECTIVE CONFERENCE

**To Order, Specify:**

- ① Model Number
- ② Wood Species
- ③ Finish Scheme
  - A. Accent Surround - Veneer or Paint
  - B. Base Pedestal - Veneer or Paint  
(see page 312 - apron follows base pedestal)
- ④ Edge Detail
  - A. Straight
  - B. Aluminum Trim
- ⑤ Worksurface Option
  - A. Veneer
  - B. Laminate
  - C. Glossy Low Iron White Back Painted Glass
  - D. Frosted Low Iron White Back Painted Glass  
(see page 308)
- ⑥ Power and Data Options (see pages 519-535)
- ⑦ Other Product Options
- ⑧ Center Console Accessories (see pages 390-391 - order separately)

Description	① Model	D	L	H	Seat Capacity	Top Pieces	Bases Required	CTN WT	CU FT	Veneer	Glass Top
-------------	---------	---	---	---	---------------	------------	----------------	--------	-------	--------	-----------

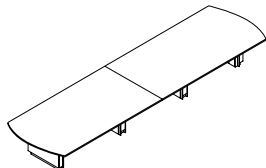
	<b>CC8JAP2-60216</b>	60	216	29	16	2	4	813	47	\$28,375	\$44,341
	<ul style="list-style-type: none"> <li>· short grain veneer direction</li> <li>· base CC8NPC2-32174</li> <li>· plinth base</li> <li>· top is 1 ¼" thick and in two sections</li> <li>· laminate worksurface, no charge if standard laminate is selected</li> <li>· base front arc panel, add \$594 to list, arc is only outside bases</li> <li>· glass worksurface with reverse bevel edge, (see page 308)</li> </ul>										

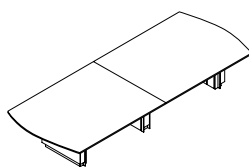
	<b>CC8JAP2-60192</b>	60	192	29	14	2	3	682	39	\$22,155	\$36,559
	<ul style="list-style-type: none"> <li>· short grain veneer direction</li> <li>· base CC8NPC2-32156</li> <li>· plinth base</li> <li>· top is 1 ¼" thick and in two sections</li> <li>· laminate worksurface, no charge if standard laminate is selected</li> <li>· base front arc panel, add \$594 to list, arc is only outside bases</li> <li>· glass worksurface with reverse bevel edge, (see page 308)</li> </ul>										

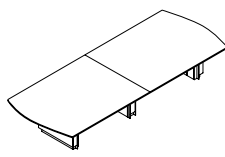
	<b>CC8JAP2-60168</b>	60	168	29	14	2	3	630	36	\$19,864	\$32,282
	<ul style="list-style-type: none"> <li>· short grain veneer direction</li> <li>· base CC8NPC2-32132</li> <li>· plinth base</li> <li>· top is 1 ¼" thick and in two sections</li> <li>· laminate worksurface, no charge if standard laminate is selected</li> <li>· base front arc panel, add \$594 to list, arc is only outside bases</li> <li>· glass worksurface with reverse bevel edge, (see page 308)</li> </ul>										

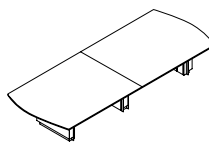
	<b>CC8JAP2-60144</b>	60	144	29	12	2	3	578	33	\$18,024	\$28,668
	<ul style="list-style-type: none"> <li>· short grain veneer direction</li> <li>· base CC8NPC2-32108</li> <li>· plinth base</li> <li>· top is 1 ¼" thick and in two sections</li> <li>· laminate worksurface, no charge if standard laminate is selected</li> <li>· base front arc panel, add \$594 to list, arc is only outside bases</li> <li>· glass worksurface with reverse bevel edge, (see page 308)</li> </ul>										

COLLECTIVE CONFERENCE

Description	① Model	D	L	H	Seat Capacity	Top Pieces	Bases Required	CTN WT	CU FT	Veneer	Glass Top
-------------	---------	---	---	---	---------------	------------	----------------	--------	-------	--------	-----------

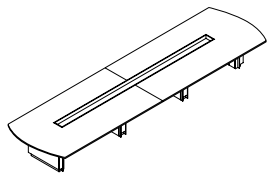

- short grain veneer direction
- base CC8NPC2-32174
- plinth base
- top is 1 1/4" thick and in two sections
- anodized aluminum center console 160" long
- laminate worksurface, no charge if standard laminate is selected
- base front arc panel, add \$594 to list, arc is only outside bases
- glass worksurface with reverse bevel edge, (see page 308)

Arc End Table with Panel Base and Center Console

<b>CC8JAPM-60192</b>	60	192	29	16	2	3	682	46	\$27,618	\$41,811
----------------------	----	-----	----	----	---	---	-----	----	----------	----------

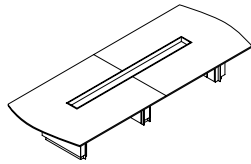

- short grain veneer direction
- base CC8NPC2-32156
- plinth base
- top is 1 1/4" thick and in two sections
- anodized aluminum center console 144" long
- laminate worksurface, no charge if standard laminate is selected
- base front arc panel, add \$594 to list, arc is only outside bases
- glass worksurface with reverse bevel edge, (see page 308)

Arc End Table with Panel Base and Center Console

<b>CC8JAPM-60168</b>	60	168	29	14	2	3	631	42	\$24,466	\$36,886
----------------------	----	-----	----	----	---	---	-----	----	----------	----------

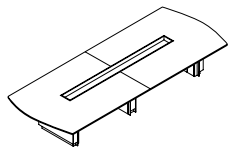

- short grain veneer direction
- base CC8NPC2-32132
- plinth base
- top is 1 1/4" thick and in two sections
- anodized aluminum center console 120" long
- laminate worksurface, no charge if standard laminate is selected
- base front arc panel, add \$594 to list, arc is only outside bases
- glass worksurface with reverse bevel edge, (see page 308)

Arc End Table with Panel Base and Center Console

<b>CC8JAPM-60144</b>	60	144	29	10	2	3	578	39	\$21,760	\$32,404
----------------------	----	-----	----	----	---	---	-----	----	----------	----------

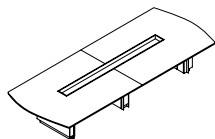

- short grain veneer direction
- base CC8NPC2-32108
- plinth base
- top is 1 1/4" thick and in two sections
- anodized aluminum center console 96" long
- laminate worksurface, no charge if standard laminate is selected
- base front arc panel, add \$594 to list, arc is only outside bases
- glass worksurface with reverse bevel edge, (see page 308)

**To Order, Specify:**

**Arc End Table**

- ① Model Number
- ② Wood Species
- ③ Finish Scheme
  - A. Accent Surround - Veneer or Paint
  - B. Base Pedestal - Veneer or Paint  
(see page 312 - apron follows base pedestal)
- ④ Worksurface Option
  - A. Veneer
  - B. Laminate
  - C. Glossy Low Iron White Back Painted Glass
  - D. Frosted Low Iron White Back Painted Glass  
(see page 308)
- ⑤ Power and Data Options (see pages 519-535)
- ⑥ Other Product Options

**Arc End Table with Center Console**

- ① Model Number
- ② Wood Species
- ③ Finish Scheme
  - A. Accent Surround - Veneer or Paint
  - B. Base Pedestal - Veneer or Paint  
(see page 312 - apron follows base pedestal)
- ④ Worksurface Option
  - A. Veneer
  - B. Laminate
  - C. Glossy Low Iron White Back Painted Glass
  - D. Frosted Low Iron White Back Painted Glass  
(see page 308)
- ⑤ Power and Data Options (see pages 519-535)
- ⑥ Other Product Options
- ⑦ Center Console Accessories (see pages 390-391 - order separately)

COLLECTIVE CONFERENCE

Description	① Model	D	L	H	Seat Capacity	Top Pieces	Bases Required	CTN WT	CU FT	Veneer	Glass Top
-------------	---------	---	---	---	---------------	------------	----------------	--------	-------	--------	-----------

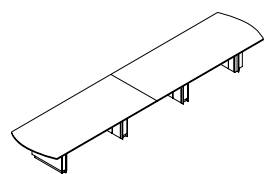

Arc End Table with Panel Base	<b>CC8JAP2-48216</b>	48	216	29	16	2	4	702	38	\$24,031	\$36,806
-------------------------------	----------------------	----	-----	----	----	---	---	-----	----	----------	----------

- short grain veneer direction
- base CC8NPC2-27174
- plinth base
- top is 1 1/4" thick and in two sections
- laminate worksurface, no charge if standard laminate is selected
- base front arc panel, add \$594 to list, arc is only outside bases
- glass worksurface with reverse bevel edge, (see page 308)

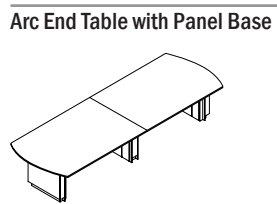

Arc End Table with Panel Base	<b>CC8JAP2-48192</b>	48	192	29	16	2	3	581	32	\$18,528	\$29,883
-------------------------------	----------------------	----	-----	----	----	---	---	-----	----	----------	----------

- short grain veneer direction
- base CC8NPC2-27156
- plinth base
- top is 1 1/4" thick and in two sections
- laminate worksurface, no charge if standard laminate is selected
- base front arc panel, add \$594 to list, arc is only outside bases
- glass worksurface with reverse bevel edge, (see page 308)

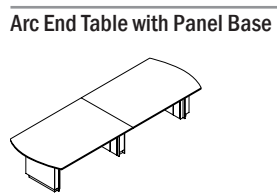

Arc End Table with Panel Base	<b>CC8JAP2-48168</b>	48	168	29	14	2	3	538	29	\$16,667	\$26,603
-------------------------------	----------------------	----	-----	----	----	---	---	-----	----	----------	----------

- short grain veneer direction
- base CC8NPC2-27132
- plinth base
- top is 1 1/4" thick and in two sections
- laminate worksurface, no charge if standard laminate is selected
- base front arc panel, add \$594 to list, arc is only outside bases
- glass worksurface with reverse bevel edge, (see page 308)

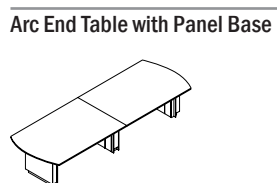

Arc End Table with Panel Base	<b>CC8JAP2-48144</b>	48	144	29	10	2	3	497	27	\$15,228	\$23,745
-------------------------------	----------------------	----	-----	----	----	---	---	-----	----	----------	----------

- short grain veneer direction
- base CC8NPC2-27108
- plinth base
- top is 1 1/4" thick and in two sections
- laminate worksurface, no charge if standard laminate is selected
- base front arc panel, add \$594 to list, arc is only outside bases
- glass worksurface with reverse bevel edge, (see page 308)

COLLECTIVE CONFERENCE



Description	① Model	D	L	H	Seat Capacity	Top Pieces	Bases Required	CTN WT	CU FT	Veneer	Glass Top
Arc End Table with Panel Base	<b>CC8JAP2-48120</b>	48	120	29	6	2	2	375	20	\$9,964	\$16,638

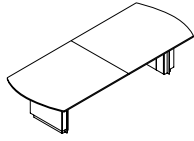

- short grain veneer direction
- base CC8NPC2-2784
- plinth base
- top is 1 1/4" thick and in two sections
- laminate worksurface, no charge if standard laminate is selected
- base front arc panel, add \$594 to list, arc is only outside bases
- glass worksurface with reverse bevel edge, (see page 308)

Arc End Table with Panel Base	<b>CC8JAP2-4896</b>	48	96	29	6	1	2	334	18	\$8,352	\$13,691
-------------------------------	---------------------	----	----	----	---	---	---	-----	----	---------	----------

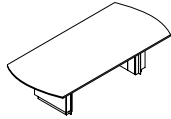

- long grain veneer direction
- base CC8NPC2-2760
- plinth base
- top is 1 1/4" thick
- laminate worksurface, no charge if standard laminate is selected
- base front arc panel, add \$594 to list, arc is only outside bases
- glass worksurface with reverse bevel edge, (see page 308)

**To Order, Specify**

- ① Model Number
- ② Wood Species
- ③ Finish Scheme
  - A. Accent Surround - Veneer or Paint
  - B. Base Pedestal - Veneer or Paint  
(see page 312 - apron follows base pedestal)
- ④ Worksurface Option
  - A. Veneer
  - B. Laminate
  - C. Glossy Low Iron White Back Painted Glass
  - D. Frosted Low Iron White Back Painted Glass  
(see page 308)
- ⑤ Power and Data Options (see pages 519-535)
- ⑥ Other Product Options

Description	① Model	D	L	H	Seat Capacity	Top Pieces	Bases Required	CTN WT	CU FT	Veneer	Glass Top
Arc End Table with Panel Base and Center Console 	<b>CC8JAPM-48216</b>	48	216	29	16	2	4	702	44	\$30,356	\$43,131
	<ul style="list-style-type: none"> <li>· short grain veneer direction</li> <li>· base CC8NPC2-27174</li> <li>· plinth base</li> <li>· top is 1 ¼" thick and in two sections</li> <li>· anodized aluminum center console 160" long</li> <li>· laminate worksurface, no charge if standard laminate is selected</li> <li>· base front arc panel, add \$594 to list, arc is only outside bases</li> <li>· glass worksurface with reverse bevel edge, (see page 308)</li> </ul>										
Arc End Table with Panel Base and Center Console 	<b>CC8JAPM-48192</b>	48	192	29	16	2	3	581	37	\$23,992	\$35,348
	<ul style="list-style-type: none"> <li>· short grain veneer direction</li> <li>· base CC8NPC2-27156</li> <li>· plinth base</li> <li>· top is 1 ¼" thick and in two sections</li> <li>· anodized aluminum center console 144" long</li> <li>· laminate worksurface, no charge if standard laminate is selected</li> <li>· base front arc panel, add \$594 to list, arc is only outside bases</li> <li>· glass worksurface with reverse bevel edge, (see page 308)</li> </ul>										
Arc End Table with Panel Base and Center Console 	<b>CC8JAPM-48168</b>	48	168	29	14	2	3	539	34	\$21,267	\$31,203
	<ul style="list-style-type: none"> <li>· short grain veneer direction</li> <li>· base CC8NPC2-27132</li> <li>· plinth base</li> <li>· top is 1 ¼" thick and in two sections</li> <li>· anodized aluminum center console 120" long</li> <li>· laminate worksurface, no charge if standard laminate is selected</li> <li>· base front arc panel, add \$594 to list, arc is only outside bases</li> <li>· glass worksurface with reverse bevel edge, (see page 308)</li> </ul>										
Arc End Table with Panel Base and Center Console 	<b>CC8JAPM-48144</b>	48	144	29	10	2	3	497	31	\$18,965	\$27,481
	<ul style="list-style-type: none"> <li>· short grain veneer direction</li> <li>· base CC8NPC2-27108</li> <li>· plinth base</li> <li>· top is 1 ¼" thick and in two sections</li> <li>· anodized aluminum center console 96" long</li> <li>· laminate worksurface, no charge if standard laminate is selected</li> <li>· base front arc panel, add \$594 to list, arc is only outside bases</li> <li>· glass worksurface with reverse bevel edge, (see page 308)</li> </ul>										

COLLECTIVE CONFERENCE

Description	① Model	D	L	H	Seat Capacity	Top Pieces	Bases Required	CTN WT	CU FT	Veneer	Glass Top
Arc End Table with Panel Base and Center Console	<b>CC8JAPM-48120</b>	48	120	29	6	2	2	376	24	\$12,839	\$19,512

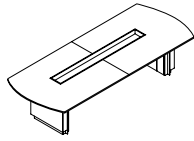

- short grain veneer direction
- base CC8NPC2-2784
- plinth base
- top is 1 1/4" thick and in two sections
- anodized aluminum center console 72" long
- laminate worksurface, no charge if standard laminate is selected
- base front arc panel, add \$594 to list, arc is only outside bases
- glass worksurface with reverse bevel edge, (see page 308)

Arc End Table with Panel Base and Center Console	<b>CC8JAPM-4896</b>	48	96	29	6	1	2	334	21	\$10,363	\$15,703
--	---------------------	----	----	----	---	---	---	-----	----	----------	----------

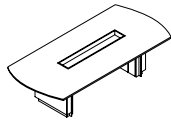

- long grain veneer direction
- base CC8NPC2-2760
- plinth base
- top is 1 1/4" thick
- anodized aluminum center console 48" long
- laminate worksurface, no charge if standard laminate is selected
- base front arc panel, add \$594 to list, arc is only outside bases
- glass worksurface with reverse bevel edge, (see page 308)

**To Order, Specify**

- ① Model Number
- ② Wood Species
- ③ Finish Scheme
  - A. Accent Surround - veneer or paint
  - B. Base Pedestal - veneer or paint  
(see page 312 - apron follows base pedestal)
- ④ Worksurface Option
  - A. Veneer
  - B. Laminate
  - C. Glossy Low Iron White Back Painted Glass
  - D. Frosted Low Iron White Back Painted Glass  
(see page 308)
- ⑤ Power and Data Options (see pages 519-535)
- ⑥ Other Product Options
- ⑦ Center Console Accessories (see pages 390-391 - order separately)

Description	① Model	D	L	H	Seat Capacity	Top Pieces	Bases Required	CTN WT	CU FT	Veneer	Glass Top
-------------	---------	---	---	---	---------------	------------	----------------	--------	-------	--------	-----------

Racetrack Table with Panel Base	<b>CC8JOP2-60216</b>	60	216	29	18	2	4	788	47	\$28,638	\$44,606
---------------------------------	----------------------	----	-----	----	----	---	---	-----	----	----------	----------

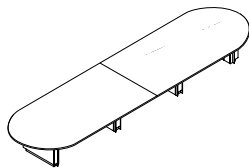

- short grain veneer direction
- base CC8NPC2-32174
- plinth base
- top is 1 1/4" thick and in two sections
- laminate worksurface, no charge if standard laminate is selected
- base front arc panel, add \$594 to list, arc is only outside bases
- glass worksurface with reverse bevel edge, (see page 308)

Racetrack Table with Panel Base	<b>CC8JOP2-60192</b>	60	192	29	14	2	3	657	39	\$22,383	\$36,575
---------------------------------	----------------------	----	-----	----	----	---	---	-----	----	----------	----------

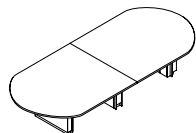

- short grain veneer direction
- base CC8NPC2-32156
- plinth base
- top is 1 1/4" thick and in two sections
- laminate worksurface, no charge if standard laminate is selected
- base front arc panel, add \$594 to list, arc is only outside bases
- glass worksurface with reverse bevel edge, (see page 308)

Racetrack Table with Panel Base	<b>CC8JOP2-60168</b>	60	168	29	12	2	3	605	36	\$20,061	\$32,481
---------------------------------	----------------------	----	-----	----	----	---	---	-----	----	----------	----------

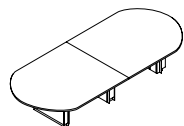

- short grain veneer direction
- base CC8NPC2-32132
- plinth base
- top is 1 1/4" thick and in two sections
- laminate worksurface, no charge if standard laminate is selected
- base front arc panel, add \$594 to list, arc is only outside bases
- glass worksurface with reverse bevel edge, (see page 308)

Racetrack Table with Panel Base	<b>CC8JOP2-60144</b>	60	144	29	8	2	3	553	33	\$18,184	\$28,829
---------------------------------	----------------------	----	-----	----	---	---	---	-----	----	----------	----------

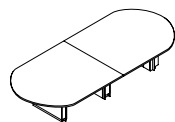

- short grain veneer direction
- base CC8NPC2-32108
- plinth base
- top is 1 1/4" thick and in two sections
- laminate worksurface, no charge if standard laminate is selected
- base front arc panel, add \$594 to list, arc is only outside bases
- glass worksurface with reverse bevel edge, (see page 308)

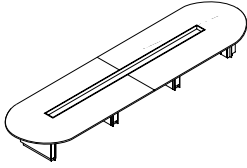
Description	① Model	D	L	H	Seat Capacity	Top Pieces	Bases Required	CTN WT	CU FT	Veneer	Glass Top
Racetrack Table with Panel Base and Center Console 	<b>CC8JOPM-60216</b>	60	216	29	18	2	4	789	55	\$34,962	\$50,930
<ul style="list-style-type: none"> <li>• short grain veneer direction</li> <li>• base CC8NPC2-32174</li> <li>• plinth base</li> <li>• top is 1 1/4" thick and in two sections</li> <li>• anodized aluminum center console 160" long</li> <li>• laminate worksurface, no charge if standard laminate is selected</li> <li>• base front arc panel, add \$594 to list, arc is only outside bases</li> <li>• glass worksurface with reverse bevel edge, (see page 308)</li> </ul>											

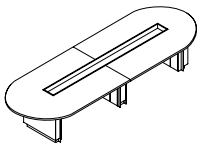
Racetrack Table with Panel Base and Center Console 	<b>CC8JOPM-60192</b>	60	192	29	16	2	3	657	46	\$28,286	\$42,478
<ul style="list-style-type: none"> <li>• short grain veneer direction</li> <li>• base CC8NPC2-32156</li> <li>• plinth base</li> <li>• top is 1 1/4" thick and in two sections</li> <li>• anodized aluminum center console 144" long</li> <li>• laminate worksurface, no charge if standard laminate is selected</li> <li>• base front arc panel, add \$594 to list, arc is only outside bases</li> <li>• glass worksurface with reverse bevel edge, (see page 308)</li> </ul>											

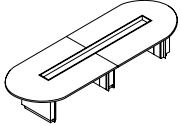
Racetrack Table with Panel Base and Center Console 	<b>CC8JOPM-60168</b>	60	168	29	14	2	3	606	42	\$24,661	\$37,080
<ul style="list-style-type: none"> <li>• short grain veneer direction</li> <li>• base CC8NPC2-32132</li> <li>• plinth base</li> <li>• top is 1 1/4" thick and in two sections</li> <li>• anodized aluminum center console 120" long</li> <li>• laminate worksurface, no charge if standard laminate is selected</li> <li>• base front arc panel, add \$594 to list, arc is only outside bases</li> <li>• glass worksurface with reverse bevel edge, (see page 308)</li> </ul>											

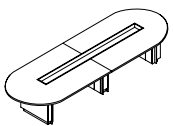
Racetrack Table with Panel Base and Center Console 	<b>CC8JOPM-60144</b>	60	144	29	10	2	3	553	39	\$21,926	\$32,570
<ul style="list-style-type: none"> <li>• short grain veneer direction</li> <li>• base CC8NPC2-32108</li> <li>• plinth base</li> <li>• top is 1 1/4" thick and in two sections</li> <li>• anodized aluminum center console 96" long</li> <li>• laminate worksurface, no charge if standard laminate is selected</li> <li>• base front arc panel, add \$594 to list, arc is only outside bases</li> <li>• glass worksurface with reverse bevel edge, (see page 308)</li> </ul>											

**To Order, Specify:**

**Racetrack Table**

- ① Model Number
- ② Wood Species
- ③ Finish Scheme
  - A. Accent Surround - Veneer or Paint
  - B. Base Pedestal - Veneer or Paint  
(see page 312 - apron follows base pedestal)
- ④ Worksurface Option
  - A. Veneer
  - B. Laminate
  - C. Glossy Low Iron White Back Painted Glass
  - D. Frosted Low Iron White Back Painted Glass  
(see page 308)
- ⑤ Power and Data Options (see pages 519-535)
- ⑥ Other Product Options

**Racetrack Table with Center Console**

- ① Model Number
- ② Wood Species
- ③ Finish Scheme
  - A. Accent Surround - Veneer or Paint
  - B. Base Pedestal - Veneer or Paint  
(see page 312 - apron follows base pedestal)
- ④ Worksurface Option
  - A. Veneer
  - B. Laminate
  - C. Glossy Low Iron White Back Painted Glass
  - D. Frosted Low Iron White Back Painted Glass  
(see page 308)
- ⑤ Power and Data Options (see pages 519-535)
- ⑥ Other Product Options
- ⑦ Center Console Accessories (see pages 390-391 - order separately)

Description	① Model	D	L	H	Seat Capacity	Top Pieces	Bases Required	CTN WT	CU FT	Veneer	Glass Top
-------------	---------	---	---	---	---------------	------------	----------------	--------	-------	--------	-----------

Racetrack Table with Panel Base	<b>CC8JOP2-48216</b>	48	216	29	16	2	4	694	38	\$24,234	\$37,008
---------------------------------	----------------------	----	-----	----	----	---	---	-----	----	----------	----------

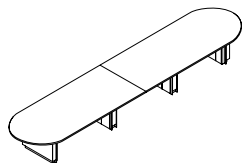

- short grain veneer direction
- base CC8NPC2-27174
- plinth base
- top is 1 1/4" thick and in two sections
- laminate worksurface, no charge if standard laminate is selected
- base front arc panel, add \$594 to list, arc is only outside bases
- glass worksurface with reverse bevel edge, (see page 308)

Racetrack Table with Panel Base	<b>CC8JOP2-48192</b>	48	192	29	14	2	3	565	32	\$22,821	\$34,176
---------------------------------	----------------------	----	-----	----	----	---	---	-----	----	----------	----------

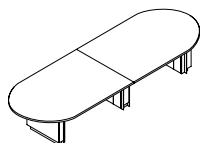

- short grain veneer direction
- base CC8NPC2-27156
- plinth base
- top is 1 1/4" thick and in two sections
- laminate worksurface, no charge if standard laminate is selected
- base front arc panel, add \$594 to list, arc is only outside bases
- glass worksurface with reverse bevel edge, (see page 308)

Racetrack Table with Panel Base	<b>CC8JOP2-48168</b>	48	168	29	12	2	3	531	29	\$16,819	\$26,754
---------------------------------	----------------------	----	-----	----	----	---	---	-----	----	----------	----------

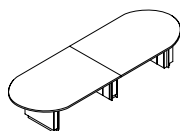

- short grain veneer direction
- base CC8NPC2-27132
- plinth base
- top is 1 1/4" thick and in two sections
- laminate worksurface, no charge if standard laminate is selected
- base front arc panel, add \$594 to list, arc is only outside bases
- glass worksurface with reverse bevel edge, (see page 308)

Racetrack Table with Panel Base	<b>CC8JOP2-48144</b>	48	144	29	8	2	3	481	27	\$15,353	\$23,869
---------------------------------	----------------------	----	-----	----	---	---	---	-----	----	----------	----------

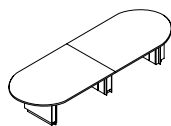

- short grain veneer direction
- base CC8NPC2-27108
- plinth base
- top is 1 1/4" thick and in two sections
- laminate worksurface, no charge if standard laminate is selected
- base front arc panel, add \$594 to list, arc is only outside bases
- glass worksurface with reverse bevel edge, (see page 308)

Description	① Model	D	L	H	Seat Capacity	Top Pieces	Bases Required	CTN WT	CU FT	Veneer	Glass Top
Racetrack Table with Panel Base	<b>CC8JOP2-48120</b>	48	120	29	6	2	2	359	20	\$10,066	\$16,740

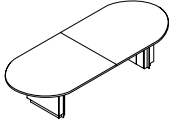

- short grain veneer direction
- base CC8NPC2-2784
- plinth base
- top is 1 1/4" thick and in two sections
- laminate worksurface, no charge if standard laminate is selected
- base front arc panel, add \$594 to list, arc is only outside bases
- glass worksurface with reverse bevel edge, (see page 308)

Racetrack Table with Panel Base	<b>CC8JOP2-4896</b>	48	96	29	6	1	2	309	18	\$8,427	\$13,767
---------------------------------	---------------------	----	----	----	---	---	---	-----	----	---------	----------

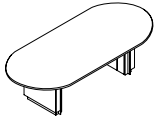

- long grain veneer direction
- base CC8NPC2-2760
- plinth base
- top is 1 1/4" thick
- laminate worksurface, no charge if standard laminate is selected
- base front arc panel, add \$594 to list, arc is only outside bases
- glass worksurface with reverse bevel edge, (see page 308)

COLLECTIVE CONFERENCE

**To Order, Specify:**

- ① Model Number
- ② Wood Species
- ③ Finish Scheme
  - A. Accent Surround - Veneer or Paint
  - B. Base Pedestal - Veneer or Paint  
(see page 312 - apron follows base pedestal)
- ④ Worksurface Option
  - A. Veneer
  - B. Laminate
  - C. Glossy Low Iron White Back Painted Glass
  - D. Frosted Low Iron White Back Painted Glass  
(see page 308)
- ⑤ Power and Data Options (see pages 519-535)
- ⑥ Other Product Options

Description	① Model	D	L	H	Seat Capacity	Top Pieces	Bases Required	CTN WT	CU FT	Veneer	Glass Top
-------------	---------	---	---	---	---------------	------------	----------------	--------	-------	--------	-----------

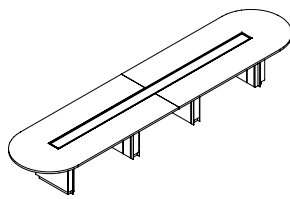
<b>Racetrack Table with Panel Base and Center Console</b> 	<b>CC8JOPM-48216</b>	48	216	29	16	2	4	694	44	\$30,560	\$43,333
	<ul style="list-style-type: none"> <li>· short grain veneer direction</li> <li>· base CC8NPC2-27174</li> <li>· plinth base</li> <li>· top is 1 1/4" thick and in two sections</li> <li>· anodized aluminum center console 160" long</li> <li>· laminate worksurface, no charge if standard laminate is selected</li> <li>· base front arc panel, add \$594 to list, arc is only outside bases</li> <li>· glass worksurface with reverse bevel edge, (see page 308)</li> </ul>										

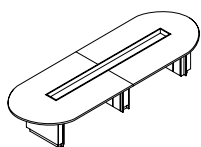
<b>Racetrack Table with Panel Base and Center Console</b> 	<b>CC8JOPM-48192</b>	48	192	29	14	2	3	566	37	\$24,169	\$35,523
	<ul style="list-style-type: none"> <li>· short grain veneer direction</li> <li>· base CC8NPC2-27156</li> <li>· plinth base</li> <li>· top is 1 1/4" thick and in two sections</li> <li>· anodized aluminum center console 144" long</li> <li>· laminate worksurface, no charge if standard laminate is selected</li> <li>· base front arc panel, add \$594 to list, arc is only outside bases</li> <li>· glass worksurface with reverse bevel edge, (see page 308)</li> </ul>										

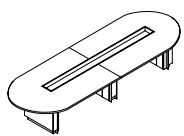
<b>Racetrack Table with Panel Base and Center Console</b> 	<b>CC8JOPM-48168</b>	48	168	29	12	2	3	531	34	\$21,420	\$31,356
	<ul style="list-style-type: none"> <li>· short grain veneer direction</li> <li>· base CC8NPC2-27132</li> <li>· plinth base</li> <li>· top is 1 1/4" thick and in two sections</li> <li>· anodized aluminum center console 120" long</li> <li>· laminate worksurface, no charge if standard laminate is selected</li> <li>· base front arc panel, add \$594 to list, arc is only outside bases</li> <li>· glass worksurface with reverse bevel edge, (see page 308)</li> </ul>										

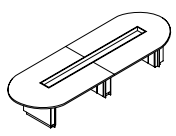
<b>Racetrack Table with Panel Base and Center Console</b> 	<b>CC8JOPM-48144</b>	48	144	29	8	2	3	482	31	\$19,093	\$27,608
	<ul style="list-style-type: none"> <li>· short grain veneer direction</li> <li>· base CC8NPC2-27108</li> <li>· plinth base</li> <li>· top is 1 1/4" thick and in two sections</li> <li>· anodized aluminum center console 96" long</li> <li>· laminate worksurface, no charge if standard laminate is selected</li> <li>· base front arc panel, add \$594 to list, arc is only outside bases</li> <li>· glass worksurface with reverse bevel edge, (see page 308)</li> </ul>										

COLLECTIVE CONFERENCE



Description	① Model	D	L	H	Seat Capacity	Top Pieces	Bases Required	CTN WT	CU FT	Veneer	Glass Top
Racetrack Table with Panel Base and Center Console	<b>CC8JOPM-48120</b>	48	120	29	6	2	2	360	24	\$12,941	\$19,615

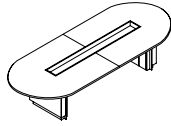

- short grain veneer direction
- base CC8NPC2-2784
- plinth base
- top is 1 ¼" thick and in two sections
- anodized aluminum center console 72" long
- laminate worksurface, no charge if standard laminate is selected
- base front arc panel, add \$594 to list, arc is only outside bases
- glass worksurface with reverse bevel edge, (see page 308)

Racetrack Table with Panel Base and Center Console	<b>CC8JOPM-4896</b>	48	96	29	6	1	2	310	21	\$10,438	\$15,777
--	---------------------	----	----	----	---	---	---	-----	----	----------	----------

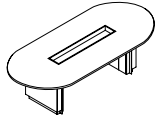

- long grain veneer direction
- base CC8NPC2-2760
- plinth base
- top is 1 ¼" thick
- anodized aluminum center console 48" long
- laminate worksurface, no charge if standard laminate is selected
- base front arc panel, add \$594 to list, arc is only outside bases
- glass worksurface with reverse bevel edge, (see page 308)

**To Order, Specify:**

- ① Model Number
- ② Wood Species
- ③ Finish Scheme
  - A. Accent Surround - Veneer or Paint
  - B. Base Pedestal - Veneer or Paint  
(see page 312 - apron follows base pedestal)
- ④ Worksurface Option
  - A. Veneer
  - B. Laminate
  - C. Glossy Low Iron White Back Painted Glass
  - D. Frosted Low Iron White Back Painted Glass  
(see page 308)
- ⑤ Power and Data Options (see pages 519-535)
- ⑥ Other Product Options
- ⑦ Center Console Accessories (see pages 390-391 - order separately)

Description	① Model	D	L	H	Seat Capacity	Top Pieces	Bases Required	CTN WT	CU FT	Veneer	Glass Top
-------------	---------	---	---	---	---------------	------------	----------------	--------	-------	--------	-----------

Boat Shape Table with Panel Base	<b>CC8JBP2-60216</b>	60	216	29	16	2	4	736	47	\$27,664	\$43,630
----------------------------------	----------------------	----	-----	----	----	---	---	-----	----	----------	----------

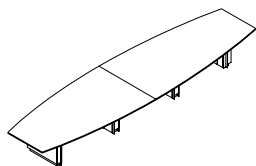

- short grain veneer direction
- base CC8NPC2-32174
- plinth base
- top is 1 1/4" thick and in two sections
- laminate worksurface, no charge if standard laminate is selected
- base front arc panel, add \$594 to list, arc is only outside bases
- glass worksurface with reverse bevel edge, (see page 308)

Boat Shape Table with Panel Base	<b>CC8JBP2-60192</b>	60	192	29	14	2	3	613	39	\$21,644	\$35,836
----------------------------------	----------------------	----	-----	----	----	---	---	-----	----	----------	----------

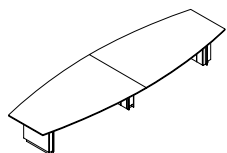

- short grain veneer direction
- base CC8NPC2-32156
- plinth base
- top is 1 1/4" thick and in two sections
- laminate worksurface, no charge if standard laminate is selected
- base front arc panel, add \$594 to list, arc is only outside bases
- glass worksurface with reverse bevel edge, (see page 308)

Boat Shape Table with Panel Base	<b>CC8JBP2-60168</b>	60	168	29	12	2	3	570	36	\$19,460	\$31,879
----------------------------------	----------------------	----	-----	----	----	---	---	-----	----	----------	----------

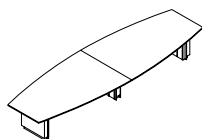

- short grain veneer direction
- base CC8NPC2-32132
- plinth base
- top is 1 1/4" thick and in two sections
- laminate worksurface, no charge if standard laminate is selected
- base front arc panel, add \$594 to list, arc is only outside bases
- glass worksurface with reverse bevel edge, (see page 308)

COLLECTIVE CONFERENCE

Description	① Model	D	L	H	Seat Capacity	Top Pieces	Bases Required	CTN WT	CU FT	Veneer	Glass Top
-------------	---------	---	---	---	---------------	------------	----------------	--------	-------	--------	-----------

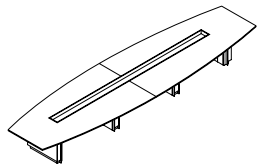

- short grain veneer direction
- base CC8NPC2-32174
- plinth base
- top is 1 1/4" thick and in two sections
- anodized aluminum center console 160" long
- laminate worksurface, no charge if standard laminate is selected
- base front arc panel, add \$594 to list, arc is only outside bases
- glass worksurface with reverse bevel edge, (see page 308)

<b>Boat Shape Table with Panel Base and Center Console</b>	<b>CC8JBPM-60192</b>	60	192	29	14	2	3	613	46	\$27,106	\$41,298
--	----------------------	----	-----	----	----	---	---	-----	----	----------	----------

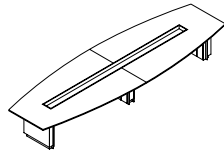

- short grain veneer direction
- base CC8NPC2-32156
- plinth base
- top is 1 1/4" thick and in two sections
- anodized aluminum center console 144" long
- laminate worksurface, no charge if standard laminate is selected
- base front arc panel, add \$594 to list, arc is only outside bases
- glass worksurface with reverse bevel edge, (see page 308)

<b>Boat Shape Table with Panel Base and Center Console</b>	<b>CC8JBPM-60168</b>	60	168	29	12	2	3	571	42	\$24,063	\$36,483
--	----------------------	----	-----	----	----	---	---	-----	----	----------	----------

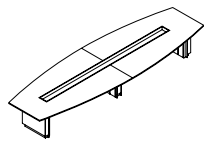

- short grain veneer direction
- base CC8NPC2-32132
- plinth base
- top is 1 1/4" thick and in two sections
- anodized aluminum center console 120" long
- laminate worksurface, no charge if standard laminate is selected
- base front arc panel, add \$594 to list, arc is only outside bases
- glass worksurface with reverse bevel edge, (see page 308)

**To Order, Specify:**

**Boat Shape Table**

- ① Model Number
- ② Wood Species
- ③ Finish Scheme
  - A. Accent Surround - Veneer or Paint
  - B. Base Pedestal - Veneer or Paint  
(see page 312 - apron follows base pedestal)
- ④ Worksurface Option
  - A. Veneer
  - B. Laminate
  - C. Glossy Low Iron White Back Painted Glass
  - D. Frosted Low Iron White Back Painted Glass  
(see page 308)
- ⑤ Power and Data Options (see pages 519-535)
- ⑥ Other Product Options

**Boat Shape Table with Center Console**

- ① Model Number
- ② Wood Species
- ③ Finish Scheme
  - A. Accent Surround - Veneer or Paint
  - B. Base Pedestal - Veneer or Paint  
(see page 312 - apron follows base pedestal)
- ④ Worksurface Option
  - A. Veneer
  - B. Laminate
  - C. Glossy Low Iron White Back Painted Glass
  - D. Frosted Low Iron White Back Painted Glass  
(see page 308)
- ⑤ Power and Data Options (see pages 519-535)
- ⑥ Other Product Options
- ⑦ Center Console Accessories (see pages 390-391 - order separately)

COLLECTIVE CONFERENCE

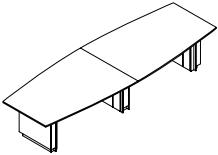
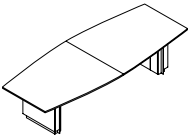
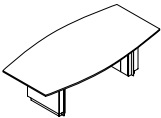
Description	① Model	D	L	H	Seat Capacity	Top Pieces	Bases Required	CTN WT	CU FT	Veneer	Glass Top
Boat Shape Table with Panel Base 	<b>CC8JBP2-48144</b>	48	144	29	8	2	3	469	27	\$17,713	\$26,228
	<ul style="list-style-type: none"> <li>· short grain veneer direction</li> <li>· base CC8NPC2-27108</li> <li>· plinth base</li> <li>· top is 1 1/4" thick and in two sections</li> <li>· laminate worksurface, no charge if standard laminate is selected</li> <li>· base front arc panel, add \$594 to list, arc is only outside bases</li> <li>· glass worksurface with reverse bevel edge, (see page 308)</li> </ul>										
Boat Shape Table with Panel Base 	<b>CC8JBP2-48120</b>	48	120	29	6	2	2	352	20	\$11,322	\$17,995
	<ul style="list-style-type: none"> <li>· short grain veneer direction</li> <li>· base CC8NPC2-2784</li> <li>· plinth base</li> <li>· top is 1 1/4" thick and in two sections</li> <li>· laminate worksurface, no charge if standard laminate is selected</li> <li>· base front arc panel, add \$594 to list, arc is only outside bases</li> <li>· glass worksurface with reverse bevel edge, (see page 308)</li> </ul>										
Boat Shape Table with Panel Base 	<b>CC8JBP2-4896</b>	48	96	29	6	1	2	315	18	\$9,368	\$14,708
	<ul style="list-style-type: none"> <li>· long grain veneer direction</li> <li>· base CC8NPC2-2760</li> <li>· plinth base</li> <li>· top is 1 1/4" thick</li> <li>· laminate worksurface, no charge if standard laminate is selected</li> <li>· base front arc panel, add \$594 to list, arc is only outside bases</li> <li>· glass worksurface with reverse bevel edge, (see page 308)</li> </ul>										

COLLECTIVE CONFERENCE

Description	① Model	D	L	H	Seat Capacity	Top Pieces	Bases Required	CTN WT	CU FT	Veneer	Glass Top
-------------	---------	---	---	---	---------------	------------	----------------	--------	-------	--------	-----------

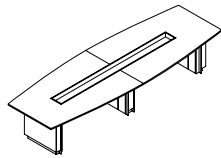

- short grain veneer direction
- base CC8NPC2-27108
- plinth base
- top is 1 1/4" thick and in two sections
- anodized aluminum center console 96" long
- laminate worksurface, no charge if standard laminate is selected
- base front arc panel, add \$594 to list, arc is only outside bases
- glass worksurface with reverse bevel edge, (see page 308)

<b>Boat Shape Table with Panel Base and Center Console</b>	<b>CC8JBPM-48120</b>	48	120	29	6	2	2	353	24	\$14,197	\$20,869
--	----------------------	----	-----	----	---	---	---	-----	----	----------	----------

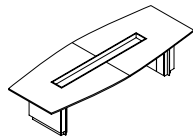

- short grain veneer direction
- base CC8NPC2-2784
- plinth base
- top is 1 1/4" thick and in two sections
- anodized aluminum center console 72" long
- laminate worksurface, no charge if standard laminate is selected
- base front arc panel, add \$594 to list, arc is only outside bases
- glass worksurface with reverse bevel edge, (see page 308)

<b>Boat Shape Table with Panel Base and Center Console</b>	<b>CC8JBPM-4896</b>	48	96	29	6	1	2	316	21	\$11,378	\$16,718
--	---------------------	----	----	----	---	---	---	-----	----	----------	----------

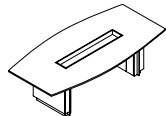

- long grain veneer direction
- base CC8NPC2-2760
- plinth base
- top is 1 1/4" thick
- anodized aluminum center console 48" long
- laminate worksurface, no charge if standard laminate is selected
- base front arc panel, add \$594 to list, arc is only outside bases
- glass worksurface with reverse bevel edge, (see page 308)

**To Order, Specify:**

**Boat Shape Table**

- ① Model Number
- ② Wood Species
- ③ Finish Scheme
  - A. Accent Surround - Veneer or Paint
  - B. Base Pedestal - Veneer or Paint  
(see page 312 - apron follows base pedestal)
- ④ Worksurface Option
  - A. Veneer
  - B. Laminate
  - C. Glossy Low Iron White Back Painted Glass
  - D. Frosted Low Iron White Back Painted Glass  
(see page 308)
- ⑤ Power and Data Options (see pages 519-535)
- ⑥ Other Product Options

**Boat Shape Table with Center Console**

- ① Model Number
- ② Wood Species
- ③ Finish Scheme
  - A. Accent Surround - Veneer or Paint
  - B. Base Pedestal - Veneer or Paint  
(see page 312 - apron follows base pedestal)
- ④ Worksurface Option
  - A. Veneer
  - B. Laminate
  - C. Glossy Low Iron White Back Painted Glass
  - D. Frosted Low Iron White Back Painted Glass  
(see page 308)
- ⑤ Power and Data Options (see pages 519-535)
- ⑥ Other Product Options
- ⑦ Center Console Accessories (see pages 390-391 - order separately)

COLLECTIVE CONFERENCE

Description	① Model	D	L	H	Seat Capacity	Top Pieces	Bases Required	CTN WT	CU FT	Veneer	Glass Top
-------------	---------	---	---	---	---------------	------------	----------------	--------	-------	--------	-----------

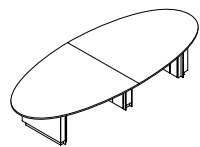

- short grain veneer direction
- base CC8NPC2-32108
- plinth base
- top is 1 1/4" thick and in two sections
- laminate worksurface, no charge if standard laminate is selected
- base front arc panel, add \$594 to list, arc is only outside bases
- glass worksurface with reverse bevel edge, (see page 308)

Ellipse Table with Panel Base	<b>CC8JEP2-54120</b>	54	120	29	8	2	2	348	22	\$14,454	\$21,962
-------------------------------	----------------------	----	-----	----	---	---	---	-----	----	----------	----------

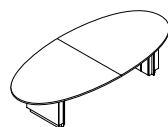

- short grain veneer direction
- base CC8NPC2-2784
- plinth base
- top is 1 1/4" thick and in two sections
- laminate worksurface, no charge if standard laminate is selected
- base front arc panel, add \$594 to list, arc is only outside bases
- glass worksurface with reverse bevel edge, (see page 308)

Ellipse Table with Panel Base	<b>CC8JEP2-4896</b>	48	96	29	6	1	2	297	18	\$9,805	\$15,144
-------------------------------	---------------------	----	----	----	---	---	---	-----	----	---------	----------

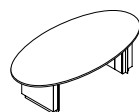

- long grain veneer direction
- base CC8NPC2-2760
- plinth base
- top is 1 1/4" thick
- laminate worksurface, no charge if standard laminate is selected
- base front arc panel, add \$594 to list, arc is only outside bases
- glass worksurface with reverse bevel edge, (see page 308)

COLLECTIVE CONFERENCE

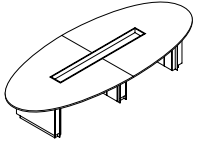
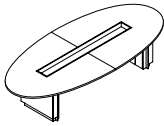
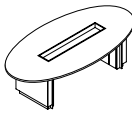
Description	① Model	D	L	H	Seat Capacity	Top Pieces	Bases Required	CTN WT	CU FT	Veneer	Glass Top
<b>Ellipse Table with Panel Base and Center Console</b> 	<b>CC8JEPM-60144</b>	60	144	29	10	2	3	508	39	\$24,947	\$35,592
	<ul style="list-style-type: none"> <li>· short grain veneer direction</li> <li>· base CC8NPC2-32108</li> <li>· plinth base</li> <li>· top is 1 ¼" thick and in two sections</li> <li>· anodized aluminum center console 96" long</li> <li>· laminate worksurface, no charge if standard laminate is selected</li> <li>· base front arc panel, add \$594 to list, arc is only outside bases</li> <li>· glass worksurface with reverse bevel edge, (see page 308)</li> </ul>										
<b>Ellipse Table with Panel Base and Center Console</b> 	<b>CC8JEPM-54120</b>	54	120	29	8	2	2	349	26	\$17,329	\$24,835
	<ul style="list-style-type: none"> <li>· short grain veneer direction</li> <li>· base CC8NPC2-2784</li> <li>· plinth base</li> <li>· top is 1 ¼" thick and in two sections</li> <li>· anodized aluminum center console 72" long</li> <li>· laminate worksurface, no charge if standard laminate is selected</li> <li>· base front arc panel, add \$594 to list, arc is only outside bases</li> <li>· glass worksurface with reverse bevel edge, (see page 308)</li> </ul>										
<b>Ellipse Table with Panel Base and Center Console</b> 	<b>CC8JEPM-4896</b>	48	96	29	6	1	2	298	21	\$11,665	\$17,003
	<ul style="list-style-type: none"> <li>· long grain veneer direction</li> <li>· base CC8NPC2-2760</li> <li>· plinth base</li> <li>· top is 1 ¼" thick</li> <li>· anodized aluminum center console 48" long</li> <li>· laminate worksurface, no charge if standard laminate is selected</li> <li>· base front arc panel, add \$594 to list, arc is only outside bases</li> <li>· glass worksurface with reverse bevel edge, (see page 308)</li> </ul>										

COLLECTIVE CONFERENCE

**To Order, Specify:**

**Ellipse Tables**

- ① Model Number
- ② Wood Species
- ③ Finish Scheme
  - A. Accent Surround - Veneer or Paint
  - B. Base Pedestal - Veneer or Paint  
(see page 312 - apron follows base pedestal)
- ④ Worksurface Option
  - A. Veneer
  - B. Laminate
  - C. Glossy Low Iron White Back Painted Glass
  - D. Frosted Low Iron White Back Painted Glass  
(see page 308)
- ⑤ Power and Data Options (see pages 519-535)
- ⑥ Other Product Options

**Ellipse Table with Center Console**

- ① Model Number
- ② Wood Species
- ③ Finish Scheme
  - A. Accent Surround - Veneer or Paint
  - B. Base Pedestal - Veneer or Paint  
(see page 312 - apron follows base pedestal)
- ④ Worksurface Option
  - A. Veneer
  - B. Laminate
  - C. Glossy Low Iron White Back Painted Glass
  - D. Frosted Low Iron White Back Painted Glass  
(see page 308)
- ⑤ Power and Data Options (see pages 519-535)
- ⑥ Other Product Options
- ⑦ Center Console Accessories (see pages 390-391 - order separately)

Description	① Model	D	L	H	Seat Capacity	Top Pieces	Bases Required	CTN WT	CU FT	Veneer	Glass Top
View Table with Panel Base	<b>CC8JVP2-60168</b>	60	168	29	11	2	3	560	34	\$20,187	\$32,606

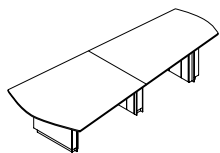

- short grain veneer direction
- base CC8NPC9-32168
- plinth base
- top is 1 1/4" thick and in two sections
- laminate worksurface, no charge if standard laminate is selected
- glass worksurface with reverse bevel edge, (see page 308)
- top size: 168"w x 40/60"d

View Table with Panel Base	<b>CC8JVP2-60144</b>	60	144	29	11	2	3	516	31	\$18,295	\$28,938
----------------------------	----------------------	----	-----	----	----	---	---	-----	----	----------	----------

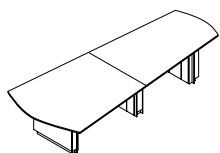

- short grain veneer direction
- base CC8NPC9-32144
- plinth base
- top is 1 1/4" thick and in two sections
- laminate worksurface, no charge if standard laminate is selected
- glass worksurface with reverse bevel edge, (see page 308)
- top size: 144"w x 40/60"d

View Table with Panel Base	<b>CC8JVP2-60120</b>	60	120	29	9	2	2	394	24	\$11,720	\$20,061
----------------------------	----------------------	----	-----	----	---	---	---	-----	----	----------	----------

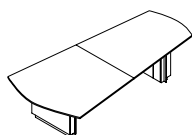

- short grain veneer direction
- base CC8NPC9-32120
- plinth base
- top is 1 1/4" thick and in two sections
- laminate worksurface, no charge if standard laminate is selected
- glass worksurface with reverse bevel edge, (see page 308)
- top size: 120"w x 40/60"d

View Table with Panel Base	<b>CC8JVP2-6096</b>	60	96	29	7	1	2	350	21	\$9,740	\$16,414
----------------------------	---------------------	----	----	----	---	---	---	-----	----	---------	----------

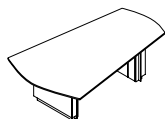

- long grain veneer direction
- base CC8NPC9-3296
- plinth base
- top is 1 1/4" thick
- laminate worksurface, no charge if standard laminate is selected
- glass worksurface with reverse bevel edge, (see page 308)
- top size: 96"w x 40/60"d

COLLECTIVE CONFERENCE

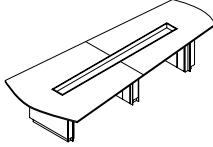
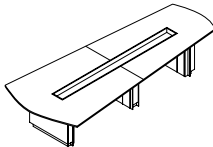
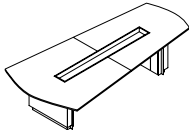
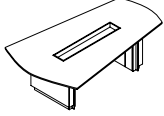

Description	① Model	D	L	H	Seat Capacity	Top Pieces	Bases Required	CTN WT	CU FT	Veneer	Glass Top
<b>View Table with Panel Base and Center Console</b> 	<b>CC8JVPM-60168</b>	60	168	29	11	2	3	561	40	\$24,788	\$37,206
	<ul style="list-style-type: none"> <li>• short grain veneer direction</li> <li>• base CC8NPC9-32168</li> <li>• plinth base</li> <li>• top is 1 1/4" thick and in two sections</li> <li>• anodized aluminum center console 120" long</li> <li>• laminate worksurface, no charge if standard laminate is selected</li> <li>• glass worksurface with reverse bevel edge, (see page 308)</li> <li>• top size: 168"w x 40/60"d</li> </ul>										
<b>View Table with Panel Base and Center Console</b> 	<b>CC8JVPM-60144</b>	60	144	29	11	2	3	516	37	\$22,034	\$32,678
	<ul style="list-style-type: none"> <li>• short grain veneer direction</li> <li>• base CC8NPC9-32144</li> <li>• plinth base</li> <li>• top is 1 1/4" thick and in two sections</li> <li>• anodized aluminum center console 96" long</li> <li>• laminate worksurface, no charge if standard laminate is selected</li> <li>• glass worksurface with reverse bevel edge, (see page 308)</li> <li>• top size: 144"w x 40/60"d</li> </ul>										
<b>View Table with Panel Base and Center Console</b> 	<b>CC8JVPM-60120</b>	60	120	29	9	2	2	394	29	\$14,593	\$22,935
	<ul style="list-style-type: none"> <li>• short grain veneer direction</li> <li>• base CC8NPC9-32120</li> <li>• plinth base</li> <li>• top is 1 1/4" thick and in two sections</li> <li>• anodized aluminum center console 72" long</li> <li>• laminate worksurface, no charge if standard laminate is selected</li> <li>• glass worksurface with reverse bevel edge, (see page 308)</li> <li>• top size: 120"w x 40/60"d</li> </ul>										
<b>View Table with Panel Base and Center Console</b> 	<b>CC8JVPM-6096</b>	60	96	29	7	1	2	350	25	\$11,754	\$18,427
	<ul style="list-style-type: none"> <li>• long grain veneer direction</li> <li>• base CC8NPC9-3296</li> <li>• plinth base</li> <li>• top is 1 1/4" thick</li> <li>• anodized aluminum center console 48" long</li> <li>• laminate worksurface, no charge if standard laminate is selected</li> <li>• glass worksurface with reverse bevel edge, (see page 308)</li> <li>• top size: 96"w x 40/60"d</li> </ul>										

**To Order, Specify:**

- ① Model Number
- ② Wood Species
- ③ Finish Scheme
  - A. Accent Surround - Veneer or Paint
  - B. Base Pedestal - Veneer or Paint  
(see page 312 - apron follows base pedestal)
- ④ Worksurface Option
  - A. Veneer
  - B. Laminate
  - C. Glossy Low Iron White Back Painted Glass
  - D. Frosted Low Iron White Back Painted Glass  
(see page 308)
- ⑤ Power and Data Options (see pages 519-535)
- ⑥ Other Product Options

COLLECTIVE CONFERENCE

Description	① Model	D	L	H	Seat Capacity	Top Pieces	Bases Required	CTN WT	CU FT	Veneer	Glass Top
-------------	---------	---	---	---	---------------	------------	----------------	--------	-------	--------	-----------

Rectangular Table with Rectangular Base	<b>CC8JRR2-60216</b>	60	216	29	18	2	3	787	42	\$30,229	\$46,196
---	----------------------	----	-----	----	----	---	---	-----	----	----------	----------

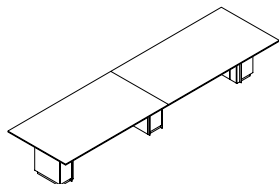

- short grain veneer direction
- base CC8NRC2-27174
- plinth base
- top is 1 1/4" thick and in two sections
- laminate worksurface, no charge if standard laminate is selected
- glass worksurface with reverse bevel edge, (see page 308)
- aluminum edge available, specify and add \$6,080 list

Rectangular Table with Rectangular Base	<b>CC8JRR2-60192</b>	60	192	29	16	2	3	737	39	\$23,453	\$37,646
---	----------------------	----	-----	----	----	---	---	-----	----	----------	----------

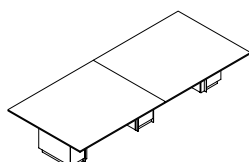

- short grain veneer direction
- base CC8NRC2-27156
- plinth base
- top is 1 1/4" thick and in two sections
- laminate worksurface, no charge if standard laminate is selected
- glass worksurface with reverse bevel edge, (see page 308)
- aluminum edge available, specify and add \$5,554 list

Rectangular Table with Rectangular Base	<b>CC8JRR2-60168</b>	60	168	29	14	2	3	683	36	\$21,263	\$33,681
---	----------------------	----	-----	----	----	---	---	-----	----	----------	----------

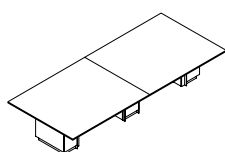

- short grain veneer direction
- base CC8NRC2-27132
- plinth base
- top is 1 1/4" thick and in two sections
- laminate worksurface, no charge if standard laminate is selected
- glass worksurface with reverse bevel edge, (see page 308)
- aluminum edge available, specify and add \$5,027 list

Rectangular Table with Rectangular Base	<b>CC8JRR2-60144</b>	60	144	29	10	2	3	632	33	\$19,517	\$30,162
---	----------------------	----	-----	----	----	---	---	-----	----	----------	----------

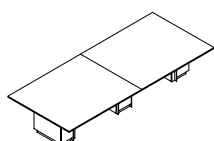

- short grain veneer direction
- base CC8NRC2-27108
- plinth base
- top is 1 1/4" thick and in two sections
- laminate worksurface, no charge if standard laminate is selected
- glass worksurface with reverse bevel edge, (see page 308)
- aluminum edge available, specify and add \$4,496 list

COLLECTIVE CONFERENCE

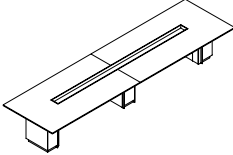
Description	① Model	D	L	H	Seat Capacity	Top Pieces	Bases Required	CTN WT	CU FT	Veneer	Glass Top
Rectangular Table with Rectangular Base and Center Console 	<b>CC8JRRM-60216</b>	60	216	29	18	2	3	788	50	\$36,555	\$52,522
	<ul style="list-style-type: none"> <li>• short grain veneer direction</li> <li>• base CC8NRC2-27174</li> <li>• plinth base</li> <li>• top is 1 1/4" thick and in two sections</li> <li>• anodized aluminum center console 160" long</li> <li>• laminate worksurface, no charge if standard laminate is selected</li> <li>• glass worksurface with reverse bevel edge, (see page 308)</li> <li>• aluminum edge available, specify and add \$6,080 list</li> </ul>										

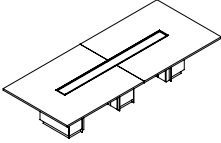
Rectangular Table with Rectangular Base and Center Console 	<b>CC8JRRM-60192</b>	60	192	29	16	2	3	737	46	\$28,916	\$43,108
	<ul style="list-style-type: none"> <li>• short grain veneer direction</li> <li>• base CC8NRC2-27156</li> <li>• plinth base</li> <li>• top is 1 1/4" thick and in two sections</li> <li>• anodized aluminum center console 144" long</li> <li>• laminate worksurface, no charge if standard laminate is selected</li> <li>• glass worksurface with reverse bevel edge, (see page 308)</li> <li>• aluminum edge available, specify and add \$5,554 list</li> </ul>										

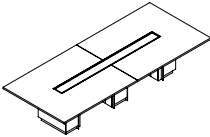
Rectangular Table with Rectangular Base and Center Console 	<b>CC8JRRM-60168</b>	60	168	29	14	2	3	684	42	\$25,862	\$38,281
	<ul style="list-style-type: none"> <li>• short grain veneer direction</li> <li>• base CC8NRC2-27132</li> <li>• plinth base</li> <li>• top is 1 1/4" thick and in two sections</li> <li>• anodized aluminum center console 120" long</li> <li>• laminate worksurface, no charge if standard laminate is selected</li> <li>• glass worksurface with reverse bevel edge, (see page 308)</li> <li>• aluminum edge available, specify and add \$5,027 list</li> </ul>										

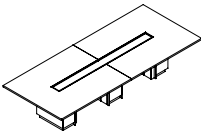
Rectangular Table with Rectangular Base and Center Console 	<b>CC8JRRM-60144</b>	60	144	29	10	2	3	632	39	\$23,253	\$33,898
	<ul style="list-style-type: none"> <li>• short grain veneer direction</li> <li>• base CC8NRC2-27108</li> <li>• plinth base</li> <li>• top is 1 1/4" thick and in two sections</li> <li>• anodized aluminum center console 96" long</li> <li>• laminate worksurface, no charge if standard laminate is selected</li> <li>• glass worksurface with reverse bevel edge, (see page 308)</li> <li>• aluminum edge available, specify and add \$4,496 list</li> </ul>										

**To Order, Specify:**

**Rectangular Table**

- ① Model Number
- ② Wood Species
- ③ Finish Scheme
  - A. Accent Surround - Veneer or Paint
  - B. Base Pedestal - Veneer or Paint  
(see page 312 - apron follows base pedestal)
- ④ Worksurface Option
  - A. Veneer
  - B. Laminate
  - C. Glossy Low Iron White Back Painted Glass
  - D. Frosted Low Iron White Back Painted Glass  
(see page 308)
- ⑤ Power and Data Options (see pages 519-535)
- ⑥ Other Product Options

**Rectangular Table with Center Console**

- ① Model Number
- ② Wood Species
- ③ Finish Scheme
  - A. Accent Surround - Veneer or Paint
  - B. Base Pedestal - Veneer or Paint  
(see page 312 - apron follows base pedestal)
- ④ Worksurface Option
  - A. Veneer
  - B. Laminate
  - C. Glossy Low Iron White Back Painted Glass
  - D. Frosted Low Iron White Back Painted Glass  
(see page 308)
- ⑤ Power and Data Options (see pages 519-535)
- ⑥ Other Product Options
- ⑦ Center Console Accessories (see pages 390-391 - order separately)

Description	① Model	D	L	H	Seat Capacity	Top Pieces	Bases Required	CTN WT	CU FT	Veneer	Glass Top
-------------	---------	---	---	---	---------------	------------	----------------	--------	-------	--------	-----------

Rectangular Table with Rectangular Base	<b>CC8JRR2-48216</b>	48	216	29	16	2	3	654	37	\$25,738	\$38,513
---	----------------------	----	-----	----	----	---	---	-----	----	----------	----------

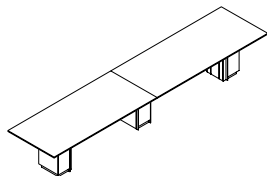

- short grain veneer direction
- base CC8NRC2-21174
- plinth base
- top is 1 1/4" thick and in two sections
- laminate worksurface, no charge if standard laminate is selected
- glass worksurface with reverse bevel edge, (see page 308)
- aluminum edge available, specify and add \$5,818 list

Rectangular Table with Rectangular Base	<b>CC8JRR2-48192</b>	48	192	29	14	2	3	612	35	\$19,738	\$31,093
---	----------------------	----	-----	----	----	---	---	-----	----	----------	----------

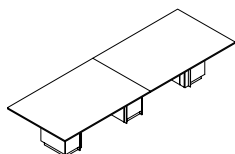

- short grain veneer direction
- base CC8NRC2-21156
- plinth base
- top is 1 1/4" thick and in two sections
- laminate worksurface, no charge if standard laminate is selected
- glass worksurface with reverse bevel edge, (see page 308)
- aluminum edge available, specify and add \$5,289 list

Rectangular Table with Rectangular Base	<b>CC8JRR2-48168</b>	48	168	29	12	2	3	567	32	\$17,952	\$27,888
---	----------------------	----	-----	----	----	---	---	-----	----	----------	----------

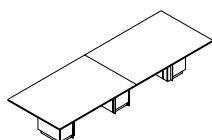

- short grain veneer direction
- base CC8NRC2-21132
- plinth base
- top is 1 1/4" thick and in two sections
- laminate worksurface, no charge if standard laminate is selected
- glass worksurface with reverse bevel edge, (see page 308)
- aluminum edge available, specify and add \$4,762 list

Rectangular Table with Rectangular Base	<b>CC8JRR2-48144</b>	48	144	29	8	2	3	525	30	\$16,587	\$25,104
---	----------------------	----	-----	----	---	---	---	-----	----	----------	----------

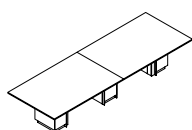

- short grain veneer direction
- base CC8NRC2-21108
- plinth base
- top is 1 1/4" thick and in two sections
- laminate worksurface, no charge if standard laminate is selected
- glass worksurface with reverse bevel edge, (see page 308)
- aluminum edge available, specify and add \$4,232 list

COLLECTIVE CONFERENCE

Description	① Model	D	L	H	Seat Capacity	Top Pieces	Bases Required	CTN WT	CU FT	Veneer	Glass Top
Rectangular Table with Rectangular Base	<b>CC8JRR2-48120</b>	48	120	29	6	2	2	393	22	\$10,815	\$17,488

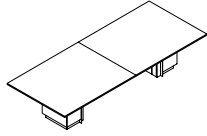

- short grain veneer direction
- base CC8NRC2-2184
- plinth base
- top is 1 1/4" thick and in two sections
- laminate worksurface, no charge if standard laminate is selected
- glass worksurface with reverse bevel edge, (see page 308)
- aluminum edge available, specify and add \$3,704 list

Rectangular Table with Rectangular Base	<b>CC8JRR2-4896</b>	48	96	29	6	1	2	355	20	\$9,286	\$14,624
---	---------------------	----	----	----	---	---	---	-----	----	---------	----------

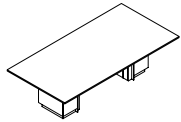

- long grain veneer direction
- base CC8NRC2-2160
- plinth base
- top is 1 1/4" thick
- laminate worksurface, no charge if standard laminate is selected
- glass worksurface with reverse bevel edge, (see page 308)
- aluminum edge available, specify and add \$3,176 list

COLLECTIVE CONFERENCE

**To Order, Specify:**

- ① Model Number
- ② Wood Species
- ③ Finish Scheme
  - A. Accent Surround - Veneer or Paint
  - B. Base Pedestal - Veneer or Paint  
(see page 312 - apron follows base pedestal)
- ④ Worksurface Option
  - A. Veneer
  - B. Laminate
  - C. Glossy Low Iron White Back Painted Glass
  - D. Frosted Low Iron White Back Painted Glass  
(see page 308)
- ⑤ Power and Data Options (see pages 519-535)
- ⑥ Other Product Options

Description	① Model	D	L	H	Seat Capacity	Top Pieces	Bases Required	CTN WT	CU FT	Veneer	Glass Top
-------------	---------	---	---	---	---------------	------------	----------------	--------	-------	--------	-----------

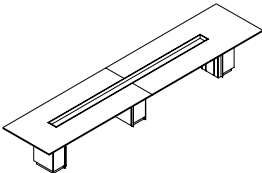
<b>Rectangular Table with Rectangular Base and Center Console</b> 	<b>CC8JRRM-48216</b>	48	216	29	18	2	3	654	43	\$32,068	\$44,841
---	----------------------	----	-----	----	----	---	---	-----	----	----------	----------

- short grain veneer direction
- base CC8NRC2-21174
- plinth base
- top is 1 1/4" thick and in two sections
- anodized aluminum center console 120" long
- laminate worksurface, no charge if standard laminate is selected
- glass worksurface with reverse bevel edge, (see page 308)
- aluminum edge available, specify and add \$5,818 list

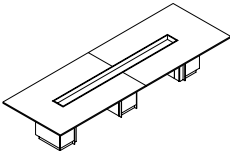
<b>Rectangular Table with Rectangular Base and Center Console</b> 	<b>CC8JRRM-48192</b>	48	192	29	16	2	3	612	40	\$25,203	\$36,558
---	----------------------	----	-----	----	----	---	---	-----	----	----------	----------

- short grain veneer direction
- base CC8NRC2-21156
- plinth base
- top is 1 1/4" thick and in two sections
- anodized aluminum center console 144" long
- laminate worksurface, no charge if standard laminate is selected
- glass worksurface with reverse bevel edge, (see page 308)
- aluminum edge available, specify and add \$5,289 list

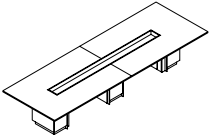
<b>Rectangular Table with Rectangular Base and Center Console</b> 	<b>CC8JRRM-48168</b>	48	168	29	14	2	3	568	37	\$22,554	\$32,490
---	----------------------	----	-----	----	----	---	---	-----	----	----------	----------

- short grain veneer direction
- base CC8NRC2-21132
- plinth base
- top is 1 1/4" thick and in two sections
- anodized aluminum center console 120" long
- laminate worksurface, no charge if standard laminate is selected
- glass worksurface with reverse bevel edge, (see page 308)
- aluminum edge available, specify and add \$4,762 list

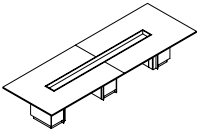
<b>Rectangular Table with Rectangular Base and Center Console</b> 	<b>CC8JRRM-48144</b>	48	144	29	10	2	3	525	34	\$20,326	\$28,841
---	----------------------	----	-----	----	----	---	---	-----	----	----------	----------

- short grain veneer direction
- base CC8NRC2-21108
- plinth base
- top is 1 1/4" thick and in two sections
- anodized aluminum center console 96" long
- laminate worksurface, no charge if standard laminate is selected
- glass worksurface with reverse bevel edge, (see page 308)
- aluminum edge available, specify and add \$4,232 list

COLLECTIVE CONFERENCE

Description	① Model	D	L	H	Seat Capacity	Top Pieces	Bases Required	CTN WT	CU FT	Veneer	Glass Top
-------------	---------	---	---	---	---------------	------------	----------------	--------	-------	--------	-----------

Rectangular Table with Rectangular Base and Center Console

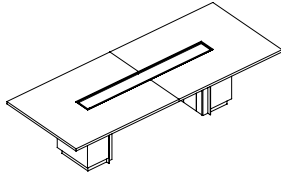

- short grain veneer direction
- base CC8NRC2-2184
- plinth base
- top is 1 1/4" thick and in two sections
- anodized aluminum center console 72" long
- laminate worksurface, no charge if standard laminate is selected
- glass worksurface with reverse bevel edge, (see page 308)
- aluminum edge available, specify and add \$3,704 list

Rectangular Table with Rectangular Base and Center Console

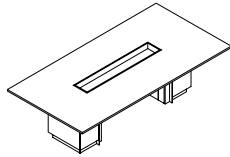

<b>CC8JRRM-48120</b>	48	120	29	6	2	2	394	26	\$13,691	\$20,364
----------------------	----	-----	----	---	---	---	-----	----	----------	----------

- long grain veneer direction
- base CC8NRC2-2160
- plinth base
- top is 1 1/4" thick
- anodized aluminum center console 48" long
- laminate worksurface, no charge if standard laminate is selected
- glass worksurface with reverse bevel edge, (see page 308)
- aluminum edge available, specify and add \$3,176 list

**To Order, Specify:**

- ① Model Number
- ② Wood Species
- ③ Finish Scheme
  - A. Accent Surround - Veneer or Paint
  - B. Base Pedestal - Veneer or Paint  
(see page 312 - apron follows base pedestal)
- ④ Worksurface Option
  - A. Veneer
  - B. Laminate
  - C. Glossy Low Iron White Back Painted Glass
  - D. Frosted Low Iron White Back Painted Glass  
(see page 308)
- ⑤ Power and Data Options (see pages 519-535)
- ⑥ Other Product Options
- ⑦ Center Console Accessories (see pages 390-391 - order separately)

Description	① Model	D	L	H	Seat Capacity	Top Pieces	Bases Required	CTN WT	CU FT	Veneer	Glass Top
-------------	---------	---	---	---	---------------	------------	----------------	--------	-------	--------	-----------

Arc End Table with Rectangular Base	<b>CC8JAR2-60216</b>	60	216	29	16	2	3	787	42	\$31,021	\$46,988
-------------------------------------	----------------------	----	-----	----	----	---	---	-----	----	----------	----------

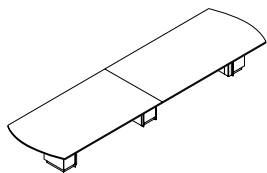

- short grain veneer direction
- base CC8NRC2-27174
- plinth base
- top is 1 1/4" thick and in two sections
- laminate worksurface, no charge if standard laminate is selected
- glass worksurface with reverse bevel edge, (see page 308)

Arc End Table with Rectangular Base	<b>CC8JAR2-60192</b>	60	192	29	14	2	3	737	39	\$24,139	\$38,332
-------------------------------------	----------------------	----	-----	----	----	---	---	-----	----	----------	----------

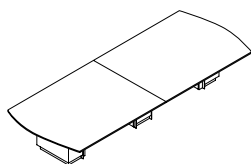

- short grain veneer direction
- base CC8NRC2-27156
- plinth base
- top is 1 1/4" thick and in two sections
- laminate worksurface, no charge if standard laminate is selected
- glass worksurface with reverse bevel edge, (see page 308)

Arc End Table with Rectangular Base	<b>CC8JAR2-60168</b>	60	168	29	12	2	3	683	36	\$21,850	\$36,558
-------------------------------------	----------------------	----	-----	----	----	---	---	-----	----	----------	----------

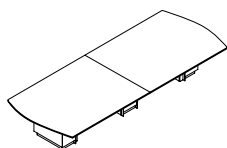

- short grain veneer direction
- base CC8NRC2-27132
- plinth base
- top is 1 1/4" thick and in two sections
- laminate worksurface, no charge if standard laminate is selected
- glass worksurface with reverse bevel edge, (see page 308)

Arc End Table with Rectangular Base	<b>CC8JAR2-60144</b>	60	144	29	10	2	3	632	33	\$20,004	\$30,649
-------------------------------------	----------------------	----	-----	----	----	---	---	-----	----	----------	----------

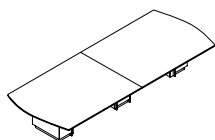

- short grain veneer direction
- base CC8NRC2-27108
- plinth base
- top is 1 1/4" thick and in two sections
- laminate worksurface, no charge if standard laminate is selected
- glass worksurface with reverse bevel edge, (see page 308)

COLLECTIVE CONFERENCE



Description	① Model	D	L	H	Seat Capacity	Top Pieces	Bases Required	CTN WT	CU FT	Veneer	Glass Top
-------------	---------	---	---	---	---------------	------------	----------------	--------	-------	--------	-----------

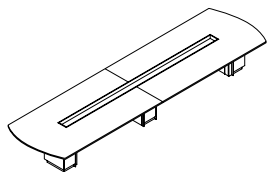

- short grain veneer direction
- base CC8NRC2-27174
- plinth base
- top is 1 1/4" thick and in two sections
- anodized aluminum center console 160" long
- laminate worksurface, no charge if standard laminate is selected
- glass worksurface with reverse bevel edge, (see page 308)

**Arc End Table with Rectangular Base and Center Console**

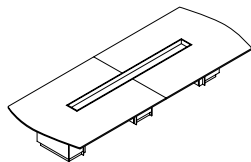

- |                      |    |     |    |    |   |   |     |    |          |          |
|----------------------|----|-----|----|----|---|---|-----|----|----------|----------|
| <b>CC8JARM-60192</b> | 60 | 192 | 29 | 14 | 2 | 3 | 737 | 46 | \$29,604 | \$43,798 |
|----------------------|----|-----|----|----|---|---|-----|----|----------|----------|
- short grain veneer direction
  - base CC8NRC2-27156
  - plinth base
  - top is 1 1/4" thick and in two sections
  - anodized aluminum center console 144" long
  - laminate worksurface, no charge if standard laminate is selected
  - glass worksurface with reverse bevel edge, (see page 308)

**Arc End Table with Rectangular Base and Center Console**

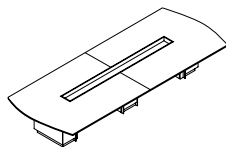

- |                      |    |     |    |    |   |   |     |    |          |          |
|----------------------|----|-----|----|----|---|---|-----|----|----------|----------|
| <b>CC8JARM-60168</b> | 60 | 168 | 29 | 12 | 2 | 3 | 684 | 42 | \$26,451 | \$38,870 |
|----------------------|----|-----|----|----|---|---|-----|----|----------|----------|
- short grain veneer direction
  - base CC8NRC2-27132
  - plinth base
  - top is 1 1/4" thick and in two sections
  - anodized aluminum center console 120" long
  - laminate worksurface, no charge if standard laminate is selected
  - glass worksurface with reverse bevel edge, (see page 308)

**Arc End Table with Rectangular Base and Center Console**

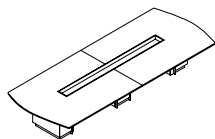

- |                      |    |     |    |    |   |   |     |    |          |          |
|----------------------|----|-----|----|----|---|---|-----|----|----------|----------|
| <b>CC8JARM-60144</b> | 60 | 144 | 29 | 10 | 2 | 3 | 632 | 39 | \$23,742 | \$34,387 |
|----------------------|----|-----|----|----|---|---|-----|----|----------|----------|
- short grain veneer direction
  - base CC8NRC2-27108
  - plinth base
  - top is 1 1/4" thick and in two sections
  - anodized aluminum center console 96" long
  - laminate worksurface, no charge if standard laminate is selected
  - glass worksurface with reverse bevel edge, (see page 308)

**To Order, Specify:**

**Arc End Table**

- ① Model Number
- ② Wood Species
- ③ Finish Scheme
  - A. Accent Surround - Veneer or Paint
  - B. Base Pedestal - Veneer or Paint  
(see page 312 - apron follows base pedestal)
- ④ Worksurface Option
  - A. Veneer
  - B. Laminate
  - C. Glossy Low Iron White Back Painted Glass
  - D. Frosted Low Iron White Back Painted Glass  
(see page 308)
- ⑤ Power and Data Options (see pages 519-535)
- ⑥ Other Product Options

**Arc End Table with Center Console**

- ① Model Number
- ② Wood Species
- ③ Finish Scheme
  - A. Accent Surround - Veneer or Paint
  - B. Base Pedestal - Veneer or Paint  
(see page 312 - apron follows base pedestal)
- ④ Worksurface Option
  - A. Veneer
  - B. Laminate
  - C. Glossy Low Iron White Back Painted Glass
  - D. Frosted Low Iron White Back Painted Glass  
(see page 308)
- ⑤ Power and Data Options (see pages 519-535)
- ⑥ Other Product Options
- ⑦ Center Console Accessories (see pages 390-391 - order separately)

COLLECTIVE CONFERENCE

Description	① Model	D	L	H	Seat Capacity	Top Pieces	Bases Required	CTN WT	CU FT	Veneer	Glass Top
-------------	---------	---	---	---	---------------	------------	----------------	--------	-------	--------	-----------

Arc End Table with Rectangular Base	<b>CC8JAR2-48216</b>	48	216	29	16	2	3	654	37	\$26,348	\$39,122
-------------------------------------	----------------------	----	-----	----	----	---	---	-----	----	----------	----------

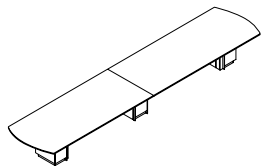

- short grain veneer direction
- base CC8NRC2-21174
- plinth base
- top is 1 1/4" thick and in two sections
- laminate worksurface, no charge if standard laminate is selected
- glass worksurface with reverse bevel edge, (see page 308)

Arc End Table with Rectangular Base	<b>CC8JAR2-48192</b>	48	192	29	14	2	3	612	35	\$20,267	\$31,621
-------------------------------------	----------------------	----	-----	----	----	---	---	-----	----	----------	----------

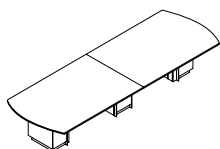

- short grain veneer direction
- base CC8NRC2-21156
- plinth base
- top is 1 1/4" thick and in two sections
- laminate worksurface, no charge if standard laminate is selected
- glass worksurface with reverse bevel edge, (see page 308)

Arc End Table with Rectangular Base	<b>CC8JAR2-48168</b>	48	168	29	12	2	3	567	32	\$18,406	\$28,343
-------------------------------------	----------------------	----	-----	----	----	---	---	-----	----	----------	----------

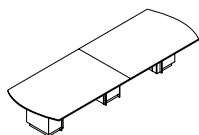

- short grain veneer direction
- base CC8NRC2-21132
- plinth base
- top is 1 1/4" thick and in two sections
- laminate worksurface, no charge if standard laminate is selected
- glass worksurface with reverse bevel edge, (see page 308)

Arc End Table with Rectangular Base	<b>CC8JAR2-48144</b>	48	144	29	10	2	3	525	30	\$16,964	\$26,924
-------------------------------------	----------------------	----	-----	----	----	---	---	-----	----	----------	----------

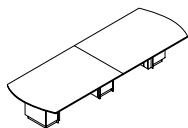

- short grain veneer direction
- base CC8NRC2-21108
- plinth base
- top is 1 1/4" thick and in two sections
- laminate worksurface, no charge if standard laminate is selected
- glass worksurface with reverse bevel edge, (see page 308)

COLLECTIVE CONFERENCE

Description	① Model	D	L	H	Seat Capacity	Top Pieces	Bases Required	CTN WT	CU FT	Veneer	Glass Top
Arc End Table with Rectangular Base	CC8JAR2-48120	48	120	29	6	2	2	393	22	\$11,121	\$17,794

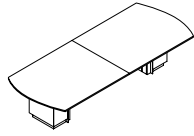

- short grain veneer direction
- base CC8NRC2-2184
- plinth base
- top is 1 1/4" thick and in two sections
- laminate worksurface, no charge if standard laminate is selected
- glass worksurface with reverse bevel edge, (see page 308)

Arc End Table with Rectangular Base	CC8JAR2-4896	48	96	29	6	1	2	355	20	\$9,511	\$14,849
-------------------------------------	--------------	----	----	----	---	---	---	-----	----	---------	----------

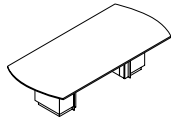

- long grain veneer direction
- base CC8NRC2-2160
- plinth base
- top is 1 1/4" thick
- laminate worksurface, no charge if standard laminate is selected
- glass worksurface with reverse bevel edge, (see page 308)

**To Order, Specify**

- ① Model Number
- ② Wood Species
- ③ Finish Scheme
  - A. Accent Surround - Veneer or Paint
  - B. Base Pedestal - Veneer or Paint  
(see page 312 - apron follows base pedestal)
- ④ Worksurface Option
  - A. Veneer
  - B. Laminate
  - C. Glossy Low Iron White Back Painted Glass
  - D. Frosted Low Iron White Back Painted Glass  
(see page 308)
- ⑤ Power and Data Options (see pages 519-535)
- ⑥ Other Product Options

Description	① Model	D	L	H	Seat Capacity	Top Pieces	Bases Required	CTN WT	CU FT	Veneer	Glass Top
-------------	---------	---	---	---	---------------	------------	----------------	--------	-------	--------	-----------

Arc End Table with Rectangular Base and Center Console	<b>CC8JARM-48216</b>	48	216	29	16	2	3	654	43	\$32,675	\$45,448
--	----------------------	----	-----	----	----	---	---	-----	----	----------	----------

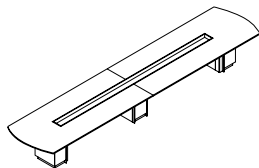

- short grain veneer direction
- base CC8NRC2-21174
- plinth base
- top is 1 1/4" thick and in two sections
- anodized aluminum center console 160" long
- laminate worksurface, no charge if standard laminate is selected
- glass worksurface with reverse bevel edge, (see page 308)

Arc End Table with Rectangular Base and Center Console	<b>CC8JARM-48192</b>	48	192	29	14	2	3	612	40	\$25,732	\$44,029
--	----------------------	----	-----	----	----	---	---	-----	----	----------	----------

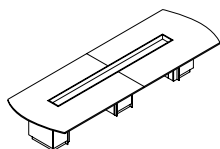

- short grain veneer direction
- base CC8NRC2-21156
- plinth base
- top is 1 1/4" thick and in two sections
- anodized aluminum center console 144" long
- laminate worksurface, no charge if standard laminate is selected
- glass worksurface with reverse bevel edge, (see page 308)

Arc End Table with Rectangular Base and Center Console	<b>CC8JARM-48168</b>	48	168	29	12	2	3	568	37	\$23,007	\$32,942
--	----------------------	----	-----	----	----	---	---	-----	----	----------	----------

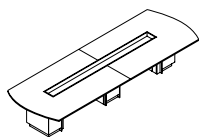

- short grain veneer direction
- base CC8NRC2-21132
- plinth base
- top is 1 1/4" thick and in two sections
- anodized aluminum center console 120" long
- laminate worksurface, no charge if standard laminate is selected
- glass worksurface with reverse bevel edge, (see page 308)

Arc End Table with Rectangular Base and Center Console	<b>CC8JARM-48144</b>	48	144	29	10	2	3	525	34	\$20,703	\$29,219
--	----------------------	----	-----	----	----	---	---	-----	----	----------	----------

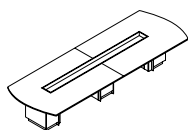

- short grain veneer direction
- base CC8NRC2-21108
- plinth base
- top is 1 1/4" thick and in two sections
- anodized aluminum center console 96" long
- laminate worksurface, no charge if standard laminate is selected
- glass worksurface with reverse bevel edge, (see page 308)

COLLECTIVE CONFERENCE

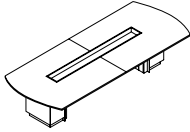
Description	① Model	D	L	H	Seat Capacity	Top Pieces	Bases Required	CTN WT	CU FT	Veneer	Glass Top
Arc End Table with Rectangular Base and Center Console 	<b>CC8JARM-48120</b>	48	120	29	6	2	2	394	26	\$13,997	\$20,670
	<ul style="list-style-type: none"> <li>· short grain veneer direction</li> <li>· base CC8NRC2-2184</li> <li>· plinth base</li> <li>· top is 1 1/4" thick and in two sections</li> <li>· anodized aluminum center console 72" long</li> <li>· laminate worksurface, no charge if standard laminate is selected</li> <li>· glass worksurface with reverse bevel edge, (see page 308)</li> </ul>										

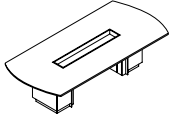
Arc End Table with Rectangular Base and Center Console 	<b>CC8JARM-4896</b>	48	96	29	6	1	2	355	23	\$11,523	\$16,862
	<ul style="list-style-type: none"> <li>· long grain veneer direction</li> <li>· base CC8NRC2-2160</li> <li>· plinth base</li> <li>· top is 1 1/4" thick</li> <li>· anodized aluminum center console 48" long</li> <li>· laminate worksurface, no charge if standard laminate is selected</li> <li>· glass worksurface with reverse bevel edge, (see page 308)</li> </ul>										

COLLECTIVE CONFERENCE

**To Order, Specify**

- ① Model Number
- ② Wood Species
- ③ Finish Scheme
  - A. Accent Surround - Veneer or Paint
  - B. Base Pedestal - Veneer or Paint  
(see page 312 - apron follows base pedestal)
- ④ Worksurface Option
  - A. Veneer
  - B. Laminate
  - C. Glossy Low Iron White Back Painted Glass
  - D. Frosted Low Iron White Back Painted Glass  
(see page 308)
- ⑤ Power and Data Options (see pages 519-535)
- ⑥ Other Product Options
- ⑦ Center Console Accessories (see pages 390-391 - order separately)

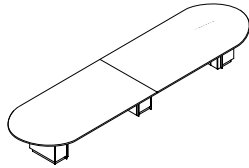
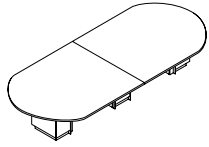
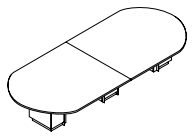
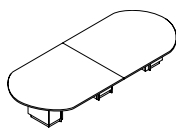
Description	① Model	D	L	H	Seat Capacity	Top Pieces	Bases Required	CTN WT	CU FT	Veneer	Glass Top
Racetrack Table with Rectangular Base 	<b>CC8JOR2-60216</b>	60	216	29	18	2	3	762	42	\$31,282	\$47,250
	<ul style="list-style-type: none"> <li>· short grain veneer direction</li> <li>· base CC8NRC2-27174</li> <li>· plinth base</li> <li>· top is 1 1/4" thick and in two sections</li> <li>· laminate worksurface, no charge if standard laminate is selected</li> <li>· glass worksurface with reverse bevel edge, (see page 308)</li> </ul>										
Racetrack Table with Rectangular Base 	<b>CC8JOR2-60192</b>	60	192	29	16	2	3	712	39	\$24,370	\$38,562
	<ul style="list-style-type: none"> <li>· short grain veneer direction</li> <li>· base CC8NRC2-27156</li> <li>· plinth base</li> <li>· top is 1 1/4" thick and in two sections</li> <li>· laminate worksurface, no charge if standard laminate is selected</li> <li>· glass worksurface with reverse bevel edge, (see page 308)</li> </ul>										
Racetrack Table with Rectangular Base 	<b>CC8JOR2-60168</b>	60	168	29	14	2	3	658	36	\$22,045	\$34,463
	<ul style="list-style-type: none"> <li>· short grain veneer direction</li> <li>· base CC8NRC2-27132</li> <li>· plinth base</li> <li>· top is 1 1/4" thick and in two sections</li> <li>· laminate worksurface, no charge if standard laminate is selected</li> <li>· glass worksurface with reverse bevel edge, (see page 308)</li> </ul>										
Racetrack Table with Rectangular Base 	<b>CC8JOR2-60144</b>	60	144	29	10	2	3	607	33	\$20,168	\$30,812
	<ul style="list-style-type: none"> <li>· short grain veneer direction</li> <li>· base CC8NRC2-27108</li> <li>· plinth base</li> <li>· top is 1 1/4" thick and in two sections</li> <li>· laminate worksurface, no charge if standard laminate is selected</li> <li>· glass worksurface with reverse bevel edge, (see page 308)</li> </ul>										

COLLECTIVE CONFERENCE

Description	① Model	D	L	H	Seat Capacity	Top Pieces	Bases Required	CTN WT	CU FT	Veneer	Glass Top
-------------	---------	---	---	---	---------------	------------	----------------	--------	-------	--------	-----------

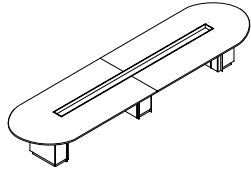

- short grain veneer direction
- base CC8NRC2-27174
- plinth base
- top is 1 1/4" thick and in two sections
- anodized aluminum center console 160" long
- laminate worksurface, no charge if standard laminate is selected
- glass worksurface with reverse bevel edge, (see page 308)

Racetrack Table with Rectangular Base and Center Console

<b>CC8JORM-60192</b>	60	192	29	16	2	3	712	46	\$29,832	\$44,025
----------------------	----	-----	----	----	---	---	-----	----	----------	----------

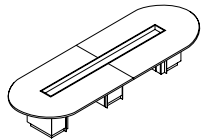

- short grain veneer direction
- base CC8NRC2-27156
- plinth base
- top is 1 1/4" thick and in two sections
- anodized aluminum center console 144" long
- laminate worksurface, no charge if standard laminate is selected
- glass worksurface with reverse bevel edge, (see page 308)

Racetrack Table with Rectangular Base and Center Console

<b>CC8JORM-60168</b>	60	168	29	14	2	3	659	42	\$26,646	\$39,065
----------------------	----	-----	----	----	---	---	-----	----	----------	----------

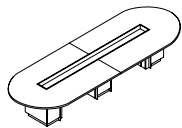

- short grain veneer direction
- base CC8NRC2-27132
- plinth base
- top is 1 1/4" thick and in two sections
- anodized aluminum center console 120" long
- laminate worksurface, no charge if standard laminate is selected
- glass worksurface with reverse bevel edge, (see page 308)

Racetrack Table with Rectangular Base and Center Console

<b>CC8JORM-60144</b>	60	144	29	10	2	3	607	39	\$23,908	\$34,551
----------------------	----	-----	----	----	---	---	-----	----	----------	----------

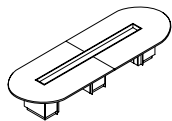

- short grain veneer direction
- base CC8NRC2-27108
- plinth base
- top is 1 1/4" thick and in two sections
- anodized aluminum center console 96" long
- laminate worksurface, no charge if standard laminate is selected
- glass worksurface with reverse bevel edge, (see page 308)

**To Order, Specify:**

**Racetrack Table**

- ① Model Number
- ② Wood Species
- ③ Finish Scheme
  - A. Accent Surround - Veneer or Paint
  - B. Base Pedestal - Veneer or Paint  
(see page 312 - apron follows base pedestal)
- ④ Worksurface Option
  - A. Veneer
  - B. Laminate
  - C. Glossy Low Iron White Back Painted Glass
  - D. Frosted Low Iron White Back Painted Glass  
(see page 308)
- ⑤ Power and Data Options (see pages 519-535)
- ⑥ Other Product Options

**Racetrack Table with Center Console**

- ① Model Number
- ② Wood Species
- ③ Finish Scheme
  - A. Accent Surround - Veneer or Paint
  - B. Base Pedestal - Veneer or Paint  
(see page 312 - apron follows base pedestal)
- ④ Worksurface Option
  - A. Veneer
  - B. Laminate
  - C. Glossy Low Iron White Back Painted Glass
  - D. Frosted Low Iron White Back Painted Glass  
(see page 308)
- ⑤ Power and Data Options (see pages 519-535)
- ⑥ Other Product Options
- ⑦ Center Console Accessories (see pages 390-391- order separately)

COLLECTIVE CONFERENCE

Description	① Model	D	L	H	Seat Capacity	Top Pieces	Bases Required	CTN WT	CU FT	Veneer	Glass Top
-------------	---------	---	---	---	---------------	------------	----------------	--------	-------	--------	-----------

Racetrack Table with Rectangular Base	<b>CC8JOR2-48216</b>	48	216	29	16	2	3	646	37	\$26,551	\$39,324
---------------------------------------	----------------------	----	-----	----	----	---	---	-----	----	----------	----------

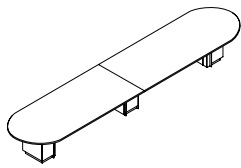

- short grain veneer direction
- base CC8NRC2-21174
- plinth base
- top is 1 1/4" thick and in two sections
- laminate worksurface, no charge if standard laminate is selected
- glass worksurface with reverse bevel edge, (see page 308)

Racetrack Table with Rectangular Base	<b>CC8JOR2-48192</b>	48	192	29	14	2	3	596	35	\$20,444	\$31,799
---------------------------------------	----------------------	----	-----	----	----	---	---	-----	----	----------	----------

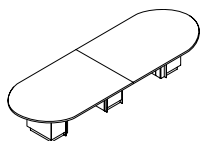

- short grain veneer direction
- base CC8NRC2-21156
- plinth base
- top is 1 1/4" thick and in two sections
- laminate worksurface, no charge if standard laminate is selected
- glass worksurface with reverse bevel edge, (see page 308)

Racetrack Table with Rectangular Base	<b>CC8JOR2-48168</b>	48	168	29	12	2	3	560	32	\$18,556	\$28,491
---------------------------------------	----------------------	----	-----	----	----	---	---	-----	----	----------	----------

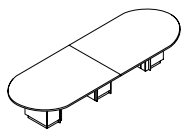

- short grain veneer direction
- base CC8NRC2-21132
- plinth base
- top is 1 1/4" thick and in two sections
- laminate worksurface, no charge if standard laminate is selected
- glass worksurface with reverse bevel edge, (see page 308)

Racetrack Table with Rectangular Base	<b>CC8JOR2-48144</b>	48	144	29	8	2	3	509	30	\$17,091	\$25,609
---------------------------------------	----------------------	----	-----	----	---	---	---	-----	----	----------	----------

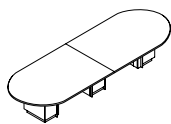

- short grain veneer direction
- base CC8NRC2-21108
- plinth base
- top is 1 1/4" thick and in two sections
- laminate worksurface, no charge if standard laminate is selected
- glass worksurface with reverse bevel edge, (see page 308)

COLLECTIVE CONFERENCE

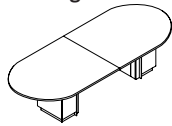

Description	① Model	D	L	H	Seat Capacity	Top Pieces	Bases Required	CTN WT	CU FT	Veneer	Glass Top
-------------	---------	---	---	---	---------------	------------	----------------	--------	-------	--------	-----------

<b>Racetrack Table with Rectangular Base</b> 	<b>CC8JOR2-48120</b>	48	120	29	6	2	2	377	22	\$11,223	\$17,895
	<ul style="list-style-type: none"> <li>· short grain veneer direction</li> <li>· base CC8NRC2-2184</li> <li>· plinth base</li> <li>· top is 1 1/4" thick and in two sections</li> <li>· laminate worksurface, no charge if standard laminate is selected</li> <li>· glass worksurface with reverse bevel edge, (see page 308)</li> </ul>										

<b>Racetrack Table with Rectangular Base</b> 	<b>CC8JOR2-4896</b>	48	96	29	6	1	2	330	20	\$9,585	\$14,925
	<ul style="list-style-type: none"> <li>· long grain veneer direction</li> <li>· base CC8NRC2-2160</li> <li>· plinth base</li> <li>· top is 1 1/4" thick</li> <li>· laminate worksurface, no charge if standard laminate is selected</li> <li>· glass worksurface with reverse bevel edge, (see page 308)</li> </ul>										

**To Order, Specify:**

- ① Model Number
- ② Wood Species
- ③ Finish Scheme
  - A. Accent Surround - Veneer or Paint
  - B. Base Pedestal - Veneer or Paint  
(see page 312 - apron follows base pedestal)
- ④ Worksurface Option
  - A. Veneer
  - B. Laminate
  - C. Glossy Low Iron White Back Painted Glass
  - D. Frosted Low Iron White Back Painted Glass  
(see page 308)
- ⑤ Power and Data Options (see pages 519-535)
- ⑥ Other Product Options

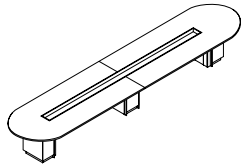
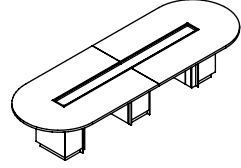
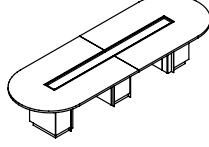
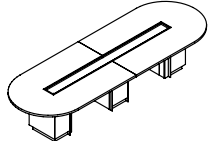
Description	① Model	D	L	H	Seat Capacity	Top Pieces	Bases Required	CTN WT	CU FT	Veneer	Glass Top
Racetrack Table with Rectangular Base and Center Console 	<b>CC8JORM-48216</b>	48	216	29	18	2	3	646	43	\$32,876	\$45,649
	<ul style="list-style-type: none"> <li>· short grain veneer direction</li> <li>· base CC8NRC2-21174</li> <li>· plinth base</li> <li>· top is 1 ¼" thick and in two sections</li> <li>· anodized aluminum center console 160" long</li> <li>· laminate worksurface, no charge if standard laminate is selected</li> <li>· glass worksurface with reverse bevel edge, (see page 308)</li> </ul>										
Racetrack Table with Rectangular Base and Center Console 	<b>CC8JORM-48192</b>	48	192	29	16	2	3	597	40	\$25,909	\$37,263
	<ul style="list-style-type: none"> <li>· short grain veneer direction</li> <li>· base CC8NRC2-21156</li> <li>· plinth base</li> <li>· top is 1 ¼" thick and in two sections</li> <li>· anodized aluminum center console 144" long</li> <li>· laminate worksurface, no charge if standard laminate is selected</li> <li>· glass worksurface with reverse bevel edge, (see page 308)</li> </ul>										
Racetrack Table with Rectangular Base and Center Console 	<b>CC8JORM-48168</b>	48	168	29	14	2	3	560	37	\$23,157	\$33,093
	<ul style="list-style-type: none"> <li>· short grain veneer direction</li> <li>· base CC8NRC2-21132</li> <li>· plinth base</li> <li>· top is 1 ¼" thick and in two sections</li> <li>· anodized aluminum center console 120" long</li> <li>· laminate worksurface, no charge if standard laminate is selected</li> <li>· glass worksurface with reverse bevel edge, (see page 308)</li> </ul>										
Racetrack Table with Rectangular Base and Center Console 	<b>CC8JORM-48144</b>	48	144	29	10	2	3	510	34	\$20,830	\$29,345
	<ul style="list-style-type: none"> <li>· short grain veneer direction</li> <li>· base CC8NRC2-21108</li> <li>· plinth base</li> <li>· top is 1 ¼" thick and in two sections</li> <li>· anodized aluminum center console 96" long</li> <li>· laminate worksurface, no charge if standard laminate is selected</li> <li>· glass worksurface with reverse bevel edge, (see page 308)</li> </ul>										

COLLECTIVE CONFERENCE

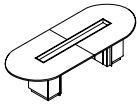
Description	① Model	D	L	H	Seat Capacity	Top Pieces	Bases Required	CTN WT	CU FT	Veneer	Glass Top
<b>Racetrack Table with Rectangular Base and Center Console</b> 	<b>CC8JORM-48120</b>	48	120	29	6	2	2	378	26	\$14,102	\$20,775
	<ul style="list-style-type: none"> <li>· short grain veneer direction</li> <li>· base CC8NRC2-2184</li> <li>· plinth base</li> <li>· top is 1 ¼" thick and in two sections</li> <li>· anodized aluminum center console 72" long</li> <li>· laminate worksurface, no charge if standard laminate is selected</li> <li>· glass worksurface with reverse bevel edge, (see page 308)</li> </ul>										

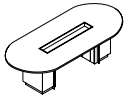
<b>Racetrack Table with Rectangular Base and Center Console</b> 	<b>CC8JORM-4896</b>	48	96	29	6	1	2	331	23	\$11,597	\$16,935
	<ul style="list-style-type: none"> <li>· long grain veneer direction</li> <li>· base CC8NRC2-2160</li> <li>· plinth base</li> <li>· top is 1 ¼" thick</li> <li>· anodized aluminum center console 48" long</li> <li>· laminate worksurface, no charge if standard laminate is selected</li> <li>· glass worksurface with reverse bevel edge, (see page 308)</li> </ul>										

COLLECTIVE CONFERENCE

**To Order, Specify:**

- ① Model Number
- ② Wood Species
- ③ Finish Scheme
  - A. Accent Surround - Veneer or Paint
  - B. Base Pedestal - Veneer or Paint  
(see page 312 - apron follows base pedestal)
- ④ Worksurface Option
  - A. Veneer
  - B. Laminate
  - C. Glossy Low Iron White Back Painted Glass
  - D. Frosted Low Iron White Back Painted Glass  
(see page 308)
- ⑤ Power and Data Options (see pages 519-535)
- ⑥ Other Product Options
- ⑦ Center Console Accessories (see pages 390-391 - order separately)

Description	① Model	D	L	H	Seat Capacity	Top Pieces	Bases Required	CTN WT	CU FT	Veneer	Glass Top
-------------	---------	---	---	---	---------------	------------	----------------	--------	-------	--------	-----------

Boat Shape Table with Rectangular Base	<b>CC8JBR2-60216</b>	60	216	29	16	2	3	710	42	\$30,310	\$45,105
--	----------------------	----	-----	----	----	---	---	-----	----	----------	----------

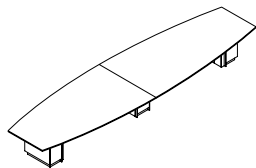

- short grain veneer direction
- base CC8NRC2-27174
- plinth base
- top is 1 1/4" thick and in two sections
- laminate worksurface, no charge if standard laminate is selected
- glass worksurface with reverse bevel edge, (see page 308)

Boat Shape Table with Rectangular Base	<b>CC8JBR2-60192</b>	60	192	29	14	2	3	668	39	\$23,243	\$37,435
--	----------------------	----	-----	----	----	---	---	-----	----	----------	----------

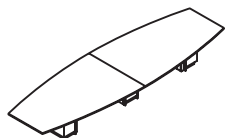

- short grain veneer direction
- base CC8NRC2-27156
- plinth base
- top is 1 1/4" thick and in two sections
- laminate worksurface, no charge if standard laminate is selected
- glass worksurface with reverse bevel edge, (see page 308)

Boat Shape Table with Rectangular Base	<b>CC8JBR2-60168</b>	60	168	29	12	2	3	623	36	\$21,447	\$33,866
--	----------------------	----	-----	----	----	---	---	-----	----	----------	----------

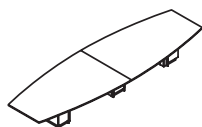

- short grain veneer direction
- base CC8NRC2-27132
- plinth base
- top is 1 1/4" thick and in two sections
- laminate worksurface, no charge if standard laminate is selected
- glass worksurface with reverse bevel edge, (see page 308)

COLLECTIVE CONFERENCE

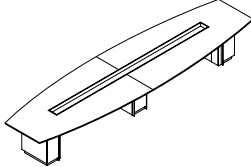
Description	① Model	D	L	H	Seat Capacity	Top Pieces	Bases Required	CTN WT	CU FT	Veneer	Glass Top
<b>Boat Shape Table with Rectangular Base and Center Console</b> 	<b>CC8JBRM-60216</b>	60	216	29	16	2	3	711	50	\$36,635	\$52,603
	<ul style="list-style-type: none"> <li>• short grain veneer direction</li> <li>• base CC8NRC2-27174</li> <li>• plinth base</li> <li>• top is 1 1/4" thick and in two sections</li> <li>• anodized aluminum center console 160" long</li> <li>• laminate worksurface, no charge if standard laminate is selected</li> <li>• glass worksurface with reverse bevel edge, (see page 308)</li> </ul>										

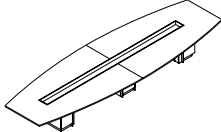
<b>Boat Shape Table with Rectangular Base and Center Console</b> 	<b>CC8JBRM-60192</b>	60	192	29	14	2	3	668	46	\$28,706	\$42,899
	<ul style="list-style-type: none"> <li>• short grain veneer direction</li> <li>• base CC8NRC2-27156</li> <li>• plinth base</li> <li>• top is 1 1/4" thick and in two sections</li> <li>• anodized aluminum center console 144" long</li> <li>• laminate worksurface, no charge if standard laminate is selected</li> <li>• glass worksurface with reverse bevel edge, (see page 308)</li> </ul>										

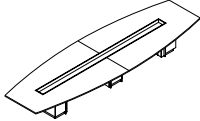
<b>Boat Shape Table with Rectangular Base and Center Console</b> 	<b>CC8JBRM-60168</b>	60	168	29	12	2	3	624	42	\$26,045	\$38,465
	<ul style="list-style-type: none"> <li>• short grain veneer direction</li> <li>• base CC8NRC2-27132</li> <li>• plinth base</li> <li>• top is 1 1/4" thick and in two sections</li> <li>• anodized aluminum center console 120" long</li> <li>• laminate worksurface, no charge if standard laminate is selected</li> <li>• glass worksurface with reverse bevel edge, (see page 308)</li> </ul>										

**To Order, Specify:**

**Boat Shape Table**

- ① Model Number
- ② Wood Species
- ③ Finish Scheme
  - A. Accent Surround - Veneer or Paint
  - B. Base Pedestal - Veneer or Paint  
(see page 312 - apron follows base pedestal)
- ④ Worksurface Option
  - A. Veneer
  - B. Laminate
  - C. Glossy Low Iron White Back Painted Glass
  - D. Frosted Low Iron White Back Painted Glass  
(see page 308)
- ⑤ Power and Data Options (see pages 519-535)
- ⑥ Other Product Options

**Boat Shape Table with Center Console**

- ① Model Number
- ② Wood Species
- ③ Finish Scheme
  - A. Accent Surround - Veneer or Paint
  - B. Base Pedestal - Veneer or Paint  
(see page 312 - apron follows base pedestal)
- ④ Worksurface Option
  - A. Veneer
  - B. Laminate
  - C. Glossy Low Iron White Back Painted Glass
  - D. Frosted Low Iron White Back Painted Glass  
(see page 308)
- ⑤ Power and Data Options (see pages 519-535)
- ⑥ Other Product Options
- ⑦ Center Console Accessories (see pages 390-391 - order separately)

Description	① Model	D	L	H	Seat Capacity	Top Pieces	Bases Required	CTN WT	CU FT	Veneer	Glass Top
-------------	---------	---	---	---	---------------	------------	----------------	--------	-------	--------	-----------

Boat Shape Table with Rectangular Base	<b>CC8JBR2-48144</b>	48	144	29	8	2	3	497	30	\$19,695	\$28,211
--	----------------------	----	-----	----	---	---	---	-----	----	----------	----------

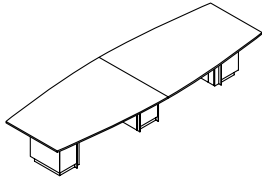

- short grain veneer direction
- base CC8NRC2-21108
- plinth base
- top is 1 1/4" thick and in two sections
- laminate worksurface, no charge if standard laminate is selected
- glass worksurface with reverse bevel edge, (see page 308)

Boat Shape Table with Rectangular Base	<b>CC8JBR2-48120</b>	48	120	29	6	2	2	370	22	\$12,479	\$19,153
--	----------------------	----	-----	----	---	---	---	-----	----	----------	----------

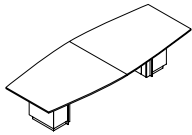

- short grain veneer direction
- base CC8NRC2-2184
- plinth base
- top is 1 1/4" thick and in two sections
- laminate worksurface, no charge if standard laminate is selected
- glass worksurface with reverse bevel edge, (see page 308)

Boat Shape Table with Rectangular Base	<b>CC8JBR2-4896</b>	48	96	29	6	1	2	336	20	\$10,526	\$15,865
--	---------------------	----	----	----	---	---	---	-----	----	----------	----------

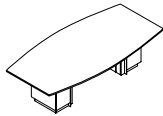

- long grain veneer direction
- base CC8NRC2-2160
- plinth base
- top is 1 1/4" thick
- laminate worksurface, no charge if standard laminate is selected
- glass worksurface with reverse bevel edge, (see page 308)

COLLECTIVE CONFERENCE

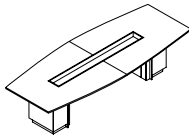
Description	① Model	D	L	H	Seat Capacity	Top Pieces	Bases Required	CTN WT	CU FT	Veneer	Glass Top
<b>Boat Shape Table with Rectangular Base and Center Console</b> 	<b>CC8JBRM-48144</b>	48	144	29	8	2	3	498	34	\$23,433	\$31,948
	<ul style="list-style-type: none"> <li>· short grain veneer direction</li> <li>· base CC8NRC2-21108</li> <li>· plinth base</li> <li>· top is 1 ¼" thick and in two sections</li> <li>· anodized aluminum center console 96" long</li> <li>· laminate worksurface, no charge if standard laminate is selected</li> <li>· glass worksurface with reverse bevel edge, (see page 308)</li> </ul>										

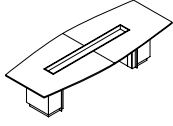
<b>Boat Shape Table with Rectangular Base and Center Console</b> 	<b>CC8JBRM-48120</b>	48	120	29	6	2	2	371	26	\$15,353	\$22,027
	<ul style="list-style-type: none"> <li>· short grain veneer direction</li> <li>· base CC8NRC2-2184</li> <li>· plinth base</li> <li>· top is 1 ¼" thick and in two sections</li> <li>· anodized aluminum center console 72" long</li> <li>· laminate worksurface, no charge if standard laminate is selected</li> <li>· glass worksurface with reverse bevel edge, (see page 308)</li> </ul>										

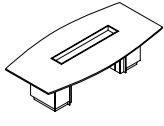
<b>Boat Shape Table with Rectangular Base and Center Console</b> 	<b>CC8JBRM-4896</b>	48	96	29	6	1	2	337	23	\$12,537	\$17,877
	<ul style="list-style-type: none"> <li>· long grain veneer direction</li> <li>· base CC8NRC2-2160</li> <li>· plinth base</li> <li>· top is 1 ¼" thick</li> <li>· anodized aluminum center console 48" long</li> <li>· laminate worksurface, no charge if standard laminate is selected</li> <li>· glass worksurface with reverse bevel edge, (see page 308)</li> </ul>										

COLLECTIVE CONFERENCE

**To Order, Specify:**

**Boat Shape Table**

- ① Model Number
- ② Wood Species
- ③ Finish Scheme
  - A. Accent Surround - Veneer or Paint
  - B. Base Pedestal - Veneer or Paint  
(see page 312 - apron follows base pedestal)
- ④ Worksurface Option
  - A. Veneer
  - B. Laminate
  - C. Glossy Low Iron White Back Painted Glass
  - D. Frosted Low Iron White Back Painted Glass  
(see page 308)
- ⑤ Power and Data Options (see pages 519-535)
- ⑥ Other Product Options

**Boat Shape Table with Center Console**

- ① Model Number
- ② Wood Species
- ③ Finish Scheme
  - A. Accent Surround - Veneer or Paint
  - B. Base Pedestal - Veneer or Paint  
(see page 312 - apron follows base pedestal)
- ④ Worksurface Option
  - A. Veneer
  - B. Laminate
  - C. Glossy Low Iron White Back Painted Glass
  - D. Frosted Low Iron White Back Painted Glass  
(see page 308)
- ⑤ Power and Data Options (see pages 519-535)
- ⑥ Other Product Options
- ⑦ Center Console Accessories (see pages 390-391 - order separately)

Description	① Model	D	L	H	Seat Capacity	Top Pieces	Bases Required	CTN WT	CU FT	Veneer	Glass Top
-------------	---------	---	---	---	---------------	------------	----------------	--------	-------	--------	-----------

View Table with Rectangular Base	<b>CC8JVR2-60168</b>	60	168	29	12	2	3	629	36	\$24,021	\$36,440
----------------------------------	----------------------	----	-----	----	----	---	---	-----	----	----------	----------

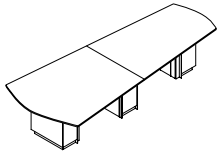

- short grain veneer direction
- base CC8NRC9-27168
- plinth base
- top is 1 1/4" thick and in two sections
- laminate worksurface, no charge if standard laminate is selected
- glass worksurface with reverse bevel edge, (see page 308)
- top size: 168"w x 40/60"d

View Table with Rectangular Base	<b>CC8JVR2-60144</b>	60	144	29	10	2	3	585	33	\$20,249	\$30,894
----------------------------------	----------------------	----	-----	----	----	---	---	-----	----	----------	----------

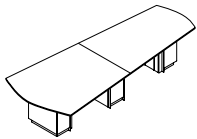

- short grain veneer direction
- base CC8NRC9-27144
- plinth base
- top is 1 1/4" thick and in two sections
- laminate worksurface, no charge if standard laminate is selected
- glass worksurface with reverse bevel edge, (see page 308)
- top size: 144"w x 40/60"d

View Table with Rectangular Base	<b>CC8JVR2-60120</b>	60	120	29	9	2	2	424	25	\$12,892	\$21,232
----------------------------------	----------------------	----	-----	----	---	---	---	-----	----	----------	----------

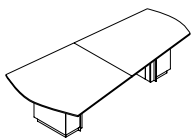

- short grain veneer direction
- base CC8NRC9-27120
- plinth base
- top is 1 1/4" thick and in two sections
- laminate worksurface, no charge if standard laminate is selected
- glass worksurface with reverse bevel edge, (see page 308)
- top size: 120"w x 40/60"d

View Table with Rectangular Base	<b>CC8JVR2-6096</b>	60	96	29	7	1	2	380	22	\$10,714	\$17,388
----------------------------------	---------------------	----	----	----	---	---	---	-----	----	----------	----------

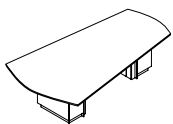

- long grain veneer direction
- base CC8NRC9-2796
- plinth base
- top is 1 1/4" thick
- laminate worksurface, no charge if standard laminate is selected
- glass worksurface with reverse bevel edge, (see page 308)
- top size: 96"w x 40/60"d

COLLECTIVE CONFERENCE

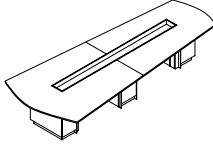

Description	① Model	D	L	H	Seat Capacity	Top Pieces	Bases Required	CTN WT	CU FT	Veneer	Glass Top
View Table with Rectangular Base and Center Console 	<b>CC8JVRM-60168</b>	60	168	29	11	2	3	630	42	\$28,623	\$41,041
<ul style="list-style-type: none"> <li>• short grain veneer direction</li> <li>• base CC8NRC9-27168</li> <li>• plinth base</li> <li>• top is 1 ¼" thick and in two sections</li> <li>• anodized aluminum center console 120" long</li> <li>• laminate worksurface, no charge if standard laminate is selected</li> <li>• glass worksurface with reverse bevel edge, (see page 308)</li> <li>• top size: 168"w x 40/60"d</li> </ul>											

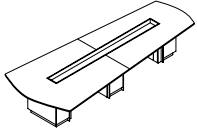
View Table with Rectangular Base and Center Console 	<b>CC8JVRM-60144</b>	60	144	29	11	2	3	585	39	\$23,988	\$34,633
<ul style="list-style-type: none"> <li>• short grain veneer direction</li> <li>• base CC8NRC9-27144</li> <li>• plinth base</li> <li>• top is 1 ¼" thick and in two sections</li> <li>• anodized aluminum center console 96" long</li> <li>• laminate worksurface, no charge if standard laminate is selected</li> <li>• glass worksurface with reverse bevel edge, (see page 308)</li> <li>• top size: 144"w x 40/60"d</li> </ul>											

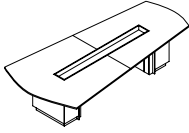
View Table with Rectangular Base and Center Console 	<b>CC8JVRM-60120</b>	60	120	29	9	2	2	424	30	\$15,765	\$24,107
<ul style="list-style-type: none"> <li>• short grain veneer direction</li> <li>• base CC8NRC9-27120</li> <li>• plinth base</li> <li>• top is 1 ¼" thick and in two sections</li> <li>• anodized aluminum center console 72" long</li> <li>• laminate worksurface, no charge if standard laminate is selected</li> <li>• glass worksurface with reverse bevel edge, (see page 308)</li> <li>• top size: 120"w x 40/60"d</li> </ul>											

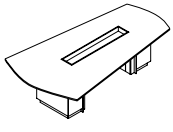
View Table with Rectangular Base and Center Console 	<b>CC8JVRM-6096</b>	60	96	29	7	1	2	380	26	\$12,729	\$19,402
<ul style="list-style-type: none"> <li>• long grain veneer direction</li> <li>• base CC8NRC9-2796</li> <li>• plinth base</li> <li>• top is 1 ¼" thick</li> <li>• anodized aluminum center console 48" long</li> <li>• laminate worksurface, no charge if standard laminate is selected</li> <li>• glass worksurface with reverse bevel edge, (see page 308)</li> <li>• top size: 96"w x 40/60"d</li> </ul>											

**To Order, Specify:**

**View Table**

- ① Model Number
- ② Wood Species
- ③ Finish Scheme
  - A. Accent Surround - Veneer or Paint
  - B. Base Pedestal - Veneer or Paint  
(see page 312 - apron follows base pedestal)
- ④ Worksurface Option
  - A. Veneer
  - B. Laminate
  - C. Glossy Low Iron White Back Painted Glass
  - D. Frosted Low Iron White Back Painted Glass  
(see page 308)
- ⑤ Power and Data Options (see pages 519-535)
- ⑥ Other Product Options

**View Table with Center Console**

- ① Model Number
- ② Wood Species
- ③ Finish Scheme
  - A. Accent Surround - Veneer or Paint
  - B. Base Pedestal - Veneer or Paint  
(see page 312 - apron follows base pedestal)
- ④ Worksurface Option
  - A. Veneer
  - B. Laminate
  - C. Glossy Low Iron White Back Painted Glass
  - D. Frosted Low Iron White Back Painted Glass  
(see page 308)
- ⑤ Power and Data Options (see pages 519-535)
- ⑥ Other Product Options
- ⑦ Center Console Accessories (see pages 390-391 - order separately)

Meeting Tables

Description	① Model	D	L	H	Seat Capacity	Top Pieces	Bases Required	CTN WT	CU FT	List Price
Solid Glass Meeting Table with Column/Disc Base	CC8JDDG-0048	48	48	29	3 to 4	1	1	175	20	\$7,588
	CC8JDDG-0042	42	42	29	3 to 4	1	1	154	19	\$6,903
	CC8JDDG-0036	36	36	29	3 to 4	1	1	136	18	\$6,270

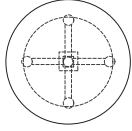

- top is solid 1/2" tempered frosted glass underside, see page 313 for additional information
- 26" dia. disk base is Arctic Silver powder coated aluminum with veneer column

Veneer Meeting Table with Column/Disc Base	CC8JDD1-0048	48	48	29	3 to 4	1	1	150	5	\$6,375
	CC8JDD1-0042	42	42	29	3 to 4	1	1	135	4	\$5,768
	CC8JDD1-0036	36	36	29	3 to 4	1	1	122	3	\$5,140
	CC8JDD1-0030	30	30	29	3 to 4	1	1	110	3	\$4,631

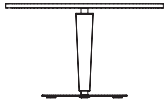

- 26" dia. disk base is Arctic Silver powder coated aluminum with veneer column
- laminate worksurface, no charge if standard laminate is selected
- see page 313 for additional information

Meeting Tables

Description	① Model	D	L	H	Seat Capacity	Top Pieces	Bases Required	CTN WT	CU FT	List Price
Veneer Meeting Table with Cylinder Base	CC8JDC1-0048	48	48	29	4	1	1	141	17	\$4,526
	CC8JDC1-0042	42	42	29	4	1	1	126	16	\$4,244

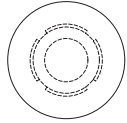
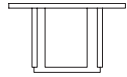

- 24" dia. base has 4 accent panels
- laminate worksurface, no charge if standard laminate is selected
- drum style construction
- see page 313 for additional information

COLLECTIVE CONFERENCE

To Order, Specify:

Round Table with Column/Disc Base

- ① Model Number
- ② Wood Species
- ③ Finish Color

Round Table with Cylinder Disc

- ① Model Number
- ② Wood Species
- ③ Finish Scheme
  - A. Cylinder Base - Veneer or Paint
  - B. Accent Panel - Veneer or Paint
 (see page 313 - apron follows base pedestal)

Description	① Model	W	L	H	Seat Capacity	Top Pieces	CTN WT	CU FT	Veneer	Glass Top
Rectangular Top 	<b>CC8CTR1-60216</b>	60	216	1 ¼	18	2	460	25	\$13,425	\$29,393
	<b>CC8CTR1-60192</b>	60	192	1 ¼	16	2	409	23	\$11,689	\$25,881
	<b>CC8CTR1-60168</b>	60	168	1 ¼	14	2	358	20	\$10,002	\$22,420
	<b>CC8CTR1-60144</b>	60	144	1 ¼	10	2	308	17	\$8,377	\$19,021

- short grain veneer direction
- top is 1 ¼" thick and in two sections
- laminate worksurface, no charge if standard laminate is selected
- glass worksurface with reverse bevel edge, (see page 308)
- aluminum edge available, specify and add \$6,080 list for CC8CTR1-60216, \$5,554 list for CC8CTR1-60192, \$5,027 list for CC8CTR1-60168 and \$4,496 list for CC8CTR1-60144

Rectangular Top 	<b>CC8CTR1-48216</b>	48	216	1 ¼	16	2	370	21	\$10,331	\$23,106
	<b>CC8CTR1-48192</b>	48	192	1 ¼	14	2	330	18	\$8,984	\$20,338
	<b>CC8CTR1-48168</b>	48	168	1 ¼	13	2	289	16	\$7,702	\$17,636
	<b>CC8CTR1-48144</b>	48	144	1 ¼	8	2	248	14	\$6,454	\$14,970
	<b>CC8CTR1-48120</b>	48	120	1 ¼	6	2	207	11	\$5,243	\$11,916

- short grain veneer direction
- top is 1 ¼" thick and in two sections
- laminate worksurface, no charge if standard laminate is selected
- glass worksurface with reverse bevel edge, (see page 308)
- aluminum edge available, specify and add \$5,818 list for CC8CTR1-48216, \$5,289 list for CC8CTR1-48192, \$4,762 list for CC8CTR1-48168, \$4,232 list for CC8CTR1-48144 and \$3,704 list for CC8CTR1-48120

Rectangular Top 	<b>CC8CTR1-4896</b>	48	96	1 ¼	6	1	160	9	\$3,838	\$9,178
---	---------------------	----	----	-----	---	---	-----	---	---------	---------

- long grain veneer direction
- top is 1 ¼" thick
- laminate worksurface, no charge if standard laminate is selected
- glass worksurface with reverse bevel edge, (see page 308)
- aluminum edge available, specify and add \$3,176 list for CC8CTR1-4896

Rectangular Top 	<b>CC8CTR1-4284</b>	42	84	1 ¼	4	1	123	7	\$2,790	\$6,878
	<b>CC8CTR1-3672</b>	36	72	1 ¼	4	1	91	5	\$2,057	\$5,059

- long grain veneer direction
- top is 1 ¼" thick
- laminate worksurface, no charge if standard laminate is selected
- glass worksurface with reverse bevel edge, (see page 308)
- aluminum edge available, specify and add \$2,779 list for CC8CTR1-4284 and \$2,383 list for CC8CTR1-3672

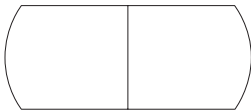
Description	① Model	W	L	H	Seat Capacity	Top Pieces	CTN WT	CU FT	Veneer	Glass Top
<b>Arc End Top</b> 	<b>CC8CTA1-60216</b>	60	216	1 ¼	16	2	460	25	\$14,213	\$30,181
	<b>CC8CTA1-60192</b>	60	192	1 ¼	14	2	409	23	\$12,374	\$26,569
	<b>CC8CTA1-60168</b>	60	168	1 ¼	12	2	358	20	\$10,590	\$23,009
	<b>CC8CTA1-60144</b>	60	144	1 ¼	10	2	308	17	\$8,865	\$19,510

- short grain veneer direction
- top is 1 ¼" thick and in two sections
- laminate worksurface, no charge if standard laminate is selected
- glass worksurface with reverse bevel edge, (see page 308)

<b>Arc End Top</b> 	<b>CC8CTA1-48216</b>	48	216	1 ¼	16	2	370	21	\$10,908	\$23,683
	<b>CC8CTA1-48192</b>	48	192	1 ¼	14	2	330	18	\$9,512	\$20,866
	<b>CC8CTA1-48168</b>	48	168	1 ¼	12	2	289	16	\$8,154	\$18,088
	<b>CC8CTA1-48144</b>	48	144	1 ¼	8	2	248	14	\$6,834	\$15,350
	<b>CC8CTA1-48120</b>	48	120	1 ¼	6	2	207	11	\$5,548	\$12,222

- short grain veneer direction
- top is 1 ¼" thick and in two sections
- laminate worksurface, no charge if standard laminate is selected
- glass worksurface with reverse bevel edge, (see page 308)

<b>Arc End Top</b> 	<b>CC8CTA1-4896</b>	48	96	1 ¼	6	1	160	9	\$4,061	\$9,399
--	---------------------	----	----	-----	---	---	-----	---	---------	---------

- long grain veneer direction
- top is 1 ¼" thick
- laminate worksurface, no charge if standard laminate is selected
- glass worksurface with reverse bevel edge, (see page 308)

<b>Arc End Top</b> 	<b>CC8CTA1-4284</b>	42	84	1 ¼	4	1	123	7	\$2,951	\$7,041
	<b>CC8CTA1-3672</b>	36	72	1 ¼	6	1	91	5	\$2,172	\$5,176

- long grain veneer direction
- top is 1 ¼" thick
- laminate worksurface, no charge if standard laminate is selected
- glass worksurface with reverse bevel edge, (see page 308)

**To Order, Specify:**

**Rectangular Top**

- ① Model Number
- ② Wood Species
- ③ Finish Color
- ④ Edge Detail
  - A. Straight
  - B. Aluminum Trim
- ⑤ Worksurface Option
  - A. Veneer
  - B. Laminate
  - C. Glossy Low Iron White Back Painted Glass
  - D. Frosted Low Iron White Back Painted Glass (see page 308)
- ⑥ Power and Data Options (see pages 519-535)
- ⑦ Other Product Options

**Arc Top**

- ① Model Number
- ② Wood Species
- ③ Finish Color
- ④ Worksurface Option
  - A. Veneer
  - B. Laminate
  - C. Glossy Low Iron White Back Painted Glass
  - D. Frosted Low Iron White Back Painted Glass (see page 308)
- ⑤ Power and Data Options (see pages 519-535)
- ⑥ Other Product Options

Description	① Model	W	L	H	Seat Capacity	Top Pieces	CTN WT	CU FT	Veneer	Glass Top
	<b>CC8CT01-60216</b>	60	216	1 ¼	18	2	435	25	\$14,479	\$30,446
	<b>CC8CT01-60192</b>	60	192	1 ¼	16	2	384	23	\$12,604	\$26,796
	<b>CC8CT01-60168</b>	60	168	1 ¼	14	2	333	20	\$10,787	\$23,205
	<b>CC8CT01-60144</b>	60	144	1 ¼	10	2	283	17	\$9,029	\$19,673

- short grain veneer direction
- top is 1 ¼" thick and in two sections
- laminate worksurface, no charge if standard laminate is selected
- glass worksurface with reverse bevel edge, (see page 308)

Description	① Model	W	L	H	Seat Capacity	Top Pieces	CTN WT	CU FT	Veneer	Glass Top
	<b>CC8CT01-48216</b>	48	216	1 ¼	16	2	363	21	\$11,111	\$23,885
	<b>CC8CT01-48192</b>	48	192	1 ¼	14	2	314	18	\$9,686	\$21,041
	<b>CC8CT01-48168</b>	48	168	1 ¼	12	2	281	16	\$8,305	\$18,240
	<b>CC8CT01-48144</b>	48	144	1 ¼	8	2	232	14	\$6,957	\$15,474
	<b>CC8CT01-48120</b>	48	120	1 ¼	6	2	191	11	\$5,652	\$12,326

- short grain veneer direction
- top is 1 ¼" thick and in two sections
- laminate worksurface, no charge if standard laminate is selected
- glass worksurface with reverse bevel edge, (see page 308)

Description	① Model	W	L	H	Seat Capacity	Top Pieces	CTN WT	CU FT	Veneer	Glass Top
	<b>CC8CT01-4896</b>	48	96	1 ¼	6	1	135	9	\$4,132	\$9,471

- long grain veneer direction
- top is 1 ¼" thick
- laminate worksurface, no charge if standard laminate is selected
- glass worksurface with reverse bevel edge, (see page 308)

Description	① Model	W	L	H	Seat Capacity	Top Pieces	CTN WT	CU FT	Veneer	Glass Top
	<b>CC8CT01-4284</b>	42	84	1 ¼	4	1	110	7	\$3,004	\$7,091
	<b>CC8CT01-3672</b>	36	72	1 ¼	4	1	82	5	\$2,212	\$5,214

- long grain veneer direction
- top is 1 ¼" thick
- laminate worksurface, no charge if standard laminate is selected
- glass worksurface with reverse bevel edge, (see page 308)

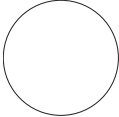
Description	① Model	W	L	H	Seat Capacity	Top Pieces	CTN WT	CU FT	Veneer	Glass Top
	<b>CC8CTD1-0048</b>	48	48	1 ¼	4	1	81	5	\$3,842	\$6,511
	<b>CC8CTD1-0042</b>	42	42	1 ¼	4	1	62	4	\$3,532	\$5,575

- short grain veneer direction
- top is 1 ¼" thick
- laminate worksurface, no charge if standard laminate is selected
- glass worksurface with reverse bevel edge, (see page 308)

COLLECTIVE CONFERENCE

Description	① Model	W	L	H	Seat Capacity	Top Pieces	CTN WT	CU FT	Veneer	Glass Top
<b>Boat Shape Top</b> 	<b>CC8CTB1-60216</b>	38/60	216	1 ¼	18	2	460	25	\$13,461	\$29,430
	<b>CC8CTB1-60192</b>	38/60	192	1 ¼	16	2	409	23	\$11,815	\$26,008
	<b>CC8CTB1-60168</b>	36/60	168	1 ¼	14	2	358	20	\$10,124	\$22,543

- short grain veneer direction
- top is 1 ¼" thick and in two sections
- laminate worksurface, no charge if standard laminate is selected
- glass worksurface with reverse bevel edge, (see page 308)

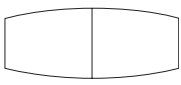
<b>Boat Shape Top</b> 	<b>CC8CTB1-48144</b>	36/48	144	1 ¼	8	2	248	14	\$8,495	\$17,012
	<b>CC8CTB1-48120</b>	36/48	120	1 ¼	6	2	207	11	\$6,907	\$13,579

- short grain veneer direction
- top is 1 ¼" thick and in two sections
- laminate worksurface, no charge if standard laminate is selected
- glass worksurface with reverse bevel edge, (see page 308)

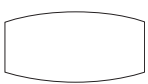
<b>Boat Shape Top</b> 	<b>CC8CTB1-4896</b>	34/48	96	1 ¼	6	1	160	9	\$5,075	\$10,413
--	---------------------	-------	----	-----	---	---	-----	---	---------	----------

- long grain veneer direction
- top is 1 ¼" thick
- laminate worksurface, no charge if standard laminate is selected
- glass worksurface with reverse bevel edge, (see page 308)

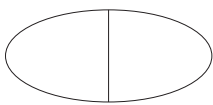
<b>Ellipse Shape Top</b> 	<b>CC8CTE1-60144</b>	60	144	1 ¼	10	2	238	17	\$12,052	\$22,696
	<b>CC8CTE1-54120</b>	54	120	1 ¼	8	2	181	13	\$7,744	\$15,356

- short grain veneer direction
- top is 1 ¼" thick and in two sections
- laminate worksurface, no charge if standard laminate is selected
- glass worksurface with reverse bevel edge, (see page 308)

<b>Ellipse Shape Top</b> 	<b>CC8CTE1-4896</b>	48	96	1 ¼	6	2	123	9	\$5,713	\$11,053
---	---------------------	----	----	-----	---	---	-----	---	---------	----------

- long grain veneer direction
- top is 1 ¼" thick
- laminate worksurface, no charge if standard laminate is selected
- glass worksurface with reverse bevel edge, (see page 308)

**To Order, Specify:**

- ① Model Number
- ② Wood Species
- ③ Finish Color
- ④ Worksurface Option
  - A. Veneer
  - B. Laminate
  - C. Glossy Low Iron White Back Painted Glass
  - D. Frosted Low Iron White Back Painted Glass (see page 308)
- ⑤ Power and Data Options (see pages 519-535)
- ⑥ Other Product Options

Description	D	W	H	CTN WT	CU FT	① Model	List Price
Open Cable Base	3½	27	27⅞	67	3	CC8NCO1-0427	\$3,839
	3½	23	27⅞	57	57	CC8NCO1-0423	\$3,414

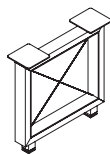

- X-shaped stainless steel cable accent
- wood surround
- Silver powder coated inner metal frame
- telescopic feet are anodized aluminum
- not for use with 60"d tops

Closed Cable Base	5	27	27⅞	77	4	CC8NCC1-0527	\$4,544
	5	23	27⅞	67	3	CC8NCC1-0523	\$4,237

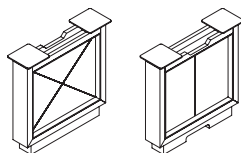

side 1      side 2

- X-shaped stainless steel cable accent
- wood surround
- Silver powder coated inner metal frame
- wood panel one side; hinged doors with 3" opening on top for wire management and touch latch
- not for use with 60"d tops

Closed Cable Middle Base	5	27	15¾	86	4	CC8NCM1-0527	\$3,375
--------------------------	---	----	-----	----	---	--------------	---------

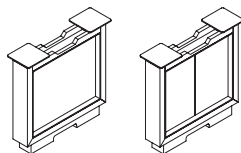

side 1      side 2

- wood surround
- Silver powder coated inner metal frame
- wood panel one side; hinged doors with 3" opening on top for wire management and touch latch
- plinth base with cut-out in bottom 2" x 6"
- not for use with 60"d tops

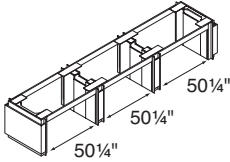
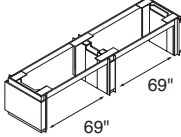
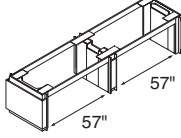
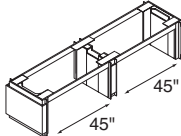

Description	D	W	H	CTN WT	CU FT	① Model	List Price
<b>32" Panel Base with Apron Rails and Center Bases</b> 	32 1/4	174	27 3/4	398	20	<b>CC8NPC2-32174</b>	<b>\$14,410</b>
<ul style="list-style-type: none"> <li>use with 216" x 60" table top</li> <li>anodized aluminum trim</li> <li>hinged doors one side with touch latch; outside bases have 3" opening on top of hinged door side for wire management; middle bases have 3" opening on top both sides for wire management</li> <li>adjustable glides</li> <li>arc or flat panel front - add \$594 for arc end panel front, arc only on outside panels</li> </ul>							
<b>32" Panel Base with Apron Rails and Center Base</b> 	32 1/4	156	27 3/4	301	15	<b>CC8NPC2-32156</b>	<b>\$9,784</b>
<ul style="list-style-type: none"> <li>use with 192" x 60" table top</li> <li>anodized aluminum trim</li> <li>hinged doors one side with touch latch; outside bases have 3" opening on top of hinged door side for wire management; middle bases have 3" opening on top both sides for wire management</li> <li>adjustable glides</li> <li>arc or flat panel front - add \$594 for arc end panel front, arc only on outside panels</li> </ul>							
<b>32" Panel Base with Apron Rails and Center Base</b> 	32 1/4	132	27 3/4	298	15	<b>CC8NPC2-32132</b>	<b>\$9,494</b>
<ul style="list-style-type: none"> <li>use with 168" x 60" table top</li> <li>anodized aluminum trim</li> <li>hinged doors one side with touch latch; outside bases have 3" opening on top of hinged door side for wire management; middle bases have 3" opening on top both sides for wire management</li> <li>adjustable glides</li> <li>arc or flat panel front - add \$594 for arc end panel front, arc only on outside panels</li> </ul>							
<b>32" Panel Base with Apron Rails and Center Base</b> 	32 1/4	108	27 3/4	295	15	<b>CC8NPC2-32108</b>	<b>\$9,053</b>
<ul style="list-style-type: none"> <li>use with 144" x 60" table top</li> <li>anodized aluminum trim</li> <li>hinged doors one side with touch latch; outside bases have 3" opening on top of hinged door side for wire management; middle bases have 3" opening on top both sides for wire management</li> <li>adjustable glides</li> <li>arc or flat panel front - add \$594 for arc end panel front, arc only on outside panels</li> </ul>							

**To Order, Specify:**

**Open Cable Base**

- ① Model Number
- ② Wood Species
- ③ Finish Color
- ④ Other Product Options

**Closed Cable Base**

- ① Model Number
- ② Wood Species
- ③ Finish Scheme
  - A. Outer Frame & Plinth - Veneer only
  - B. Inner Panel/Door - Veneer or Paint
 (see page 311)
- ④ Other Product Options

**Panel Base with Apron Rails and Center Bases**

- ① Model Number
- ② Wood Species
- ③ Base Front Panel
  - A. Arc
  - B. Flat
 (see page 310)
- ④ Finish Scheme
  - A. Outer Frame & Plinth - Veneer only
  - B. Inner Panel/Door - Veneer or Paint
 (see page 312)
- ④ Other Product Options

Description	D	W	H	CTN WT	CU FT	① Model	List Price
-------------	---	---	---	--------	-------	---------	------------

27" Panel Base with Apron Rails and Center Bases

27 1/4	174	27 3/4	365	16	CC8NPC2-27174	\$8,942
--------	-----	--------	-----	----	---------------	---------

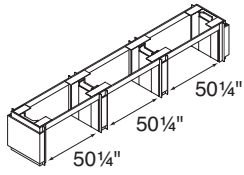

- use with 216" x 48" table top
- anodized aluminum trim
- hinged doors one side with touch latch; outside bases have 3" opening on top of hinged door side for wire management; middle bases have 3" opening on top both sides for wire management
- adjustable glides
- arc or flat panel front - add \$594 for arc end panel front, arc only on outside panels

27" Panel Base with Apron Rails and Center Base

27 1/4	156	27 3/4	279	12	CC8NPC2-27156	\$9,022
--------	-----	--------	-----	----	---------------	---------

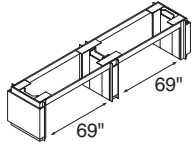

- use with 192" x 48" table top
- anodized aluminum trim
- hinged doors one side with touch latch; outside bases have 3" opening on top of hinged door side for wire management; middle base has 3" opening on top both sides for wire management
- adjustable glides
- arc or flat panel front - add \$594 for arc end panel front, arc only on outside panels

27" Panel Base with Apron Rails and Center Base

27 1/4	132	27 3/4	276	12	CC8NPC2-27132	\$8,674
--------	-----	--------	-----	----	---------------	---------

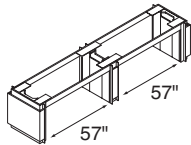

- use with 168" x 48" table top
- anodized aluminum trim
- hinged doors one side with touch latch; outside bases have 3" opening on top of hinged door side for wire management; middle base has 3" opening on top both sides for wire management
- adjustable glides
- arc or flat panel front - add \$594 for arc end panel front, arc only on outside panels

27" Panel Base with Apron Rails and Center Base

27 1/4	108	27 3/4	274	12	CC8NPC2-27108	\$8,539
--------	-----	--------	-----	----	---------------	---------

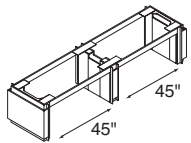

- use with 144" x 48" table top
- anodized aluminum trim
- hinged doors one side with touch latch; outside bases have 3" opening on top of hinged door side for wire management; middle base has 3" opening on top both sides for wire management
- adjustable glides
- arc or flat panel front - add \$594 for arc end panel front, arc only on outside panels

COLLECTIVE CONFERENCE

Description	D	W	H	CTN WT	CU FT	① Model	List Price
27" Panel Base with Apron Rails	27 1/4	84	27 3/4	187	8	CC8NPC2-2784	\$4,541

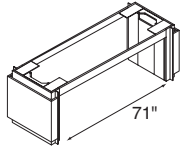

- use with 120" x 48" table top
- anodized aluminum trim
- hinged doors one side with touch latch; 3" opening on top of hinged door side for wire management
- adjustable glides
- arc or flat panel front - add \$594 for arc end panel front, arc only on outside panels

27" Panel Base with Apron Rails	27 1/4	60	27 3/4	184	8	CC8NPC2-2760	\$4,404
---------------------------------	--------	----	--------	-----	---	--------------	---------

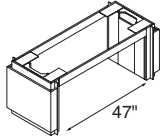

- use with 96" x 48" table top
- anodized aluminum trim
- hinged doors one side with touch latch; 3" opening on top of hinged door side for wire management
- adjustable glides
- arc or flat panel front - add \$594 for arc end panel front, arc only on outside panels

**To Order, Specify:**

- ① Model Number
- ② Wood Species
- ③ Base Front Panel
  - A. Arc
  - B. Flat
  - (see page 310)
- ④ Finish Scheme
  - A. Outer Frame & Plinth - veneer only
  - B. Inner Panel/Door - Veneer or Paint
  - (see page 312)
- ④ Other Product Options

Description	D	W	H	CTN WT	CU FT	① Model	List Price
-------------	---	---	---	--------	-------	---------	------------

27" Rectangular Base with Apron Rails and Center Base

27 ¼"	174	27 ¾"	354	15	CC8NRC2-27174	\$12,685
-------	-----	-------	-----	----	---------------	----------

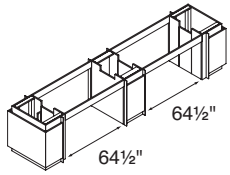

- use with 216" x 60" table top
- anodized aluminum trim
- hinged doors one side with touch latch; outside bases have 3" opening on top of hinged door side for wire management; middle base has 3" opening on top both sides for wire management
- adjustable glides

27" Rectangular Base with Apron Rails and Center Base

27 ¼"	156	27 ¾"	352	15	CC8NRC2-27156	\$9,684
-------	-----	-------	-----	----	---------------	---------

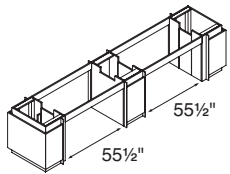

- use with 192" x 60" table top
- anodized aluminum trim
- hinged doors one side with touch latch; outside bases have 3" opening on top of hinged door side for wire management; middle base has 3" opening on top both sides for wire management
- adjustable glides

27" Rectangular Base with Apron Rails and Center Base

27 ¼"	132	27 ¾"	350	15	CC8NRC2-27132	\$9,549
-------	-----	-------	-----	----	---------------	---------

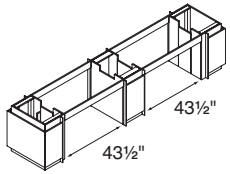

- use with 168" x 60" table top
- anodized aluminum trim
- hinged doors one side with touch latch; outside bases have 3" opening on top of hinged door side for wire management; middle base has 3" opening on top both sides for wire management
- adjustable glides

27" Rectangular Base with Apron Rails and Center Base

27 ¼"	108	27 ¾"	347	15	CC8NRC2-27108	\$9,413
-------	-----	-------	-----	----	---------------	---------

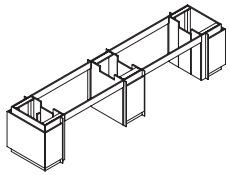

- use with 144" x 60" table top
- anodized aluminum trim
- hinged doors one side with touch latch; outside bases have 3" opening on top of hinged door side for wire management; middle base has 3" opening on top both sides for wire management
- adjustable glides

COLLECTIVE CONFERENCE

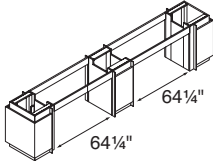
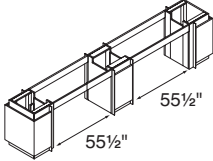
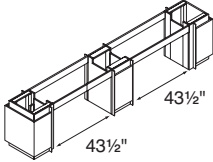
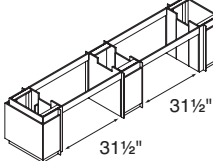
Description	D	W	H	CTN WT	CU FT	① Model	List Price
<b>21" Rectangular Base with Apron Rails and Center Base</b> 	21 1/4	174	27 3/4	308	15	CC8NRC2-21174	\$11,256
<ul style="list-style-type: none"> <li>· use with 216" x 48" table top</li> <li>· anodized aluminum trim</li> <li>· hinged doors one side with touch latch; outside bases have 3" opening on top of hinged door side for wire management; middle base has 3" opening on top both sides for wire management</li> <li>· adjustable glides</li> </ul>							
<b>21" Rectangular Base with Apron Rails and Center Base</b> 	21 1/4	156	27 3/4	306	15	CC8NRC2-21156	\$8,614
<ul style="list-style-type: none"> <li>· use with 192" x 48" table top</li> <li>· anodized aluminum trim</li> <li>· hinged doors one side with touch latch; outside bases have 3" opening on top of hinged door side for wire management; middle base has 3" opening on top both sides for wire management</li> <li>· adjustable glides</li> </ul>							
<b>21" Rectangular Base with Apron Rails and Center Base</b> 	21 1/4	132	27 3/4	304	15	CC8NRC2-21132	\$8,495
<ul style="list-style-type: none"> <li>· use with 168" x 48" table top</li> <li>· anodized aluminum trim</li> <li>· hinged doors one side with touch latch; outside bases have 3" opening on top of hinged door side for wire management; middle base has 3" opening on top both sides for wire management</li> <li>· adjustable glides</li> </ul>							
<b>21" Rectangular Base with Apron Rails and Center Base</b> 	21 1/4	108	27 3/4	302	15	CC8NRC2-21108	\$8,347
<ul style="list-style-type: none"> <li>· use with 144" x 48" table top</li> <li>· anodized aluminum trim</li> <li>· hinged doors one side with touch latch; outside bases have 3" opening on top of hinged door side for wire management; middle base has 3" opening on top both sides for wire management</li> <li>· adjustable glides</li> </ul>							

COLLECTIVE CONFERENCE

**To Order, Specify:**

- ① Model Number
- ② Wood Species
- ③ Finish Scheme
  - A. Outer Frame & Plinth - veneer only
  - B. Inner Panel/Door - veneer or paint (see page 312)
- ④ Other Product Options

Description	D	W	H	CTN WT	CU FT	① Model	List Price
21" Rectangular Base with Apron Rails	21 1/4	84	27 3/4	212	10	CC8NRC2-2184	\$5,699

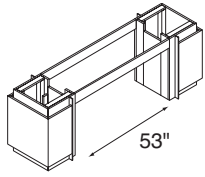

- use with 120" x 48" table top
- anodized aluminum trim
- hinged doors one side with touch latch; 3" opening on top of hinged door side for wire management
- adjustable glides

21" Rectangular Base with Apron Rails	21 1/4	60	27 3/4	208	10	CC8NRC2-2160	\$5,562
---------------------------------------	--------	----	--------	-----	----	--------------	---------

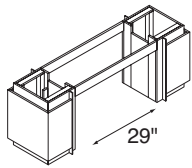

- use with 96" x 48" table top
- anodized aluminum trim
- hinged doors one side with touch latch; 3" opening on top of hinged door side for wire management
- adjustable glides

Description	D	W	H	CTN WT	CU FT	❶ Model	List Price
26" Dia. Base	26	26	27 ¾	93	13	CC8NCD1-0026	\$3,164

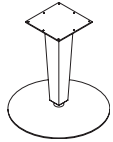

· 26" dia. disk base is Silver powder coated aluminum with veneer column

Cylinder Base	24	24	27 ¾	89	11	CC8NCY9-0024	\$3,206
---------------	----	----	------	----	----	--------------	---------



· 24" dia. base has 4 accent panels

**To Order, Specify:**

**21" Rectangular Base with Apron Rails**

- ❶ Model Number
- ❷ Wood Species
- ❸ Finish Scheme
  - A. Outer Frame & Plinth - veneer only
  - B. Inner Panel/Door - Veneer or Paint
 (see page 312)
- ❹ Other Product Options

**26" Dia. Base**

- ❶ Model Number
- ❷ Wood Species
- ❸ Finish Color
- ❹ Other Product Options

**Cylinder Base**

- ❶ Model Number
- ❷ Wood Species
- ❸ Finish Scheme
  - A. Chassis Frame - veneer only
  - B. Accent Panel - Veneer or Paint
 (see page 311)
- ❹ Other Product Options

Description	D	W	H	CTN WT	CU FT	① Model	List Price
-------------	---	---	---	-----------	----------	---------	------------

Accessory Shelf	15	16		13	2	CC9CNA1-1516	\$1,992
-----------------	----	----	--	----	---	--------------	---------

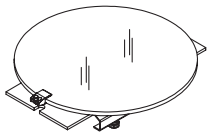

- 15" dia. glass shelf; not designed to rotate
- anodized aluminum
- frosted glass with screen print on underside

Lamp	6 ¾	4	30	10	1	CC9CNL1-0704	\$1,352
------	-----	---	----	----	---	--------------	---------

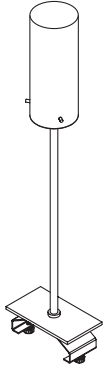

- anodized aluminum

Coaster	6 ¾	4		6	1	CC9CNC1-0704	\$1,453
---------	-----	---	--	---	---	--------------	---------

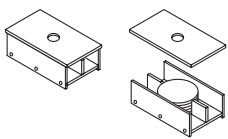

- includes (5) anodized aluminum coasters; finger lift lid

Storage	6 ¾	16	1 ¾	7	1	CC9CNS1-0716	\$895
---------	-----	----	-----	---	---	--------------	-------

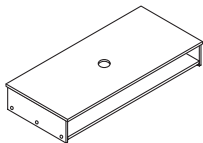

- storage - use for pens, notepads, and etc.
- anodized aluminum

Storage	6 ¾	12	1 ¾	7	1	CC9CNS1-0712	\$794
---------	-----	----	-----	---	---	--------------	-------

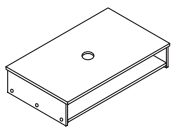

- storage - use for pens, notepads, and etc.
- anodized aluminum

Storage	6 ¾	8	1 ¾	6	1	CC9CNS1-0708	\$702
---------	-----	---	-----	---	---	--------------	-------

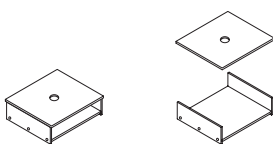

- storage - use for pens, notepads, and etc.
- anodized aluminum

COLLECTIVE CONFERENCE

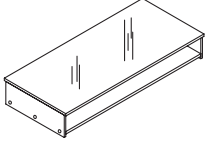
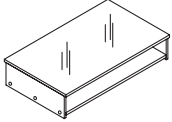
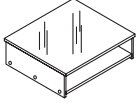
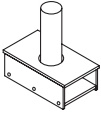
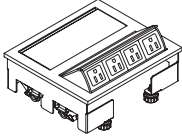
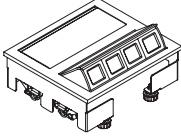

Description	D	W	H	CTN WT	CU FT	① Model	List Price
<b>Glass Panel</b>  <ul style="list-style-type: none"> <li>· glass surface; not for use as storage</li> <li>· anodized aluminum</li> <li>· frosted glass with screen print on underside</li> </ul>	6 ¾	16	1 ¾	7	1	CC9CNG1-0716	\$765
<b>Glass Panel</b>  <ul style="list-style-type: none"> <li>· glass surface; not for use as storage</li> <li>· anodized aluminum</li> <li>· frosted glass with screen print on underside</li> </ul>	6 ¾	12	1 ¾	6	1	CC9CNG1-0712	\$718
<b>Glass Panel</b>  <ul style="list-style-type: none"> <li>· glass surface; not for use as storage</li> <li>· anodized aluminum</li> <li>· frosted glass with screen print on underside</li> </ul>	6 ¾	8	1 ¾	6	1	CC9CNG1-0708	\$690
<b>Vase</b>  <ul style="list-style-type: none"> <li>· 7" vase (6" visible); clear glass</li> <li>· anodized aluminum</li> </ul>	6 ¾	4		5	1	CC9CNV1-0704	\$772
<b>Power Data Module</b>  <p>electrical side</p>  <p>voice/data side</p> <ul style="list-style-type: none"> <li>· anodized aluminum; one touch accessibility; (4) electrical one side; (4) voice/data ports opposite side; voice/data adapter kit; voice/data jacks &amp; couples sold separately; 10 ft., 15 amp cord with plug; UL listed</li> <li>· accepts up to four type 3 telecom jacks (see page 389)</li> <li>· NOTE: Use for consoles only</li> </ul>	7 ½	8		6	1	CC9CNE1-0708	\$1,398

COLLECTIVE CONFERENCE

**To Order, Specify:**  
 ① Model Number



## Collective Conference Storage Product Information



COLLECTIVE CONFERENCE

## Collective Conference Storage Product Information

### Exterior Wood Materials

Exterior surfaces are made from the finest selected veneers to achieve clarity and consistency in the Collective Conference Storage product line. To attain a pleasing, symmetrical pattern, all veneers in Collective Conference Storage are book-matched. All exterior solid lumber is matched to coordinate with the veneer.

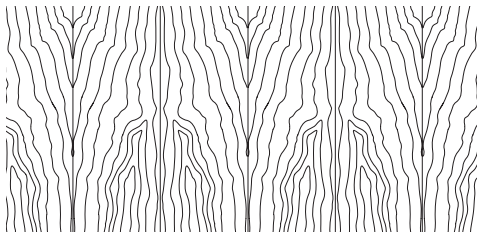

#### Book Matched Example

Alternating pieces of veneer are flipped over so they face each other like the pages within a book

Collective Conference Storage is available in flat cut cherry, maple, and walnut veneer.

Solid painted finishes on MDF are also offered on drawer and door fronts to provide an accent to the Collective Conference Storage product.

### Work Surface Construction

Tops are 3-ply balanced construction, 1½" thick with solid matching hardwood 1.5mm rims.

Matching or coordinating high pressure laminate in a veneer grain can be applied to the top surface and is available at no additional charge for some finishes.

### Case Construction

Outside panels are 1¾" and joined together by mortise and tenon construction. In addition to mortise and tenon joint construction, pedestal joints are reinforced with screws, cleats, brackets and glue. Tops are secured to the chassis with top fastening cleats screwed to the inside of the panels.

Cabinet doors have 110° swing hinges to allow adequate access into the interior of the cabinet.

Leveling glides are provided in both plinth base or telescopic foot.

### Extruded Aluminum Components

Telescopic Feet, Valance Rails, Tool Rails, and Spacers all are made from an alloy aluminum compound, made up of 10% post consumer scrap, 60% post industrial scrap and 30% primary aluminum. The aluminum meets or exceeds the guidelines of USGBC - LEED V2.2. The parts are precisely machined and then processed in a clear anodized finish for a natural aluminum appearance.

### Fabricated or Casted Metal Components

The metal is laser cut, bended and robotically welded to the exact specifications, polished and powder coated to blend with the anodized aluminum.

### Access Kneespace Panel

Wall stud construction style frame is made from 16-gauge steel, stamped and laser cut. Pop-rivets are used to combine frames and create various widths. Frames are coated with silver powder coat. The back is open and is designed to sit up against a wall, to allow for wiring access.

### Aluminum Glass Doors

Aluminum glass doors and modesty panels have extruded aluminum frames with 4mm thick with three glass options: frosted with acid etch front, frosted low iron white back painted glass (matte) and glossy low iron white back painted glass (shiny).

### Drawer Box Construction

The 9ply unidirectional hardwood sides of the drawer box are 7/16" thick assembled with English dovetail construction at each corner of the box. The drawer bottom panel is ¼" thick fitting into a groove machined into the side of the box. Interiors are sanded and coated with a clear U.V. finish to protect against shrinking, swelling or warping, and to provide a clean, smooth feel and appearance.

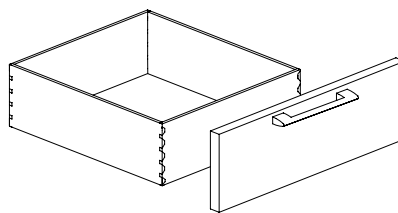

### Drawer Suspension

The high quality black drawer suspensions carry a lifetime warranty. Slides feature steel ball bearings for longer life with cushioned in/out stops. File and box drawers have 100% full extension with over travel.

# Collective Conference Storage Product Information

## Locking

Credenzas feature door locking option to provide maximum security and flexibility.

Units are shipped randomly keyed as standard (units tagged in the grouping are keyed alike). Keyed alike units are available if requested at no upcharge. Removable cores for in-field re-keying are standard.

## Finish - Stain/Colors

We offer a wide variety of wood stains and paint colors on the Collective Conference Storage. Please see the chart below. Samples are available upon request, through our website or by contacting Customer Service.

<b>CH1 Cherry</b>	<i>Flat Cut Veneer</i>		
BRL Barley		EAR Earthy	
BBM Bourbon Medium		HRV Harvest*	
BRM Brighton Medium		LGC Legacy	
CLA Classic		PRL Praline*	
CLL Collectors*		SAF Saffron	

<b>MA1 Maple</b>	<i>Flat Cut Veneer</i>		
ALM Ale Medium		FLX Flax	
BUT Butterscotch		VEN Venetian	
CIN Cinnamon			

<b>WA1 Walnut</b>	<i>Flat Cut Veneer</i>		
AUB Auburn		SIE Sienna*	
ESP Espresso		TOF Toffee	
MCH Mocha*		TRF Truffle*	
NTO Night Owl*			

<b>PNT Paint</b>	<i>MDF Board</i>		
BKD Backdrop		GRV Greek Villa	
BFX Black Fox		NET Network Gray	
BWH Bright White		NWH Nonchalant White	
CGP Cargo Pants		STM Storm	
CHT Chatroom		TRC Tricorn Black	
FRR French Roast			

\*finishes with coordinating laminate tops.

## Protective Top Coat

DuraTex™ offers exceptional hardness along with abrasion and impact resistance, it has been formulated to eliminate hazardous and harmful gases that are normally associated with wood finish.

## DuraTex™ Features

**Safety** - Significantly reduces hazardous formaldehyde emissions which help improve the quality of the indoor air we breathe.  
**Quality** - Developed to be tough and durable with special attention to appearance. The DuraTex™ finish preserves the natural beauty of wood.  
**Durability** - Designed to meet a wide range of demanding performance and environmental standards to withstand even the highest wear and tear.

## Product Modification

### Laminate Tops

Work surface only, no additional upcharge if Collective's coordinating wood grain laminate is specified. Contact Customer Service for any other laminate request.

<b>Cherry Finishes</b>	<b>Maple Finishes</b>	<b>Walnut Finishes</b>
Barley	Ale Light	Auburn
Bourbon Light	Cinnamon	Mocha
Brighton Light	Venetian	Night Owl
Classic		Sienna
Collectors		Toffee
Harvest		Truffle
Legacy		
Praline		
Saffron		

### Special Finishes

Special finishes can be requested by following the instruction in the general introduction section, page 3. There is a one time charge of \$332 list per order.

### Species Change

For species changes contact customer service for a quote.

## Collective Conference Storage Product Information

### Edge Profile Hardware

Collective Conference Storage utilizes a clean cut straight edge profile with a 1.5mm veneer rim. The Elite hardware is made of anodized aluminum. Longer versions of pull are available for other applications

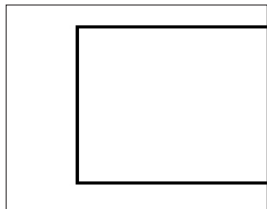

Straight Edge Profile

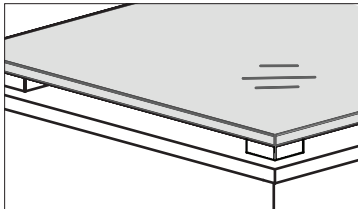

Floating Frosted Glass Top - screen print film  
(wood sub-top with aluminum spacers)

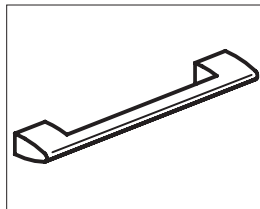

Elite Pull (PK)  
Anodized Aluminum Finish

### End Panel Grommet

Collective Conference Storage credenzas feature a brushed stainless steel 4" x 2" end panel grommet to allow for wire management. The end panel grommet is optional on other items; see pricing pages for more information.

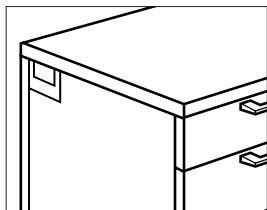

Grommet Location

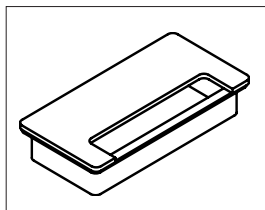

Grommet (G7C)  
Brush Stainless Steel

### Foot/Plinth Style Base

The Collective Conference Storage features an anodized aluminum foot. Plinth base feature is not available on conference storage product, so adequate ventilation can be achieved for technology.

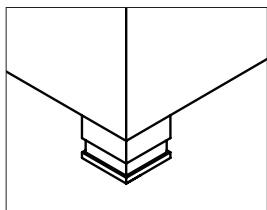

Foot Style  
Anodized Aluminum Finish

### Foot Leveling Details

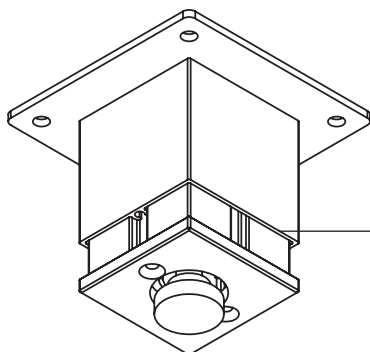

Telescopic cover can slide up to provide access for adjustment

## Collective Conference Storage Product Information

### Wall Options

Collective Conference Storage addresses today's information and presentation environments. Collective Conference Storage consists of modular components, Media Walls to build various technology applications. Walls require specification of left and right end panels or towers, and a center wall panel to complete a configuration.

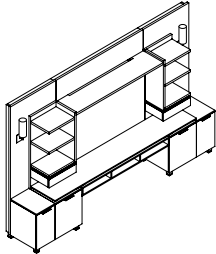

Media Wall

### Media Wall Components

The Media Wall supports technology applications to support large screen viewing and interactive video conferencing. The Media Wall creates 86" and 71" heights and includes a center wall panel, technology niche storage with back panel, technology credenza, end towers, glass and wood tops. Panels and towers are always wall mounted.

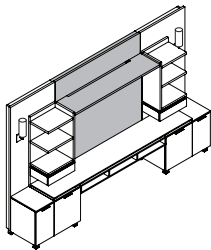

Center Wall Panel

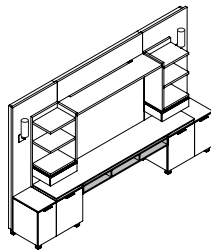

Technology Console

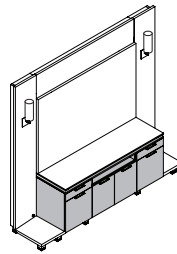

Technology Credenza

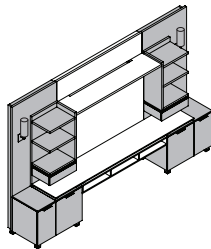

End Towers

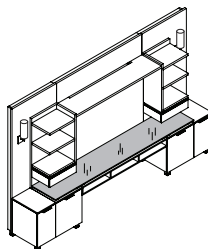
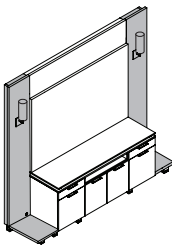

Glass and Wood Tops

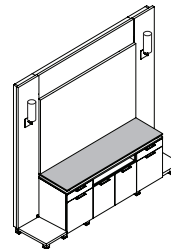

# Collective Conference Storage Product Information

## Center Access Panel

The Media Wall below shows how wires feed down the center wall panel into the technology niche storage with access panel and out to the end towers.

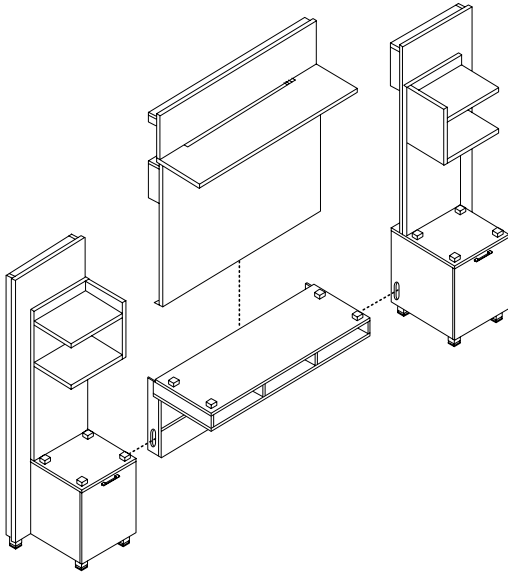

Media Wall with Technology Cubby  
(Front View)

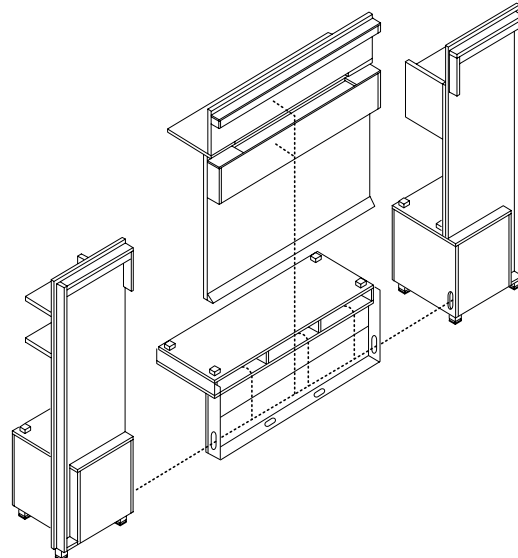

Media Wall with Technology Cubby  
(Back View)

## Center Technology Credenza

The diagram below shows the Media Wall with wire management routed down the center wall panel into the technology credenza and out to the end towers.

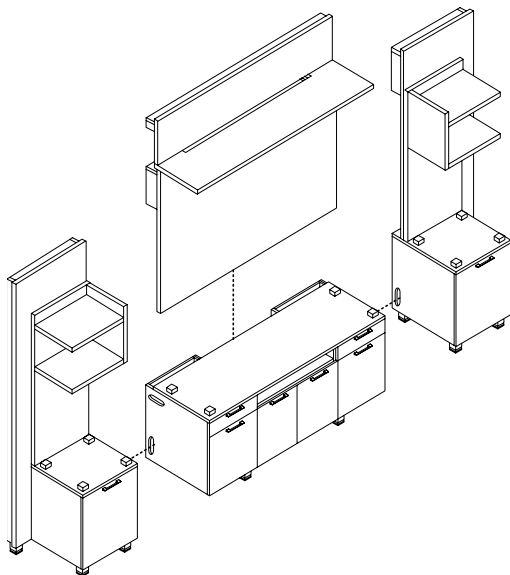

Media Wall with Technology Credenza  
(Front View)

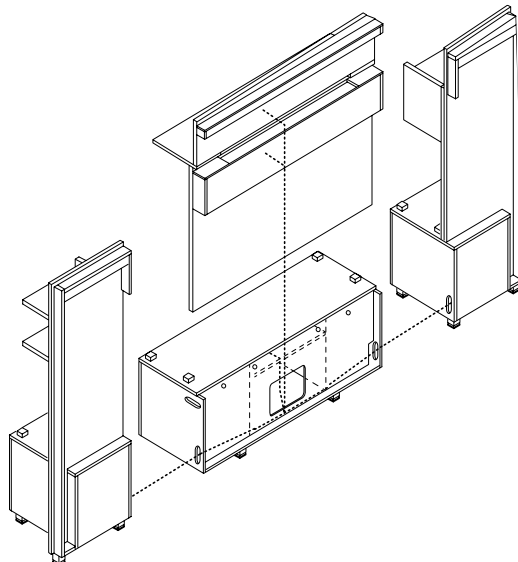

Media Wall with Technology Credenza  
(Front View)



## Collective Conference Storage Product Information

### Access Panel Wiring

The access panel consist of two hinged panels with a lid stay mechanism on upper panel. The panel allows access to building power and communication and features concealed lay-in cable channel, and optional modular power distribution system.

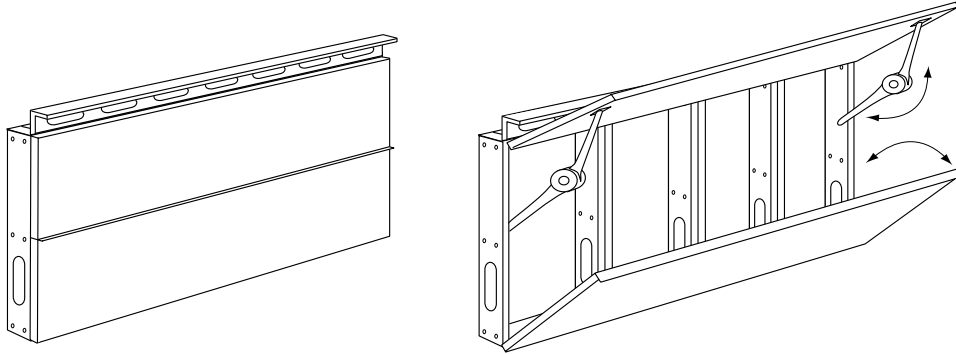

### Installation of the Data Adapter Kit & Base Plate

1. Select the appropriate adapter.
2. Snap jack into adapter following the instructions provided with the jack.
3. Once assembled, snap adapter into the notched, square holes in the orientation shown.
4. If provided, snap adapter into any 1 $\frac{3}{8}$ " x 2 $\frac{3}{4}$ " opening.

Note: Verify fit of jack in adapter before ordering large quantities as manufacturer designs may change without notice.

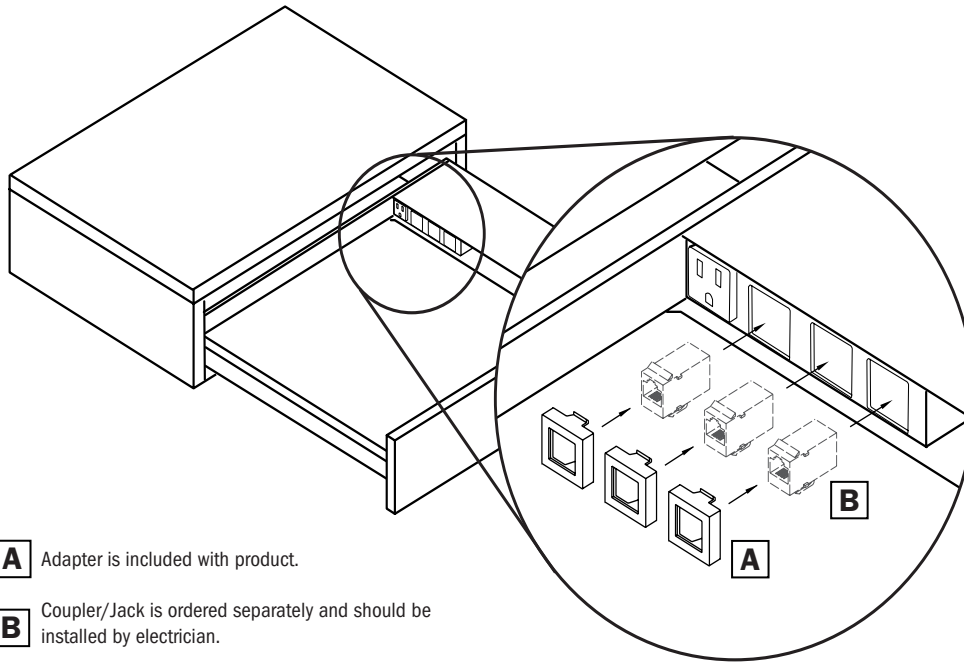

**A** Adapter is included with product.

**B** Coupler/Jack is ordered separately and should be installed by electrician.

## Collective Conference Storage Product Information

### Material Options and Finish Schemes

Collective Conference Storage uses a mix of materials: paint, veneer, and aluminum. Veneer choices are cherry, maple, and walnut. Eleven paint colors are available; see page 395. Wood worksurface tops or rims on laminate worksurface top, are available in veneer finishes only.

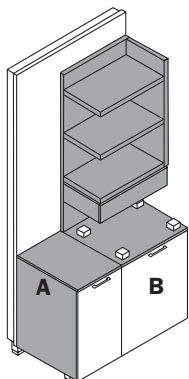

Media Wall End Tower

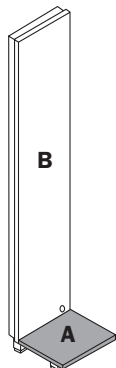

Media Wall Speaker Tower

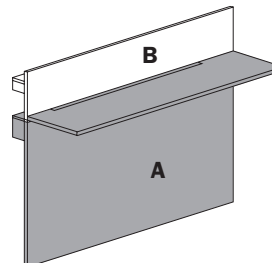

Media Wall Center Wall Panel

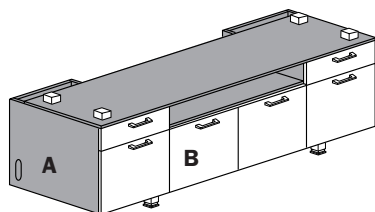

Media Wall Technology Credenza

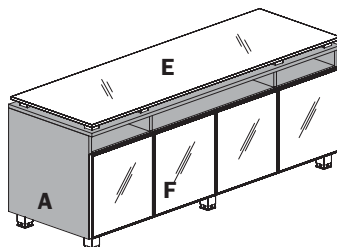

Freestanding Media Credenza

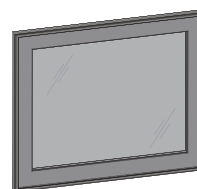

**Aluminum Frame Door with**  
 Frosted Tempered Glass  
 Frosted Bright White Back Painted Glass (matte)  
 Glossy Frosted Bright White Back Painted Glass (shiny)

(clear anodized aluminum frame)

### Material Key

- A veneer finish only
- B veneer or paint
- C fabric tackable surface (aluminum tool rail between panels)
- D dry erase marker board (marker/eraser tray)
- E frosted glass top - screen print film
- F aluminum frame glass doors

## Collective Conference Storage Product Information

### Finish and Product Reference Codes

Select	Code	Select	Code	Select	Code
<b>Veneer</b>		Walnut Finishes		<b>Laminate Coordinates</b>	
Cherry Flat Cut	CH1	Auburn	AUB	Cherry Wood Grain Patterns	
Maple Flat Cut	MA1	Espresso	ESP	Barley	BRL
Walnut Flat Cut	WA1	Mocha	MCH	Bourbon Light	BOL
		Night Owl	NTO	Brighton Light	BGL
<b>Finish</b>		Sienna	SIE	Classic	CLA
Cherry		Toffee	TOF	Collectors	CLL
Barley	BRL	Truffle	TRF	Harvest	HRV
Bourbon Medium	BBM			Legacy	LGC
Brighton Medium	BRM	<b>Paint Finishes</b>		Praline	PRL
Classic	CLA	Backdrop	BKD	Saffron	SAF
Collectors	CLL	Black Fox	BFX		
Earthy	EAR	Bright White	BWH	<b>Maple Wood Grain Patterns</b>	
Harvest	HRV	Cargo Pants	CGP	Ale Light	ALL
Legacy	LGC	Chatroom	CHT	Cinnamon	CIN
Praline	PRL	French Roast	FRR	Venetian	VEN
Saffron	SAF	Greek Villa	GRV		
		Network Gray	NET	<b>Walnut Wood Grain Patterns</b>	
<b>Maple Finishes</b>		Nonchalant White	NWH	Auburn	AUB
Ale Medium	ALM	Storm	STM	Mocha	MCH
Butterscotch	BUT	Tricorn Black	TRC	Night Owl	NTO
Cinnamon	CIN			Sienna	SIE
Flax	FLX			Toffee	TOF
Venetian	VEN			Truffle	TRF
				<b>Metal Finish</b>	
				Arctic Silver	ASL
				Anodized Clear Aluminum	AAL

### Order Check List:

Specify:

- 1. Model Number
- 2. Finish Scheme/Color (see page 400)
- 3. Wood Species - cherry - maple - walnut
- 4. Top Options - standard veneer - laminate surface (see page 396)
- 5. Other Product Options
- 6. Power and Data Accessories (*drawing showing location and orientation must accompany order*)
- 7. Side Mark Information (*i.e. room number, East Conference Room*)
- 8. Shipping Address (*contact name and phone number*)
- 9. Special Delivery Instructions (*i.e. call before delivery, deliver to job site*)

Description	D	W	H	CTN WT	CU FT	① Model	List Price
86" h Storage Tower with Laptop Drawer	24	34 1/2	86 1/4	316	48	MDOQDTAR-2435	\$8,750
	24	34 1/2	86 1/4	316	48	MDOQDTAL-2435	\$8,750

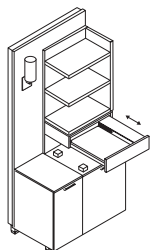

left shown with optional sconce

- use with 18 1/2" d top
- three open fixed shelves
- laptop drawer with power port
- three blanks (for future data use)
- two adapter kits to fit coupler/jacks
- aluminum spacers included
- 20 1/2" w storage compartment with one adjustable shelf and cut-out for wall access
- 14" w storage compartment with a concealed storage drawer
- wire management cut-out in pedestal opposite door hinge
- telescopic feet
- locking doors available, specify and add \$246 list
- pull-out shelf in large compartment available, specify and add \$283 list
- wall sconce available, specify and add \$401 list

86" h Storage Tower with Drawer	24	34 1/2	86 1/4	304	48	MDOQDTBR-2435	\$8,009
	24	34 1/2	86 1/4	304	48	MDOQDTBL-2435	\$8,009

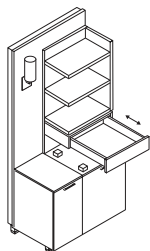

left shown with optional sconce

- use with 18 1/2" d top
- three open fixed shelves and drawer
- aluminum spacers included
- 20 1/2" w storage compartment with one adjustable shelf and cut-out for wall access
- 14" w storage compartment with a concealed storage drawer
- wire management cut-out in pedestal opposite door hinge
- telescopic feet
- locking doors available, specify and add \$246 list
- pull-out shelf in large compartment available, specify and add \$283 list
- wall sconce available, specify and add \$401 list

86" h Storage Tower	24	34 1/2	86 1/4	273	48	MDOQDT1R-2435	\$6,838
	24	34 1/2	86 1/4	273	48	MDOQDT1L-2435	\$6,838

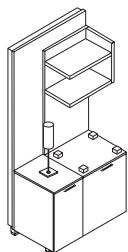

left shown with optional lamp

- use with 18 1/2" d top
- two open fixed shelves and drawer
- aluminum spacers included
- 20 1/2" w storage compartment with one adjustable shelf and cut-out for wall access
- 14" w storage compartment with a concealed storage drawer
- wire management cut-out in pedestal opposite door hinge
- telescopic feet
- locking doors available, specify and add \$246 list
- pull-out shelf in large compartment available, specify and add \$283 list
- credenza lamp available, specify and add \$420 list

Description	D	W	H	CTN WT	CU FT	① Model	List Price
86" h Wood Door Storage Tower	24	34 ½	86 ¼	247	48	MDOQTT1R-2435	\$7,647
	24	34 ½	86 ¼	247	48	MDOQTT1L-2435	\$7,647

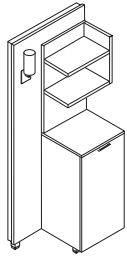

left shown with optional scance

- two open fixed shelves
- storage compartment with two adjustable shelves and cut-out for wall access
- wire management cut-out in pedestal opposite door hinge
- telescopic feet
- locking door available, specify and add \$123 list
- pull-out shelf in closed compartment available, specify and add \$283 list
- wall scance available, specify and add \$401 list

86" h Glass Door Storage Tower	24	34 ½	86 ¼	244	48	MDOQTGR-2435	\$7,448
	24	34 ½	86 ¼	244	48	MDOQTGL-2435	\$7,448

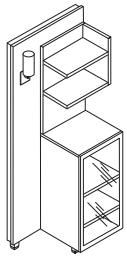

left shown with optional scance

- two open fixed shelves
- glass door is touch latch
- storage compartment with two adjustable shelves and cut-out for wall access
- telescopic feet
- locking not available
- pull-out shelf in closed compartment available, specify and add \$283 list
- wall scance available, specify and add \$401 list

**To Order, Specify:**

- ① Model Number
- ② Wood Species on Top/Chassis/Shelves -  
Cherry (CH1), Maple (MA1) or Walnut (WA1)  
(see page 395)
- ③ Finish Color for Top/Chassis/Shelves (see page 400)
- ④ Finish Color for Back Panel and Door Fronts  
A. Same as Top  
B. Paint Color (see page 395)
- ⑤ Glass Door Option (see page 400)

Description	D	W	H	CTN WT	CU FT	① Model	List Price
<b>86" h Refreshment/Storage Tower</b>	24	30	86 ¼	268	41	<b>MDOQRT1R-2430</b>	<b>\$7,190</b>
	24	30	86 ¼	268	41	<b>MDOQRT1L-2430</b>	<b>\$7,190</b>

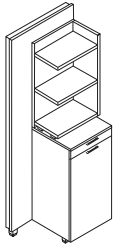

left shown

- three open fixed shelves
- aluminum spacers included
- storage drawer
- storage compartment with cut-out for ventilation or wall access
- wire management cut-out in pedestal opposite door hinge
- telescopic feet
- locking door available, specify and add \$123 list
- open interior space: 22 ½" d x 22 ½" w x 31" h

<b>86" h Garage Tower</b>	24	30	86 ¼	254	42	<b>MDOQGT1R-2430</b>	<b>\$6,344</b>
	24	30	86 ¼	254	42	<b>MDOQGT1L-2430</b>	<b>\$6,344</b>

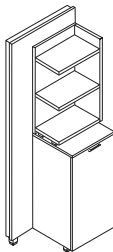

left shown

- three open fixed shelves
- aluminum spacers included
- stores mobile technology cart, see page 241 (order separately)
- wire management cut-out in pedestal opposite door hinge
- telescopic feet
- locking door available, specify and add \$123 list
- open bottom: 20 ¾" d x 17" w

Description	D	W	H	CTN WT	CU FT	① Model	List Price
86" h Storage Tower with Laptop Drawer	24	26 ½	86 ¼	239	37	MDOQSTAR-2427	\$6,893
	24	26 ½	86 ¼	239	37	MDOQSTAL-2427	\$6,893

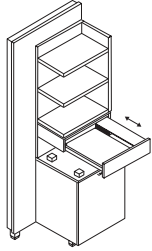

left shown

- use with 18 ½" d top
- three open fixed shelves
- laptop drawer with power port
- three blanks (for future data use)
- two adaptor kits to fit coupler/jacks
- aluminum spacers included
- 20 ½" w storage compartment with one adjustable shelf and cut-out for wall access
- wire management cut-out in pedestal opposite door hinge
- telescopic feet
- locking door available, specify and add \$123 list
- pull-out shelf in closed compartment available, specify and add \$283 list

86" h Storage Tower with Drawer	24	26 ½	86 ¼	239	37	MDOQSTBR-2427	\$6,150
	24	26 ½	86 ¼	239	37	MDOQSTBL-2427	\$6,150

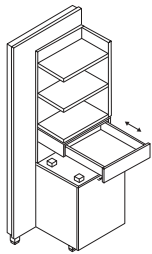

left shown

- use with 18 ½" d top
- three open fixed shelves and drawer
- aluminum spacers included
- 20 ½" w storage compartment with one adjustable shelf and cut-out for wall access
- wire management cut-out in pedestal opposite door hinge
- telescopic feet
- locking door available, specify and add \$123 list
- pull-out shelf in closed compartment available, specify and add \$283 list

**To Order, Specify:**

- ① Model Number
- ② Wood Species on Top/Chassis/Shelves -  
Cherry (CH1), Maple (MA1) or Walnut (WA1)  
(see page 395)
- ③ Finish Color for Top/Chassis/Shelves (see page 400)
- ④ Finish Color for Back Panel and Door Fronts
  - A. Same as Top
  - B. Paint Color (see page 395)

Description	D	W	H	CTN WT	CU FT	① Model	List Price
86" h Storage Tower	24	26½	86¼	197	37	MDOQST1R-2427	\$5,251
	24	26½	86¼	197	37	MDOQST1L-2427	\$5,251

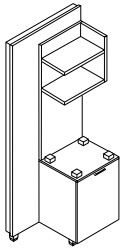

left shown

- use with 18½" d top
- two open fixed shelves
- aluminum spacers included
- 20½" w storage compartment with one adjustable shelf and cut-out for wall access
- wire management cut-out in pedestal opposite door hinge
- telescopic feet
- locking door available, specify and add \$123 list
- pull-out shelf in closed compartment available, specify and add \$283 list
- credenza lamp available, specify and add \$445 list

86" h Storage Tower	24	27	86¼	163	38	MDOQSTZR-2427	\$5,181
	24	27	86¼	163	38	MDOQSTZL-2427	\$5,181

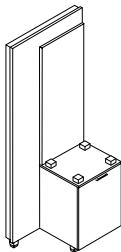

left shown

- use with 18½" d top
- aluminum spacers included
- 20½" w storage compartment with one adjustable shelf and cut-out for wall access
- wire management cut-out in pedestal opposite door hinge
- telescopic feet
- locking door available, specify and add \$123 list
- pull-out shelf in closed compartment available, specify and add \$283 list
- credenza lamp available, specify and add \$445 list

86" h Glass Door Storage Tower	24	20½	86¼	214	30	MDOQNT1R-2421	\$5,957
	24	20½	86¼	214	30	MDOQNT1L-2421	\$5,957

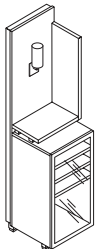

left shown with optional scence

- one open fixed shelf
- aluminum spacers included
- glass door is touch latch
- storage compartment with two adjustable shelves and cut out for wall access
- wire management cut-out in pedestal opposite door hinge
- telescopic feet
- locking not available
- pull-out shelf in closed compartment available, specify and add \$283 list
- wall scence available, specify and add \$401 list

86" h Speaker Tower	24	14	86¼	63	21	MDOQHT1R-2414	\$3,292
	24	14	86¼	63	21	MDOQHT1L-2414	\$3,292

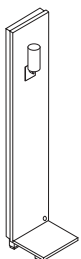

left shown with optional scence

- 1¼" d grommet installed on attaching side of back panel
- position on media wall determines left or right
- telescopic feet
- wall scence available, specify and add \$401 list



Description	D	W	H	CTN WT	CU FT	① Model	List Price
71" h Storage Tower with Laptop Drawer	24	34 ½	71 ¼	276	43	MDOQDSAR-2435	\$7,223
	24	34 ½	71 ¼	276	43	MDOQDSAL-2435	\$7,223

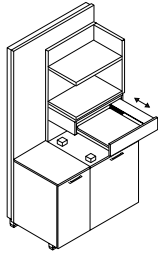

left shown

- use with 18 ½" d top
- two open fixed shelves
- laptop drawer with power port
- three blanks (for future data use)
- two adaptor kits to fit coupler/jacks
- aluminum spacers included
- 20 ½" w storage compartment with one adjustable shelf and cut-out for wall access
- 14" w storage compartment with a concealed storage drawer
- one power port
- wire management cut-out in pedestal opposite door hinge
- telescopic feet
- locking doors available, specify and add \$246 list
- pull-out shelf in large compartment available, specify and add \$283 list

71" h Storage Tower with Drawer	24	34 ½	71 ¼	264	43	MDOQDSBR-2435	\$6,481
	24	34 ½	71 ¼	264	43	MDOQDSBL-2435	\$6,481

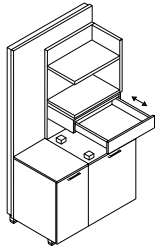

left shown

- use with 18 ½" d top
- two open fixed shelves and drawer
- aluminum spacers included
- 20 ½" w storage compartment with one adjustable shelf and cut-out for wall access
- 14" w storage compartment with a concealed storage drawer
- telescopic feet
- locking doors available, specify and add \$246 list
- pull-out shelf in large compartment available, specify and add \$283 list

71" h Storage Tower	24	34 ½	71 ¼	233	43	MDOQDS1R-2435	\$6,224
	24	34 ½	71 ¼	233	43	MDOQDS1L-2435	\$6,224

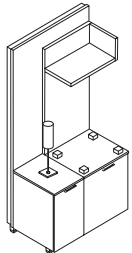

left shown

- use with 18 ½" d top
- one open fixed shelf
- aluminum spacers included
- 20 ½" w storage compartment with one adjustable shelf and cut-out for wall access
- 14" w storage compartment with a concealed storage drawer
- wire management cut-out in pedestal opposite door hinge
- telescopic feet
- locking doors available, specify and add \$246 list
- pull-out shelf in large compartment available, specify and add \$283 list
- credenza lamp available, specify and add \$445 list

**To Order, Specify:**

- ① Model Number
- ② Wood Species on Top/Chassis/Shelves -  
Cherry (CH1), Maple (MA1) or Walnut (WA1)  
(see page 395)
- ③ Finish Color for Top/Chassis/Shelves (see page 400)
- ④ Finish Color for Back Panel and Door Fronts  
A. Same as Top  
B. Paint Color (see page 395)
- ⑤ Glass Door Option (see page 400)

Description	D	W	H	CTN WT	CU FT	① Model	List Price
71" h Storage Tower with Laptop Drawer	24	26½	71¼	203	33	MDOQSSAR-2427	\$6,757
	24	26½	71¼	203	33	MDOQSSAL-2427	\$6,757

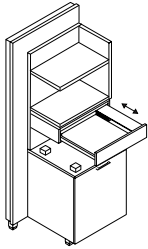

left shown

- use with 18½" d top
- two open fixed shelves
- laptop drawer with one power port
- three blanks (for future data use)
- two adaptor kits to fit coupler/jacks
- aluminum spacers included
- 20½" w storage compartment with one adjustable shelf and cut-out for wall access
- wire management cut-out in pedestal opposite door hinge
- telescopic feet
- locking doors available, specify and add \$246 list
- pull-out shelf in large compartment available, specify and add \$283 list

71" h Storage Tower with Drawer	24	26½	71¼	203	33	MDOQSSBR-2427	\$6,017
	24	26½	71¼	203	33	MDOQSSBL-2427	\$6,017

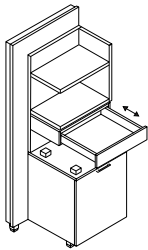

left shown

- use with 18½" d top
- two open fixed shelves and drawer
- aluminum spacers included
- 20½" w storage compartment with one adjustable shelf and cut-out for wall access
- wire management cut-out in pedestal opposite door hinge
- telescopic feet
- locking doors available, specify and add \$123 list
- pull-out shelf in large compartment available, specify and add \$283 list

71" h Storage Tower	24	26½	71¼	161	33	MDOQSS1R-2427	\$4,157
	24	26½	71¼	161	33	MDOQSS1L-2427	\$4,157

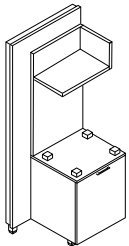

left shown

- use with 18½" d top
- one open fixed shelf
- aluminum spacers included
- 20½" w storage compartment with one adjustable shelf and cut-out for wall access
- wire management cut-out in pedestal opposite door hinge
- telescopic feet
- locking doors available, specify and add \$123 list
- pull-out shelf in large compartment available, specify and add \$283 list
- credenza lamp available, specify and add \$420 list

Description	D	W	H	CTN WT	CU FT	① Model	List Price
71" h Storage Tower	24	27	71 ¼	148	33	MDOQSSZR-2427	\$3,564
	24	27	71 ¼	148	33	MDOQSSZL-2427	\$3,564

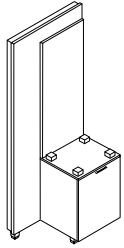

left shown

- use with 18 ½" d top
- aluminum spacers included
- 20 ½" w storage compartment with one adjustable shelf and cut-out for wall access
- wire management cut-out in pedestal opposite door hinge
- telescopic feet
- locking door available, specify and add \$123 list
- pull-out shelf in closed compartment available, specify and add \$283 list
- credenza lamp available, specify and add \$445 list

71" h Speaker Tower	24	14	71 ¼	55	14	MDOQHS1R-2414	\$2,827
	24	14	71 ¼	55	14	MDOQHS1L-2414	\$2,827



left shown with optional sconce

- 1 ¼" grommet installed on attaching side of back panel
- position on media wall determines left or right
- telescopic feet
- wall sconce available, specify and add \$401 list

**To Order, Specify:**

- ① Model Number
- ② Wood Species on Top/Chassis/Shelves -  
Cherry (CH1), Maple (MA1) or Walnut (WA1)  
(see page 395)
- ③ Finish Color for Top/Chassis/Shelves (see page 400)
- ④ Finish Color for Back Panel and Door Front
  - A. Same as Top
  - B. Paint Color (see page 395)

Description	D	W	H	CTN WT	CU FT	① Model	List Price
Technology Credenza	24	72	26½	238	32	MDOTCRD-2472	\$6,661
	24	66	26½	234	29	MDOTCRD-2466	\$6,445

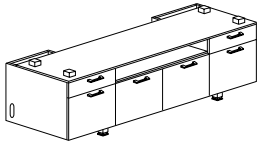

- unhanded
- not freestanding
- order top separately, see next page
- 2 pencil/hinge pedestals with adjustable shelves each end, 18" w
- 2 hinge/door pedestals center, 18" w
- technology cubby, 36" w
- wire management cut-outs in back panel
- aluminum spacers included
- telescopic feet
- locking drawers not available
- locking doors available, specify and add \$369 list
- pull-out shelf (on outside hinged doors) available, specify and add \$283 list each

Technology Credenza	24	54	26½	194	24	MDOTCRD-2454	\$5,839
---------------------	----	----	-----	-----	----	--------------	---------

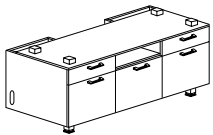

- unhanded
- not freestanding
- order top separately, see next page
- 2 pencil/hinge pedestals with adjustable shelves each end, 18" w
- 1 hinge/door pedestal center, 18" w
- technology cubby, 18" w
- wire management cut-outs in back panel
- aluminum spacers included
- telescopic feet
- locking drawers not available
- locking doors available, specify and add \$369 list
- pull-out shelf (on outside hinged doors) available, specify and add \$283 list each

Technology Credenza	24	72	26½	225	32	MDOTCRO-2472	\$5,412
	24	66	26½	210	29	MDOTCRO-2466	\$5,286

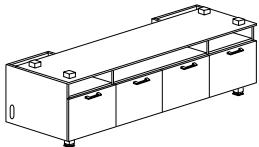

- unhanded
- not freestanding
- order top separately, see next page
- 4 hinge door pedestals, 18" w
- outer hinge door pedestals with adjustable shelves
- 2 technology cubbies, 18" w
- 1 technology cubby, 36" w
- wire management cut-outs in back panel
- aluminum spacers included
- telescopic feet
- locking doors available, specify and add \$369 list
- pull-out shelf (on outside hinged doors) available, specify and add \$283 list each

Technology Credenza	24	54	26½	182	24	MDOTCRO-2454	\$4,357
---------------------	----	----	-----	-----	----	--------------	---------

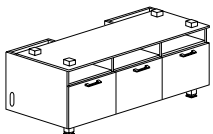

- unhanded
- not freestanding
- order top separately, see next page
- 3 hinge door pedestals, 18" w
- outer hinge door pedestals with adjustable shelves
- 3 technology niches, 18" w
- wire management cut-outs in back panel
- mount to end units for support
- aluminum spacers included
- telescopic feet
- locking doors available, specify and add \$369 list
- pull-out shelf (on outside hinged doors) available, specify and add \$283 list each

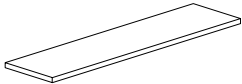
Description	D	W	H	CTN WT	CU FT	① Model	List Price
<b>Wood Tops</b> 	18½	113	1¼	68	4	MD7WTU1-19113	\$2,515
	18½	107	1¼	65	4	MD7WTU1-19107	\$2,406
	18½	101	1¼	61	4	MD7WTU1-19101	\$2,273
	18½	95	1¼	57	4	MD7WTU1-1995	\$2,138
	18½	72	1¼	43	3	MD7WTU1-1972	\$1,157
	18½	66	1¼	40	3	MD7WTU1-1966	\$1,111
	18½	60	1¼	36	2	MD7WTU1-1960	\$1,012
	18½	54	1¼	33	2	MD7WTU1-1954	\$848
	18½	20½	1¼	12	1	MD7WTU1-1921	\$497

- long grain veneer direction

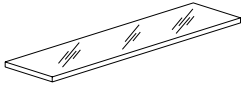
<b>Glass Tops</b> 	18½	113	¾	102	4	MD7WTUG-19113	\$3,681
	18½	107	¾	96	3	MD7WTUG-19107	\$3,570
	18½	101	¾	91	3	MD7WTUG-19101	\$3,372
	18½	95	¾	85	3	MD7WTUG-1995	\$3,173
	18½	72	¾	65	2	MD7WTUG-1972	\$1,838
	18½	66	¾	59	2	MD7WTUG-1966	\$1,770
	18½	60	¾	54	2	MD7WTUG-1960	\$1,610
	18½	54	¾	49	2	MD7WTUG-1954	\$1,453
	18½	20½	¾	18	1	MD7WTUG-1921	\$792

- frosted glass top - screen print on underside
- eased edges
- fingerprint resisting coating on underside

### To Order, Specify:

#### Credenzas

- ① Model Number
- ② Wood Species on Top/Chassis/Cubby- Cherry (CH1), Maple (MA1) or Walnut (WA1), (see page 395)
- ③ Finish Color for Top/Chassis (see page 400)
- ④ Finish Color for Door/Drawer Fronts
  - A. Same as Top
  - B. Paint Color (see page 395)

#### Wood Tops

- ① Model Number
- ② Wood Species - Cherry (CH1), Maple (MA1) or Walnut (WA1), (see page 395)
- ③ Finish Color (see page 395)

Description	D	W	H	CTN WT	CU FT	① Model	List Price
Technology Cubby Storage with Access Panel	21 3/4	72	26 1/2	125	17	MD0TNS1-2272	\$3,962
	21 3/4	66	26 1/2	115	15	MD0TNS1-2266	\$3,712
	21 3/4	60	26 1/2	106	14	MD0TNS1-2260	\$3,408
	21 3/4	54	26 1/2	96	13	MD0TNS1-2254	\$3,066

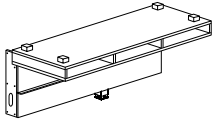

- unhanded
- not freestanding
- mount to end units for support
- use below credenza top
- panels open top up and bottom down for wire access

Center Wall Panel with Technology Shelf	19 1/2	72	59 3/4	212	28	MD0TPT1-2072	\$3,829
	19 1/2	66	59 3/4	195	26	MD0TPT1-2066	\$3,512
	19 1/2	60	59 3/4	144	24	MD0TPT1-2060	\$3,239
	19 1/2	54	59 3/4	162	21	MD0TPT1-2054	\$2,976

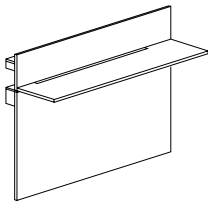

- use with 86" h ends
- unhanded
- 42" x 1 1/4" wire management opening (center shelf)
- -2072 TV dimension not to exceed 70" w x 40" h to allow proper mounting clearance and air circulation
- -2066 TV dimension not to exceed 64" w x 40" h to allow proper mounting clearance and air circulation
- -2060 TV dimension not to exceed 58" w x 40" h to allow proper mounting clearance and air circulation
- -2054 TV dimension not to exceed 52" w x 40" h to allow proper mounting clearance and air circulation

Center Wall Panel	5 1/2	72	59 1/2	184	20	MD0TPTZ-2072	\$3,323
	5 1/2	66	59 1/2	168	18	MD0TPTZ-2066	\$3,175
	5 1/2	60	59 1/2	153	17	MD0TPTZ-2060	\$2,936
	5 1/2	54	59 1/2	140	17	MD0TPTZ-2054	\$2,776

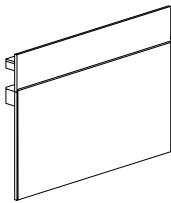

- use with 86" h ends
- unhanded
- -2072 TV dimension not to exceed 70" w x 40" h to allow proper mounting clearance
- -2066 TV dimension not to exceed 64" w x 40" h to allow proper mounting clearance
- -2060 TV dimension not to exceed 58" w x 40" h to allow proper mounting clearance
- -2054 TV dimension not to exceed 52" w x 40" h to allow proper mounting clearance

Center Wall Panel	5 1/2	72	44 3/4	146	15	MD0TPS1-0672	\$2,090
	5 1/2	66	44 3/4	135	14	MD0TPS1-0666	\$1,918
	5 1/2	60	44 3/4	129	13	MD0TPS1-0660	\$1,770
	5 1/2	54	44 3/4	111	11	MD0TPS1-0654	\$1,637

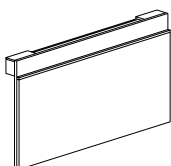

- use with 71" h ends
- unhanded
- -0672 TV dimension not to exceed 70" w x 36 1/2" h to allow proper mounting clearance
- -0666 TV dimension not to exceed 64" w x 36 1/2" h to allow proper mounting clearance
- -0660 TV dimension not to exceed 58" w x 36 1/2" h to allow proper mounting clearance
- -0654 TV dimension not to exceed 52" w x 36 1/2" h to allow proper mounting clearance

Description	D	W	H	CTN WT	CU FT	① Model	List Price
Serving Height Credenza	24	72	36 1/8	411	47	MD2BCR1-2472	\$8,148

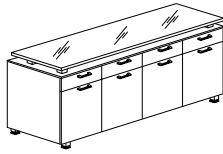

- freestanding
- frosted glass top - screen print on underside
- 4 pencil/hinge pedestal with adjustable shelves, 18"w
- aluminum spacers included
- telescopic feet
- locking drawers not available
- locking doors available, specify and add \$369 list
- wood top, deduct \$372 list - species and finish will match chassis

**To Order, Specify:**

**Access Panel**

- ① Model Number
- ② Wood Species on Top/Chassis- Cherry (CH1), Maple (MA1) or Walnut (WA1), (see page 395)

**Center Wall Panels**

- ① Model Number
- ② Wood Species on Lower Panel/Shelf - Cherry (CH1), Maple (MA1) or Walnut (WA1), (see page 395)
- ③ Finish Color for Lower Panel/Shelf (see page 395)
- ④ Finish Color for Upper Center Panel
  - A. Same as Lower Panel/Shelf
  - B. Paint Color (see page 395)

**Credenzas**

- ① Model Number
- ② Wood Species on Chassis- Cherry (CH1), Maple (MA1) or Walnut (WA1), (see page 395)
- ③ Finish Color for Chassis (see page 395)
- ④ Finish Color for Door/Drawer Fronts
  - A. Same as Chassis
  - B. Paint Color (see page 395)

Description	D	W	H	CTN WT	CU FT	① Model	List Price
-------------	---	---	---	-----------	----------	---------	------------

**72"w Technology Credenza**

24	72	29	357	39	<b>MD0FCRG-2472</b>	<b>\$7,112</b>
----	----	----	-----	----	---------------------	----------------

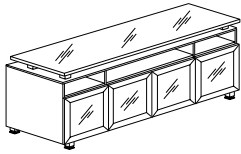

- freestanding
- 23 1/4" d frosted glass top - screen print on underside
- 4 glass hinge door pedestals, 18" w
- outer hinge door pedestals with adjustable shelves
- 2 technology cubbies, 18" w
- 1 technology cubby, 36" w
- wire management cut-outs in back panel
- aluminum spacers included
- locking not available
- wood top, deduct \$372 list - species and finish will match chassis

**72"w Technology Credenza**

24	72	29	374	39	<b>MD0FCRD-2472</b>	<b>\$6,559</b>
----	----	----	-----	----	---------------------	----------------

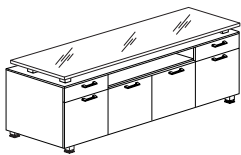

- freestanding
- 23 1/4" d frosted glass top - screen print on underside
- 2 pencil/hinge door pedestals with adjustable shelves each end, 18" w
- 2 hinge door pedestals center, 18" w
- technology cubby 36" w
- wire management cut-outs in back panel
- aluminum spacers included
- telescopic feet
- locking drawers not available
- locking doors available, specify and add \$369 list
- wood top, deduct \$372 list - species and finish will match chassis

**60"w Technology Credenza**

24	60	29	302	33	<b>MD0FCRE-2460</b>	<b>\$5,923</b>
----	----	----	-----	----	---------------------	----------------

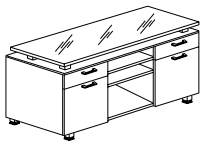

- freestanding
- 23 1/4" d frosted glass top - screen print on underside
- 2 pencil/hinge door pedestals with adjustable shelves each end, 18" w
- open center, 24" w
- technology cubby 24" w
- wire management cut-outs in back panel
- adjustable shelf per compartment
- aluminum spacers included
- telescopic feet
- locking drawers not available
- locking doors available, specify and add \$246 list
- wood top, deduct \$310 list - species and finish will match chassis



Description	D	W	H	CTN WT	CU FT	① Model	List Price
90"w Technology Console	24	90	24 ¾	348	42	MDOFCSD-2490	\$7,335

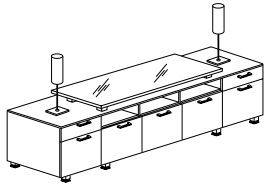

- freestanding
- 23 ¼"d frosted glass top - screen print on underside
- 2 pencil/hinge door pedestals with adjustable shelves each end, 18"w
- 3 hinge door pedestals center, 18"w
- 3 technology cubbies center, 18"w
- wire management cut-outs in back panel
- aluminum spacers included
- two credenza lamps
- telescopic feet
- locking drawers not available
- locking doors available, specify and add \$492 list
- wood top, deduct \$245 list - species and finish will match chassis

72"w Asymmetric Technology Console	24	72	24 ¾	251	34	MDOACSDR-2472	\$6,857
	24	72	24 ¾	251	34	MDOACSDL-2472	\$6,857

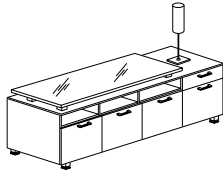

right shown

- freestanding
- 23 ¼"d frosted glass top - screen print on underside
- 1 pencil/hinge door pedestal with adjustable shelf, 18"w
- 3 hinge door pedestals center, 18"w
- 3 technology cubbies, 18"w
- wire management cut-outs in back panel
- aluminum spacers included
- credenza lamp
- telescopic feet
- locking drawer not available
- locking doors available, specify and add \$369 list
- wood top, deduct \$245 list - species and finish will match chassis

### To Order, Specify:

- ① Model Number
- ② Wood Species on Chassis- Cherry (CH1), Maple (MA1) or Walnut (WA1), (see page 395)
- ③ Finish Color for Chassis (see page 395)
- ④ Finish Color for Door/Drawer Fronts
  - A. Same as Chassis
  - B. Paint Color (see page 395)
- ⑤ Glass Door Option (see page 400)

Description	D	W	H	CTN WT	CU FT	① Model	List Price
-------------	---	---	---	-----------	----------	---------	------------

### 72" w Technology Console

24	72	24 ¾	270	34	<b>MD0FCSD-2472</b>	<b>\$6,337</b>
----	----	------	-----	----	---------------------	----------------

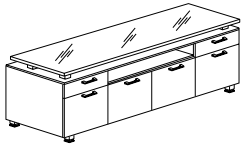

- freestanding
- 23 ¼" d frosted glass top - screen print on underside
- 2 pencil/hinge door pedestals with adjustable shelves, 18" w
- 2 hinge door pedestals center, 18" w
- 1 technology cubby, 18" w
- wire management cut-outs in back panel
- aluminum spacers included
- telescopic feet
- locking drawers not available
- locking doors available, specify and add \$369 list
- wood top, deduct \$326 list - species and finish will match chassis

### 54" w Technology Console

24	54	24 ¾	216	26	<b>MD0FCSOR-2454</b>	<b>\$5,732</b>
24	54	24 ¾	216	26	<b>MD0FCSOL-2454</b>	<b>\$5,732</b>

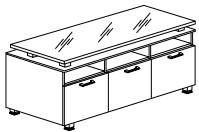

left shown

- freestanding
- 23 ¼" d frosted glass top - screen print on underside
- 3 hinge door pedestals, 18" w
- 3 technology cubbies 18" w
- wire management cut-outs in back panel
- aluminum spacers included
- telescopic feet
- locking doors available, specify and add \$369 list
- wood top, deduct \$245 list - species and finish will match chassis

### Low Platform

24	24	26 ½	53	11	<b>MD0SOL1R-2424</b>	<b>\$1,955</b>
24	24	26 ½	53	11	<b>MD0SOL1L-2424</b>	<b>\$1,955</b>

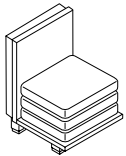

shown with optional cushions

- freestanding
- telescopic feet
- attachment determines left or right
- cushions available, see next page

Description	D	W	H	CTN WT	CU FT	① Model	List Price
Low Technology Console	24	72	26 ½	175	27	MD0FCLO-2472	\$4,967

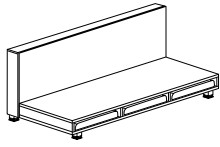

shown with optional cushions

- freestanding
- 3 technology cubbies
- wire management cut-outs
- telescopic feet
- cushions available, see below

Low Technology Console	24	66	26 ½	162	25	MD0FCLO-2466	\$4,516
	24	60	26 ½	148	22	MD0FCLO-2460	\$3,792

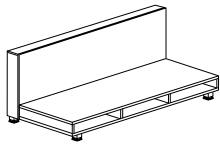

- freestanding
- 3 technology cubbies
- wire management cut-outs
- telescopic feet
- cushions available (will fit two cushions with a space in between), see below

Description	D	W	H	CTN WT	CU FT	① Model	List Price Per Grade
Cushion for Low Console	19 ¼	21 ¾	4	12	2	COL2424CUSH	COM \$352
							A \$367
							B \$389
							COL/C \$430
							D \$482
							E \$536
							F \$620
							G \$708
							H \$800
							I \$950
							J \$1,126
							L1 \$774
							L2 \$879

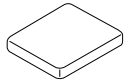

- com ydg: 1
- col sq ft: 18

**To Order, Specify:**

**Low Console**

- ① Model Number
- ② Wood Species on Chassis- Cherry (CH1), Maple (MA1) or Walnut (WA1), (see page 395)
- ③ Finish Color for Chassis (see page 395)
- ④ Finish Color for Door/Drawer Fronts
  - A. Same as Chassis
  - B. Paint Color (see page 395)

**Low Platform and Low Technology Console**

- ① Model Number
- ② Wood Species on Top - Cherry (CH1), Maple (MA1) or Walnut (WA1), (see page 395)
- ③ Finish Color for Top (see page 395)
- ④ Finish Color for Back Panel
  - A. Same as Top
  - B. Paint Color (see page 395)

**Cushion**

- ① Model Number
- ② Fabric - vendor, pattern, color

Description	D	W	H	CTN WT	CU FT	① Model	List Price
Asymmetric Hinged Door Storage	24	34 ½	29	172	19	MD0AHD1R-2435	\$2,594
	24	34 ½	29	172	19	MD0AHD1L-2435	\$2,594

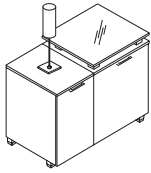

left shown with optional lamp

- freestanding
- 23 ¼" d frosted glass top - screen print on underside
- credenza lamp
- lamp end determines left or right
- wire management cut-out in pedestal opposite door hinge
- telescopic feet
- locking doors available, specify and add \$246 list
- wood top, deduct \$191 - species and finish will match chassis

34 ½" w Hinged Door Storage	24	34 ½	29	179	19	MD0FHD1R-2435	\$2,291
	24	34 ½	29	179	19	MD0FHD1L-2435	\$2,291

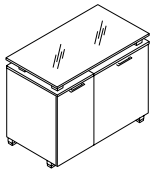

left shown

- freestanding
- 23 ¼" d frosted glass top - screen print on underside
- wire management cut-out in pedestal opposite door hinge
- telescopic feet
- locking doors available, specify and add \$246 list
- wood top, deduct \$249 - species and finish will match chassis

20 ½" w Hinged Door Storage	24	20 ½	29	130	12	MD0FHD1R-2420	\$1,796
	24	20 ½	29	130	12	MD0FHD1L-2420	\$1,796

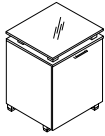

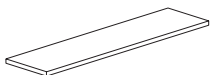

- freestanding
- 23 ¼" d frosted glass top - screen print on underside
- wire management cut-out in pedestal opposite door hinge
- hinge determines left or right
- telescopic feet
- locking door available, specify and add \$123 list
- wood top, deduct \$191 - species and finish will match chassis

Wall Mount Storage Shelves	8	72	1 ¼	20	1	MD0WSS1-0872	\$1,263
	8	66	1 ¼	19	1	MD0WSS1-0866	\$1,175
	8	60	1 ¼	17	1	MD0WSS1-0860	\$1,052
	8	54	1 ¼	16	1	MD0WSS1-0854	\$884

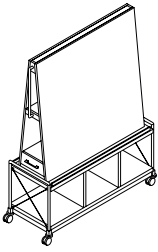

- mounting hardware included

Description	D	W	H	CTN WT	CU FT	① Model	List Price Per Grade
<b>Mobile Marker Board</b>	20	51 ½	71 ¾	227	50	<b>MD0MMB1-2052</b>	<b>COM \$11,570</b>
 <ul style="list-style-type: none"> <li>· 48" x 48" porcelain enamel marker board</li> <li>· 48" x 48" tackable surface</li> <li>· handles for easy mobility</li> <li>· thumbs screws for flip chart</li> <li>· frame is arctic silver</li> <li>· 8 ½" x 16" wood drawer boxes on each side</li> <li>· three lower open compartments</li> <li>· X-shaped steel cables on sides</li> <li>· two locking/two non-locking casters</li> <li>· com ydg: 1 ¾</li> </ul>							A \$11,593
							B \$11,632
							C \$11,703
							D \$11,798
							E \$11,890
							F \$12,035
							G \$12,188
							H \$12,357
							I \$12,612
							J \$12,922

Description	D	W	H	CTN WT	CU FT	① Model	List Price
<b>Mobile Serving Cart</b>	19	35 ⅝	38 ¼	88	18	<b>MD0MCS1-1936</b>	<b>\$7,871</b>
 <ul style="list-style-type: none"> <li>· handles for easy mobility</li> <li>· frame is arctic silver</li> <li>· top and bottom fixed shelves</li> <li>· one adjustable shelf</li> <li>· X-shaped steel cables on sides</li> <li>· two locking/two non-locking casters</li> </ul>							

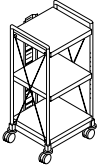
Description	D	W	H	CTN WT	CU FT	① Model	List Price
<b>Mobile Technology Cart</b>	15	17 ⅜	38 ¼	32	8	<b>MD0MCT1-1517</b>	<b>\$7,085</b>
 <ul style="list-style-type: none"> <li>· handles for easy mobility</li> <li>· frame is arctic silver</li> <li>· top and bottom fixed shelves</li> <li>· one adjustable shelf</li> <li>· vertical wire management channel on back</li> <li>· X-shaped steel cables on sides</li> <li>· two locking/two non-locking casters</li> </ul>							

### To Order, Specify:

#### Storage Units

- ① Model Number
- ② Wood Species on Top/Chassis- Cherry (CH1), Maple (MA1) or Walnut (WA1), (see page 395)
- ③ Finish Color for Top/Chassis (see page 395)
- ④ Finish Color for Door Fronts
  - A. Same as Top
  - B. Paint Color (see page 395)

#### End Display Unit

- ① Model Number
- ② Wood Species - Cherry (CH1), Maple (MA1) or Walnut (WA1), (see page 395)
- ③ Finish Color (see page 395)
- ④ Fabric - vendor, pattern, color





Desks . . . . .	444
Modesty Panels . . . . .	444
Returns and Bridges . . . . .	452
Credenzas . . . . .	457
Overhead Cabinets . . . . .	460
Tackboards . . . . .	464
Tool Rail Accessories . . . . .	470
Wall Mount Storage . . . . .	471
Storage Towers . . . . .	480
Transaction Counters . . . . .	489
Bookcases . . . . .	490
Lateral Files . . . . .	491
Vertical Storage Units . . . . .	492
Freestanding Tables . . . . .	496

## Finale - Overview

### Desks



**Bow Front Double Pedestal Desk**  
Page 444



**Double Pedestal Desk**  
Page 444



**Electric Adjustable Height Table Desk**  
Page 446



**Pneumatic Adjustable Height Table Desk**  
Page 446

### Modesty Panels

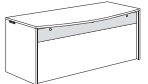

**Glass Trim Modesty Panel**  
Page 444

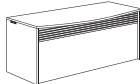

**Metal Trim Modesty Panel**  
Page 444

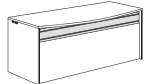

**Metal/Glass Trim Modesty Panel**  
Page 445

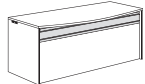

**Metal/Veneer Trim Modesty Panel**  
Page 445



**Metal Trim Modesty Panel**  
Page 448



**Metal/Glass Trim Modesty Panel**  
Page 448



**Metal/Veneer Trim Modesty Panel**  
Page 448

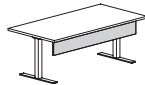

**Adjustable Height Table Modesty Panel**  
Page 446

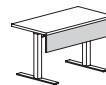

**Adjustable Height Bridge Modesty Panel**  
Page 456

### Table Desks



**Metal Frame Table Desk with Glass Top**  
Page 447



**Metal Frame Table Desk with Veneer Top**  
Page 447



**Metal Frame Table Desk for COM Top**  
Page 447

### Desk Applications



**Bow Front Single Pedestal Desk**  
Page 449



**Single Pedestal Desk**  
Page 449

### Peninsula Desks

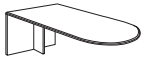

**Bullet Peninsula Desk**  
Page 450

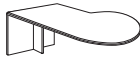

**P-Top Peninsula Desk**  
Page 450

### Peninsula Desk Bases and Modesty Panels

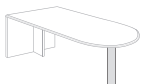

**Column Base**  
Page 451

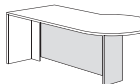

**Full Modesty Panel**  
Page 451

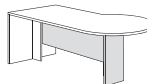

**3/4 Modesty Panel**  
Page 451

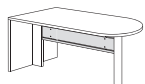

**Metal/Glass Trim Modesty Panel**  
Page 451

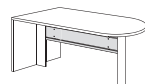

**Metal/Veneer Trim Modesty Panel**  
Page 451



## Finale - Overview

### Return Applications



File/File Return  
Page 452



Lateral File Return  
Page 452



Multi-File Return  
Page 452



File/File Corner  
Return  
Page 454



Lateral File Corner  
Return  
Page 454



Multi-File Corner  
Return  
Page 454



Executive Corner  
Unit  
Page 453

### Bridge Applications

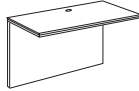

Bridge with Modesty Panel  
Page 455

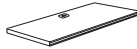

Bridge Top  
Page 455

### Adjustable Height Bridge



Electric Adjustable  
Height Bridge  
Page 456

### Credenza and Lateral Files

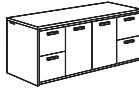

Storage Credenza  
Page 457



Lateral File Credenza  
Page 457

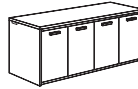

Four Door Credenza  
Page 457



Two Door Credenza  
Page 457

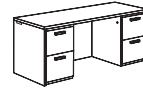

Kneespace Credenza  
Page 458



Buffet Credenza  
Page 458



Pedestal Credenza  
Page 458



File/File Reception  
Credenza  
Page 458



Lateral Pedestal  
Credenza  
Page 459



Multi-File Pedestal  
Credenza  
Page 459

### Printer Stand



Printer Stand  
Page 459

### Corner Unit

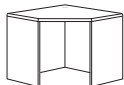

Corner Unit  
Page 459

# Finale - Overview

## Overhead Cabinets



Double Height Storage Overhead Cabinet with Four Doors  
Page 460



Double Height Storage Overhead Cabinet with Four Glass Doors  
Page 460



Double Height Storage Overhead Cabinet with Four Doors and Cubbies  
Page 461



Double Height Storage Overhead Cabinet with Four Glass Doors and Cubbies  
Page 461

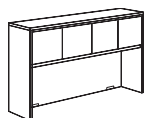

Storage Overhead Cabinet with Four Doors  
Page 462

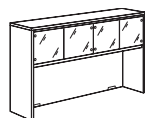

Storage Overhead Cabinet with Four Glass Doors  
Page 462



Storage Overhead Cabinet with Four Doors and Cubbies  
Page 463

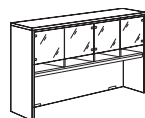

Storage Overhead Cabinet with Four Glass Doors and Cubbies  
Page 463



Open Storage Overhead Cabinet  
Page 462



Open Storage Overhead Cabinet with Cubbies  
Page 463

## Tackboards

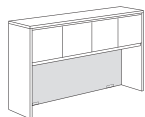

Tackboard for Storage Overhead Cabinet  
Page 464

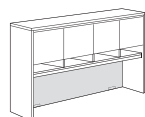

Tackboard for Storage Overhead Cabinet with Cubbies  
Page 465 & 466

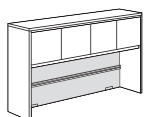

Accessory Rail Tackboards for Storage Overhead Cabinets  
Page 467

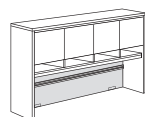

Accessory Rail Tackboards for Storage Overhead Cabinets with Cubbies  
Page 468

## Accessories

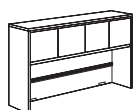

Accessory rail  
Page 469



Upright tray  
Page 470



Small tray  
Page 470



Pencil tray  
Page 470



Paper tray  
Page 470



File hanger  
Page 470



Acrylic Accessory Tray  
Page 470



Center drawer  
Page 500

## Wall Mount Storage

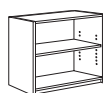

Double Height Wall Mount Open Overhead Cabinet  
Page 471

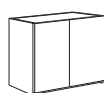

Double Height Wall Mount Overhead Cabinet with Two Doors  
Page 471



Double Height Wall Mount Overhead Cabinet with Two Glass Doors  
Page 471



Double Height Wall Mount Open Overhead Cabinet with Cubbies  
Page 472



Double Height Wall Mount Overhead with Two Doors and Cubbies  
Page 472



Double Height Wall Mount Overhead with Two Glass Doors and Cubbies  
Page 472

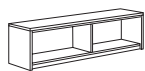

Wall Mount Open Overhead  
Page 473



Wall Mount Open Overhead  
Page 473

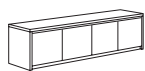

Wall Mount Overhead Cabinet with Four Doors  
Page 473



Wall Mount Overhead Cabinet with Two Doors  
Page 473

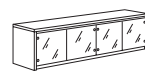

Wall Mount Overhead Cabinet with Four Glass Doors  
Page 474



Wall Mount Overhead Cabinet with Two Glass Doors  
Page 474

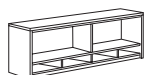

Wall Mount Open Overhead with Cubbies  
Page 474



Wall Mount Open Overhead with Cubbies  
Page 474

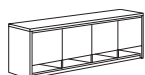

Wall Mount Overhead Cabinet with Four Doors and Cubbies  
Page 475



Wall Mount Overhead Cabinet with Two Doors and Cubbies  
Page 475

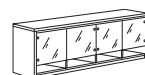

Wall Mount Overhead Cabinet with Four Glass Doors and Cubbies  
Page 475



Wall Mount Overhead Cabinet with Two Glass Doors and Cubbies  
Page 475

# Finale - Overview

## Tackboards

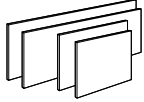

Wall Mount Tackboards  
Pages 476-477

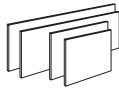

Wall Mount Tackboards for  
Overhead Cabinets with Cubbies  
Pages 478-479

## Storage Towers



Double Height Open  
Storage Tower  
Page 480



Double Height Storage  
Tower with 54" h Door  
Page 480



Double Height Storage  
Tower with 54" h  
Glass Door  
Page 480



Double Height Open  
Storage Tower  
Page 481

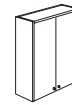

Double Height Storage  
Tower with Two 54" h  
Doors  
Page 481



Double Height Storage  
Tower with Two 54" h  
Glass Doors  
Page 481



Open Storage Tower  
Page 482



Storage Tower with  
42" h Door  
Page 482



Storage Tower with  
42" h Glass Door  
Page 482



Open Storage Tower  
Page 483



Storage Tower with Two  
42" h Doors  
Page 483



Storage Tower with Two  
42" h Glass Doors  
Page 483



Bookcase Overhead  
Page 484



Storage Tower  
Page 484



Glass Door Storage  
Tower  
Page 484

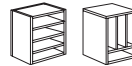

Storage Tower  
Page 482



Double Height Bridge  
Mount Open Overhead  
Cabinet  
Page 485



Double Height Bridge  
Mount Overhead  
Cabinet with Two Doors  
Page 485



Double Height Bridge  
Mount Overhead Cabinet  
with Two Glass Doors  
Page 485

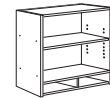

Double Height Bridge  
Mount Open Overhead  
Cabinet and Cubbies  
Page 486

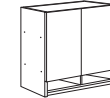

Double Height Bridge  
Mount Overhead Cabinet  
with Two Doors and Cubbies  
Page 486



Double Height Bridge Mount  
Overhead Cabinet with Two  
Glass Doors and Cubbies  
Page 486



Bridge Mount  
Open Overhead  
Page 487



Bridge Mount Overhead  
Cabinet with Two Doors  
Page 487



Bridge Mount Overhead  
Cabinet with Two  
Glass Doors  
Page 487



Bridge Mount Open  
Overhead with Cubbies  
Page 488



Bridge Mount Overhead  
Cabinet with Two Doors  
and Cubbies  
Page 488



Bridge Mount Overhead  
Cabinet with Two Glass  
Doors and Cubbies  
Page 488



Modular Cabinet Top  
Page 488

## Transaction Counters

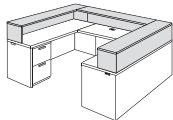

Transaction Counter  
Page 489

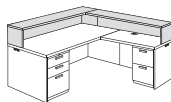

Transaction Counter  
Page 489



Transaction Counter  
Page 489

# Finale - Overview

## Bookcases

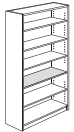

Bookcase  
Page 490

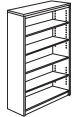

Bookcase  
Page 490

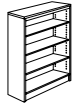

Bookcase  
Page 490



Bookcase  
Page 490



Bookcase  
Page 490

## Lateral Files



Lateral File  
Page 491



Lateral File  
Page 491



Lateral File  
Page 491



Mobile Pedestal  
Page 491

## Storage Cabinets

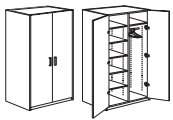

84" h Wardrobe  
Page 492



72" h Wardrobe  
Page 492



Hanging Bar to Shelves  
Conversion Kit  
Page 492

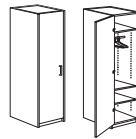

84" h Wardrobe  
Page 493



72" h Wardrobe  
Page 493

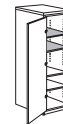

Hanging Bar to Shelves  
Conversion Kit  
Page 493

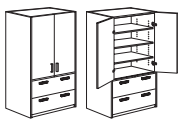

84" h File/File Lateral  
Storage Cabinet  
Page 494



72" h File/File Lateral  
Storage Cabinet  
Page 494

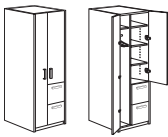

84" h File/File  
Storage Wardrobe  
Page 494



72" h File/File  
Storage Wardrobe  
Page 494



Modular Wardrobe Top  
Page 495

# Finale - Overview

## Magazine Table

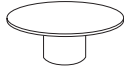

Round Magazine Table  
Page 496

## Tables



Sofa Table  
Page 497



Magazine Table  
Page 497



End Table  
Page 497



End Table  
Page 497



Metal Frame End Table with Glass Top  
Page 498



Metal Frame End Table with Veneer Top  
Page 498



Metal Frame End Table for COM Top  
Page 498



Metal Frame Magazine Table with Glass Top  
Page 499



Metal Frame Magazine Table with Veneer Top  
Page 499



Metal Frame Magazine Table for COM Top  
Page 499



Metal Frame Magazine Table with Glass Top  
Page 500



Metal Frame Magazine Table with Veneer Top  
Page 500



Metal Frame Magazine Table for COM Top  
Page 500



Corner Table  
Page 497

## Task Lights



48" w Task Light  
Page 532



24" w Task Light  
Page 532



31" w LED Starter Task Light  
Page 532



31" w LED Linking Adder Task Light  
Page 532



17" w LED Starter Task Light  
Page 533



17" w LED Linking Adder Task Light  
Page 533



Motion Sensor for Task Lights  
Page 533

# Finale Product Information

## Exterior Wood Materials

Exterior surfaces are made from the finest selected veneers to achieve clarity and consistency in the Finale product line. To attain a pleasing, symmetrical pattern, all veneers in Finale are book-matched. All exterior solid lumber is matched to coordinate with the veneer.

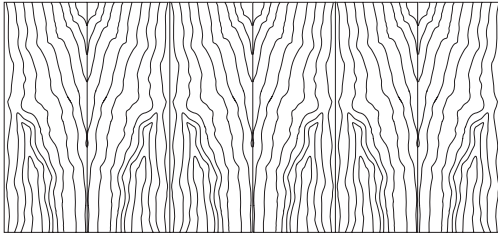

### Book Matched Example

Alternating pieces of veneer are flipped over so they face each other like the pages within a book

Finale is available in flat cut cherry, maple and walnut veneer. A wide range of wood stains have been formulated to enhance the beauty of the veneer.

Cherry veneer is the only veneer species available on the **NOW!** quickship program on select models.

## Work Surface Construction

Tops are 5-ply balanced construction, 1 3/16" thick with solid matching hardwood edges. Surfaces are available in wood veneer or high pressure laminate. No additional charge for using our coordinating high pressure laminate with a veneer grain pattern.

## Case Construction

Outside panels are 1 3/16" and joined together by mortise and tenon construction. In addition to mortise and tenon joint construction, pedestal joints are reinforced with screws, cleats, brackets and glue. Leveling glides are set into solid hardwood blocks with t-nut inserts, which helps to prevent the leveling glide from tear out. Tops are secured to the chassis with top fastening cleats screwed to the inside of the panels.

Cabinet doors have 110° swing hinges to allow adequate access into the interior of the cabinet.

## Drawers

The 9ply unidirectional hardwood sides of the drawer box are 7/16" thick assembled with English dovetail construction at each corner of the box. The drawer bottom panel is 1/4" thick fitting into a groove machined the into side of the box. Interiors are sanded and coated with clear U.V. finish to protect against shrinking, swelling or warping, and to provide a clean, smooth feel and appearance.

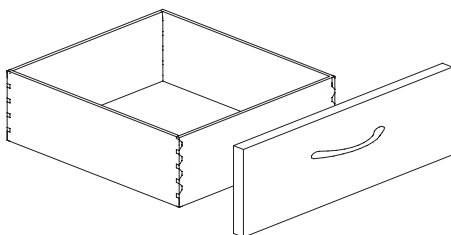

## Drawer Suspension

The high quality black drawer suspensions carry a lifetime warranty. Slides feature steel ball bearings for longer life with cushioned in /out stops. File and box drawers have 100% full extension with over travel.

## Filing Hardware

All file drawers are constructed with a custom designed filing system in place to allow for hanging folders. Filing diagram on pages 437-439.

## Locking

All desks, credenzas and returns feature pedestal locking and lateral files feature central locking to provide maximum security and flexibility.

Units are shipped randomly keyed as standard (units in the grouping are keyed alike). Keyed alike units available if requested at no upcharge. Removable cores for in-field re-keying are standard.

## Finish - Stain/Colors

We offer a variety of wood stains and paint colors on Finale. Please see the chart below. Samples are available upon request.

<b>CH1 Cherry</b>		<i>Flat Cut Veneer</i>	
BRL Barley	EAR Earthy		
BBM Bourbon Medium	HRV Harvest*		
BRM Brighton Medium	LGC Legacy		
CLA Classic	PRL Praline*		
CLL Collectors*	SAF Saffron		

<b>MA1 Maple</b>		<i>Flat Cut Veneer</i>	
ALM Ale Medium	FLX Flax		
BUT Butterscotch	VEN Venetian		
CIN Cinnamon			

<b>WA1 Walnut</b>		<i>Flat Cut Veneer</i>	
AUB Auburn	SIE Sienna		
ESP Espresso	TOF Toffee		
MCH Mocha	TRF Truffle		
NTO Night Owl			

\*finishes with coordinating laminate tops.

## Protective Top Coat

DuraTex™ offers exceptional hardness along with abrasion and impact resistance, it has been formulated to eliminate hazardous and harmful gases that are normally associated with wood finish.

## DuraTex™ Features

**Safety** - Significantly reduces hazardous formaldehyde emissions which help improve the quality of the of the indoor air we breathe.

**Quality** - Developed to be tough and durable with special attention to appearance. The DuraTex™ finish preserves the natural beauty of wood.

**Durability** - Designed to meet a wide range of demanding performance and environmental standards to withstand even the highest wear and tear.

# Finale Product Information

## Product Modification

### Laminate Tops

Worksurface only, no additional upcharge if coordinating wood grain laminate is specified. Contact Customer Service for any other laminate request. Listed below are finishes that have coordinating wood grain HPL laminates.

Cherry Finishes	Maple Finishes	Walnut Finishes
<i>Barley</i>	<i>Ale Light</i>	<i>Auburn</i>
<i>Bourbon Light</i>	<i>Cinnamon</i>	<i>Mocha</i>
<i>Brighton Light</i>	<i>Venetian</i>	<i>Night Owl</i>
<i>Classic</i>		<i>Sienna</i>
<i>Collectors</i>		<i>Toffee</i>
<i>Harvest</i>		<i>Truffle</i>
<i>Legacy</i>		
<i>Praline</i>		
<i>Saffron</i>		

### Special Finishes

Special finishes can be requested by following the instruction in the general introduction section, page 5. There is a one time charge of \$321 list per order.

### Species Change

For species changes contact customer service for a quote.

### Pedestal Configuration Change

Box-box-file configuration is standard on all desks and file-file configuration is standard on all return units.

Finale drawer configuration on pedestals 27" to 30" high can be switched out either to a box-box-file or file-file configuration, but must be specified at the time of order with an additional \$162 list per pedestal.

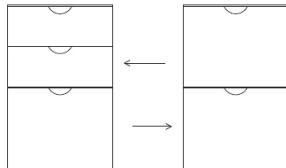

### Writing Shelf - Pullout (Arm Slide)

Desk Pedestals in Finale can have an optional pullout shelf above the top drawer for additional writing surface. Add \$301 to the list for each pedestal.

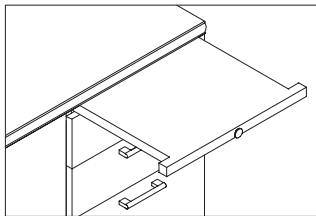

## Special Sizes from Standard Offering

The following chart contains pricing for general modifications to Finale. **All modifications still must be approved by JSI manufacturing,** please contact Customer Service to verify any of the modifications listed in the chart below. More complex modification to standard product may be possible, please refer to page 5 for additional details.

**This chart does not apply to glass doors, glass tops or to metal components; such as modesty trims panels, and structural support. Any changes to file drawers will affect filing capabilities.**

**Increasing Dimensions** - Add On to the list Per 6" Occurrence

#### Overhead

Increasing width	\$829
Increasing depth	\$1,415
Increasing width with doors	\$982
Increasing depth with doors	\$1,514

#### Any Pedestal

Increasing width	\$1,177
Increasing depth	\$1,050

#### Any Panel

Increasing width	\$268
------------------	-------

#### Any Top

Increasing width	\$349
Increasing depth	\$493

**Decreasing Dimensions** Add On to the list Per 6" Occurrence

#### Overhead

Decreasing width	\$253
Decreasing depth	\$253
Decreasing width with doors	\$346
Decreasing depth with doors	\$346

#### Any Pedestal

Decreasing width	\$1,094
Decreasing depth	\$977

#### Any Panel

Decreasing width	\$129
------------------	-------

#### Any Top

Decreasing width	\$190
Decreasing depth	\$190

### Example 1

Increasing open corner credenza width by 11", from 72" to 83".

Add Top Width (\$349 × 2) [\$349 for each 6" increment]

Add Panel Width (\$268 × 2) [\$268 for each 6" increment]

Total Modification = \$1,234

### Example 2

Increasing a desk pedestal depth from 36" to 40" & increase the width of the same pedestal by 8"

Add Pedestal Depth \$1,050

Add Pedestal Width (\$1,177 × 2) [\$1,177 for each 6" increment]

Total Modification = \$3,404

### Example 3

Decreasing an overhead from 60" to 58" width & increasing the depth by 3"

Decrease Overhead Width \$253

Add Overhead Depth \$1,415

Total Modification = \$1,668

## Finale Product Information

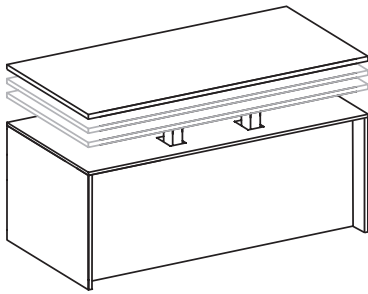

### ERGO Adjustable Work Height Mechanism

Our proprietary adjustable work height mechanism can be specified on many of the models in Finale.

ERGO mechanism allows height adjustability to be added to the worksurface. Our solution uses a standardized design that minimizes the modifications required to standard desk, bridge or credenza models. The mechanism and control box are neatly concealed to maintain the appearance of the original elegance of the product. A push button activates the electric powered lifting columns for adjustability from sitting height to a standing height. A ¾" thick finished sub top is added to the top of the desk chassis for a clean appearance when the surface is in the raised position. In the lowered position, please note that ERGO adds ¾" to the standard height of the desk and the installation will decrease kneespace depth by 8".

Automatic Collision Control is built in to each mechanism as a standard feature. When the system senses an obstacle obstructing the movement, the mechanism will reverse direction and retreat by 1".

When ERGO is added to a worksurface in an "L" or "U" group, all units in the configuration need to have a sub top added. These units are considered to be ERGO ADJACENT units. ERGO ADJACENT units must have a fixed height worksurface that matches the lowest position of the ERGO mechanism and the top. This is accomplished by adding a ¾" sub top between the chassis and the worksurface. This feature can also be specified for cabinets which may sit next to a unit with the ERGO mechanism.

Height adjustment starts at 30 ¼", to a standing height of 49 ¾", a range of 19 ½".

**Note:** The kneespace depth is decreased when the ERGO mechanism is specified. Contact Customer Service for dimension information.

The ERGO mechanism and controls are warranted for a period of (1) year. The rest of the casegood unit(s) are warranted under the normal fifteen (15) year warranty.

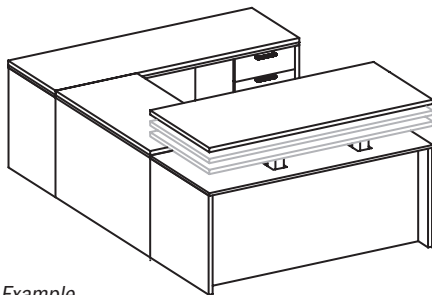

Example

FN3672LD (with ERGO option) add \$4,223 to list  
 FN2448EB (with ERGO ADJACENT option) add \$542 to list  
 FN2472RC (with ERGO ADJACENT option) add \$635 to list

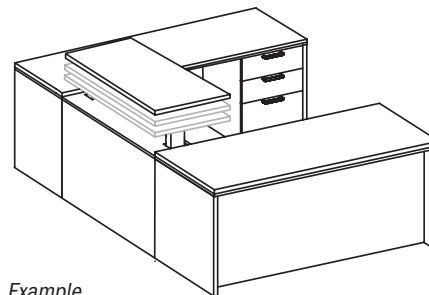

Example

FN3672LD (with ERGO ADJACENT option) add \$635 to list  
 FN2448EB (with ERGO option) add \$4,223 to list  
 FN2472RC (with ERGO ADJACENT option) add \$635 to list

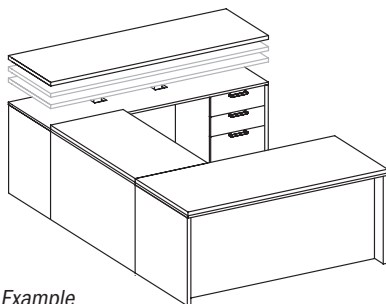

Example

FN3672LD (with ERGO ADJACENT option) add \$635 to list  
 FN2448EB (with ERGO ADJACENT option) add \$542 to list  
 FN2472RC (with ERGO option) add \$4,223 to list

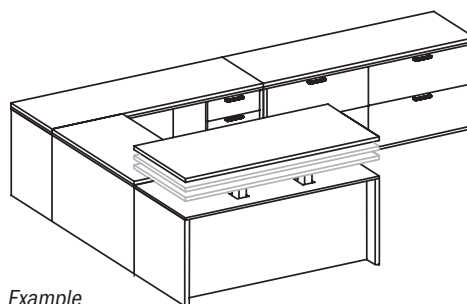

Example

FN3672LD (with ERGO option) add \$4,223 to list  
 FN2448EB (with ERGO ADJACENT option) add \$542 to list  
 FN2472RC (with ERGO ADJACENT option) add \$635 to list  
 FN2472LFC (with ERGO ADJACENT option) add \$635 to list



## Finale Product Information

### Availability of Finale Units with the Mechanism

The following models are available with the ERGO Adjustable Work Height Mechanism.

**Freestanding Units** - Units below do not require adjacent products; select ERGO option and add \$4,223 to the list price.

<u>Double Pedestal Desk</u>	<u>Credenzas</u>
FN4272BD	FN2472KC
FN3672DD	FN2466KC
FN3072DD	
FN3066DD	
FN3060DD	

**Adjacent Connecting Units** - Select ERGO option for the model you wish to have height adjustment and add \$4,223 to the list price. For units, from this list, that are connecting to the ERGO model, you must select ERGO ADJACENT on each of these connecting models and add \$635 list to each model. \*If the connecting model is 24"x 48" or less, add \$542 list.

<u>Single Pedestal Desk</u>	<u>Returns</u>	<u>Bridges</u>	<u>Credenzas</u>	<u>Corner Units</u>
FN4272RBD	FN2448ERR*	FN2448EB*	FN2472RC	FN4242ERCU
FN4272LBD	FN2448ELR*	FN2442EB*	FN2472LC	FN4242ELCU
FN3672RD	FN2442ERR*	FN2436EB*	FN2466RC	FN4242CU
FN3672LD	FN2442ELR*		FN2466LC	
FN3072RD	FN2448ERCR*			
FN3072LD	FN2448ELCR*			
FN3066RD	FN2442ERCR*			
FN3066LD	FN2442ELCR*			

# Finale Product Information

## Layouts

Two heights of storage overheads are available in Finale.

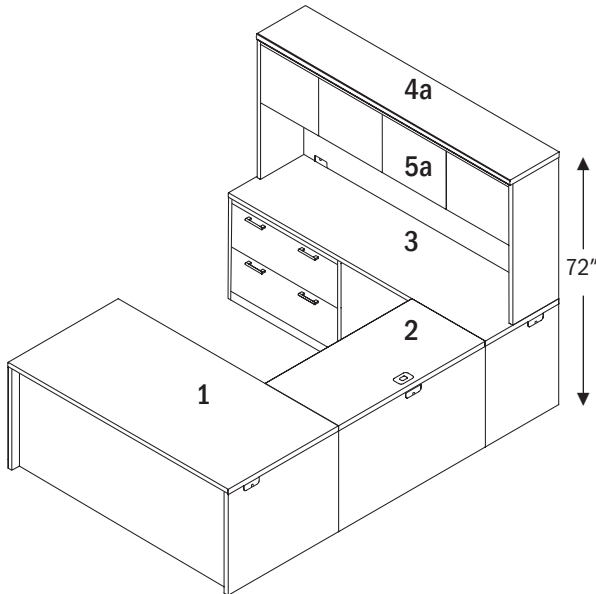

Finale is an easily specified contemporary product line, with standard office furniture sizes.

**Easily specified and setup while providing well established layouts in the office environment.**

- 1 Single Pedestal Desk**, with the standard box, box, file pedestal configuration and side locking. Standard side grommet keeps the desk top clean from wires, while still having convenient wire management.
- 2 Bridge** standard with top and back panel grommet and mounting hardware.
- 3 Lateral File Credenza** available with fixed back panel.
- 4a Cabinet Top** is a standard feature on 42" high overhead cabinets.
- 4b Modular Cabinet Top** (not shown in diagram) is an option on 54" high overhead cabinet. These tops are ordered separately.
- 5a Overhead Cabinet** height is 42" for an overall height 72"  
Standard with left and right grommets on the back panel. Models are available with frameless glass doors in white back painted. (Locks and pulls are not available with glass doors). Models with installed cubbies are also available.
- 5b Overhead Cabinet** height is 54" for an overall height 84"  
(add 1 3/16" if specifying modular cabinet tops). Standard with left and right grommets on the back panel. Shown with frameless white back painted glass doors. (Locks and pulls are not available with glass doors) Models are also available in wood doors.

**Note:** Tackboard or panels can be ordered for the inside back of the overhead cabinet, along with the accessory rails.

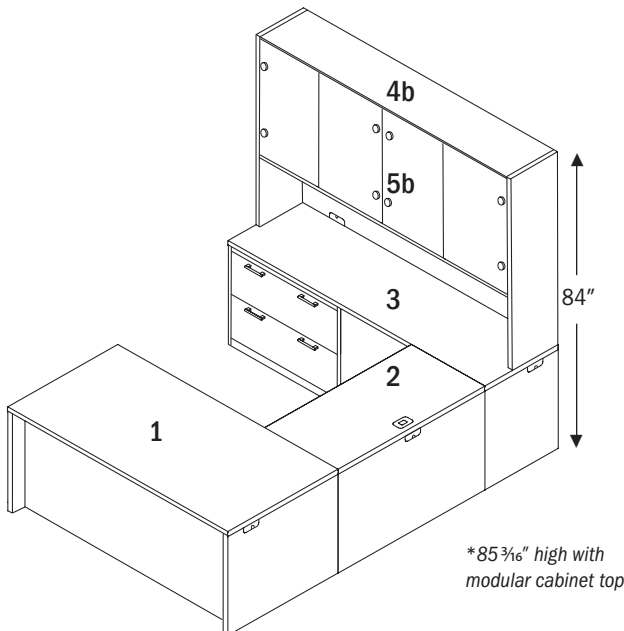

**Modular Cabinet Tops**  
Overhead Cabinets 54" tall do not come with modular cabinet tops. Tops can be specified and ordered separately. To maintain the same finish height on all units, specify tops for **ALL** adjacent units.

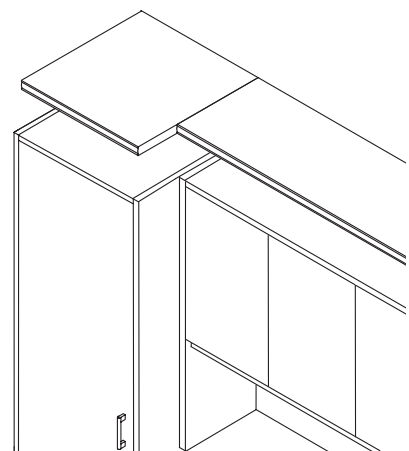

Frameless opaque glass doors in white back painted brings a nice aesthetic to the Finale product line.

# Finale Product Information

## Pull Style and Color Options



**Arch**  
Matte Black (MBK)  
Matte Silver (MSL)

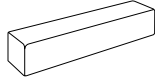

**Block**  
Matte Nickel (MNK)



**Curve**  
Matte Nickel (MNK)



**Twist**  
Matte Nickel (MNK)

## Top Edge Details

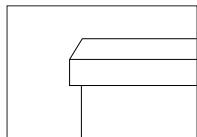

**Bevel (B)**

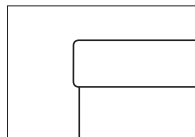

**Eased (R4)**

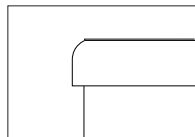

**Gael (G)**

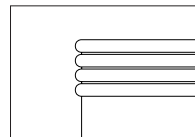

**Reeded (H)**

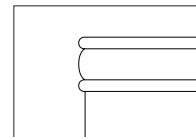

**Transitional (C)**

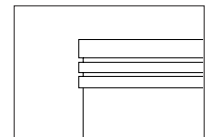

**Triad (F)**

## Top Edge Detail Location

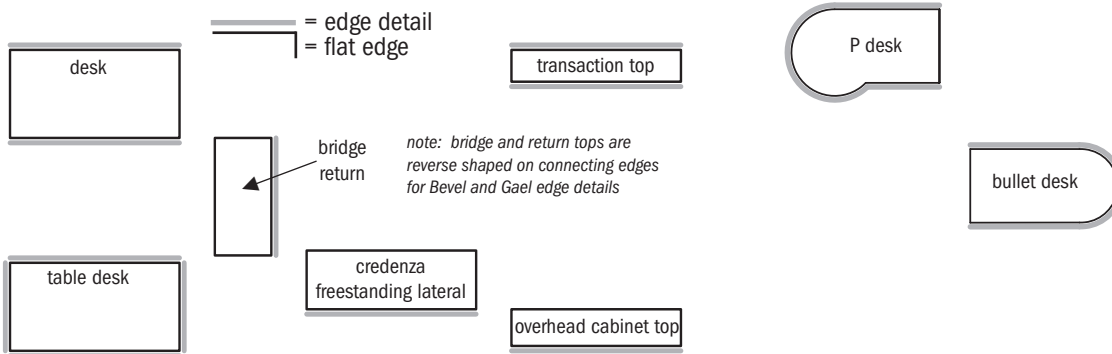

## Standard Grain Direction

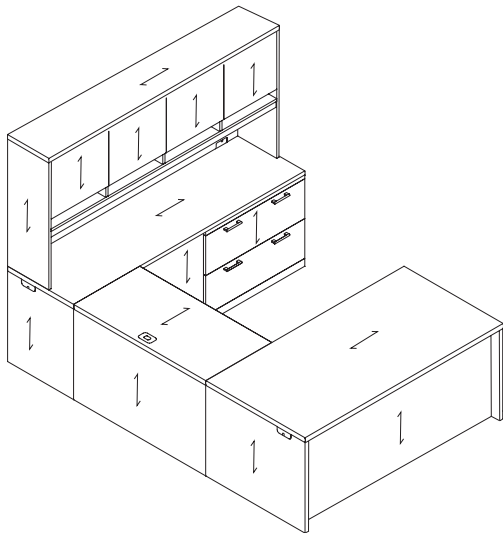

**Note:**

Grain direction on Return and Bridge units run short grain.

Grain on valance rails on overhead cabinet run vertical.

# Finale Product Information

## Grommet and Color Options

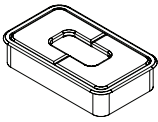

### Worksurface Grommet

Matte Black (MBK)  
Stardust Silver (STS)

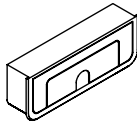

### End Panel Grommet

Matte Black (MBK)  
Stardust Silver (STS)

## Worksurface Grommet Locations

Additional worksurface grommets can be specified on desk, bridges, returns and credenzas. Grommet locations are indicated below with an (A) for left, (B) for center, (C) for right and (D) for center end.

Add \$99 to the list for each additional grommet.

Grommet color must be specified, select Matte Black or Stardust Silver choose one color for all grommets. If no color is selected, grommet color will coordinate with the pull color. Lock cores will coordinate with grommet color

Matte Black (MBK)  
Stardust Silver (STS)

### 36" d Pedestal Desk

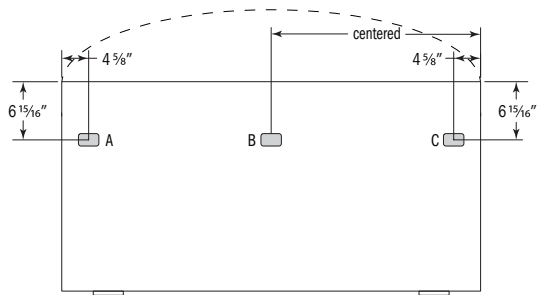

### Support End and Run-Off Desk

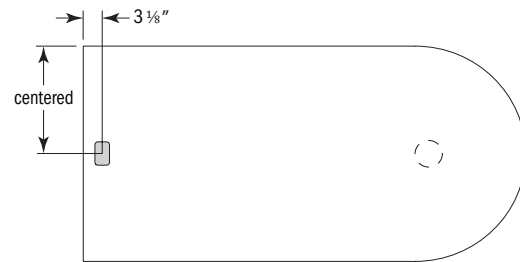

### 30" d Pedestal Desk

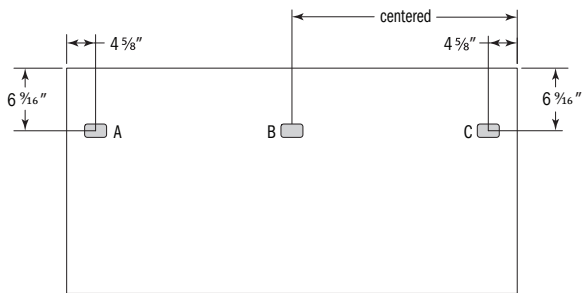

### Bridges, Returns and Credenzas

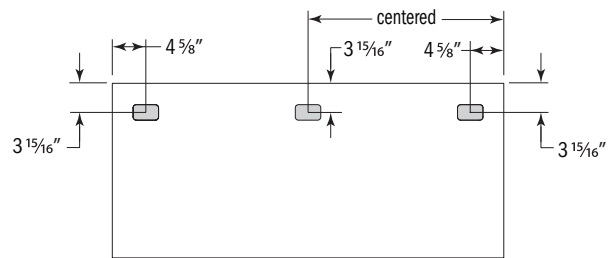

## End/Back Panel Grommet

Finale features grommets and wire pass thru on all of the cabinets. This allows wiring to move from unit to unit or from unit to the data or power source. The end/back panel grommets are standard, for any special consideration contact Customer Service.

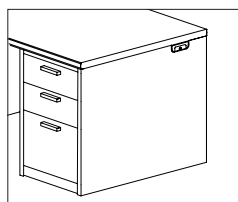

**Desks - Credenza**  
End Panel Grommet

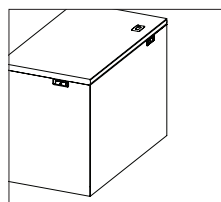

**Returns**  
Work Surface Grommet  
End Panel Grommet  
Back Panel Grommet

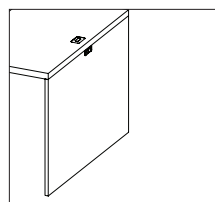

**Bridge**  
Work Surface Grommet  
Back Panel Grommet

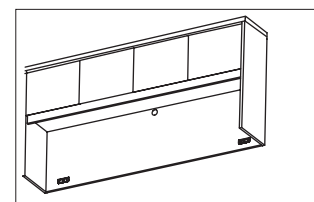

**Overhead Cabinet**  
Back Panel Grommet  
Back Center Pass Thru

**Note:** See the accessory section in this price list for additional wiring and power/data options.

# Finale Product Information

## Product Trim Features and Options

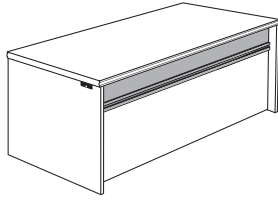

### Trim Modesty Panel

- Decorative metal in 3 finishes
  - Black Sandtex (BSX)
  - Soft Nickel (SNK)
  - Stardust Silver (STS)
- Top panel in
  - Veneer
  - White Back Painted Glass (not low iron)
- Available on
  - Recess Modesty Desks
  - Table Desks
  - Bullet Desk
  - P Style Desk

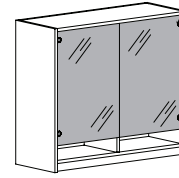

### Glass Doors

- Frameless Tempered Glass
  - Puck Style Hinges
  - Aluminum Color
- Back Painted Glass
  - White (not low iron)
- Available on
  - Overhead Cabinets
  - Storage Towers

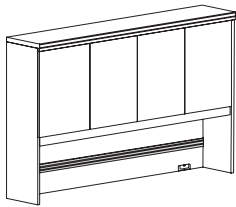

### Aluminum Accessory Rail

- Anodized Aluminum Finish
- Accessory Tools (see page 470)
  - Upright Tray
  - Small Tray
  - Pencil Tray
  - Paper Tray
  - File Hanger

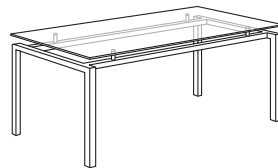

### Table Desk

- Top Surface
  - Clear Glass
  - White Back Painted Glass (not low iron)
  - Veneer
  - COM (*right diagram*)
- Frame Finishes
  - Black Sandtex (BSX)
  - Soft Nickel (SNK)
  - Stardust Silver (STS)

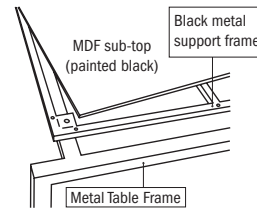

### Customer Supplies Top (COM)

- Table Frame with Support
- Allows for Unique Materials
- Frame Finishes
  - Black Sandtex (BSX)
  - Soft Nickel (SNK)
  - Stardust Silver (STS)

## Finale Product Information

### Finish and Reference Codes - Summary

<b>Select</b>	<b>Code</b>	<b>Select</b>	<b>Code</b>
<b>Veneer</b>			
Cherry	CH1	Bevel	B
Maple	MA1	Eased	R4
Walnut	WA1	Gael	G
<b>Finish</b>			
Cherry Finishes			
Barley	BRL	Reeded	H
Bourbon Medium	BBM	Transitional	C
Brighton Medium	BRM	Triad	F
Classic	CLA	<b>Pull Style and Color</b>	
Collectors	CLL	Arc - Matte Black	MBK
Earthy	EAR	Arc - Matte Silver	MSL
Harvest	HRV	Block - Matte Nickel	MNK
Legacy	LGC	Curve - Matte Nickel	MNK
Praline	PRL	Twist - Matte Nickel	MNK
Saffron	SAF	<b>Grommet Color</b>	
Maples Finishes			
Ale Medium	ALM	Matte Black	MBK
Butterscotch	BUT	Stardust Silver	STS
Cinnamon	CIN	<b>Metal Color</b>	
Flax	FLX	Black Sandtex	BSX
Venetian	VEN	Soft Nickel	SNK
Walnut Finishes			
Auburn	AUB	Stardust Silver	STS
Espresso	ESP	<b>Glass Color</b>	
Mocha	MCH	Clear Glass	
Night Owl	NTO	White Back Painted	
Sienna	SIE		
Toffee	TOF		
Truffle	TRF		

## Finale Product Information

Desk Model	Description	Drawer Configuration (User Side)	
		Left Pedestal	Right Pedestal
FN4272BD	Double Pedestal Bow Desk	Box/Box/File	File/File
FN3672DD	Double Pedestal Desk	Box/Box/File	File/File
FN3072DD	Double Pedestal Desk	Box/Box/File	File/File
FN3066DD	Double Pedestal Desk	Box/Box/File	File/File
FN3060DD	Double Pedestal Desk	Box/Box/File	File/File
FN4272RBD	Right Pedestal Bow Desk		Box/Box/File
FN4272LBD	Left Pedestal Bow Desk	Box/Box/File	
FN3672RD	Right Pedestal Desk		Box/Box/File
FN3672LD	Left Pedestal Desk	Box/Box/File	
FN3072RD	Right Pedestal Desk		Box/Box/File
FN3072LD	Left Pedestal Desk	Box/Box/File	
FN3066RD	Right Pedestal Desk		Box/Box/File
FN3066LD	Left Pedestal Desk	Box/Box/File	

Interior Drawer Dimensions	Depth	Width	Height
Box	21"	11 7/8"	4 1/4"
File	21"	11 7/8"	9 3/8"

### Filing Options



Letter



Letter



Legal

Mobile Pedestals Model	Description	Drawer Configuration
		Single Pedestal Width
FN1820MP	Mobile Pedestal	Box/Box/File

Interior Drawer Dimensions	Depth	Width	Height
Box	21"	14 7/8"	4 1/4"
File	15 1/4"	14 7/8"	9 3/8"

### Filing Options



Legal

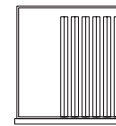

Legal

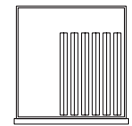

Letter

Executive Returns Model	Description	Drawer Configuration (User Side)	
		Left Pedestal	Right Pedestal
FN2448ERR	Right Executive Return		File/File
FN2448ELR	Left Executive Return	File/File	
FN2442ERR	Right Executive Return		File/File
FN2442ELR	Left Executive Return	File/File	
FN2448ERCR	Right Executive Return		File/File
FN2448ELCR	Left Executive Return	File/File	
FN2442ERCR	Right Executive Return		File/File
FN2442ELCR	Left Executive Return	File/File	

Interior Drawer Dimensions	Depth	Width	Height
File	15 1/4"	11 7/8"	9 3/8"

### Filing Options



Letter

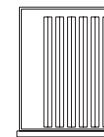

Legal

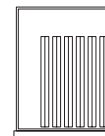

Letter

## Finale Product Information

<b>Executive Returns with Lateral File</b>		Drawer Configuration (User Side)	
Model	Description	Left Pedestal	Right Pedestal
FN2448LRR	Right Lateral Return		2 Lateral Drawers
FN2448LLR	Left Lateral Return	2 Lateral Drawers	
FN2448MRR	Right Multi-File Return		2 Box /File Lateral Drawers
FN2448MLR	Left Multi-File Return	2 Box /File Lateral Drawers	
FN2448LRCR	Right Lateral Return		2 Lateral Drawers
FN2448LLCR	Left Lateral Return	2 Lateral Drawers	
FN2448MRCR	Right Multi-File Return		2 Box /File Lateral Drawers
FN2448MLCR	Left Multi-File Return	2 Box /File Lateral Drawers	

Interior Drawer Dimensions	Depth	Width	Height
Box	15 1/4"	13 7/8"	4 1/4"
File	15 1/4"	14 7/8"	9 3/8"
Lateral File	15 1/4"	31 3/8"	9 3/8"

### Filing Options

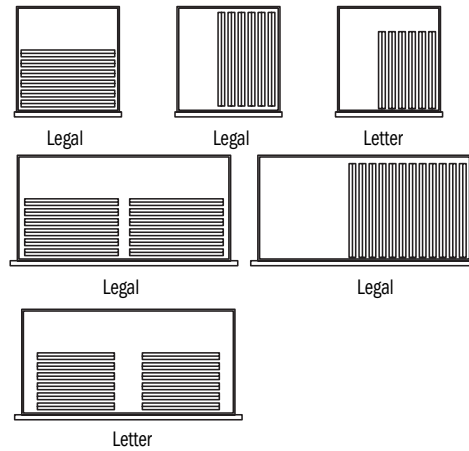

<b>Credenza</b>		Drawer Configuration (User Side)	
Model	Description	Left Pedestal	Right Pedestal
FN2472SC	Storage Credenza <sup>1</sup>	File/File	File/File
FN2466SC	Storage Credenza <sup>1</sup>	File/File	File/File
FN2472KC	Kneespace Credenza	File/File	File/File
FN2466KC	Kneespace Credenza	File/File	File/File
FN2472RC	Right Pedestal Credenza		File/File
FN2472LC	Left Pedestal Credenza	File/File	
FN2466RC	Right Pedestal Credenza		File/File
FN2466LC	Left Pedestal Credenza	File/File	
FN2472RCR	Right Pedestal Credenza		File/File
FN2472LCR	Left Pedestal Credenza	File/File	

Interior Drawer Dimensions	Depth	Width	Height
File	15 1/4"	14 7/8"	9 3/8"

### Filing Options

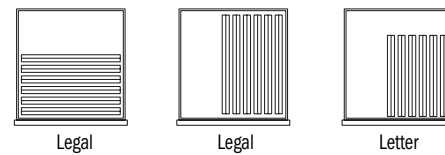

<sup>1</sup>Center Section - Hinge Door Storage

<b>Credenza - Lateral</b>		Drawer Configuration (User Side)	
Model	Description	Left Pedestal	Right Pedestal
FN2472LFC	Lateral File Credenza	2 Lateral Drawers	2 Lateral Drawers
FN2472LRC	Right Lateral File	2 Lateral Drawers	
FN2472LLC	Left Lateral File		2 Lateral Drawers
FN2472MRC	Right Multi-File Credenza		2 Box /File/Lateral
FN2472MLC	Right Multi-File Credenza		2 Box /File/Lateral

Interior Drawer Dimensions	Depth	Width	Height
Box	15 1/4"	13 7/8"	4 1/4"
File	15 1/4"	14 7/8"	9 3/8"
Lateral File	15 1/4"	31 3/8"	9 3/8"

### Filing Options

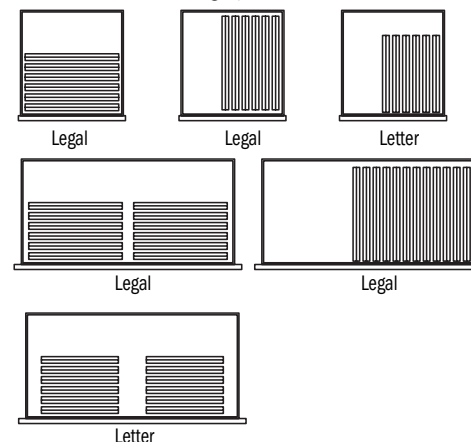



# Finale Product Information

## Buffet Credenza

Model	Description	Drawer Configuration
FN2472BSC	Buffet Credenza <sup>2</sup>	Along the Top <sup>2</sup> 4 Box Drawers

<sup>2</sup>Bottom Section - Hinge Door Storage

Interior Drawer Dimensions	Depth	Width	Height
Box	15 1/4"	14 3/16"	4 1/4"

## Lateral File Cabinet

Model	Description	Drawer Configuration
FN3654LF	4 Drawer Lateral File Cabinet	Single Lateral Pedestal Width 4 Lateral Drawers
FN3642LF	3 Drawer Lateral File Cabinet	3 Lateral Drawers
FN3630LF	2 Drawer Lateral File Cabinet	2 Lateral Drawers

Interior Drawer Dimensions	Depth	Width	Height
Lateral File	15 1/4"	31 3/8"	9 3/8"

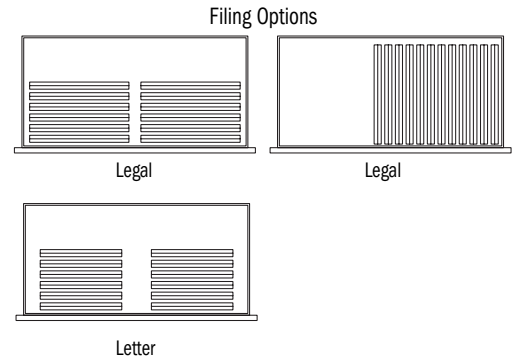

## Tall Storage Cabinets

Model	Description	Drawer Configuration
FN3672SWLF	Storage Cabinet	Single Lateral Pedestal Width 2 Lower Lateral Drawers
FN2472SWR	Storage Cabinet	2 File Drawers on Lower Right
FN2472SWL	Storage Cabinet	2 File Drawers on Lower Left

Interior Drawer Dimensions	Depth	Width	Height
File	15 1/4"	11 7/8"	9 3/8"
Lateral File	15 1/4"	31 3/8"	9 3/8"

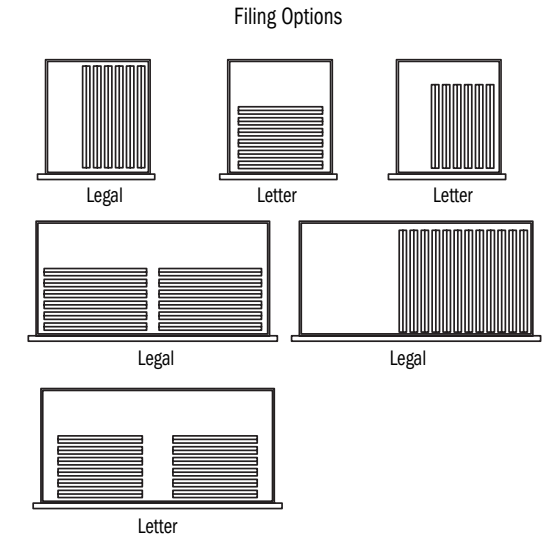

## Additional Drawer Sizes

Center Drawer - FN1825CD  
Interior Sizes - 15 1/4" d x 21 15/16" w x 2" h

## Finale - Typicals

### FN001

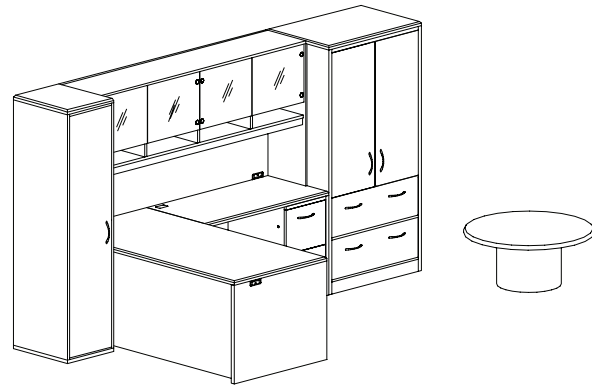
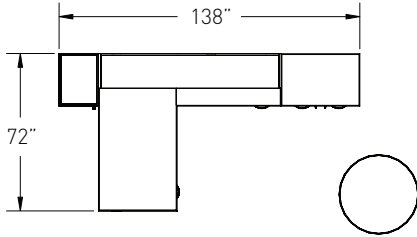

Model	Description	Qty	Price
1 FN1684GSOC	storage overhead cabinet w/glass doors & cubbies	1	\$4,317
2 FN1872WL	72" wardrobe, left	1	\$2,854
3 FN2418MTC	modular wardrobe top	1	\$525
4 FN2448ERR	file/file return, right	1	\$2,509
5 FN3672LD	single pedestal desk, left	1	\$3,291
6 FN3672SWLF	72" file/file lateral storage cabinet	1	\$4,396
7 FN2436MTC	modular wardrobe top	1	\$628
8 FN36MTD	36" round magazine table	1	\$2,125
9 FN84TKC	tackboard for 84"w storage overhead cabinet w/cubbies	1	\$362
<b>Typical List Price</b>			<b>\$21,007</b>

### FN002

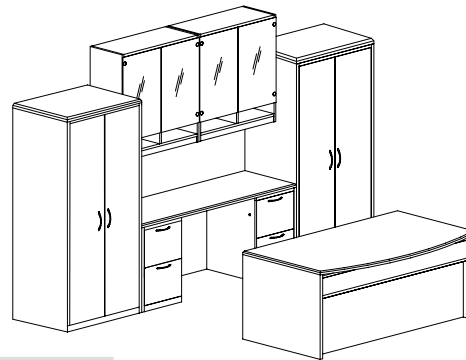
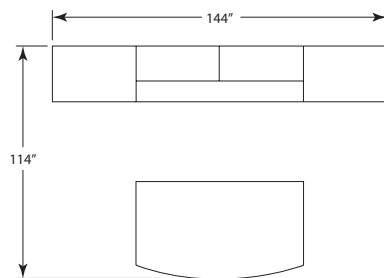

Model	Description	Qty	Price
1 FN1636DGBMSC	double height bridge mount overhead cabinet with glass doors and cubbies	2	\$5,348
2 FN2472KC	kneespace credenza	1	\$3,681
3 FN3672W	72" wardrobe w/2 doors	2	\$6,816
4 FN4272BD	bow front double pedestal desk	1	\$4,400
5 FN0772GVMP	metal/vener trim modesty panel	1	\$1,240
<b>Typical List Price</b>			<b>\$21,485</b>

## Finale - Typical

### FN003

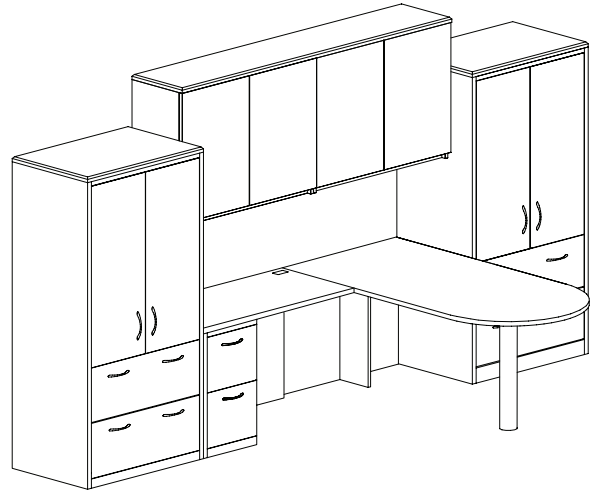
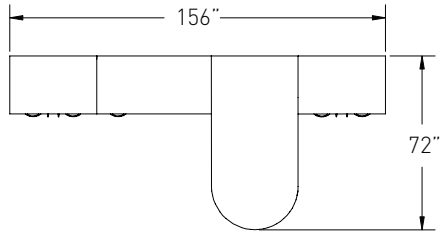

Model	Description	Qty	Price
1 FN1642DWMS	double height wall mount overhead cabinet with wood doors	2	\$4,430
2 FN2448ELR	file/file return, left	1	\$2,509
3 FN3672SWLF	72" file/file lateral storage cabinet	2	\$8,792
4 FN1684MCT	modular cabinet top	1	\$1,607
5 FN3672B	bullet peninsula desk	1	\$2,706
6 04BB	column base	1	\$395
<b>Typical List Price</b>			<b>\$20,439</b>

### FN007

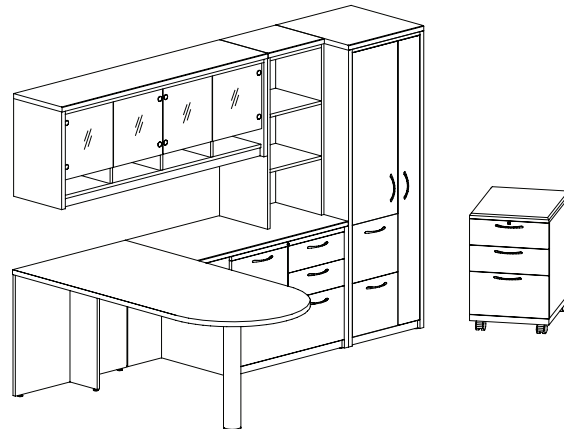
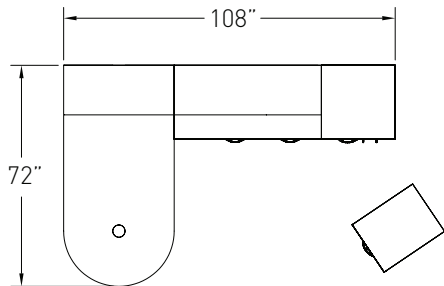

Model	Description	Qty	Price
1 FN3672B	bullet peninsula desk	1	\$2,706
2 04NB	column base	1	\$395
3 FN2448MRR	multi-file pedestal return, right	1	\$3,765
4 FN1666GWMS	wall mount overhead cabinet with 4 glass doors & cubbies	1	\$3,213
5 FN1618SO	open storage tower	1	\$1,124
6 FN2472SWR	72" file/file storage tower, right	1	\$3,209
7 FN1820MP	mobile pedestal	1	\$1,886
<b>Typical List Price</b>			<b>\$16,298</b>

## Finale - Typical

### FN008

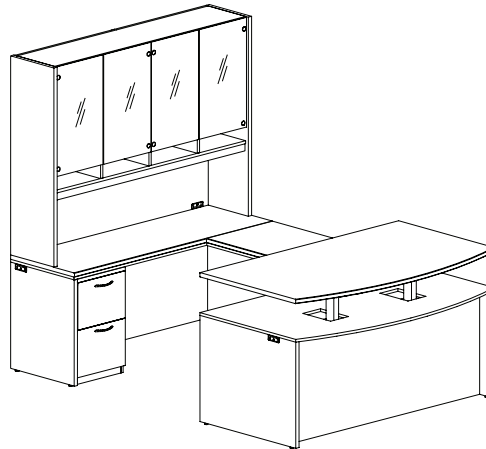
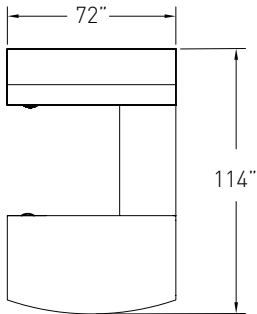

Model	Description	Qty	Price
1 FN4272RBD	bow front single ped desk, right, ERGO adjustable height	1	\$8,633
2 FN2448EB	bridge with modesty panel, ERGO adjacent	1	\$1,676
3 FN2472LC	file/file pedestal return, left, ERGO adjacent	1	\$3,873
4 FN1672DGSOC	double height overhead cabinet with 4 glass doors & cubbies	1	\$5,144
<b>Typical List Price</b>			<b>\$19,326</b>

### FN011

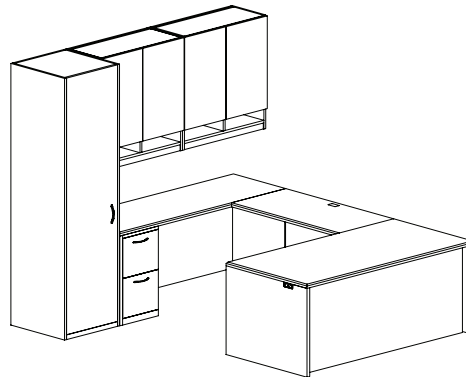
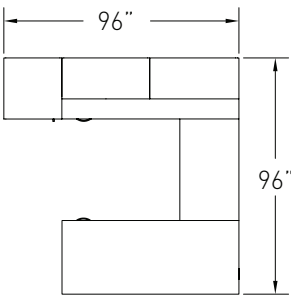

Model	Description	Qty	Price
1 FN3072RD	single pedestal desk, right	1	\$3,203
2 FN2442EB	bridge with modesty panel	1	\$1,032
3 FN1636DWMSC	double height wall mount overhead with 2 doors and cubbies	2	\$4,762
4 FN2472LC	file/file pedestal credenza, left	1	\$3,238
5 FN1884WL	84" wardrobe, left	1	\$3,426
<b>Typical List Price</b>			<b>\$15,661</b>

## Finale - Typicals

### FN013

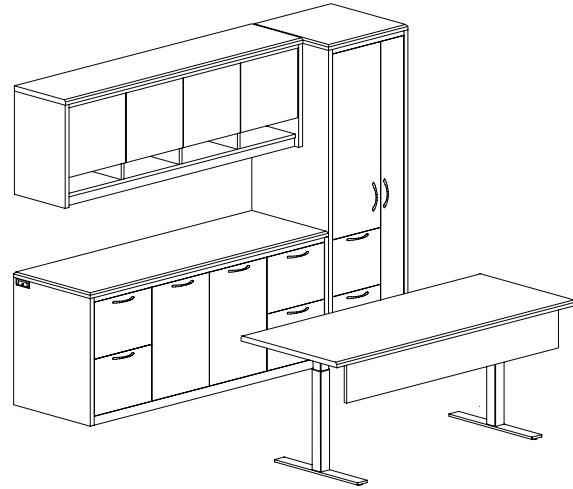
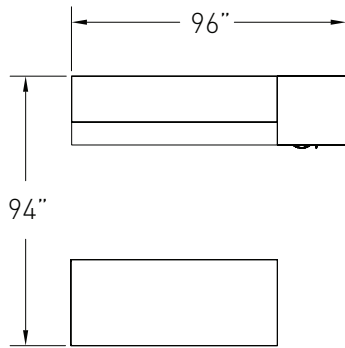

Model	Description	QTY	Price
1 FN3072AHTD-EL	electric adjustable height table desk	1	\$2,680
2 FN0964TDM	modesty panel for adjustable height table desk	1	\$652
3 FN2472SC	storage credenza	1	\$3,791
4 FN1672WMSC	wall mount overhead with 4 doors & cubbies	1	\$2,741
5 FN2472SWR	72"h file/file storage wardrobe	1	\$3,209
<b>Typical List Price</b>			<b>\$13,073</b>

### FN014

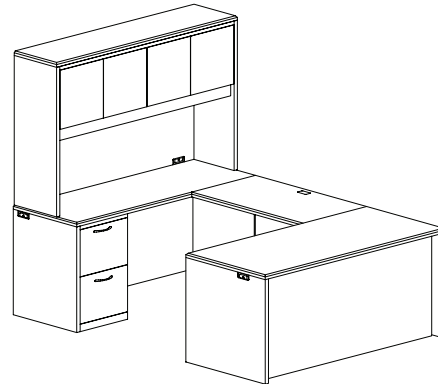
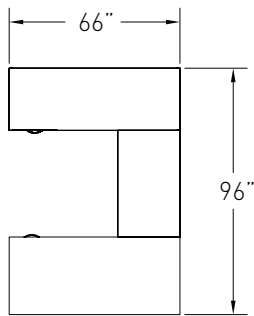

Model	Description	Qty	Price
1 FN3066RD	single pedestal desk, right	1	\$3,116
2 FN2442EB	bridge with modesty panel	1	\$1,032
3 FN2466LC	file/file pedestal credenza, left	1	\$3,084
4 FN1666SO	storage overhead cabinet with 4 doors	1	\$2,847
<b>Typical List Price</b>			<b>\$10,079</b>

Description	D	W	H	CTN WT	CU FT	① Model	List Price
-------------	---	---	---	-----------	----------	---------	------------

<b>Bow Front Double Pedestal Desk</b>	42	71 ¾	30	480	61	<b>FN4272BD</b>	<b>\$4,400</b>
---------------------------------------	----	------	----	-----	----	-----------------	----------------

**NOW!**



- box/box/file left pedestal; file/file right pedestal
- letter width pedestals
- optional center drawer, model FN1825CD. See page 500.
- pedestal locking
- top edge profile on user and approach sides
- two end panel grommets standard
- 6" overhang on approach side
- chassis - 36" x 71 ¾"
- kneespace - 38 ½"

<b>Double Pedestal Desk</b>	36	71 ¾	30	340	53	<b>FN3672DD</b>	<b>\$3,729</b>
-----------------------------	----	------	----	-----	----	-----------------	----------------

**NOW!**



	30	71 ¾	30	368	44	<b>FN3072DD</b>	<b>\$3,671</b>
	30	65 ¾	30	320	41	<b>FN3066DD</b>	<b>\$3,616</b>
	30	59 ¾	30	300	37	<b>FN3060DD</b>	<b>\$3,558</b>

- box/box/file left pedestal; file/file right pedestal
- letter width pedestals
- optional center drawer, model FN1825CD. See page 500.
- pedestal locking
- top edge profile on user and approach sides
- two end panel grommets standard
- FN3672DD and FN3072DD kneespace - 38 ½"
- FN3066DD kneespace - 32 ½"
- FN3060DD kneespace - 26 ½"

<b>Glass Trim Modesty Panel</b>	¾	68 ½	6 ½	13	2	<b>FN0772AMP</b>	<b>\$560</b>
---------------------------------	---	------	-----	----	---	------------------	--------------

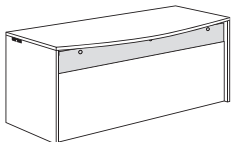

coordinates with:  
 FN4272BD FN3672DD FN3072DD  
 FN4272RBD FN3672RD FN3072RD  
 FN4272LBD FN3672LD FN3072LD

	¾	62 ½	6 ½	12	2	<b>FN0766AMP</b>	<b>\$550</b>
--	---	------	-----	----	---	------------------	--------------

coordinates with:  
 FN3066DD FN3066RD FN3066LD

	¾	56 ½	6 ½	11	2	<b>FN0760AMP</b>	<b>\$543</b>
--	---	------	-----	----	---	------------------	--------------

coordinates with:  
 FN3060DD

- white back painted glass panel
- field installed

<b>Metal Trim Modesty Panel</b>	2	68 ½	7	18	2	<b>FN0772GRMP</b>	<b>\$1,089</b>
---------------------------------	---	------	---	----	---	-------------------	----------------

**NOW!**

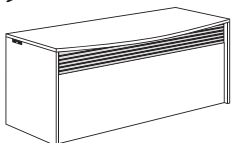

coordinates with:  
 FN4272BD FN3672DD FN3072DD  
 FN4272RBD FN3672RD FN3072RD  
 FN4272LBD FN3672LD FN3072LD

	2	62 ½	7	17	2	<b>FN0766GRMP</b>	<b>\$1,077</b>
--	---	------	---	----	---	-------------------	----------------

coordinates with:  
 FN3066DD FN3066RD FN3066LD

	2	56 ½	7	16	2	<b>FN0760GRMP</b>	<b>\$1,062</b>
--	---	------	---	----	---	-------------------	----------------

coordinates with:  
 FN3060DD

- five metal tubes - specify metal color option: Black Sandtex, Soft Nickel or Stardust Silver
- field installed

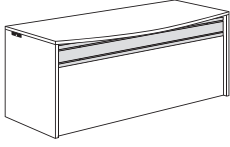
Description	D	W	H	CTN WT	CU FT	① Model	List Price
<b>Metal/Glass Trim Modesty Panel</b> 	2	68 ½	7	15	2	<b>FN0772GAMP</b> coordinates with: FN4272BD FN3672DD FN3072DD FN4272RBD FN3672RD FN3072RD FN4272LBD FN3672LD FN3072LD	<b>\$1,315</b>
	2	62 ½	7	14	2	<b>FN0766GAMP</b> coordinates with: FN3066DD FN3066RD FN3066LD	<b>\$1,303</b>
	2	56 ½	7	13	2	<b>FN0760GAMP</b> coordinates with: FN3060DD	<b>\$1,296</b>

- two metal tubes - specify metal color option: Black Sandtex, Soft Nickel or Stardust Silver
- white back painted glass panel insert
- field installed

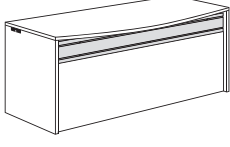
<b>Metal/Veneer Trim Modesty Panel</b> 	2	68 ½	7	13	2	<b>FN0772GVMP</b> coordinates with: FN4272BD FN3672DD FN3072DD FN4272RBD FN3672RD FN3072RD FN4272LBD FN3672LD FN3072LD	<b>\$1,240</b>
	2	62 ½	7	12	2	<b>FN0766GVMP</b> coordinates with: FN3066DD FN3066RD FN3066LD	<b>\$1,226</b>
	2	56 ½	7	11	2	<b>FN0760GVMP</b> coordinates with: FN3060DD	<b>\$1,216</b>

- two metal tubes - specify metal color option: Black Sandtex, Soft Nickel or Stardust Silver
- veneer panel insert - specify finish option: see page 436
- field installed

**To Order, Specify:**

- ① Model Number
- ② Wood Species - Cherry (CH1), Maple (MA1) or Walnut (WA1) (see page 436)
- ③ Finish Color - (see page 436)
- ④ Edge Profile - (see page 436)
- ⑤ Pull Style and Color - (see page 436)
- ⑥ Grommet Color - Matte Black (MBK) or Stardust Silver (STS) (see page 436)
- ⑦ Metal Color - Black Sandtex (BSX), Soft Nickel (SNK) or Stardust Silver (STS) (see page 436)
- ⑧ Other Product Options (see page 429)
- ⑨ Accessories, Power and Data Options (see pages 519-535)

When ordering Quickship products, place a "Q" in front of model number.  
Example: QFN3072DD

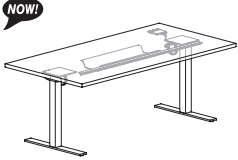

Description	D	W	H	CTN WT	CU FT	① Model	List Price
<b>Electric Adjustable Height Table Desk</b> 	36	72	Adj.	194	18	FN3672AHTD-EL	\$2,787
	30	72	Adj.	175	16	FN3072AHTD-EL	\$2,680
	30	66	Adj.	168	15	FN3066AHTD-EL	\$2,650
	30	60	Adj.	160	14	FN3060AHTD-EL	\$2,618
	24	72	Adj.	151	12	FN2472AHTD-EL	\$2,574
	24	66	Adj.	146	11	FN2466AHTD-EL	\$2,547
	24	60	Adj.	140	10	FN2460AHTD-EL	\$2,523

- 22 1/2" - 49" height adjustment
- top edge profile on user and approach sides
- push button control pad mounted right or left
- maximum weight rating 140 lbs. (evenly distributed load)
- key pad features height display with three memory settings
- display will reference position to the nearest 1/2"
- 120" power cord
- specify Matte Black (MBK) or Arctic Silver (STS) base finish
- ships KD

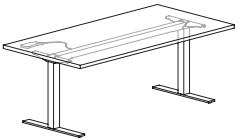
<b>Pneumatic Adjustable Height Table Desk</b> 	36	72	Adj.	194	18	FN3672AHTD-PN	\$4,883
	30	72	Adj.	175	16	FN3072AHTD-PN	\$4,672
	30	66	Adj.	168	15	FN3066AHTD-PN	\$4,535
	30	60	Adj.	160	14	FN3060AHTD-PN	\$4,392
	24	72	Adj.	151	12	FN2472AHTD-PN	\$4,375
	24	66	Adj.	146	11	FN2466AHTD-PN	\$4,299
	24	60	Adj.	140	10	FN2460AHTD-PN	\$4,206

- 27 1/2" - 44 1/2" height adjustment
- top edge profile on user and approach sides
- release lever mounts under edge of top
- 20 lb lift force/max weight rating 140 lbs. (evenly distributed load)
- specify Matte Black or Alloy base finish
- ships KD

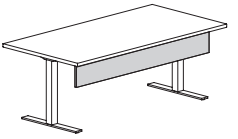
<b>Modesty Panels for Adjustable Height Tables</b> 	3/4	64	9	18	3	FN0964TDM	\$652
	3/4	58	9	16	2	FN0958TDM	\$631
	3/4	52	9	14	2	FN0952TDM	\$609

- FN0964TDM use with 72" wide adjustable height desk
- FN0958TDM use with 66" wide adjustable height desk
- FN0952TDM use with 60" wide adjustable height desk
- flat edge detail
- modesty panel bracket is available in Black Sandtex (BSX) or Stardust Silver (STS)



Description	D	W	H	CTN WT	CU FT	① Model	List Price
<b>Metal Frame Table Desk with Glass Top</b>	36	72	30	195	53	<b>FN3672TDG</b>	<b>\$4,754</b>

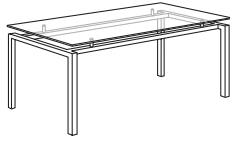

- metal 2" square tube frame - specify metal color option: Black Sandtex, Soft Nickel or Stardust Silver
- clear glass or white back painted glass top
- floor to frame knee height clearance 25 1/2"
- glass top crated for shipment
- 1/2 tempered glass top

<b>Metal Frame Table Desk with Veneer Top</b>	36	72	30	195	53	<b>FN3672TDV</b>	<b>\$4,736</b>
---	----	----	----	-----	----	------------------	----------------

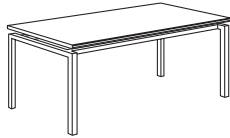

- metal 2" square tube frame - specify metal color option: Black Sandtex, Soft Nickel or Stardust Silver
- black support for veneer top included
- floor to frame knee height clearance 25 1/2"
- wood species, finish and edge profile must be specified
- field assembly of veneer top to metal base frame

<b>Metal Frame Table Desk for COM Top</b>	36	72	30	195	53	<b>FN3672TDX</b>	<b>\$4,702</b>
---	----	----	----	-----	----	------------------	----------------

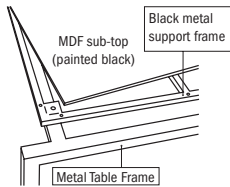
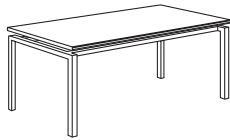

- includes: table desk frame, black metal support and black MDF sub top
- CUSTOMER MUST SUPPLY WORK SURFACE AND INSTALLATION AT FINAL DESTINATION
- metal 2" square tube frame - specify metal color option: Black Sandtex, Soft Nickel or Stardust Silver
- black support for COM top
- floor to frame knee height clearance 25 1/2"
- field assembly of COM top support to metal base frame

**To Order, Specify:**

- ① Model Number
- ② Wood Species - Cherry (CH1), Maple (MA1) or Walnut (WA1) (see page 436)
- ③ Finish Color - (see page 436)
- ④ Glass Surface - (see page 436)
- ⑤ Metal Color - (see page 436)
- ⑥ Edge Profile - (see page 436)
- ⑦ Other Product Options (see page 429)

When ordering Quickship products, place a "Q" in front of model number.  
Example: QFN3072DD

**NOW!**  
Need it.  
JSI Quickship

Description	D	W	H	CTN WT	CU FT	① Model	List Price
-------------	---	---	---	-----------	----------	---------	------------

<b>Metal Trim Modesty Panel</b>  <ul style="list-style-type: none"> <li>· two metal tubes - specify metal color option: Black Sandtex (BSX), Soft Nickel (SNK) or Stardust Silver (STS)</li> <li>· field installed</li> <li>· for use with FN3672TDG, FN3672TDV and FN3672TDX</li> </ul>	2	64 ½	7	18	2	<b>FNTD72GRMP</b>	<b>\$1,133</b>
---	---	------	---	----	---	-------------------	----------------

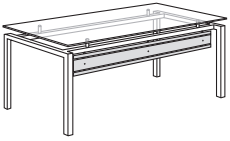
<b>Metal/Glass Trim Modesty Panel</b>  <ul style="list-style-type: none"> <li>· two metal tubes - specify metal color option: Black Sandtex (BSX), Soft Nickel (SNK) or Stardust Silver (STS)</li> <li>· white back painted glass panel insert</li> <li>· field installed</li> <li>· for use with FN3672TDG, FN3672TDV and FN3672TDX</li> </ul>	2	64 ½	7	15	2	<b>FNTD72GAMP</b>	<b>\$1,384</b>
--	---	------	---	----	---	-------------------	----------------

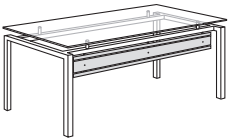
<b>Metal/Veneer Trim Modesty Panel</b>  <ul style="list-style-type: none"> <li>· two metal tubes - specify metal color option: Black Sandtex (BSX), Soft Nickel (SNK) or Stardust Silver (STS)</li> <li>· veneer panel insert - specify finish option</li> <li>· field installed</li> <li>· for use with FN3672TDG, FN3672TDV and FN3672TDX</li> </ul>	2	64 ½	7	13	2	<b>FNTD72GVMP</b>	<b>\$1,262</b>
--	---	------	---	----	---	-------------------	----------------

Desk Applications

Executive U

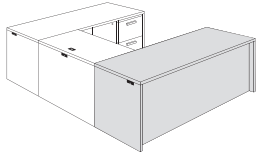

Computer U

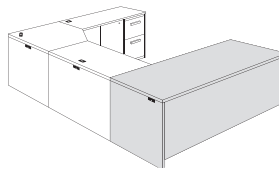

Description	D	W	H	CTN WT	CU FT	1 Model	List Price
Bow Front Single Pedestal Desk	42	71 3/4	30	400	61	FN4272RBD	\$4,110
<b>NOW!</b>	42	71 3/4	30	400	61	FN4272LBD	\$4,110

**NOW!**

left shown

- box/box/file pedestal - letter width
- optional center drawer, See page 496
- 6" overhang on approach side
- chassis - 36" x 71 3/4"
- pedestal locking
- top edge profile on user and approach side
- two end panel grommets with wire pass thru

Single Pedestal Desk	36	71 3/4	30	290	53	FN3672RD	\$3,291
<b>NOW!</b>	36	71 3/4	30	290	53	FN3672LD	\$3,291
	30	71 3/4	30	290	44	FN3072RD	\$3,203
	30	71 3/4	30	290	44	FN3072LD	\$3,203
	30	65 3/8	30	275	41	FN3066RD	\$3,116
	30	65 3/8	30	275	41	FN3066LD	\$3,116

**NOW!**

left shown

- box/box/file pedestal - letter width
- optional center drawer, See page 496
- pedestal locking
- top edge profile on user and approach side
- two end panel grommets with wire pass thru

To Order, Specify:

- 1 Model Number
- 2 Wood Species - Cherry (CH1), Maple (MA1) or Walnut (WA1) (see page 436)
- 3 Finish Color - (see page 436)
- 4 Edge Profile - (see page 436)
- 5 Pull Style & Color - (see page 436)
- 6 Grommet Color - Matte Black (MBK) or Stardust Silver (STS) (see page 436)
- 7 Glass Color - (see page 436)
- 8 Metal Color - Black Sandtex (BSX), Soft Nickel (SNK) or Stardust Silver (STS) (see page 436)
- 9 Other Product Options (see page 429)
- 10 Accessories, Power and Data Options (see pages 519-535)

When ordering Quickship products, place a "Q" in front of model number.  
Example: QFN3072DD

**NOW!**  
Need it.  
JSI Quickship

Peninsula Desk Applications

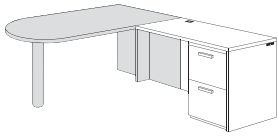

Description	D	W	H	CTN WT	CU FT	① Model	List Price
Bullet Peninsula Desk	36	72	30	135	53	FN3672B	\$2,706
 Bullet Peninsula Desk	30	72	30	122	44	FN3072B	\$2,661

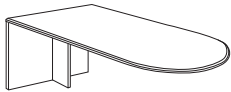

- edge profile on three open sides
- one end panel grommet
- trim modesty panel available, see page 451
- non-handed
- optional center drawer available, See page 500
- not for freestanding use
- bases must be purchased separately; see page 451 for options

P-Top Peninsula Desk	42	72	30	155	61	FN4272RP	\$3,224
 P-Top Peninsula Desk	42	72	30	155	61	FN4272LP	\$3,224

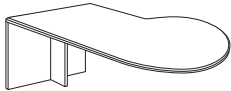

right shown

- 42" at widest point
- 36" at end panel
- edge profile on three open sides
- one end panel grommet
- trim modesty panel, see page 451
- optional center drawer available, See page 500
- not for freestanding use
- bases must be purchased separately; see page 451 for options

**Bases Options and Modesty Panels for Peninsula Tops**  
 (these bases must be ordered separately from the desks listed on previous page)

**NOW!**

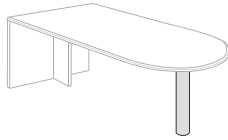

- Column Base**
- 04BB - Black Sandtex (BSX) \$395
  - 04NB - Soft Nickel (SNK) \$395
  - 04SB - Stardust Silver (STS) \$395

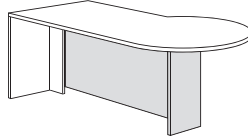

- Full Modesty Panel**
- FN2854RMP - right \$925
  - FN2854LMP - left \$925

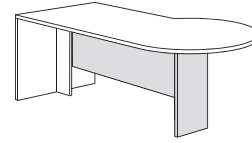

- 3/4 Modesty Panel**
- FN2154RMP - right \$925
  - FN2154LMP - left \$925

- Base:**
- 13 gauge steel
  - 4" diameter

Description	D	W	H	CTN WT	CU FT	1 Model	List Price
Trim Modesty Panel	2	42	10	10	2	FN1042GAMP	\$813

**NOW!**

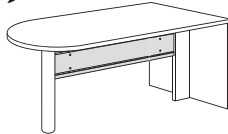

- two metal tubes - specify metal color option: Black Sandtex (BSX), Soft Nickel (SNK) or Stardust Silver (STS)
- white back painted glass panel insert
- field installed
- modesty panel requires special location if an optional center drawer is used

Trim Modesty Panel	2	42	10	12	2	FN1042GVMP	\$769
--------------------	---	----	----	----	---	------------	-------

**NOW!**

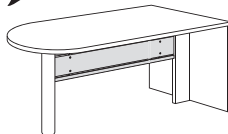

- two metal tubes - specify metal color option: Black Sandtex (BSX), Soft Nickel (SNK) or Stardust Silver (STS)
- veneer panel insert - specify finish option
- field installed
- modesty panel requires special location if an optional center drawer is used

**To Order, Specify:**

- 1 Model Number
- 2 Wood Species - Cherry (CH1), Maple (MA1) or Walnut (WA1) (see page 436)
- 3 Finish Color - (see page 436)
- 4 Edge Profile - (see page 436)
- 5 Pull Style and Color - (see page 436)
- 6 Grommet Color - Matte Black (MBK) or Stardust Silver (STS) (see page 436)
- 7 Metal Color - Black Sandtex (BSX), Soft Nickel (SNK) or Stardust Silver (STS) (see page 436)
- 8 Other Product Options (see page 429)
- 9 Accessories, Power and Data Options (see pages 519-535)

When ordering Quickship products, place a "Q" in front of model number.  
 Example: QFN3072DD

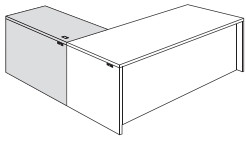

**NOW!**  
 Need it.  
 JSI Quickship

Return Applications - Executive L

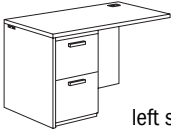
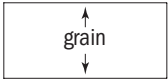

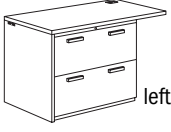

Description	D	W	H	CTN WT	CU FT	① Model	List Price
<b>File/File Return</b>   <p>left shown</p> 	23 7/8	47 7/8	30	150	25	<b>FN2448ERR</b>	\$2,509
	23 7/8	47 7/8	30	150	25	<b>FN2448ELR</b>	\$2,509
	23 7/8	41 7/8	30	140	22	<b>FN2442ERR</b>	\$2,263
	23 7/8	41 7/8	30	140	22	<b>FN2442ELR</b>	\$2,263

- top edge profile on user side
- short grain direction
- pedestal locking
- letter width file/file pedestal
- one end and back panel grommet with wire pass thru
- one surface grommet

<b>Lateral File Return</b>   <p>left shown</p> 	23 7/8	47 7/8	30	170	25	<b>FN2448LRR</b>	\$3,134
	23 7/8	47 7/8	30	170	25	<b>FN2448LLR</b>	\$3,134

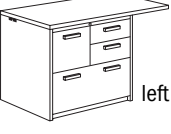
- top edge profile on user side
- short grain direction
- anti-tip interlock mechanism
- pedestal locking
- one end and back panel grommet with wire pass thru
- one surface grommet

<b>Multi-File Return</b>   <p>left shown</p> 	23 7/8	47 7/8	30	170	25	<b>FN2448MRR</b>	\$3,765
	23 7/8	47 7/8	30	170	25	<b>FN2448MLR</b>	\$3,765

- top edge profile on user side
- short grain direction
- 36" width multi-file
- pedestal locking
- one end and back panel grommet with wire pass thru
- one surface grommet

Corner Unit Applications - Computer L

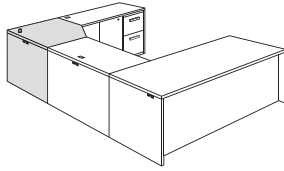

Description	D	W	H	CTN WT	CU FT	① Model	List Price
Executive Corner Unit	41 7/8	41 7/8	30	135	36	FN4242ERCU	\$2,509
<b>NOW!</b>	41 7/8	41 7/8	30	135	36	FN4242ELCU	\$2,509
	35 7/8	35 7/8	30	118	27	FN3636ERCU	\$2,282
	35 7/8	35 7/8	30	118	27	FN3636ELCU	\$2,282



- use with corner return
- not freestanding
- one surface and two back panel grommets

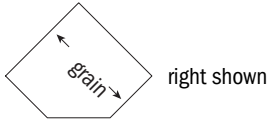

To Order, Specify:

- ① Model Number
- ② Wood Species - Cherry (CH1), Maple (MA1) or Walnut (WA1)  
(see page 436)
- ③ Finish Color - (see page 436)
- ④ Edge Profile - (see page 436)
- ⑤ Pull Style and Color - (see page 436)
- ⑥ Grommet Color - Matte Black (MBK) or Stardust Silver (STS)  
(see page 436)
- ⑦ Other Product Options (see page 429)
- ⑧ Accessories, Power and Data Options (see pages 519-535)

When ordering Quickship products, place a "Q" in front of model number.  
Example: QFN3072DD

**NOW!**  
Need it.  
JSI Quickship

Corner Return Applications - Executive L

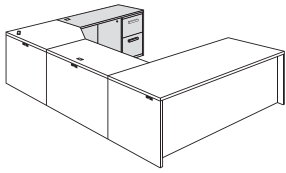

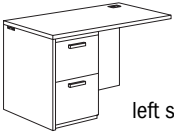
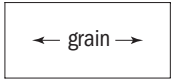
Description	D	W	H	CTN WT	CU FT	① Model	List Price
File/File Corner Return	23 7/8	47 7/8	30	150	25	FN2448ERCR	\$2,509
<b>NOW!</b>	23 7/8	47 7/8	30	150	25	FN2448ELCR	\$2,509
 <p>left shown</p> 	23 7/8	41 7/8	30	145	22	FN2442ERCR	\$2,263
	23 7/8	41 7/8	30	145	22	FN2442ELCR	\$2,263

- top edge profile on user side
- long grain direction
- pedestal locking
- letter width file/file pedestal
- one end and back panel grommet with wire pass thru
- one surface grommet

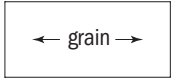
Lateral File Corner Return	23 7/8	47 7/8	30	170	25	FN2448LRCR	\$3,134
<b>NOW!</b>	23 7/8	47 7/8	30	170	25	FN2448LLCR	\$3,134
 <p>left shown</p> 							

- top edge profile on user side
- long grain direction
- anti-tip interlock mechanism
- pedestal locking
- one end and back panel grommet with wire pass thru
- one surface grommet

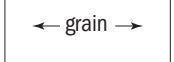
Multi-File Corner Return	23 7/8	47 7/8	30	170	25	FN2448MRCR	\$3,765
<b>NOW!</b>	23 7/8	47 7/8	30	170	25	FN2448MLCR	\$3,765
 <p>left shown</p> 							

- top edge profile on user side
- long grain direction
- 36" width multi-file
- pedestal locking
- one end and back panel grommet with wire pass thru
- one surface grommet



Bridge Applications - Executive U

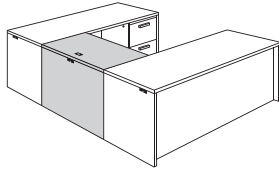

Description	D	W	H	CTN WT	CU FT	① Model	List Price
Bridge with Modesty Panel	23 7/8	48	30	105	5	FN2448EB	\$1,134
<b>NOW!</b>	23 7/8	42	30	85	3	FN2442EB	\$1,032
	23 7/8	36	30	65	3	FN2436EB	\$886

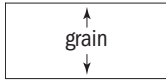
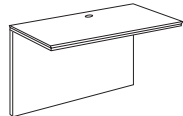

- top edge profile on user side
- short grain direction
- one surface grommet
- one back panel grommet

Bridge Top	23 7/8	48	1 3/16	39	4	FN4824MCT	\$1,018
<b>NOW!</b>	23 7/8	42	1 3/16	35	4	FN4224MCT	\$944
	23 7/8	36	1 3/16	29	3	FN3624MCT	\$836

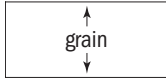
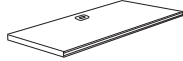

- top edge profile on user side
- short grain direction
- one surface grommet
- no modesty included; top only

To Order, Specify:

- ① Model Number
- ② Wood Species - Cherry (CH1), Maple (MA1) or Walnut (WA1) (see page 436)
- ③ Finish Color - (see page 436)
- ④ Edge Profile - (see page 436)
- ⑤ Pull Style and Color - (see page 436)
- ⑥ Grommet Color - Matte Black (MBK) or Stardust Silver (STS) (see page 436)
- ⑦ Other Product Options (see page 429)
- ⑧ Accessories, Power and Data Options (see pages 519-535)

When ordering Quickship products, place a "Q" in front of model number.  
Example: QFN3072DD

**NOW!**  
Need it.  
JSI Quickship

Description	D	W	H	CTN WT	CU FT	① Model	List Price
Electric Adjustable Height Bridge	24	46	Adj.	90	9	FN2446AHB-EL	\$2,430
	24	40	Adj.	85	8	FN2440AHB-EL	\$2,386

**NOW!**

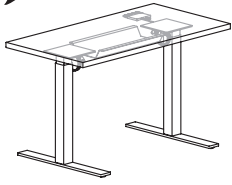

- 22 1/2" - 49" height adjustment
- top edge profile on user and approach sides
- push button control pad mounted right or left
- maximum weight rating 140 lbs. (evenly distributed load)
- key pad features height display with three memory settings
- display will reference position to the nearest 1/2"
- 120" power cord
- specify Matte Black (MBK) or Arctic Silver (STS) base finish
- ships KD

Modesty Panel for Adjustable Height Bridge	3/4	46	9	13	2	FN0946TDM	\$593
	3/4	40	9	11	2	FN0940TDM	\$575

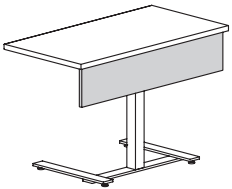
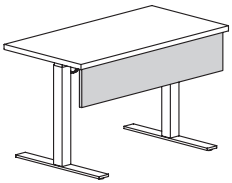

- FN0946TDM use with 46" wide adjustable height bridge
- FN0940TDM use with 40" wide adjustable height bridge
- modesty panel bracket is available in Black Sandtex (BSX) or Stardust Silver (STS)
- flat edge detail

Description	D	W	H	CTN WT	CU FT	① Model	List Price
Storage Credenza	24	71 ¾	30	290	36	FN2472SC	\$3,791
<b>NOW!</b>	24	65 ¾	30	270	33	FN2466SC	\$3,681



- top edge profile on user side
- file/file pedestal - legal width
- adjustable shelf in center storage
- pedestal locking
- locking doors available, specify and add \$123 list
- one back and two end panel grommets with wire pass thru

Lateral File Credenza	24	71 ¾	30	235	36	FN2472LFC	\$3,927
-----------------------	----	------	----	-----	----	-----------	---------



- top edge profile on user side
- two drawer lateral files side by side
- pedestal front locking
- anti-tip interlock mechanism
- two end panel grommets with wire pass thru

Four Door Credenza	24	71 ¾	30	235	36	FN2472DSC	\$3,752
--------------------	----	------	----	-----	----	-----------	---------

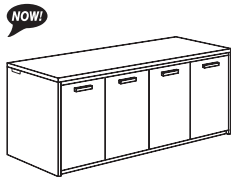

- top edge profile on user side
- adjustable shelves
- locking doors available, specify and add \$246 list
- two end panel grommets with wire pass thru

Two Door Credenza	24	35 ¾	30	90	19	FN3630SC	\$1,778
-------------------	----	------	----	----	----	----------	---------



- top edge profile on user side
- one adjustable shelf
- locking doors available, specify and add \$123 list
- two end panel grommets with wire pass thru
- compatible with overhead bookcases and cabinets; see page 480

**To Order, Specify:**

- ① Model Number
- ② Wood Species - Cherry (CH1), Maple (MA1) or Walnut (WA1) (see page 436)
- ③ Finish Color - (see page 436)
- ④ Edge Profile - (see page 436)
- ⑤ Pull Style and Color - (see page 436)
- ⑥ Grommet Color - Matte Black (MBK) or Stardust Silver (STS) (see page 436)
- ⑦ Metal Color - (see page 436)
- ⑧ Other Product Options (see page 429)
- ⑨ Accessories, Power and Data Options (see pages 519-535)

When ordering Quickship products, place a "Q" in front of model number.  
Example: QFN3072DD

**NOW!**  
Need it.  
JSI Quickship

Description	D	W	H	CTN WT	CU FT	① Model	List Price
Kneespace Credenza	24	71 ¾	30	270	36	FN2472KC	\$3,681
Kneespace Credenza	24	65 ¾	30	255	33	FN2466KC	\$3,564

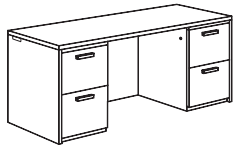

- top edge profile on user side
- file/file pedestals - legal width
- pedestal locking
- one back and two end panel grommets with wire pass thru
- kneespace for FN2472KC - 32 ½"
- kneespace for FN2466KC - 26 ½"

Buffet Credenza	24	71 7/8	36	280	43	FN2472BSC	\$5,307
-----------------	----	--------	----	-----	----	-----------	---------



- top edge profile on user side
- four door credenza
- four box drawers above doors
- locking doors and drawers not available
- adjustable shelf in storage cabinet
- two end panel grommets with wire pass thru

Credenza Applications - Executive U

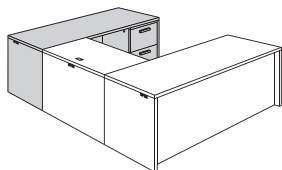

Description	D	W	H	CTN WT	CU FT	① Model	List Price
File/File Pedestal Credenza	23 7/8	71 ¾	30	235	36	FN2472RC	\$3,238
File/File Pedestal Credenza	23 7/8	71 ¾	30	235	36	FN2472LC	\$3,238
File/File Pedestal Credenza	23 7/8	65 ¾	30	220	33	FN2466RC	\$3,084
File/File Pedestal Credenza	23 7/8	65 ¾	30	220	33	FN2466LC	\$3,084



left shown

- top edge profile on user side
- pedestal locking
- legal width file/file pedestal
- two end panel and one back panel grommet with wire pass thru

File/File Reception Credenza	23 7/8	71 ¾	30	235	36	FN2472RCR	\$3,238
File/File Reception Credenza	23 7/8	71 ¾	30	235	36	FN2472LCR	\$3,238



left shown

- top edge profile on user side
- pedestal locking
- file/file pedestal - legal width
- two end panel grommets with wire pass thru
- no back panel grommets

Description	D	W	H	CTN WT	CU FT	① Model	List Price
Lateral Pedestal Credenza	23 7/8	71 3/4	30	250	36	FN2472LRC	\$3,640
<b>NOW!</b>	23 7/8	71 3/4	30	250	36	FN2472LLC	\$3,640



left shown

- top edge profile on user side
- pedestal locking
- anti-tip interlock mechanism
- two end panel and one back panel grommet with wire pass thru
- 36" wide lateral file

Multi-File Pedestal Credenza	23 7/8	71 3/4	30	265	36	FN2472MRC	\$3,806
<b>NOW!</b>	23 7/8	71 3/4	30	265	36	FN2472MLC	\$3,806



left shown

- top edge profile on user side
- pedestal locking
- 36" width multi-file
- two end panel and one back panel grommet with wire pass thru

Printer Stand	24	30	30	120	16	FN2430PS	\$1,659
---------------	----	----	----	-----	----	----------	---------

**NOW!**

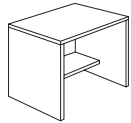

- fixed 11" deep shelf

Corner Unit	41 7/8	41 7/8	30	135	36	FN4242CU	\$2,509
<b>NOW!</b>	35 7/8	35 7/8	30	121	27	FN3636CU	\$2,282

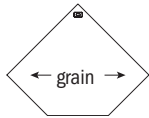
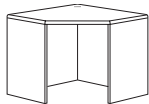

- angle grain direction on top
- one surface grommet and two back panel grommets
- freestanding
- top edge profile on user side only
- keyboard tray or mouse pad cannot be used with FN3636CU

**To Order, Specify:**

- ① Model Number
- ② Wood Species - Cherry (CH1), Maple (MA1) or Walnut (WA1) (see page 436)
- ③ Finish Color - (see page 436)
- ④ Edge Profile - (see page 436)
- ⑤ Pull Style and Color (see page 436)
- ⑥ Grommet Color - Matte Black (MBK) or Stardust Silver (STS) (see page 436)

- ⑦ Other Product Options (see page 429)
- ⑧ Accessories, Power and Data Options (see pages 519-535)

When ordering Quickship products, place a "Q" in front of model number.  
Example: QFN3072DD

**NOW!**  
*Need it.*  
JSI Quickship

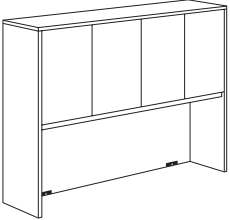
Description	D	W	H	CTN WT	CU FT	① Model	List Price
<b>Double Height Storage Overhead Cabinet with Four Doors</b> 	15 7/8	83 3/4	54	338	50	<b>FN1684DSO</b>	<b>\$3,712</b>
	15 7/8	77 3/4	54	318	47	<b>FN1678DSO</b>	<b>\$3,642</b>
	15 7/8	71 3/4	54	297	43	<b>FN1672DSO</b>	<b>\$3,571</b>
	15 7/8	65 3/4	54	262	40	<b>FN1666DSO</b>	<b>\$3,422</b>

- grommet in bottom left and right and in top center of back panel
- tackboards available, see pages 476-477
- task lights available, see pages 532-533
- 22" vertical clearance from desk top to bottom of light soffit
- adjustable shelf
- optional modular top, see page 488
- locking doors available, specify and add \$246 list
- no pulls
- backside of unit intended to go against wall, cabinet should be secured to wall as a safety precaution

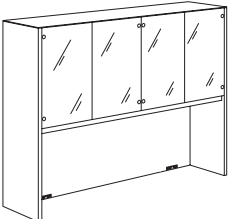
<b>Double Height Storage Overhead Cabinet with Four Glass Doors</b> 	15 7/8	83 3/4	54	342	50	<b>FN1684DGSO</b>	<b>\$4,637</b>
	15 7/8	77 3/4	54	323	47	<b>FN1678DGSO</b>	<b>\$4,549</b>
	15 7/8	71 3/4	54	301	43	<b>FN1672DGSO</b>	<b>\$4,462</b>
	15 7/8	65 3/4	54	266	40	<b>FN1666DGSO</b>	<b>\$4,276</b>

- white back painted glass doors
- grommet in bottom left and right and in top center of back panel
- tackboards available, see pages 476-477
- task lights available, see pages 532-533
- 22" vertical clearance from desk top to bottom of light soffit
- adjustable shelf
- optional modular top, see page 488
- locking doors not available
- pulls not available
- backside of unit intended to go against wall, cabinet should be secured to wall as a safety precaution

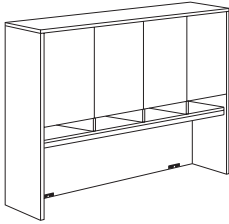
Description	D	W	H	CTN WT	CU FT	① Model	List Price
<b>Double Height Storage Overhead Cabinet with Four Doors and Cubbies</b> 	15 7/8	83 3/4	54	373	50	FN1684DSOC	\$4,475
	15 7/8	77 3/4	54	351	47	FN1678DSOC	\$4,350
	15 7/8	71 3/4	54	327	43	FN1672DSOC	\$4,254
	15 7/8	65 3/4	54	290	40	FN1666DSOC	\$4,152

- grommet in bottom left and right and in top center of back panel
- tackboards available, see pages 478-479
- task lights available, see pages 532-533
- 17 1/2" vertical clearance from desk top to bottom of light soffit
- adjustable shelf
- optional modular top, see page 488
- locking doors available, specify and add \$246 list
- no pulls
- backside of unit intended to go against wall, cabinet should be secured to wall as a safety precaution

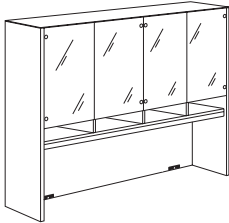
<b>Double Height Storage Overhead Cabinet with Four Glass Doors and Cubbies</b> 	15 7/8	83 3/4	54	377	50	FN1684DGSOC	\$5,401
	15 7/8	77 3/4	54	356	47	FN1678DGSOC	\$5,259
	15 7/8	71 3/4	54	331	43	FN1672DGSOC	\$5,144
	15 7/8	65 3/4	54	294	40	FN1666DGSOC	\$4,880

- white back painted glass doors
- grommet in bottom left and right and in top center of back panel
- tackboards available, see pages 478-479
- task lights available, see pages 532-533
- 17 1/2" vertical clearance from desk top to bottom of light soffit
- adjustable shelf
- optional modular top, see page 488
- locking doors not available
- pulls not available
- backside of unit intended to go against wall, cabinet should be secured to wall as a safety precaution

**To Order, Specify:**

- ① Model Number
- ② Wood Species - Cherry (CH1), Maple (MA1) or Walnut (WA1) (see page 436)
- ③ Finish Color - (see page 436)
- ④ Grommet Color - (see page 436)
- ⑤ Other Product Options (see page 429)

When ordering Quickship products, place a "Q" in front of model number.  
 Example: QFN3072DD

**NOW!**  
 Need it.  
 JSI Quickship

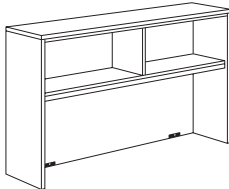
Description	D	W	H	CTN WT	CU FT	① Model	List Price
<b>Open Storage Overhead Cabinet</b>  	16	83 3/4	42	238	40	<b>FN168400</b>	\$2,978
	16	77 3/4	42	238	37	<b>FN167800</b>	\$2,921
	16	71 3/4	42	228	34	<b>FN167200</b>	\$2,862
	16	65 3/4	42	218	32	<b>FN166600</b>	\$2,734

- top edge profile on user side
- grommet in bottom left and right and in top center of back panel
- tackboards available, see pages 476-477
- task lights available, see pages 532-533
- 22" vertical clearance from desk top to bottom of light soffit

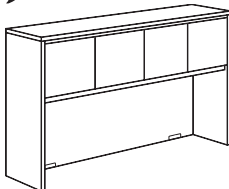
<b>Storage Overhead Cabinet with Four Doors</b>  	16	83 3/4	42	258	40	<b>FN1684S0</b>	\$3,087
	16	77 3/4	42	258	37	<b>FN1678S0</b>	\$3,030
	16	71 3/4	42	248	34	<b>FN1672S0</b>	\$2,972
	16	65 3/4	42	238	32	<b>FN1666S0</b>	\$2,847

- top edge profile on user side
- grommet in bottom left and right and in top center of back panel
- tackboards available, see pages 476-477
- task lights available, see pages 532-533
- 22" vertical clearance from desk top to bottom of light soffit
- locking doors available, specify and add \$246 list
- no pulls

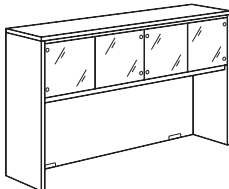
<b>Storage Overhead Cabinet with Four Glass Doors</b> 	16	83 3/4	42	258	40	<b>FN1684GS0</b>	\$3,555
	16	77 3/4	42	258	37	<b>FN1678GS0</b>	\$3,498
	16	71 3/4	42	248	34	<b>FN1672GS0</b>	\$3,442
	16	65 3/4	42	238	32	<b>FN1666GS0</b>	\$3,322

- top edge profile on user side
- white back painted glass doors
- grommet in bottom left and right and in top center of back panel
- tackboards available, see pages 476-477
- task lights available, see pages 532-533
- 22" vertical clearance from desk top to bottom of light soffit
- locking doors not available
- pulls not available



Description	D	W	H	CTN WT	CU FT	① Model	List Price
<b>Open Storage Overhead Cabinet with Cubbies</b> 	16	83 ¾	42	286	40	FN168400C	\$3,743
	16	77 ¾	42	271	37	FN167800C	\$3,629
	16	71 ¾	42	258	34	FN167200C	\$3,543
	16	65 ¾	42	246	32	FN166600C	\$3,335

**NOW!**

- top edge profile on user side
- grommet in bottom left and right and in top center of back panel
- tackboards available, see pages 478-479
- task lights available, see pages 532-533
- 17 ½" vertical clearance from desk top to bottom of light soffit

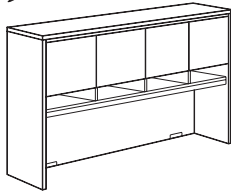
<b>Storage Overhead Cabinet with Four Doors and Cubbies</b> 	16	83 ¾	42	306	40	FN1684S0C	\$3,853
	16	77 ¾	42	291	37	FN1678S0C	\$3,742
	16	71 ¾	42	278	34	FN1672S0C	\$3,654
	16	65 ¾	42	266	32	FN1666S0C	\$3,393

**NOW!**

- top edge profile on user side
- grommet in bottom left and right and in top center of back panel
- tackboards available, see pages 478-479
- task lights available, see pages 532-533
- 17 ½" vertical clearance from desk top to bottom of light soffit
- locking doors available, specify and add \$246 list
- no pulls

<b>Storage Overhead Cabinet with Four Glass Doors and Cubbies</b> 	16	83 ¾	42	310	40	FN1684GS0C	\$4,317
	16	77 ¾	42	295	37	FN1678GS0C	\$4,208
	16	71 ¾	42	282	34	FN1672GS0C	\$4,124
	16	65 ¾	42	270	32	FN1666GS0C	\$3,922

- top edge profile on user side
- white back painted glass doors
- grommet in bottom left and right and in top center of back panel
- tackboards available, see pages 478-479
- task lights available, see pages 532-533
- 17 ½" vertical clearance from desk top to bottom of light soffit
- adjustable shelf
- locking doors not available
- pulls not available

**To Order, Specify:**

- ① Model Number
- ② Wood Species - Cherry (CH1), Maple (MA1) or Walnut (WA1) (see page 436)
- ③ Finish Color - (see page 436)
- ④ Edge Profile - (see page 436)
- ⑤ Grommet Color - (see page 436)
- ⑥ Other Product Options (see page 429)

When ordering Quickship products, place a "Q" in front of model number.  
 Example: QFN3072DD

**NOW!**  
 Need it.  
 JSI Quickship

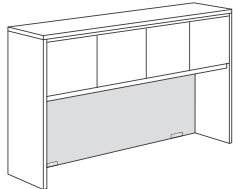
Description	D	W	H	CTN WT	CU FT	① Model	List Price Per Grade
<b>Tackboard for 84" w Storage Overhead Cabinet</b> 	3/8	81 1/4	17 1/8	3	4	<b>FN84TK</b>	<b>COM \$362</b> A \$396 B \$463 C \$579 D \$726 E \$874 F \$1,104 G \$1,354 H \$1,615 I \$2,027 J \$2,521

- for use with 84" wide storage overhead cabinet
- fabrics available, see pages 19-26 for selection
- com ydg: 2 3/4

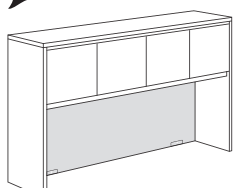
<b>Tackboard for 78" w Storage Overhead Cabinet</b> 	3/8	75 1/4	17 1/8	3	4	<b>FN78TK</b>	<b>COM \$358</b> A \$389 B \$449 C \$554 D \$689 E \$823 F \$1,032 G \$1,256 H \$1,496 I \$1,870 J \$2,320
---	-----	--------	--------	---	---	---------------	--

- for use with 78" wide storage overhead cabinet
- fabrics available, see pages 19-26 for selection
- com ydg: 2 1/2

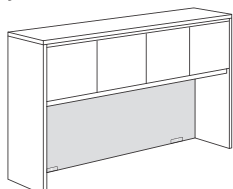
<b>Tackboard for 72" w Storage Overhead Cabinet</b> 	3/8	69 1/4	17 1/8	2	3	<b>FN72TK</b>	<b>COM \$336</b> A \$364 B \$418 C \$513 D \$633 E \$756 F \$944 G \$1,145 H \$1,360 I \$1,697 J \$2,101
---	-----	--------	--------	---	---	---------------	--

- for use with 72" wide storage overhead cabinet
- fabrics available, see pages 19-26 for selection
- com ydg: 2 1/4

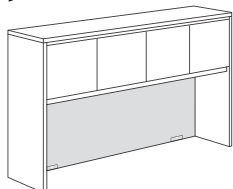
<b>Tackboard for 66" w Storage Overhead Cabinet</b> 	3/8	63 1/4	17 1/8	2	3	<b>FN66TK</b>	<b>COM \$316</b> A \$340 B \$387 C \$472 D \$579 E \$686 F \$854 G \$1,034 H \$1,224 I \$1,525 J \$1,886
---	-----	--------	--------	---	---	---------------	--

- for use with 66" wide storage overhead cabinet
- fabrics available, see pages 19-26 for selection
- com ydg: 2

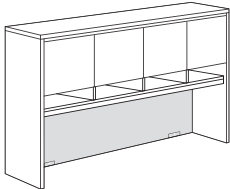
Description	D	W	H	CTN WT	CU FT	① Model	List Price Per Grade
<b>Tackboard for 84" w Storage Overhead Cabinet with Cubbies</b> 	3/8	81 1/4	12 1/8	3	2	FN84TKC	COM \$362 A \$396 B \$463 C \$579 D \$726 E \$874 F \$1,104 G \$1,354 H \$1,615 I \$2,027 J \$2,521

- for use with 84" wide storage overhead cabinet
- fabrics available, see pages 19-26 for selection
- com ydg: 2 3/4

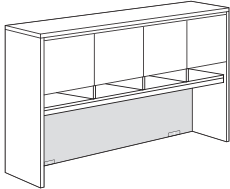
<b>Tackboard for 78" w Storage Overhead Cabinet with Cubbies</b> 	3/8	75 1/4	12 1/8	3	2	FN78TKC	COM \$358 A \$389 B \$449 C \$554 D \$689 E \$823 F \$1,032 G \$1,256 H \$1,496 I \$1,870 J \$2,320
---	-----	--------	--------	---	---	---------	---

- for use with 78" wide storage overhead cabinet
- fabrics available, see pages 19-26 for selection
- com ydg: 2 1/2

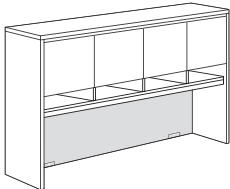
<b>Tackboard for 72" w Storage Overhead Cabinet with Cubbies</b> 	3/8	69 1/4	12 1/8	2	2	FN72TKC	COM \$336 A \$364 B \$418 C \$513 D \$633 E \$756 F \$944 G \$1,145 H \$1,360 I \$1,697 J \$2,101
---	-----	--------	--------	---	---	---------	---

- for use with 72" wide storage overhead cabinet
- fabrics available, see pages 19-26 for selection
- com ydg: 2 1/4

**To Order, Specify:**

- ① Model Number
- ② Fabric Selection: vendor, pattern color
- ③ Other Product Options (see page 429)

When ordering Quickship products, place a "Q" in front of model number.  
 Example: QFN3072DD

**NOW!**  
*Need it.*  
 JSI Quickship

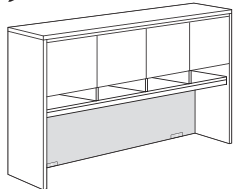
Description	D	W	H	CTN WT	CU FT	① Model	List Price Per Grade
<b>Tackboard for 66" w Storage Overhead Cabinet with Cubbies</b>  <p><b>NOW!</b></p> <ul style="list-style-type: none"> <li>· for use with 66" wide storage overhead cabinet</li> <li>· fabrics available, see pages 19-26 for selection</li> <li>· com ydg: 2</li> </ul>	3/8	63 1/4	12 1/8	2	2	<b>FN66TKC</b>	<b>COM \$316</b> A \$340 B \$387 C \$472 D \$579 E \$686 F \$854 G \$1,034 H \$1,224 I \$1,525 J \$1,886

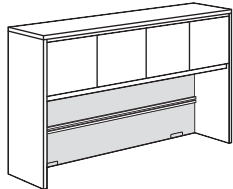
<b>Tackboard for Accessory Rail on 84" w Storage Overhead Cabinet</b>  <p><b>NOW!</b></p> <ul style="list-style-type: none"> <li>· tackboard panels for above and below accessory rail</li> <li>· not required; add-on for convenience application</li> <li>· fabrics available, see pages 19-26 for selection</li> <li>· upper tackboard height: 6 3/8</li> <li>· lower tackboard height: 7 1/2</li> <li>· coordinates with FN1684DSO, FN1684DGSO, FN168400, FN1684SO, FN1684GSO</li> <li>· accessory rail sold separately, see page 469</li> </ul>	3/8	81 1/4		3	4	<b>FN84TKA</b>	<b>COM \$404</b> A \$436 B \$503 C \$619 D \$765 E \$914 F \$1,145 G \$1,392 H \$1,655 I \$2,067 J \$2,561
---	-----	--------	--	---	---	----------------	--

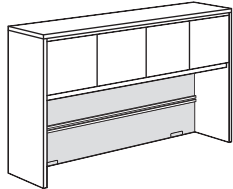
<b>Tackboard for Accessory Rail on 78" w Storage Overhead Cabinet</b>  <p><b>NOW!</b></p> <ul style="list-style-type: none"> <li>· tackboard panels for above and below accessory rail</li> <li>· not required; add-on for convenience application</li> <li>· fabrics available, see pages 19-26 for selection</li> <li>· upper tackboard height: 6 3/8</li> <li>· lower tackboard height: 7 1/2</li> <li>· coordinates with FN1678DSO, FN1678DGSO, FN167800, FN1678SO, FN1678GSO</li> <li>· accessory rail sold separately, see page 469</li> <li>· com ydg: 2 1/2</li> </ul>	3/8	75 1/4		3	4	<b>FN78TKA</b>	<b>COM \$396</b> A \$428 B \$486 C \$592 D \$727 E \$862 F \$1,071 G \$1,297 H \$1,537 I \$1,911 J \$2,358
---	-----	--------	--	---	---	----------------	--

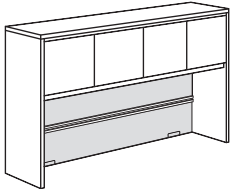
Description	D	W	H	CTN WT	CU FT	① Model	List Price Per Grade
<b>Tackboard for Accessory Rail on 72" w Storage Overhead Cabinet</b> 	3/8	69 1/4		2	3	FN72TKA	COM \$377
							A \$405
							B \$457
							C \$552
							D \$674
							E \$794
							F \$985
							G \$1,184
							H \$1,402
							I \$1,738
J \$2,141							

- tackboard panels for above and below accessory rail
- not required; add-on for convenience application
- fabrics available, see pages 19-26 for selection
- upper tackboard height: 6 3/8
- lower tackboard height: 7 1/2
- coordinates with FN1672DSO, FN1672DGSO, FN167200, FN1672SO, FN1672GSO
- accessory rail sold separately, see page 469
- com ydg: 2 1/4

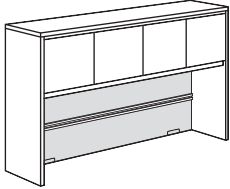
<b>Tackboard for Accessory Rail on 66" w Storage Overhead Cabinet</b> 	3/8	63 1/4		2	3	FN66TKA	COM \$353
							A \$379
							B \$426
							C \$509
							D \$618
							E \$725
							F \$893
							G \$1,072
							H \$1,263
							I \$1,563
J \$1,923							







- tackboard panels for above and below accessory rail
- not required; add-on for convenience application
- fabrics available, see pages 19-26 for selection
- upper tackboard height: 6 3/8
- lower tackboard height: 7 1/2
- coordinates with FN1666DSO, FN1666DGSO, FN166600, FN1666SO, FN1666GSO
- accessory rail sold separately, see page 469
- com ydg: 2

**To Order, Specify:**

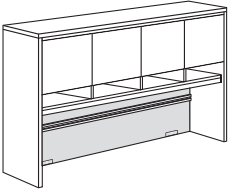
- ① Model Number
- ② Fabric Selection: vendor, pattern color
- ③ Other Product Options (see page 429)

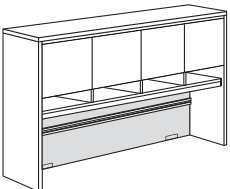
When ordering Quickship products, place a "Q" in front of model number.  
 Example: QFN3072DD

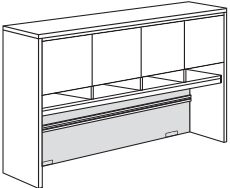
**NOW!**  
 Need it.  
 JSI Quickship

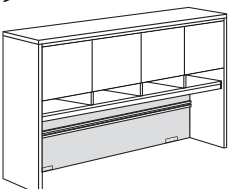
Description	D	W	H	CTN WT	CU FT	① Model	List Price Per Grade
<b>Tackboard for Accessory Rail on 84" w Storage Overhead Cabinet with Cubbies</b>  	3/8	81 1/4		3	2	FN84TKCA	COM \$404
							A \$436
							B \$503
							C \$619
							D \$765
							E \$914
							F \$1,145
							G \$1,392
							H \$1,655
							I \$2,067
J \$2,561							
<b>Tackboard for Accessory Rail on 78" w Storage Overhead Cabinet with Cubbies</b>  	3/8	75 1/4		3	2	FN78TKCA	COM \$396
							A \$428
							B \$486
							C \$592
							D \$727
							E \$862
							F \$1,071
							G \$1,297
							H \$1,537
							I \$1,911
J \$2,358							
<b>Tackboard for Accessory Rail on 72" w Storage Overhead Cabinet with Cubbies</b>  	3/8	69 1/4		2	2	FN72TKCA	COM \$377
							A \$405
							B \$457
							C \$552
							D \$674
							E \$794
							F \$985
							G \$1,184
							H \$1,402
							I \$1,738
J \$2,141							
<b>Tackboard for Accessory Rail on 66" w Storage Overhead Cabinet with Cubbies</b>  	3/8	63 1/4		2	2	FN66TKCA	COM \$353
							A \$379
							B \$426
							C \$509
							D \$618
							E \$725
							F \$893
							G \$1,072
							H \$1,263
							I \$1,563
J \$1,923							

- tackboard panels for above and below accessory rail
- not required; add-on for convenience application
- fabrics available, see pages 19-26 for selection
- upper tackboard height: 2 1/4
- lower tackboard height: 7 1/2
- coordinates with FN1684DSOC, FN1684DGSOC, FN16840OC, FN1684SOC, FN1684GSOC
- accessory rail sold separately, see page 469
- com ydg: 2 3/4

- tackboard panels for above and below accessory rail
- not required; add-on for convenience application
- fabrics available, see pages 19-26 for selection
- upper tackboard height: 2 1/4
- lower tackboard height: 7 1/2
- coordinates with FN1678DSOC, FN1678DGSOC, FN16780OC, FN1678SOC, FN1678GSOC
- accessory rail sold separately, see page 469
- com ydg: 2 1/2

- tackboard panels for above and below accessory rail
- not required; add-on for convenience application
- fabrics available, see pages 19-26 for selection
- upper tackboard height: 2 1/4
- lower tackboard height: 7 1/2
- coordinates with FN1672DSOC, FN1672DGSOC, FN16720OC, FN1672SOC, FN1672GSOC
- accessory rail sold separately, see page 469
- com ydg: 2 1/4

- tackboard panels for above and below accessory rail
- not required; add-on for convenience application
- fabrics available, see pages 19-26 for selection
- upper tackboard height: 2 1/4
- lower tackboard height: 7 1/2
- coordinates with FN1666DSOC, FN1666DGSOC, FN16660OC, FN1666SOC, FN1666GSOC
- accessory rail sold separately, see page 469
- com ydg: 2









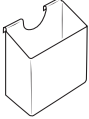

Description	D	W	H	CTN WT	CU FT	① Model	List Price Per Grade
<b>Accessory Rails</b> 	3/4	81 1/4	3 1/4	6	2	<b>FN84AR</b> For use on: • FN1684DGSO • FN168400 • FN1684DSO • FN1684SO • FN1684GSO	\$386
	3/4	75 1/4	3 1/4	5	2	<b>FN78AR</b> For use on: • FN1678DGSO • FN167800 • FN1678DSO • FN1678SO • FN1678GSO	\$367
	3/4	69 1/4	3 1/4	5	2	<b>FN72AR</b> For use on: • FN1672DGSO • FN167200 • FN1672DSO • FN1672SO • FN1672GSO	\$349
	3/4	63 1/4	3 1/4	4	2	<b>FN66AR</b> For use on: • FN1666DGSO • FN166600 • FN1666DSO • FN1666SO • FN1666GSO	\$330

**To Order, Specify:**

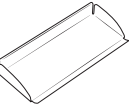
- ① Model Number
- ② Fabric Selection: vendor, pattern color
- ③ Other Product Options (see page 429)

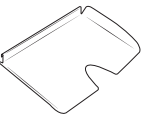
When ordering Quickship products, place a "Q" in front of model number.  
 Example: QFN3072DD

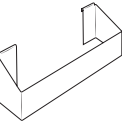
**NOW!**  
*Need it.*  
 JSI Quickship

Description	D	W	H	CTN WT	CU FT	① Model	List Price
<b>Upright Tray</b>   <ul style="list-style-type: none"> <li>· pen and gadget cup</li> <li>· Stardust Silver finish</li> </ul>	1 9/16	3 1/8	3 9/16	1	1	AC203CUP	\$95
<b>Small Tray</b>   <ul style="list-style-type: none"> <li>· tray for paper clips and other small items</li> <li>· Stardust Silver finish</li> </ul>	3 5/16	2 11/16	7/8	1	1	AC403TRAY	\$72
<b>Pencil Tray</b>   <ul style="list-style-type: none"> <li>· tray for pencils and other small items</li> <li>· Stardust Silver finish</li> </ul>	3 5/16	7 11/16	7/8	1	1	AC408TRAY	\$87
<b>Paper Tray</b>   <ul style="list-style-type: none"> <li>· tray for 8 1/2 x 11" letter paper size</li> <li>· Stardust Silver finish</li> </ul>	9 15/16	13 3/16	7/8	2	1	AC912PAP	\$133
<b>File Hanger</b>   <ul style="list-style-type: none"> <li>· file hanger for 8 1/2 x 11" letter size hanging file folders</li> <li>· Stardust Silver finish</li> </ul>	2 13/16	12 3/16	4	1	1	AC313FILE	\$127
<b>Acrylic Accessory Tray</b>   <ul style="list-style-type: none"> <li>· set of 4</li> </ul>	12 1/4	9 1/4	2 1/4	5	1	ALT0912C	\$335

FINALE



Description	D	W	H	CTN WT	CU FT	① Model	List Price
Double Height Wall Mount Open Overhead	15 7/8	41 3/4	31 1/2	125	16	FN1642DWMO	\$1,578
	15 7/8	35 3/4	31 1/2	108	14	FN1636DWMO	\$1,431
	15 7/8	29 3/4	31 1/2	99	12	FN1630DWMO	\$1,259

NOW!

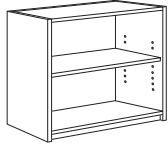

- supported by wall cleat - hardware provided by installer
- adjustable shelf
- optional modular top, see page 484

Double Height Wall Mount Overhead Cabinet with Two Doors	15 7/8	41 3/4	31 1/2	125	16	FN1642DWMS	\$2,215
	15 7/8	35 3/4	31 1/2	113	14	FN1636DWMS	\$2,064
	15 7/8	29 3/4	31 1/2	105	12	FN1630DWMS	\$1,925

NOW!

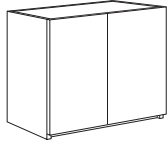

- supported by wall cleat - hardware provided by installer
- adjustable shelf
- locking doors available, specify and add \$123 list
- optional modular top, see page 484
- no pulls

Double Height Wall Mount Overhead Cabinet with Two Glass Doors	15 7/8	41 3/4	31 1/2	135	16	FN1642DGWMS	\$2,506
	15 7/8	35 3/4	31 1/2	115	14	FN1636DGWMS	\$2,356
	15 7/8	29 3/4	31 1/2	107	12	FN1630DGWMS	\$2,220

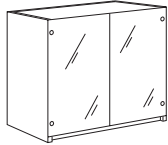

- white back painted glass doors
- supported by wall cleat - hardware provided by installer
- adjustable shelf
- optional modular top, see page 484
- locking doors not available
- pulls not available

**To Order, Specify:**

- ① Model Number
- ② Wood Species - Cherry (CH1), Maple (MA1) or Walnut (WA1) (see page 436)
- ③ Finish Color - (see page 436)
- ④ Other Product Options (see page 429)

When ordering Quickship products, place a "Q" in front of model number.  
Example: QFN3072DD

**NOW!**  
Need it.  
JSI Quickship

Description	D	W	H	CTN WT	CU FT	① Model	List Price
Double Height Wall Mount Open Overhead with Cubbies	15 7/8	41 3/4	36 1/2	140	18	FN1642DWMOC	\$1,894
	15 7/8	35 3/4	36 1/2	128	16	FN1636DWMOC	\$1,748
	15 7/8	29 3/4	36 1/2	119	13	FN1630DWMOC	\$1,579

**NOW!**



- supported by wall cleat - hardware provided by installer
- adjustable shelf
- optional modular top, see page 484

Double Height Wall Mount Overhead Cabinet with Two Doors and Cubbies	15 7/8	41 3/4	36 1/2	150	18	FN1642DWMSC	\$2,532
	15 7/8	35 3/4	36 1/2	136	16	FN1636DWMSC	\$2,381
	15 7/8	29 3/4	36 1/2	127	13	FN1630DWMSC	\$2,243

**NOW!**

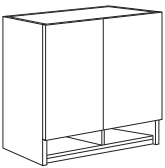

- supported by wall cleat - hardware provided by installer
- adjustable shelf
- locking doors available, specify and add \$123 list
- optional modular top, see page 484
- no pulls

Double Height Wall Mount Overhead Cabinet with Two Glass Doors and Cubbies	15 7/8	41 3/4	36 1/2	160	18	FN1642DGWMSC	\$2,825
	15 7/8	35 3/4	36 1/2	143	16	FN1636DGWMSC	\$2,674
	15 7/8	29 3/4	36 1/2	134	13	FN1630DGWMSC	\$2,537

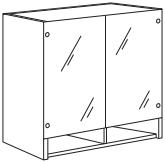

- white back painted glass doors
- supported by wall cleat - hardware provided by installer
- adjustable shelf
- optional modular top, see page 484
- locking doors not available
- pulls not available

Description	D	W	H	CTN WT	CU FT	① Model	List Price
Wall Mount Open Overhead	16	71 ¾	19 ½	155	17	FN1672WMO	\$2,309
<b>NOW!</b>	16	65 ¾	19 ½	115	16	FN1666WMO	\$2,196

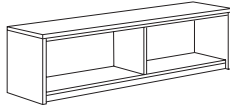

- top edge profile on user side
- supported by wall cleat - hardware provided by installer

Wall Mount Open Overhead	16	41 ¾	19 ½	95	10	FN1642WMO	\$1,262
<b>NOW!</b>	16	35 ¾	19 ½	80	9	FN1636WMO	\$1,147
	16	29 ¾	19 ½	65	8	FN1630WMO	\$1,009

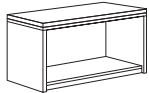

- top edge profile on user side
- supported by wall cleat - hardware provided by installer

Wall Mount Overhead Cabinet with Four Doors	16	71 ¾	19 ½	170	17	FN1672WMS	\$2,425
	16	65 ¾	19 ½	130	16	FN1666WMS	\$2,312

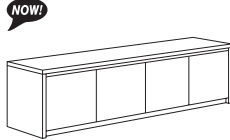

- top edge profile on user side
- supported by wall cleat - hardware provided by installer
- locking doors available, specify and add \$246 list
- no pulls

Wall Mount Overhead Cabinet with Two Doors	16	41 ¾	19 ½	95	10	FN1642WMS	\$1,826
<b>NOW!</b>	16	35 ¾	19 ½	85	9	FN1636WMS	\$1,652
	16	29 ¾	19 ½	70	8	FN1630WMS	\$1,540

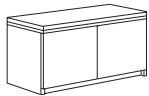

- top edge profile on user side
- supported by wall cleat - hardware provided by installer
- locking doors available, specify and add \$123 list
- no pulls

**To Order, Specify:**

- ① Model Number
- ② Wood Species - Cherry (CH1), Maple (MA1) or Walnut (WA1) (see page 436)
- ③ Finish Color - (see page 436)
- ④ Edge Profile - (see page 436)
- ⑤ Other Product Options (see page 429)

When ordering Quickship products, place a "Q" in front of model number.  
Example: QFN3072DD

**NOW!**  
Need it.  
JSI Quickship

Description	D	W	H	CTN WT	CU FT	① Model	List Price
<b>Wall Mount Overhead Cabinet with Four Glass Doors</b>	16	71 ¾	19 ½	175	17	FN1672GWMS	\$3,009
	16	65 ¾	19 ½	135	16	FN1666GWMS	\$2,896

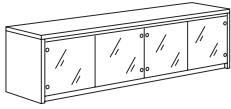

- top edge profile on user side
- supported by wall cleat - hardware provided by installer
- white back painted glass doors
- locking doors not available
- pulls not available

<b>Wall Mount Overhead Cabinet with Two Glass Doors</b>	16	41 ¾	19 ½	100	10	FN1642GWMS	\$2,234
	16	35 ¾	19 ½	86	9	FN1636GWMS	\$1,943
	16	29 ¾	19 ½	72	8	FN1630GWMS	\$1,832



- top edge profile on user side
- supported by wall cleat - hardware provided by installer
- white back painted glass doors
- locking doors not available
- pulls not available

<b>Wall Mount Open Overhead with Cubbies</b>	16	71 ¾	24 ½	182	21	FN1672WMOC	\$2,626
	16	65 ¾	24 ½	170	19	FN1666WMOC	\$2,512

**NOW!**

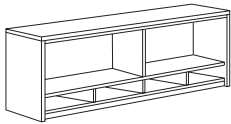

- top edge profile on user side
- supported by wall cleat - hardware provided by installer

<b>Wall Mount Open Overhead with Cubbies</b>	16	41 ¾	24 ½	120	12	FN1642WMOC	\$1,581
	16	35 ¾	24 ½	98	11	FN1636WMOC	\$1,466
	16	29 ¾	24 ½	85	9	FN1630WMOC	\$1,327

**NOW!**

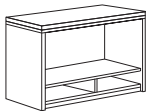

- top edge profile on user side
- supported by wall cleat - hardware provided by installer

Description	D	W	H	CTN WT	CU FT	1 Model	List Price
Wall Mount Overhead Cabinet with Four Doors and Cubbies	16	71 3/4	24 1/2	201	21	FN1672WMSC	\$2,741
	16	65 3/4	24 1/2	188	19	FN1666WMSC	\$2,631

**NOW!**

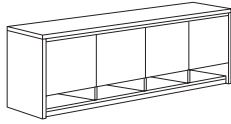

- top edge profile on user side
- supported by wall cleat - hardware provided by installer
- locking doors available, specify and add \$246 list
- no pulls

Wall Mount Overhead Cabinet with Two Doors and Cubbies	16	41 3/4	24 1/2	120	12	FN1642WMSC	\$2,144
	16	35 3/4	24 1/2	108	11	FN1636WMSC	\$1,969
	16	29 3/4	24 1/2	92	9	FN1630WMSC	\$1,857

**NOW!**

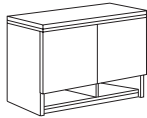

- top edge profile on user side
- supported by wall cleat - hardware provided by installer
- locking doors available, specify and add \$123 list
- no pulls

Wall Mount Overhead Cabinet with Four Glass Doors and Cubbies	16	71 3/4	24 1/2	206	21	FN1672GWMSC	\$3,328
	16	65 3/4	24 1/2	193	19	FN1666GWMSC	\$3,213

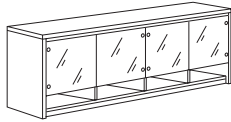

- top edge profile on user side
- supported by wall cleat - hardware provided by installer
- white back painted glass doors
- locking doors not available
- pulls not available

Wall Mount Overhead Cabinet with Two Glass Doors and Cubbies	16	41 3/4	24 1/2	125	12	FN1642GWMSC	\$2,555
	16	35 3/4	24 1/2	112	11	FN1636GWMSC	\$2,260
	16	29 3/4	24 1/2	96	9	FN1630GWMSC	\$2,152









- top edge profile on user side
- supported by wall cleat - hardware provided by installer
- white back painted glass doors
- locking doors not available
- pulls not available

**To Order, Specify:**

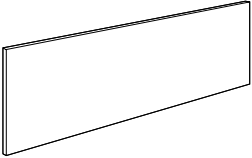
- 1 Model Number
- 2 Wood Species - Cherry (CH1), Maple (MA1)  
or Walnut (WA1) (see page 436)
- 3 Finish Color - (see page 436)
- 4 Edge Profile - (see page 436)
- 5 Other Product Options (see page 429)

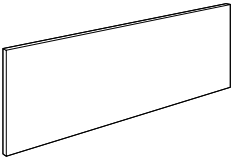
When ordering Quickship products, place a "Q" in front of model number.  
Example: QFN3072DD

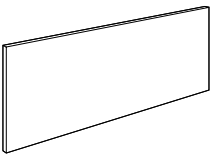
**NOW!**  
Need it.  
JSI Quickship

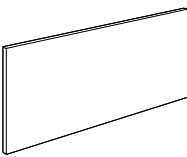
Description	D	W	H	CTN WT	CU FT	① Model	List Price Per Grade
<b>84" w Wall Mount Tackboard</b>  	1 ½	83 ¾	21 ½	2	4	<b>FN8420WT</b>	COM \$435 A \$470 B \$535 C \$651 D \$797 E \$946 F \$1,178 G \$1,425 H \$1,688 I \$2,099 J \$2,593
<ul style="list-style-type: none"> <li>· fabrics available, see pages 19-26 for selection</li> <li>· com ydg: 2 ¾</li> </ul>							
<b>78" w Wall Mount Tackboard</b>  	1 ½	77 ¾	21 ½	2	4	<b>FN7820WT</b>	COM \$430 A \$460 B \$521 C \$627 D \$761 E \$895 F \$1,103 G \$1,330 H \$1,569 I \$1,944 J \$2,391
<ul style="list-style-type: none"> <li>· fabrics available, see pages 19-26 for selection</li> <li>· com ydg: 2 ½</li> </ul>							
<b>72" w Wall Mount Tackboard</b>  	1 ½	71 ¾	21 ½	2	3	<b>FN7220WT</b>	COM \$409 A \$437 B \$490 C \$587 D \$707 E \$829 F \$1,016 G \$1,218 H \$1,434 I \$1,771 J \$2,175
<ul style="list-style-type: none"> <li>· fabrics available, see pages 19-26 for selection</li> <li>· com ydg: 2 ¼</li> </ul>							
<b>66" w Wall Mount Tackboard</b>  	1 ½	65 ¾	21 ½	2	3	<b>FN6620WT</b>	COM \$387 A \$411 B \$458 C \$543 D \$651 E \$759 F \$926 G \$1,104 H \$1,298 I \$1,598 J \$1,955
<ul style="list-style-type: none"> <li>· fabrics available, see pages 19-26 for selection</li> <li>· com ydg: 2</li> </ul>							

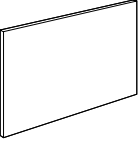
Description	D	W	H	CTN WT	CU FT	① Model	List Price Per Grade
<b>42" w Wall Mount Tackboard</b>   <ul style="list-style-type: none"> <li>· fabrics available, see pages 19-26 for selection</li> <li>· com ydg: 1 1/2</li> </ul>	1 1/2	41 3/4	21 1/2	2	2	<b>FN4220WT</b>	<b>COM \$332</b> A \$352 B \$387 C \$450 D \$530 E \$610 F \$737 G \$872 H \$1,015 I \$1,241 J \$1,510

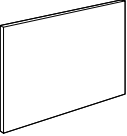
<b>36" w Wall Mount Tackboard</b>   <ul style="list-style-type: none"> <li>· fabrics available, see pages 19-26 for selection</li> <li>· com ydg: 1 1/4</li> </ul>	1 1/2	35 3/4	21 1/2	2	2	<b>FN3620WT</b>	<b>COM \$304</b> A \$321 B \$351 C \$404 D \$472 E \$539 F \$641 G \$757 H \$875 I \$1,062 J \$1,285
---	-------	--------	--------	---	---	-----------------	--

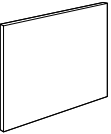





<b>30" w Wall Mount Tackboard</b>   <ul style="list-style-type: none"> <li>· fabrics available, see pages 19-26 for selection</li> <li>· com ydg: 1</li> </ul>	1 1/2	29 3/4	21 1/2	2	2	<b>FN3020WT</b>	<b>COM \$282</b> A \$296 B \$319 C \$360 D \$415 E \$470 F \$552 G \$641 H \$737 I \$889 J \$1,068
---	-------	--------	--------	---	---	-----------------	--

**To Order, Specify:**

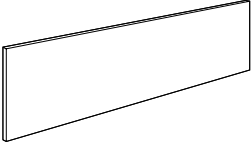
- ① Model Number
- ② Fabric Selection: vendor, pattern color
- ③ Other Product Options (see page 429)

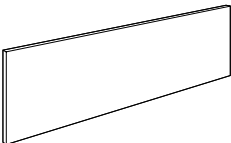
When ordering Quickship products, place a "Q" in front of model number.  
 Example: QFN3072DD

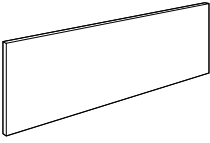
 *Need it.*  
 JSI Quickship

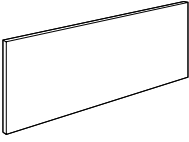
Description	D	W	H	CTN WT	CU FT	① Model	List Price Per Grade
<b>84" w Wall Mount Tackboard for Overhead Cabinet with Cubbies</b>  	1 ½	83 ¾	16 ½	3	3	<b>FN84WTC</b>	COM \$435 A \$470 B \$535 C \$651 D \$797 E \$946 F \$1,178 G \$1,425 H \$1,688 I \$2,099 J \$2,593
<ul style="list-style-type: none"> <li>· fabrics available, see pages 19-26 for selection</li> <li>· com ydg: 2 ¾</li> </ul>							
<b>78" w Wall Mount Tackboard for Overhead Cabinet with Cubbies</b>  	1 ½	77 ¾	16 ½	3	3	<b>FN78WTC</b>	COM \$430 A \$460 B \$521 C \$627 D \$761 E \$895 F \$1,103 G \$1,330 H \$1,569 I \$1,944 J \$2,391
<ul style="list-style-type: none"> <li>· fabrics available, see pages 19-26 for selection</li> <li>· com ydg: 2 ½</li> </ul>							
<b>72" w Wall Mount Tackboard for Overhead Cabinet with Cubbies</b>  	1 ½	71 ¾	16 ½	2	2	<b>FN72WTC</b>	COM \$409 A \$437 B \$490 C \$587 D \$707 E \$829 F \$1,016 G \$1,218 H \$1,434 I \$1,771 J \$2,175
<ul style="list-style-type: none"> <li>· fabrics available, see pages 19-26 for selection</li> <li>· com ydg: 2 ¼</li> </ul>							
<b>66" w Wall Mount Tackboard for Overhead Cabinet with Cubbies</b>  	1 ½	65 ¾	16 ½	2	2	<b>FN66WTC</b>	COM \$387 A \$411 B \$458 C \$543 D \$651 E \$759 F \$926 G \$1,104 H \$1,298 I \$1,598 J \$1,955
<ul style="list-style-type: none"> <li>· fabrics available, see pages 19-26 for selection</li> <li>· com ydg: 2</li> </ul>							

FINALE

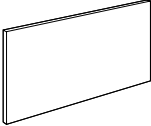

Description	D	W	H	CTN WT	CU FT	① Model	List Price Per Grade
<b>42" w Wall Mount Tackboard for Overhead Cabinet with Cubbies</b>  	1 1/2	41 3/4	16 1/2	2	2	<b>FN42WTC</b>	COM \$332
							A \$352
	<ul style="list-style-type: none"> <li>· fabrics available, see pages 19-26 for selection</li> <li>· com ydg: 1 1/2</li> </ul>						B \$387
							C \$450
							D \$530
							E \$610
							F \$737
							G \$872
							H \$1,015
							I \$1,241
						J \$1,510	

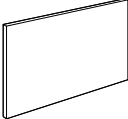
<b>36" w Wall Mount Tackboard for Overhead Cabinet with Cubbies</b>  	1 1/2	35 3/4	16 1/2	2	2	<b>FN36WTC</b>	COM \$304
							A \$321
	<ul style="list-style-type: none"> <li>· fabrics available, see pages 19-26 for selection</li> <li>· com ydg: 1 1/4</li> </ul>						B \$351
							C \$404
							D \$472
							E \$539
							F \$641
							G \$757
							H \$875
							I \$1,062
						J \$1,285	

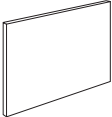
<b>30" w Wall Mount Tackboard for Overhead Cabinet with Cubbies</b>  	1 1/2	29 3/4	16 1/2	2	2	<b>FN30WTC</b>	COM \$282
							A \$296
	<ul style="list-style-type: none"> <li>· fabrics available, see pages 19-26 for selection</li> <li>· com ydg: 1</li> </ul>						B \$319
							C \$360
							D \$415
							E \$470
							F \$552
							G \$641
							H \$737
							I \$889
						J \$1,068	

**To Order, Specify:**

- ① Model Number
- ② Fabric Selection: vendor, pattern color
- ③ Other Product Options (see page 429)

When ordering Quickship products, place a "Q" in front of model number.  
Example: QFN3072DD

 *Need it.*  
JSI Quickship

Description	D	W	H	CTN WT	CU FT	① Model	List Price
-------------	---	---	---	-----------	----------	---------	------------

**Double Height Open Storage Tower**

15 7/8	18	54	126	12	<b>FN1618DSO</b>	<b>\$1,405</b>
--------	----	----	-----	----	------------------	----------------

**NOW!**

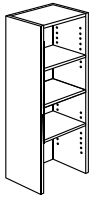

- fixed center shelf, two adjustable shelves
- one back panel grommet
- optional modular top, see page 488
- cannot be wall mounted

**Double Height Storage Tower with 54" h Door**

15 7/8	18	54	145	12	<b>FN1618SDR</b>	<b>\$1,518</b>
15 7/8	18	54	145	12	<b>FN1618SDL</b>	<b>\$1,518</b>

**NOW!**

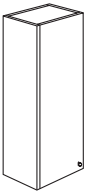

left shown

- one fixed shelf, two adjustable shelves
- one back panel grommet
- locking door available, specify and add \$123 list
- optional modular top, see page 488
- pull knob
- cannot be wall mounted

**Double Height Storage Tower with 54" h Glass Door**

15 7/8	18	54	147	12	<b>FN1618DGS DR</b>	<b>\$1,809</b>
15 7/8	18	54	147	12	<b>FN1618DGS DL</b>	<b>\$1,809</b>

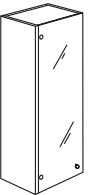

left shown

- white back painted glass doors
- one fixed shelf, two adjustable shelves
- one back panel grommet
- locking door not available
- optional modular top, see page 488
- pull knob
- cannot be wall mounted

Description	D	W	H	CTN WT	CU FT	① Model	List Price
-------------	---	---	---	-----------	----------	---------	------------

<b>Double Height Open Storage Tower</b>	15 <sup>7</sup> / <sub>8</sub>	35 <sup>7</sup> / <sub>8</sub>	54	175	23	<b>FN1636DSO</b>	<b>\$1,460</b>
---	--------------------------------	--------------------------------	----	-----	----	------------------	----------------

**NOW!**

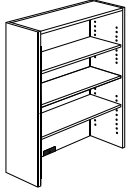

- fixed center shelf, two adjustable shelves
- one back panel grommet
- optional modular top, see page 488
- not to be used with lateral file or storage cabinet
- to be used with credenza
- cannot be wall mounted

<b>Double Height Storage Tower with 54" h Doors</b>	15 <sup>7</sup> / <sub>8</sub>	35 <sup>7</sup> / <sub>8</sub>	54	210	23	<b>FN1636DSD</b>	<b>\$2,403</b>
---	--------------------------------	--------------------------------	----	-----	----	------------------	----------------

**NOW!**

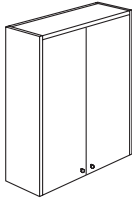

- one fixed shelf, two adjustable shelves
- one back panel grommet
- locking doors available, specify and add \$123 list
- optional modular top, see page 488
- pull knob
- not to be used with lateral file or storage cabinet
- to be used with credenza
- cannot be wall mounted

<b>Double Height Storage Tower with 54" h Glass Doors</b>	15 <sup>7</sup> / <sub>8</sub>	35 <sup>7</sup> / <sub>8</sub>	54	212	23	<b>FN1636DGS</b>	<b>\$2,694</b>
---	--------------------------------	--------------------------------	----	-----	----	------------------	----------------

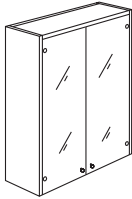

- white back painted glass doors
- one fixed shelf, two adjustable shelves
- one back panel grommet
- locking doors not available
- optional modular top, see page 488
- pull knob
- not to be used with lateral file or storage cabinet
- to be used with credenza
- cannot be wall mounted

**To Order, Specify:**

- ① Model Number
- ② Wood Species - Cherry (CH1), Maple (MA1) or Walnut (WA1) (see page 436)
- ③ Finish Color - (see page 436)
- ④ Knob Color - Matte Black (MBK) or Matte Nickel (MNK) (see page 436)
- ⑤ Other Product Options (see page 429)

When ordering Quickship products, place a "Q" in front of model number.  
Example: QFN3072DD

**NOW!**  
*Need it.*  
JSI Quickship

Description	D	W	H	CTN WT	CU FT	① Model	List Price
Open Storage Tower	16	18	42	98	10	FN1618SO	\$1,124

**NOW!**

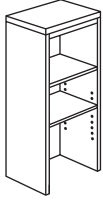

- top edge profile on user side
- fixed top shelf, one adjustable shelf
- one back panel grommet
- cannot be wall mounted

Storage Tower with 42" h Door	16	18	42	113	10	FN1618SDR	\$1,214
	16	18	42	113	10	FN1618SDL	\$1,214

**NOW!**



- top edge profile on user side
- one fixed shelf, one adjustable shelf
- one back panel grommet
- locking door available, specify and add \$123 list
- pull knob
- cannot be wall mounted

Storage Tower with 42" h Glass Door	16	18	42	114	10	FN1618GSDR	\$1,509
	16	18	42	114	10	FN1618GSDL	\$1,509

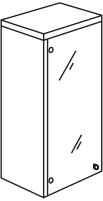

- top edge profile on user side
- white back painted glass doors
- one fixed shelf, one adjustable shelf
- one back panel grommet
- locking door not available
- pull knob
- cannot be wall mounted

Storage Tower	14	15 3/4	21	18	4	FN2116ST	\$1,027
---------------	----	--------	----	----	---	----------	---------

**NOW!**

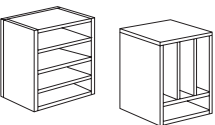

- veneer unit, not available in laminate
- paper management slots can be configured horizontally or with three vertical slots
- can be installed in storage tower or under storage overhead cabinet
- cannot be used with cubbies

Description	D	W	H	CTN WT	CU FT	① Model	List Price
Open Storage Tower	16	35 7/8	42	136	18	FN1636SO	\$1,169

**NOW!**

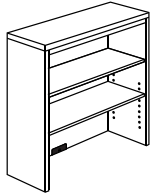

- top edge profile on user side
- fixed top shelf, one adjustable shelf
- one back panel grommet
- not to be used with lateral file or storage cabinet
- to be used with credenza
- cannot be wall mounted

Storage Tower with 42" h Doors	16	35 7/8	42	166	18	FN1636SD	\$1,923
--------------------------------	----	--------	----	-----	----	----------	---------

**NOW!**

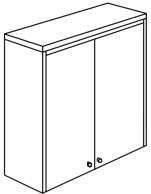

- top edge profile on user side
- one fixed shelf, one adjustable shelf
- one back panel grommet
- locking doors available, specify and add \$123 list
- pull knob
- not to be used with lateral file or storage cabinet
- to be used with credenza
- cannot be wall mounted

Storage Tower with 42" h Glass Doors	16	35 7/8	42	168	18	FN1636GSD	\$2,216
--------------------------------------	----	--------	----	-----	----	-----------	---------



- top edge profile on user side
- white back painted glass doors
- one fixed shelf, one adjustable shelf
- one back panel grommet
- locking doors not available
- pull knob
- not to be used with lateral file or storage cabinet
- to be used with credenza
- cannot be wall mounted

**To Order, Specify:**

- ① Model Number
- ② Wood Species - Cherry (CH1), Maple (MA1) or Walnut (WA1) (see page 436)
- ③ Finish Color - (see page 436)
- ④ Edge Profile - (see page 436)
- ⑤ Knob Color - Matte Black (MBK) or Matte Nickel (MNK) (see page 436)
- ⑥ Other Product Options (see page 429)

When ordering Quickship products, place a "Q" in front of model number.  
Example: QFN3072DD

**NOW!**  
*Need it.*  
JSI Quickship

Description	D	W	H	CTN WT	CU FT	① Model	List Price
-------------	---	---	---	-----------	----------	---------	------------

<b>Bookcase Overhead</b>	16	35 $\frac{3}{8}$	42	100	18	<b>FN1636B0</b>	<b>\$1,124</b>
--------------------------	----	------------------	----	-----	----	-----------------	----------------



- top edge profile on user side
- one back panel grommet
- compatible with FN3630SC and FN3630LF; see pages 457 and 491

<b>Storage Tower</b>	16	35 $\frac{3}{8}$	42	166	18	<b>FN1636BD</b>	<b>\$1,829</b>
----------------------	----	------------------	----	-----	----	-----------------	----------------

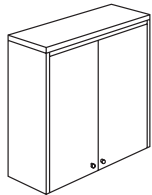

- top edge profile on user side
- one fixed shelf, one adjustable shelf
- one back panel grommet
- locking doors available, specify and add \$123 list
- pull knob
- compatible with FN3630SC and FN3630LF; see pages 457 and 491

<b>Glass Door Storage Tower</b>	16	35 $\frac{3}{8}$	42	168	18	<b>FN1636GBD</b>	<b>\$2,129</b>
---------------------------------	----	------------------	----	-----	----	------------------	----------------

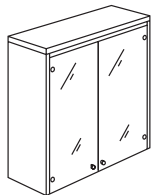

- top edge profile on user side
- white back painted glass doors
- one fixed shelf, one adjustable shelf
- one back panel grommet
- locking doors not available
- pull knob
- compatible with FN3630SC and FN3630LF; see pages 457 and 491

Description	D	W	H	CTN WT	CU FT	① Model	List Price
Double Height Bridge Mount Open Overhead	15 7/8	35 3/4	31 1/2	108	13	FN1636DBMO	\$1,431
	15 7/8	29 3/4	31 1/2	99	12	FN1630DBMO	\$1,259

**NOW!**

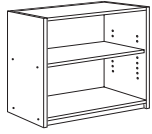

- supported by two storage towers
- adjustable shelf
- optional modular top, see page 488
- cannot be wall mounted

Double Height Bridge Mount Overhead Cabinet with Two Doors	15 7/8	35 3/4	31 1/2	113	14	FN1636DBMS	\$2,064
	15 7/8	29 3/4	31 1/2	105	12	FN1630DBMS	\$1,925

**NOW!**

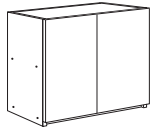

- supported by two storage towers
- adjustable shelf
- locking doors available, specify and add \$123 list
- optional modular top, see page 488
- no pulls
- cannot be wall mounted

Double Height Bridge Mount Overhead Cabinet with Two Glass Doors	15 7/8	35 3/4	31 1/2	115	14	FN1636DGBMS	\$2,356
	15 7/8	29 3/4	31 1/2	107	12	FN1630DGBMS	\$2,220

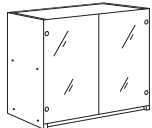

- white back painted glass doors
- supported by two storage towers
- adjustable shelf
- optional modular top, see page 488
- locking doors not available
- pulls not available
- cannot be wall mounted

**To Order, Specify:**

- ① Model Number
- ② Wood Species - Cherry (CH1), Maple (MA1) or Walnut (WA1) (see page 436)
- ③ Finish Color - (see page 436)
- ④ Edge Profile - (see page 436)
- ⑤ Knob Color - Matte Black (MBK) or Matte Nickel (MNK) (see page 436)
- ⑥ Other Product Options (see page 429)

When ordering Quickship products, place a "Q" in front of model number.  
Example: QFN3072DD

**NOW!**  
*Need it.*  
JSI Quickship

Description	D	W	H	CTN WT	CU FT	① Model	List Price
<b>Double Height Bridge Mount Open Overhead with Cubbies</b>	15 7/8	35 3/4	36 1/2	128	14	<b>FN1636DBMOC</b>	<b>\$1,748</b>
	15 7/8	29 3/4	36 1/2	119	12	<b>FN1630DBMOC</b>	<b>\$1,579</b>

**NOW!**



- supported by two storage towers
- adjustable shelf
- optional modular top, see page 484
- cannot be wall mounted

<b>Double Height Bridge Mount Overhead Cabinet with Two Doors and Cubbies</b>	15 7/8	35 3/4	36 1/2	136	16	<b>FN1636DBMSC</b>	<b>\$2,381</b>
	15 7/8	29 3/4	36 1/2	127	13	<b>FN1630DBMSC</b>	<b>\$2,243</b>

**NOW!**

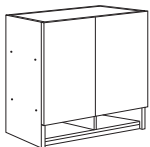

- supported by two storage towers
- adjustable shelf
- locking doors available, specify and add \$123 list
- optional modular top, see page 484
- no pulls
- cannot be wall mounted

<b>Double Height Bridge Mount Overhead Cabinet with Two Glass Doors and Cubbies</b>	15 7/8	35 3/4	36 1/2	143	16	<b>FN1636DGBMSC</b>	<b>\$2,674</b>
	15 7/8	29 3/4	36 1/2	134	13	<b>FN1630DGBMSC</b>	<b>\$2,537</b>

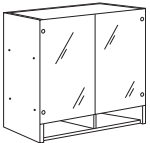

- white back painted glass doors
- supported by two storage towers
- adjustable shelf
- optional modular top, see page 484
- locking doors not available
- pulls not available
- cannot be wall mounted



Description	D	W	H	CTN WT	CU FT	① Model	List Price
Bridge Mount Open Overhead	16	35 ¾	19 ½	80	9	FN1636BMO	\$1,147
<b>NOW!</b>	16	29 ¾	19 ½	65	8	FN1630BMO	\$1,009

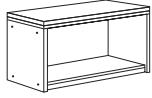

- top edge profile on user side
- supported by two storage towers
- cannot be wall mounted

Bridge Mount Overhead Cabinet with Two Doors	16	35 ¾	19 ½	85	9	FN1636BMS	\$1,652
<b>NOW!</b>	16	29 ¾	19 ½	70	8	FN1630BMS	\$1,540

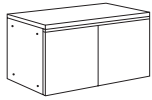

- top edge profile on user side
- supported by two storage towers
- locking doors available, specify and add \$123 list
- no pulls
- cannot be wall mounted

Bridge Mount Overhead Cabinet with Two Glass Doors	16	35 ¾	19 ½	86	9	FN1636GBMS	\$1,943
<b>NOW!</b>	16	29 ¾	19 ½	72	8	FN1630GBMS	\$1,832



- top edge profile on user side
- white back painted glass doors
- supported by two storage towers
- locking doors not available
- pulls not available
- cannot be wall mounted

**To Order, Specify:**

- ① Model Number
- ② Wood Species - Cherry (CH1), Maple (MA1) or Walnut (WA1) (see page 436)
- ③ Finish Color - (see page 436)
- ④ Edge Profile - (see page 436)
- ⑤ Other Product Options (see page 429)

When ordering Quickship products, place a "Q" in front of model number.  
Example: QFN3072DD

**NOW!**  
Need it.  
JSI Quickship

Description	D	W	H	CTN WT	CU FT	① Model	List Price
Bridge Mount Open Overhead with Cubbies	16	35 3/4	24 1/2	102	11	FN1636BMOC	\$1,466
	16	29 3/4	24 1/2	86	9	FN1630BMOC	\$1,327

**NOW!**

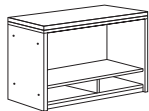

- top edge profile on user side
- supported by two storage towers
- cannot be wall mounted

Bridge Mount Overhead Cabinet with Two Doors and Cubbies	16	35 3/4	24 1/2	108	11	FN1636BMSC	\$1,969
	16	29 3/4	24 1/2	92	9	FN1630BMSC	\$1,857

**NOW!**

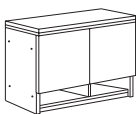

- top edge profile on user side
- supported by two storage towers
- locking doors available, specify and add \$123 list
- no pulls
- cannot be wall mounted

Bridge Mount Overhead Cabinet with Two Glass Doors and Cubbies	16	35 3/4	24 1/2	112	11	FN1636GBMSC	\$2,260
	16	29 3/4	24 1/2	96	9	FN1630GBMSC	\$2,152



- top edge profile on user side
- white back painted glass doors
- supported by two storage towers
- locking doors not available
- pulls not available
- cannot be wall mounted

Modular Cabinet Top	D	W	H	CTN WT	CU FT	Model	List Price
<b>NOW!</b> 	16	83 3/4	1 3/16	94	6	FN1684MCT	\$1,607
	16	77 3/4	1 3/16	85	5	FN1678MCT	\$1,568
	16	71 3/4	1 3/16	76	5	FN1672MCT	\$1,527
	16	65 3/4	1 3/16	63	5	FN1666MCT	\$1,447
	16	41 3/4	1 3/16	40	3	FN1642MCT	\$1,051
	16	35 3/4	1 3/16	35	3	FN1636MCT	\$995
	16	29 3/4	1 3/16	29	3	FN1630MCT	\$952
	16	17 15/16	1 3/16	18	2	FN1618MCT	\$913

- top edge profile on user side
- field installed
- to be used with double height units only

Description	D	W	H	CTN WT	CU FT	1 Model	List Price
Transaction Counter for U Unit	13	89 3/4	17 3/16	115	41	<b>FN13186TC</b> coordinates with FN2472RCR, FN2472LCR, and FN2442EB	\$2,090

**NOW!**

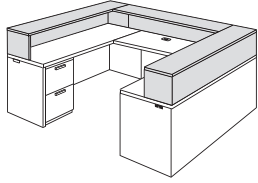

- for U units
- 16" vertical clearance from desk to bottom of transaction top

Transaction Counter for L Unit	13	65 3/4	17 3/16	100	20	<b>FN13114RTC</b> coordinates with FN3066LD and FN2448ERR	\$1,700
--------------------------------	----	--------	---------	-----	----	--	---------

**NOW!**

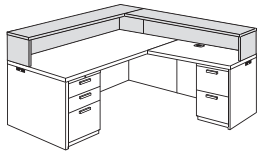

right shown

	13	65 3/4	17 3/16	100	20	<b>FN13114LTC</b> coordinates with FN3066RD and FN2448ELR	\$1,700
--	----	--------	---------	-----	----	--	---------

- for L units
- 16" vertical clearance from desk to bottom of transaction top

Transaction Counter	13	71 3/4	17 3/16	87	12	<b>FN1372TC</b> coordinates with a 71 3/4" surface	\$1,302
---------------------	----	--------	---------	----	----	---	---------

**NOW!**

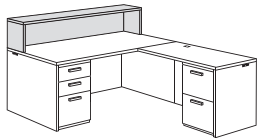

	13	65 3/4	17 3/16	79	11	<b>FN1366TC</b> coordinates with a 65 3/4" surface	\$1,249
--	----	--------	---------	----	----	---	---------

- 16" vertical clearance from desk to bottom of transaction top

**To Order, Specify:**

- 1 Model Number
- 2 Wood Species - Cherry (CH1), Maple (MA1) or Walnut (WA1) (see page 436)
- 3 Finish Color - (see page 436)
- 4 Edge Profile - (see page 436)
- 5 Other Product Options (see page 429)

When ordering Quickship products, place a "Q" in front of model number.  
Example: QFN3072DD

**NOW!**  
*Need it.*  
JSI Quickship

Description	D	W	H	CTN WT	CU FT	① Model	List Price
-------------	---	---	---	-----------	----------	---------	------------

Bookcase	15 7/8	36	82 3/4	180	35	FN3684BC	\$2,570
----------	--------	----	--------	-----	----	----------	---------

**NOW!**

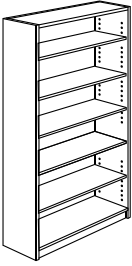

- one fixed shelf
- four adjustable shelves
- we recommend this product be mounted to the floor or wall
- optional modular top, see page 484

Bookcase	16	36	72	150	30	FN3672BC	\$2,141
----------	----	----	----	-----	----	----------	---------

**NOW!**

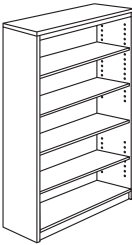

- top edge profile on user side
- one fixed shelf
- three adjustable shelves

Bookcase	16	36	54	125	23	FN3654BC	\$1,659
----------	----	----	----	-----	----	----------	---------

**NOW!**

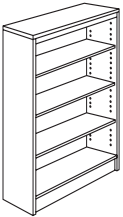

- top edge profile on user side
- three adjustable shelves

Bookcase	16	36	42	105	18	FN3642BC	\$1,413
----------	----	----	----	-----	----	----------	---------

**NOW!**



- top edge profile on user side
- two adjustable shelves

Bookcase	16	36	30	85	13	FN3630BC	\$1,179
----------	----	----	----	----	----	----------	---------

**NOW!**



- top edge profile on user side
- one adjustable shelf

Description	D	W	H	CTN WT	CU FT	1 Model	List Price
Lateral File	24	35 3/8	54	300	32	FN3654LF	\$3,322

**NOW!**



- top edge profile on user side
- four drawers
- anti-tip interlock mechanism
- central locking

Lateral File	24	35 3/8	42	260	25	FN3642LF	\$2,711
--------------	----	--------	----	-----	----	----------	---------

**NOW!**



- top edge profile on user side
- three drawers
- anti-tip interlock mechanism
- central locking

Lateral File	24	35 3/8	30	175	19	FN3630LF	\$2,192
--------------	----	--------	----	-----	----	----------	---------

**NOW!**

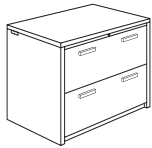

- top edge profile on user side
- two drawers
- anti-tip interlock mechanism
- central locking
- two end panel grommets with wire pass thru
- for overhead bookcases and cabinets; see page 484

Mobile Pedestal	22	18 1/16	28 1/4	95	9	FN1820MP	\$1,886
-----------------	----	---------	--------	----	---	----------	---------

**NOW!**



- box/box/file only
- legal width pedestal
- pedestal locking
- casters

**To Order, Specify:**

- 1 Model Number
- 2 Wood Species - Cherry (CH1), Maple (MA1) or Walnut (WA1) (see page 436)
- 3 Finish Color - (see page 436)
- 4 Edge Profile - (see page 436)
- 5 Other Product Options (see page 429)

When ordering Quickship products, place a "Q" in front of model number.  
Example: QFN3072DD

**NOW!**  
*Need it.*  
JSI Quickship

Description	D	W	H	CTN WT	CU FT	① Model	List Price
-------------	---	---	---	-----------	----------	---------	------------

<b>84" h Wardrobe</b>	23 $\frac{7}{8}$	35 $\frac{3}{8}$	84	335	50	<b>FN3684W</b>	<b>\$4,089</b>
-----------------------	------------------	------------------	----	-----	----	----------------	----------------

**NOW!**

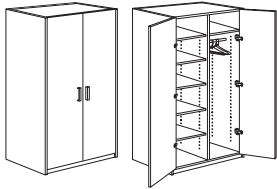

- chrome hanging bar on right
- one fixed shelf second from bottom on left
- locking doors available; specify and add \$246 list
- optional modular top, see page 491

<b>72" h Wardrobe</b>	24	35 $\frac{3}{8}$	72	360	41	<b>FN3672W</b>	<b>\$3,408</b>
-----------------------	----	------------------	----	-----	----	----------------	----------------

**NOW!**

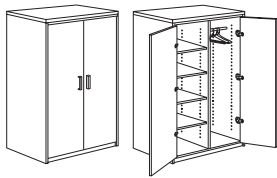

- top edge profile on user side
- chrome hanging bar on right
- one fixed shelf second from bottom on left
- locking doors available; specify and add \$246 list

<b>Hanging Bar to Shelves Conversion Kit</b>	24	18	$\frac{3}{4}$	56	2	<b>FN1824SK</b>	<b>\$780</b>
--	----	----	---------------	----	---	-----------------	--------------

**NOW!**

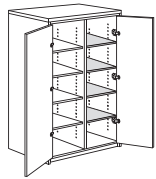

- four shelves
- for 36" wide wardrobe

Description	D	W	H	CTN WT	CU FT	① Model	List Price
84" h Wardrobe	23 7/8	17 3/4	84	260	25	FN1884WR	\$3,426
<b>NOW!</b>	23 7/8	17 3/4	84	260	25	FN1884WL	\$3,426

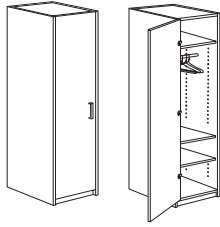

left shown

- chrome hanging bar at top
- one fixed shelf 26 1/2" from cabinet floor
- one adjustable shelf
- locking door available; specify and add \$123 list
- optional modular top, see page 491

72" h Wardrobe	24	18	72	233	23	FN1872WR	\$2,854
<b>NOW!</b>	24	18	72	233	23	FN1872WL	\$2,854

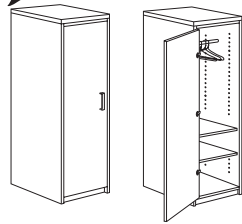

left shown

- top edge profile on user side
- chrome hanging bar at top
- one fixed shelf 26 1/2" from cabinet floor
- one adjustable shelf
- locking door available; specify and add \$123 list

Hanging Bar to Shelves Conversion Kit	24	16	3/4	50	2	FN1624SK	\$618
---------------------------------------	----	----	-----	----	---	----------	-------

**NOW!**

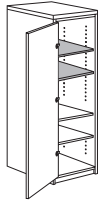

- two shelves
- for 18" wide wardrobe

**To Order, Specify:**

- ① Model Number
- ② Wood Species - Cherry (CH1), Maple (MA1) or Walnut (WA1) (see page 436)
- ③ Finish Color - (see page 436)
- ④ Edge Profile - (see page 436)
- ⑤ Pull Style and Color - (see page 436)
- ⑥ Other Product Options (see page 429)
- ⑦ Accessories (see pages 519-535)
- ⑧ Power and Data Options (see pages 519-535)

When ordering Quickship products, place a "Q" in front of model number.  
Example: QFN3072DD

**NOW!**  
*Need it.*  
JSI Quickship

Description	D	W	H	CTN WT	CU FT	① Model	List Price
-------------	---	---	---	-----------	----------	---------	------------

<b>84" h File/File Lateral Storage Cabinet</b>	23 $\frac{7}{8}$	35 $\frac{3}{8}$	84	370	50	<b>FN3684SWLF</b>	<b>\$5,275</b>
--	------------------	------------------	----	-----	----	-------------------	----------------

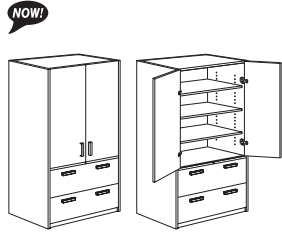

- three adjustable shelves
- locking doors available; specify and add \$123 list
- file/file lateral
- pedestal locking
- optional modular top, see page 491

<b>72" h File/File Lateral Storage Cabinet</b>	24	35 $\frac{3}{8}$	72	360	43	<b>FN3672SWLF</b>	<b>\$4,396</b>
--	----	------------------	----	-----	----	-------------------	----------------

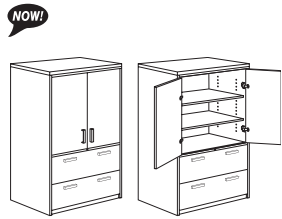

- two adjustable shelves
- locking doors available; specify and add \$123 list
- top edge profile on user side only
- file/file lateral
- pedestal locking

<b>84" h File/File Storage Wardrobe</b>	23 $\frac{7}{8}$	23 $\frac{5}{8}$	84	315	34	<b>FN2484SWR</b>	<b>\$3,851</b>
	23 $\frac{7}{8}$	23 $\frac{5}{8}$	84	315	34	<b>FN2484SWL</b>	<b>\$3,851</b>

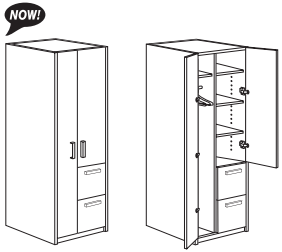

left shown

- chrome hanging bar
- three adjustable shelves
- file/file pedestal
- locking not available
- optional modular top, see page 491

<b>72" h File/File Storage Wardrobe</b>	24	23 $\frac{5}{8}$	72	340	29	<b>FN2472SWR</b>	<b>\$3,209</b>
	24	23 $\frac{5}{8}$	72	340	29	<b>FN2472SWL</b>	<b>\$3,209</b>

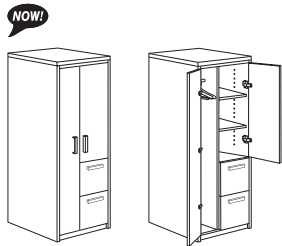

left shown

- top edge profile on user side
- chrome hanging bar
- two adjustable shelves
- file/file pedestal
- locking not available



Description	D	W	H	CTN WT	CU FT	① Model	List Price
<b>Modular Wardrobe Top</b> 	24	34 5/8	1 3/16	38	3	<b>FN2436MTC</b> coordinates with: FN3684W and FN3684SWLF	<b>\$628</b>
	24	23 7/8	1 3/16	28	2	<b>FN2424MTC</b> coordinates with: FN2484SWL and FN2484SWR	<b>\$561</b>
	24	17 7/8	1 3/16	21	2	<b>FN2418MTC</b> coordinates with: FN1884WL and FN1884WR	<b>\$525</b>

**NOW!**



- top edge profile on user side
- field installed
- to be used with 84" height wardrobe units only

**To Order, Specify:**

- ① Model Number
- ② Wood Species - Cherry (CH1), Maple (MA1) or Walnut (WA1) (see page 436)
- ③ Finish Color - (see page 436)
- ④ Edge Profile - (see page 436)
- ⑤ Pull Style and Color - (see page 436)
- ⑥ Other Product Options (see page 429)
- ⑦ Accessories, Power and Data Options (see pages 519-535)

When ordering Quickship products, place a "Q" in front of model number.  
Example: QFN3072DD

**NOW!**  
*Need it.*  
JSI Quickship

Description	D	W	H	CTN WT	CU FT	① Model	List Price
42" dia. Round Magazine Table	42	42	16			<b>FN42MTD</b>	<b>\$2,290</b>

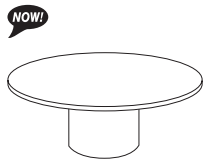

Consists of:							
				56	5	<b>FN42TT - Table Top</b>	<b>\$1,365</b>
				68	5	<b>FN18-16RB - Round Base</b>	<b>\$925</b>

· ships KD in two cartons

36" dia. Round Magazine Table	36	36	16			<b>FN36MTD</b>	<b>\$2,127</b>
-------------------------------	----	----	----	--	--	----------------	----------------

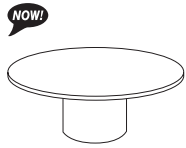

Consists of:							
				42	4	<b>FN36TT - Table Top</b>	<b>\$1,202</b>
				68	5	<b>FN18-16RB - Round Base</b>	<b>\$925</b>

· ships KD in two cartons

Description	D	W	H	CTN WT	CU FT	① Model	List Price
Corner Table	36	36	17	79	5	FN3636CT	\$1,079

**NOW!**

· ships KD in one carton



Sofa Table	18	60	30	66	4	FN1860ST	\$1,097
------------	----	----	----	----	---	----------	---------

**NOW!**

· ships KD in one carton

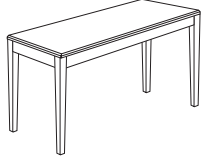

Magazine Table	20	42	16	51	4	FN2042MT	\$926
----------------	----	----	----	----	---	----------	-------

**NOW!**

· ships KD in one carton

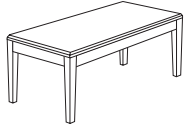

End Table	24	24	20	35	3	FN2424ET	\$783
-----------	----	----	----	----	---	----------	-------

**NOW!**

· ships KD in one carton

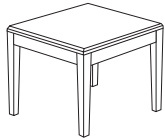

End Table	20	28	20	35	3	FN2028ET	\$780
-----------	----	----	----	----	---	----------	-------

**NOW!**

· ships KD in one carton

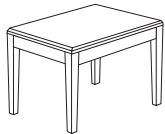

**To Order, Specify:**

- ① Model Number
- ② Wood Species - Cherry (CH1), Maple (MA1) or Walnut (WA1) (see page 436)
- ③ Finish Color - (see page 436)
- ④ Edge Profile - (see page 436)
- ⑤ Grommet Color - (see page 436)
- ⑥ Other Product Options (see page 429)

When ordering Quickship products, place a "Q" in front of model number.  
Example: QFN3072DD

**NOW!**  
*Need it.*  
JSI Quickship

Description	D	W	H	CTN WT	CU FT	① Model	List Price
-------------	---	---	---	-----------	----------	---------	------------

**Metal Frame End Table with Glass Top**

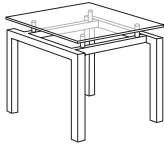

- metal 1 1/2" square tube frame - specify metal color option: Black Sandtex (BSX), Soft Nickel (SNK) or Stardust Silver (STS)
- clear glass or white back painted glass top
- glass top crated for shipment
- 1/2" tempered glass top
- field assembly of glass top to metal base frame

**Metal Frame End Table with Veneer Top**

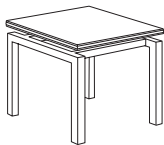

- metal 1 1/2" square tube frame - specify metal color option: Black Sandtex (BSX), Soft Nickel (SNK) or Stardust Silver (STS)
- black support for veneer top
- wood species, finish and edge profile must be specified
- field assembly of veneer top to metal base frame

**Metal Frame End Table for COM Top**

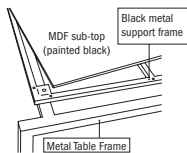
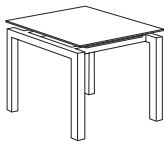

- includes: table frame, black metal support and black MDF sub top
- CUSTOMER MUST SUPPLY WORK SURFACE AND INSTALLATION AT FINAL DESTINATION
- metal 1 1/2" square tube frame - specify metal color option: Black Sandtex (BSX), Soft Nickel (SNK) or Stardust Silver (STS)
- black support for COM top
- field assembly of COM top support to metal base frame

	24	24	20	51	10	<b>FN2424V-20</b>	<b>\$2,251</b>
--	----	----	----	----	----	-------------------	----------------

	24	24	20	51	10	<b>FN2424X-20</b>	<b>\$2,227</b>
--	----	----	----	----	----	-------------------	----------------

Description	D	W	H	CTN WT	CU FT	① Model	List Price
-------------	---	---	---	-----------	----------	---------	------------

**Metal Frame Magazine Table with Glass Top**

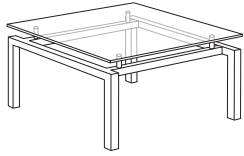

- metal 1 1/2" square tube frame - specify metal color option: Black Sandtex (BSX), Soft Nickel (SNK) or Stardust Silver (STS)
- clear glass or white back painted glass top
- glass top crated for shipment
- 1/2" tempered glass top
- field assembly of glass top to metal base frame

**Metal Frame Magazine Table with Veneer Top**

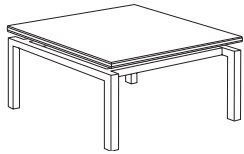

- metal 1 1/2" square tube frame - specify metal color option: Black Sandtex (BSX), Soft Nickel (SNK) or Stardust Silver (STS)
- black support for veneer top
- wood species, finish and edge profile must be specified
- field assembly of veneer top to metal base frame

**Metal Frame Magazine Table for COM Top**

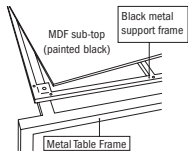
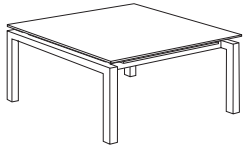

- includes: table frame, black metal support and black MDF sub top
- CUSTOMER MUST SUPPLY WORK SURFACE AND INSTALLATION AT FINAL DESTINATION
- metal 1 1/2" square tube frame - specify metal color option: Black Sandtex (BSX), Soft Nickel (SNK) or Stardust Silver (STS)
- black support for COM top
- field assembly of COM top support to metal base frame

**To Order, Specify:**

- ① Model Number
- ② Wood Species - Cherry (CH1), Maple (MA1) or Walnut (WA1) (see page 436)
- ③ Finish Color - (see page 436)
- ④ Glass Surface - Clear or White Back Painted - (see page 436)
- ⑤ Metal Color - Black Sandtex (BSX), Soft Nickel (SNK) or Stardust Silver (STS) (see page 436)
- ⑥ Edge Profile - (see page 436)
- ⑦ Other Product Options (see page 429)

When ordering Quickship products, place a "Q" in front of model number.  
Example: QFN3072DD



Description	D	W	H	CTN WT	CU FT	① Model	List Price
-------------	---	---	---	--------	-------	---------	------------

**Metal Frame Magazine Table with Glass Top**

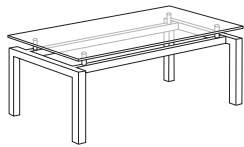

- metal 1 1/2" square tube frame - specify metal color option: Black Sandtex (BSX), Soft Nickel (SNK) or Stardust Silver (STS)
- clear glass or white back painted glass top
- glass top crated for shipment
- 1/2" tempered glass top
- field assembly of glass top to metal base frame

**Metal Frame Magazine Table with Veneer Top**

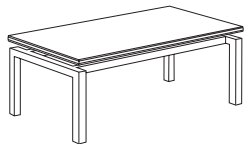

24	48	17	81	15	<b>FN2448V-17</b>	<b>\$2,631</b>
----	----	----	----	----	-------------------	----------------

- metal 1 1/2" square tube frame - specify metal color option: Black Sandtex (BSX), Soft Nickel (SNK) or Stardust Silver (STS)
- black support for veneer top
- wood species, finish and edge profile must be specified
- field assembly of veneer top to metal base frame

**Metal Frame Magazine Table for COM Top**

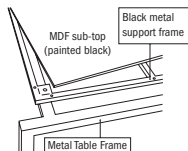
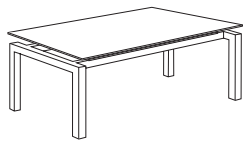

24	48	17	81	15	<b>FN2448X-17</b>	<b>\$2,604</b>
----	----	----	----	----	-------------------	----------------

- includes: table frame, black metal support and black MDF sub top
- CUSTOMER MUST SUPPLY WORK SURFACE AND INSTALLATION AT FINAL DESTINATION
- metal 1 1/2" square tube frame - specify metal color option: Black Sandtex (BSX), Soft Nickel (SNK) or Stardust Silver (STS)
- black support for COM top
- field assembly of COM top support to metal base frame

**Center Drawer**

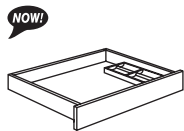

16	25	3	12	2	<b>FN1825CD</b>	<b>\$383</b>
----	----	---	----	---	-----------------	--------------

- non-locking

**o Order, Specify:**

- ① Model Number
- ② Wood Species - Cherry (CH1), Maple (MA1) or Walnut (WA1) (see page 436)
- ③ Finish Color - (see page 436)
- ④ Glass Surface - Clear or White Back Painted - (see page 436)
- ⑤ Metal Color - Black Sandtex (BSX), Soft Nickel (SNK) or Stardust Silver (STS) (see page 436)
- ⑥ Edge Profile - (see page 436)
- ⑦ Other Product Options (see page 429)

When ordering Quickship products, place a "Q" in front of model number.  
Example: QFN3072DD



# Finale Conference Product Information



FINALE

# Finale Conference Product Information

## Exterior Wood Materials

Exterior surfaces are made from the finest selected veneers to achieve clarity and consistency in the Finale product line. To attain a pleasing, symmetrical pattern, all veneers in Finale are book-matched. All exterior solid lumber is matched to coordinate with the veneer.

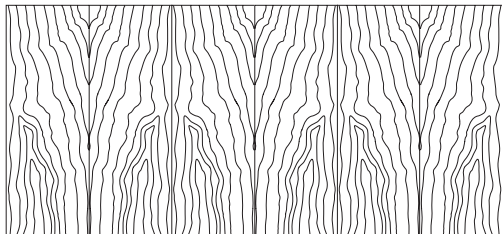

### Book Matched Example

Alternating pieces of veneer are flipped over so they face each other like the pages within a book.

Finale is available in flat cut cherry, maple and walnut veneer. A wide range of wood stains have been formulated to enhance the beauty of the veneer.

Solid painted finishes on the veneer are also offered to provide an accent to the Finale product.

Cherry veneer is the only veneer species available on the  quickship program on select models.

## Work Surface Construction

Tops are 5-ply balanced construction, 1 3/16" thick with solid matching hardwood edges. Tops are available in six edge profile.

Matching or coordinating high pressure laminate in a veneer grain can be applied to the top surface and is available at no additional charge.

## Base Construction

Panels are joined together by mortise and tenon construction. In addition to mortise and tenon joint construction. Leveling glides are set into solid hardwood with t-nut inserts, which helps to prevent the leveling glide from tear out. Tops are secured to the bases with top fastening cleats screwed to the inside of the panels.

## Drawers

The 9ply unidirectional hardwood sides of the drawer box are 7/16" thick assembled with English dovetail construction at each corner of the box. The drawer bottom panel is 1/4" thick fitting into a groove machined into the side of the box. Interiors are sanded and coated with clear U.V. finish to protect against shrinking, swelling or warping, and to provide a clean, smooth feel and appearance.

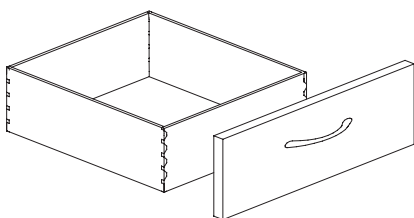

## Drawer Suspension

The high quality black drawer suspensions carry a lifetime warranty. Slides feature steel ball bearings for longer life with cushioned in/out stops. File and box drawers have 100% full extension with over travel.

## Finish - Stain/Colors

We offer a variety of wood stains and paint colors on Finale. Please see the chart below. Samples are available upon request.

<b>CH1 Cherry</b> <i>Flat Cut Veneer</i>	
BRL Barley	EAR Earthy
BBN Bourbon	HRV Harvest
BRG Brighton	LGC Legacy
CLA Classic	PRL Praline
CLL Collectors	SAF Saffron

<b>MA1 Maple</b> <i>Flat Cut Veneer</i>	
ALE Ale	FLX Flax
BUT Butterscotch	VEN Venetian
CIN Cinnamon	

<b>WA1 Walnut</b> <i>Flat Cut Veneer</i>	
AUB Auburn	SIE Sienna
ESP Espresso	TOF Toffee
MCH Mocha	TRF Truffle
NTO Night Owl	

## Protective Top Coat

DuraTex™ offers exceptional hardness along with abrasion and impact resistance, it has been formulated to eliminate hazardous and harmful gases that are normally associated with wood finish.

## DuraTex™ Features

**Safety** - Significantly reduces hazardous formaldehyde emissions, which help improve the quality of the of the indoor air we breathe.

**Quality** - Developed to be tough and durable with special attention to appearance. The DuraTex™ finish preserves the natural beauty of wood.

**Durability** - Designed to meet a wide range of demanding performance and environmental standards to withstand even the highest wear and tear.



## Finale Conference Product Information

### Product Modification

#### Laminate Tops

Worksurface only, no additional upcharge if coordinating wood grain laminate is specified. Contact Customer Service for any other laminate request. Listed below are finishes that have coordinating wood grain HPL laminates.

Cherry Finishes	Walnut Finishes
<i>Collectors</i>	<i>Mocha</i>
<i>Harvest</i>	<i>Night Owl</i>
<i>Praline</i>	<i>Sienna</i>
	<i>Truffle</i>

#### Special Finishes

Special finishes can be requested by following the instruction in the general introduction section, page 5. There is a one time charge of \$332 list per order.

#### Species Change

For species changes contact customer service for a quote.

# Finale Conference Product Information

## Top Edge Details

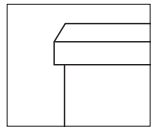

Bevel (B)

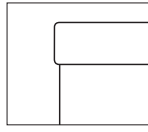

Eased (R4)

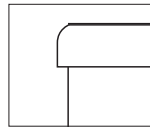

Gael (G)

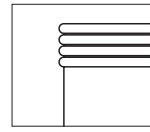

Reeded (H)

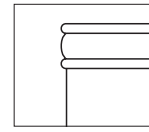

Transitional (C)

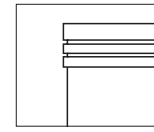

Triad (F)

## Drawer Style Color Options

Finish Color MBK = Matte Black MNK = Matte Nickel MSL = Matte Silver



Arch  
(MBK or MSL)



Block  
(MNK)



Curve  
(MNK)



Twist  
(MNK)

## Top Shapes - size - base requirement - seating capacity

top sizes 108" through 192" are 2 pieces

top sizes above 192" are 3 pieces

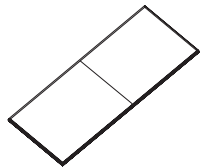

rectangular

264" x 60"	4 bases	seats 24
240" x 60"	4 bases	seats 22
216" x 60"	4 bases	seats 20
192" x 60"	3 bases	seats 18
264" x 54"	4 bases	seats 22
240" x 54"	4 bases	seats 20
216" x 54"	4 bases	seats 18
192" x 54"	3 bases	seats 16
264" x 48"	4 bases	seats 22
240" x 48"	4 bases	seats 20
216" x 48"	4 bases	seats 18
192" x 48"	3 bases	seats 16
168" x 48"	3 bases	seats 14
144" x 48"	3 bases	seats 12
120" x 48"	2-3* bases	seats 8
120" x 42"	2-3* bases	seats 8
108" x 42"	2 bases	seats 8
96" x 48"	2 bases	seats 8
96" x 42"	2 bases	seats 8
84" x 42"	2 bases	seats 8
72" x 36"	2 bases	seats 6



racetrack

264" x 60"	4 bases	seats 24
240" x 60"	4 bases	seats 22
216" x 60"	4 bases	seats 20
192" x 60"	3 bases	seats 18
264" x 54"	4 bases	seats 22
240" x 54"	4 bases	seats 20
216" x 54"	4 bases	seats 18
192" x 54"	3 bases	seats 16
264" x 48"	4 bases	seats 22
240" x 48"	4 bases	seats 20
216" x 48"	4 bases	seats 18
192" x 48"	3 bases	seats 16
168" x 48"	3 bases	seats 14
144" x 48"	3 bases	seats 12
120" x 48"	2-3* bases	seats 8
120" x 42"	2-3* bases	seats 8
108" x 42"	2 bases	seats 8
96" x 48"	2 bases	seats 8
96" x 42"	2 bases	seats 8
84" x 42"	2 bases	seats 8
72" x 36"	2 bases	seats 6

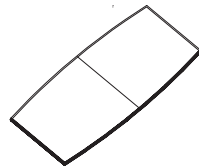

boat

264" x 60"	4 bases	seats 24
240" x 60"	4 bases	seats 22
216" x 60"	4 bases	seats 20
192" x 60"	3 bases	seats 18
264" x 54"	4 bases	seats 22
240" x 54"	4 bases	seats 20
216" x 54"	4 bases	seats 18
192" x 54"	3 bases	seats 16
264" x 48"	4 bases	seats 22
240" x 48"	4 bases	seats 20
216" x 48"	4 bases	seats 18
192" x 48"	3 bases	seats 16
168" x 48"	3 bases	seats 14
144" x 48"	3 bases	seats 12
120" x 48"	2-3* bases	seats 8
120" x 42"	2-3* bases	seats 8
108" x 42"	2 bases	seats 8
96" x 48"	2 bases	seats 8
96" x 42"	2 bases	seats 8
84" x 42"	2 bases	seats 8
72" x 36"	2 bases	seats 6



round\*

60" dia.	Seats 6
54" dia.	Seats 6
48" dia.	Seats 4
42" dia.	Seats 4
36" dia.	Seats 4

\*requires 1 base

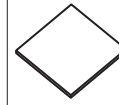

square\*

60" sq.	seats 8
54" sq.	seats 6
48" sq.	seats 4
42" sq.	seats 4
36" sq.	seats 4
30" sq.	seats 4

\*requires 1 base

\* When ordering bases for 120" x 48" and 120" x 42" size tops, three (3) bases are required for Panel and Rectangle bases, two (2) bases are required for all other.

## Base (units with access panel in the base for wire management are available, order this feature with the appropriate model number.)

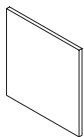

panel base  
30" and 24" width

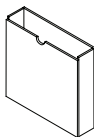

rectangle base  
30" and 24" width

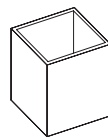

square base  
24" and 18" width

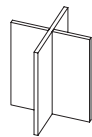

cross base  
24" and 18" width

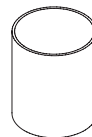

round base  
24", 20" and 18" dia.

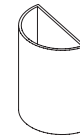

half-round base  
24", 20 and 18" dia.

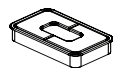

### Worksurface Grommet

Additional worksurface grommets can be specified on veneer/laminate worksurfaces. The grommet location must be approved by JSI manufacturing, contact Customer Service. Add \$99 to the list for each additional grommet.

Grommet color must be specified, select Matte Black or Stardust Silver. Lock cores will match grommet color Matte Black (MBK) or Stardust Silver (STS).



### End/Back Panel Grommet

The end/back panel grommets are standard, for any special consideration contact Customer Service.

# Finale Conference Product Information

## Finish and Product Reference Codes

### Select Code

#### Veneer

Cherry Flat Cut	CH1
Maple Flat Cut	MA1
Walnut Flat Cut	WA1

#### Finish

##### Cherry Finishes

Barley	BRL
Bourbon	BBN
Brighton	BRG
Classic	CLA
Collectors	CLL
Earthy	EAR
Harvest	HRV
Legacy	LGC
Praline	PRL
Saffron	SAF

##### Maple Finishes

Ale	ALE
Butterscotch	BUT
Cinnamon	CIN
Flax	FLX
Venetian	VEN

### Select Code

#### Walnut Finishes

Auburn	AUB
Espresso	ESP
Mocha	MCH
Night Owl	NTO
Sienna	SIE
Toffee	TOF
Truffle	TRF

#### Top Edge Details

Bevel	B
Eased	R4
Gael	G
Reeded	H
Transitional	C
Triad	F

#### Pull & Finish Codes

Arch - Matte Nickel	MNK
Arch - Matte Silver	MSL
Block - Matte Nickel	MNK
Curve - Matte Nickel	MNK
Twist - Matte Nickel	MNK

### Select Code

#### Laminate Coordinates

##### Cherry Wood Grain Patterns

Barley	BRL
Bourbon	BBN
Brighton	BRG
Classic	CLA
Collectors	CLL
Harvest	HRV
Legacy	LGC
Praline	PRL
Saffron	SAF

##### Maple Wood Grain Patterns

Ale	ALE
Cinnamon	CIN
Venetian	VEN

##### Walnut Wood Grain Patterns

Auburn	AUB
Mocha	MCH
Night Owl	NTO
Sienna	SIE
Toffee	TOF
Truffle	TRF

#### Metal Finish *(grommet)*

Matte Black	MBK
Stardust Silver	STS

## Order Check List:

Specify:

- 1. Model Number
- 2. Finish
- 3. Wood Species - cherry - makore - maple - walnut
- 4. Top Options - standard veneer - laminate surface (see page 503)
- 5. Other Product Options
- 6. Power and Data Accessories *(drawing showing location and orientation must accompany order)*
- 7. Side Mark Information *(i.e. room number, East Conference Room)*
- 8. Shipping Address *(contact name and phone number)*
- 9. Special Delivery Instructions *(i.e. call before delivery, deliver to job site)*

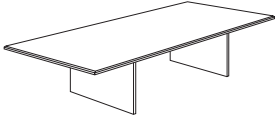

Description	D	W	H	CTN WT	CU FT	① Model	List Price	
Conference Table	42	96	30			<b>FN4296CTP</b>	<b>\$4,855</b>	
 <p><b>NOW!</b></p> <ul style="list-style-type: none"> <li>ships KD in four cartons</li> <li>one piece top</li> <li>price reflects two bases</li> <li>price includes one FN0655SP stretcher panel</li> <li>must order (2) panel bases</li> </ul>						Consists of:		
			172	15			FN4296TT - Table Top	\$3,565
			54 ea.	4 ea.			FN2428PB - Panel Bases	\$645 ea.

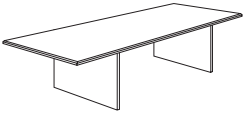
Conference Table	36	72	30			<b>FN3672CTP</b>	<b>\$3,583</b>	
 <p><b>NOW!</b></p> <ul style="list-style-type: none"> <li>ships KD in four cartons</li> <li>one piece top</li> <li>price reflects two bases</li> <li>price includes one FN0631SP stretcher panel</li> <li>must order (2) panel bases</li> </ul>						Consists of:		
			110	10			FN3672TT - Table Top	\$2,293
			54 ea.	4 ea.			FN2428PB - Panel Bases	\$645 ea.

Round Conference Table	48	48	30			<b>FN48CTD</b>	<b>\$2,775</b>	
 <p><b>NOW!</b></p> <ul style="list-style-type: none"> <li>ships KD in two cartons</li> </ul>						Consists of:		
			73	7			FN48TT - Table Top	\$1,786
			71	9			FN20RB - Round Base	\$989

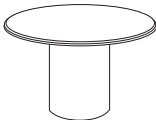



Round Conference Table	42	42	30			<b>FN42CTD</b>	<b>\$2,354</b>	
 <p><b>NOW!</b></p> <ul style="list-style-type: none"> <li>ships KD in two cartons</li> </ul>						Consists of:		
			56	5			FN42TT - Table Top	\$1,365
			71	9			FN20RB - Round Base	\$989

**To Order, Specify:**

- ① Model Number
- ② Wood Species
  - A. Work Surface
  - B. Chassis
- ③ Finish Color
  - A. Work Surface
  - B. Chassis
- ④ Edge Profile
- ⑤ Power and Data Options (see pages 519-535)
- ⑥ Other Product Options

When ordering Quickship products, place a "Q" in front of model number.  
Example: QVV3072DD

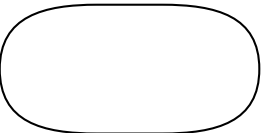

Description	① Model	W	L	Seat Capacity	Top Pieces	Bases Required	CTN WT	CU FT	List Price
Rectangular Tops 	FN60264TT	60	264	24	3	4	673	57	\$15,048
	FN60240TT	60	240	22	3	4	613	51	\$13,680
	FN60216TT	60	216	20	3	4	552	48	\$12,316
	FN60192TT	60	192	18	2	3	490	42	\$10,944
	FN54264TT	54	264	22	3	4	609	52	\$12,542
	FN54240TT	54	240	20	3	4	554	50	\$11,401
	FN54216TT	54	216	18	3	4	498	43	\$10,264
	FN54192TT	54	192	16	2	3	441	38	\$9,122
	FN48264TT	48	264	22	3	4	548	47	\$11,151
	FN48240TT	48	240	20	3	4	498	43	\$10,138
	FN48216TT	48	216	18	3	4	447	38	\$9,122
	FN48192TT	48	192	16	2	3	396	33	\$8,111
	FN48168TT	48	168	14	2	3	346	30	\$7,097
	FN48144TT	48	144	12	2	3	296	28	\$6,084
	FN48120TT**	48	120	8	2	2-3**	245	22	\$5,072
	FN4896TT 	48	96	8	1	2	197	17	\$4,074
	FN42120TT**	42	120	8	2	2-3**	217	19	\$4,438
	FN42108TT	42	108	8	2	2	195	17	\$3,997
	FN4296TT 	42	96	8	1	2	172	15	\$3,565
	FN4284TT 	42	84	8	1	2	151	13	\$3,104
FN3672TT 	36	72	6	1	2	110	10	\$2,293	
Racetrack Tops 	FN60264RT	60	264	24	3	4	646	57	\$17,783
	FN60240RT	60	240	22	3	4	589	51	\$16,166
	FN60216RT	60	216	20	3	4	530	48	\$14,552
	FN60192RT	60	192	18	2	3	471	42	\$12,936
	FN54264RT	54	264	22	3	4	586	52	\$14,818
	FN54240RT	54	240	20	3	4	530	50	\$13,473
	FN54216RT	54	216	18	3	4	474	43	\$12,127
	FN54192RT	54	192	16	2	3	417	38	\$10,779
	FN48264RT	48	264	22	3	4	529	47	\$13,173
	FN48240RT	48	240	20	3	4	479	43	\$11,978
	FN48216RT	48	216	18	3	4	428	38	\$10,779
	FN48192RT	48	192	16	2	3	377	33	\$9,582
	FN48168RT	48	168	14	2	3	327	30	\$8,284
	FN48144RT	48	144	12	2	3	277	28	\$7,189
	FN48120RT**	48	120	8	2	2-3**	226	22	\$5,995
	FN4896RT	48	96	8	1	2	185	17	\$4,797
	FN42120RT**	42	120	8	2	2-3**	203	19	\$5,244
	FN42108RT	42	108	8	2	2	180	17	\$4,720
	FN4296RT	42	96	8	1	2	157	15	\$4,195
	FN4284RT	42	84	8	1	2	142	13	\$3,688
FN3672RT	36	72	6	1	2	100	10	\$2,703	

\*\*When ordering RECTANGLE or PANEL BASES - FN48120 and FN42120 require (3) panel bases and additional stretchers. Stretchers will be included as required.

\*\*When ordering RECTANGLE or PANEL BASES - FN48120 and FN42120 require (3) panel bases and additional stretchers. Stretchers will be included as required.

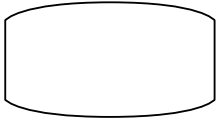
Description	① Model	W	L	Seat Capacity	Top Pieces	Bases Required	CTN WT	CU FT	List Price
<b>Boat Shape Tops</b>  · boat shape top end dimension is 6" less than center dimension  **When ordering RECTANGLE or PANEL BASES - FN48120 and FN42120 require (3) panel bases and additional stretchers. Stretchers will be included as required.	FN60264BT	60	264	24	3	4	646	57	\$17,783
	FN60240BT	60	240	22	3	4	589	51	\$16,166
	FN60216BT	60	216	20	3	4	530	48	\$14,552
	FN60192BT	60	192	18	2	3	471	42	\$12,936
	FN54264BT	54	264	22	3	4	586	52	\$14,818
	FN54240BT	54	240	20	3	4	530	50	\$13,473
	FN54216BT	54	216	18	3	4	474	43	\$12,127
	FN54192BT	54	192	16	2	3	417	38	\$10,779
	FN48264BT	48	264	22	3	4	529	47	\$13,173
	FN48240BT	48	240	20	3	4	479	43	\$11,978
	FN48216BT	48	216	18	3	4	428	38	\$10,779
	FN48192BT	48	192	16	2	3	377	33	\$9,582
	FN48168BT	48	168	14	2	3	327	30	\$8,284
	FN48144BT	48	144	12	2	3	277	28	\$7,189
	FN48120BT**	48	120	8	2	2-3**	226	22	\$5,995
	FN4896BT	48	96	8	1	2	185	17	\$4,797
	FN42120BT**	42	120	8	2	2-3**	203	19	\$5,244
	FN42108BT	42	108	8	2	2	180	17	\$4,720
	FN4296BT	42	96	8	1	2	157	15	\$4,195
	FN4284BT	42	84	8	1	2	142	13	\$3,688
FN3672BT	36	72	6	1	2	100	10	\$2,703	

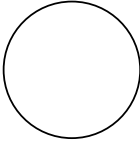
Round Tops	Model	W	L	Seat Capacity	Top Pieces	Bases Required	CTN WT	CU FT	List Price
	FN60TT	60	N/A	6	1	1	112	10	\$3,018
	FN54TT	54	N/A	6	1	1	92	8	\$2,266
	FN48TT	48	N/A	4	1	1	73	7	\$1,786
	FN42TT	42	N/A	4	1	1	56	5	\$1,365
	FN36TT	36	N/A	3	1	1	42	4	\$1,202
	FN30TT	30	N/A	3	1	1	30	3	\$1,060

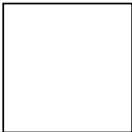
Square Tops	Model	W	L	Seat Capacity	Top Pieces	Bases Required	CTN WT	CU FT	List Price
	FN6060TT	60	60	8	1	1	154	10	\$2,765
	FN5454TT	54	54	6	1	1	125	8	\$2,094
	FN4848TT	48	48	4	1	1	99	7	\$1,653
	FN4242TT	42	42	4	1	1	77	5	\$1,268
	FN3636TT	36	36	4	1	1	56	4	\$1,143
	FN3030TT	30	30	4	1	1	39	3	\$795

**To Order, Specify:**

- ① Model Number
- ② Wood Species
- ③ Finish Color
- ④ Edge Profile
- ⑤ Power and Data Options (see pages 519-535)
- ⑥ Other Product Options

When ordering Quickship products, place a "Q" in front of model number.  
 Example: QV3072DD

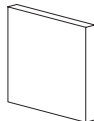

**NOW!**  
 Need it.  
 JSI Quickship

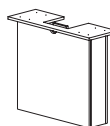
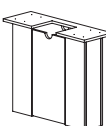
Description	D	W	H	CTN WT	CU FT	① Model	List Price
<b>Panel Base</b> 	2 5/16	36	28 3/4	83	6	<b>FN3628PB</b> · for use with 60" width top	\$776
	2 5/16	30	28 3/4	68	5	<b>FN3028PB</b> · for use with 54" width top	\$714
	2 5/16	24	28 3/4	54	4	<b>FN2428PB</b> · for use with 36", 42" and 48" width top · (3) bases are required when ordering FN48120 or FN42120	\$645

Description	D	W	H	CTN WT	CU FT	① Model	List Price
<b>Rectangular Base</b>   side 1      side 2	7 5/8	36	28 3/4	69	7	<b>FN3628PBA</b> · for use with 60" width top · access panel	\$1,311
	7 5/8	30	28 3/4	60	6	<b>FN3028PBA</b> · for use with 54" width top · access panel	\$1,246
	7 5/8	24	28 3/4	52	5	<b>FN2428PBA</b> · for use with 36", 42" and 48" width top · access panel · (3) bases are required when ordering FN48120 or FN42120	\$1,177

Description	D	W	H	CTN WT	CU FT	① Model	List Price
<b>Round Base</b> 	24	n/a	28 3/4	74	12	<b>FN24RB</b> · for use with 54" and 60" width top	\$1,124
	24	n/a	28 3/4	37	12	<b>FN24RBA</b> · for use with 54" and 60" width top · access panel	\$1,254
	20	n/a	28 3/4	71	9	<b>FN20RB</b> · for use with 42" and 48" width top	\$989
	20	n/a	28 3/4	34	9	<b>FN20RBA</b> · for use with 42" and 48" width top · access panel	\$1,120
	18	n/a	28 3/4	68	7	<b>FN18RB</b> · for use with 36" width top	\$925
	18	n/a	28 3/4	31	7	<b>FN18RBA</b> · for use with 36" width top · access panel	\$1,057



Description	D	W	H	CTN WT	CU FT	① Model	List Price
Half Round Base 	12	24	28 3/4	35	6	<b>FN24HRB</b> · for use with 54" width top	\$849
	12	24	28 3/4	33	6	<b>FN24HRBA</b> · for use with 54" width top · access panel	\$1,000
	10	20	28 3/4	30	5	<b>FN20HRB</b> · for use with 42" and 48" width top	\$774
	10	20	28 3/4	28	5	<b>FN20HRBA</b> · for use with 42" and 48" width top · access panel	\$927
	9	18	28 3/4	27	4	<b>FN18HRB</b> · for use with 36" width top	\$743
	9	18	28 3/4	26	4	<b>FN18HRBA</b> · for use with 36" width top · access panel	\$897
	Square Base 	30	30	28 3/4	83	6	<b>FN30SB</b> · for use with 60" width top
30		30	28 3/4	68	16	<b>FN30SBA</b> · for use with 60" width top · access panel	\$1,195
24		24	28 3/4	68	12	<b>FN24SB</b> · for use with 54" width top	\$937
24		24	28 3/4	68	12	<b>FN24SBA</b> · for use with 54" width top · access panel	\$1,070
18		18	28 3/4	39	7	<b>FN18SB</b> · for use with 36", 42" and 48" width top	\$809
18		18	28 3/4	39	7	<b>FN18SBA</b> · for use with 36", 48" and 48" width top · access panel	\$941
Cross Base 		30	30	28 3/4	80	16	<b>FN30XB</b> · for use with 60" width top
	24	24	28 3/4	80	12	<b>FN24XB</b> · for use with 48" and 54" width top	\$792
	18	18	28 3/4	50	7	<b>FN18XB</b> · for use with 30", 36" and 42" width top	\$707

**To Order, Specify:**

- ① Model Number
- ② Wood Species
- ③ Finish Color
- ④ Power and Data Options (see pages 519-535)
- ⑤ Other Product Options

Description	D	W	H	CTN WT	CU FT	① Model	List Price
-------------	---	---	---	-----------	----------	---------	------------

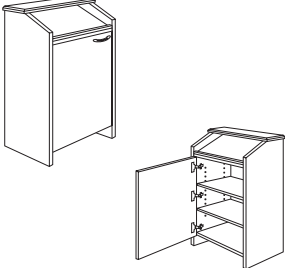
 <p>Conference Lectern</p> <ul style="list-style-type: none"> <li>· two adjustable shelves</li> <li>· four concealed, locking casters</li> <li>· door non-locking</li> <li>· standard door is hinged on left</li> <li>· round grommet in bottom panel</li> <li>· notches in adjustable shelves allow wires to pass through</li> </ul>	23	27	48	250	23	FN2622LEC	\$3,001
---	----	----	----	-----	----	-----------	---------

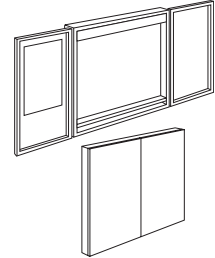
 <p>Visual Board</p> <p><b>NOW!</b></p> <ul style="list-style-type: none"> <li>· corkboard on right and left doors; paper pad on left only</li> <li>· marker board in center</li> <li>· four markers and eraser included</li> <li>· optional face applied pulls</li> <li>· locking not available</li> </ul>	3½	48	48	125	8	FN4848VB	\$3,483
---	----	----	----	-----	---	----------	---------

 <p>Buffet Credenza</p> <p><b>NOW!</b></p> <ul style="list-style-type: none"> <li>· top edge profile on user side</li> <li>· four door credenza</li> <li>· four box drawers above doors</li> <li>· locking doors and drawers not available</li> <li>· adjustable shelf in storage cabinet</li> <li>· two end panel grommets with wire pass thru</li> <li>· back panel includes cord exit grommets</li> </ul>	24	71½	36	280	43	FN2472BSC	\$5,307
--	----	-----	----	-----	----	-----------	---------

 <p>Buffet Credenza - Flat Screen Support</p> <ul style="list-style-type: none"> <li>· top edge profile on user side</li> <li>· four door credenza</li> <li>· four box drawers above doors</li> <li>· locking doors and drawers not available</li> <li>· adjustable shelf in storage cabinet</li> <li>· two end panel grommets with wire pass thru</li> <li>· flat screen mounting grommets in top</li> <li>· back panel includes cord exit grommets</li> </ul>	24	71½	36	280	43	FN2472BSCT	\$5,760
---	----	-----	----	-----	----	------------	---------

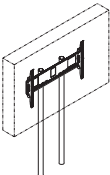
 <p>Flat Screen Mounting Frame</p> <ul style="list-style-type: none"> <li>· round 2" tube frame with cable management to inside of credenza</li> <li>· mounting bracket for TV provided (see page 535)</li> <li>· available in black (B) or silver (S)</li> <li>· TV not included</li> <li>· TV dimension not to exceed 70"w x 38"h to allow proper mounting clearance</li> <li>· coordinates with FN2472BSCT</li> </ul>	2	14	55	35	4	FSTV	\$1,518
--	---	----	----	----	---	------	---------

FINALE

Description	D	W	H	CTN WT	CU FT	① Model	List Price
<b>72" h File/File Lateral Storage Cabinet</b>	24	35 3/8	72	360	43	FN3672SWLF	\$4,396

**NOW!**

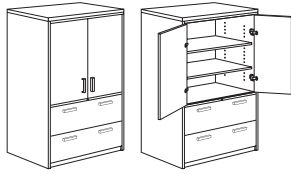

- two adjustable shelves
- locking doors available; specify and add \$123 list
- top edge profile on user side only
- file/file lateral
- pedestal locking

<b>72" h Wardrobe</b>	24	35 3/8	72	360	41	FN3672W	\$3,408
-----------------------	----	--------	----	-----	----	---------	---------

**NOW!**

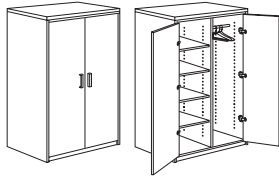

- top edge profile on user side
- chrome hanging bar on right
- one fixed shelf second from bottom on left
- locking doors available; specify and add \$246 list

<b>Hanging Bar to Shelves Conversion Kit</b>	24	18	3/4	56	2	FN1824SK	\$780
--	----	----	-----	----	---	----------	-------

**NOW!**

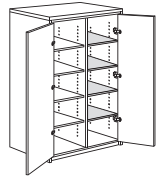

- four shelves
- for 36" wide wardrobe

**To Order, Specify:**

- ① Model Number
- ② Wood Species
- ③ Finish Color
- ④ Edge Profile
- ⑤ Pull (style and color)
- ⑥ Grommet Color
- ⑦ Power and Data Options (see pages 519-535)
- ⑧ Other Product Options

When ordering Quickship products, place a "Q" in front of model number.  
Example: QV3072DD

**NOW!**  
*Need it.*  
JSI Quickship

Description	D	W	H	CTN WT	CU FT	① Model	List Price
72" h File/File Storage Wardrobe	24	23 5/8	72	340	29	FN2472SWR	\$3,209
	24	23 5/8	72	340	29	FN2472SWL	\$3,209

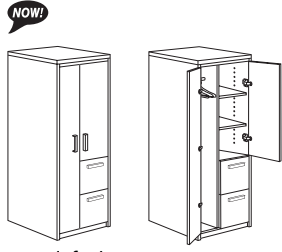

- top edge profile on user side
- chrome hanging bar
- two adjustable shelves
- file/file pedestal
- locking not available

left shown

Description	D	W	H	CTN WT	CU FT	① Model	List Price
72" h Wardrobe	24	18	72	233	23	FN1872WR	\$2,854
	24	18	72	233	23	FN1872WL	\$2,854

**NOW!**

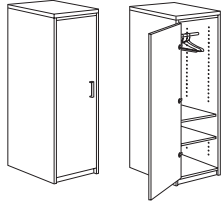

left shown

- top edge profile on user side
- chrome hanging bar at top
- one fixed shelf 26 1/2" from cabinet floor
- one adjustable shelf
- locking doors available; specify and add \$123 list

**To Order, Specify:**

- ① Model Number
- ② Wood Species
- ③ Finish Color
- ④ Edge Profile
- ⑤ Pull (style and color)
- ⑥ Grommet (style and color)
- ⑦ Power and Data Options (see pages 519-535)
- ⑧ Other Product Options

When ordering Quickship products, place a "Q" in front of model number.  
Example: QV3072DD



### Fresco Table Bases Order Check List:



**Specify:**  
 1. Model Number  
 2. Finish/Color

**Example:**

**FR24-THD** | **BSX**  
(model #) | (finish)

---

**1. Model Number**

---

**2. Base Color Options:**

Powdercoat  
BSX Black Sandtex  
STS Stardust Silver

Chrome  
CHR Chrome

Description	H	Base Spread	W	CTN WT	① Model	Powder Coat	Chrome
-------------	---	-------------	---	--------	---------	-------------	--------

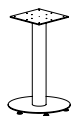

- 4" diameter column
- specify Black Sandtex, Stardust Silver or Chrome finish
- 18" disc base diameter
- compatible with Prep or Menu tops
- for use with 24" and 30" round or 24" square top

Fresco Table Height Disc Base	27 3/4	23 3/4	45	3	FR24-THD	\$1,134	\$1,440
-------------------------------	--------	--------	----	---	----------	---------	---------

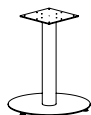

- 4" diameter column
- specify Black Sandtex, Stardust Silver or Chrome finish
- 23 3/4" disc base diameter
- compatible with Prep or Menu tops
- for use with 36" or 42" round or 30" or 36" square top

Fresco Table Height Disc Base	27 3/4	28	50	4	FR28-THD	\$1,320	\$1,737
-------------------------------	--------	----	----	---	----------	---------	---------

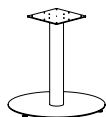

- 4" diameter column
- specify Black Sandtex, Stardust Silver or Chrome finish
- 28" disc base diameter
- compatible with Prep or Menu tops
- for use with 48" round or 42" square top

Fresco Counter Height Disc Base	34 3/4	18	32	4	FR18-CHD	\$1,053	\$1,373
---------------------------------	--------	----	----	---	----------	---------	---------

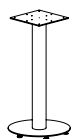

- 4" diameter column
- specify Black Sandtex, Stardust Silver or Chrome finish
- 18" disc base diameter
- compatible with Prep or Menu tops
- for use with 24" and 30" round or 24" square top

**To Order, Specify:**

- ① Model Number
- ② Base Color

**④ Base Color:**

- BSX Black Sandtex
- CHR Chrome
- STS Stardust Silver

**Specifications**

- All bases have a 4" diameter column.
- All bases have 1/4" thick round disc base.
- All bases have adjustable glides, 1" from floor to bottom of disc.
- Each base ships in two cartons.
- Mounting plate is welded to column.
- Disc bolts to bottom of column in field.

Description	H	Base Spread	W	CTN WT	① Model	Powder Coat	Chrome
Fresco Counter Height Disc Base	34 ¾	23 ¾	48	4	FR24-CHD	\$1,229	\$1,584

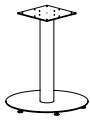

- 4" diameter column
- specify Black Sandtex, Stardust Silver or Chrome finish
- 23 ¾" disc base diameter
- compatible with Prep or Menu tops
- for use with 36" or 42" round or 36" or 36" square top

Fresco Bar Height Disc Base	40 ¾	18	32	4	FR18-BHD	\$1,053	\$1,373
-----------------------------	------	----	----	---	----------	---------	---------

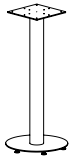

- 4" diameter column
- specify Black Sandtex, Stardust Silver or Chrome finish
- 18" disc base diameter
- compatible with Prep or Menu tops
- for use with 24" and 30" round or 24" square top

Fresco Bar Height Disc Base	40 ¾	23 ¾	50	4	FR24-BHD	\$1,229	\$1,584
-----------------------------	------	------	----	---	----------	---------	---------

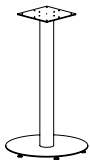

- 4" diameter column
- specify Black Sandtex, Stardust Silver or Chrome finish
- 23 ¾" disc base diameter
- compatible with Prep or Menu tops
- for use with 36" or 42" round or 30" or 36" square top

**To Order, Specify:**

- ① Model Number
- ② Base Color

**② Base Color Options:**

- BSX Black Sandtex
- CHR Chrome
- STS Stardust Silver

**Specifications**

- All bases have a 4" diameter column.
- All bases have ¼" thick round disc base.
- All bases have adjustable glides, 1" from floor to bottom of disc.
- Each base ships in two cartons.
- Mounting plate is welded to column.
- Disc bolts to bottom of column in field.



# Accessories, Power and Data



## Accessories - Overview

### Power Accessories

Pages 521-524



Power and Data Tilt Out



15" Power and Data Unit



Dual Sided Power and Data Unit



Single Sided Power and Data Unit

### Telecom Jacks

Pages 528-531

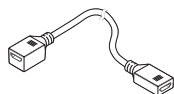

HDMI Connector

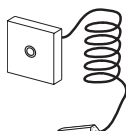

Mini Stereo Jack

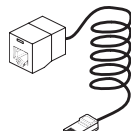

Network Jack

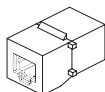

Voice Coupler

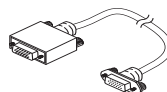

Data Jack

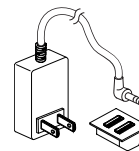

Dual Powered Charging USB

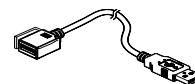

3.0 USB Connector

### Wire Management Accessories

Page 525



Vertical Wire Manager



Wire Management Channel

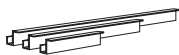

Wire Management Trough



Wire Management Channel



Cable Management Clip



Velcro Straps

### Task Lights

Pages 532-533



48" w Task Light



24" w Task Light



31" w LED Starter Task Light



31" w LED Linking Adder Task Light



17" w LED Starter Task Light



17" w LED Linking Adder Task Light



Motion Sensor for Task Lights

### Keyboard Accessories

Pages 534

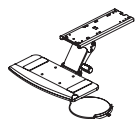

Articulating Keyboard Tray

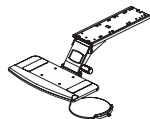

Articulating Keyboard Tray



Articulating Keyboard Tray

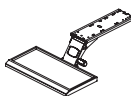

Articulating Keyboard Tray



Keyboard Tray Mouse Pad

### Monitor Support Arm

Page 535



For Use with Desk Bookcases

Description	D	W	H	CTN WT	CU FT	① Model	List Price
Power and Data Tilt Out	3	7		3		EC3	\$372

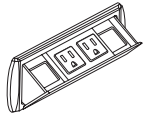

(standard location)

- spring assist tilt up access
- two power receptacles 120 volt, 15amp and two openings for voice/data jacks
- data adapter kit provided to accept jacks from most port manufacturers (see page 530)
- accepts up to two Type 3 Telecom Jacks (see page 531)
- 72" power cord with molded plug
- drop in field installation required
- cut out provided in center of back panel of storage cabinet below tackboard
- UL listed component
- Black or Silver finish

For Use with Desk and Conference Tables

Description	D	W	H	CTN WT	CU FT	① Model	List Price
Mini Power and Data Tilt Up	4 1/4	5 1/2		6	1	EC10	\$428



- fluid one touch tilt up access
- one power receptacle - 120 volt; 15 amp and one opening for voice/data port
- data adapter kit provided to accept jacks from most port manufacturers (see page 527)
- accepts one Type 3 Telecom Jack (see page 531)
- 72" power cord with molded plug
- drop in field installation required
- cut out provided in top at specified location (see page 526)
- UL listed component
- Black or Silver finish

Mini Power Tilt Up	4 1/4	5 1/2		6	1	EC11	\$446
--------------------	-------	-------	--	---	---	------	-------



- fluid one touch tilt up access
- two power receptacles - 120 volt; 15 amp
- 72" power cord with molded plug
- drop in field installation required
- cut out provided in top at specified location (see page 526)
- UL listed component
- Black or Silver finish

Mini Power and USB Tilt Up	4 1/4	5 1/2		6	1	EC12	\$555
----------------------------	-------	-------	--	---	---	------	-------



- fluid one touch tilt up access
- two power receptacles - 120 volt; 15 amp dual powered USB
- 72" power cord with molded plug
- drop in field installation required
- cut out provided in top at specified location (see page 526)
- UL listed component
- Black or Silver finish

To Order, Specify:

- ① Model number
- ② Finish

## For Use with Desk Bookcases

ACCESSORIES

Description	D	W	H	CTN WT	CU FT	① Model	List Price
Quad Power and Data Pop Up	11 5/8	11 5/8		27	3	EC1	\$2,810



- used on square top configuration
- spring loaded - touch release pop up
- two power receptacles - 120 volt; 15 amp on each side
- accepts up to four (4) Type 1 Telecom Plates; additional plate configurations sold separately, see pages 524-525
- unit ships standard with four (4) TCP101, two (2) TCP 110 Telecom Plates and two (2) data adapter kits
- 72" power cord with molded plug
- field installation required
- cut out provided in top at specified location (see page 526)
- must be located above 24" or larger round or square base
- black metal top, trim and housing standard
- brushed stainless steel top and trim available, specify and add \$640 list upcharge
- CSA certified component

Power and Data Tilt Out	30	9		7	6	EC4	\$4,411
-------------------------	----	---	--	---	---	-----	---------

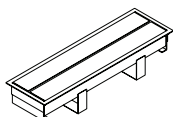

closed

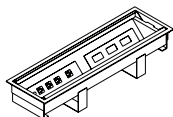

open

- 30" power and data unit
- retractable doors
- standard in silver pearl powder coat
- brush aluminum doors available; specify and add \$1,753 list
- door design allows cords/cables to exit while doors are in closed position
- seven power receptacles
- one dual powered USB
- accepts up to six (6) Type 1 Telecom Plates; additional plate configurations sold separately, see see pages 528-529
- unit ships standard with six (6) TCP101, three (3) TCP110 Telecom Plates and three (3) data adapter kits
- power inserts are UL or ETL listed
- two 108" power cords with molded plugs
- cannot be positioned over table support base

Description	D	W	H	CTN WT	CU FT	① Model	List Price
<b>15" Power and Data Unit</b>	15	9		4	2	<b>EC5</b>	<b>\$2,821</b>

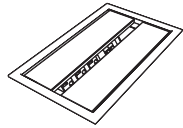

closed

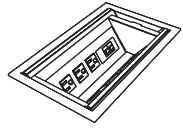

open

- retractable doors
- available in silver pearl powder coat
- brush aluminum doors available; specify and add \$877 list
- door design allows cords/cables to exit while doors are in closed position
- three power receptacles
- one dual powered USB
- accepts up to three (3) Type 1 Telecom Plates; additional plate configurations sold separately, see pages 528-529
- unit ships standard with three (3) TCP101, two (2) TCP110 Telecom Plates and two (2) data adapter kits
- power inserts are UL or ETL listed
- 108" power cord with molded plug

<b>Dual Sided Power and Data Unit</b>	11 ½	14 ¾		7	2	<b>EC6</b>	<b>\$1,968</b>
---------------------------------------	------	------	--	---	---	------------	----------------

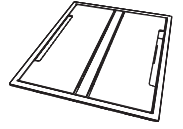

closed

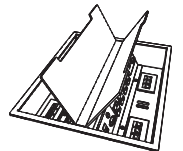

open

- door design allows cords/cables to exit while doors are in closed position
- eight power receptacles, four per side
- accepts up to eight (8) Type 1 Telecom Plates; additional plate configurations sold separately, see pages 528-529
- unit ships standard with four (4) TCP101, four (4) TCP110 Telecom Plates and two (2) data adapter kits
- lids lift to open and contain an access slot to allow cords to exit while in use
- available in silver pearl and black texture powder coat
- units are UL listed and CSA certified
- 108" power cord with molded plug

<b>Single Sided Power and Data Unit</b>	5 ¾	9		4	1	<b>EC7</b>	<b>\$750</b>
---	-----	---	--	---	---	------------	--------------



- two power receptacles
- accepts one (1) Type 1 Telecom Plates; additional plate configurations sold separately, see pages 528-529
- unit ships standard with one (1) TCP101, one (1) TCP110 Telecom Plate and one (1) data adapter kit
- additionally accepts up to (4) Type 2 Telecom Jacks
- lid lifts to open and contain an access slot to allow cords to exit while in use
- available in silver pearl or black textured powder coat finish
- units are UL listed and CSA certified
- 108" power cord with molded plug
- one under surface power receptacle

**To Order, Specify:**

- ① Model number

When ordering Quickship products, place a "Q" in front of model number.  
Example: QAK1



Description	D	W	H	CTN WT	CU FT	① Model	List Price
<b>Single Sided Power and Data Unit</b>	8 3/8	4		3	1	<b>EC9</b>	<b>\$875</b>

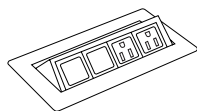

- two power receptacles - 120 volt, 15 amp and two openings for voice/data jacks
- data adapter kit provided to accept jacks from most port manufacturers (see page 526)
- accepts up to two Type 3 Telecom Jacks (see page 531)
- push to open pop up door
- clear anodized aluminum
- 72" power cord with molded plug
- UL listed

<b>Dual Power and Data Tilt Up</b>	8	8 3/8		16	1	<b>EC13</b>	<b>\$1,130</b>
------------------------------------	---	-------	--	----	---	-------------	----------------

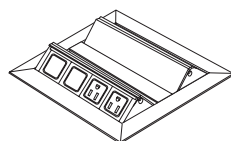

- fluid one touch tilt up access
- back to back tilt sections
- four power receptacles (2 per side) - 120 volt; 15 amp with four openings for voice/data jacks (2 per side)
- data adapter kit provided to accept jacks from most port manufacturers
- accepts up to four Type 3 Telecom Jacks (see page 531)
- two 72" power cord with molded plug
- drop in field installation required
- cut out provided in top at specified location (see page 526)
- UL listed component
- available in Silver (S)

<b>Edge Mount Electrical</b>	3	10		16	1	<b>EC15</b>	<b>\$503</b>
------------------------------	---	----	--	----	---	-------------	--------------

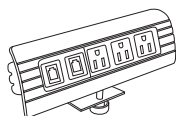

- clamp mounts to the edge of the worksurface - requiring minimum 2" surface overhang
- three power receptacles - 120 volt; 15 amp with two voice/data ports
- data adapter kit provided to accept jacks from most port manufacturers
- accepts up to two Type 3 Telecom Jacks (see page 531)
- 72" power cord with molded plug - exits back of unit
- UL listed component
- clear anodized aluminum

Description	D	W	H	CTN WT	CU FT	1 Model	List Price
Worksurface Power	2 5/8	6 3/8	3	3	1	EC26	\$606

**NOW!**

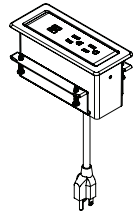

- two power receptacles - 120 volt; 15 amp dual powered USB
- 120" power cord with molded plug
- White (W) or Black (B) finish available, specify when ordering
- UL recognized
- meets UL spill requirements

Edge Mount Power	3 1/2	5 1/2	7 1/2	3	1	EC28	\$577
------------------	-------	-------	-------	---	---	------	-------

**NOW!**

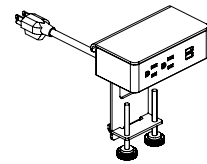

- two power receptacles - 120 volt; 15 amp dual powered USB
- 72" power cord with molded plug
- White (W) or Black (B) finish available, specify when ordering
- UL recognized

Power Center - Under Mount	2 3/4	4	2 5/8			EC30	\$471
----------------------------	-------	---	-------	--	--	------	-------

**NOW!**

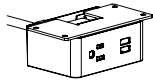

- 10' cord
- frame mounted simplex receptacle and two USB/10' - three prong plug power cord
- specify black or white - cord color will match unit
- optional graphite fabric cord available, specify and add \$196 list
- overall mounting bracket tabs: 5" w

Wireless Charging Unit	3 1/2	3 1/2	1	3	1	EC33	\$369
------------------------	-------	-------	---	---	---	------	-------

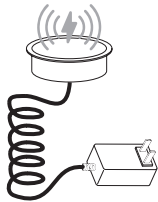

- wireless charging for use with Qi enabled devices
- 72" power cord
- black
- UL Listed
- CE/FCC certified

Under Surface Convenience Power Unit	3 1/8	7 1/8	2 1/8	3	1	EC34	\$382
--------------------------------------	-------	-------	-------	---	---	------	-------

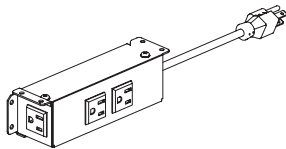

- three outlets
- 120" power cord
- black
- ETL Listed for US

**To Order, Specify:**

1 Model number

When ordering Quickship products, place a "Q" in front of model number.  
Example: QAK1

**NOW!**  
Need it.  
JSI Quickship

Description	D	W	H	CTN WT	CU FT	① Model	List Price
2"dia. Grommet	2	2	7/8			GP02FIG	\$28

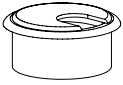

- use in panels 3/4" thick or greater
- plastic sleeve and removable lid
- matte black (MBK)
- interior 1 1/2" dia.
- recommended 1 3/4" dia. cut out for installation in field

3"dia. Grommet	3	3	3/4			GP03FIG	\$28
----------------	---	---	-----	--	--	---------	------

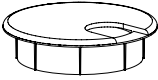

- use in panels 3/4" thick or greater
- plastic sleeve and removable lid
- matte black (MBK)
- interior 2 1/4" dia.
- recommended 2 5/8" dia. cut out for installation in field

Power Strip	1 1/2	1 7/8	8			GP9ACP1-0212	\$81
-------------	-------	-------	---	--	--	--------------	------

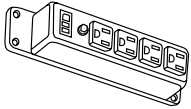

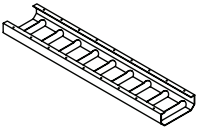

- includes switch
- power surge with 10' cord
- four electrical outlets

Wire Management Trays	7 1/2	45				GP9WMT1-0845	\$234
	7 1/2	35				GP9WMT1-0835	\$198
	7 1/2	25				GP9WMT1-0825	\$160



- silver powder-coated finish
- four hanging brackets (CI2C00)

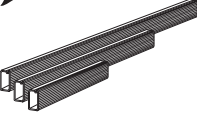
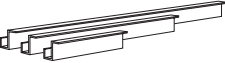
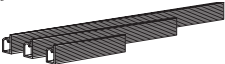

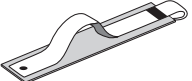
Description	D	W	H	CTN WT	CU FT	① Model	List Price
<b>Vertical Wire Manager</b>  <ul style="list-style-type: none"> <li>flexible, vertebrae-style construction</li> <li>field installed to bottom of worksurface with screws provided</li> <li>length can be adjusted by removing individual discs as required</li> <li>wire manager is 1 1/2" diameter</li> <li>weighted base is 4" diameter</li> <li>black plastic</li> </ul>	1 1/2	1 1/2	45	4	1	45VWM	\$113
<b>Wire Management Channel</b>  <ul style="list-style-type: none"> <li>available in 12", 24" and 36" increments</li> <li>field installed with adhesive tape provided</li> <li>black</li> </ul>	1/2	36	1	4		36WC	\$68
	1/2	24	1	3		24WC	\$61
	1/2	12	1	2		12WC	\$53
<b>Wire Management Trough</b>  <ul style="list-style-type: none"> <li>available in 12", 24" and 36" increments</li> <li>field installed with screws provided</li> <li>black</li> </ul>	2 1/2	36	2 1/2	3		36WCT	\$132
	2 1/2	24	2 1/2	3		24WCT	\$119
	2 1/2	12	2 1/2	2		12WCT	\$103
<b>Wire Management Trough</b>  <ul style="list-style-type: none"> <li>available in 12", 24" and 36" increments</li> <li>field installed with adhesive tape provided</li> <li>mounts to edge of surface top</li> <li>black</li> </ul>	1 1/8	36	2 3/8	1		36WJC	\$56
	1 1/8	24	2 3/8	1		24WJC	\$40
	1 1/8	12	2 3/8	1		12WJC	\$21
<b>Cable Management Clip</b>  <ul style="list-style-type: none"> <li>four retention loops</li> <li>field installed with screws provided</li> <li>mounts under surface</li> <li>black</li> </ul>	2 5/8	3 3/4	1 5/8	1		0304CMC	\$46
<b>Wire Management Velcro Straps</b>  <ul style="list-style-type: none"> <li>set of four</li> <li>field installed with adhesive tape provided</li> <li>mounts under surface or on vertical panels</li> <li>black</li> </ul>	1 3/4	3 1/2	1/8	1		04WVS	\$48

**To Order, Specify:**

① Model number

When ordering Quickship products, place a "Q" in front of model number.  
 Example: QAK1

**NOW!**  
 Need it.  
 JSI Quickship

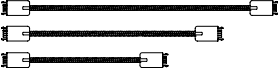
Description	D	W	H	CTN WT	CU FT	① Model	List Price
<b>Jumper</b> 	144			4	1	ECT4T-144JK	\$218
	138			4	1	ECT4T-138JK	\$213
	132			4	1	ECT4T-132JK	\$208
	126			4	1	ECT4T-126JK	\$204
	120			4	1	ECT4T-120JK	\$200
	114			4	1	ECT4T-114JK	\$196
	108			4	1	ECT4T-108JK	\$193
	102			4	1	ECT4T-102JK	\$187
	96			3	1	ECT4T-96JK	\$178
	90			3	1	ECT4T-90JK	\$178
	84			3	1	ECT4T-84JK	\$174
	78			3	1	ECT4T-78JK	\$168
	72			3	1	ECT4T-72JK	\$165
	66			3	1	ECT4T-66JK	\$157
	60			3	1	ECT4T-60JK	\$147
	54			3	1	ECT4T-54JK	\$143
	48			2	1	ECT4T-48JK	\$130
	42			2	1	ECT4T-42JK	\$130
	36			2	1	ECT4T-36JK	\$126
	30			2	1	ECT4T-30JK	\$122
24			2	1	ECT4T-24JK	\$118	
18			2	1	ECT4T-18JK	\$117	

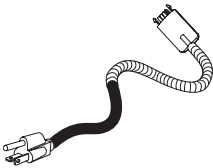
<b>Three Prong Power Infeed - Flex Metallic Conduit</b> 	120			4	1	ECT4T-120APE	\$331
	108			4	1	ECT4T-108APE	\$323
	96			3	1	ECT4T-96APE	\$315
	84			3	1	ECT4T-84APE	\$312
	72			3	1	ECT4T-72APE	\$264
	60			3	1	ECT4T-60APE	\$225
	48			2	1	ECT4T-48APE	\$218

- single circuit infeed
- two foot rubber cord transitions to metal conduit

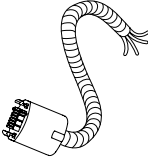
<b>Hardwire Power Infeed - Flex Metallic Conduit</b> 	144			4	1	ECT4T-144HPE	\$204
	132			4	1	ECT4T-132HPE	\$195
	120			4	1	ECT4T-120HPE	\$189
	108			4	1	ECT4T-108HPE	\$183
	96			3	1	ECT4T-96HPE	\$172
	84			3	1	ECT4T-84HPE	\$163
	72			3	1	ECT4T-72HPE	\$155

- single or double circuit infeed
- 4 wire 2 circuit system
- 13 duplexes available per each circuit

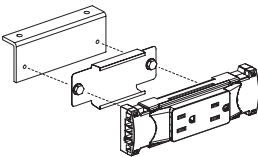
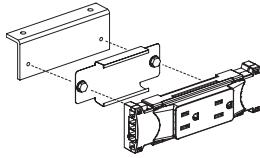
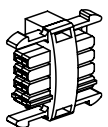
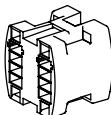
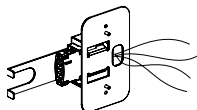
Description	D	W	H	CTN WT	CU FT	① Model	List Price
<b>Conduit Clamp</b>  <ul style="list-style-type: none"> <li>· includes screw</li> </ul>				1	1	ECT4T-CLAMP	\$10
<b>Duplex Receptacle Kit Circuit 1</b>  <ul style="list-style-type: none"> <li>· used in single circuit and multi-circuit applications</li> <li>· vertical and horizontal mounting brackets included</li> </ul>				1	1	ECT4T-DUP1K	\$112
<b>Duplex Receptacle Kit Circuit 2</b>  <ul style="list-style-type: none"> <li>· used in multi-circuit applications</li> <li>· vertical and horizontal mounting brackets included</li> </ul>				1	1	ECT4T-DUP2K	\$112
<b>Receptacle to Receptacle Connector</b> 				1	1	ECT4T-R2R	\$67
<b>H Block Connector Kit</b>  <ul style="list-style-type: none"> <li>· accepts one power infeed and connects up to three jumpers</li> <li>· mounting bracket included</li> </ul>				1	1	ECT4T-4HCON	\$74
<b>Quick Disconnect</b>  <ul style="list-style-type: none"> <li>· hardwire connection (4 wire), mounts to wall</li> <li>· accommodates single or multi-circuit</li> <li>· connects directly to jumper in place of power infeed</li> </ul>	1	2 3/4	4 5/8	1	1	ECT4T-4QD	\$148

To Order, Specify:  
 ① Model number

**Standard Power and Data Locations for Casegoods:**

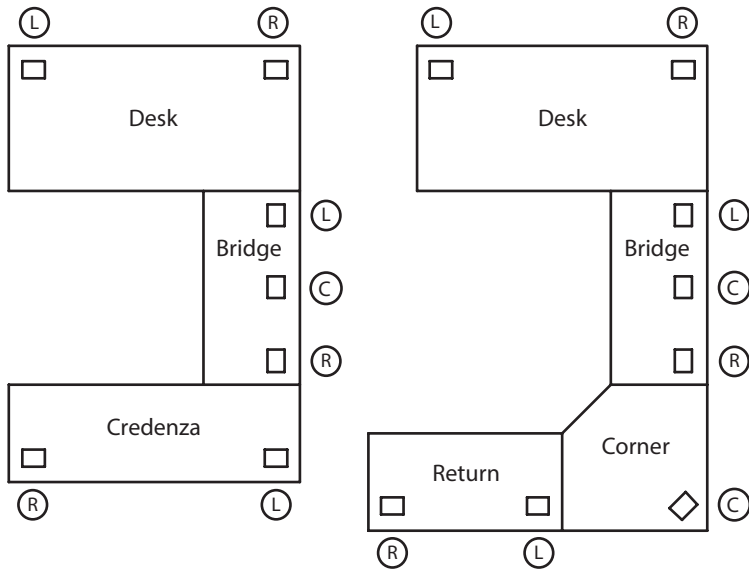

- Specify - Location when ordering on desk, return, computer corner, bridge and credenza - please provide drawing.
- Computer corner units - power/data replaces grommet.
- Standard power and data unit locations are indicated from user side of desk, return, computer corner bridge or credenza.

**NOTE:** Verify fit of data jack in adapter before ordering large quantities as manufacturer designs may change without notice

**Standard Power and Data Locations for Tables and Conference Units:**

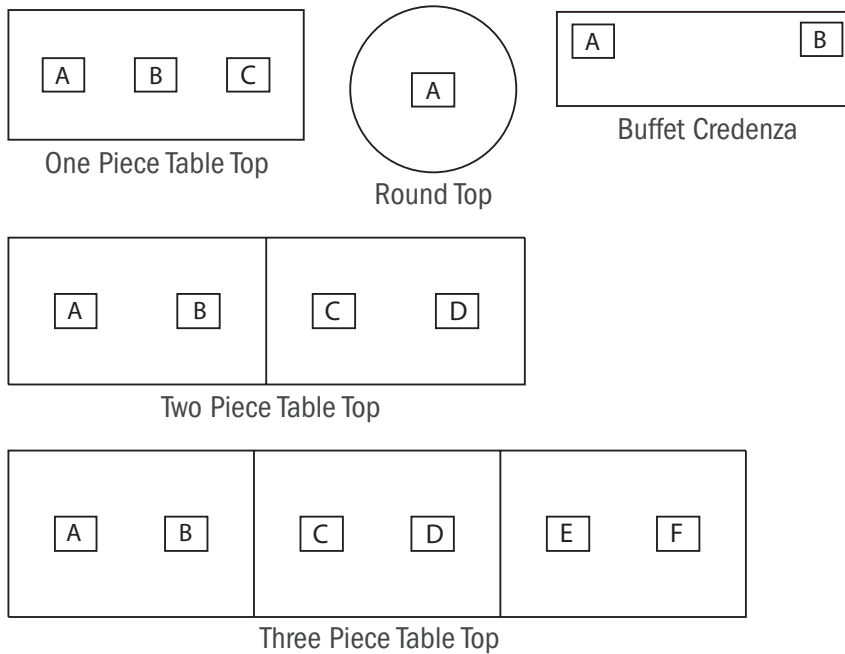

- Verify fit of jack in adapter before ordering large quantities as manufacturer designs may change without notice.
- Installation of Power and Data units on a seam of multi piece tops should be avoided when possible.
- Specify location when ordering conference tops or buffet credenza.
- Standard power and data units are indicated from the side of conference tops and user side of buffet credenza.

## Data Adapter Applications

Data adapter kits ship with each power and data unit.

Adapter plates are marked on the back with letter designators to indicate the data jack manufacturer, series and style. Websites are listed below for quick reference to verify data jack series or style.

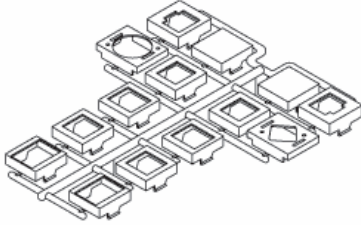



*Included with EC9, EC10, EC13, EC15, TCP110 and CC9CNE1-0708.*

**NOTE:** Verify fit of data jack in adapter before ordering large quantities as manufacturer designs may change without notice.

Adapter	Manufacturer	Website
AA	Uniprise/Systimax/Avaya	<a href="http://www.unipriseresolutions.com">www.unipriseresolutions.com</a>
BB	Tyco SL and 100 Connect Series Modular Jacks	<a href="http://www.ampconnect.com">www.ampconnect.com</a>
BB	Siemon Keystone Style	<a href="http://www.siemon.com">www.siemon.com</a>
BB	Allen Tel Versa Tap Series	<a href="http://www.allentel.com">www.allentel.com</a>
BB	Leviton Quick Port® Series	<a href="http://www.leviton.com">www.leviton.com</a>
BB	Nordx Keystone Style	<a href="http://www.nordx.com">www.nordx.com</a>
CC	Tyco SL Coupler Series	<a href="http://www.ampconnect.com">www.ampconnect.com</a>
CC	Krone 6000 Series	<a href="http://www.adc.com">www.adc.com</a>
CC	Hubbell Xcelerator™ Keystone Series	<a href="http://www.hubbell.com">www.hubbell.com</a>
DD	Blank (no coupler/jack)	
EE	Ortronics TracJack Series	<a href="http://www.ortronics.com">www.ortronics.com</a>
FF	Panduit Mini-Com Series	<a href="http://www.panduit.com">www.panduit.com</a>
GG	Microphone jack/3-pin XLR, solder type only	
HH	Video Monitor jack/DB-15, panel mount solder style	

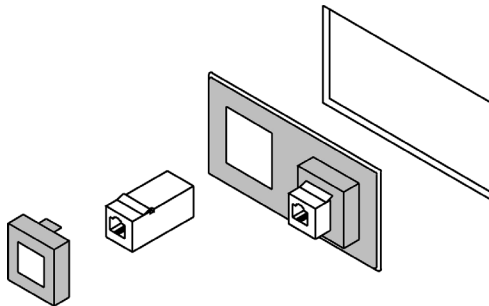
The TCP110 Type 1 Data plate comes with the adapter kit to allow installation of data jacks listed above. The TCP110 can be installed in the EC1, EC4, EC5, EC6, EC7.

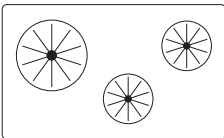
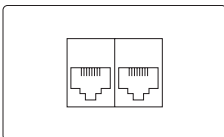
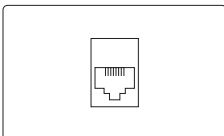
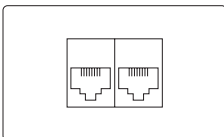
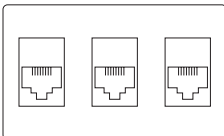
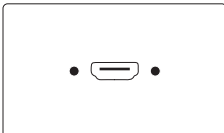

Description	D	W	H	CTN WT	CU FT	① Model	List Price
<b>Data Plate - Blank Cap</b>  <ul style="list-style-type: none"> <li>· for use in EC1, EC4, EC5, EC6, EC7</li> </ul>		1 3/4	3 1/8			<b>TCP101</b>	<b>\$13</b>
<b>Data Plate - Three Cord Bushings</b>  <ul style="list-style-type: none"> <li>· for use in EC1, EC4, EC5, EC6, EC7</li> </ul>		1 3/4	3 1/8			<b>TCP102</b>	<b>\$52</b>
<b>Data Plate - Two Jacks</b>  <ul style="list-style-type: none"> <li>· one RJ11 Cat3 Jack</li> <li>· one RJ-45 Cat6 Jack</li> <li>· for use in EC1, EC4, EC5, EC6, EC7</li> </ul>		1 3/4	3 1/8			<b>TCP103</b>	<b>\$128</b>
<b>Data Plate - One Jack</b>  <ul style="list-style-type: none"> <li>· one RJ-45 Cat6 jack</li> <li>· for use in EC1, EC4, EC5, EC6, EC7</li> </ul>		1 3/4	3 1/8			<b>TCP104</b>	<b>\$90</b>
<b>Data Plate - Two Jacks</b>  <ul style="list-style-type: none"> <li>· two RJ-45 Cat6 jacks</li> <li>· for use in EC1, EC4, EC5, EC6, EC7</li> </ul>		1 3/4	3 1/8			<b>TCP105</b>	<b>\$171</b>
<b>Data Plate - Three Jacks</b>  <ul style="list-style-type: none"> <li>· three RJ-45 Cat6 jacks</li> <li>· for use in EC1, EC4, EC5, EC6, EC7</li> </ul>		1 3/4	3 1/8			<b>TCP106</b>	<b>\$248</b>
<b>Data Plate - HDMI</b>  <ul style="list-style-type: none"> <li>· one HDMI female to female with 36" cord</li> <li>· for use in EC1, EC4, EC5, EC6, EC7</li> </ul>		1 3/4	3 1/8			<b>TCP107</b>	<b>\$198</b>

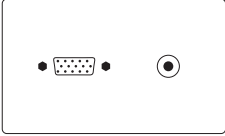
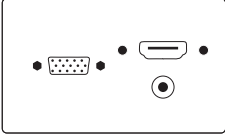
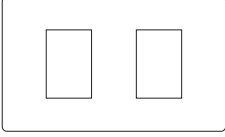
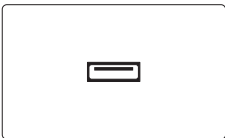
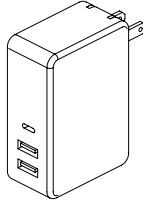
Description	D	W	H	CTN WT	CU FT	① Model	List Price
<b>Data Plate - VGA and Mini-Stereo</b>  <ul style="list-style-type: none"> <li>· one VGA female to female with 72" cord</li> <li>· one Mini-Stereo Inline</li> <li>· for use in EC1, EC4, EC5, EC6, EC7</li> </ul>		1 3/4	3 1/8			<b>TCP108</b>	<b>\$205</b>
<b>Data Plate - VGA, HDMI and Mini-Stereo</b>  <ul style="list-style-type: none"> <li>· one VGA female to female with 72" cord</li> <li>· one HDMI female to female with 36" cord</li> <li>· one Mini-Stereo Inline</li> <li>· for use in EC1, EC4, EC5, EC6, EC7</li> </ul>		1 3/4	3 1/8			<b>TCP109</b>	<b>\$385</b>
<b>Data Plate - Two Open Data Ports</b>  <ul style="list-style-type: none"> <li>· used with two Type 3 Telecom Jacks; see page 531</li> <li>· for use in EC1, EC4, EC5, EC6, EC7</li> </ul>		1 3/4	3 1/8			<b>TCP110</b>	<b>\$17</b>
<b>Data Plate - USB 3.0</b>  <ul style="list-style-type: none"> <li>· one USB 3.0 Type A/A with 36" patch cord with male end</li> <li>· for use in EC1, EC4, EC5, EC6, EC7</li> <li>· data transfer port</li> <li>· can become powered USB charging port with addition of TCP111-POW power supply</li> </ul>		1 3/4	3 1/8			<b>TCP111</b>	<b>\$228</b>
<b>USB Charging - Power Supply</b>  <ul style="list-style-type: none"> <li>· USB power supply</li> <li>· for use with TCP111</li> <li>· converts TCP111 into USB charging port</li> <li>· power source under table or from building required to power unit</li> </ul>						<b>TCP111-POW</b>	<b>\$140</b>

**To Order, Specify:**

- ① Model number

# Type 2 Telecom Jacks

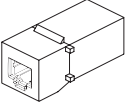
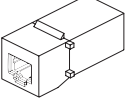

ACCESSORIES

Description	D	W	H	CTN WT	CU FT	① Model	List Price
<b>Phone Jack</b>  <ul style="list-style-type: none"> <li>· RJ-11 phone jack</li> <li>· for use in EC7</li> </ul>						<b>TCP201</b>	<b>\$95</b>
<b>Data Jack</b>  <ul style="list-style-type: none"> <li>· CAT6-RJ45 data jack</li> <li>· for use in EC7</li> </ul>						<b>TCP202</b>	<b>\$95</b>

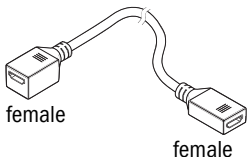
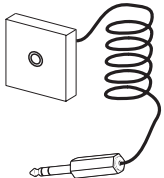
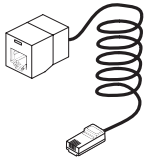
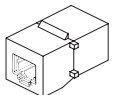
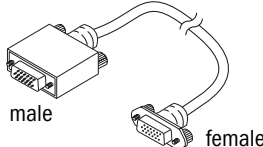
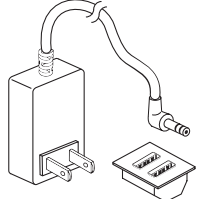
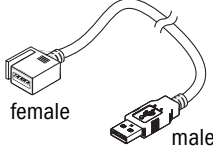

Description	D	W	H	CTN WT	CU FT	① Model	List Price
<b>HDMI Connector</b>  <ul style="list-style-type: none"> <li>· HDMI coupler</li> <li>· 18" cord</li> <li>· female to female connection</li> <li>· for use in EC9, EC10, EC13, EC15</li> <li>· uses data adapter kit BB adapter plate</li> </ul>						<b>TCP301</b>	<b>\$104</b>
<b>Mini Stereo Jack</b>  <ul style="list-style-type: none"> <li>· 3.5 mm Mini Stereo Jack</li> <li>· 10 foot cord</li> <li>· female to male connection</li> <li>· for use in EC9, EC10, EC13, EC15</li> <li>· installs directly into unit without need of data adapter kit</li> </ul>						<b>TCP302</b>	<b>\$29</b>
<b>Network Jack</b>  <ul style="list-style-type: none"> <li>· Cat5e RJ-45 Panduit Jack</li> <li>· Pre-terminated</li> <li>· 9 foot cord</li> <li>· 8-Pin</li> <li>· for use in EC9, EC10, EC13, EC15</li> <li>· uses data adapter kit FF adapter plate</li> </ul>						<b>TCP303</b>	<b>\$93</b>
<b>Voice Coupler</b>  <ul style="list-style-type: none"> <li>· AMP Category 3, RJ-11</li> <li>· 6-Pin</li> <li>· connects to standard phone cord</li> <li>· for use in EC9, EC10, EC13, EC15</li> <li>· uses data adapter kit CC adapter plate</li> </ul>						<b>TCP304</b>	<b>\$93</b>
<b>Data Jack - VGA 15 Pin</b>  <ul style="list-style-type: none"> <li>· 120" M/F cable - female-to-male connection</li> <li>· 15 pin connections</li> <li>· provides electronic device to remove display connection</li> <li>· uses data adapter kit HH adapter plate</li> </ul>						<b>TCP305</b>	<b>\$128</b>
<b>Dual Powered USB Charging</b>  <ul style="list-style-type: none"> <li>· two (2) USB-A connections for USB powered devices or charging mobile electronics</li> <li>· 2000mA (2 amp) charging power per USB port</li> <li>· black or white option</li> <li>· for use in EC9, EC10, EC13, EC15</li> <li>· installs directly into unit without need of data adapter kit</li> <li>· 27" cord</li> </ul>						<b>TCP306</b>	<b>\$171</b>
<b>Data Jack - USB 3.0</b>  <ul style="list-style-type: none"> <li>· USB 3.0 data jack with 10' cord and male plug</li> <li>· for use in EC9, EC10, EC13, EC15</li> <li>· data transfer port - no USB charging capability</li> <li>· data transfer speed up to 5gbs/sec</li> <li>· uses data adapter kit HH adapter plate</li> </ul>						<b>TCP307</b>	<b>\$93</b>

To Order, Specify:

① Model number

Description	D	W	H	CTN WT	CU FT	① Model	List Price
48" w Task Light	4 1/2	48	1 1/2	6	1	48T5L	\$449

**NOW!**



- use with overhead cabinets 60" wide and larger
- uses slim energy-efficient T5 - 3500k lamp (included)
- two position on - off switch
- prismatic lens with electronic ballast
- ETL listed component
- factory installation optional (no additional charge); please specify unit where light is to be installed

24" w Task Light	4 1/2	24	1 1/2	4	1	24T5L	\$312
------------------	-------	----	-------	---	---	-------	-------

**NOW!**

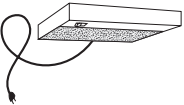

- use with overhead cabinets 30" wide and larger
- uses slim energy-efficient T5 - 3500k lamp (included)
- two position on - off switch
- prismatic lens with electronic ballast
- ETL listed component
- factory installation optional (no additional charge); please specify unit where light is to be installed

31" w LED Starter Task Light	2	31	1/2	4	1	TL31LED-S	\$713
------------------------------	---	----	-----	---	---	-----------	-------

**NOW!**





- use with overhead cabinets 42" wide and larger
- slim energy-efficient stand alone or starter LED lamp
- soft touch switching with instant on to fade way off
- infinite dimming with last state memory (dimming range 100% to 15%)
- automatic time off after 10 hours
- includes power supply
- ETL listed component
- GSA compliant
- factory installation optional (no additional charge); please specify unit where light is to be installed

31" w LED Linking Adder Task Light	2	31	1/2	4	1	TL31LED-A	\$628
------------------------------------	---	----	-----	---	---	-----------	-------

**NOW!**

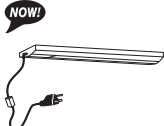
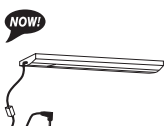

- use with overhead cabinets 42" wide and larger
- slim energy-efficient LED lamp for linking to a starter task light
- string may contain 1 starter with up to five adders
- soft touch switching with instant on to fade way off
- infinite dimming with last state memory (dimming range 100% to 15%)
- automatic time off after 10 hours
- ETL listed component
- GSA compliant
- factory installation optional (no additional charge); please specify unit where light is to be installed



Description	D	W	H	CTN WT	CU FT	① Model	List Price
<b>17" w LED Starter Task Light</b>  <ul style="list-style-type: none"> <li>• use with overhead cabinets 30" wide and larger</li> <li>• slim energy-efficient stand alone or starter LED lamp</li> <li>• soft touch switching with instant on to fade way off</li> <li>• infinite dimming with last state memory (dimming range 100% to 15%)</li> <li>• automatic time off after 10 hours</li> <li>• includes power supply</li> <li>• ETL listed component</li> <li>• GSA compliant</li> <li>• factory installation optional (no additional charge); please specify unit where light is to be installed</li> </ul>	2	17	½	2	1	TL17LED-S	\$580
<b>17" w LED Linking Adder Task Light</b>  <ul style="list-style-type: none"> <li>• use with overhead cabinets 30" wide and larger</li> <li>• slim energy-efficient LED lamp for linking to a starter task light</li> <li>• string may contain 1 starter with up to five adders</li> <li>• soft touch switching with instant on to fade way off</li> <li>• infinite dimming with last state memory (dimming range 100% to 15%)</li> <li>• automatic time off after 10 hours</li> <li>• ETL listed component</li> <li>• GSA compliant</li> <li>• factory installation optional (no additional charge); please specify unit where light is to be installed</li> </ul>	2	17	½	2	1	TL17LED-A	\$397
<b>Motion Sensor for Task Lights</b>  <ul style="list-style-type: none"> <li>• occupancy sensor for LED task lights</li> <li>• integrates with TL31LED or TL17LED</li> <li>• shuts off after 30 minutes of inactivity</li> <li>• connects to end of light fixture (adds 3" to length of fixture)</li> <li>• one sensor controls starter and connected adders</li> </ul>	2	3	½	1	1	TL03-OCPS	\$390

**To Order, Specify:**

① Model number

When ordering Quickship products, place a "Q" in front of model number.  
 Example: QAK1

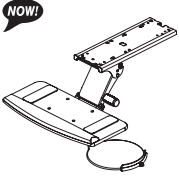
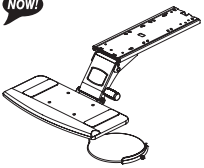
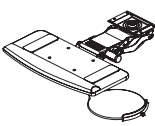
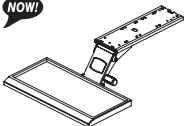
**NOW!**  
 Need it.  
 JSI Quickship

Description	D	W	H	CTN WT	CU FT	① Model	List Price
<b>Articulating Keyboard Tray</b>  <ul style="list-style-type: none"> <li>· articulating keyboard tray - black color</li> <li>· mouse tray included</li> <li>· 16" glide track</li> <li>· easy one-handed adjustment; vertical range of motion of 5.1" below glide track</li> <li>· tray tilt range +10 degree to -20 degree</li> <li>· unit swivels side-to-side</li> <li>· tray size is 19.4" wide x 9.4" deep</li> <li>· tray includes palm rest</li> <li>· tray is made with recyclable high density polyethylene</li> </ul>	13	24	7	14	2	AK2	\$540
<b>Articulating Keyboard Tray</b>  <ul style="list-style-type: none"> <li>· articulating keyboard tray - black color</li> <li>· mouse tray included</li> <li>· 17" glide track</li> <li>· easy one-handed adjustment; vertical range of motion of 8.9"; (6.5" below the glide track and an additional 2.38" above)</li> <li>· tray tilt range +10 degree to -20 degree</li> <li>· unit swivels side-to-side</li> <li>· tray size is 19.4" wide x 9.4" deep</li> <li>· tray includes palm rest</li> <li>· tray is made with recyclable high density polyethylene</li> </ul>	13	24	7	12	2	AK3	\$597
<b>Articulating Keyboard Tray</b>  <ul style="list-style-type: none"> <li>· trackless articulating keyboard tray - black color</li> <li>· mouse tray included</li> <li>· use when depth under work surface for mounting is limited; minimum of 9.38" depth recommended</li> <li>· easy one-handed adjustment; vertical range of motion of 5.73</li> <li>· tray tilt range +10 degree to -15 degree</li> <li>· unit swivels side-to-side</li> <li>· tray size is 19.4" wide x 9.4" deep</li> <li>· tray includes palm rest</li> <li>· tray is made with recyclable high density polyethylene</li> </ul>	11	23	3	11	2	AK5	\$558
<b>Articulating Keyboard Tray</b>  <ul style="list-style-type: none"> <li>· articulating keyboard tray - wood finish tray with black mechanism</li> <li>· recommended for spaces with 24" clearance side to side</li> <li>· mouse tray purchased separately - specify MT4</li> <li>· 17" glide track</li> <li>· easy one-handed adjustment; vertical range of motion of 8.9"; (6.5" below the glide track and an additional 2.38" above)</li> <li>· tray tilt range +10 degree to -20 degree</li> <li>· unit swivels side-to-side</li> <li>· tray size is 21.75" wide x 11" deep</li> <li>· wood tray requires finish selection; see component finishes for the selection</li> </ul>	14	23	7	15	2	AK4	\$640
<b>Keyboard Tray Mouse Pad</b>  <ul style="list-style-type: none"> <li>· adjusts for user comfort</li> <li>· 8" x 8"</li> <li>· for left or right hand operation</li> <li>· compatible with AK4 Keyboard Drawer only</li> </ul>	8	8	1/4	2		MT4	\$186

Description	D	W	H	CTN WT	CU FT	① Model	List Price
-------------	---	---	---	-----------	----------	---------	------------

Center Drawer	16	22	1 1/2	8	3	1622CD	\$275
---------------	----	----	-------	---	---	--------	-------

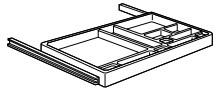

- non-locking

Wide Pencil Drawer	19 1/4	22	1 7/8	5	1	GP2219CD	\$144
--------------------	--------	----	-------	---	---	----------	-------

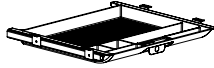

- plastic

Pencil Drawer	19 1/4	16 1/8	2 3/8	4	1	GP1619CD	\$136
---------------	--------	--------	-------	---	---	----------	-------



- plastic

Center Nook Drawer	8 1/4	15 1/4	2	2	1	GP1509CD	\$131
--------------------	-------	--------	---	---	---	----------	-------

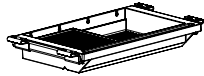

- plastic

### To Order, Specify:

- ① Model number

When ordering Quickship products, place a "Q" in front of model number.  
Example: QAK1

**NOW!**  
Need it.  
JSI Quickship.

Description	D	W	H	CTN WT	CU FT	① Model	List Price
Monitor Support Arm	12	6	17	9		AMA3B	\$562



- 360 degree swivel
- adjusts height, tilt and distance of monitor screen to user
- integrated cable management
- grommet and edge clamp mount included
- black finish
- monitor not included
- will fit monitors made to the VESA standard of 75 mm or 100 mm hole spacing in a square configuration

## Conference

### Flat Screen Mount - Universal Bracket (standard with TV, DTV and FSTV model)

Peerless® ST650 universal tilting flat screen mount is supplied with the FSTV Flat Screen Mounting Frame.

- For use with 32"-50" screens
- Maximum weight 175 lbs. (79kg)
- Tilt 15° forward and -5° backward angles
- Mounting pattern allows up to 6" of vertical adjustment

NOTE: To verify TV interface to universal bracket

1. Access website - [www.peerlessmounts.com](http://www.peerlessmounts.com)
2. Locate "Mount Finder™" on home page side navigation bar
3. Enter make and/or model of your flat screen
4. Verify model: ST650 is listed as available model

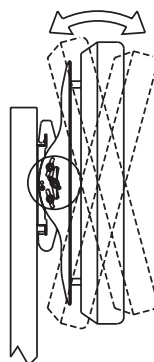

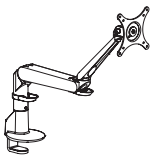
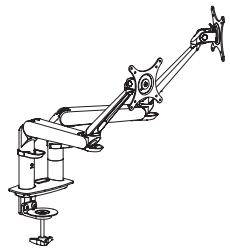
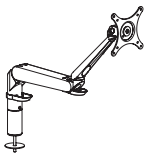
Description	D	W	H	CTN WT	CU FT	① Model	List Price
<b>Monitor Arm - Edge Mount</b>  <ul style="list-style-type: none"> <li>· mounts to edge of worksurface</li> <li>· silver or black</li> </ul>				9	1	<b>GP5901MA</b>	<b>\$599</b>
<b>Dual Monitor Arm - Edge Mount</b>  <ul style="list-style-type: none"> <li>· mounts to edge of worksurface</li> <li>· supports two monitors</li> <li>· silver or black</li> </ul>				18	2	<b>GP5902MA</b>	<b>\$1,078</b>
<b>Monitor Arm</b>  <ul style="list-style-type: none"> <li>· mounts through hole in worksurface</li> <li>· field drilled and field installed</li> <li>· supports up to 12 lbs and/or 27" monitor</li> <li>· silver or black</li> </ul>				9	1	<b>GP5905MA</b>	<b>\$667</b>

**To Order, Specify:**

① Model number

When ordering Quickship products, place a "Q" in front of model number.  
 Example: QAK1

