



Desks	FN20
Modesty Panels	FN20
Returns and Bridges	FN28
Credenzas	FN33
Overhead Cabinets.	FN36
Tackboards	FN40
Tool Rail Accessories.	FN46
Wall Mount Storage	FN47
Storage Towers.	FN56
Transaction Counters.	FN65
Bookcases.	FN66
Lateral Files	FN67
Vertical Storage Units	FN68
Freestanding Tables	FN72

Finale - Overview

Desks



Bow Front Double Pedestal Desk
Page [FN20](#)



Double Pedestal Desk
Page [FN20](#)



Electric Adjustable Height Table Desk
Page [FN22](#)



Pneumatic Adjustable Height Table Desk
Page [FN22](#)

Modesty Panels

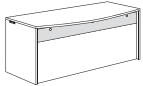

Glass Trim Modesty Panel
Page [FN20](#)

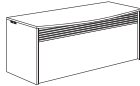

Metal Trim Modesty Panel
Page [FN20](#)

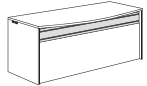

Metal/Glass Trim Modesty Panel
Page [FN21](#)

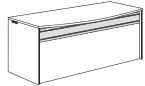

Metal/Veneer Trim Modesty Panel
Page [FN21](#)



Metal Trim Modesty Panel
Page [FN24](#)



Metal/Glass Trim Modesty Panel
Page [FN24](#)



Metal/Veneer Trim Modesty Panel
Page [FN24](#)

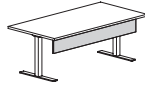

Adjustable Height Table Modesty Panel
Page [FN22](#)

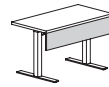

Adjustable Height Bridge Modesty Panel
Page [FN32](#)

Table Desks



Metal Frame Table Desk with Glass Top
Page [FN23](#)



Metal Frame Table Desk with Veneer Top
Page [FN23](#)



Metal Frame Table Desk for COM Top
Page [FN23](#)

Desk Applications



Bow Front Single Pedestal Desk
Page [FN25](#)



Single Pedestal Desk
Page [FN25](#)

Peninsula Desks

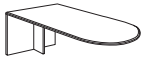

Bullet Peninsula Desk
Page [FN26](#)

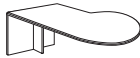

P-Top Peninsula Desk
Page [FN26](#)

Peninsula Desk Bases and Modesty Panels



Column Base
Page [FN27](#)

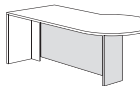

Full Modesty Panel
Page [FN27](#)

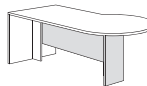

3/4 Modesty Panel
Page [FN27](#)

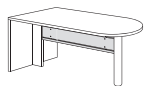

Metal/Glass Trim Modesty Panel
Page [FN27](#)

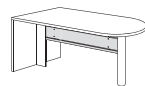

Metal/Veneer Trim Modesty Panel
Page [FN27](#)

Finale - Overview

Return Applications



File/File Return
Page [FN28](#)



Lateral File Return
Page [FN28](#)



Multi-File Return
Page [FN28](#)



File/File Corner
Return
Page [FN30](#)



Lateral File Corner
Return
Page [FN30](#)



Multi-File Corner
Return
Page [FN30](#)



Executive Corner
Unit
Page [FN29](#)

Bridge Applications

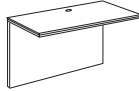

Bridge with Modesty Panel
Page [FN31](#)

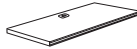

Bridge Top
Page [FN31](#)

Adjustable Height Bridge



Electric Adjustable
Height Bridge
Page [FN32](#)

Credenza and Lateral Files



Storage Credenza
Page [FN33](#)



Lateral File Credenza
Page [FN33](#)

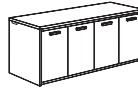

Four Door Credenza
Page [FN33](#)



Two Door Credenza
Page [FN33](#)

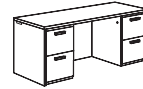

Kneespace Credenza
Page [FN34](#)



Buffet Credenza
Page [FN34](#)



Pedestal Credenza
Page [FN34](#)



File/File Reception
Credenza
Page [FN34](#)



Lateral Pedestal
Credenza
Page [FN35](#)



Multi-File Pedestal
Credenza
Page [FN35](#)

Printer Stand



Printer Stand
Page [FN35](#)

Corner Unit

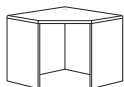

Corner Unit
Page [FN35](#)

Finale - Overview

Overhead Cabinets



Double Height Storage Overhead Cabinet with Four Doors
Page [FN36](#)



Double Height Storage Overhead Cabinet with Four Glass Doors
Page [FN36](#)



Double Height Storage Overhead Cabinet with Four Doors and Cubbies
Page [FN37](#)



Double Height Storage Overhead Cabinet with Four Glass Doors and Cubbies
Page [FN37](#)

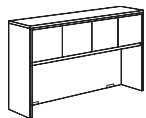

Storage Overhead Cabinet with Four Doors
Page [FN38](#)

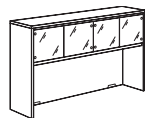

Storage Overhead Cabinet with Four Glass Doors
Page [FN38](#)



Storage Overhead Cabinet with Four Doors and Cubbies
Page [FN39](#)



Storage Overhead Cabinet with Four Glass Doors and Cubbies
Page [FN39](#)



Open Storage Overhead Cabinet
Page [FN38](#)



Open Storage Overhead Cabinet with Cubbies
Page [FN39](#)

Tackboards

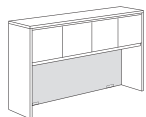

Tackboard for Storage Overhead Cabinet
Page [FN40](#)

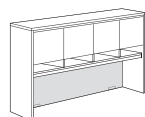

Tackboard for Storage Overhead Cabinet with Cubbies
Page [FN41-FN42](#)

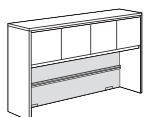

Accessory Rail Tackboards for Storage Overhead Cabinets
Page [FN43](#)

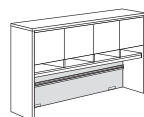

Accessory Rail Tackboards for Storage Overhead Cabinets with Cubbies
Page [FN44](#)

Accessories

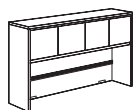

Accessory rail
Page [FN45](#)



Upright tray
Page [FN46](#)



Small tray
Page [FN46](#)



Pencil tray
Page [FN46](#)



Paper tray
Page [FN46](#)



File hanger
Page [FN46](#)



Acrylic Accessory Tray
Page [FN46](#)



Center drawer
Page [FN76](#)

Wall Mount Storage



Double Height Wall Mount Open Overhead Cabinet
Page [FN47](#)



Double Height Wall Mount Overhead Cabinet with Two Doors
Page [FN47](#)



Double Height Wall Mount Overhead Cabinet with Two Glass Doors
Page [FN47](#)

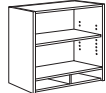

Double Height Wall Mount Open Overhead Cabinet with Cubbies
Page [FN48](#)



Double Height Wall Mount Overhead with Two Doors and Cubbies
Page [FN48](#)



Double Height Wall Mount Overhead with Two Glass Doors and Cubbies
Page [FN48](#)

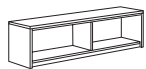

Wall Mount Open Overhead
Page [FN49](#)



Wall Mount Open Overhead
Page [FN49](#)

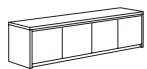

Wall Mount Overhead Cabinet with Four Doors
Page [FN49](#)



Wall Mount Overhead Cabinet with Two Doors
Page [FN49](#)

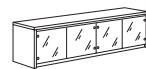

Wall Mount Overhead Cabinet with Four Glass Doors
Page [FN50](#)



Wall Mount Overhead Cabinet with Two Glass Doors
Page [FN50](#)

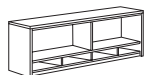

Wall Mount Open Overhead with Cubbies
Page [FN50](#)



Wall Mount Open Overhead with Cubbies
Page [FN50](#)

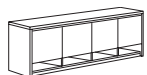

Wall Mount Overhead Cabinet with Four Doors and Cubbies
Page [FN51](#)



Wall Mount Overhead Cabinet with Two Doors and Cubbies
Page [FN51](#)

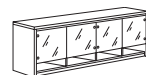

Wall Mount Overhead Cabinet with Four Glass Doors and Cubbies
Page [FN51](#)



Wall Mount Overhead Cabinet with Two Glass Doors and Cubbies
Page [FN51](#)

Finale - Overview

Tackboards

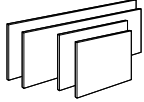

Wall Mount Tackboards
Pages [FN52-FN53](#)

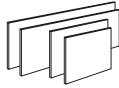

Wall Mount Tackboards for
Overhead Cabinets with Cubbies
Pages [FN54-FN55](#)

Storage Towers



Double Height Open
Storage Tower
Page [FN56](#)



Double Height Storage
Tower with 54" h Door
Page [FN56](#)



Double Height Storage
Tower with 54" h
Glass Door
Page [FN56](#)



Double Height Open
Storage Tower
Page [FN57](#)

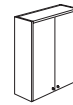

Double Height Storage
Tower with Two 54" h
Doors
Page [FN57](#)



Double Height Storage
Tower with Two 54" h
Glass Doors
Page [FN57](#)



Open Storage Tower
Page [FN58](#)



Storage Tower with
42" h Door
Page [FN58](#)



Storage Tower with
42" h Glass Door
Page [FN58](#)



Open Storage Tower
Page [FN59](#)



Storage Tower with Two
42" h Doors
Page [FN59](#)



Storage Tower with Two
42" h Glass Doors
Page [FN59](#)



Bookcase Overhead
Page [FN60](#)



Storage Tower
Page [FN60](#)



Glass Door Storage
Tower
Page [FN60](#)

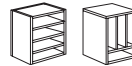

Storage Tower
Page [FN58](#)



Double Height Bridge
Mount Open Overhead
Cabinet
Page [FN61](#)



Double Height Bridge
Mount Overhead
Cabinet with Two Doors
Page [FN61](#)



Double Height Bridge
Mount Overhead Cabinet
with Two Glass Doors
Page [FN61](#)

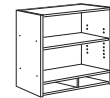

Double Height Bridge
Mount Open Overhead
Cabinet and Cubbies
Page [FN62](#)

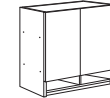

Double Height Bridge
Mount Overhead Cabinet
with Two Doors and Cubbies
Page [FN62](#)



Double Height Bridge Mount
Overhead Cabinet with Two
Glass Doors and Cubbies
Page [FN62](#)



Bridge Mount
Open Overhead
Page [FN63](#)



Bridge Mount Overhead
Cabinet with Two Doors
Page [FN63](#)



Bridge Mount Overhead
Cabinet with Two
Glass Doors
Page [FN63](#)



Bridge Mount Open
Overhead with Cubbies
Page [FN64](#)



Bridge Mount Overhead
Cabinet with Two Doors
and Cubbies
Page [FN64](#)



Bridge Mount Overhead
Cabinet with Two Glass
Doors and Cubbies
Page [FN64](#)



Modular Cabinet Top
Page [FN64](#)

Transaction Counters

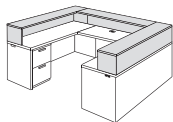

Transaction Counter
Page [FN65](#)

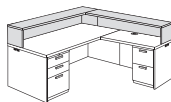

Transaction Counter
Page [FN65](#)

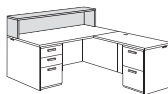

Transaction Counter
Page [FN65](#)

Finale - Overview

Bookcases

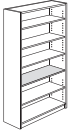

Bookcase
Page [FN66](#)



Bookcase
Page [FN66](#)

Lateral Files



Lateral File
Page [FN67](#)



Mobile Pedestal
Page [FN67](#)

Storage Cabinets

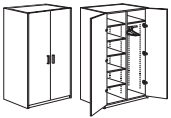

84" h Wardrobe
Page [FN68](#)



72" h Wardrobe
Page [FN68](#)



Hanging Bar to Shelves
Conversion Kit
Page [FN68](#)

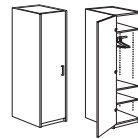

84" h Wardrobe
Page [FN69](#)



72" h Wardrobe
Page [FN69](#)

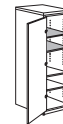

Hanging Bar to Shelves
Conversion Kit
Page [FN69](#)



84" h File/File Lateral
Storage Cabinet
Page [FN70](#)

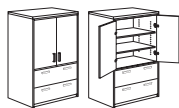

72" h File/File Lateral
Storage Cabinet
Page [FN70](#)

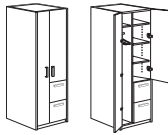

84" h File/File
Storage Wardrobe
Page [FN70](#)



72" h File/File
Storage Wardrobe
Page [FN70](#)



Modular Wardrobe Top
Page [FN71](#)

Finale - Overview

Magazine Table

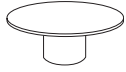

Round Magazine Table
Page [FN72](#)

Tables



Sofa Table
Page [FN73](#)



Magazine Table
Page [FN73](#)

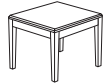

End Table
Page [FN73](#)



End Table
Page [FN73](#)



Metal Frame End Table with Glass Top
Page [FN74](#)



Metal Frame End Table with Veneer Top
Page [FN74](#)



Metal Frame End Table for COM Top
Page [FN74](#)



Metal Frame Magazine Table with Glass Top
Page [FN75](#)



Metal Frame Magazine Table with Veneer Top
Page [FN75](#)



Metal Frame Magazine Table for COM Top
Page [FN75](#)



Metal Frame Magazine Table with Glass Top
Page [FN76](#)



Metal Frame Magazine Table with Veneer Top
Page [FN76](#)



Metal Frame Magazine Table for COM Top
Page [FN76](#)



Corner Table
Page [FN73](#)

Task Lights



Task Light



LED Task Light



Motion Sensor for Task Lights

Finale Product Information

Exterior Wood Materials

Exterior surfaces are made from the finest selected veneers to achieve clarity and consistency in the Finale product line. To attain a pleasing, symmetrical pattern, all veneers in Finale are book-matched. All exterior solid lumber is matched to coordinate with the veneer.

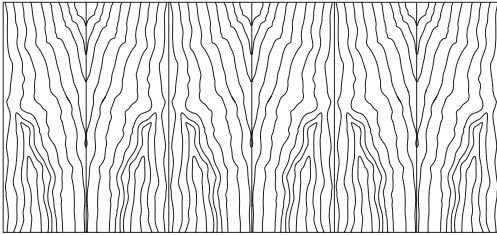

Book Matched Example

Alternating pieces of veneer are flipped over so they face each other like the pages within a book

Finale is available in flat cut cherry, maple and walnut veneer. A wide range of wood stains have been formulated to enhance the beauty of the veneer.

Work Surface Construction

Tops are 5-ply balanced construction, 1 3/16" thick with solid matching hardwood edges. Surfaces are available in wood veneer or high pressure laminate. No additional charge for using our coordinating high pressure laminate with a veneer grain pattern.

Case Construction

Outside panels are 1 3/16" and joined together by mortise and tenon construction. In addition to mortise and tenon joint construction, pedestal joints are reinforced with screws, cleats, brackets and glue. Leveling glides are set into solid hardwood blocks with t-nut inserts, which helps to prevent the leveling glide from tear out. Tops are secured to the chassis with top fastening cleats screwed to the inside of the panels.

Cabinet doors have 110° swing hinges to allow adequate access into the interior of the cabinet.

Drawers

The 9ply unidirectional hardwood sides of the drawer box are 7/16" thick assembled with English dovetail construction at each corner of the box. The drawer bottom panel is 1/4" thick fitting into a groove machined the into side of the box. Interiors are sanded and coated with clear U.V. finish to protect against shrinking, swelling or warping, and to provide a clean, smooth feel and appearance.

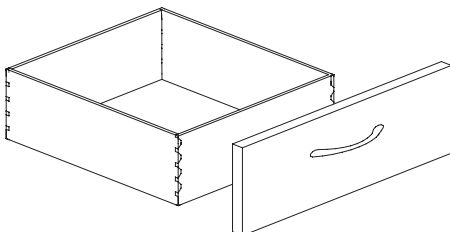

Drawer Suspension

The high quality black drawer suspensions carry a lifetime warranty. Slides feature steel ball bearings for longer life with cushioned in /out stops. File and box drawers have 100% full extension with over travel.

Filing Hardware

All file drawers are constructed with a custom designed filing system in place to allow for hanging folders. Filing diagram on pages [FN17-FN19](#).

Locking

All desks, credenzas and returns feature pedestal locking and lateral files feature central locking to provide maximum security and flexibility.

Units are shipped randomly keyed as standard (units in the grouping are keyed alike). Keyed alike units available if requested at no upcharge. Removable cores for in-field re-keying are standard.

Finish - Stain/Colors

We offer a variety of wood stains and paint colors on Finale. Please see the chart below. Samples are available upon request.

ESS Essentials Veneer Collection

BRK	Brickdust	OBK	Outback
CSK	Cask	PIL	Pilsner
CLY	Clay	SIE	Sienna
FLX	Flax	TRF	Truffle
MES	Mesa	UMB	Umber
MCH	Mocha		

Protective Top Coat

DuraTex™ offers exceptional hardness along with abrasion and impact resistance, it has been formulated to eliminate hazardous and harmful gases that are normally associated with wood finish.

DuraTex™ Features

Safety - Significantly reduces hazardous formaldehyde emissions which help improve the quality of the of the indoor air we breathe.

Quality - Developed to be tough and durable with special attention to appearance. The DuraTex™ finish preserves the natural beauty of wood.

Durability - Designed to meet a wide range of demanding performance and environmental standards to withstand even the highest wear and tear.

Finale Product Information

Product Modification

Laminate Tops

Worksurface only, no additional upcharge if coordinating wood grain laminate is specified. Contact Customer Service for any other laminate request. Listed below are finishes that have coordinating wood grain HPL laminates.

ESS Essentials Veneer with Laminate Top

BRK	Brickdust	MCH	Mocha
CSK	Cask	OBK	Outback
CLY	Clay	PIL	Pilsner
MES	Mesa	UMB	Umber

Special Finishes

Special finishes can be requested by following the instruction in the general introduction section. There is a one time charge of \$384 list per order.

Finish Sheen

All veneer finishes, for Finale, are standard in 35-sheen. All other finishes can have their sheen modified with a 15% upcharge added to the list price of each item.

Pedestal Configuration Change

Box-box-file configuration is standard on all desks and file-file configuration is standard on all return units.

Finale drawer configuration on pedestals 27" to 30" high can be switched out either to a box-box-file or file-file configuration, but must be specified at the time of order with an additional \$198 list per pedestal.

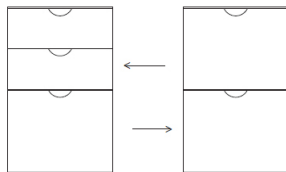

Writing Shelf - Pullout (Arm Slide)

Desk Pedestals in Finale can have an optional pullout shelf above the top drawer for additional writing surface. Add \$381 to the list for each pedestal.

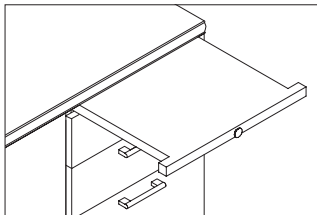

Special Sizes from Standard Offering

The following chart contains pricing for general modifications to Finale.

All modifications still must be approved by JSI manufacturing. please contact Customer Service to verify any of the modifications listed in the chart below. More complex modification to standard product may be possible, please refer to page 5 for additional details.

This chart does not apply to glass doors, glass tops or to metal components; such as modesty trims panels, and structural support. Any changes to file drawers will affect filing capabilities.

Increasing Dimensions - Add On to the list Per 6" Occurrence

Overhead

Increasing width	\$1,136
Increasing depth	\$1,936
Increasing width with doors	\$1,344
Increasing depth with doors	\$2,071

Any Pedestal

Increasing width	\$1,610
Increasing depth	\$1,436

Any Panel

Increasing width	\$368
------------------	-------

Any Top

Increasing width	\$478
Increasing depth	\$676

Decreasing Dimensions Add On to the list Per 6" Occurrence

Overhead

Decreasing width	\$253
Decreasing depth	\$253
Decreasing width with doors	\$346
Decreasing depth with doors	\$346

Any Pedestal

Decreasing width	\$1,094
Decreasing depth	\$977

Any Panel

Decreasing width	\$129
------------------	-------

Any Top

Decreasing width	\$190
Decreasing depth	\$190

Example 1

Increasing open corner credenza width by 11", from 72" to 83".

Add Top Width (\$478 x 2) [\$478 for each 6" increment]

Add Panel Width (\$368 x 2) [\$368 for each 6" increment]

Total Modification = \$1,692

Example 2

Increasing a desk pedestal depth from 36" to 40" & increase the width of the same pedestal by 8"

Add Pedestal Depth \$1,436

Add Pedestal Width (\$1,610 x 2) [\$1,610 for each 6" increment]

Total Modification = \$4,656

Example 3

Decreasing an overhead from 60" to 58" width & increasing the depth by 3"

Decrease Overhead Width \$253

Add Overhead Depth \$1,936

Total Modification = \$1,683

Finale Product Information

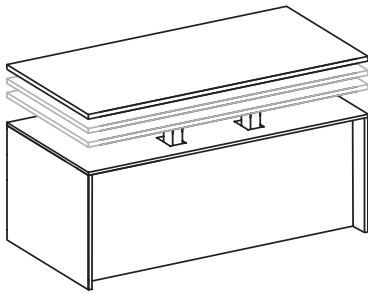

ERGO Adjustable Work Height Mechanism

Our proprietary adjustable work height mechanism can be specified on many of the models in Finale.

ERGO mechanism allows height adjustability to be added to the worksurface. Our solution uses a standardized design that minimizes the modifications required to standard desk, bridge or credenza models. The mechanism and control box are neatly concealed to maintain the appearance of the original elegance of the product. A push button activates the electric powered lifting columns for adjustability from sitting height to a standing height. A ¾" thick finished sub top is added to the top of the desk chassis for a clean appearance when the surface is in the raised position. In the lowered position, please note that ERGO adds ¾" to the standard height of the desk and the installation will decrease kneespace depth by 8".

Automatic Collision Control is built in to each mechanism as a standard feature. When the system senses an obstacle obstructing the movement, the mechanism will reverse direction and retreat by 1".

When ERGO is added to a worksurface in an "L" or "U" group, all units in the configuration need to have a sub top added. These units are considered to be ERGO ADJACENT units. ERGO ADJACENT units must have a fixed height worksurface that matches the lowest position of the ERGO mechanism and the top. This is accomplished by adding a ¾" sub top between the chassis and the worksurface. This feature can also be specified for cabinets which may sit next to a unit with the ERGO mechanism.

Height adjustment starts at 30 ¼", to a standing height of 49 ¾", a range of 19 ½".

Note: The kneespace depth is decreased when the ERGO mechanism is specified. Contact Customer Service for dimension information.

The Ergo mechanism and controls are warranted for a period of (1) year. The rest of the casegood unit(s) are warranted under the Lifetime Warranty.

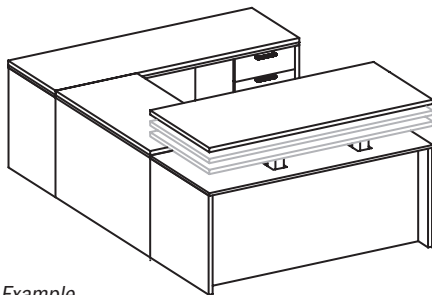

Example

FN3672LD (with ERGO option) add \$4,981 to list
 FN2448EB (with ERGO ADJACENT option) add \$625 to list
 FN2472RC (with ERGO ADJACENT option) add \$733 to list

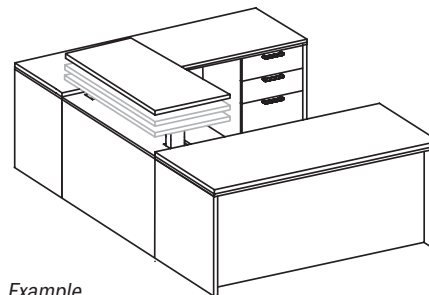

Example

FN3672LD (with ERGO ADJACENT option) add \$733 to list
 FN2448EB (with ERGO option) add \$4,981 to list
 FN2472RC (with ERGO ADJACENT option) add \$733 to list

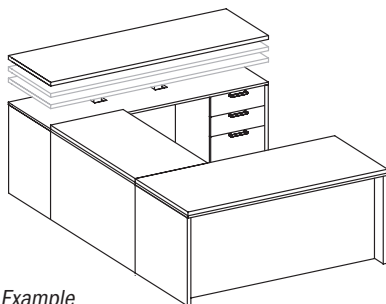

Example

FN3672LD (with ERGO ADJACENT option) add \$733 to list
 FN2448EB (with ERGO ADJACENT option) add \$625 to list
 FN2472RC (with ERGO option) add \$4,981 to list

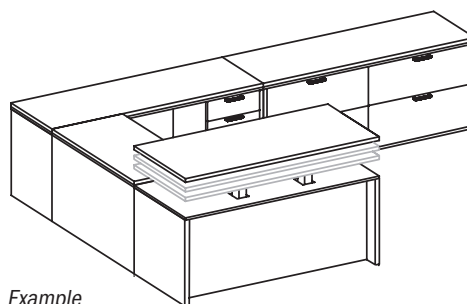

Example

FN3672LD (with ERGO option) add \$4,981 to list
 FN2448EB (with ERGO ADJACENT option) add \$625 to list
 FN2472RC (with ERGO ADJACENT option) add \$733 to list
 FN2472LFC (with ERGO ADJACENT option) add \$733 to list

Finale Product Information

Availability of Finale Units with the Mechanism

The following models are available with the ERGO Adjustable Work Height Mechanism.

Freestanding Units - Units below do not require adjacent products; select ERGO option and add \$4,981 to the list price.

<u>Double Pedestal Desk</u>	<u>Credenzas</u>
FN4272BD	FN2472KC
FN3672DD	FN2466KC
FN3072DD	
FN3066DD	
FN3060DD	

Adjacent Connecting Units - Select ERGO option for the model you wish to have height adjustment and add \$4,981 to the list price. For units, from this list, that are connecting to the ERGO model, you must select ERGO ADJACENT on each of these connecting models and add \$733 list to each model. *If the connecting model is 24"x 48" or less, add \$625 list.

<u>Single Pedestal Desk</u>	<u>Returns</u>	<u>Bridges</u>	<u>Credenzas</u>	<u>Corner Units</u>
FN4272RBD	FN2448ERR*	FN2448EB*	FN2472RC	FN4242ERCU
FN4272LBD	FN2448ELR*	FN2442EB*	FN2472LC	FN4242ELCU
FN3672RD	FN2442ERR*	FN2436EB*	FN2466RC	FN4242CU
FN3672LD	FN2442ELR*		FN2466LC	
FN3072RD	FN2448ERCR*			
FN3072LD	FN2448ELCR*			
FN3066RD	FN2442ERCR*			
FN3066LD	FN2442ELCR*			

Finale Product Information

Layouts

Two heights of storage overheads are available in Finale.

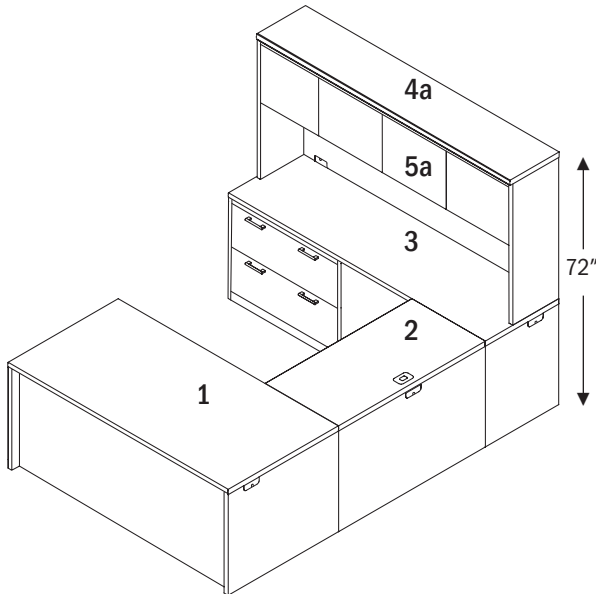

Finale is an easily specified contemporary product line, with standard office furniture sizes.

Easily specified and setup while providing well established layouts in the office environment.

- 1 Single Pedestal Desk**, with the standard box, box, file pedestal configuration and side locking. Standard side grommet keeps the desk top clean from wires, while still having convenient wire management.
- 2 Bridge** standard with top and back panel grommet and mounting hardware.
- 3 Lateral File Credenza** available with fixed back panel.
- 4a Cabinet Top** is a standard feature on 42" high overhead cabinets.
- 4b Modular Cabinet Top** (not shown in diagram) is an option on 54" high overhead cabinet. These tops are ordered separately.
- 5a Overhead Cabinet** height is 42" for an overall height 72" Standard with left and right grommets on the back panel. Models are available with frameless glass doors in white back painted. (Locks and pulls are not available with glass doors). Models with installed cubbies are also available.
- 5b Overhead Cabinet** height is 54" for an overall height 84" (add 1 3/16" if specifying modular cabinet tops). Standard with left and right grommets on the back panel. Shown with frameless white back painted glass doors. (Locks and pulls are not available with glass doors) Models are also available in wood doors.

Note: Tackboard or panels can be ordered for the inside back of the overhead cabinet, along with the accessory rails.

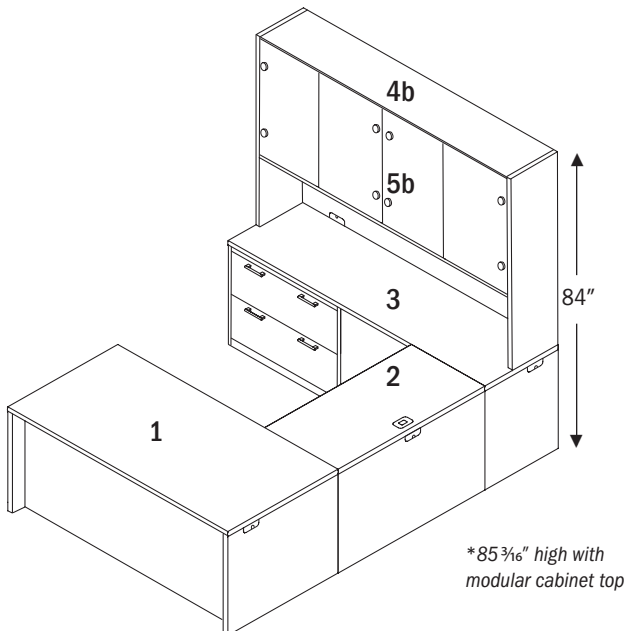

Modular Cabinet Tops
Overhead Cabinets 54" tall do not come with modular cabinet tops. Tops can be specified and ordered separately. To maintain the same finish height on all units, specify tops for **ALL** adjacent units.

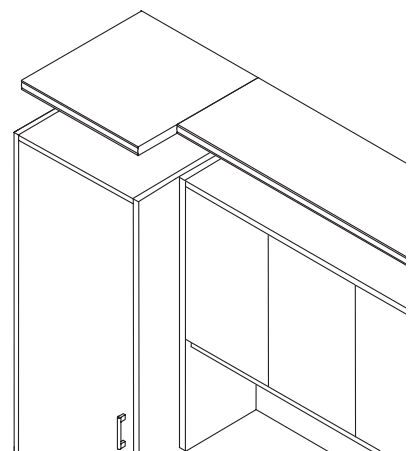

Frameless opaque glass doors in white back painted brings a nice aesthetic to the Finale product line.

Finale Product Information

Pull Style and Color Options



Arch
Matte Black (MBK)
Matte Silver (MSL)

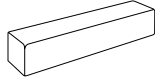

Block
Matte Nickel (MNK)



Curve
Matte Nickel (MNK)



Twist
Matte Nickel (MNK)

Top Edge Details

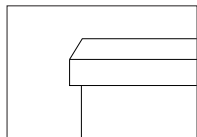

Bevel (B)

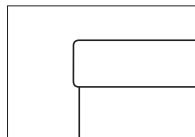

Eased (R4)

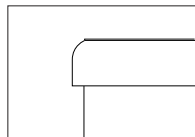

Gael (G)

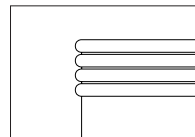

Reeded (H)

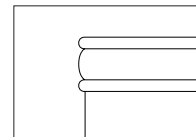

Transitional (C)

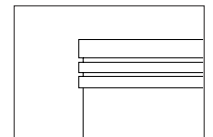

Triad (F)

Top Edge Detail Location

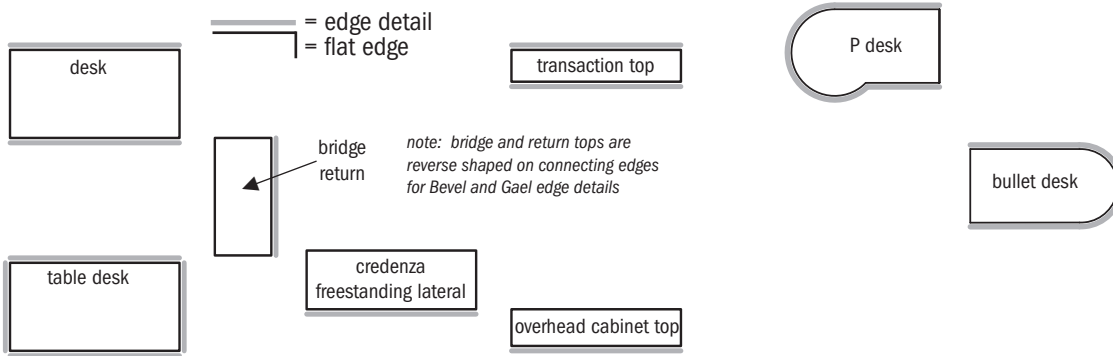

Standard Grain Direction

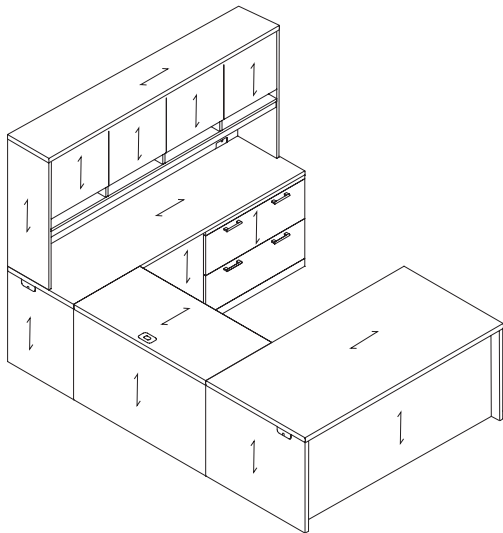

Note:

Grain direction on Return and Bridge units run short grain.

Grain on valance rails on overhead cabinet run vertical.

Finale Product Information

Grommet and Color Options

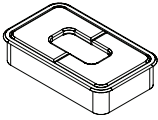

Worksurface Grommet

Matte Black (MBK)
Stardust Silver (STS)

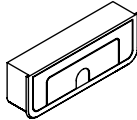

End Panel Grommet

Matte Black (MBK)
Stardust Silver (STS)

Worksurface Grommet Locations

Additional worksurface grommets can be specified on desk, bridges, returns and credenzas. Grommet locations are indicated below with an (A) for left, (B) for center, (C) for right and (D) for center end.

Add \$118 to the list for each additional grommet.

Grommet color must be specified, select Matte Black or Stardust Silver choose one color for all grommets. If no color is selected, grommet color will coordinate with the pull color. Lock cores will coordinate with grommet color

Matte Black (MBK)
Stardust Silver (STS)

36" d Pedestal Desk

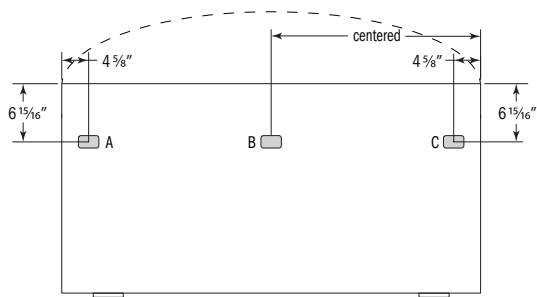

Support End and Run-Off Desk

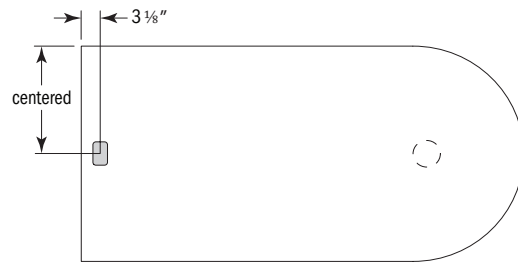

30" d Pedestal Desk

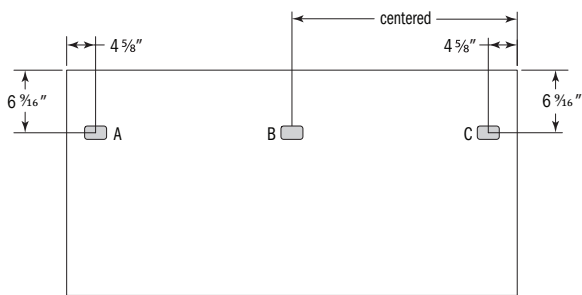

Bridges, Returns and Credenzas

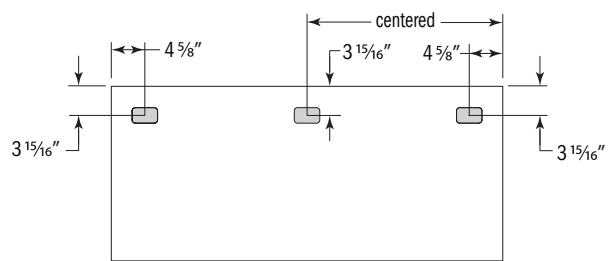

End/Back Panel Grommet

Finale features grommets and wire pass thru on all of the cabinets. This allows wiring to move from unit to unit or from unit to the data or power source. The end/back panel grommets are standard, for any special consideration contact Customer Service.

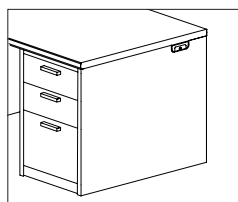

Desks - Credenza
End Panel Grommet

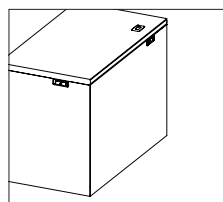

Returns
Work Surface Grommet
End Panel Grommet
Back Panel Grommet

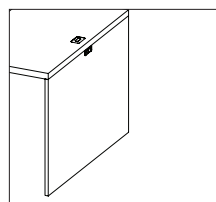

Bridge
Work Surface Grommet
Back Panel Grommet

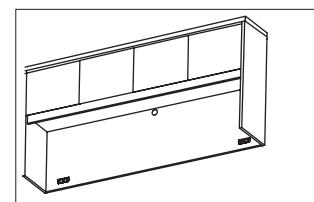

Overhead Cabinet
Back Panel Grommet
Back Center Pass Thru

Note: See the accessory section in this price list for additional wiring and power/data options.

Finale Product Information

Product Trim Features and Options

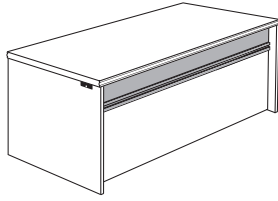

Trim Modesty Panel

- Decorative metal in 3 finishes
 - Black Sandtex (BSX)
 - Soft Nickel (SNK)
 - Stardust Silver (STS)
- Top panel in
 - Veneer
 - White Back Painted Glass (not low iron)
- Available on
 - Recess Modesty Desks
 - Table Desks
 - Bullet Desk
 - P Style Desk

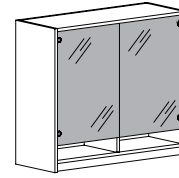

Glass Doors

- Frameless Tempered Glass
 - Puck Style Hinges
 - Aluminum Color
- Back Painted Glass
 - White (not low iron)
- Available on
 - Overhead Cabinets
 - Storage Towers

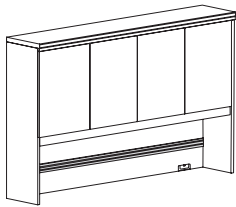

Aluminum Accessory Rail

- Anodized Aluminum Finish
- Accessory Tools (see page [FN46](#))
 - Upright Tray
 - Small Tray
 - Pencil Tray
 - Paper Tray
 - File Hanger

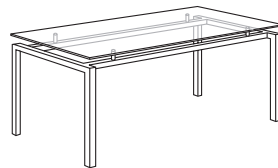
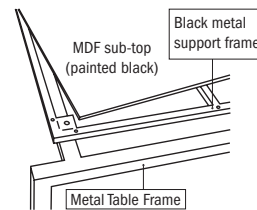

Table Desk

- Top Surface
 - Clear Glass
 - White Back Painted Glass (not low iron)
 - Veneer
 - COM (*right diagram*)
- Frame Finishes
 - Black Sandtex (BSX)
 - Soft Nickel (SNK)
 - Stardust Silver (STS)



Customer Supplies Top (COM)

- Table Frame with Support
- Allows for Unique Materials
- Frame Finishes
 - Black Sandtex (BSX)
 - Soft Nickel (SNK)
 - Stardust Silver (STS)

Finale Product Information

Finish and Reference Codes - Summary

Select	Code
Essentials Veneer Collection	
Brickdust	BRK
Cask	CSK
Clay	CLY
Flax	FLX
Mesa	MES
Mocha	MCH
Outback	OBK
Pilsner	PIL
Sienna	SIE
Truffle	TRF
Umber	UMB

Select	Code
Essentials Veneer with Laminate Top	
Brickdust	BRK
Cask	CSK
Clay	CLY
Mesa	MES
Mocha	MCH
Outback	OBK
Pilsner	PIL
Umber	UMB

Select	Code
Edge Profile	
Bevel	B
Eased	R4
Gael	G
Reeded	H
Transitional	C
Triad	F

Select	Code
Pull Style and Color	
Arc - Matte Black	MBK
Arc - Matte Silver	MSL
Block - Matte Nickel	MNK
Curve - Matte Nickel	MNK
Twist - Matte Nickel	MNK

Select	Code
Grommet Color	
Matte Black	MBK
Stardust Silver	STS

Select	Code
Metal Color	
Black Sandtex	BSX
Soft Nickel	SNK
Stardust Silver	STS

Select	Code
Glass Color	
Clear Glass	
White Back Painted	

Finale Product Information

Desk Model	Description	Drawer Configuration (User Side)	
		Left Pedestal	Right Pedestal
FN4272BD	Double Pedestal Bow Desk	Box/Box/File	File/File
FN3672DD	Double Pedestal Desk	Box/Box/File	File/File
FN3072DD	Double Pedestal Desk	Box/Box/File	File/File
FN3066DD	Double Pedestal Desk	Box/Box/File	File/File
FN3060DD	Double Pedestal Desk	Box/Box/File	File/File
FN4272RBD	Right Pedestal Bow Desk		Box/Box/File
FN4272LBD	Left Pedestal Bow Desk	Box/Box/File	
FN3672RD	Right Pedestal Desk		Box/Box/File
FN3672LD	Left Pedestal Desk	Box/Box/File	
FN3072RD	Right Pedestal Desk		Box/Box/File
FN3072LD	Left Pedestal Desk	Box/Box/File	
FN3066RD	Right Pedestal Desk		Box/Box/File
FN3066LD	Left Pedestal Desk	Box/Box/File	

Interior Drawer Dimensions	Depth	Width	Height
Box	21"	11 7/8"	4 1/4"
File	21"	11 7/8"	9 3/8"

Filing Options



Letter



Letter



Legal

Mobile Pedestals Model	Description	Drawer Configuration
		Single Pedestal Width
FN1820MP	Mobile Pedestal	Box/Box/File

Interior Drawer Dimensions	Depth	Width	Height
Box	21"	14 7/8"	4 1/4"
File	15 1/4"	14 7/8"	9 3/8"

Filing Options



Legal

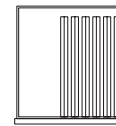

Legal

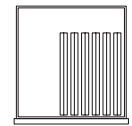

Letter

Executive Returns Model	Description	Drawer Configuration (User Side)	
		Left Pedestal	Right Pedestal
FN2448ERR	Right Executive Return		File/File
FN2448ELR	Left Executive Return	File/File	
FN2442ERR	Right Executive Return		File/File
FN2442ELR	Left Executive Return	File/File	
FN2448ERCR	Right Executive Return		File/File
FN2448ELCR	Left Executive Return	File/File	
FN2442ERCR	Right Executive Return		File/File
FN2442ELCR	Left Executive Return	File/File	

Interior Drawer Dimensions	Depth	Width	Height
File	15 1/4"	11 7/8"	9 3/8"

Filing Options



Letter

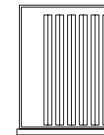

Legal

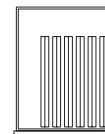

Letter

Finale Product Information

Executive Returns with Lateral File		Drawer Configuration (User Side)	
Model	Description	Left Pedestal	Right Pedestal
FN2448LRR	Right Lateral Return		2 Lateral Drawers
FN2448LLR	Left Lateral Return	2 Lateral Drawers	
FN2448MRR	Right Multi-File Return		2 Box /File Lateral Drawers
FN2448MLR	Left Multi-File Return	2 Box /File Lateral Drawers	
FN2448LRCR	Right Lateral Return		2 Lateral Drawers
FN2448LLCR	Left Lateral Return	2 Lateral Drawers	
FN2448MRCR	Right Multi-File Return		2 Box /File Lateral Drawers
FN2448MLCR	Left Multi-File Return	2 Box /File Lateral Drawers	

Interior Drawer Dimensions	Depth	Width	Height
Box	15 1/4"	13 7/8"	4 1/4"
File	15 1/4"	14 7/8"	9 3/8"
Lateral File	15 1/4"	31 3/8"	9 3/8"

Filing Options

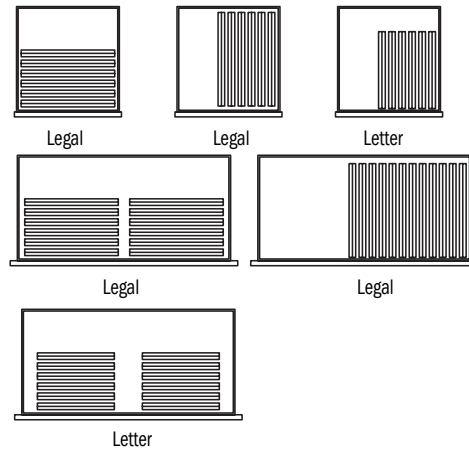

Credenza		Drawer Configuration (User Side)	
Model	Description	Left Pedestal	Right Pedestal
FN2472SC	Storage Credenza ¹	File/File	File/File
FN2466SC	Storage Credenza ¹	File/File	File/File
FN2472KC	Kneespace Credenza	File/File	File/File
FN2466KC	Kneespace Credenza	File/File	File/File
FN2472RC	Right Pedestal Credenza		File/File
FN2472LC	Left Pedestal Credenza	File/File	
FN2466RC	Right Pedestal Credenza		File/File
FN2466LC	Left Pedestal Credenza	File/File	
FN2472RCR	Right Pedestal Credenza		File/File
FN2472LCR	Left Pedestal Credenza	File/File	

Interior Drawer Dimensions	Depth	Width	Height
File	15 1/4"	14 7/8"	9 3/8"

Filing Options

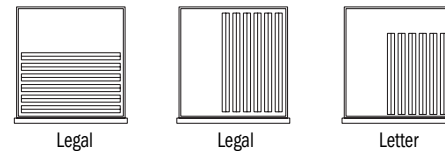

¹Center Section - Hinge Door Storage

Credenza - Lateral		Drawer Configuration (User Side)	
Model	Description	Left Pedestal	Right Pedestal
FN2472LFC	Lateral File Credenza	2 Lateral Drawers	2 Lateral Drawers
FN2472LRC	Right Lateral File	2 Lateral Drawers	
FN2472LLC	Left Lateral File		2 Lateral Drawers
FN2472MRC	Right Multi-File Credenza		2 Box /File/Lateral
FN2472MLC	Right Multi-File Credenza		2 Box /File/Lateral

Interior Drawer Dimensions	Depth	Width	Height
Box	15 1/4"	13 7/8"	4 1/4"
File	15 1/4"	14 7/8"	9 3/8"
Lateral File	15 1/4"	31 3/8"	9 3/8"

Filing Options

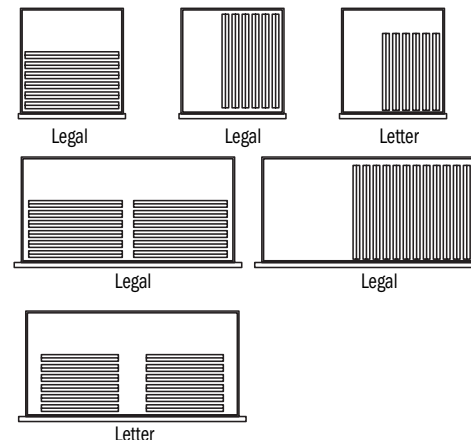

Finale Product Information

Buffet Credenza

Model	Description	Drawer Configuration
FN2472BSC	Buffet Credenza ²	Along the Top ² 4 Box Drawers

²Bottom Section - Hinge Door Storage

Interior Drawer Dimensions	Depth	Width	Height
Box	15 1/4"	14 3/16"	4 1/4"

Lateral File Cabinet

Model	Description	Drawer Configuration
FN3654LF	4 Drawer Lateral File Cabinet	Single Lateral Pedestal Width 4 Lateral Drawers
FN3642LF	3 Drawer Lateral File Cabinet	3 Lateral Drawers
FN3630LF	2 Drawer Lateral File Cabinet	2 Lateral Drawers

Interior Drawer Dimensions	Depth	Width	Height
Lateral File	15 1/4"	31 3/8"	9 3/8"

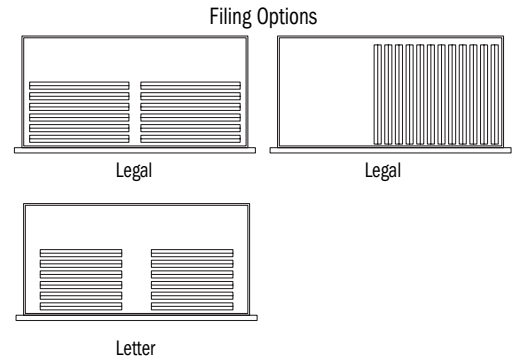

Tall Storage Cabinets

Model	Description	Drawer Configuration
FN3672SWLF	Storage Cabinet	Single Lateral Pedestal Width 2 Lower Lateral Drawers
FN2472SWR	Storage Cabinet	2 File Drawers on Lower Right
FN2472SWL	Storage Cabinet	2 File Drawers on Lower Left

Interior Drawer Dimensions	Depth	Width	Height
File	15 1/4"	11 7/8"	9 3/8"
Lateral File	15 1/4"	31 3/8"	9 3/8"

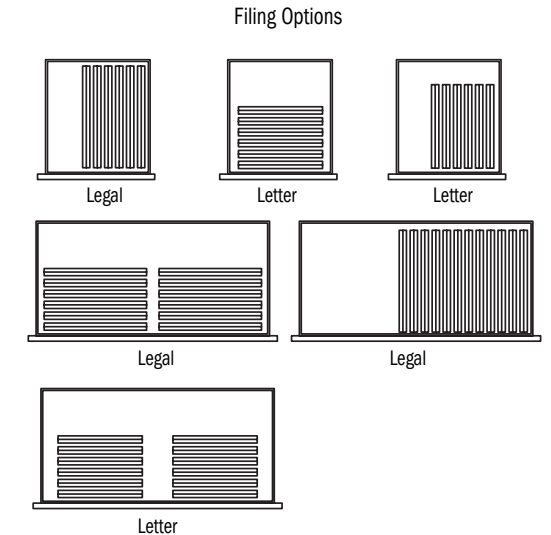

Additional Drawer Sizes

Center Drawer - FN1825CD
Interior Sizes - 15 1/4" d x 21 15/16" w x 2" h

Description	D	W	H	CTN WT	CU FT	① Model	List Price
Bow Front Double Pedestal Desk	42	71 ¾	30	480	61	FN4272BD	\$6,015



- box/box/file left pedestal; file/file right pedestal
- letter width pedestals
- optional center drawer, model FN1825CD. See page [FN76](#).
- pedestal locking
- top edge profile on user and approach sides
- two end panel grommets standard
- 6" overhang on approach side
- chassis - 36" x 71 ¾"
- kneespace - 38 ½"

Double Pedestal Desk	36	71 ¾	30	340	53	FN3672DD	\$5,099
	30	71 ¾	30	368	44	FN3072DD	\$5,019
	30	65 ¾	30	320	41	FN3066DD	\$4,945
	30	59 ¾	30	300	37	FN3060DD	\$4,866



- box/box/file left pedestal; file/file right pedestal
- letter width pedestals
- optional center drawer, model FN1825CD. See page [FN76](#).
- pedestal locking
- top edge profile on user and approach sides
- two end panel grommets standard
- FN3672DD and FN3072DD kneespace - 38 ½"
- FN3066DD kneespace - 32 ½"
- FN3060DD kneespace - 26 ½"

Glass Trim Modesty Panel	¾	68 ½	6 ½	13	2	FN0772AMP coordinates with: FN4272BD FN3672DD FN3072DD FN4272RBD FN3672RD FN3072RD FN4272LBD FN3672LD FN3072LD	\$767
	¾	62 ½	6 ½	12	2	FN0766AMP coordinates with: FN3066DD FN3066RD FN3066LD	\$753
	¾	56 ½	6 ½	11	2	FN0760AMP coordinates with: FN3060DD	\$744

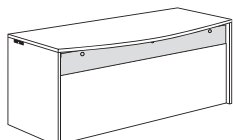

- white back painted glass panel
- field installed

Metal Trim Modesty Panel	2	68 ½	7	18	2	FN0772GRMP coordinates with: FN4272BD FN3672DD FN3072DD FN4272RBD FN3672RD FN3072RD FN4272LBD FN3672LD FN3072LD	\$1,490
	2	62 ½	7	17	2	FN0766GRMP coordinates with: FN3066DD FN3066RD FN3066LD	\$1,473
	2	56 ½	7	16	2	FN0760GRMP coordinates with: FN3060DD	\$1,452

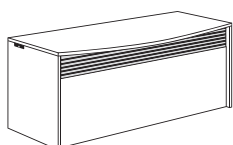

- five metal tubes - specify metal color option: Black Sandtex, Soft Nickel or Stardust Silver
- field installed

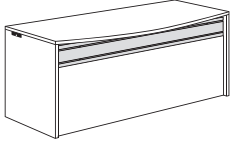
Description	D	W	H	CTN WT	CU FT	① Model	List Price
Metal/Glass Trim Modesty Panel 	2	68 ½	7	15	2	FN0772GAMP coordinates with: FN4272BD FN3672DD FN3072DD FN4272RBD FN3672RD FN3072RD FN4272LBD FN3672LD FN3072LD	\$1,799
	2	62 ½	7	14	2	FN0766GAMP coordinates with: FN3066DD FN3066RD FN3066LD	\$1,782
	2	56 ½	7	13	2	FN0760GAMP coordinates with: FN3060DD	\$1,774

- two metal tubes - specify metal color option: Black Sandtex, Soft Nickel or Stardust Silver
- white back painted glass panel insert
- field installed

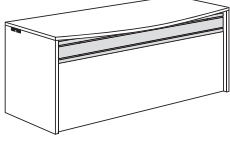
Metal/Veneer Trim Modesty Panel 	2	68 ½	7	13	2	FN0772GVMP coordinates with: FN4272BD FN3672DD FN3072DD FN4272RBD FN3672RD FN3072RD FN4272LBD FN3672LD FN3072LD	\$1,697
	2	62 ½	7	12	2	FN0766GVMP coordinates with: FN3066DD FN3066RD FN3066LD	\$1,677
	2	56 ½	7	11	2	FN0760GVMP coordinates with: FN3060DD	\$1,664

- two metal tubes - specify metal color option: Black Sandtex, Soft Nickel or Stardust Silver
- veneer panel insert - specify finish option: see page [FN16](#)
- field installed

To Order, Specify:

- ① Model Number
- ② Finish Color - (see page [FN16](#))
- ③ Edge Profile - (see page [FN16](#))
- ④ Pull Style and Color - (see page [FN16](#))
- ⑤ Grommet Color - (see page [FN16](#))
- ⑥ Metal Color - (see page [FN16](#))
- ⑦ Other Product Options (see page [FN9](#))
- ⑧ Accessories, Power and Data Options (see [accessories price list](#))

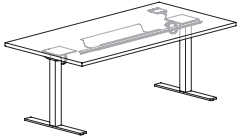
Description	D	W	H	CTN WT	CU FT	① Model	List Price
Electric Adjustable Height Table Desk 	36	72	Adj.	194	18	FN3672AHTD-EL	\$3,465
	30	72	Adj.	175	16	FN3072AHTD-EL	\$3,332
	30	66	Adj.	168	15	FN3066AHTD-EL	\$3,293
	30	60	Adj.	160	14	FN3060AHTD-EL	\$3,254
	24	72	Adj.	151	12	FN2472AHTD-EL	\$3,200
	24	66	Adj.	146	11	FN2466AHTD-EL	\$3,166
	24	60	Adj.	140	10	FN2460AHTD-EL	\$3,136

- 22 1/2" - 49" height adjustment
- top edge profile on user and approach sides
- push button control pad mounted right or left
- maximum weight rating 140 lbs. (evenly distributed load)
- key pad features height display with three memory settings
- display will reference position to the nearest 1/2"
- 120" power cord
- specify Matte Black (MBK) or Arctic Silver (STS) base finish
- ships KD

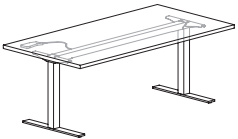
Pneumatic Adjustable Height Table Desk 	36	72	Adj.	194	18	FN3672AHTD-PN	\$6,069
	30	72	Adj.	175	16	FN3072AHTD-PN	\$5,807
	30	66	Adj.	168	15	FN3066AHTD-PN	\$5,636
	30	60	Adj.	160	14	FN3060AHTD-PN	\$5,458
	24	72	Adj.	151	12	FN2472AHTD-PN	\$5,437
	24	66	Adj.	146	11	FN2466AHTD-PN	\$5,343
	24	60	Adj.	140	10	FN2460AHTD-PN	\$5,227

- 27 1/2" - 44 1/2" height adjustment
- top edge profile on user and approach sides
- release lever mounts under edge of top
- 20 lb lift force/max weight rating 140 lbs. (evenly distributed load)
- specify Matte Black or Alloy base finish
- ships KD

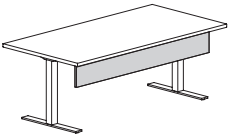
Modesty Panels for Adjustable Height Tables 	3/4	64	9	18	3	FN0964TDM	\$893
	3/4	58	9	16	2	FN0958TDM	\$864
	3/4	52	9	14	2	FN0952TDM	\$834

- FN0964TDM use with 72" wide adjustable height desk
- FN0958TDM use with 66" wide adjustable height desk
- FN0952TDM use with 60" wide adjustable height desk
- flat edge detail
- modesty panel bracket is available in Black Sandtex (BSX) or Stardust Silver (STS)

Description	D	W	H	CTN WT	CU FT	① Model	List Price
Metal Frame Table Desk with Glass Top	36	72	30	195	53	FN3672TDG	\$6,499

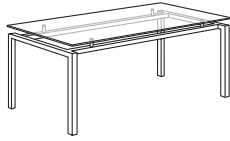

- metal 2" square tube frame - specify metal color option: Black Sandtex, Soft Nickel or Stardust Silver
- clear glass or white back painted glass top
- floor to frame knee height clearance 25 1/2"
- glass top crated for shipment
- 1/2 tempered glass top

Metal Frame Table Desk with Veneer Top	36	72	30	195	53	FN3672TDV	\$6,475
-----------------------------------------------	----	----	----	-----	----	------------------	----------------

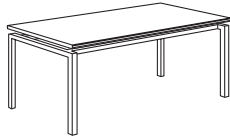

- metal 2" square tube frame - specify metal color option: Black Sandtex, Soft Nickel or Stardust Silver
- black support for veneer top included
- floor to frame knee height clearance 25 1/2"
- finish and edge profile must be specified
- field assembly of veneer top to metal base frame

Metal Frame Table Desk for COM Top	36	72	30	195	53	FN3672TDX	\$6,429
-------------------------------------------	----	----	----	-----	----	------------------	----------------

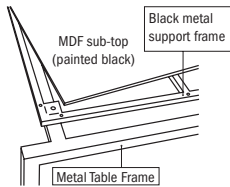
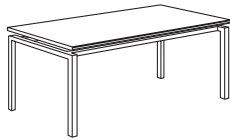

- includes: table desk frame, black metal support and black MDF sub top
- CUSTOMER MUST SUPPLY WORK SURFACE AND INSTALLATION AT FINAL DESTINATION
- metal 2" square tube frame - specify metal color option: Black Sandtex, Soft Nickel or Stardust Silver
- black support for COM top
- floor to frame knee height clearance 25 1/2"
- field assembly of COM top support to metal base frame

To Order, Specify:

- ① Model Number
- ② Finish Color - (see page [FN16](#))
- ③ Glass Surface - (see page [FN16](#))
- ④ Metal Color - (see page [FN16](#))
- ⑤ Edge Profile - (see page [FN16](#))
- ⑥ Other Product Options (see page [FN9](#))

Description	D	W	H	CTN WT	CU FT	① Model	List Price
-------------	---	---	---	-----------	----------	---------	------------

Metal Trim Modesty Panel	2	64 ½	7	18	2	FNTD72GRMP	\$1,550
---------------------------------	---	------	---	----	---	-------------------	----------------

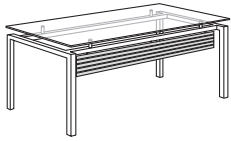

- two metal tubes - specify metal color option: Black Sandtex (BSX), Soft Nickel (SNK) or Stardust Silver (STS)
- field installed
- for use with FN3672TDG, FN3672TDV and FN3672TDX

Metal/Glass Trim Modesty Panel	2	64 ½	7	15	2	FNTD72GAMP	\$1,894
---------------------------------------	---	------	---	----	---	-------------------	----------------

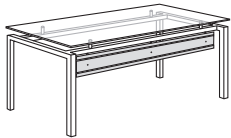

- two metal tubes - specify metal color option: Black Sandtex (BSX), Soft Nickel (SNK) or Stardust Silver (STS)
- white back painted glass panel insert
- field installed
- for use with FN3672TDG, FN3672TDV and FN3672TDX

Metal/Veneer Trim Modesty Panel	2	64 ½	7	13	2	FNTD72GVMP	\$1,726
----------------------------------------	---	------	---	----	---	-------------------	----------------

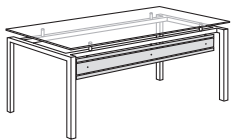

- two metal tubes - specify metal color option: Black Sandtex (BSX), Soft Nickel (SNK) or Stardust Silver (STS)
- veneer panel insert - specify finish option
- field installed
- for use with FN3672TDG, FN3672TDV and FN3672TDX

Desk Applications

Executive U

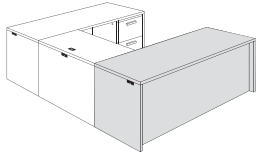

Computer U

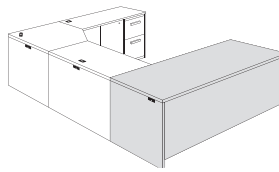

Description	D	W	H	CTN WT	CU FT	① Model	List Price
Bow Front Single Pedestal Desk	42	71 ¾	30	400	61	FN4272RBD	\$5,619
	42	71 ¾	30	400	61	FN4272LBD	\$5,619



left shown

- box/box/file pedestal - letter width
- optional center drawer, see page [FN76](#)
- 6" overhang on approach side
- chassis - 36" x 71 ¾"
- pedestal locking
- top edge profile on user and approach side
- two end panel grommets with wire pass thru

Single Pedestal Desk	36	71 ¾	30	290	53	FN3672RD	\$4,499
	36	71 ¾	30	290	53	FN3672LD	\$4,499
	30	71 ¾	30	290	44	FN3072RD	\$4,380
	30	71 ¾	30	290	44	FN3072LD	\$4,380
	30	65 ⅞	30	275	41	FN3066RD	\$4,261
	30	65 ⅞	30	275	41	FN3066LD	\$4,261



left shown

- box/box/file pedestal - letter width
- optional center drawer, see page [FN76](#)
- pedestal locking
- top edge profile on user and approach side
- two end panel grommets with wire pass thru

To Order, Specify:

- ① Model Number
- ② Finish Color - (see page [FN16](#))
- ③ Edge Profile - (see page [FN16](#))
- ④ Pull Style & Color - (see page [FN16](#))
- ⑤ Grommet Color - (see page [FN16](#))
- ⑥ Glass Color - (see page [FN16](#))
- ⑦ Metal Color - (see page [FN16](#))
- ⑧ Other Product Options (see page [FN9](#))
- ⑨ Accessories, Power and Data Options (see [accessories price list](#))

Peninsula Desk Applications

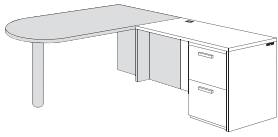

Description	D	W	H	CTN WT	CU FT	① Model	List Price
Bullet Peninsula Desk	36	72	30	135	53	FN3672B	\$3,700
	30	72	30	122	44	FN3072B	\$3,639

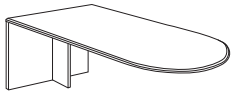

- edge profile on three open sides
- one end panel grommet
- trim modesty panel available, see page [FN27](#)
- non-handed
- optional center drawer available, See page [FN76](#)
- not for freestanding use
- bases must be purchased separately; see page [FN27](#) for options

P-Top Peninsula Desk	42	72	30	155	61	FN4272RP	\$4,408
	42	72	30	155	61	FN4272LP	\$4,408

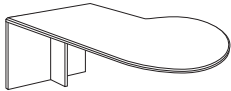

right shown

- 42" at widest point
- 36" at end panel
- edge profile on three open sides
- one end panel grommet
- trim modesty panel available, see page [FN27](#)
- optional center drawer available, See page [FN76](#)
- not for freestanding use
- bases must be purchased separately; see page [FN27](#) for options

Bases Options and Modesty Panels for Peninsula Tops
 (these bases must be ordered separately from the desks listed on previous page)

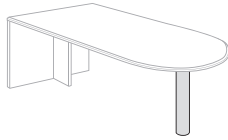

- Column Base**
- 04BB - Black Sandtex (BSX) \$462
 - 04NB - Soft Nickel (SNK) \$462
 - 04SB - Stardust Silver (STS) \$462

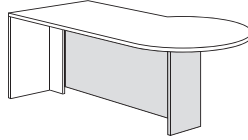

- Full Modesty Panel**
- FN2854RMP - right \$1,265
 - FN2854LMP - left \$1,265

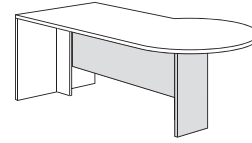

- 3/4 Modesty Panel**
- FN2154RMP - right \$1,265
 - FN2154LMP - left \$1,265

- Base:**
- 13 gauge steel
 - 4" diameter

Description	D	W	H	CTN WT	CU FT	① Model	List Price
Trim Modesty Panel	2	42	10	10	2	FN1042GAMP	\$1,113

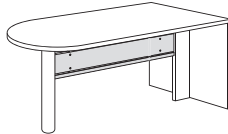

- two metal tubes - specify metal color option: Black Sandtex (BSX), Soft Nickel (SNK) or Stardust Silver (STS)
- white back painted glass panel insert
- field installed
- modesty panel requires special location if an optional center drawer is used

Trim Modesty Panel	2	42	10	12	2	FN1042GVMP	\$1,052
--------------------	---	----	----	----	---	------------	---------

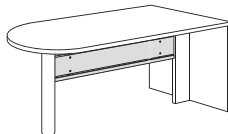

- two metal tubes - specify metal color option: Black Sandtex (BSX), Soft Nickel (SNK) or Stardust Silver (STS)
- veneer panel insert - specify finish option
- field installed
- modesty panel requires special location if an optional center drawer is used

To Order, Specify:

- ① Model Number
- ② Finish Color - (see page [FN16](#))
- ③ Edge Profile - (see page [FN16](#))
- ④ Pull Style and Color - (see page [FN16](#))
- ⑤ Grommet Color - (see page [FN16](#))
- ⑥ Metal Color - (see page [FN16](#))
- ⑦ Other Product Options (see page [FN9](#))
- ⑧ Accessories, Power and Data Options (see [accessories price list](#))

Return Applications - Executive L

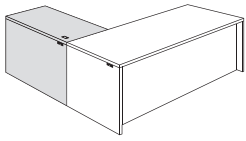

Description	D	W	H	CTN WT	CU FT	① Model	List Price
File/File Return	23 7/8	47 7/8	30	150	25	FN2448ERR	\$3,431
	23 7/8	47 7/8	30	150	25	FN2448ELR	\$3,431
File/File Return	23 7/8	41 7/8	30	140	22	FN2442ERR	\$3,095
	23 7/8	41 7/8	30	140	22	FN2442ELR	\$3,095

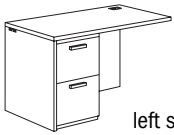

left shown

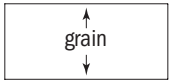

- top edge profile on user side
- short grain direction
- pedestal locking
- letter width file/file pedestal
- one end and back panel grommet with wire pass thru
- one surface grommet

Lateral File Return	23 7/8	47 7/8	30	170	25	FN2448LRR	\$4,285
	23 7/8	47 7/8	30	170	25	FN2448LLR	\$4,285



left shown

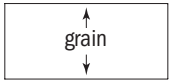

- top edge profile on user side
- short grain direction
- anti-tip interlock mechanism
- pedestal locking
- one end and back panel grommet with wire pass thru
- one surface grommet

Multi-File Return	23 7/8	47 7/8	30	170	25	FN2448MRR	\$5,148
	23 7/8	47 7/8	30	170	25	FN2448MLR	\$5,148

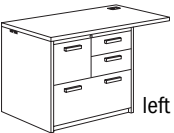

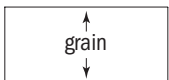

left shown

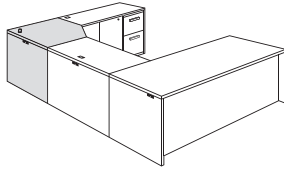

- top edge profile on user side
- short grain direction
- 36" width multi-file
- pedestal locking
- one end and back panel grommet with wire pass thru
- one surface grommet

Corner Unit Applications - Computer L



Description	D	W	H	CTN WT	CU FT	① Model	List Price
Executive Corner Unit	41 7/8	41 7/8	30	135	36	FN4242ERCU	\$3,431
	41 7/8	41 7/8	30	135	36	FN4242ELCU	\$3,431
	35 7/8	35 7/8	30	118	27	FN3636ERCU	\$3,121
	35 7/8	35 7/8	30	118	27	FN3636ELCU	\$3,121

- use with corner return
- not freestanding
- one surface and two back panel grommets

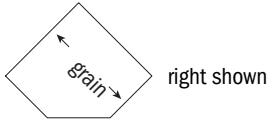

To Order, Specify:

- ① Model Number
- ② Finish Color - (see page [FN16](#))
- ③ Edge Profile - (see page [FN16](#))
- ④ Pull Style and Color - (see page [FN16](#))
- ⑤ Grommet Color - (see page [FN16](#))
- ⑥ Other Product Options (see page [FN9](#))
- ⑦ Accessories, Power and Data Options (see [accessories price list](#))

Corner Return Applications - Executive L

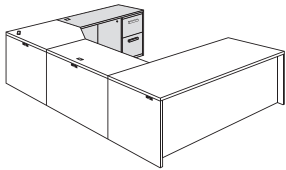

Description	D	W	H	CTN WT	CU FT	① Model	List Price
File/File Corner Return	23 7/8	47 7/8	30	150	25	FN2448ERCR	\$3,431
	23 7/8	47 7/8	30	150	25	FN2448ELCR	\$3,431
	23 7/8	41 7/8	30	145	22	FN2442ERCR	\$3,095
	23 7/8	41 7/8	30	145	22	FN2442ELCR	\$3,095

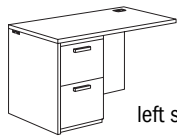

left shown

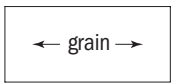

- top edge profile on user side
- long grain direction
- pedestal locking
- letter width file/file pedestal
- one end and back panel grommet with wire pass thru
- one surface grommet

Lateral File Corner Return	23 7/8	47 7/8	30	170	25	FN2448LRCR	\$4,285
	23 7/8	47 7/8	30	170	25	FN2448LLCR	\$4,285



left shown

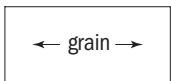

- top edge profile on user side
- long grain direction
- anti-tip interlock mechanism
- pedestal locking
- one end and back panel grommet with wire pass thru
- one surface grommet

Multi-File Corner Return	23 7/8	47 7/8	30	170	25	FN2448MR CR	\$5,148
	23 7/8	47 7/8	30	170	25	FN2448MLCR	\$5,148



left shown

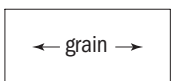

- top edge profile on user side
- long grain direction
- 36" width multi-file
- pedestal locking
- one end and back panel grommet with wire pass thru
- one surface grommet

Bridge Applications - Executive U

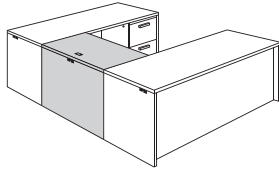

Description	D	W	H	CTN WT	CU FT	① Model	List Price
Bridge with Modesty Panel	23 7/8	48	30	105	5	FN2448EB	\$1,551
	23 7/8	42	30	85	3	FN2442EB	\$1,412
	23 7/8	36	30	65	3	FN2436EB	\$1,213

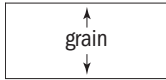
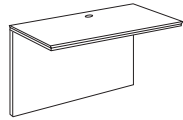

- top edge profile on user side
- short grain direction
- one surface grommet
- one back panel grommet

Bridge Top	23 7/8	48	1 3/16	39	4	FN4824MCT	\$1,393
	23 7/8	42	1 3/16	35	4	FN4224MCT	\$1,292
	23 7/8	36	1 3/16	29	3	FN3624MCT	\$1,144

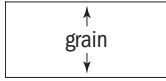
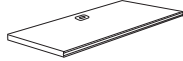

- top edge profile on user side
- short grain direction
- one surface grommet
- no modesty included; top only

To Order, Specify:

- ① Model Number
- ② Finish Color - (see page [FN16](#))
- ③ Edge Profile - (see page [FN16](#))
- ④ Pull Style and Color - (see page [FN16](#))
- ⑤ Grommet Color - (see page [FN16](#))
- ⑥ Other Product Options (see page [FN9](#))
- ⑦ Accessories, Power and Data Options (see [accessories price list](#))

Description	D	W	H	CTN WT	CU FT	① Model	List Price
Electric Adjustable Height Bridge	24	46	Adj.	90	9	FN2446AHB-EL	\$3,324
	24	40	Adj.	85	8	FN2440AHB-EL	\$3,263

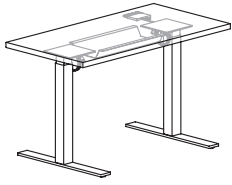

- 22 1/2" - 49" height adjustment
- top edge profile on user and approach sides
- push button control pad mounted right or left
- maximum weight rating 140 lbs. (evenly distributed load)
- key pad features height display with three memory settings
- display will reference position to the nearest 1/2"
- 120" power cord
- specify Matte Black (MBK) or Arctic Silver (STS) base finish
- ships KD

Modesty Panel for Adjustable Height Bridge	3/4	46	9	13	2	FN0946TDM	\$812
	3/4	40	9	11	2	FN0940TDM	\$788

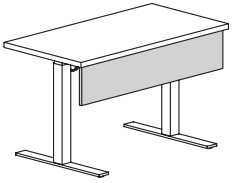

- FN0946TDM use with 46" wide adjustable height bridge
- FN0940TDM use with 40" wide adjustable height bridge
- modesty panel bracket is available in Black Sandtex (BSX) or Stardust Silver (STS)
- flat edge detail

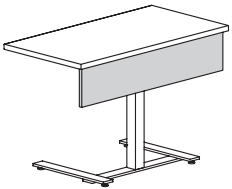

Description	D	W	H	CTN WT	CU FT	① Model	List Price
Storage Credenza	24	71 ¾	30	290	36	FN2472SC	\$5,183
	24	65 ¾	30	270	33	FN2466SC	\$5,033



- top edge profile on user side
- file/file pedestal - legal width
- adjustable shelf in center storage
- pedestal locking
- locking doors available, specify and add \$147 list
- one back and two end panel grommets with wire pass thru

Lateral File Credenza	24	71 ¾	30	235	36	FN2472LFC	\$5,368
-----------------------	----	------	----	-----	----	-----------	---------



- top edge profile on user side
- two drawer lateral files side by side
- pedestal front locking
- anti-tip interlock mechanism
- two end panel grommets with wire pass thru

Four Door Credenza	24	71 ¾	30	235	36	FN2472DSC	\$5,131
--------------------	----	------	----	-----	----	-----------	---------

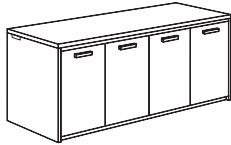

- top edge profile on user side
- adjustable shelves
- locking doors available, specify and add \$294 list
- two end panel grommets with wire pass thru

Two Door Credenza	24	35 ¾	30	90	19	FN3630SC	\$2,431
-------------------	----	------	----	----	----	----------	---------



- top edge profile on user side
- one adjustable shelf
- locking doors available, specify and add \$147 list
- two end panel grommets with wire pass thru
- compatible with overhead bookcases and cabinets; see page [FN56](#)

To Order, Specify:

- ① Model Number
- ② Finish Color - (see page [FN16](#))
- ③ Edge Profile - (see page [FN16](#))
- ④ Pull Style and Color - (see page [FN16](#))
- ⑤ Grommet Color - (see page [FN16](#))
- ⑥ Metal Color - (see page [FN16](#))
- ⑦ Other Product Options (see page [FN9](#))
- ⑧ Accessories, Power and Data Options (see [accessories price list](#))

Description	D	W	H	CTN WT	CU FT	① Model	List Price
Kneespace Credenza	24	71 ¾	30	270	36	FN2472KC	\$5,033
	24	65 ¾	30	255	33	FN2466KC	\$4,872



- top edge profile on user side
- file/file pedestals - legal width
- pedestal locking
- one back and two end panel grommets with wire pass thru
- kneespace for FN2472KC - 32 ½"
- kneespace for FN2466KC - 26 ½"

Buffet Credenza	24	71 ¾	36	280	43	FN2472BSC	\$7,255
-----------------	----	------	----	-----	----	-----------	---------



- top edge profile on user side
- four door credenza
- four box drawers above doors
- locking doors and drawers not available
- adjustable shelf in storage cabinet
- two end panel grommets with wire pass thru

Credenza Applications - Executive U

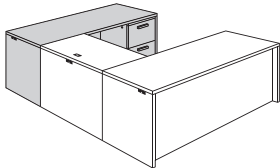

Description	D	W	H	CTN WT	CU FT	① Model	List Price
File/File Pedestal Credenza	23 7/8	71 ¾	30	235	36	FN2472RC	\$4,428
	23 7/8	71 ¾	30	235	36	FN2472LC	\$4,428
	23 7/8	65 ¾	30	220	33	FN2466RC	\$4,217
	23 7/8	65 ¾	30	220	33	FN2466LC	\$4,217



left shown

- top edge profile on user side
- pedestal locking
- legal width file/file pedestal
- two end panel and one back panel grommet with wire pass thru

File/File Reception Credenza	23 7/8	71 ¾	30	235	36	FN2472RCR	\$4,428
	23 7/8	71 ¾	30	235	36	FN2472LCR	\$4,428



left shown

- top edge profile on user side
- pedestal locking
- file/file pedestal - legal width
- two end panel grommets with wire pass thru
- no back panel grommets

Description	D	W	H	CTN WT	CU FT	① Model	List Price
Lateral Pedestal Credenza	23 7/8	71 3/4	30	250	36	FN2472LRC	\$4,977
	23 7/8	71 3/4	30	250	36	FN2472LLC	\$4,977



left shown

- top edge profile on user side
- pedestal locking
- anti-tip interlock mechanism
- two end panel and one back panel grommet with wire pass thru
- 36" wide lateral file

Multi-File Pedestal Credenza	23 7/8	71 3/4	30	265	36	FN2472MRC	\$5,203
	23 7/8	71 3/4	30	265	36	FN2472MLC	\$5,203



left shown

- top edge profile on user side
- pedestal locking
- 36" width multi-file
- two end panel and one back panel grommet with wire pass thru

Printer Stand	24	30	30	120	16	FN2430PS	\$2,270
----------------------	----	----	----	-----	----	-----------------	----------------

- fixed 11" deep shelf

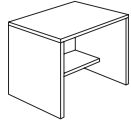

Corner Unit	41 7/8	41 7/8	30	135	36	FN4242CU	\$3,431
	35 7/8	35 7/8	30	121	27	FN3636CU	\$3,121

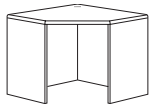

- angle grain direction on top
- one surface grommet and two back panel grommets
- freestanding
- top edge profile on user side only
- keyboard tray or mouse pad cannot be used with FN3636CU

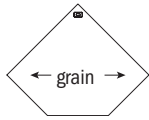
To Order, Specify:

- ① Model Number
- ② Finish Color - (see page [FN16](#))
- ③ Edge Profile - (see page [FN16](#))
- ④ Pull Style and Color (see page [FN16](#))
- ⑤ Grommet Color - (see page [FN16](#))
- ⑥ Other Product Options (see page [FN9](#))
- ⑦ Accessories, Power and Data Options (see [accessories price list](#))

Description	D	W	H	CTN WT	CU FT	① Model	List Price
Double Height Storage Overhead Cabinet with Four Doors	15 7/8	83 3/4	54	338	50	FN1684DSO	\$5,075
	15 7/8	77 3/4	54	318	47	FN1678DSO	\$4,979
	15 7/8	71 3/4	54	297	43	FN1672DSO	\$4,882
	15 7/8	65 3/4	54	262	40	FN1666DSO	\$4,680

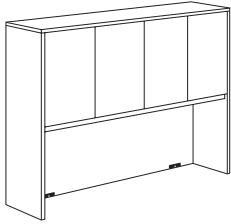

- grommet in bottom left and right and in top center of back panel
- tackboards available, see pages [FN52-FN53](#)
- task lights available, see [accessories price list](#)
- 22" vertical clearance from desk top to bottom of light soffit
- adjustable shelf
- optional modular top, see page [FN64](#)
- locking doors available, specify and add \$294 list
- no pulls
- backside of unit intended to go against wall, cabinet should be secured to wall as a safety precaution

Double Height Storage Overhead Cabinet with Four Glass Doors	15 7/8	83 3/4	54	342	50	FN1684DGSO	\$6,340
	15 7/8	77 3/4	54	323	47	FN1678DGSO	\$6,219
	15 7/8	71 3/4	54	301	43	FN1672DGSO	\$6,100
	15 7/8	65 3/4	54	266	40	FN1666DGSO	\$5,846

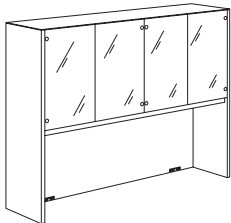

- white back painted glass doors
- grommet in bottom left and right and in top center of back panel
- tackboards available, see pages [FN52-FN53](#)
- task lights available, see [accessories price list](#)
- 22" vertical clearance from desk top to bottom of light soffit
- adjustable shelf
- optional modular top, see page [FN64](#)
- locking doors not available
- pulls not available
- backside of unit intended to go against wall, cabinet should be secured to wall as a safety precaution

Description	D	W	H	CTN WT	CU FT	① Model	List Price
Double Height Storage Overhead Cabinet with Four Doors and Cubbies	15 7/8	83 3/4	54	373	50	FN1684DSOC	\$6,119
	15 7/8	77 3/4	54	351	47	FN1678DSOC	\$5,947
	15 7/8	71 3/4	54	327	43	FN1672DSOC	\$5,816
	15 7/8	65 3/4	54	290	40	FN1666DSOC	\$5,678

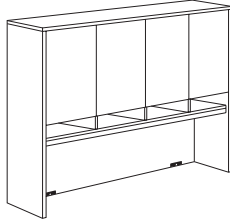

- grommet in bottom left and right and in top center of back panel
- tackboards available, see pages [FN54-FN55](#)
- task lights available, see [accessories price list](#)
- 17 1/2" vertical clearance from desk top to bottom of light soffit
- adjustable shelf
- optional modular top, see page [FN64](#)
- locking doors available, specify and add \$294 list
- no pulls
- backside of unit intended to go against wall, cabinet should be secured to wall as a safety precaution

Double Height Storage Overhead Cabinet with Four Glass Doors and Cubbies	15 7/8	83 3/4	54	377	50	FN1684DGSOC	\$7,385
	15 7/8	77 3/4	54	356	47	FN1678DGSOC	\$7,190
	15 7/8	71 3/4	54	331	43	FN1672DGSOC	\$7,033
	15 7/8	65 3/4	54	294	40	FN1666DGSOC	\$6,672

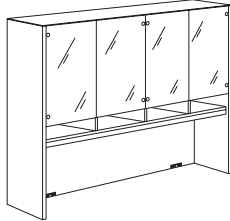

- white back painted glass doors
- grommet in bottom left and right and in top center of back panel
- tackboards available, see pages [FN54-FN55](#)
- task lights available, see [accessories price list](#)
- 17 1/2" vertical clearance from desk top to bottom of light soffit
- adjustable shelf
- optional modular top, see page [FN64](#)
- locking doors not available
- pulls not available
- backside of unit intended to go against wall, cabinet should be secured to wall as a safety precaution

To Order, Specify:

- ① Model Number
- ② Finish Color - (see page [FN16](#))
- ③ Edge Profile - (see page [FN16](#))
- ④ Other Product Options (see page [FN9](#))

Description	D	W	H	CTN WT	CU FT	① Model	List Price
Open Storage Overhead Cabinet	16	83 ¾	42	238	40	FN168400	\$4,072
	16	77 ¾	42	238	37	FN167800	\$3,993
	16	71 ¾	42	228	34	FN167200	\$3,913
	16	65 ¾	42	218	32	FN166600	\$3,738



- top edge profile on user side
- grommet in bottom left and right and in top center of back panel
- tackboards available, see pages [FN52-FN53](#)
- task lights available, see [accessories price list](#)
- 22" vertical clearance from desk top to bottom of light soffit

Storage Overhead Cabinet with Four Doors	16	83 ¾	42	258	40	FN1684S0	\$4,221
	16	77 ¾	42	258	37	FN1678S0	\$4,143
	16	71 ¾	42	248	34	FN1672S0	\$4,065
	16	65 ¾	42	238	32	FN1666S0	\$3,893

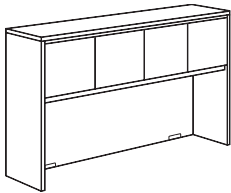

- top edge profile on user side
- grommet in bottom left and right and in top center of back panel
- tackboards available, see pages [FN52-FN53](#)
- task lights available, see [accessories price list](#)
- 22" vertical clearance from desk top to bottom of light soffit
- locking doors available, specify and add \$294 list
- no pulls

Storage Overhead Cabinet with Four Glass Doors	16	83 ¾	42	258	40	FN1684GS0	\$4,860
	16	77 ¾	42	258	37	FN1678GS0	\$4,782
	16	71 ¾	42	248	34	FN1672GS0	\$4,706
	16	65 ¾	42	238	32	FN1666GS0	\$4,542

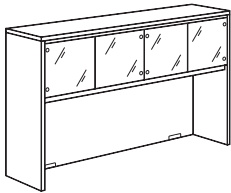

- top edge profile on user side
- white back painted glass doors
- grommet in bottom left and right and in top center of back panel
- tackboards available, see pages [FN52-FN53](#)
- task lights available, see [accessories price list](#)
- 22" vertical clearance from desk top to bottom of light soffit
- locking doors not available
- pulls not available

Description	D	W	H	CTN WT	CU FT	① Model	List Price
Open Storage Overhead Cabinet with Cubbies	16	83 ¾	42	286	40	FN168400C	\$5,119
	16	77 ¾	42	271	37	FN167800C	\$4,963
	16	71 ¾	42	258	34	FN167200C	\$4,845
	16	65 ¾	42	246	32	FN166600C	\$4,560

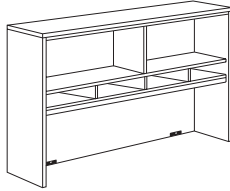

- top edge profile on user side
- grommet in bottom left and right and in top center of back panel
- tackboards available, see pages [FN54-FN55](#)
- task lights available, see [accessories price list](#)
- 17 ½" vertical clearance from desk top to bottom of light soffit

Storage Overhead Cabinet with Four Doors and Cubbies	16	83 ¾	42	306	40	FN1684S0C	\$5,268
	16	77 ¾	42	291	37	FN1678S0C	\$5,115
	16	71 ¾	42	278	34	FN1672S0C	\$4,996
	16	65 ¾	42	266	32	FN1666S0C	\$4,640

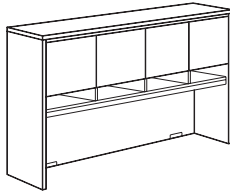

- top edge profile on user side
- grommet in bottom left and right and in top center of back panel
- tackboards available, see pages [FN54-FN55](#)
- task lights available, see [accessories price list](#)
- 17 ½" vertical clearance from desk top to bottom of light soffit
- locking doors available, specify and add \$294 list
- pulls not available

Storage Overhead Cabinet with Four Glass Doors and Cubbies	16	83 ¾	42	310	40	FN1684GS0C	\$5,902
	16	77 ¾	42	295	37	FN1678GS0C	\$5,753
	16	71 ¾	42	282	34	FN1672GS0C	\$5,639
	16	65 ¾	42	270	32	FN1666GS0C	\$5,363

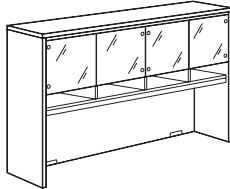

- top edge profile on user side
- white back painted glass doors
- grommet in bottom left and right and in top center of back panel
- tackboards available, see pages [FN54-FN55](#)
- task lights available, see [accessories price list](#)
- 17 ½" vertical clearance from desk top to bottom of light soffit
- adjustable shelf
- locking doors not available
- pulls not available

To Order, Specify:

- ① Model Number
- ② Finish Color - (see page [FN16](#))
- ③ Edge Profile - (see page [FN16](#))
- ④ Knob Color - (see page [FN16](#))
- ⑤ Other Product Options (see page [FN9](#))

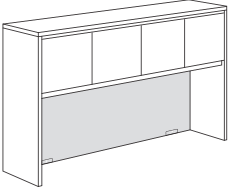
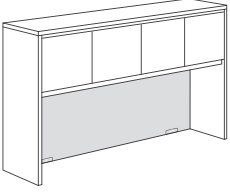
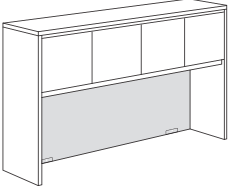
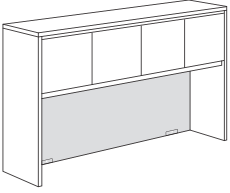
Description	D	W	H	CTN WT	CU FT	① Model	List Price Per Grade
Tackboard for 84" w Storage Overhead Cabinet 	3/8	81 1/4	17 1/8	3	4	FN84TK	COM \$497
							A \$621
<ul style="list-style-type: none"> · for use with 84" wide storage overhead cabinet · fabrics available; visit www.jsifurniture.com/finishes-and-materials/textiles for our textiles program · com ydg: 2 3/4 							B \$647
							C \$721
							D \$825
							E \$920
							F \$1,027
							G \$1,155
							H \$1,340
							I \$1,395
							J \$1,553
							Tackboard for 78" w Storage Overhead Cabinet 
A \$604							
<ul style="list-style-type: none"> · for use with 78" wide storage overhead cabinet · fabrics available; visit www.jsifurniture.com/finishes-and-materials/textiles for our textiles program · com ydg: 2 1/2 							B \$628
							C \$695
							D \$790
							E \$876
							F \$974
							G \$1,090
							H \$1,258
							I \$1,308
							J \$1,453
							Tackboard for 72" w Storage Overhead Cabinet 
A \$563							
<ul style="list-style-type: none"> · for use with 72" wide storage overhead cabinet · fabrics available; visit www.jsifurniture.com/finishes-and-materials/textiles for our textiles program · com ydg: 2 1/4 							B \$584
							C \$645
							D \$730
							E \$808
							F \$896
							G \$1,000
							H \$1,152
							I \$1,197
							J \$1,327
							Tackboard for 66" w Storage Overhead Cabinet 
A \$525							
<ul style="list-style-type: none"> · for use with 66" wide storage overhead cabinet · fabrics available; visit www.jsifurniture.com/finishes-and-materials/textiles for our textiles program · com ydg: 2 							B \$543
							C \$597
							D \$673
							E \$742
							F \$820
							G \$913
							H \$1,048
							I \$1,088
							J \$1,204

FINALE

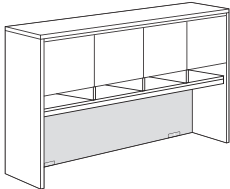
Description	D	W	H	CTN WT	CU FT	① Model	List Price Per Grade	
Tackboard for 84" w Storage Overhead Cabinet with Cubbies 	3/8	81 1/4	12 1/8	3	2	FN84TKC	COM \$497	
	<ul style="list-style-type: none"> · for use with 84" wide storage overhead cabinet · fabrics available; visit www.jsifurniture.com/finishes-and-materials/textiles for our textiles program · com ydg: 2 3/4 							A \$621
								B \$647
								C \$721
								D \$825
								E \$920
								F \$1,027
								G \$1,155
								H \$1,340
								I \$1,395
							J \$1,553	

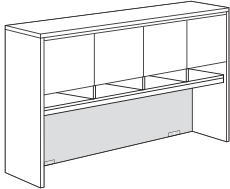
Tackboard for 78" w Storage Overhead Cabinet with Cubbies 	3/8	75 1/4	12 1/8	3	2	FN78TKC	COM \$491	
	<ul style="list-style-type: none"> · for use with 78" wide storage overhead cabinet · fabrics available; visit www.jsifurniture.com/finishes-and-materials/textiles for our textiles program · com ydg: 2 1/2 							A \$604
								B \$628
								C \$695
								D \$790
								E \$876
								F \$974
								G \$1,090
								H \$1,258
								I \$1,308
							J \$1,453	

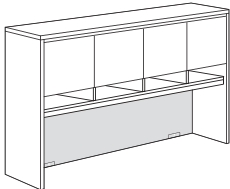
Tackboard for 72" w Storage Overhead Cabinet with Cubbies 	3/8	69 1/4	12 1/8	2	2	FN72TKC	COM \$461	
	<ul style="list-style-type: none"> · for use with 72" wide storage overhead cabinet · fabrics available; visit www.jsifurniture.com/finishes-and-materials/textiles for our textiles program · com ydg: 2 1/4 							A \$563
								B \$584
								C \$645
								D \$730
								E \$808
								F \$896
								G \$1,000
								H \$1,152
								I \$1,197
							J \$1,327	

To Order, Specify:

- ① Model Number
- ② Fabric Selection: vendor, pattern color
- ③ Other Product Options (see page [FN9](#))

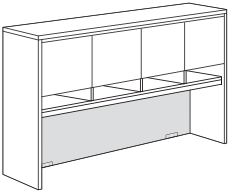
Description	D	W	H	CTN WT	CU FT	① Model	List Price Per Grade	
Tackboard for 66" w Storage Overhead Cabinet with Cubbies 	3/8	63 1/4	12 1/8	2	2	FN66TKC	COM \$434	
	<ul style="list-style-type: none"> · for use with 66" wide storage overhead cabinet · fabrics available; visit www.jsifurniture.com/finishes-and-materials/textiles for our textiles program · com ydg: 2 							A \$525
								B \$543
								C \$597
								D \$673
								E \$742
								F \$820
								G \$913
								H \$1,048
								I \$1,088
								J \$1,204

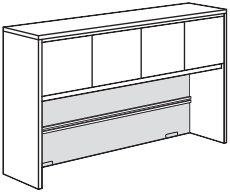
Tackboard for Accessory Rail on 84" w Storage Overhead Cabinet 	3/8	81 1/4		3	4	FN84TKA	COM \$554	
	<ul style="list-style-type: none"> · tackboard panels for above and below accessory rail · not required; add-on for convenience application · fabrics available; visit www.jsifurniture.com/finishes-and-materials/textiles for our textiles program · upper tackboard height: 6 3/8 · lower tackboard height: 7 1/2 · coordinates with FN1684DSO, FN1684DGSO, FN168400, FN1684SO, FN1684GSO · accessory rail sold separately, see page FN45 							A \$679
								B \$704
								C \$778
								D \$882
								E \$977
								F \$1,084
								G \$1,212
								H \$1,398
								I \$1,453
								J \$1,612

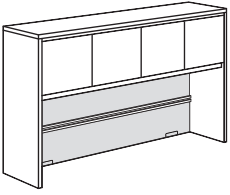
Tackboard for Accessory Rail on 78" w Storage Overhead Cabinet 	3/8	75 1/4		3	4	FN78TKA	COM \$543	
	<ul style="list-style-type: none"> · tackboard panels for above and below accessory rail · not required; add-on for convenience application · fabrics available; visit www.jsifurniture.com/finishes-and-materials/textiles for our textiles program · upper tackboard height: 6 3/8 · lower tackboard height: 7 1/2 · coordinates with FN1678DSO, FN1678DGSO, FN167800, FN1678SO, FN1678GSO · accessory rail sold separately, see page FN45 · com ydg: 2 1/2 							A \$656
								B \$680
								C \$747
								D \$841
								E \$928
								F \$1,025
								G \$1,141
								H \$1,310
								I \$1,361
								J \$1,506

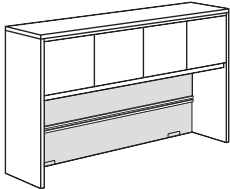
Description	D	W	H	CTN WT	CU FT	① Model	List Price Per Grade
Tackboard for Accessory Rail on 72" w Storage Overhead Cabinet 	3/8	69 1/4		2	3	FN72TKA	COM \$516
							A \$618
<ul style="list-style-type: none"> tackboard panels for above and below accessory rail not required; add-on for convenience application fabrics available; visit www.jsifurniture.com/finishes-and-materials/textiles for our textiles program upper tackboard height: 6 3/8 lower tackboard height: 7 1/2 coordinates with FN1672DSO, FN1672DGSO, FN167200, FN1672SO, FN1672GSO accessory rail sold separately, see page FN45 com ydg: 2 1/4 							B \$639
							C \$700
							D \$785
							E \$863
							F \$951
							G \$1,055
							H \$1,207
							I \$1,253
							J \$1,384

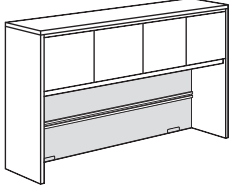
Tackboard for Accessory Rail on 66" w Storage Overhead Cabinet 	3/8	63 1/4		2	3	FN66TKA	COM \$484
							A \$575
<ul style="list-style-type: none"> tackboard panels for above and below accessory rail not required; add-on for convenience application fabrics available; visit www.jsifurniture.com/finishes-and-materials/textiles for our textiles program upper tackboard height: 6 3/8 lower tackboard height: 7 1/2 coordinates with FN1666DSO, FN1666DGSO, FN166600, FN1666SO, FN1666GSO accessory rail sold separately, see page FN45 com ydg: 2 							B \$594
							C \$648
							D \$723
							E \$792
							F \$870
							G \$963
							H \$1,099
							I \$1,140
							J \$1,256

To Order, Specify:

- ① Model Number
- ② Fabric Selection: vendor, pattern color
- ③ Other Product Options (see page [FN9](#))

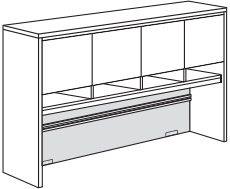
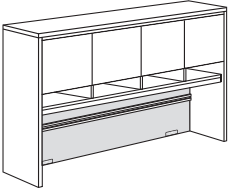
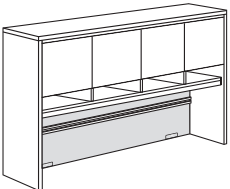
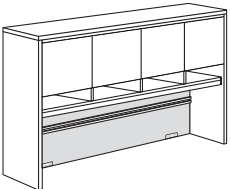
Description	D	W	H	CTN WT	CU FT	① Model	List Price Per Grade
Tackboard for Accessory Rail on 84" w Storage Overhead Cabinet with Cubbies 	3/8	81 1/4		3	2	FN84TKCA	COM \$554
							A \$679
<ul style="list-style-type: none"> tackboard panels for above and below accessory rail not required; add-on for convenience application fabrics available; visit www.jsifurniture.com/finishes-and-materials/textiles for our textiles program upper tackboard height: 2 1/4 lower tackboard height: 7 1/2 coordinates with FN1684DSOC, FN1684DGSOC, FN168400C, FN1684SOC, FN1684GSOC accessory rail sold separately, see page FN45 com ydg: 2 3/4 							B \$704
							C \$778
							D \$882
							E \$977
							F \$1,084
							G \$1,212
							H \$1,398
							I \$1,453
							J \$1,612
	Tackboard for Accessory Rail on 78" w Storage Overhead Cabinet with Cubbies 	3/8	75 1/4		3	2	FN78TKCA
A \$656							
<ul style="list-style-type: none"> tackboard panels for above and below accessory rail not required; add-on for convenience application fabrics available; visit www.jsifurniture.com/finishes-and-materials/textiles for our textiles program upper tackboard height: 2 1/4 lower tackboard height: 7 1/2 coordinates with FN1678DSOC, FN1678DGSOC, FN167800C, FN1678SOC, FN1678GSOC accessory rail sold separately, see page FN45 com ydg: 2 1/2 							B \$680
							C \$747
							D \$841
							E \$928
							F \$1,025
							G \$1,141
							H \$1,310
							I \$1,361
							J \$1,506
	Tackboard for Accessory Rail on 72" w Storage Overhead Cabinet with Cubbies 	3/8	69 1/4		2	2	FN72TKCA
A \$618							
<ul style="list-style-type: none"> tackboard panels for above and below accessory rail not required; add-on for convenience application fabrics available; visit www.jsifurniture.com/finishes-and-materials/textiles for our textiles program upper tackboard height: 2 1/4 lower tackboard height: 7 1/2 coordinates with FN1672DSOC, FN1672DGSOC, FN167200C, FN1672SOC, FN1672GSOC accessory rail sold separately, see page FN45 com ydg: 2 1/4 							B \$639
							C \$700
							D \$785
							E \$863
							F \$951
							G \$1,055
							H \$1,207
							I \$1,253
							J \$1,384
	Tackboard for Accessory Rail on 66" w Storage Overhead Cabinet with Cubbies 	3/8	63 1/4		2	2	FN66TKCA
A \$575							
<ul style="list-style-type: none"> tackboard panels for above and below accessory rail not required; add-on for convenience application fabrics available; visit www.jsifurniture.com/finishes-and-materials/textiles for our textiles program upper tackboard height: 2 1/4 lower tackboard height: 7 1/2 coordinates with FN1666DSOC, FN1666DGSOC, FN166600C, FN1666SOC, FN1666GSOC accessory rail sold separately, see page FN45 com ydg: 2 							B \$594
							C \$648
							D \$723
							E \$792
							F \$870
							G \$963
							H \$1,099
							I \$1,140
							J \$1,256

FINALE

Description	D	W	H	CTN WT	CU FT	① Model	List Price Per Grade
Accessory Rails 	3/4	81 1/4	3 1/4	6	2	FN84AR For use on: • FN1684DGSO • FN168400 • FN1684DSO • FN1684SO • FN1684GSO	\$530
	3/4	75 1/4	3 1/4	5	2	FN78AR For use on: • FN1678DGSO • FN167800 • FN1678DSO • FN1678SO • FN1678GSO	\$503
	3/4	69 1/4	3 1/4	5	2	FN72AR For use on: • FN1672DGSO • FN167200 • FN1672DSO • FN1672SO • FN1672GSO	\$478
	3/4	63 1/4	3 1/4	4	2	FN66AR For use on: • FN1666DGSO • FN166600 • FN1666DSO • FN1666SO • FN1666GSO	\$453

To Order, Specify:

- ① Model Number
- ② Fabric Selection: vendor, pattern color
- ③ Other Product Options (see page [FN9](#))

Description	D	W	H	CTN WT	CU FT	① Model	List Price
Upright Tray	1 9/16	3 1/8	3 9/16	1	1	AC203CUP	\$112

- pen and gadget cup
- Stardust Silver finish

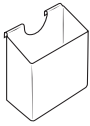

Small Tray	3 5/16	2 11/16	7/8	1	1	AC403TRAY	\$85
-------------------	--------	---------	-----	---	---	-----------	------

- tray for paper clips and other small items
- Stardust Silver finish



Pencil Tray	3 5/16	7 11/16	7/8	1	1	AC408TRAY	\$103
--------------------	--------	---------	-----	---	---	-----------	-------

- tray for pencils and other small items
- Stardust Silver finish

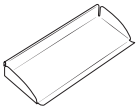

Paper Tray	9 15/16	13 3/16	7/8	2	1	AC912PAP	\$157
-------------------	---------	---------	-----	---	---	----------	-------

- tray for 8 1/2 x 11" letter paper size
- Stardust Silver finish

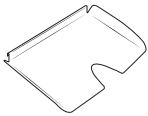

File Hanger	2 13/16	12 3/16	4	1	1	AC313FILE	\$149
--------------------	---------	---------	---	---	---	-----------	-------

- file hanger for 8 1/2 x 11" letter size hanging file folders
- Stardust Silver finish

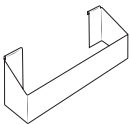

Acrylic Accessory Tray	12 1/4	9 1/4	2 1/4	5	1	ALT0912C	\$392
-------------------------------	--------	-------	-------	---	---	----------	-------

- set of 4



Description	D	W	H	CTN WT	CU FT	① Model	List Price
Double Height Wall Mount Open Overhead	15 7/8	41 3/4	31 1/2	125	16	FN1642DWMO	\$2,158
	15 7/8	35 3/4	31 1/2	108	14	FN1636DWMO	\$1,957
	15 7/8	29 3/4	31 1/2	99	12	FN1630DWMO	\$1,723

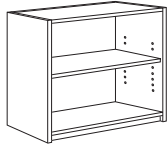

- supported by wall cleat - hardware provided by installer
- adjustable shelf
- optional modular top, see page [FN64](#)

Double Height Wall Mount Overhead Cabinet with Two Doors	15 7/8	41 3/4	31 1/2	125	16	FN1642DWMS	\$3,030
	15 7/8	35 3/4	31 1/2	113	14	FN1636DWMS	\$2,822
	15 7/8	29 3/4	31 1/2	105	12	FN1630DWMS	\$2,633

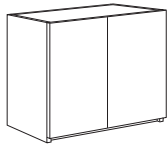

- supported by wall cleat - hardware provided by installer
- adjustable shelf
- locking doors available, specify and add \$147 list
- optional modular top, see page [FN64](#)
- no pulls

Double Height Wall Mount Overhead Cabinet with Two Glass Doors	15 7/8	41 3/4	31 1/2	135	16	FN1642DGWMS	\$3,427
	15 7/8	35 3/4	31 1/2	115	14	FN1636DGWMS	\$3,221
	15 7/8	29 3/4	31 1/2	107	12	FN1630DGWMS	\$3,035

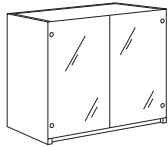

- white back painted glass doors
- supported by wall cleat - hardware provided by installer
- adjustable shelf
- optional modular top, see page [FN64](#)
- locking doors not available
- pulls not available

To Order, Specify:

- ① Model Number
- ② Finish Color - (see page [FN16](#))
- ③ Other Product Options (see page [FN9](#))

Description	D	W	H	CTN WT	CU FT	① Model	List Price
Double Height Wall Mount Open Overhead with Cubbies	15 7/8	41 3/4	36 1/2	140	18	FN1642DWMOC	\$2,591
	15 7/8	35 3/4	36 1/2	128	16	FN1636DWMOC	\$2,391
	15 7/8	29 3/4	36 1/2	119	13	FN1630DWMOC	\$2,161



- supported by wall cleat - hardware provided by installer
- adjustable shelf
- optional modular top, see page [FN64](#)

Double Height Wall Mount Overhead Cabinet with Two Doors and Cubbies	15 7/8	41 3/4	36 1/2	150	18	FN1642DWMSC	\$3,462
	15 7/8	35 3/4	36 1/2	136	16	FN1636DWMSC	\$3,256
	15 7/8	29 3/4	36 1/2	127	13	FN1630DWMSC	\$3,068

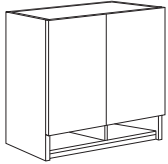

- supported by wall cleat - hardware provided by installer
- adjustable shelf
- locking doors available, specify and add \$147 list
- optional modular top, see page [FN64](#)
- no pulls

Double Height Wall Mount Overhead Cabinet with Two Glass Doors and Cubbies	15 7/8	41 3/4	36 1/2	160	18	FN1642DGMWSC	\$3,863
	15 7/8	35 3/4	36 1/2	143	16	FN1636DGMWSC	\$3,657
	15 7/8	29 3/4	36 1/2	134	13	FN1630DGMWSC	\$3,470

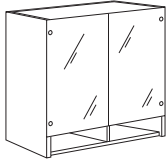

- white back painted glass doors
- supported by wall cleat - hardware provided by installer
- adjustable shelf
- optional modular top, see page [FN64](#)
- locking doors not available
- pulls not available

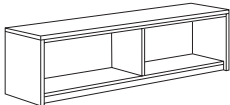
Description	D	W	H	CTN WT	CU FT	① Model	List Price
Wall Mount Open Overhead 	16	71 ¾	19 ½	155	17	FN1672WMO	\$3,157
	16	65 ¾	19 ½	115	16	FN1666WMO	\$3,003

- top edge profile on user side
- supported by wall cleat - hardware provided by installer

Wall Mount Open Overhead 	16	41 ¾	19 ½	95	10	FN1642WMO	\$1,726
	16	35 ¾	19 ½	80	9	FN1636WMO	\$1,569
	16	29 ¾	19 ½	65	8	FN1630WMO	\$1,381

- top edge profile on user side
- supported by wall cleat - hardware provided by installer

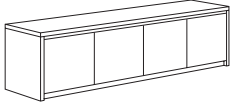
Wall Mount Overhead Cabinet with Four Doors 	16	71 ¾	19 ½	170	17	FN1672WMS	\$3,316
	16	65 ¾	19 ½	130	16	FN1666WMS	\$3,162

- top edge profile on user side
- supported by wall cleat - hardware provided by installer
- locking doors available, specify and add \$294 list
- no pulls

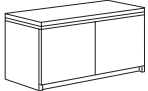
Wall Mount Overhead Cabinet with Two Doors 	16	41 ¾	19 ½	95	10	FN1642WMS	\$2,497
	16	35 ¾	19 ½	85	9	FN1636WMS	\$2,260
	16	29 ¾	19 ½	70	8	FN1630WMS	\$2,107

- top edge profile on user side
- supported by wall cleat - hardware provided by installer
- locking doors available, specify and add \$147 list
- no pulls

To Order, Specify:

- ① Model Number
- ② Finish Color - (see page [FN16](#))
- ③ Edge Profile - (see page [FN16](#))
- ④ Other Product Options (see page [FN9](#))

Description	D	W	H	CTN WT	CU FT	① Model	List Price
Wall Mount Overhead Cabinet with Four Glass Doors	16	71 ¾	19 ½	175	17	FN1672GWMS	\$4,114
	16	65 ¾	19 ½	135	16	FN1666GWMS	\$3,960

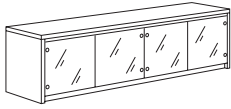

- top edge profile on user side
- supported by wall cleat - hardware provided by installer
- white back painted glass doors
- locking doors not available
- pulls not available

Wall Mount Overhead Cabinet with Two Glass Doors	16	41 ¾	19 ½	100	10	FN1642GWMS	\$3,055
	16	35 ¾	19 ½	86	9	FN1636GWMS	\$2,658
	16	29 ¾	19 ½	72	8	FN1630GWMS	\$2,506



- top edge profile on user side
- supported by wall cleat - hardware provided by installer
- white back painted glass doors
- locking doors not available
- pulls not available

Wall Mount Open Overhead with Cubbies	16	71 ¾	24 ½	182	21	FN1672WMOC	\$3,591
	16	65 ¾	24 ½	170	19	FN1666WMOC	\$3,435

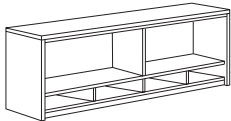

- top edge profile on user side
- supported by wall cleat - hardware provided by installer

Wall Mount Open Overhead with Cubbies	16	41 ¾	24 ½	120	12	FN1642WMOC	\$2,163
	16	35 ¾	24 ½	98	11	FN1636WMOC	\$2,006
	16	29 ¾	24 ½	85	9	FN1630WMOC	\$1,815

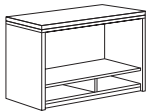

- top edge profile on user side
- supported by wall cleat - hardware provided by installer

Description	D	W	H	CTN WT	CU FT	① Model	List Price
Wall Mount Overhead Cabinet with Four Doors and Cubbies	16	71 ¾	24 ½	201	21	FN1672WMSC	\$3,748
	16	65 ¾	24 ½	188	19	FN1666WMSC	\$3,597

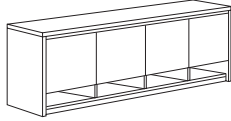

- top edge profile on user side
- supported by wall cleat - hardware provided by installer
- locking doors available, specify and add \$294 list
- no pulls

Wall Mount Overhead Cabinet with Two Doors and Cubbies	16	41 ¾	24 ½	120	12	FN1642WMSC	\$2,933
	16	35 ¾	24 ½	108	11	FN1636WMSC	\$2,693
	16	29 ¾	24 ½	92	9	FN1630WMSC	\$2,539

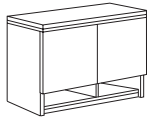

- top edge profile on user side
- supported by wall cleat - hardware provided by installer
- locking doors available, specify and add \$147 list
- no pulls

Wall Mount Overhead Cabinet with Four Glass Doors and Cubbies	16	71 ¾	24 ½	206	21	FN1672GWMSC	\$4,550
	16	65 ¾	24 ½	193	19	FN1666GWMSC	\$4,393

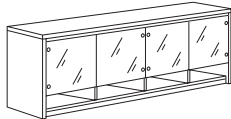

- top edge profile on user side
- supported by wall cleat - hardware provided by installer
- white back painted glass doors
- locking doors not available
- pulls not available

Wall Mount Overhead Cabinet with Two Glass Doors and Cubbies	16	41 ¾	24 ½	125	12	FN1642GWMSC	\$3,494
	16	35 ¾	24 ½	112	11	FN1636GWMSC	\$3,090
	16	29 ¾	24 ½	96	9	FN1630GWMSC	\$2,943



- top edge profile on user side
- supported by wall cleat - hardware provided by installer
- white back painted glass doors
- locking doors not available
- pulls not available

To Order, Specify:

- ① Model Number
- ② Finish Color - (see page [FN16](#))
- ③ Edge Profile - (see page [FN16](#))
- ④ Other Product Options (see page [FN9](#))

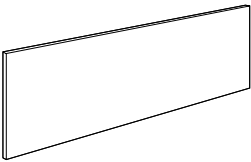
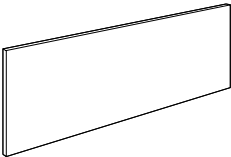
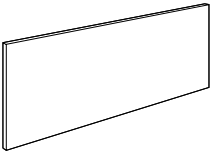
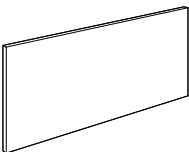
Description	D	W	H	CTN WT	CU FT	① Model	List Price Per Grade
84" w Wall Mount Tackboard  <ul style="list-style-type: none"> · fabrics available; visit www.jsifurniture.com/finishes-and-materials/textiles for our textiles program · com ydg: 2 ¾ 	1 ½	83 ¾	21 ½	2	4	FN8420WT	COM \$596 A \$720 B \$746 C \$820 D \$924 E \$1,019 F \$1,126 G \$1,254 H \$1,440 I \$1,496 J \$1,655
78" w Wall Mount Tackboard  <ul style="list-style-type: none"> · fabrics available; visit www.jsifurniture.com/finishes-and-materials/textiles for our textiles program · com ydg: 2 ½ 	1 ½	77 ¾	21 ½	2	4	FN7820WT	COM \$590 A \$703 B \$727 C \$794 D \$889 E \$975 F \$1,073 G \$1,189 H \$1,358 I \$1,409 J \$1,554
72" w Wall Mount Tackboard  <ul style="list-style-type: none"> · fabrics available; visit www.jsifurniture.com/finishes-and-materials/textiles for our textiles program · com ydg: 2 ¼ 	1 ½	71 ¾	21 ½	2	3	FN7220WT	COM \$561 A \$664 B \$685 C \$745 D \$830 E \$908 F \$996 G \$1,100 H \$1,253 I \$1,299 J \$1,430
66" w Wall Mount Tackboard  <ul style="list-style-type: none"> · fabrics available; visit www.jsifurniture.com/finishes-and-materials/textiles for our textiles program · com ydg: 2 	1 ½	65 ¾	21 ½	2	3	FN6620WT	COM \$531 A \$621 B \$640 C \$694 D \$769 E \$839 F \$917 G \$1,010 H \$1,146 I \$1,187 J \$1,303

FINALE

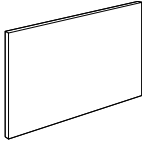
Description	D	W	H	CTN WT	CU FT	① Model	List Price Per Grade
42" w Wall Mount Tackboard	1 1/2	41 3/4	21 1/2	2	2	FN4220WT	COM \$456
 <ul style="list-style-type: none"> · fabrics available; visit www.jsifurniture.com/finishes-and-materials/textiles for our textiles program · com ydg: 1 1/2 							A \$524
							B \$538
							C \$578
							D \$635
							E \$687
							F \$745
							G \$815
							H \$918
							I \$949
							J \$1,037

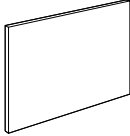
36" w Wall Mount Tackboard	1 1/2	35 3/4	21 1/2	2	2	FN3620WT	COM \$417
 <ul style="list-style-type: none"> · fabrics available; visit www.jsifurniture.com/finishes-and-materials/textiles for our textiles program · com ydg: 1 1/4 							A \$474
							B \$486
							C \$519
							D \$567
							E \$610
							F \$659
							G \$717
							H \$802
							I \$829
							J \$903

30" w Wall Mount Tackboard	1 1/2	29 3/4	21 1/2	2	2	FN3020WT	COM \$387
 <ul style="list-style-type: none"> · fabrics available; visit www.jsifurniture.com/finishes-and-materials/textiles for our textiles program · com ydg: 1 							A \$432
							B \$441
							C \$468
							D \$506
							E \$541
							F \$580
							G \$626
							H \$695
							I \$717
							J \$776

To Order, Specify:

- ① Model Number
- ② Fabric Selection: vendor, pattern color
- ③ Other Product Options (see page FN9)

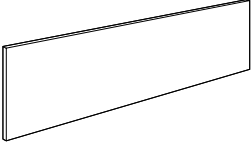
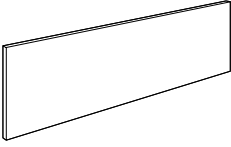
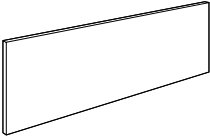
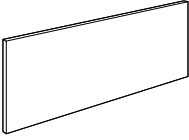
Description	D	W	H	CTN WT	CU FT	① Model	List Price Per Grade
84" w Wall Mount Tackboard for Overhead Cabinet with Cubbies 	1 ½	83 ¾	16 ½	3	3	FN84WTC	COM \$596 A \$720 B \$746 C \$820 D \$924 E \$1,019 F \$1,126 G \$1,254 H \$1,440 I \$1,496 J \$1,655
<ul style="list-style-type: none"> · fabrics available; visit www.jsifurniture.com/finishes-and-materials/textiles for our textiles program · com ydg: 2 ¾ 							
78" w Wall Mount Tackboard for Overhead Cabinet with Cubbies 	1 ½	77 ¾	16 ½	3	3	FN78WTC	COM \$590 A \$703 B \$727 C \$794 D \$889 E \$975 F \$1,073 G \$1,189 H \$1,358 I \$1,409 J \$1,554
<ul style="list-style-type: none"> · fabrics available; visit www.jsifurniture.com/finishes-and-materials/textiles for our textiles program · com ydg: 2 ½ 							
72" w Wall Mount Tackboard for Overhead Cabinet with Cubbies 	1 ½	71 ¾	16 ½	2	2	FN72WTC	COM \$561 A \$664 B \$685 C \$745 D \$830 E \$908 F \$996 G \$1,100 H \$1,253 I \$1,299 J \$1,430
<ul style="list-style-type: none"> · fabrics available; visit www.jsifurniture.com/finishes-and-materials/textiles for our textiles program · com ydg: 2 ¼ 							
66" w Wall Mount Tackboard for Overhead Cabinet with Cubbies 	1 ½	65 ¾	16 ½	2	2	FN66WTC	COM \$531 A \$621 B \$640 C \$694 D \$769 E \$839 F \$917 G \$1,010 H \$1,146 I \$1,187 J \$1,303
<ul style="list-style-type: none"> · fabrics available; visit www.jsifurniture.com/finishes-and-materials/textiles for our textiles program · com ydg: 2 							

FINALE

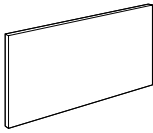
Description	D	W	H	CTN WT	CU FT	① Model	List Price Per Grade
42" w Wall Mount Tackboard for Overhead Cabinet with Cubbies 	1 ½	41 ¾	16 ½	2	2	FN42WTC	COM \$456 A \$524 B \$538 C \$578 D \$635 E \$687 F \$745 G \$815 H \$918 I \$949 J \$1,037
<ul style="list-style-type: none"> · fabrics available; visit www.jsifurniture.com/finishes-and-materials/textiles for our textiles program · com ydg: 1 ½ 							

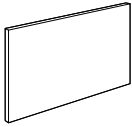
36" w Wall Mount Tackboard for Overhead Cabinet with Cubbies 	1 ½	35 ¾	16 ½	2	2	FN36WTC	COM \$417 A \$474 B \$486 C \$519 D \$567 E \$610 F \$659 G \$717 H \$802 I \$829 J \$903
<ul style="list-style-type: none"> · fabrics available; visit www.jsifurniture.com/finishes-and-materials/textiles for our textiles program · com ydg: 1 ¼ 							

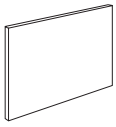
30" w Wall Mount Tackboard for Overhead Cabinet with Cubbies 	1 ½	29 ¾	16 ½	2	2	FN30WTC	COM \$387 A \$432 B \$441 C \$468 D \$506 E \$541 F \$580 G \$626 H \$695 I \$717 J \$776
<ul style="list-style-type: none"> · fabrics available; visit www.jsifurniture.com/finishes-and-materials/textiles for our textiles program · com ydg: 1 							

To Order, Specify:

- ① Model Number
- ② Fabric Selection: vendor, pattern color
- ③ Other Product Options (see page [FN9](#))

Description	D	W	H	CTN WT	CU FT	① Model	List Price
Double Height Open Storage Tower	15 $\frac{7}{8}$	18	54	126	12	FN1618DSO	\$1,922

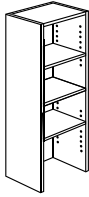

- fixed center shelf, two adjustable shelves
- one back panel grommet
- optional modular top, see page [FN64](#)
- cannot be wall mounted

Double Height Storage Tower with 54" h Door	15 $\frac{7}{8}$	18	54	145	12	FN1618SDR	\$2,076
	15 $\frac{7}{8}$	18	54	145	12	FN1618SDL	\$2,076

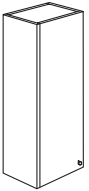

left shown

- one fixed shelf, two adjustable shelves
- one back panel grommet
- locking door available, specify and add \$147 list
- optional modular top, see page [FN64](#)
- pull knob
- cannot be wall mounted

Double Height Storage Tower with 54" h Glass Door	15 $\frac{7}{8}$	18	54	147	12	FN1618DGS DR	\$2,474
	15 $\frac{7}{8}$	18	54	147	12	FN1618DGS DL	\$2,474

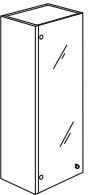

left shown

- white back painted glass doors
- one fixed shelf, two adjustable shelves
- one back panel grommet
- locking door not available
- optional modular top, see page [FN64](#)
- pull knob
- cannot be wall mounted

Description	D	W	H	CTN WT	CU FT	① Model	List Price
Double Height Open Storage Tower	15 ⁷ / ₈	35 ⁷ / ₈	54	175	23	FN1636DSO	\$1,997

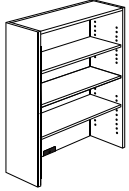

- fixed center shelf, two adjustable shelves
- one back panel grommet
- optional modular top, see page [FN64](#)
- not to be used with lateral file or storage cabinet
- to be used with credenza
- cannot be wall mounted

Double Height Storage Tower with 54" h Doors	15 ⁷ / ₈	35 ⁷ / ₈	54	210	23	FN1636DSD	\$3,286
-----------------------------------------------------	--------------------------------	--------------------------------	----	-----	----	------------------	----------------

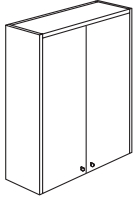

- one fixed shelf, two adjustable shelves
- one back panel grommet
- locking doors available, specify and add \$147 list
- optional modular top, see page [FN64](#)
- pull knob
- not to be used with lateral file or storage cabinet
- to be used with credenza
- cannot be wall mounted

Double Height Storage Tower with 54" h Glass Doors	15 ⁷ / ₈	35 ⁷ / ₈	54	212	23	FN1636DGSO	\$3,684
-----------------------------------------------------------	--------------------------------	--------------------------------	----	-----	----	-------------------	----------------

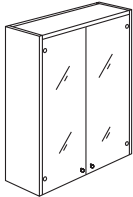

- white back painted glass doors
- one fixed shelf, two adjustable shelves
- one back panel grommet
- locking doors not available
- optional modular top, see page [FN64](#)
- pull knob
- not to be used with lateral file or storage cabinet
- to be used with credenza
- cannot be wall mounted

To Order, Specify:

- ① Model Number
- ② Finish Color - (see page [FN16](#))
- ③ Knob Color - (see page [FN16](#))
- ④ Other Product Options (see page [FN9](#))

Description	D	W	H	CTN WT	CU FT	① Model	List Price
-------------	---	---	---	-----------	----------	---------	------------

Open Storage Tower	16	18	42	98	10	FN1618SO	\$1,538
---------------------------	----	----	----	----	----	-----------------	----------------

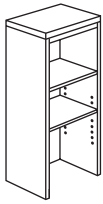

- top edge profile on user side
- fixed top shelf, one adjustable shelf
- one back panel grommet
- cannot be wall mounted

Storage Tower with 42" h Door	16	18	42	113	10	FN1618SDR	\$1,660
	16	18	42	113	10	FN1618SDL	\$1,660

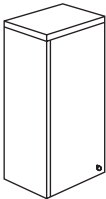

- top edge profile on user side
- one fixed shelf, one adjustable shelf
- one back panel grommet
- locking door available, specify and add \$147 list
- pull knob
- cannot be wall mounted

Storage Tower with 42" h Glass Door	16	18	42	114	10	FN1618GSDR	\$2,064
	16	18	42	114	10	FN1618GSDL	\$2,064

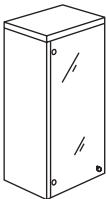

- top edge profile on user side
- white back painted glass doors
- one fixed shelf, one adjustable shelf
- one back panel grommet
- locking door not available
- pull knob
- cannot be wall mounted

Storage Tower	14	15 3/4	21	18	4	FN2116ST	\$1,405
----------------------	----	--------	----	----	---	-----------------	----------------

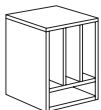

- veneer unit, not available in laminate
- paper management slots can be configured horizontally or with three vertical slots
- can be installed in storage tower or under storage overhead cabinet
- cannot be used with cubbies

Description	D	W	H	CTN WT	CU FT	① Model	List Price
Open Storage Tower	16	35 7/8	42	136	18	FN1636SO	\$1,599

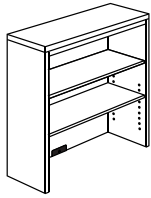

- top edge profile on user side
- fixed top shelf, one adjustable shelf
- one back panel grommet
- not to be used with lateral file or storage cabinet
- to be used with credenza
- cannot be wall mounted

Storage Tower with 42" h Doors	16	35 7/8	42	166	18	FN1636SD	\$2,631
--------------------------------	----	--------	----	-----	----	----------	---------

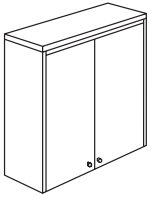

- top edge profile on user side
- one fixed shelf, one adjustable shelf
- one back panel grommet
- locking doors available, specify and add \$147 list
- pull knob
- not to be used with lateral file or storage cabinet
- to be used with credenza
- cannot be wall mounted

Storage Tower with 42" h Glass Doors	16	35 7/8	42	168	18	FN1636GSD	\$3,031
--------------------------------------	----	--------	----	-----	----	-----------	---------



- top edge profile on user side
- white back painted glass doors
- one fixed shelf, one adjustable shelf
- one back panel grommet
- locking doors not available
- pull knob
- not to be used with lateral file or storage cabinet
- to be used with credenza
- cannot be wall mounted

To Order, Specify:

- ① Model Number
- ② Finish Color - (see page [FN16](#))
- ③ Edge Profile - (see page [FN16](#))
- ④ Knob Color - (see page [FN16](#))
- ⑤ Other Product Options (see page [FN9](#))

Description	D	W	H	CTN WT	CU FT	① Model	List Price
Bookcase Overhead	16	35 $\frac{3}{8}$	42	100	18	FN1636B0	\$1,538



- top edge profile on user side
- one back panel grommet
- compatible with FN3630SC and FN3630LF; see pages [FN33](#) and [FN67](#)

Storage Tower	16	35 $\frac{3}{8}$	42	166	18	FN1636BD	\$2,502
----------------------	----	------------------	----	-----	----	-----------------	----------------

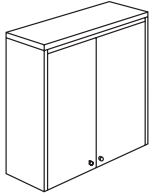

- top edge profile on user side
- one fixed shelf, one adjustable shelf
- one back panel grommet
- locking doors available, specify and add \$147 list
- pull knob
- compatible with FN3630SC and FN3630LF; see pages [FN33](#) and [FN67](#)

Glass Door Storage Tower	16	35 $\frac{3}{8}$	42	168	18	FN1636GBD	\$2,912
---------------------------------	----	------------------	----	-----	----	------------------	----------------



- top edge profile on user side
- white back painted glass doors
- one fixed shelf, one adjustable shelf
- one back panel grommet
- locking doors not available
- pull knob
- compatible with FN3630SC and FN3630LF; see pages [FN33](#) and [FN67](#)

Description	D	W	H	CTN WT	CU FT	① Model	List Price
Double Height Bridge Mount Open Overhead	15 7/8	35 3/4	31 1/2	108	13	FN1636DBMO	\$1,957
	15 7/8	29 3/4	31 1/2	99	12	FN1630DBMO	\$1,723

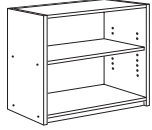

- supported by two storage towers
- adjustable shelf
- optional modular top, see page [FN64](#)
- cannot be wall mounted

Double Height Bridge Mount Overhead Cabinet with Two Doors	15 7/8	35 3/4	31 1/2	113	14	FN1636DBMS	\$2,822
	15 7/8	29 3/4	31 1/2	105	12	FN1630DBMS	\$2,633

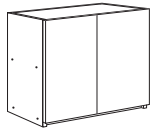

- supported by two storage towers
- adjustable shelf
- locking doors available, specify and add \$147 list
- optional modular top, see page [FN64](#)
- no pulls
- cannot be wall mounted

Double Height Bridge Mount Overhead Cabinet with Two Glass Doors	15 7/8	35 3/4	31 1/2	115	14	FN1636DGBMS	\$3,221
	15 7/8	29 3/4	31 1/2	107	12	FN1630DGBMS	\$3,035

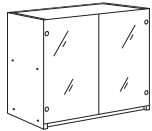

- white back painted glass doors
- supported by two storage towers
- adjustable shelf
- optional modular top, see page [FN64](#)
- locking doors not available
- pulls not available
- cannot be wall mounted

To Order, Specify:

- ① Model Number
- ② Finish Color - (see page [FN16](#))
- ③ Edge Profile - (see page [FN16](#))
- ④ Knob Color - (see page [FN16](#))
- ⑤ Other Product Options (see page [FN9](#))

Description	D	W	H	CTN WT	CU FT	① Model	List Price
Double Height Bridge Mount Open Overhead with Cubbies	15 7/8	35 3/4	36 1/2	128	14	FN1636DBMOC	\$2,391
	15 7/8	29 3/4	36 1/2	119	12	FN1630DBMOC	\$2,086



- supported by two storage towers
- adjustable shelf
- optional modular top, see page [FN64](#)
- cannot be wall mounted

Double Height Bridge Mount Overhead Cabinet with Two Doors and Cubbies	15 7/8	35 3/4	36 1/2	136	16	FN1636DBMSC	\$3,256
	15 7/8	29 3/4	36 1/2	127	13	FN1630DBMSC	\$2,995



- supported by two storage towers
- adjustable shelf
- locking doors available, specify and add \$147 list
- optional modular top, see page [FN64](#)
- no pulls
- cannot be wall mounted

Double Height Bridge Mount Overhead Cabinet with Two Glass Doors and Cubbies	15 7/8	35 3/4	36 1/2	143	16	FN1636DGBMSC	\$3,657
	15 7/8	29 3/4	36 1/2	134	13	FN1630DGBMSC	\$3,470

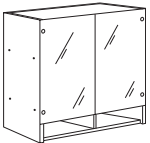

- white back painted glass doors
- supported by two storage towers
- adjustable shelf
- optional modular top, see page [FN64](#)
- locking doors not available
- pulls not available
- cannot be wall mounted

Description	D	W	H	CTN WT	CU FT	① Model	List Price
Bridge Mount Open Overhead	16	35 ¾	19 ½	80	9	FN1636BMO	\$1,569
	16	29 ¾	19 ½	65	8	FN1630BMO	\$1,381



- top edge profile on user side
- supported by two storage towers
- cannot be wall mounted

Bridge Mount Overhead Cabinet with Two Doors	16	35 ¾	19 ½	85	9	FN1636BMS	\$2,260
	16	29 ¾	19 ½	70	8	FN1630BMS	\$2,107

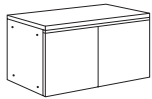

- top edge profile on user side
- supported by two storage towers
- locking doors available, specify and add \$147 list
- no pulls
- cannot be wall mounted

Bridge Mount Overhead Cabinet with Two Glass Doors	16	35 ¾	19 ½	86	9	FN1636GBMS	\$2,658
	16	29 ¾	19 ½	72	8	FN1630GBMS	\$2,506



- top edge profile on user side
- white back painted glass doors
- supported by two storage towers
- locking doors not available
- pulls not available
- cannot be wall mounted

To Order, Specify:

- ① Model Number
- ② Finish Color - (see page [FN16](#))
- ③ Knob Color - (see page [FN16](#))
- ④ Other Product Options (see page [FN9](#))

Description	D	W	H	CTN WT	CU FT	① Model	List Price
Bridge Mount Open Overhead with Cubbies	16	35 ¾	24 ½	102	11	FN1636BMOC	\$2,006
	16	29 ¾	24 ½	86	9	FN1630BMOC	\$1,744



- top edge profile on user side
- supported by two storage towers
- cannot be wall mounted

Bridge Mount Overhead Cabinet with Two Doors and Cubbies	16	35 ¾	24 ½	108	11	FN1636BMSC	\$2,693
	16	29 ¾	24 ½	92	9	FN1630BMSC	\$2,469



- top edge profile on user side
- supported by two storage towers
- locking doors available, specify and add \$147 list
- no pulls
- cannot be wall mounted

Bridge Mount Overhead Cabinet with Two Glass Doors and Cubbies	16	35 ¾	24 ½	112	11	FN1636GBMSC	\$3,090
	16	29 ¾	24 ½	96	9	FN1630GBMSC	\$2,943



- top edge profile on user side
- white back painted glass doors
- supported by two storage towers
- locking doors not available
- pulls not available
- cannot be wall mounted

Modular Cabinet Top	D	W	H	CTN WT	CU FT	Model	List Price
	16	83 ¾	1 ¾	94	6	FN1684MCT	\$2,197
	16	77 ¾	1 ¾	85	5	FN1678MCT	\$2,144
	16	71 ¾	1 ¾	76	5	FN1672MCT	\$2,088
	16	65 ¾	1 ¾	63	5	FN1666MCT	\$1,979
	16	41 ¾	1 ¾	40	3	FN1642MCT	\$1,438
	16	35 ¾	1 ¾	35	3	FN1636MCT	\$1,362
	16	29 ¾	1 ¾	29	3	FN1630MCT	\$1,303
	16	17 15/16	1 ¾	18	2	FN1618MCT	\$1,249

- top edge profile on user side
- field installed
- to be used with double height units only

Description	D	W	H	CTN WT	CU FT	① Model	List Price
Transaction Counter for U Unit	13	89 ¾	17 ¾	115	41	FN13186TC coordinates with FN2472RCR, FN2472LCR, and FN2442EB	\$2,858

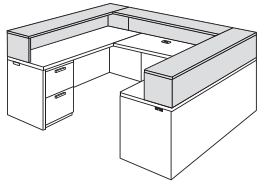

- for U units
- 16" vertical clearance from desk to bottom of transaction top

Transaction Counter for L Unit	13	65 ¾	17 ¾	100	20	FN13114RTC coordinates with FN3066LD and FN2448ERR	\$2,325
---------------------------------------	----	------	------	-----	----	-----------------------------------------------------------------	---------

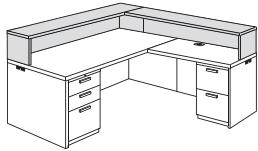

right shown

	13	65 ¾	17 ¾	100	20	FN13114LTC coordinates with FN3066RD and FN2448ELR	\$2,325
--	----	------	------	-----	----	-----------------------------------------------------------------	---------

- for L units
- 16" vertical clearance from desk to bottom of transaction top

Transaction Counter	13	71 ¾	17 ¾	87	12	FN1372TC coordinates with a 71 ¾" surface	\$1,781
----------------------------	----	------	------	----	----	-----------------------------------------------------	---------

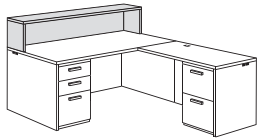

	13	65 ¾	17 ¾	79	11	FN1366TC coordinates with a 65 ¾" surface	\$1,709
--	----	------	------	----	----	-----------------------------------------------------	---------

- 16" vertical clearance from desk to bottom of transaction top

To Order, Specify:

- ① Model Number
- ② Finish Color - (see page [FN16](#))
- ③ Knob Color - (see page [FN16](#))
- ④ Other Product Options (see page [FN9](#))

Description	D	W	H	CTN WT	CU FT	① Model	List Price
Bookcase	15 7/8	36	82 3/4	180	35	FN3684BC	\$3,514

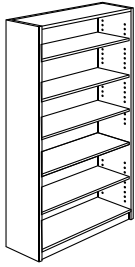

- one fixed shelf
- four adjustable shelves
- we recommend this product be mounted to the floor or wall
- optional modular top, see page [FN64](#)

Bookcase	16	36	72	150	30	FN3672BC	\$2,928
----------	----	----	----	-----	----	----------	---------

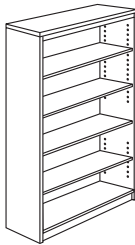

- top edge profile on user side
- one fixed shelf
- three adjustable shelves

Bookcase	16	36	54	125	23	FN3654BC	\$2,270
----------	----	----	----	-----	----	----------	---------

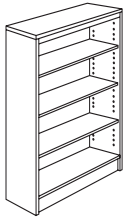

- top edge profile on user side
- three adjustable shelves

Bookcase	16	36	42	105	18	FN3642BC	\$1,932
----------	----	----	----	-----	----	----------	---------



- top edge profile on user side
- two adjustable shelves

Bookcase	16	36	30	85	13	FN3630BC	\$1,614
----------	----	----	----	----	----	----------	---------

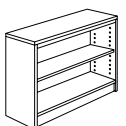

- top edge profile on user side
- one adjustable shelf

Description	D	W	H	CTN WT	CU FT	① Model	List Price
Lateral File	24	35 ³ / ₈	54	300	32	FN3654LF	\$4,542



- top edge profile on user side
- four drawers
- anti-tip interlock mechanism
- central locking

Lateral File	24	35 ³ / ₈	42	260	25	FN3642LF	\$3,707
---------------------	----	--------------------------------	----	-----	----	-----------------	----------------



- top edge profile on user side
- three drawers
- anti-tip interlock mechanism
- central locking

Lateral File	24	35 ³ / ₈	30	175	19	FN3630LF	\$2,997
---------------------	----	--------------------------------	----	-----	----	-----------------	----------------

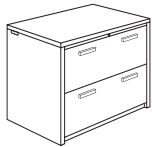

- top edge profile on user side
- two drawers
- anti-tip interlock mechanism
- central locking
- two end panel grommets with wire pass thru
- for overhead bookcases and cabinets; see page [FN60](#)

Mobile Pedestal	22	18 ¹ / ₁₆	28 ¹ / ₄	95	9	FN1820MP	\$2,580
------------------------	----	---------------------------------	--------------------------------	----	---	-----------------	----------------



- box/box/file only
- legal width pedestal
- pedestal locking
- casters

To Order, Specify:

- ① Model Number
- ② Finish Color - (see page [FN16](#))
- ③ Knob Color - (see page [FN16](#))
- ④ Other Product Options (see page [FN9](#))

Description	D	W	H	CTN WT	CU FT	① Model	List Price
84" h Wardrobe	23 $\frac{7}{8}$	35 $\frac{3}{8}$	84	335	50	FN3684W	\$5,591

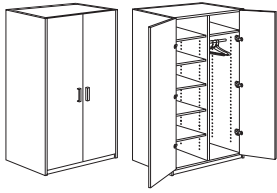

- chrome hanging bar on right
- one fixed shelf second from bottom on left
- locking doors available; specify and add \$294 list
- optional modular top, see page [FN67](#)

72" h Wardrobe	24	35 $\frac{3}{8}$	72	360	41	FN3672W	\$4,660
-----------------------	----	------------------	----	-----	----	----------------	----------------

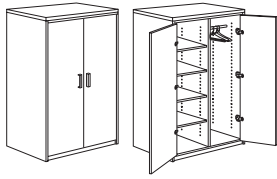

- top edge profile on user side
- chrome hanging bar on right
- one fixed shelf second from bottom on left
- locking doors available; specify and add \$294 list

Hanging Bar to Shelves Conversion Kit	24	18	$\frac{3}{4}$	56	2	FN1824SK	\$1,069
--------------------------------------------------	----	----	---------------	----	---	-----------------	----------------

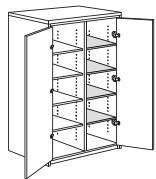

- four shelves
- for 36" wide wardrobe

Description	D	W	H	CTN WT	CU FT	① Model	List Price
84" h Wardrobe	23 7/8	17 3/4	84	260	25	FN1884WR	\$4,684
	23 7/8	17 3/4	84	260	25	FN1884WL	\$4,684

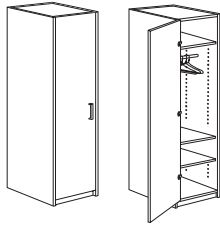

left shown

- chrome hanging bar at top
- one fixed shelf 26 1/2" from cabinet floor
- one adjustable shelf
- locking door available; specify and add \$147 list
- optional modular top, see page [FN64](#)

72" h Wardrobe	24	18	72	233	23	FN1872WR	\$3,902
	24	18	72	233	23	FN1872WL	\$3,902

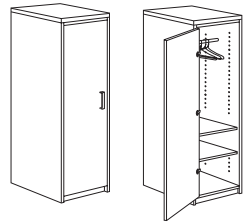

left shown

- top edge profile on user side
- chrome hanging bar at top
- one fixed shelf 26 1/2" from cabinet floor
- one adjustable shelf
- locking door available; specify and add \$147 list

Hanging Bar to Shelves Conversion Kit	24	16	3/4	50	2	FN1624SK	\$846
---------------------------------------	----	----	-----	----	---	----------	-------

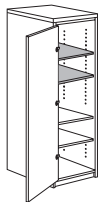

- two shelves
- for 18" wide wardrobe

To Order, Specify:

- ① Model Number
- ② Finish Color - (see page [FN16](#))
- ③ Edge Profile - (see page [FN16](#))
- ④ Pull Style and Color - (see page [FN16](#))
- ⑤ Other Product Options (see page [FN9](#))
- ⑥ Accessories, Power and Data Options (see [accessories price list](#))

Description	D	W	H	CTN WT	CU FT	① Model	List Price
84" h File/File Lateral Storage Cabinet	23 $\frac{7}{8}$	35 $\frac{3}{8}$	84	370	50	FN3684SWLF	\$7,212

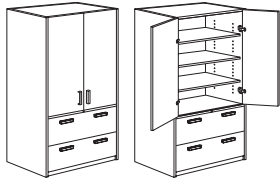

- three adjustable shelves
- locking doors available; specify and add \$147 list
- file/file lateral
- pedestal locking
- optional modular top, see page [FN67](#)

72" h File/File Lateral Storage Cabinet	24	35 $\frac{3}{8}$	72	360	43	FN3672SWLF	\$6,011
------------------------------------------------	----	------------------	----	-----	----	-------------------	----------------

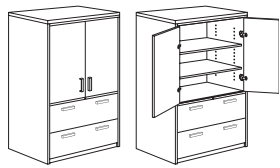

- two adjustable shelves
- locking doors available; specify and add \$147 list
- top edge profile on user side only
- file/file lateral
- pedestal locking

84" h File/File Storage Wardrobe	23 $\frac{7}{8}$	23 $\frac{5}{8}$	84	315	34	FN2484SWR	\$5,266
	23 $\frac{7}{8}$	23 $\frac{5}{8}$	84	315	34	FN2484SWL	\$5,266

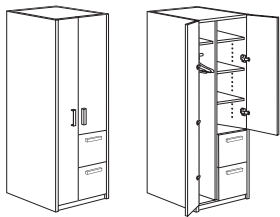

left shown

- chrome hanging bar
- three adjustable shelves
- file/file pedestal
- locking not available
- optional modular top, see page [FN67](#)

72" h File/File Storage Wardrobe	24	23 $\frac{5}{8}$	72	340	29	FN2472SWR	\$4,388
	24	23 $\frac{5}{8}$	72	340	29	FN2472SWL	\$4,388

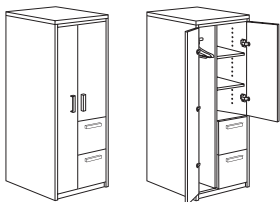

left shown

- top edge profile on user side
- chrome hanging bar
- two adjustable shelves
- file/file pedestal
- locking not available

Description	D	W	H	CTN WT	CU FT	① Model	List Price
Modular Wardrobe Top 	24	35 ³ / ₈	1 ³ / ₁₆	38	3	FN2436MTC coordinates with: FN3684W and FN3684SWLF	\$860
	24	23 ³ / ₈	1 ³ / ₁₆	28	2	FN2424MTC coordinates with: FN2484SWL and FN2484SWR	\$768
	24	17 ⁷ / ₈	1 ³ / ₁₆	21	2	FN2418MTC coordinates with: FN1884WL and FN1884WR	\$719

- top edge profile on user side
- field installed
- to be used with 84" height wardrobe units only

To Order, Specify:

- ① Model Number
- ② Finish Color - (see page [FN16](#))
- ③ Glass Surface - Clear or White Back Painted - (see page [FN16](#))
- ④ Metal Color - (see page [FN16](#))
- ⑤ Edge Profile - (see page [FN16](#))
- ⑥ Other Product Options (see page [FN9](#))

Description	D	W	H	CTN WT	CU FT	① Model	List Price
42" dia. Round Magazine Table	42	42	16			FN42MTD	\$3,133

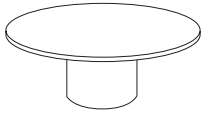

Consists of:

				56	5	FN42TT - Table Top	\$1,868
				68	5	FN18-16RB - Round Base	\$1,265

· ships KD in two cartons

36" dia. Round Magazine Table	36	36	16			FN36MTD	\$2,910
-------------------------------	----	----	----	--	--	----------------	----------------

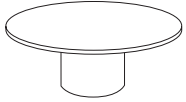

Consists of:

				42	4	FN36TT - Table Top	\$1,645
				68	5	FN18-16RB - Round Base	\$1,265

· ships KD in two cartons

Description	D	W	H	CTN WT	CU FT	① Model	List Price
Corner Table	36	36	17	79	5	FN3636CT	\$1,477



· ships KD in one carton

Sofa Table	18	60	30	66	4	FN1860ST	\$1,501
------------	----	----	----	----	---	----------	---------

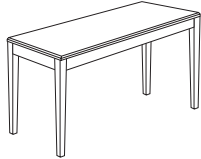

· ships KD in one carton

Magazine Table	20	42	16	51	4	FN2042MT	\$1,268
----------------	----	----	----	----	---	----------	---------

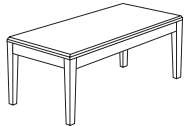

· ships KD in one carton

End Table	24	24	20	35	3	FN2424ET	\$1,072
-----------	----	----	----	----	---	----------	---------

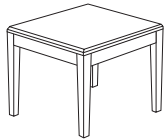

· ships KD in one carton

End Table	20	28	20	35	3	FN2028ET	\$1,069
-----------	----	----	----	----	---	----------	---------

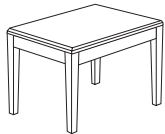

· ships KD in one carton

To Order, Specify:

- ① Model Number
- ② Finish Color - (see page [FN16](#))
- ③ Edge Profile - (see page [FN16](#))
- ④ Knob Color - (see page [FN16](#))
- ⑤ Other Product Options (see page [FN9](#))

Description	D	W	H	CTN WT	CU FT	① Model	List Price
-------------	---	---	---	-----------	----------	---------	------------

Metal Frame End Table with Glass Top

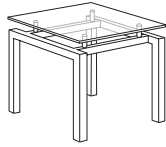

- metal 1 1/2" square tube frame - specify metal color option: Black Sandtex (BSX), Soft Nickel (SNK) or Stardust Silver (STS)
- clear glass or white back painted glass top
- glass top crated for shipment
- 1/2" tempered glass top
- field assembly of glass top to metal base frame

Metal Frame End Table with Veneer Top

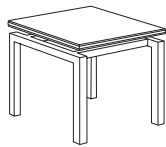

- metal 1 1/2" square tube frame - specify metal color option: Black Sandtex (BSX), Soft Nickel (SNK) or Stardust Silver (STS)
- black support for veneer top
- finish and edge profile must be specified
- field assembly of veneer top to metal base frame

Metal Frame End Table for COM Top

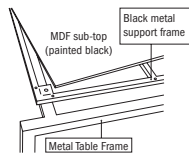
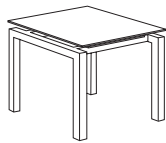

- includes: table frame, black metal support and black MDF sub top
- CUSTOMER MUST SUPPLY WORK SURFACE AND INSTALLATION AT FINAL DESTINATION
- metal 1 1/2" square tube frame - specify metal color option: Black Sandtex (BSX), Soft Nickel (SNK) or Stardust Silver (STS)
- black support for COM top
- field assembly of COM top support to metal base frame

	24	24	20	51	10	FN2424V-20	\$3,079
--	----	----	----	----	----	-------------------	----------------

	24	24	20	51	10	FN2424X-20	\$3,045
--	----	----	----	----	----	-------------------	----------------

Description	D	W	H	CTN WT	CU FT	① Model	List Price
-------------	---	---	---	-----------	----------	---------	------------

Metal Frame Magazine Table with Glass Top

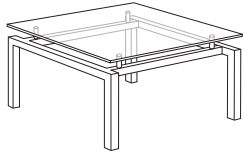

- metal 1 1/2" square tube frame - specify metal color option: Black Sandtex (BSX), Soft Nickel (SNK) or Stardust Silver (STS)
- clear glass or white back painted glass top
- glass top crated for shipment
- 1/2" tempered glass top
- field assembly of glass top to metal base frame

Metal Frame Magazine Table with Veneer Top

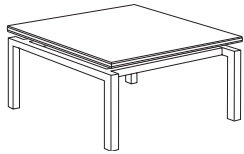

- metal 1 1/2" square tube frame - specify metal color option: Black Sandtex (BSX), Soft Nickel (SNK) or Stardust Silver (STS)
- black support for veneer top
- finish and edge profile must be specified
- field assembly of veneer top to metal base frame

Metal Frame Magazine Table for COM Top

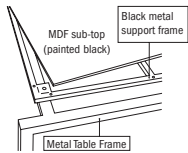
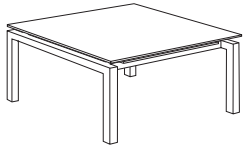

- includes: table frame, black metal support and black MDF sub top
- CUSTOMER MUST SUPPLY WORK SURFACE AND INSTALLATION AT FINAL DESTINATION
- metal 1 1/2" square tube frame - specify metal color option: Black Sandtex (BSX), Soft Nickel (SNK) or Stardust Silver (STS)
- black support for COM top
- field assembly of COM top support to metal base frame

To Order, Specify:

- ① Model Number
- ② Finish Color - (see page [FN16](#))
- ③ Glass Surface - Clear or White Back Painted - (see page [FN16](#))
- ④ Metal Color - (see page [FN16](#))
- ⑤ Edge Profile - (see page [FN16](#))
- ⑥ Other Product Options (see page [FN9](#))

Description	D	W	H	CTN WT	CU FT	① Model	List Price
Metal Frame Magazine Table with Glass Top	24	48	17	81	15	FN2448G-17	\$3,635

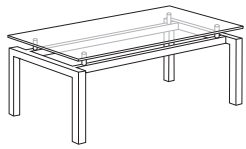

- metal 1 1/2" square tube frame - specify metal color option: Black Sandtex (BSX), Soft Nickel (SNK) or Stardust Silver (STS)
- clear glass or white back painted glass top
- glass top crated for shipment
- 1/2" tempered glass top
- field assembly of glass top to metal base frame

Metal Frame Magazine Table with Veneer Top	24	48	17	81	15	FN2448V-17	\$3,597
---------------------------------------------------	----	----	----	----	----	-------------------	----------------

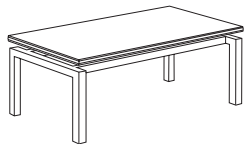

- metal 1 1/2" square tube frame - specify metal color option: Black Sandtex (BSX), Soft Nickel (SNK) or Stardust Silver (STS)
- black support for veneer top
- finish and edge profile must be specified
- field assembly of veneer top to metal base frame

Metal Frame Magazine Table for COM Top	24	48	17	81	15	FN2448X-17	\$3,561
-----------------------------------------------	----	----	----	----	----	-------------------	----------------

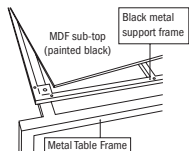
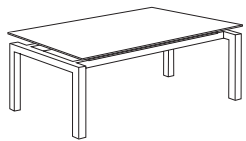

- includes: table frame, black metal support and black MDF sub top
- CUSTOMER MUST SUPPLY WORK SURFACE AND INSTALLATION AT FINAL DESTINATION
- metal 1 1/2" square tube frame - specify metal color option: Black Sandtex (BSX), Soft Nickel (SNK) or Stardust Silver (STS)
- black support for COM top
- field assembly of COM top support to metal base frame

Center Drawer	16	25	3	12	2	FN1825CD	\$525
----------------------	----	----	---	----	---	-----------------	--------------

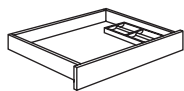

- non-locking

o Order, Specify:

- ① Model Number
- ② Finish Color - (see page [FN16](#))
- ③ Glass Surface - Clear or White Back Painted - (see page [FN16](#))
- ④ Metal Color - (see page [FN16](#))
- ⑤ Edge Profile - (see page [FN16](#))
- ⑥ Other Product Options (see page [FN9](#))

Finale Product Information



FINALE

Finale Product Information

Exterior Wood Materials

Exterior surfaces are made from the finest selected veneers to achieve clarity and consistency in the Finale product line. To attain a pleasing, symmetrical pattern, all veneers in Finale are book-matched. All exterior solid lumber is matched to coordinate with the veneer.

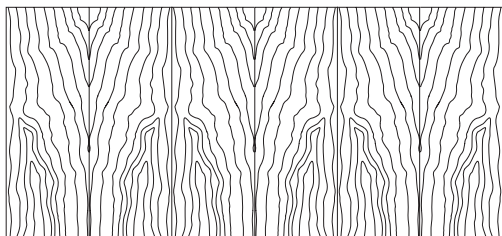

Book Matched Example

Alternating pieces of veneer are flipped over so they face each other like the pages within a book.

Finale is available in flat cut cherry, maple and walnut veneer. A wide range of wood stains have been formulated to enhance the beauty of the veneer.

Solid painted finishes on the veneer are also offered to provide an accent to the Finale product.

Work Surface Construction

Tops are 5-ply balanced construction, 1 3/16" thick with solid matching hardwood edges. Tops are available in six edge profile.

Matching or coordinating high pressure laminate in a veneer grain can be applied to the top surface and is available at no additional charge.

Base Construction

Panels are joined together by mortise and tenon construction. In addition to mortise and tenon joint construction. Leveling glides are set into solid hardwood with t-nut inserts, which helps to prevent the leveling glide from tear out. Tops are secured to the bases with top fastening cleats screwed to the inside of the panels.

Drawers

The 9ply unidirectional hardwood sides of the drawer box are 7/16" thick assembled with English dovetail construction at each corner of the box. The drawer bottom panel is 1/4" thick fitting into a groove machined into the side of the box. Interiors are sanded and coated with clear U.V. finish to protect against shrinking, swelling or warping, and to provide a clean, smooth feel and appearance.

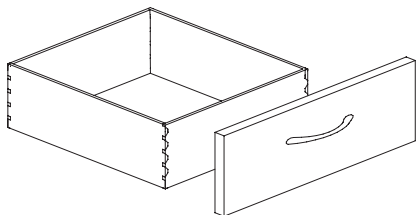

Drawer Suspension

The high quality black drawer suspensions carry a lifetime warranty. Slides feature steel ball bearings for longer life with cushioned in/out stops. File and box drawers have 100% full extension with over travel.

Finish - Stain/Colors

We offer a variety of wood stains and paint colors on Finale. Please see the chart below. Samples are available upon request.

ESS Essentials Veneer Collection

BRK	Brickdust	OBK	Outback
CSK	Cask	PIL	Pilsner
CLY	Clay	SIE	Sienna
FLX	Flax	TRF	Truffle
MES	Mesa	UMB	Umber
MCH	Mocha		

Protective Top Coat

DuraTex™ offers exceptional hardness along with abrasion and impact resistance, it has been formulated to eliminate hazardous and harmful gases that are normally associated with wood finish.

DuraTex™ Features

Safety - Significantly reduces hazardous formaldehyde emissions, which help improve the quality of the of the indoor air we breathe.

Quality - Developed to be tough and durable with special attention to appearance. The DuraTex™ finish preserves the natural beauty of wood.

Durability - Designed to meet a wide range of demanding performance and environmental standards to withstand even the highest wear and tear.

Finale Product Information

Product Modification

Laminate Tops

Worksurface only, no additional upcharge if coordinating wood grain laminate is specified. Contact Customer Service for any other laminate request. Listed below are finishes that have coordinating wood grain HPL laminates.

ESS Essentials Veneer with Laminate Top

BRK	Brickdust	MCH	Mocha
CSK	Cask	OBK	Outback
CLY	Clay	UMB	Umber
MES	Mesa		

Special Finishes

Special finishes can be requested by following the instruction in the general introduction section, page 5. There is a one time charge of \$384 list per order.

Finish Sheen

All veneer finishes for Finale are standard in 35-sheen. All other finishes can have their sheen modified with a 15% upcharge added to the list price of each item.

Finale Product Information

Top Edge Details

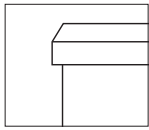

Bevel (B)

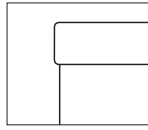

Eased (R4)

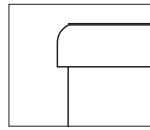

Gael (G)

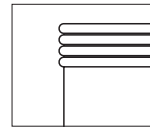

Reeded (H)

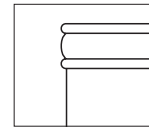

Transitional (C)

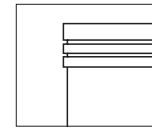

Triad (F)

Drawer Style Color Options

Finish Color MBK = Matte Black MNK = Matte Nickel MSL = Matte Silver



Arch
(MBK or MSL)

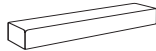

Block
(MNK)



Curve
(MNK)



Twist
(MNK)

Top Shapes - size - base requirement - seating capacity

top sizes 108" through 192" are 2 pieces

top sizes above 192" are 3 pieces

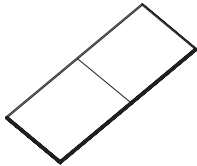

rectangular

264" x 60"	4 bases	seats 24
240" x 60"	4 bases	seats 22
216" x 60"	4 bases	seats 20
192" x 60"	3 bases	seats 18
264" x 54"	4 bases	seats 22
240" x 54"	4 bases	seats 20
216" x 54"	4 bases	seats 18
192" x 54"	3 bases	seats 16
264" x 48"	4 bases	seats 22
240" x 48"	4 bases	seats 20
216" x 48"	4 bases	seats 18
192" x 48"	3 bases	seats 16
168" x 48"	3 bases	seats 14
144" x 48"	3 bases	seats 12
120" x 48"	2-3* bases	seats 8
120" x 42"	2-3* bases	seats 8
108" x 42"	2 bases	seats 8
96" x 48"	2 bases	seats 8
96" x 42"	2 bases	seats 8
84" x 42"	2 bases	seats 8
72" x 36"	2 bases	seats 6



racetrack

264" x 60"	4 bases	seats 24
240" x 60"	4 bases	seats 22
216" x 60"	4 bases	seats 20
192" x 60"	3 bases	seats 18
264" x 54"	4 bases	seats 22
240" x 54"	4 bases	seats 20
216" x 54"	4 bases	seats 18
192" x 54"	3 bases	seats 16
264" x 48"	4 bases	seats 22
240" x 48"	4 bases	seats 20
216" x 48"	4 bases	seats 18
192" x 48"	3 bases	seats 16
168" x 48"	3 bases	seats 14
144" x 48"	3 bases	seats 12
120" x 48"	2-3* bases	seats 8
120" x 42"	2-3* bases	seats 8
108" x 42"	2 bases	seats 8
96" x 48"	2 bases	seats 8
96" x 42"	2 bases	seats 8
84" x 42"	2 bases	seats 8
72" x 36"	2 bases	seats 6

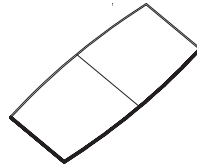

boat

264" x 60"	4 bases	seats 24
240" x 60"	4 bases	seats 22
216" x 60"	4 bases	seats 20
192" x 60"	3 bases	seats 18
264" x 54"	4 bases	seats 22
240" x 54"	4 bases	seats 20
216" x 54"	4 bases	seats 18
192" x 54"	3 bases	seats 16
264" x 48"	4 bases	seats 22
240" x 48"	4 bases	seats 20
216" x 48"	4 bases	seats 18
192" x 48"	3 bases	seats 16
168" x 48"	3 bases	seats 14
144" x 48"	3 bases	seats 12
120" x 48"	2-3* bases	seats 8
120" x 42"	2-3* bases	seats 8
108" x 42"	2 bases	seats 8
96" x 48"	2 bases	seats 8
96" x 42"	2 bases	seats 8
84" x 42"	2 bases	seats 8
72" x 36"	2 bases	seats 6



round*

60" dia.	Seats 6
54" dia.	Seats 6
48" dia.	Seats 4
42" dia.	Seats 4
36" dia.	Seats 4

*requires 1 base

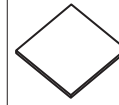

square*

60" sq.	seats 8
54" sq.	seats 6
48" sq.	seats 4
42" sq.	seats 4
36" sq.	seats 4
30" sq.	seats 4

*requires 1 base

* When ordering bases for 120" x 48" and 120" x 42" size tops, three (3) bases are required for Panel and Rectangle bases, two (2) bases are required for all other.

Base (units with access panel in the base for wire management are available, order this feature with the appropriate model number.)

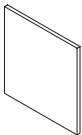

panel base
30" and 24" width

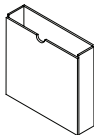

rectangle base
30" and 24" width

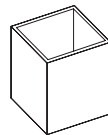

square base
24" and 18" width

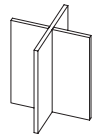

cross base
24" and 18" width



round base
24", 20" and 18" dia.

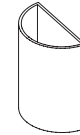

half-round base
24", 20 and 18" dia.

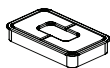

Worksurface Grommet

Additional worksurface grommets can be specified on veneer/laminate worksurfaces. The grommet location must be approved by JSI manufacturing, contact Customer Service. Add \$118 to the list for each additional grommet.

Grommet color must be specified, select Matte Black or Stardust Silver. Lock cores will match grommet color Matte Black (MBK) or Stardust Silver (STS).



End/Back Panel Grommet

The end/back panel grommets are standard, for any special consideration contact Customer Service.

Finale Product Information

Finish and Product Reference Codes

Select	Code	Select	Code	Select	Code
Essentials Veneer Collection		Top Edge Details		Metal Finish <i>(grommet)</i>	
Brickdust	BRK	Bevel	B	Matte Black	MBK
Cask	CSK	Eased	R4	Stardust Silver	STS
Clay	CLY	Gael	G		
Flax	FLX	Reeded	H		
Mesa	MES	Transitional	C		
Mocha	MCH	Triad	F		
Outback	OBK				
Pilsner	PIL				
Sienna	SIE	Pull & Finish Codes			
Truffle	TRF	Arch - Matte Black	MBK		
Umber	UMB	Arch - Matte Silver	MSL		
		Block - Matte Nickel	MNK		
		Curve - Matte Nickel	MNK		
		Twist - Matte Nickel	MNK		
Essentials Veneer with Laminate Top					
Brickdust	BRK				
Cask	CSK				
Clay	CLY				
Mesa	MES				
Mocha	MCH				
Outback	OBK				
Umber	UMB				

Order Check List:

Specify:

- 1. Model Number
- 2. Finish
- 3. Top Options - standard veneer - laminate surface (see page [FN79](#))
- 4. Other Product Options
- 5 Power and Data Accessories (*drawing showing location and orientation must accompany order*)
- 6. Side Mark Information (*i.e. room number, East Conference Room*)
- 7. Shipping Address (*contact name and phone number*)
- 8. Special Delivery Instructions (*i.e. call before delivery, deliver to job site*)

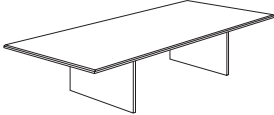
Description	D	W	H	CTN WT	CU FT	① Model	List Price	
Conference Table	42	96	30			FN4296CTP	\$6,643	
						Consists of:		
						172	15	FN4296TT - Table Top
					54 ea.	4 ea.	FN2428PB - Panel Bases	\$884 ea.
<ul style="list-style-type: none"> · ships KD in four cartons · one piece top · price reflects two bases · price includes one FN0655SP stretcher panel · must order (2) panel bases 								

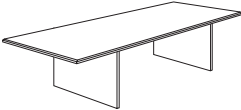
Conference Table	36	72	30			FN3672CTP	\$4,905	
						Consists of:		
						110	10	FN3672TT - Table Top
					54 ea.	4 ea.	FN2428PB - Panel Bases	\$884 ea
<ul style="list-style-type: none"> · ships KD in four cartons · one piece top · price reflects two bases · price includes one FN0631SP stretcher panel · must order (2) panel bases 								

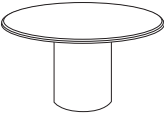
Description	D	W	H	CTN WT	CU FT	❶ Model	List Price
Round Conference Table	48	48	30			FN48CTD	\$3,797
						Consists of:	
						FN48TT - Table Top	\$2,444
						FN20RB - Round Base	\$1,353

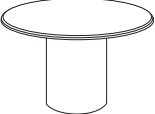

· ships KD in two cartons

Round Conference Table	42	42	30			FN42CTD	\$3,221
						Consists of:	
						FN42TT - Table Top	\$1,868
						FN20RB - Round Base	\$1,353

· ships KD in two cartons

To Order, Specify:

- ❶ Model Number
- ❷ Finish Color
 - A Work Surface
 - B. Chassis
- ❸ Edge Profile
- ❹ Power and Data Options (see [accessories price list](#))
- ❺ Other Product Options

Description	① Model	W	L	Seat Capacity	Top Pieces	Bases Required	CTN WT	CU FT	List Price
Rectangular Tops 	FN60264TT	60	264	24	3	4	673	57	\$20,569
	FN60240TT	60	240	22	3	4	613	51	\$18,700
	FN60216TT	60	216	20	3	4	552	48	\$16,836
	FN60192TT	60	192	18	2	3	490	42	\$14,960
	FN54264TT	54	264	22	3	4	609	52	\$17,144
	FN54240TT	54	240	20	3	4	554	50	\$15,585
	FN54216TT	54	216	18	3	4	498	43	\$14,031
	FN54192TT	54	192	16	2	3	441	38	\$12,470
	FN48264TT	48	264	22	3	4	548	47	\$15,244
	FN48240TT	48	240	20	3	4	498	43	\$13,859
	FN48216TT	48	216	18	3	4	447	38	\$12,470
	FN48192TT	48	192	16	2	3	396	33	\$11,088
	FN48168TT	48	168	14	2	3	346	30	\$9,702
	FN48144TT	48	144	12	2	3	296	28	\$8,318
	FN48120TT**	48	120	8	2	2-3**	245	22	\$6,935
	FN4896TT	48	96	8	1	2	197	17	\$5,571
	FN42120TT**	42	120	8	2	2-3**	217	19	\$6,068
	FN42108TT	42	108	8	2	2	195	17	\$5,465
	FN4296TT	42	96	8	1	2	172	15	\$4,875
FN4284TT	42	84	8	1	2	151	13	\$4,244	
FN3672TT	36	72	6	1	2	110	10	\$3,137	
Racetrack Tops 	FN60264RT	60	264	24	3	4	646	57	\$24,308
	FN60240RT	60	240	22	3	4	589	51	\$22,098
	FN60216RT	60	216	20	3	4	530	48	\$19,893
	FN60192RT	60	192	18	2	3	471	42	\$17,684
	FN54264RT	54	264	22	3	4	586	52	\$20,256
	FN54240RT	54	240	20	3	4	530	50	\$18,418
	FN54216RT	54	216	18	3	4	474	43	\$16,577
	FN54192RT	54	192	16	2	3	417	38	\$14,736
	FN48264RT	48	264	22	3	4	529	47	\$18,007
	FN48240RT	48	240	20	3	4	479	43	\$16,373
	FN48216RT	48	216	18	3	4	428	38	\$14,736
	FN48192RT	48	192	16	2	3	377	33	\$13,099
	FN48168RT	48	168	14	2	3	327	30	\$11,324
	FN48144RT	48	144	12	2	3	277	28	\$9,828
	FN48120RT**	48	120	8	2	2-3**	226	22	\$8,197
	FN4896RT	48	96	8	1	2	185	17	\$6,559
	FN42120RT**	42	120	8	2	2-3**	203	19	\$7,170
	FN42108RT	42	108	8	2	2	180	17	\$6,453
	FN4296RT	42	96	8	1	2	157	15	\$5,736
FN4284RT	42	84	8	1	2	142	13	\$5,043	
FN3672RT	36	72	6	1	2	100	10	\$3,696	

**When ordering RECTANGLE or PANEL BASES - FN48120 and FN42120 require (3) panel bases and additional stretchers. Stretchers will be included as required.

**When ordering RECTANGLE or PANEL BASES - FN48120 and FN42120 require (3) panel bases and additional stretchers. Stretchers will be included as required.

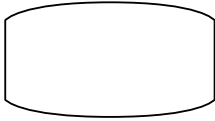
Description	① Model	W	L	Seat Capacity	Top Pieces	Bases Required	CTN WT	CU FT	List Price
Boat Shape Tops  • boat shape top end dimension is 6" less than center dimension **When ordering RECTANGLE or PANEL BASES - FN48120 and FN42120 require (3) panel bases and additional stretchers. Stretchers will be included as required.	FN60264BT	60	264	24	3	4	646	57	\$24,308
	FN60240BT	60	240	22	3	4	589	51	\$22,098
	FN60216BT	60	216	20	3	4	530	48	\$19,893
	FN60192BT	60	192	18	2	3	471	42	\$17,684
	FN54264BT	54	264	22	3	4	586	52	\$20,256
	FN54240BT	54	240	20	3	4	530	50	\$18,418
	FN54216BT	54	216	18	3	4	474	43	\$16,577
	FN54192BT	54	192	16	2	3	417	38	\$14,736
	FN48264BT	48	264	22	3	4	529	47	\$18,007
	FN48240BT	48	240	20	3	4	479	43	\$16,373
	FN48216BT	48	216	18	3	4	428	38	\$14,736
	FN48192BT	48	192	16	2	3	377	33	\$13,099
	FN48168BT	48	168	14	2	3	327	30	\$11,324
	FN48144BT	48	144	12	2	3	277	28	\$9,828
	FN48120BT**	48	120	8	2	2-3**	226	22	\$8,197
	FN4896BT	48	96	8	1	2	185	17	\$6,559
	FN42120BT**	42	120	8	2	2-3**	203	19	\$7,170
	FN42108BT	42	108	8	2	2	180	17	\$6,453
	FN4296BT	42	96	8	1	2	157	15	\$5,736
	FN4284BT	42	84	8	1	2	142	13	\$5,043
FN3672BT	36	72	6	1	2	100	10	\$3,696	

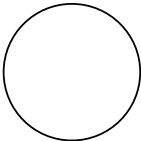
Description	① Model	W	L	Seat Capacity	Top Pieces	Bases Required	CTN WT	CU FT	List Price
Round Tops 	FN60TT	60	N/A	6	1	1	112	10	\$4,127
	FN54TT	54	N/A	6	1	1	92	8	\$3,099
	FN48TT	48	N/A	4	1	1	73	7	\$2,444
	FN42TT	42	N/A	4	1	1	56	5	\$1,868
	FN36TT	36	N/A	3	1	1	42	4	\$1,645
	FN30TT	30	N/A	3	1	1	30	3	\$1,450

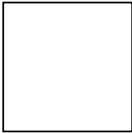
Description	① Model	W	L	Seat Capacity	Top Pieces	Bases Required	CTN WT	CU FT	List Price
Square Tops 	FN6060TT	60	60	8	1	1	154	10	\$3,781
	FN5454TT	54	54	6	1	1	125	8	\$2,864
	FN4848TT	48	48	4	1	1	99	7	\$2,261
	FN4242TT	42	42	4	1	1	77	5	\$1,735
	FN3636TT	36	36	4	1	1	56	4	\$1,565
	FN3030TT	30	30	4	1	1	39	3	\$1,088

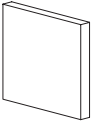

To Order, Specify:

- ① Model Number
- ② Finish Color
- ③ Edge Profile
- ④ Power and Data Options (see [accessories price list](#))
- ⑤ Other Product Options

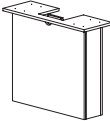
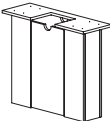
Description	D	W	H	CTN WT	CU FT	① Model	List Price
Panel Base 	2 5/16	36	28 3/4	83	6	FN3628PB · for use with 60" width top	\$1,062
	2 5/16	30	28 3/4	68	5	FN3028PB · for use with 54" width top	\$977
	2 5/16	24	28 3/4	54	4	FN2428PB · for use with 36", 42" and 48" width top · (3) bases are required when ordering FN48120 or FN42120	\$884

Description	D	W	H	CTN WT	CU FT	① Model	List Price
Rectangular Base   side 1 side 2	7 5/8	36	28 3/4	69	7	FN3628PBA · for use with 60" width top · access panel	\$1,793
	7 5/8	30	28 3/4	60	6	FN3028PBA · for use with 54" width top · access panel	\$1,704
	7 5/8	24	28 3/4	52	5	FN2428PBA · for use with 36", 42" and 48" width top · access panel · (3) bases are required when ordering FN48120 or FN42120	\$1,610

Description	D	W	H	CTN WT	CU FT	① Model	List Price
Round Base 	24	n/a	28 3/4	74	12	FN24RB · for use with 54" and 60" width top	\$1,538
	24	n/a	28 3/4	37	12	FN24RBA · for use with 54" and 60" width top · access panel	\$1,715
	20	n/a	28 3/4	71	9	FN20RB · for use with 42" and 48" width top	\$1,353
	20	n/a	28 3/4	34	9	FN20RBA · for use with 42" and 48" width top · access panel	\$1,532
	18	n/a	28 3/4	68	7	FN18RB · for use with 36" width top	\$1,265
	18	n/a	28 3/4	31	7	FN18RBA · for use with 36" width top · access panel	\$1,446

Description	D	W	H	CTN WT	CU FT	① Model	List Price
Half Round Base 	12	24	28 ¾	35	6	FN24HRB · for use with 54" width top	\$1,162
	12	24	28 ¾	33	6	FN24HRBA · for use with 54" width top · access panel	\$1,368
	10	20	28 ¾	30	5	FN20HRB · for use with 42" and 48" width top	\$1,060
	10	20	28 ¾	28	5	FN20HRBA · for use with 42" and 48" width top · access panel	\$1,269
	9	18	28 ¾	27	4	FN18HRB · for use with 36" width top	\$1,018
	9	18	28 ¾	26	4	FN18HRBA · for use with 36" width top · access panel	\$1,228
	Square Base 	30	30	28 ¾	83	6	FN30SB · for use with 60" width top
30		30	28 ¾	68	16	FN30SBA · for use with 60" width top · access panel	\$1,635
24		24	28 ¾	68	12	FN24SB · for use with 54" width top	\$1,283
24		24	28 ¾	68	12	FN24SBA · for use with 54" width top · access panel	\$1,463
18		18	28 ¾	39	7	FN18SB · for use with 36", 42" and 48" width top	\$1,108
18		18	28 ¾	39	7	FN18SBA · for use with 36", 48" and 48" width top · access panel	\$1,287
Cross Base 		30	30	28 ¾	80	16	FN30XB · for use with 60" width top
	24	24	28 ¾	80	12	FN24XB · for use with 48" and 54" width top	\$1,084
	18	18	28 ¾	50	7	FN18XB · for use with 30", 36" and 42" width top	\$967

To Order, Specify:

- ① Model Number
- ② Finish Color
- ③ Edge Profile
- ④ Power and Data Options (see [accessories price list](#))
- ⑤ Other Product Options

Description	D	W	H	CTN WT	CU FT	① Model	List Price
-------------	---	---	---	-----------	----------	---------	------------

Conference Lectern

23	27	48	250	23	FN2622LEC	\$4,103
----	----	----	-----	----	-----------	---------

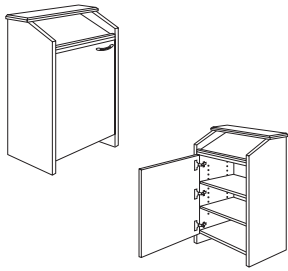

- two adjustable shelves
- four concealed, locking casters
- door non-locking
- standard door is hinged on left
- round grommet in bottom panel
- notches in adjustable shelves allow wires to pass through

Visual Board

3½	48	48	125	8	FN4848VB	\$4,762
----	----	----	-----	---	----------	---------

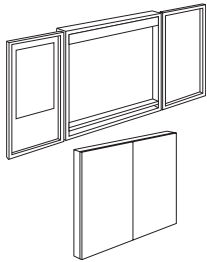

- corkboard on right and left doors; paper pad on left only
- marker board in center
- four markers and eraser included
- optional face applied pulls
- locking not available

Buffet Credenza

24	71½	36	280	43	FN2472BSC	\$7,255
----	-----	----	-----	----	-----------	---------



- top edge profile on user side
- four door credenza
- four box drawers above doors
- locking doors and drawers not available
- adjustable shelf in storage cabinet
- two end panel grommets with wire pass thru
- back panel includes cord exit grommets

Buffet Credenza - Flat Screen Support

24	71½	36	280	43	FN2472BSCT	\$7,875
----	-----	----	-----	----	------------	---------



- top edge profile on user side
- four door credenza
- four box drawers above doors
- locking doors and drawers not available
- adjustable shelf in storage cabinet
- two end panel grommets with wire pass thru
- flat screen mounting grommets in top
- back panel includes cord exit grommets

Flat Screen Mounting Frame

2	14	55	35	4	FSTV	\$1,768
---	----	----	----	---	------	---------

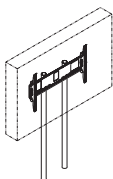

- round 2" tube frame with cable management to inside of credenza
- mounting bracket for TV provided
- available in black (B) or silver (S)
- TV not included
- TV dimension not to exceed 70"w x 38"h to allow proper mounting clearance
- coordinates with FN2472BSCT

Description	D	W	H	CTN WT	CU FT	① Model	List Price
72" h File/File Lateral Storage Cabinet	24	35 ³ / ₈	72	360	43	FN3672SWLF	\$6,011

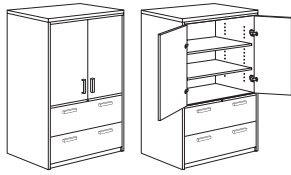

- two adjustable shelves
- locking doors available; specify and add \$147 list
- top edge profile on user side only
- file/file lateral
- pedestal locking

72" h Wardrobe	24	35 ³ / ₈	72	360	41	FN3672W	\$4,660
-----------------------	----	--------------------------------	----	-----	----	---------	---------

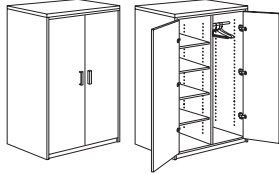

- top edge profile on user side
- chrome hanging bar on right
- one fixed shelf second from bottom on left
- locking doors available; specify and add \$294 list

Hanging Bar to Shelves Conversion Kit	24	18	³ / ₄	56	2	FN1824SK	\$1,069
----------------------------------------------	----	----	-----------------------------	----	---	----------	---------

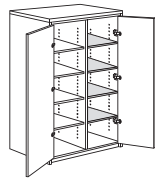

- four shelves
- for 36" wide wardrobe

To Order, Specify:

- ① Model Number
- ② Finish Color
- ③ Edge Profile
- ④ Pull (style and color)
- ⑤ Grommet Color
- ⑥ Power and Data Options (see [accessories price list](#))
- ⑦ Other Product Options

Description	D	W	H	CTN WT	CU FT	① Model	List Price
72" h File/File Storage Wardrobe	24	23 5/8	72	340	29	FN2472SWR	\$4,388
	24	23 5/8	72	340	29	FN2472SWL	\$4,388

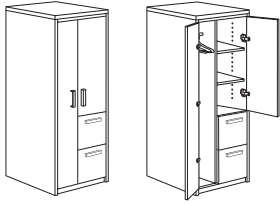

left shown

- top edge profile on user side
- chrome hanging bar
- two adjustable shelves
- file/file pedestal
- locking not available

Description	D	W	H	CTN WT	CU FT	① Model	List Price
72" h Wardrobe	24	18	72	233	23	FN1872WR	\$3,902
	24	18	72	233	23	FN1872WL	\$3,902

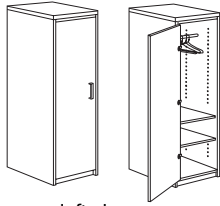

- top edge profile on user side
- chrome hanging bar at top
- one fixed shelf 26 1/2" from cabinet floor
- one adjustable shelf
- locking doors available; specify and add \$147 list

Accessories/ Keyboard/ Tasklights

For a list of electrical units, grommets, keyboards, wire management, monitor arms & telecom jacks, please see our [accessories price list](#)

Contact your customer service representative for specific questions regarding which units can be used with Finale

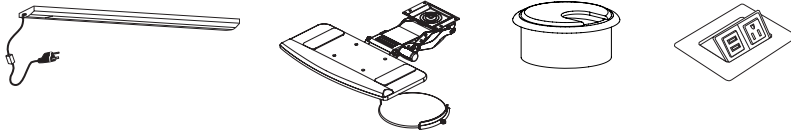

To Order, Specify:

- ① Model Number
- ② Finish Color
- ③ Edge Profile
- ④ Pull (style and color)
- ⑤ Grommet Color
- ⑥ Power and Data Options (see [accessories price list](#))
- ⑦ Other Product Options