

pricelist

effective July 1, 2024

FLUX

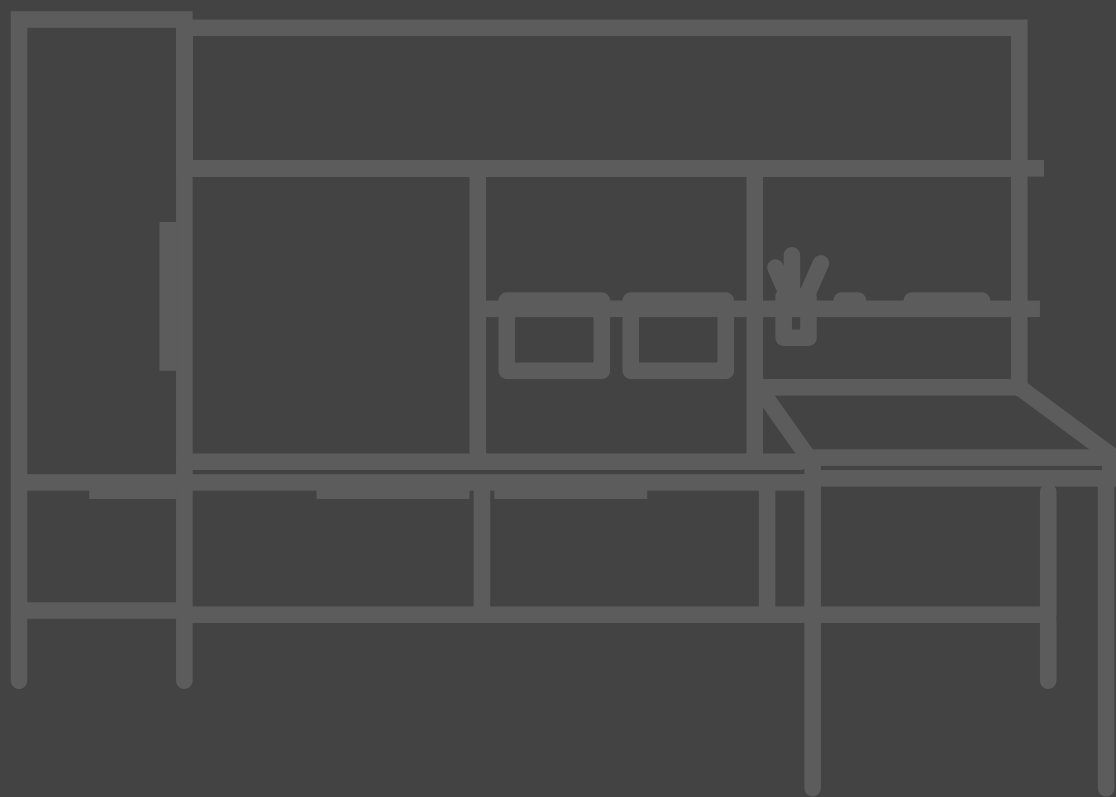

JSI Price Lists

Tables + Casegoods

- [Bourne Tables](#)
- [Brogan](#)
- [Copilot](#)
- [Finale](#)
- [Lincoln](#)
- [Native](#)
- [Nosh](#)
- [Privacy Program](#)
- [Prost](#)
- [Reef](#)
- [Romy](#)
- [Traditional](#)
- [Trail](#)
- [Walden](#)
- [Wellington](#)
- [Accessories](#)

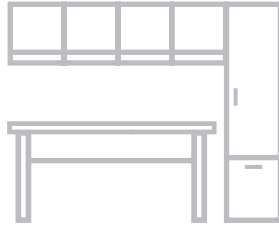

Lok

- [Training Tables](#)
- [Teamwork Tables](#)
- [Conference Tables](#)
- [Occasional Tables](#)



Flux

- [Private Office](#)

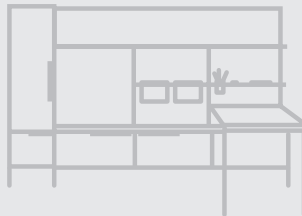

Healthcare

- Seating
 - [Kindera](#)
 - [Satisse](#)
 - [Somna](#)
- Casework
 - [Forge](#)

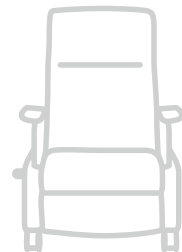

Vision

- [Casegoods](#)
- [Tables](#)

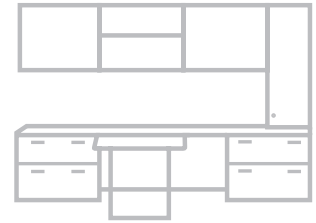

Seating

- | | |
|-----------------------------------|--------------------------|
| Addison | Kyla |
| Americana | Mackey |
| Ansen | Madison |
| Arwyn | Millie |
| Avini | Moto |
| BeSpace | Newton |
| Boston | Oxley |
| Bourne Seating | Pillow |
| Bryn | Poet |
| Caav | Protocol |
| Class Act | Proxy |
| Collective Motion | Ramona |
| Cosgrove | Ria |
| Connect | Sosa |
| Encore | Teekan |
| Finn | Totem |
| Finn Nu | Trinity |
| Garvey R5 | Wink |
| Gatsby | Ziva |
| Harbor | |
| Hoopz | |
| Indie | |
| Jude | |
| Knox | |



Environmental Mission

Our vision and goal is a sustaining supplier, manufacturer and customer for the long term protection and preservation of our environment for future generations.

MISSION

To achieve this vision, we are dedicated to ensuring the health and wellbeing of all of our partners, reducing negative impact on the environment, and maintaining price structure by increasing efficiencies and reducing consumption.

JSI, and it's parent company, is an internal manufacturer and has been an environmentally conscious organization for more than 80 years.

We are proud to use wood as our primary sustainable material resource and all corporate policies and procedures support the efforts to "recover, recycle, reuse, repurpose, reduce, refuse, and re-engineer". In doing this, we are committed to the conservation of the environment and its natural resources as well as encouraging our suppliers and customers to do the same. A goal of a "Sustainable Partnership", supplier, manufacturer and customer, is essential for the long term protection preservation and sustainability of our environment for future generations.

LOCATION

Our manufacturing facilities are located in the center of Southern Indiana. With our diverse product offering and manufacturing capabilities, we provide a single source for all of your project needs allowing you to conserve our fossil fuels and reduce greenhouse gases.

PACKAGING

We place emphasis on the minimal use of disposable packaging while still providing adequate protection to the finished product. Our corrugated packaging is recyclable, reusable, and up to 100% recycled content. We reuse or recycle more than 175 tons of corrugated material annually.

REGULATORY

All of our manufacturing facilities are in compliance with applicable OSHA regulations and meet or exceed all applicable DEM and EPA regulations for air emissions, storm water and hazardous waste disposal.

MANUFACTURING FACILITIES

Our manufacturing facilities are geared toward eco-efficiency and are encouraged to continually improve and conserve. Solid wood not used in the direct manufacturing process is recovered for the operation of our dry kilns, thus reducing greenhouse gases, the use of fossil fuels, and the burden of waste placed on landfills. Composite panels not used in the direct manufacturing process are ground and sold for use as animal bedding and boiler fuel. In addition to other energy savings techniques, our manufacturing facilities use high efficient lighting, make use of power factor capacitors, and encourage all to conserve and reduce energy consumption and water usage. Condensation pumps are used to aid in water conservation as well as extending boiler life.

MANUFACTURING PROCESSES

Our finish processes utilize efficient spray guns and proper spray techniques to reduce wasted material. Excess finish material, solvents, and waste are recycled. Many of the assembly processes use water based glues that contain no hazardous ingredients.

TEXTILES

Many of our fabric options utilize up to 100% recycled content. Our leather alternative program includes selections that contain no toxic materials, plasticizers, heavy metals, or formaldehyde and have a 100% biodegradable back cloth. Some of the available panel fabric used, if discarded is a biological nutrient for the soil. Most of the components (foam, batting, and polycord) used in upholstered products are recyclable. Excess fabrics and leathers not utilized in the upholstery process go to recyclers and local charities for additional use.

WOOD

Wood is the most diverse, most process friendly, and most widely utilized natural resource in mankind's history. No other natural resource can match the environmental advantages of wood, including being renewable, recyclable, natural, carbon negative, and biodegradable. Utilizing the sun's energy, trees grow and remove carbon dioxide from the air while giving off oxygen to benefit the entire planet. Approximately 49% of wood's dry weight is carbon and harvesting mature trees in a sustainable forest, which has slowed in the absorption of carbon dioxide, allows the photosynthetic cycle to continue at full optimization and allow for the carbon to remain sequestered. We are proud to use wood as our primary "sustainable" renewable resource.

WOOD OPTIONS

Many environmentally friendly solid wood and engineered wood options are available for quote, including: Lyptus®, Plyboo®, reclaimed woods, agricultural and post-consumer waste fiber products, etc.

INDOOR AIR QUALITY

Our goal is to reduce the impact our products will have on the indoor air quality. We practice the latest technologies and utilize a third party to assure we meet this goal. GreenGuard, one of the leaders in IAQ certification, continues to certify our product offering with UL2818-GreenGuard Indoor Air Quality certification.

PARTNERSHIPS

BIFMA
Business and Institutional Furniture Manufacturer Association
 USGBC
United States Green Building Council
 IIDA
International Interior Design Association
 FSC
Forest Stewardship Council - Forestland
 UL GreenGuard
Indiana Department of Natural/Resources - Division of Forestry - Classified Forest, Wildlands Program

Lifetime Warranty

JSI warrants to the original purchaser that each piece of furniture will be free from defects in workmanship, given normal use and care for as long as the original customer owns and uses the product. Normal use is defined as the equivalent of a single shift, 40-hour work week.

JSI will, at its option, repair or replace with comparable product within the terms of the warranty.

Exceptions to Warranty:

12 Years (from date of purchase)

- Wood Seating
- Seating Controls
- Pneumatic Cylinders
- Laminate Surfaces
- Veneer Surfaces
- Solid Surface Components
- Somna, Kindera, Satisse and Forge in multi-shift environment except components as specifically identified below

10 Years (from date of purchase)

- Recliner Mechanisms and Associated Levelers (regardless of shift usage)

5 Years (from date of purchase)

- Casters (including recliner central locking)
- Glides (including MagLinx™)
- Electric Height Adjustable Bases
- Task Lights
- Mesh/Knit Materials
- Electrical Components
- Foam
- Recliner Heat Components

This Warranty Does Not Cover:

- Natural variations in color, grain or texture of wood and other covering materials over which JSI has no control
- Normal wear, color fastness, shrinkage, puddling, wrinkling and stretching of upholsteries including fabric, vinyl, leather and other textiles. This warranty does not cover any defects that may arise in the use of COM or COL upholstery materials. Textile manufacturer's warranty will apply.
- Damages resulting from transportation, improper assembly, installation, handling, accident, user modification attachments, misuse, or neglect of product care.
- Damage resulting from extreme climate conditions
- Finish damages resulting from normal wear and tear, improper maintenance, water damage, exposure to sunlight, extreme high or low humidity or temperature, or other acts of nature.
- Damage created by loading file drawers with anything other than hanging folders.
- Use of any unauthorized non-JSI components for use in the place of JSI components, including but not limited to worksurfaces, bases, brackets, or other essential components.

Replacement components are warranted for a duration of 2 years or for the remaining duration of the initial warranty, whichever extends further.

Textile supplier's warranty will apply. Given the diverse range of cleaning agents used by various facilities, it is advisable to conduct testing on each textile choice using the facility's designated cleaning techniques prior to placing an order.

JSI makes no expressed or implied warranties to any product and, in particular, makes no warranty of merchantability of fitness for any particular purpose. JSI will not be liable for any consequential or incidental damages under this warranty.

Unique Characteristic of Natural Woods and Veneers

JSI uses high quality wood and veneer harvested from sustainably managed forests. Every tree has unique and defining characteristics, like fingerprints. These characteristics can be defined by differences in color, grain configuration, and textures. These characteristics will be more noticeable if the product has a clear or lighter finish.

JSI uses select beech, cherry, maple, oak and walnut cut wood products to produce the desired look of our furniture products.

Maple and Cherry species have a higher degree of uneven distribution of grain, small color streaks, and pin knots.

At JSI, we take care of selecting woods and veneers that are used in our products. With this in mind, we hope you appreciate the beauty of each tree's fingerprints. Products will not be replaced due to these natural characteristics.

Veneers can be sliced in a variety of ways to create unique patterns. JSI uses several different patterns, as shown below.

Flat (Plain) Cut as shown



Quarter Sliced as shown

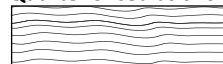

Double Cut as shown



Rift Cut as shown



Double Cut

The Double Cut veneer is a processed product that has at least two cuttings to create the final veneers. These cuts of veneer strands are dyed and layered into a block to create variation of patterns from a very tight grain pattern to an exotic figure grain pattern.

JSI offers two collection of veneer, our Essentials and Artisan Collections.

Essentials

The Essentials Collection allows users to specify beautiful veneers, without sacrificing budget, providing grain patterns and hues for maximum material flexibility and style range.

Artisan

The Artisan Collection provides a curated selection of finishes expressing an elevated style and contemporary nature.

Laminates (Veneer Series)

An alternative HPL (Higher Pressure Laminate) laminate work surface can be specified on most of our casegood product lines. The specification pages will also list the available coordinating finishes.

Laminate Series

JSI laminate series offer a full laminated product with imprinted grain to hide finger prints and provide durability. The worksurface tops are HPL (High Pressure Laminate) or TFL (Thermal Fused Laminate). TFL is used on the product's chassis.

An overview of finishes and laminates appear on page IV, detailing which species each veneer finish is applied to.

Series Material Offering

Select finishes, species and materiality are available on a per series offering, with JSI curating the correct palette offering for the series intent. Please refer to each series feature highlights within the product pages to identify the material, species, grain patterns and finishes available for that specific series.

JSI Core Materials

For projects requiring similar finishes across multiple series, JSI recommends using our Core Materials program. Finishes in this group are offered throughout the vast majority* of JSI products in the three main material categories Essentials and Artisan Veneer, Laminate and Solid Maple, in a spectrum of light to dark.

*note: not applicable to all series, for example BeSpace only offers clear veneer finish.

Finish - Top Coat

To reduce hazardous formaldehyde emissions, we use our proprietary specially designed top coat, DuraTex™. It significantly reduces hazardous formaldehyde emissions and helps improve indoor air quality.

Finish - Color/Stains

A wide range of stains are available to bring out the beautiful characteristics of each wood species. We coordinate finish color between our veneer stains and solid lumber stains; however, not all may be a perfect match. The stains are continually reviewed for accuracy of color, as well as a constant monitoring of the latest color trends in the furniture market.

Finish - Matching

Due to the natural characteristics of wood, environmental effects, and material upgrades, JSI cannot guarantee exact finish matches on existing furniture previously ordered.

If an exact match is required to accompany existing furniture, it must be specified at the time of order placement, so specific internal procedures can be followed to ensure a proper and acceptable finish match. We reserve the right to change our finish formula at any time to improve safety, quality, and appearance. Unless a finish match for existing furniture is requested at the time of ordering, we accept no liability for finish that may not match the existing furniture from prior orders.

Solid lumber may inherently have mineral streaks, pits, and various other natural occurrences. Care is taken in selecting the solid lumber to coordinate with the requested finish on our veneer products. This internal selection process is subject to availability of solid lumber parts.

Finish Sheen

All casegood veneer finishes are standard in 35-sheen, with the exception of Raven, which is only offered in 15-sheen. All other finishes are available in 15-sheen, with a 5% upcharge, per model.

Custom/Special Finishes

JSI, upon request, will accommodate special finishes. A written request is required to proceed with custom finish orders. A sample reference is required for first-time matches and must be included with the written request.

There is a charge of **\$384 list per order** for any non-standard wood finish.

Orders will be entered noting the special finish. A sample match will be provided to the customer. Written approval is needed before the finish process can be started. Delays in approval may have an impact on lead times.

Every effort will be made to create the requested match; however, an acceptable match may not be possible because of natural variations of wood. These natural variations can also cause minor differences in the final finish product.

Use standard pricing and option pricing for each line item with a special finish, unless additional modifications have been specified. For items available in both Essential and Artisan veneers, apply the Essentials pricing.

Samples

Samples of standard wood finishes, paints colors, metal colors, and standard laminate are available upon request. The fastest way for requests to be filled is by using our website. See below for options to request samples.

Website – jsifurniture.com (click the resource tab)
 JSI Sales representatives
 Phone – 800.457.4511 – Customer Service
 Email – customerservice@jaspergroup.us.com

Veneer Finish and Laminate Overview

Designator	Finish	Veneer Collection	Veneer Species	Laminate	Core Program
BAR	Barrel	Artisan	White Oak- Double Cut	n/a	N
BRK	Brickdust	Essentials	Cherry	HPL & TFL	Y
BUF	Buff	Artisan	White Oak- Double Cut	n/a	N
CSK	Cask	Essentials	Walnut	HPL & TFL	Y
CND	Cinder	Artisan	White Oak- Double Cut	n/a	N
CLY	Clay	Essentials	Cherry	HPL & TFL	Y
EGR	Egret	Artisan	White Oak- Double Cut	HPL & TFL	N
FAW	Fawn	Essentials	Linear - Double Cut	HPL & TFL	Y
FLX	Flax	Essentials	Maple	n/a	N
FLN	Flint	Essentials	Linear - Double Cut	HPL & TFL	Y
LOF	Loft	Essentials	Linear - Double Cut	HPL & TFL	Y
MES	Mesa	Essentials	Cherry	HPL & TFL	Y
MIN	Mineral	Essentials	White Oak- Double Cut	HPL & TFL	Y
MCH	Mocha	Essentials	Walnut	HPL & TFL	Y
OBK	Outback	Essentials	Cherry	HPL & TFL	Y
PIL	Pilsner	Essentials	Maple	HPL & TFL	Y
RAV	Raven	Artisan	Black Oak	n/a	N
RYE	Rye	Artisan	White Oak- Double Cut	n/a	N
SAB	Sable	Artisan	White Oak- Double Cut	n/a	N
SAD	Saddle	Artisan	White Oak- Double Cut	n/a	N
SIE	Sienna	Essentials	Walnut	n/a	N
TRF	Truffle	Essentials	Walnut	n/a	N
UMB	Umber	Essentials	Walnut	HPL & TFL	Y
VAL	Valley	Essentials	Linear - Double Cut	HPL & TFL	Y



Pricing

Prices found in this document or on our website are list prices in U.S. dollars for standard product delivery to one destination. Prices do not include storage, installation, or taxes. Possession of this price list does not constitute an offer to sell. Orders can only be received from approved authorized JSI dealers.

Prices and product information in this document, as well as our website, are subject to change without notice. Reference website for most up to date product offering and pricing.

In our ongoing efforts to minimize ancillary charges. JSI does not include these fees in any calculations for dealer participation fees or commissions in any form. Ancillary charges include but are not limited to special finish charges, special laminate charges and handling fees. When calculating your dealer participation fee or commission earned, please include product lines only and exclude any ancillary charges. Should you have any questions, please call our office for clarification.

Orders

Detailed specification pages are available in the price list at the beginning of each series.

Additional information may be obtained by consulting the Customer Service Department or our website.

Indicate shipping address if different from billing address.

Send Orders To:

US Mail – JSI
225 Clay Street
Jasper, IN 47546
Fax – 812-482-1548
Email – orders@jaspergroup.us.com

JSI reserves the right to make changes in dimensions, styles, or specifications if we believe these changes will improve the safety, quality, or appearance of the product.

Acceptance of orders will be subject to credit approval, barring any acts of governments, or any other causes beyond our control (e.g. strikes, fire, embargo of materials, etc).

Product Modifications

While we offer a wide range of products to accommodate many possible solutions, we also recognize the needs for our products to be modified from our standard offering.

In the series introduction section of each product, we address modification options for that series.

To see if the desired modification is possible, please contact our Customer Service Department for a quote. Note that order quantities and material availability can affect the quote. Additional information may be requested to fully quote modifications.

Order Acknowledgments

All orders will be acknowledged promptly upon entry of a clean order. The acknowledgment will show how the order was entered, ship date and any other information pertinent to the order. It is the purchaser's responsibility to verify all the information on the acknowledgment carefully and notify us immediately, in writing, of any discrepancies.

Every reasonable effort is made to ship as acknowledged; however, the acknowledged ship date is approximate. Company will generally ship within five (5) working days of the acknowledged ship date. If a firm ship date is necessary, customer must inform company at time of order and company will make all reasonable efforts to meet each customer's request. Acknowledged shipping dates are contingent upon the force majeure conditions contained in these terms and conditions.

Cancellations and Changes

All orders are considered firm and are not subject to cancellation or change without approval from JSI. All approved changes are subject to additional charges and revised lead times

Quickship

JSI offers select Vision models, with select options, in our Quickship program. These items ship within 10 business days after receipt of a clean, credit approved purchase order. Items should be placed on order separate from standard lead time models.

Product for up to 10 offices or 10 tables can be included on a single Quickship order. Available capacity is filled by orders as they are received. If normal 10 day Quickship is not available because capacity has been filled, you will be immediately notified by JSI customer service. Changes and cancellations to Quickship orders are not allowed under any circumstances, nor are modifications to the pre-determined Quickship offering. Limit one order per project.

Delivery

Our freight policy consists of prepaid freight to the 48 contiguous states; all other shipments are prepaid to port of exit ONLY. JSI reserves the right to select the appropriate carrier and shipment routes, most shipments are on freight carriers that are dedicated furniture specialists. Standard deliveries require a DOCK that can accommodate 75 foot trucks. Ownership and inspection of product is the responsibility of the buyer upon pickup by the freight carrier. Pricing in this book is for standard delivery only. Standard delivery does not include non-dock delivery, inside delivery, residential delivery or installation of product. Fees and changes for non-standard deliveries are listed below.

Shipping Destination

Changes to ship to locations may not occur within seven days prior to the ship date, however, in atypical situations a **\$250 change fee** will be applied to accommodate additional carrier fees.

Standard Delivery Time

Between 8 AM and 3 PM Monday through Friday. Special delivery requests can be subject to additional fees to accommodate requests.

No Touch Freight

Our freight is considered "no touch". Therefore, customers are to be prepared to unload freight from inside the truck prior to arrival. In the instance that a driver must unload the shipment, driver assists fees will apply (see fees below).

On-Site Deliveries

Shipments to the installation site, and time deliveries are available on full truckloads or slightly less, at no additional charge. Shipments or timed deliveries for smaller shipments may not be available, or if available may require an additional charge.

Detention Fees

- Carriers are given two-hour maximum time allotment to unload for one-stop truckloads.
 - Carriers are given one hour maximum time allotment to unload for multi-stop truckloads
- *Detention fees apply after allotted unloading time and will be at buyer's expense.

Fees

Orders of less than \$1,000 net \$93 net per order
 (If order is UPS shippable, the handling fee is waived and customer is invoiced for exact shipping charges.)
 Weekday deliveries outside of standard delivery times . . . \$309 net
 Weekend deliveries (Saturday or Sunday). \$618 net
 Liftgate Deliveries \$515 net minimum 7% of net price
 Driver Assist \$93 net
 Jobsite Non-Dock Delivery \$155 net per truck
 Inside Delivery (first floor inside only)- no installation or carton removal \$258 net minimum 7% of net price
 NO RESIDENTIAL DELIVERIES

Warehouse/Storage Fees

Additional storage time with a provided two-week approved notice is calculated at 3% per month of the product amount or per day.

Please be Advised

- Reconsignment fees are the responsibility of the buyer.
- Any charges arising from failure to meet shipment, re-routing while in transit or carrier storage charges are the responsibility of the buyer.
- Contact Customer Service to inquire about skidding of products, special crating of products and product installation. These requests must be approved by JSI and made at the time of order.
- Carriers have the right to refuse delivery to a specified location if it conflicts with their liability policy.

Freight Damage

JSI products are packed in cartons and meet or exceed existing codes for furniture and seating products. All shipments are delivered to the carrier in good condition and our liability ceases thereafter. If delivery arrives short or damaged, contact Customer Service immediately to file a claim. In the event of concealed damage, notify Customer Service and request immediate inspection. Failure to file a claim within 15 days after receipt of merchandise constitutes acceptance and a waiver of any such claims. Please inspect merchandise immediately upon receipt, otherwise there is no recourse. Keep all cartons and packing material, discarding these materials may negate your claim.

Storage of product in areas of uncontrolled humidity and temperature may cause damage to the product and void the JSI warranty.

Repairs

JSI will not issue credit allowance for any type of repairs without prior written consent.

Sales order, product model numbers, and reason for repair will be expected in order to process the repair request. A digital photo will help to expedite the request. JSI reserves the right to recommend solutions for repair.

Replacement Parts

Obtain information and pricing on replacement parts by contacting Customer Service. Please have the model number available when requesting replacement parts. Additional information may be required to ensure proper replacement parts.

Returns

JSI products are made to order and may not be returned for credit. No merchandise may be returned to JSI without a signed Return Good Authorization (RGA) form issued by our Customer Service Department. RGA's will be considered for the following reasons:

1. Manufacturing defect (validated by JSI representative).
2. JSI order processing error.
3. Shipping error.
4. Mis-marked cartons.
5. Duplicate shipments.

Liability for defective merchandise shall be limited to replacement or repair.

If you have questions as to whether your reason for return qualifies for consideration, please contact Customer Service. At the discretion of JSI, returns on stocked items may be considered with the following stipulations:

1. 60% restocking fee.
2. All return freight charges must be prepaid by dealer.
3. Product was never removed from the original carton.
4. Product must be returned within 30 days of RGA issue date.
5. Credit will not be issued if product returned is damaged.
6. Under no circumstances can we accept COD (Cash on Delivery) returns. Any such shipment will be refused.

Please note most models on Quickship are produced on demand and cannot be returned. Modified, special or custom-built product is not eligible for return.

Fire Retardancy

All JSI upholstered components comply with California Bureau of Home Furnishings and Thermal Insulation-Technical Bulletin 117-2013 issued by State of California Department of Consumer Affairs. This standard requires upholstered furniture to be safer from the hazards associated with smolder ignition in all four (4) categories of materials, as applicable.

Compliance with more stringent codes may require special manufacturing considerations and upcharges.

California Technical Bulletin 133 (CAL 133)

JSI uses a barrier material between the foam cushioning and the upholstery cover in order to comply with CAL 133. The standard upcharge on products specified to comply with CAL 133 is **\$81 list per yard** of textile.

JSI has performed a series of full scale fire tests on samples- representing worst case scenarios of upholstered units- to comply with the requirements of the state of California Technical Bulletin 133 (CAL 133). Products in compliance are labeled in accordance of the standards.

Some product designs and fabric cannot be combined to comply with CAL 133. Because of this, we reserve the right to reject any request for an upholstery cover, including COM, textile may not contain olefin or product style that we feel may compromise the integrity or safety of a product specified to comply with CAL 133.

Contact Customer Service for a quote if you require laboratory certification that a specific product and upholstery combination WILL PASS CAL 133. The quotation will include testing, video, and transportation charges plus the list cost of the sample.

Our standard lead time will apply to products that do not require certification. Allow an additional six weeks over the standard lead time for products that need actual laboratory certification.

The end user, specifier and/or dealer have the responsibility to make sure all products specified will meet the flammability and safety codes of the jurisdiction where the products will be located and used.



Flame Spread

All JSI may be required to comply with the requirements of Flame Spread based on ASTM standards/NFPA Life Safety Codes and general public knowledge are as follows:

- Solid Wood- Class C
- Topcoats- Class A
- Carded Fabric- Class A
- Composite Panels- Class C
- Laminate- Class B

Plastics- According to the NFPA, the lack of stability of plastics under high temperature conditions and inherit combustibility have eliminated the use of plastics for applications requiring a flame spread rating.

Also be advised that improvements may be attained in certain instances with the addition of chemicals which may add additional costs, chemical exposure and/or compromise the integrity of the product.

Textile Carded Programs

JSI is proud to partner with Maharam, Momentum, Spradling, Stinson, Ultrafabrics, Camira and Cortina Leather. Please refer to our website for our standard patterns, along with the current grade.

<https://www.jsifurniture.com/finishes-and-materials/textiles>

Textile Grade-In Programs

For the convenience of our specifiers, we offer an extensive graded in program. Please reference our website for the most up to date information on our graded in program.

<https://www.jsifurniture.com/resources/textile-partner-info/overview/>

For additional specifications on the pattern or to order memo samples, please contact the textile suppliers directly:

- Arc Com www.arc-com.com
- Camira www.camirafabrics.com
- DesignTex www.designtex.com
- Maharam www.maharam.com
- Mayer www.mayerfabrics.com
- Momentum www.themomgroup.com
- Spradling www.spradlinggroup.com
- Stinson www.cfstinson.com
- Ultrafabrics www.ultrafabricsllc.com
- Cortina Leather www.cortinaleathers.com

Any textile not graded in or pre-approved for COM/COL will require application test approval prior to order entry and shipment of fabric or leather to JSI. For current JSI grades and application status by series visit www.jsifurniture.com Resources > Graded-In + COM; [Graded-In + COM](#).

Indicate on purchase order if JSI is to order the fabric.

Grades and availability of fabric are subject to change without notice. Changes could include but are not limited to price increase, discontinued patterns, discontinued colors, etc. See www.jsifurniture.com for up to date information.

Many textiles have repeats and the additional yardage required has been factored in for textiles ordered through the JSI Carded and Grade-In Programs. We reserve the right not to match textiles with a horizontal or vertical repeat greater than 17". Additional charges may apply for textile being applied with special instructions.

Some fabric thickness or stiffness may cause issue with proper upholstering of tackable wall panels or upholstery privacy screens. Please contact customer service with concerns on the fabric thickness for these items.

COM/COL Address

JSI
Attn: COM/COL Department
Receiving B
Dock 71
201 East Martin St.
Orleans, IN 47452

Tag: Dealer Name / Purchase Order #

General COM Fabric/COL Hide Policy

Refer to the COM/COL Price Columns for list prices.

All yardage requirements listed in the price list are based upon 54" plain non-directional material. Additional yardage may be required based on fabric repeat and matching.

All square footage requirements for COL are based on an average hide size of 50 square feet.

Contact Customer Service for any of the following conditions:

- + approval of COM/COL to be used (see policy on the next page)
- + fabric repeats greater than 3"
- + fabric less than 54" wide
- + leather hides smaller than 50 square feet
- + special application requirements request

When requesting information from Customer Service on COM/COL please supply the following information:

- + model number and quantity of the product the COM/COL will be applied
- + COM/COL textile supplier's name
- + name of pattern and color of the textile
- + any special application request

Visit www.jsifurniture.com Resources > Graded-In + COM to see if the textile has already been approved. If there is no record for this particular textile then a Memo Sample will be required.

JSI takes no responsibility when additional materials must be ordered.

COM Fabric Repeat Guide

Roll Width	Plain Fabric	1" - 5" Repeat	6" - 10" Repeat	11" - 15" Repeat	16" - 20" Repeat	21" - 30" Repeat	31" - 40" Repeat	41" - 50" Repeat
54"	0%	10%	15%	20%	25%	30%	40%	50%
53" to 51"	15%	20%	25%	30%	35%	40%	50%	60%
50" to 48"	30%	35%	40%	45%	50%	55%	70%	90%
47" to 36"	60%	65%	70%	75%	80%	85%	100%	120%

The percentage represents the additional fabric yardage that needs to be added to the COM yardage. Contact Customer Service for repeats greater than 50".

All COM/COL must meet applicable codes and regulations, including TB117-2013. By selecting COM/COL, customer certifies that the material meets such codes. JSI assumes no responsibility for the applicable codes and regulation regarding flammability rating and safety rating of any COM/COL.

JSI cannot be held responsible for receipt of defective fabrics, as we apply all COM as first quality goods.

We can take no responsibility for tailoring, wear-ability or application of COM/COL textiles. Any warranty claims for the COM/COL Textile materials will fall to the original vendor of the textile, not JSI.

COM Fabric/COL Hide Process for JSI Seating

General COM Fabric and COL Hide Policy also apply.

JSI will approve or disapprove COM/COL on all products. An approval of a textile from JSI makes no claim that performance, durability or tailoring of COM/COL will result in satisfactory upholstery. Every effort will be made to meet customer's expectation, but fabrics/leathers have unforeseen inherent characteristics that may limit JSI's ability to deliver a well tailored product.

Approval COM Textile/COL Hide Process for Seating

Follow the Steps Below:

1. Send a Memo Sample of the COM/COL (recommended memo be at least 4" x 4")
 JSI
 Attn: COM/COL Approval Department
 201 East Martin Street
 Receiving B, Dock 71
 Orleans, IN 47452
2. Call our Customer Service Department at 812-482-3204 to request an electronic version of approval form.

Guide Order Form for COM and COL

Please send sample to:
 JSI
 Attn: COM/COL Approval Depart.
 201 East Martin St.
 Receiving B, Dock 71
 Orleans, IN 47452

① **Order Information:**

Quote #: _____ **Purchase Order #:** _____

Customer Service: _____

Dealer Name/Project Name: _____

Contact: _____

Address: _____

Phone: _____ **Email:** _____

Model Number(s) Receiving COM / COL: _____

Please forward a copy of this form to your JSI CSR for record keeping

② **Select off the bolt application: (Check one of the boxes)**

Up the roll (standard on most seating) Railroaded

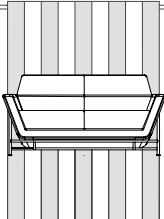
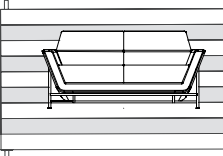
③ **Additional information:** _____

④

Attach sample here.

JSI will review and test as needed all requests. You will be notified as soon as results are documented by our review personnel. JSI reserves the right to reject any COM/COL on our products. We will provide COM/COL explanation of any unapproved textile whenever possible.

Custom Options

Wood Laser Engraved Back

Many of our seating models are available with a custom wood laser engraved back. University seals, logos, unique designs, or any type of graphic can be designed into the seating back for a custom creation. Copyright approval may be required. Consult JSI Customer Service for pricing and artwork specifications. Artwork must be submitted as a JPG or PDF file.



Wood Laser Engraved Back General Pricing

* must order plain back when choosing these options

For Artwork 4" x 4" or Less	\$58 list per chair
For Artwork Less than 6" x 6"	\$102 list per chair
For Artwork Larger than 6" x 6"	Call For Pricing

For orders fewer than 50 pieces, add \$158 list per design, per order. This pricing reflects etching (leaving the wood dark). If additional painted colors are added to artwork please call customer service for pricing.

A \$139 list set-up fee applies.

Care and Maintenance

Care and Maintenance

Care of Upholstery Surfaces

Cleanability will vary based on the fabric type. For best results, a professional service is recommended. Dirt and crumbs may be gently brushed or vacuumed off. Spills should be wiped up immediately with a cloth. Vinyl textiles can be cleaned with warm soapy water and then wiped down with a warm damp cloth. For more details on any JSI carded fabric and vinyl, please visit our website at jsifurniture.com or consult the back of the appropriate swatch card for cleaning codes and any specific instructions. For COM materials, consult with the individual textile manufacturer for cleaning codes and any specific instructions pertaining to your particular fabric.

Maintenance of Mechanical Parts

Clean any lint or debris from the moving parts of the base mechanisms. Mechanisms have been designed and tested to not require lubrication under normal conditions; however, lubricant can be used if needed.

Care of Wood Edges and Veneer Surfaces

Clean all surfaces frequently with water dampened soft cloth, moving the cloth with the grain direction. Immediately remove any liquids that come in contact with wood surfaces with a blotting action to absorb liquid. Buff dry. Lift objects to move them, never pull them across the finished surface. For an additional safeguard, use a protective surface pad. This will ensure a lasting finish by protecting your furniture from possible damage caused by pens, cups and sharp objects. Avoid exposure of furniture to extremes of heat and cold, or to wide humidity variances. Avoid exposure of furniture to strong sunlight. Avoid exposure of furniture to harsh solvents such as nail polish remover, acetates, etc., as it will cause finish deterioration. If using a protective glass top, place spacer pads under the glass top to allow the wood to breathe.

Care of Metal Finishes

Wash your powder-coated item at least one every six months. Use soft rags only - No abrasives. For stubborn stains and grease marks, use soap and water mixture. Combine 1 gallon of water and 1 cup of the neutral detergent in the bucket. Mix it up by swirling one of the rags around in it. Wipe down the powder coat with a rag that has been dampened with the cleaning solution. Do not scrub, but use gentle, repetitive pressure to remove any built-up grime. Rinse the powder coat off with a rag dampened with clear, clean water. Do not spray it down, but rather wipe it off with the rag. You may need to do this several times to get all the soap off. Wipe the powder coat down with a clean dry rag. This will prevent streaking and spotting.

Care of Frosted Glass

Use a clean, dry lint free cloth to wipe the surface. Follow with warm water and a clean rag; no soap or chemicals. Wipe dry with a clean, dry lint free cloth. Cleaning the frosted side is not recommended, if desired to clean use the above method but do not spray the water on the frosted side, use a clean rag. Please allow 48 hours for the frosted side to dry and not to show cloudiness.

Tempered Glass Information

JSI is aware of occasional occurrences of spontaneous glass breakage in various furniture products. Tempered glass makes it stronger and if it breaks, will cause it to break into many small pieces of “cubes” rather than sharp and potentially dangerous shards.

Glass breakage in furniture may occur for a variety of reasons. Tempered glass is particularly prone to breakage from damage (scratches, nicks, etc.) that may occur during shipping, handling, installation, use or maintenance. Exposure to rapid changes in temperature or concentrated temperature zones may also cause breakage.

Tempered glass may also break due to a specific type of imperfection or “inclusion” that occurs within the glass when manufactured. When this condition exists glass breakage may occur without any obvious cause. This is often referred to as “spontaneous” breakage but is a very isolated occurrence in the glass industry.

Care of Dry Erase Boards

Erase after every use to eliminate ghosting. Clean weekly with a Dry Erase Cleaner. Avoid the use of orange and red Dry Erase Markers. Follow manufacturers cleaning instructions for the eraser. If ghosting or staining remains use a small amount of rubbing alcohol on a clean, soft towel to remove.

Care of Solid Surface

Although liquids cannot penetrate Solid Surface, it is best to wipe up spills as they occur. Generally, a damp microfiber cloth used with a standard household kitchen spray should remove most stains.

For most residues, all you need to clean your Solid Surface countertops is a warm soapy water, ammonia-based household cleaner or a dedicated countertop cleaner. Do avoid window cleaners; however, as they can leave a waxy build-up that dulls the surface. Always clean using a circular motion.

Film will build up on countertops if water is left to dry on the surface. This film will dull the countertop surface, making the finish appear blotchy and uneven. To prevent film build-up, it is very important to wipe the countertop completely dry immediately after spills and cleaning.

Some color of Solid Surface may require more frequent cleaning to maintain a uniform finish. Darker colors tend to require more attention than lighter colors. Over time, even with proper care, your countertop will acquire a sheen. Dark colors may show light scratches more readily.

Specification Tools

JSI products are manufactured to order and provide a multitude of options to address your individual customer needs. As you process your order do not forget to include all the necessary information to allow the order entry process to be completed. Please see the order checklist at the beginning of every series.

JSI Customer Service edits every order for complete information. If details are not included with the purchase order, Customer Service will contact you to answer these questions. If information is not completed in a timely manner it will delay the entry process and could affect your product delivery date. To avoid delay in order entry and potential delay in delivery of your order, please double check the line items to ensure all selections have been completed.

To ensure completion of details on your purchase order, electronic catalogs and specification tools have been developed to aid in the process. These electronic tools include:

20-20 GIZA Studio and 20-20 CAP Studio software offers state-of-the-art design, specification, photo-realistic rendering and three-dimensional visualization capabilities for configurable products in the commercial interior design markets. 20-20 GIZA Studio and 20-20 CAP Studio are available for all JSI Casework and Seating products, in 2D and 3D graphics and the Specifier Catalog. Updates are made monthly reflecting any changes that occurred. To be sure the most up to date information is provided on orders, users of this software program are responsible to update their catalogs.

CET Designer, by Configura is an all-in-one software solution for space planning and configuration of products. The intuitive workflow guides you through entire process from idea to reality- supporting every step of the sales process

GSA Advantage is a Federal Government electronic catalog site offered to assist GSA customers in specifying and pricing JSI product. Listed at this site are all contract items and prices under GSA Contract # GS-28F-0030U.

Our JSI website jsifurniture.com provides many tools to assist in the design and order selection. Included in the site are downloadable images, typicals, product symbols, brochures, contact information, price lists, sales representative locations, warranty and environmental information.

GSA Terms and Conditions



Contract Holder

Contract # GS-28F-0030U

Maximum Order
\$250,000 net

Geographic Coverage
48 contiguous states and Washington D.C.

Point of Production
Jasper, Dubois County, Indiana
Orleans, Orange County, Indiana

Discount
Discount 61.6%* off list.

*Discount for Walden and Wellington is 61.71% off list.

Discount Quantity
Walden and Wellington only
\$300,000 to \$350,000 Net = 0.5%
\$350,001 to \$400,000 Net = 1%
\$400,001 to \$450,000 Net = 1.5%

Prompt Payment Terms
1% 15 - net 30 days from date of invoice.

Government purchase cards are accepted at or below the micro-purchase threshold

Government purchase cards are accepted above the micro-purchase threshold

Foreign Terms
Not applicable.

Time of Delivery
30-75 days after receipt of order, 90 days maximum.

Expedited Delivery
Contact Customer Service 800-457-4511

Overnight and 2-day Delivery
Not applicable.

Urgent Requirements
Contact Customer Service 800-457-4511

F.O.B. Points
F.O.B. destination, freight prepaid and allowed to 48 contiguous states and Washington D.C. excludes special delivery requirements.

In addition to the standard terms and conditions, the following terms and conditions apply to GSA contract.

Contract Number
GS-28F-0030U

Contract Period
June 24, 2013 - June 24, 2028

Statement of Intended Use
The furniture covered by special item number 33721 Office Furniture shall comply with the requirements defined in purchase description 3QSAB 09-608. All furniture offered under this SIN shall be GSA Chassis Grade 1, 2, 3 or NA, GSA Drawer Grade 1, 2, 3, 4 or NA, Design A B or C, as defined in 3QSAB 09-608.

Description of Special Item Number SIN #33721

Cooperative Purchasing
No

Set Aside
No

FSC/PSC Code
7125

NAICS 337211 Wood Office Furniture Manufacturing 1000 employees

Includes all furniture placed in an office, such as chairs, desks, etc. In addition, ancillary services are included, however services performed shall not be the primary purpose of the work ordered.

Lowest Price Model

SIN #	Model Number	Net Price
33721	VS-LBRKT-20	\$28.03



GSA Terms and Conditions

Ordering Address

Jasper Seating Company, Inc. d/b/a JSI
Attn: Participating Dealer
225 Clay Street
Jasper, IN 47546
Fax: 812-482-1548
Phone: 800-457-4511
Email: orders@jaspergroup.us.com

Order Procedures:

Per contract

Payment Address

JSI
225 Clay Street
Jasper, IN 47546

Warranty Provision

Limited Lifetime

Export Package Charges

Quoted on project-by-project basis.

Terms of Government Commercial Credit Card Acceptance

Accepted.

Rental, Maintenance, and Repair

Not applicable.

Terms and Conditions of installation

12% of net purchase order for installation services up to \$250,000.00 of net purchase price.

Terms and conditions of repair parts, etc.

See warranty.

List of service and distribution points

Contact Customer Service 800-457-4511.

List of participating dealers

Contact Customer Service 800-457-4511.

Preventive Maintenance

N/A

Environmental Attributes

GreenGuard Certified and recycled wood waste and fabric remnants

Section 508 Compliance

N/A

DUNS

00-636-7767

CCR and SAMS Registration

Jasper Seating Company, Inc. is registered
Cage Code #31881
Federal ID #35-0420370
UEI #DDJ2GKQM7M84

Product Modifications

We willingly accept customers' modifications to standard products. See product modification information by series at the start of each series under the "Product Modification" sections. If there is a modification you desire that is not listed in this section, please call Customer Service for a modification quote/price

Acceptance, Modification, Assignment

By placing this order for furniture, material or other products (sometimes collectively referred to as "goods"), customer agrees to these terms and conditions which shall prevail over inconsistent provisions in any other form or document of customer. No change or modification shall be applicable unless set forth in writing and signed by company. Neither this order nor any interest therein shall be assigned by customer except with the prior written consent of company.

Payment

Customer agrees to pay to company the amount indicated on the invoice, 1% 15 days, net 30 days from date of invoice (U.S. funds only), for goods ordered. Interest will be charged after 30 days from the date of invoice at the rate of one and a half percent (1.5%) per month. International sales will require additional payment arrangements. No goods shall be sold on consignment or conditional sales basis. Payment for the goods delivered hereunder shall constitute acceptance thereof.

Attorneys' Fees

Customer shall be responsible for all expenses and cost in connection with the enforcement by company of these terms and conditions and the cost of collection (including the fees of any collection agencies to whom the customer's account may be referred), plus reasonable attorneys' fees (which attorneys' fees shall not be less than 25% of the amount due, unless a lower amount is specified by applicable law).

Remedies

The remedies herein reserved shall be cumulative, and additional to any other or further remedies provided in law or equity. No waiver of a breach of any provision of these terms and conditions shall constitute waiver of any other breach or of such provision.

Insolvency

Company may forthwith cancel this order in the event of the happening of any of the following or any other comparable event: insolvency of the customer, the filing of a voluntary petition in bankruptcy, the filing of any involuntary petition to have customer declared bankrupt provided it is not vacated within thirty (30) days from the date of filing, the appointment of a receiver or trustee for customer provided such appointment is not vacated within thirty (30) days from the date of such appointment, or the execution by customer of an assignment for the benefit of creditors.

Casegoods Price List | Flux Series

General Information

Environmental Mission	II	Custom Options	VIII
Warranty.	III	Care and Maintenance.	IX
Laminate and Veneer Characteristics	III	Specification Tools	X
Samples.	IV	GSA Terms and Conditions	XI
Order Procedures	IV		
Quickship Program.	IV		
Delivery	IV		
Freight Damage	V		
Repairs and Returns	V		
Fire Retardancy / CAL 133	V		
Textile Information / COM and COL Policy.	VI		

Flux - Private Office

Product Information

Overview	2-3
--------------------	-----

General Options

Material Offerings	5
Desk Pedestal Configurations	6
File Drawer Configurations	7
Top Edge Details.	8
Pull Options/Details	9
Casters	11
Modesty Panels	12

Applied Materials

Laminate Grain Directions	13
Veneer Grain Directions	14-15
Color Scheme	16

Product Details

Pedestal Desks	17
Peninsula Desks w/Secondary Creds.	18-20
Run-off Desks	21
Adjustable Height Desks & Tables	22-23
Credenza Options	24
Credenza Compartment Dimensions	26-27
Overhead Cabinet & Wall Panel Stack-ups	28
Wall Panel Installation	29

Product Details (cont.)

Overhead Cabinet Stack-ups	30-32
Overhead Cabinet Door Options	33
Tasklight Size Chart	33
Monitor Cabinets	34-35
Vertical Storage	36-38
Modular Components	39

Technology

Power and Data Wiring Examples.	40-41
Grommets and Power Units	42
Grommet and Power Unit Locations	43-49
Wire Manager Size Chart	50-51

Pricing Pages

Tables	52
Pedestal Desks	56
Peninsula Desks	88
Run-off Desks	112
Returns & Bridges	122
Primary Height Credenzas	128
Modular Credenzas/Pedestals	150
Kneespace Credenzas	154
Peninsula Credenzas.	164

Pricing Pages (cont.)

Primary Height Credenzas	168
Secondary Height Credenzas.	190
Cushions	214
Adjustable Height Units	216
Modular Units	254
Primary Height Overhead Cabinets	272
Primary Height Panels/Markerboards.	294
Secondary Height Overhead Cabinets	298
Secondary Height Panels/Markerboards.	308
Wall Mount Overhead Cabinets.	312
Wall Mount Cubbies	332
Wall Mount Panels/Tackboards.	338
Workwall Panels	354
Storage Towers.	364
Monitor Cabinets	370
Bookcases.	378
Lateral Filing.	380
Wardrobes/Vertical Cabinets	382
Wardrobes/Vertical Cabinets with Legs	416
Pantries	444
Lockers	448

Accessories

Keyboard Accessories	456
Monitor Arms	457
Tasklights	457
Drawers	458
Power and Data	458
Wire Management	460
Portable Slide on Screen.	461

Flux Overview

Tables [Page 50-53](#)

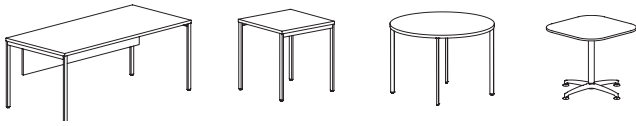

Pedestal Desks [Page 54-85](#)

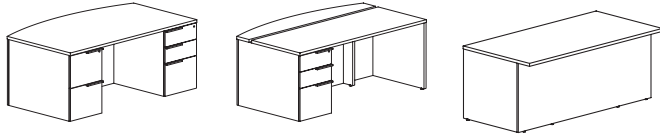

Peninsula Desks [Page 86-109](#)

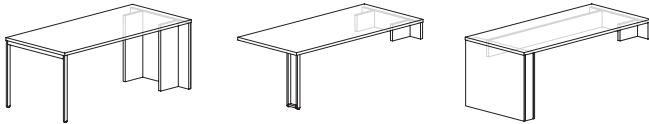

Run-off Desks [Page 110-119](#)

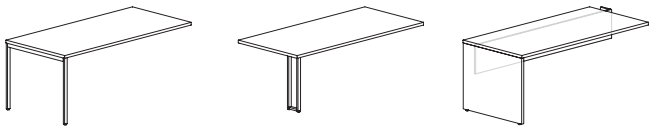

Returns & Bridges [Page 120-125](#)

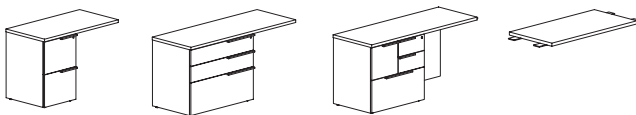

Primary Height Credenzas (to floor) [Page 126-147](#)

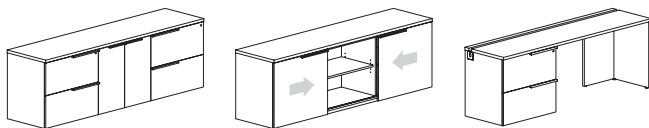

Modular Credenzas/Pedestals [Page 148-151](#)

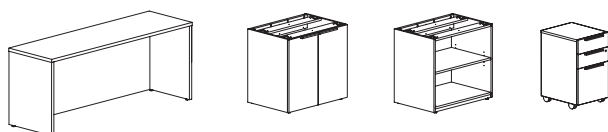

Kneespace Credenzas (on legs) [Page 152-161](#)

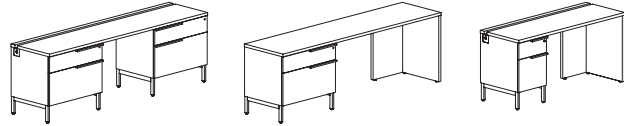

Peninsula Credenzas [Page 162-165](#)

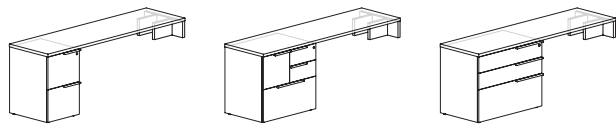

Primary Height Credenzas (on legs) [Page 166-187](#)

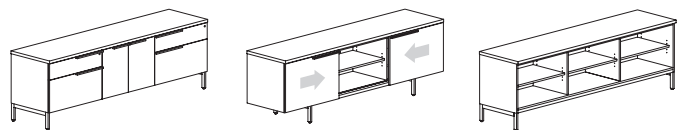

Secondary Height Credenzas [Page 188-211](#)

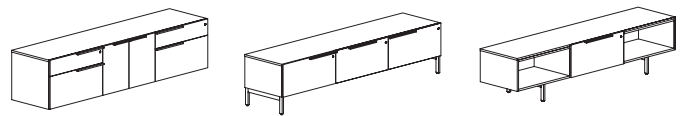

Cushions [Page 212-213](#)

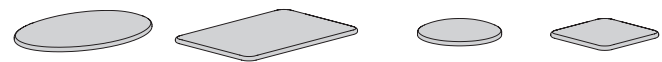

Adjustable Height Units [Page 214-251](#)

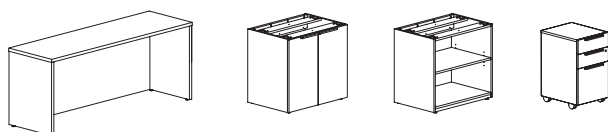
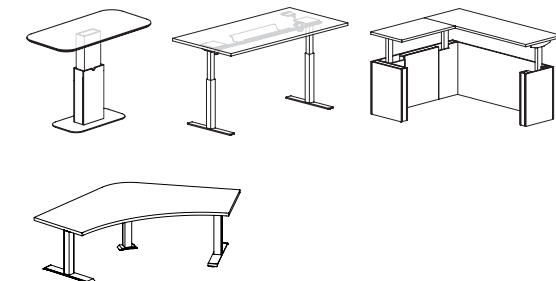

Flux Overview

Modular Units [Page 252-269](#)

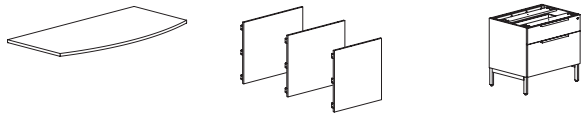

Overhead Cabinets/Panels (Primary Ht.) [Page 270-295](#)

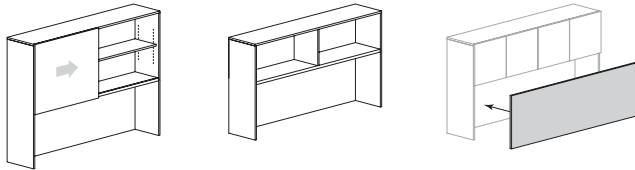

Overhead Cabinets/Panels (Secondary Ht.) [Page 296-309](#)

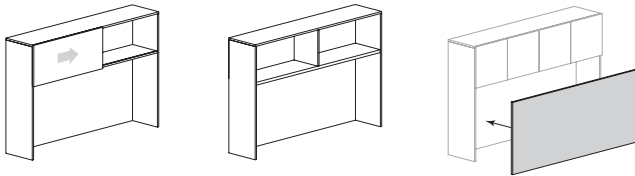

Wall Mount Overhead Cabinets [Page 310-329](#)

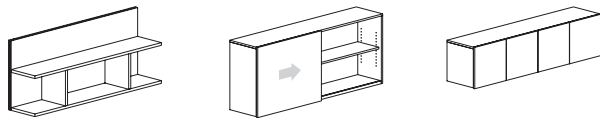

Wall Mount Cubbies [Page 330-335](#)

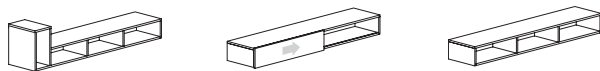

Wall Mount Panels/Accessories [Page 336-361](#)

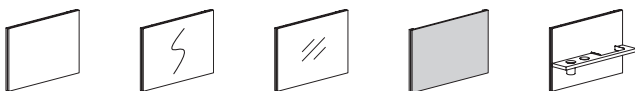

Storage Towers [Page 362-367](#)

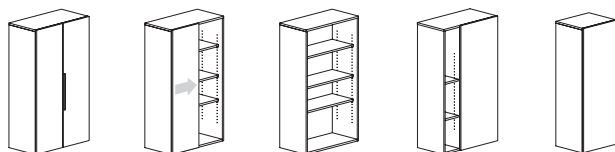

Monitor Cabinets [Page 368-375](#)

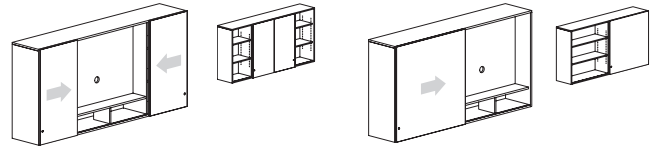

Bookcases/Vertical Filing [Page 376-379](#)

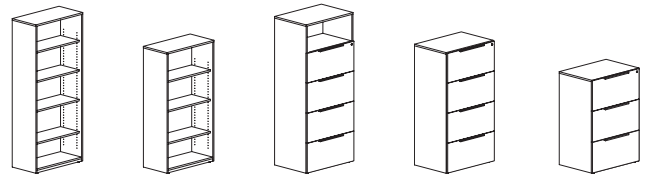

Wardrobes/Vertical Cabinets (to floor) [Page 380-413](#)

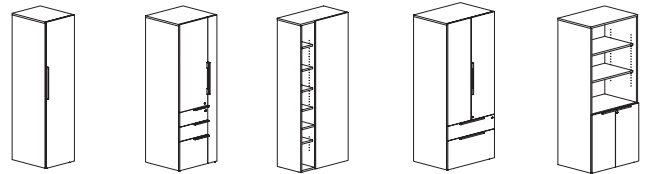

Wardrobes/Vertical Cabinets (on legs) [Page 414-441](#)



Pantries [Page 442-444](#)

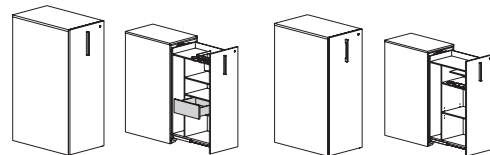

Lockers [Page 446-453](#)

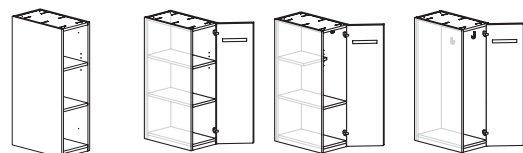

Accessories [Page 454-459](#)

Flux General Options

Laminate Products

Flux Laminate features TFL (thermally fused laminate) chassis, lockers and components. Main worksurfaces* are available in a HPL (high pressure laminate).

Eased edges of the worksurface are impact resistant (PVC) on HPL tops. The laminate is offered in wood grain patterns and solid colors. The wood grain laminate features an embossed grain to hide finger prints and light scratches. The solid laminate is smooth to the touch with a semi-matte finish. All Flux Laminate products are indoor-air certified by GreenGuard.

Laminate Worksurface Construction

Worksurfaces have a 3-ply balanced construction. Tops are 1 3/16" thick with coordinating PVC edges. Primary worksurfaces feature 3mm PVC edges on the approach and user sides. Main worksurfaces are offered in HPL. Desk, bridge, return, and primary height credenza worksurfaces are profiled with a 3mm PVC edge on the user side only. Remaining edges are banded with 1mm PVC which creates a seamless appearance when units are mated end-to-end or back-to-back.

HPL Features on Main Worksurfaces*

- fusion of multiple layers create a higher impact resistant surface
- tops are 3-ply balanced construction
- matched to the TFL wood grain and solid patterns

Case Construction

Panels for chassis consist of a 3/4" thick substrate with TFL surfaces and PVC bands on exposed edges. Pedestal and cabinets are constructed with dowels reinforced with screw and interior plates for increased stability. Leveling glides are set into metal housing corner plate to allow for maximum leveling.

*Main Worksurfaces include tops on desks, primary height credenzas, returns, bridges and transaction tops. Refer to pricing pages to confirm availability.

Veneer Products

Exterior wood surfaces are made from the finest selected veneers to achieve clarity and consistency in the Flux Veneer product line. To attain a pleasing, symmetrical pattern, all cherry, maple, black oak and walnut veneers in Flux Veneer are book-matched. All exterior solid lumber is matched to coordinate with the veneer.

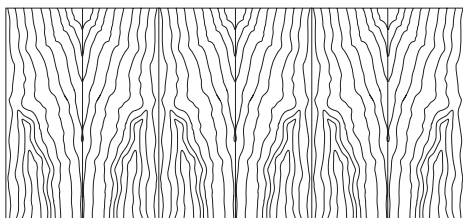

Veneer Book-Matched Example

Alternating pieces of veneer are flipped over so they face each other like the pages within a book.

Flux Veneer is available in flat cut cherry, maple, black oak and walnut veneer. A wide range of wood stains have been formulated to enhance the beauty of the veneer.

Double Cut veneer is another choice on Flux Veneer product. This veneer is a processed product that has at least two cuttings to create the final veneers. These cuts of veneer strands are dyed and layered into a block to create a wide variety of patterns, from a very tight grain pattern to an exotic figure grain pattern. Linear grain patterns can be run vertical or horizontal. Please specify the grain direction.

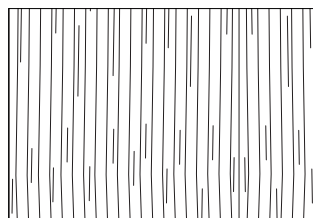

Double Cut Veneer - Tight Grain

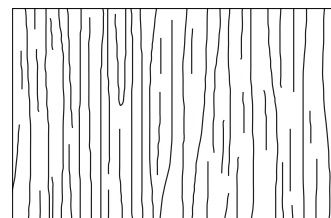

Double Cut Veneer - Natural Grain

Veneer Worksurface Construction

Tops are 3-ply balanced construction, 1 3/16" thick with matching 1.5mm wood edges. Surfaces are available in wood veneer or high pressure laminate. No additional charge for using our coordinating high pressure laminate with a veneer grain pattern with finish wood edges.

Protective Top Coat

DuraTex™ offers exceptional hardness along with abrasion and impact resistance. It has been formulated to eliminate hazardous and harmful gases that are normally associated with wood finish.

DuraTex™ Features

- Safety - Significantly reduces hazardous formaldehyde emissions which help improve the quality of the of the indoor air we breathe.
- Quality - Developed to be tough and durable with special attention to appearance. The DuraTex™ finish preserves the natural beauty of wood.
- Durability - Designed to meet a wide range of demanding performance and environmental standards to withstand even the highest wear and tear.

Special Finishes

Special finishes can be requested by following the instruction in the general introduction section, page V. There is a one-time charge of **\$384** list per order.

Finish Sheen

All veneer finishes are standard in 35-sheen, with the exception of Raven. Raven is only offered in 15-sheen. All other finishes can have their sheen modified with a 15% upcharge added to the list price of each item.

Flux General Options

Flux Standard Laminate Offering

The chart below lists the laminates available on Flux.

Laminate Options

TFL - HPL Wood Grain Pattern Laminates

BEL Belair	MIN Mineral
BRK Brickdust	MCH Mocha
CSK Cask	OBK Outback
CLY Clay	PIL Pilsner
EGR Egret	PIN Pinnacle Walnut
FAW Fawn	UMB Umber
FLN Flint	VAL Valley
FLO Florence Walnut	WLH Walnut Heights
LOF Loft	WEA Weathered Ash
MES Mesa	

TFL - HPL Solid Laminates

ALB Alabaster	SHD Shadow
BLK Black	SLG Slate Grey
BBL Bridal Blanco	ZEN Zen Grey
DWH Designer White	

Flux Color Scheme – Accent Colors

Metal Accents

ABZ Aged Bronze	PEW Pewter
ASL Arctic Silver	SBZ Soft Bronze
GLD Gold	SNK Soft Nickel
MBK Matte Black	

Items below are available in any of the seven color schemes listed above:



drawer pulls



grommets



side grommets

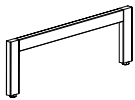

static legs, end frames, and post frames



metal wire managers

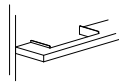

hanging folder brackets

* Note: Height adjustable legs are not offered in all seven color schemes

Black Accents

MLK	Matte Black
-----	-------------

Items below are standard as matte black:



oval grommets

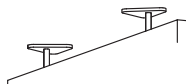

hanging modesty brackets

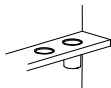

desk accessories

Flux Standard Veneer Finish Offering

The charts below list the veneer stains and paints available on Flux.

Finish/Stain Colors

ESS Essentials Veneer Collection

BRK Brickdust	MIN Mineral
CSK Cask	MCH Mocha
CLY Clay	OBK Outback
FAW Fawn	PIL Pilsner
FLX Flax	SIE Sienna
FLN Flint	TRF Truffle
LOF Loft	UMB Umber
MES Mesa	VAL Valley

ART Artisan Veneer Collection

BAR Barrel	RAV Raven
BUF Buff	RYE Rye
CND Cinder	SAB Sable
EGR Egret	SAD Saddle

PNT Paint Color

BKD Backdrop	NWH Nonchalant White
BFX Black Fox	SVP Silverplate
BWH Bright White	SKS Skyline Steel
CHT Chatroom	STM Storm
GAL Gale Force	TRC Tricorn Black
GRV Greek Villa	UKH Universal Khaki

Contact Customer Service for any additional veneer species. Samples available upon request.

Veneer Chassis with Laminate Tops

Worksurface only, no additional upcharge if Flux's coordinating wood grain laminate is specified. Contact Customer Service for any other laminate request. Listed below are finishes with coordinating wood grain HPL laminates.

ESS Essentials Veneer

BRK Brickdust	MIN Mineral
CSK Cask	MCH Mocha
CLY Clay	OBK Outback
FAW Fawn	PIL Pilsner
FLN Flint	UMB Umber
LOF Loft	VAL Valley
MES Mesa	

ART Artisan Veneer

EGR	Egret
-----	-------

Flux General Options

Desk Pedestal Configuration

The following are standard configurations for Flux pedestal desks.

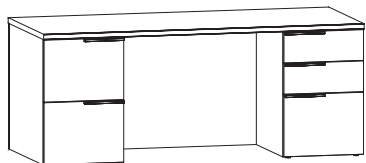

Double Pedestal Desk

Left side: file/file
Right side: box/box/file

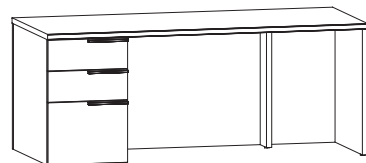

Single Pedestal Desk

box/box/file

The 18" w and 15- 5/8" w pedestal configuration can be switched from box/box/file to file/file or from file/file to box/box/file. This configuration change applies to desks, open corner credenzas and kneespace credenzas at primary height without legs. This must be specified on the order, with an upcharge of **\$198** list per pedestal.

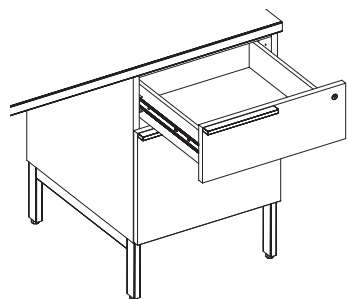

Drawer Information

Flux is standard with a unidirectional V-fold drawer box interior. The box is a durable, miter-fold drawer structure which is glued and doweled. The ½"-thick drawer sides are wrapped in a high-grade maple vinyl, with an attached front. The drawer front is attached to the four sided box.

Wood Drawer Boxes

Optional four corner dovetailed wood drawers are available. Specify and add 10% per unit.

Drawer Suspension

High quality black drawer suspension carries a lifetime warranty. File and box drawers have 100% full extension with over travel. Slides feature steel ball bearings for longer wear and positive, cushioned in/out stops.

Filing Hardware

All file drawers are constructed with a custom design for hanging folders. See filing diagram on next page.

Locking

All desks, credenzas, returns and mobile pedestals feature pedestal front locking to provide maximum security and flexibility in configuration. Units are shipped randomly keyed as standard. Key-alike units are available upon request for no additional charges. Removable cores for in-field re-keying are standard.

Lock face color is controlled by the metal color of the unit.

Aged Bronze, Gold, Pewter, Matte Black and Soft Bronze = Black Lock Face
Soft Nickel and Arctic Silver = Silver Lock Face

Interior compartment

Interior compartment sizes and specification matrix on pages 24-25 and 35.

Special Construction

Flux has an extensive product offering to create many types of configurations. Contact Customer Service if you are having trouble with finding the right units to complete the desired configuration. Requests for special construction need to be approved by JSI engineering.

Flux General Options

Filing Drawer Details

Desk and credenza pedestal filing drawers come with hardware to accommodate letter or legal files. File orientation options vary by pedestal size, as shown below. Legal and letter files may be arranged side-to-side in any pedestal, or front-to-back in larger pedestals. Select only one orientation for each filing drawer. Reference the following plan views for available options.

File Orientation Variations (top view)

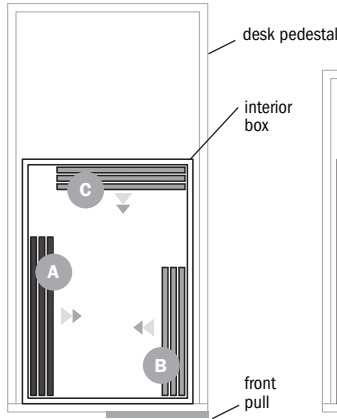

Overall Desk - 84" w through 72" w
 Desk Pedestal - 36" d x 18" w
 Interior Box - 22" d x 15 7/16" w

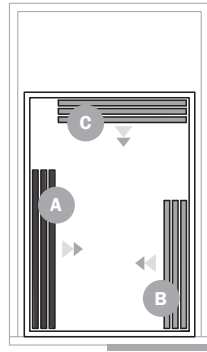

Overall Desk - 84" w through 72" w
 Desk Pedestal - 30" d x 18" w
 Interior Box - 22" d x 15 7/16" w

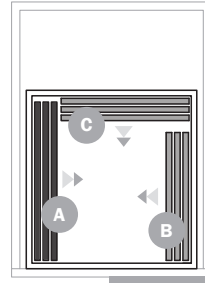

Overall Desk - 84" w through 72" w
 Desk Pedestal - 24" d x 18" w
 Interior Box - 16" d x 15 7/16" w

- A** Legal - Side-to-Side
- B** Letter - Side-to-Side
- C** Letter - Front-to-Back
- D** Legal - Front-to-Back

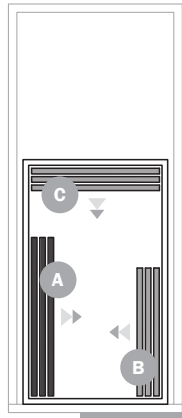

Overall Desk - 66" w through 60" w
 Desk Pedestal - 36" d x 15 7/16" w
 Interior Box - 22" d x 13" w

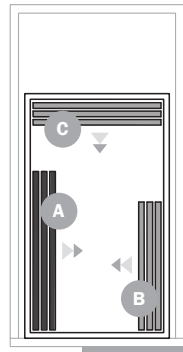

Overall Desk - 66" w through 60" w
 Desk Pedestal - 30" d x 15 7/16" w
 Interior Box - 22" d x 13" w

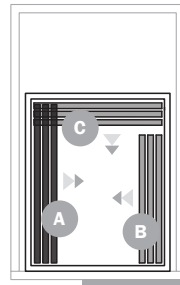

Overall Desk - 66" w through 60" w
 Desk Pedestal - 24" d x 15 7/16" w
 Interior Box - 16" d x 13" w

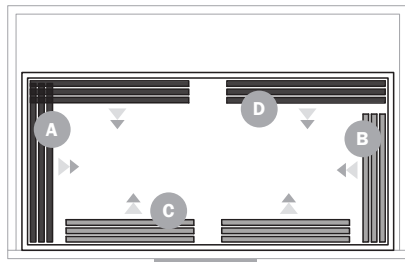

Overall Credenza - 72" w or 36" w
 Credenza Pedestal - 22" d x 36" w
 Interior Box - 16" d x 33 7/16" w

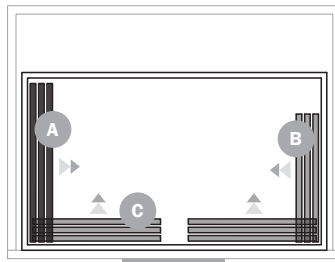

Overall Credenza - 96" w, 90" w, 84" w, 78" w,
 66" w, 60" w, 54" w, 48" w, 42" w or 30" w
 Credenza Pedestal - 22" d x 30" w
 Interior Box - 16" d x 27 7/16" w

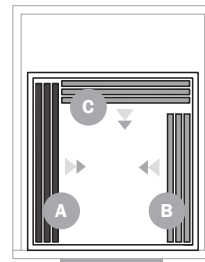

Overall Credenza - 96" w, 90" w,
 84" w, 78" w or 72" w
 Credenza Pedestal - 22" d x 18" w
 Interior Box - 16" d x 15 7/16" w

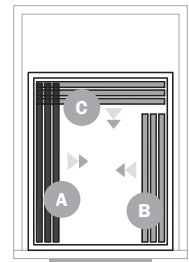

Overall Credenza - 66" w, 60" w,
 54" w, 48" w or 42" w
 Credenza Pedestal - 22" d x 15 7/16" w
 Interior Box - 16" d x 13" w

Flux General Options

Top Edge Profiles

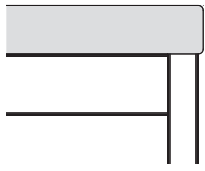

Eased Edge
Standard on worksurface tops

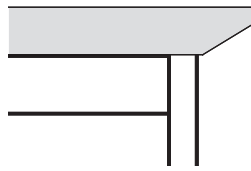

Reverse Bevel Edge
Optional on selected worksurfaces (see below)

Reverse Bevel Edge Location

Peninsula and Run-off Desks

The reverse bevel edge appears on three sides of the worksurface top, as shown to the right, and increases the depth of the top by 2½".

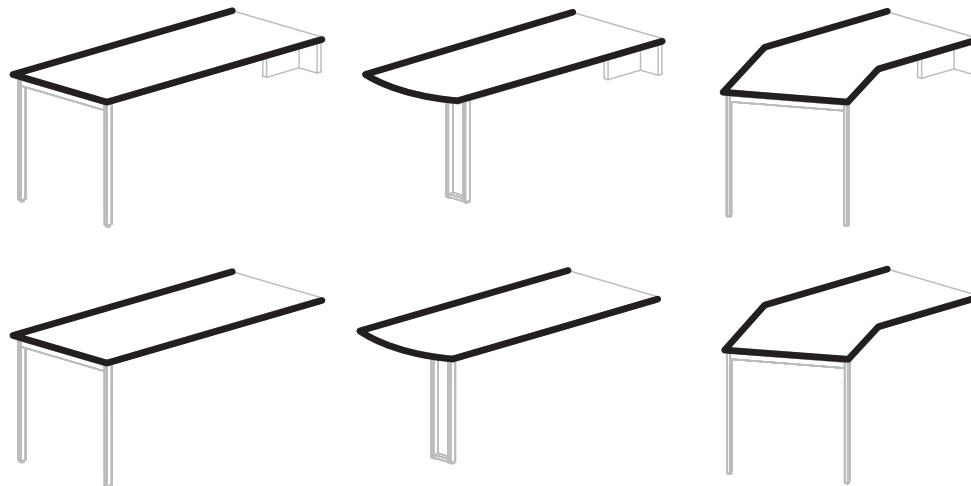

Adjustable Height Desks

The reverse bevel edge location varies according to its worksurface. When it appears on two sides, the depth of the worksurface increases by 2½". When the bevel appears on one side only, it increases the depth by 1¼". Dimension changes only happen when there is no overhang.

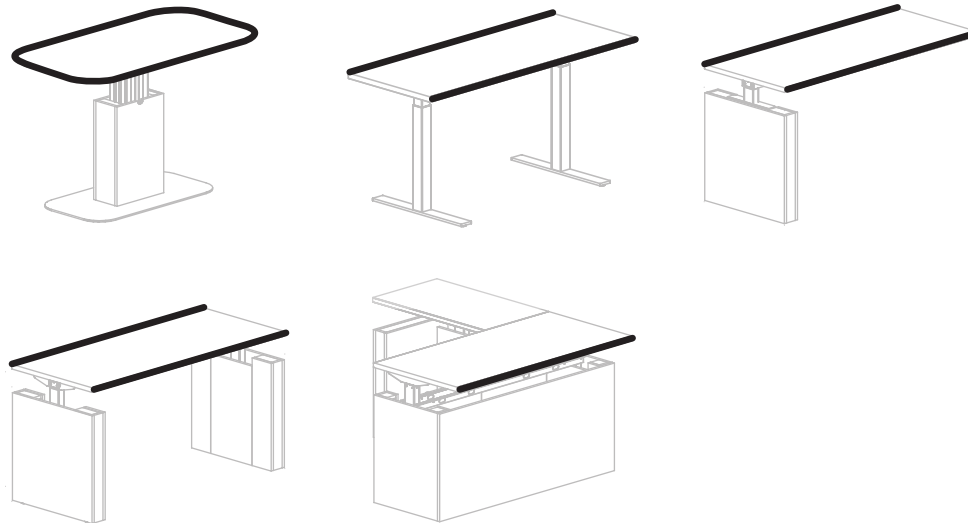

Tables

The reverse bevel edge location varies, as shown to the right, and increases the depth of the top by 2½" on the rectangle table.

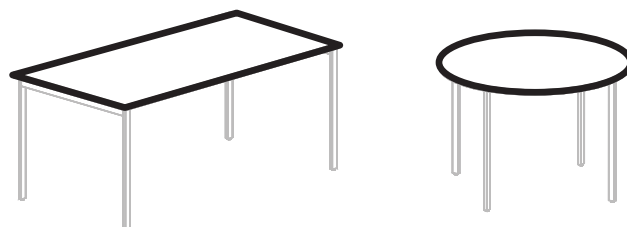

Flux General Options

Pulls and Pull Orientation

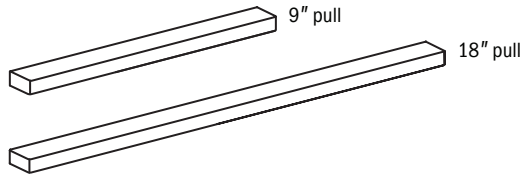

Ledge Pull

- Available in Aged Bronze, Arctic Silver, Gold, Matte Black, Soft Bronze, Soft Nickel or Pewter
- Ledge pull is considered part of the aesthetic of Flux and has unique orientation on the product. See chart below for these locations.
- Ledge pull length is determined by drawer/door width as follows:

9" pull	drawers/doors 18" wide or less
18" pull	drawers/doors wider than 18"



Prism Pull

- Available in Aged Bronze, Arctic Silver, Gold, Matte Black, Soft Bronze, Soft Nickel or Pewter
- Prism pull is mounted in the center of drawers on all drawer and lower doors widths. Upper pulls on worksurface towers or wardrobes are mounted on the right door only.

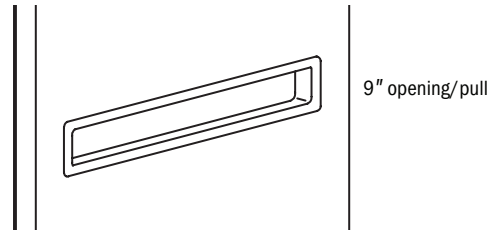

Mail Slot Pull (Lockers Only)

- In addition to Ledge and Prism pulls, mail slot is available on lockers only
- Available in Arctic Silver, Soft Nickel, Matte Black or Pewter

Lower Drawer/Door Ledge Pull Location

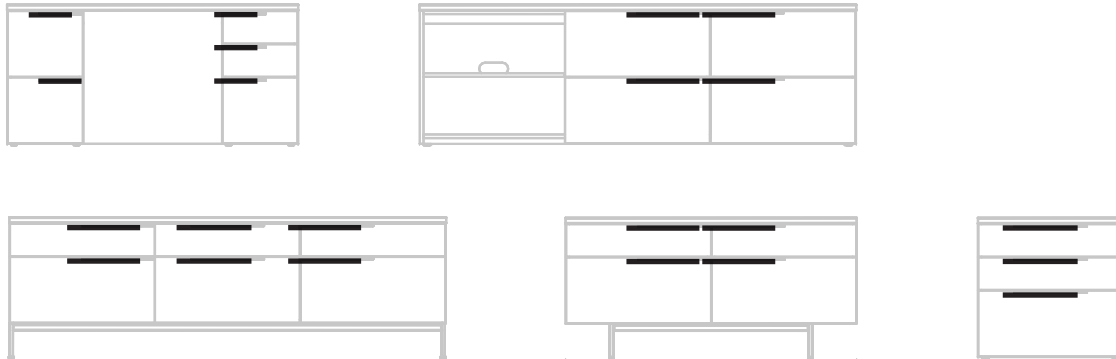

Tower/Wardrobe Ledge Pull Location

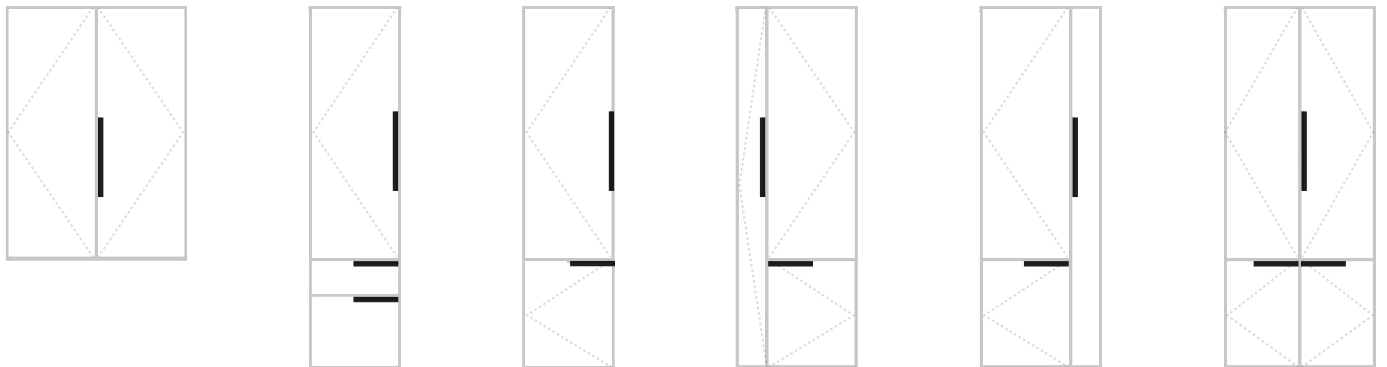

Flux General Options

Locker Pull and Lock Options

PRODUCT INFORMATION

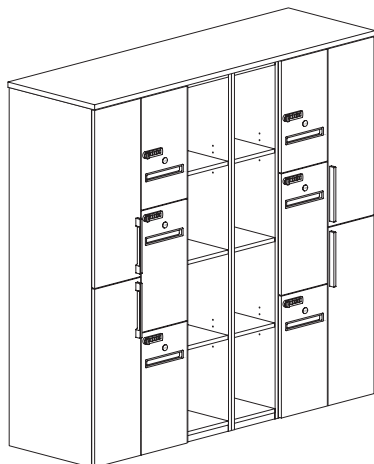

Lockers are available with a variety of pull and lock combinations.

Pulls

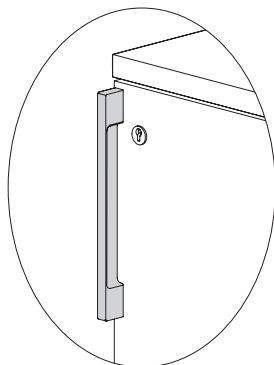

Ledge

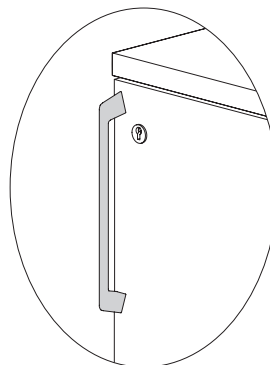

Prism

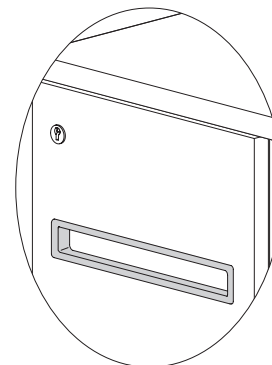

Mail Slot

Locks

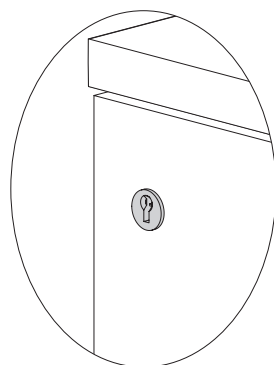

Standard

Standard lock and key. Black or silver finish. Ordered separately and field installed. Specify finish and number range. See page 455.
\$103 upcharge per lock.

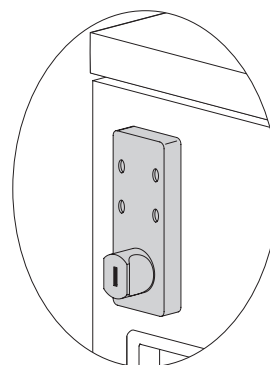

Keyless Radial

Temporary 4-digit code gets programmed by each user interaction. Built-in finger grip does not require additional pull. Prism and Ledge pulls not available. Satin Nickel finish. Master Key available, see page 455.
\$369 upcharge per lock.

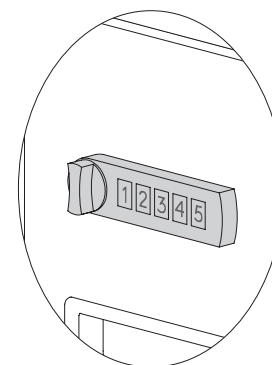

Digital Keypad

Temporary 4-digit code gets programmed by each user interaction (Locker Mode). May be reset to "Station Mode" for repeated use with a single code. Black or Silver finish. Master Key Fob available, see page 455.
\$416 upcharge per lock.

Locker Number Plates

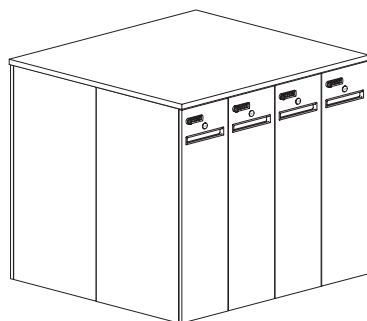

Locker number plates are available for identification. Adhesive backed for field installation. Ordered separately. Specify finish and number range, see page 455.

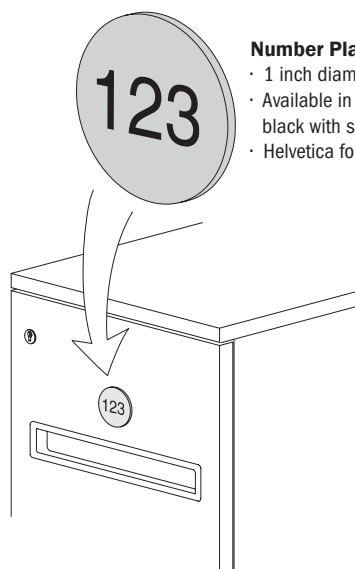

Number Plate

- 1 inch diameter aluminum
- Available in silver with black numbers or black with silver numbers
- Helvetica font, 1-3 characters

Flux General Options

Caster Option

Flux offers a dual wheel caster option with freestanding and four-star base tables, in place of standard feet.

Casters are gray when paired with Arctic Silver or Soft Nickel metal legs, or black with Aged Bronze, Gold, Matte Black, Soft Bronze or Pewter metal legs

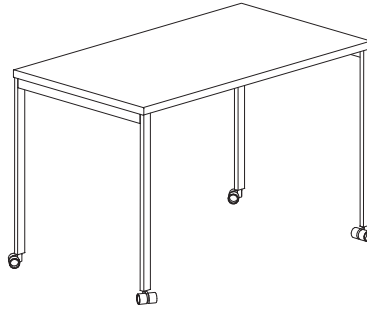
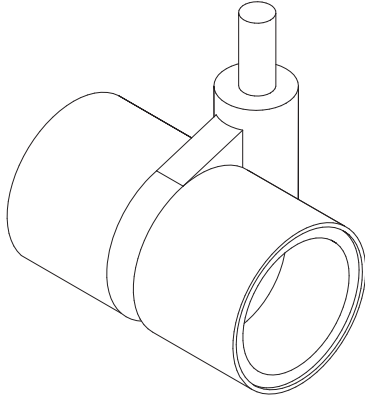

Freestanding tables with legs

Available with 2 locking and 2 non-locking casters



4-star base tables

Available with 4 locking casters

Flux General Options

Modesty Panel Options

Flux offers optional modesty panels for table desks, adjustable height desks, returns, bridges and credenzas. Reference the diagrams below for the modesty panel location on each unit.

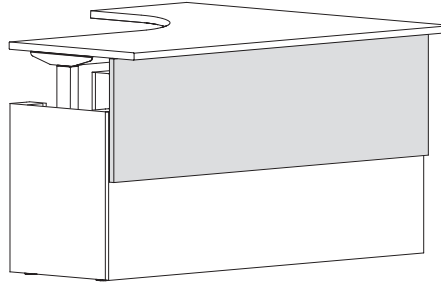
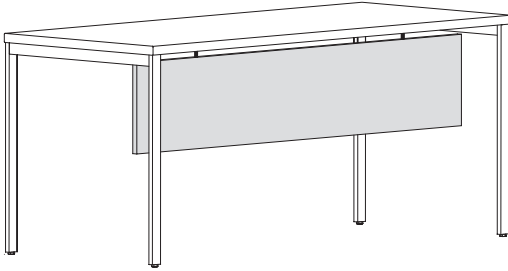
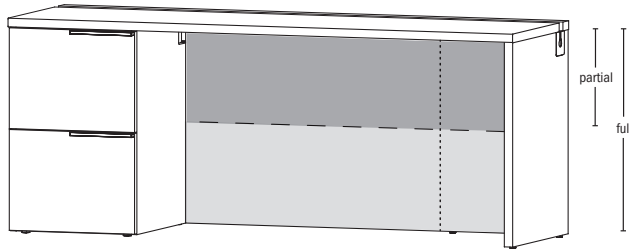
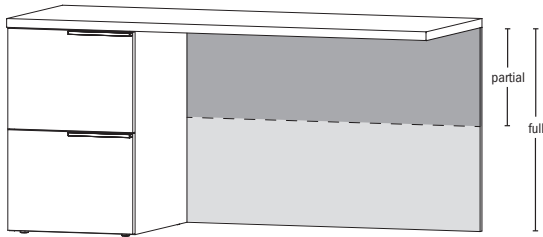

Table Desks

12" suspended modesty panels are available on table desks, peninsula desks, and run-off desks.

Adjustable Height Desks

Modesty panels are available on adjustable height desk shells. The modesty panel mounts in front of the desk and moves with the top.



Returns and Bridges

Partial or full modesty panels are available on return and bridge units.

Credenzas

Partial, full or removable modesty panels are available on credenzas.

Flux Applied Materials

Laminate Grain Direction

Laminate grain runs vertical as standard on all vertical surfaces except back panels, wall panels, kneespace access panels, and desk fronts **wider than 60"**, **which run horizontal**. Worksurfaces run long grain except for bridges, returns, and peninsula and run-off tops **60" and shorter, which run short grain**. Below are typical examples of laminate grain direction.

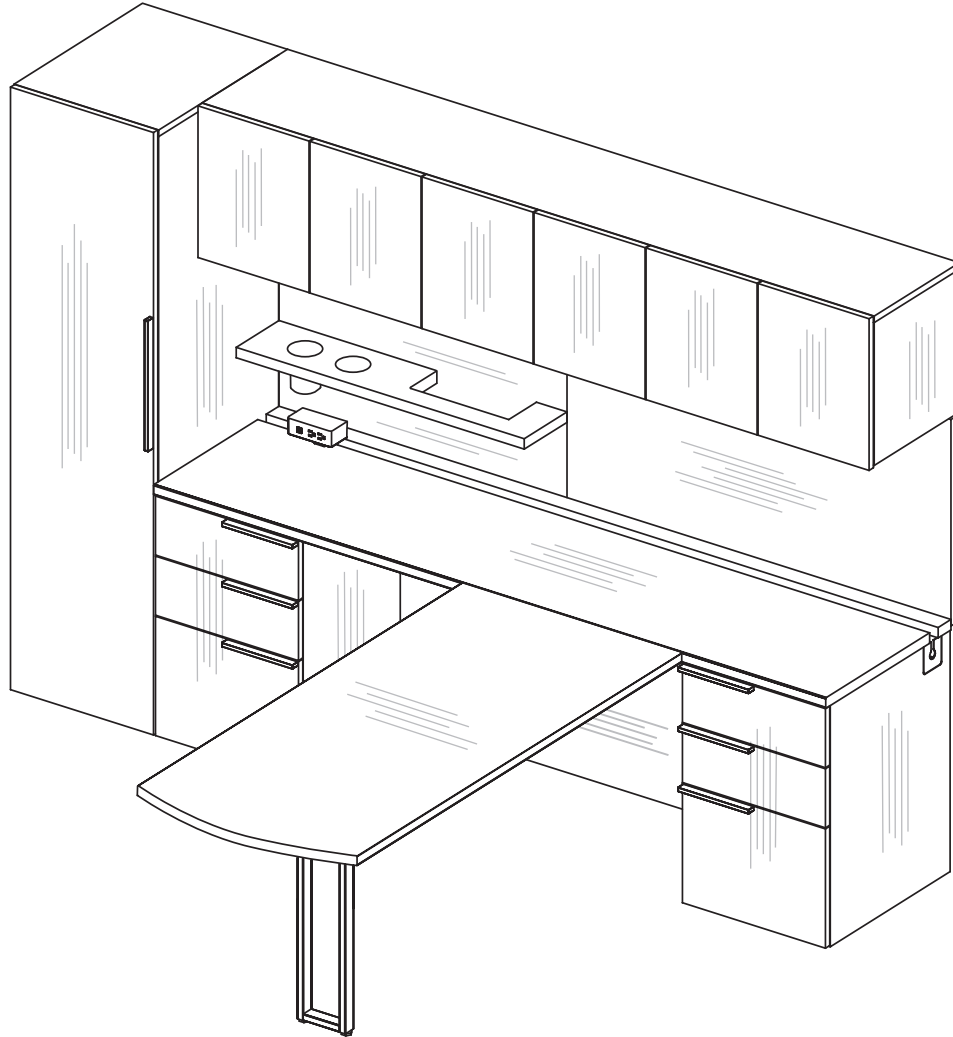

PRODUCT INFORMATION

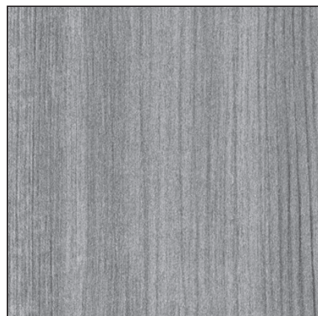

Laminate Grain

Laminate grain direction varies according to its casegood surface. Refer to the diagrams on this page for examples of standard direction.

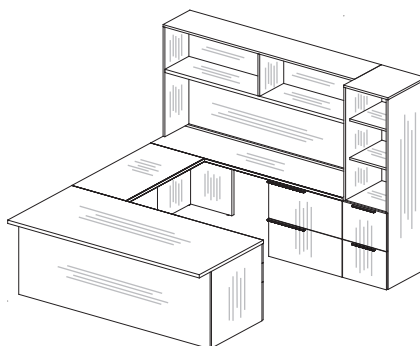

Flush Front Desk U Unit with Open Storage

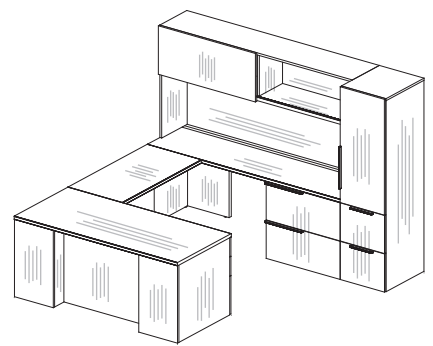

Breakfront Desk U Unit with Closed Storage

Flux Applied Materials

Vertical Veneer Grain Direction

All Flux veneer finishes can run vertical on all vertical surfaces. Worksurfaces run long grain except for bridges, returns, peninsula and run-off tops, which run short grain. Below are typical examples of vertical veneer grain direction.

PRODUCT INFORMATION

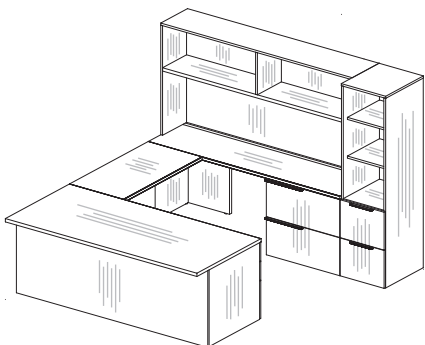

Flush Front Desk U Unit with Open Storage

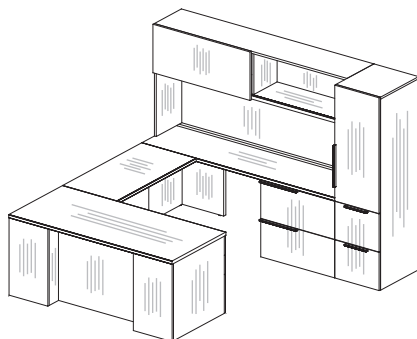

Breakfront Desk U Unit with Closed Storage

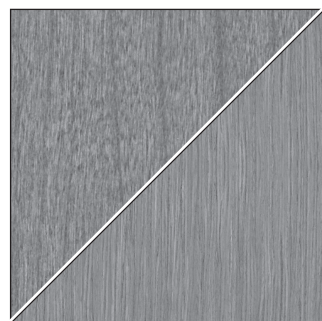
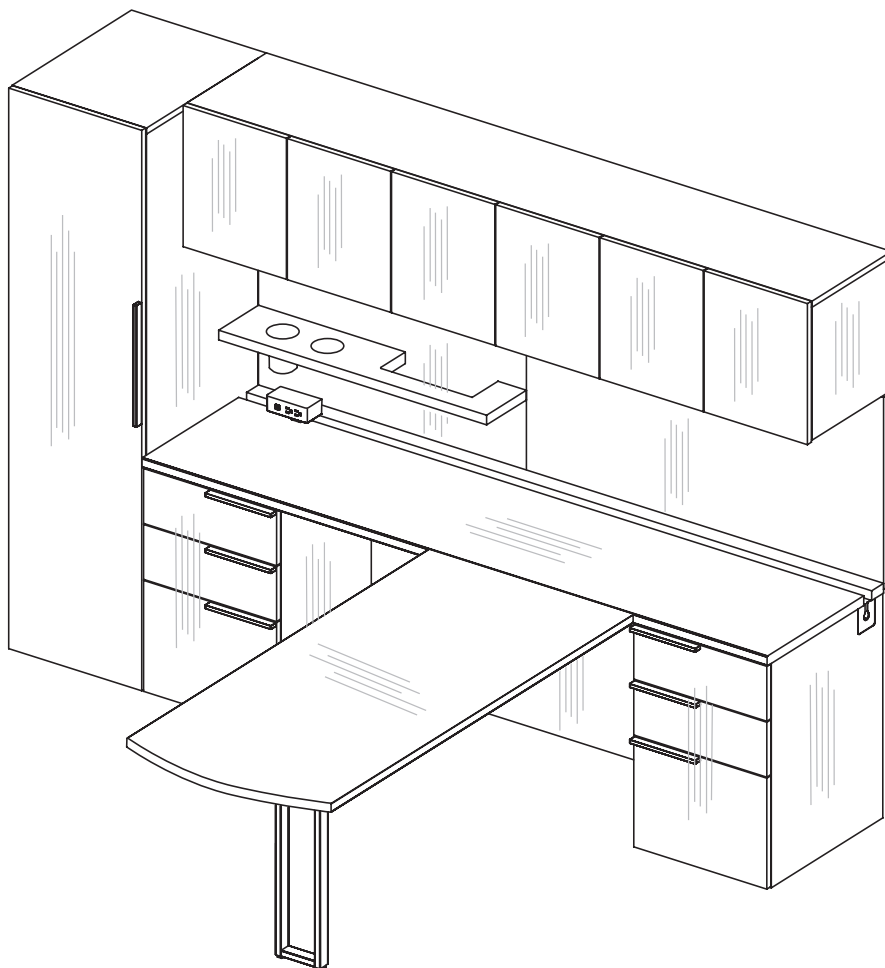

Vertical Grain Direction

Most veneer finishes run vertical as standard. Some linear grain patterns have an optional grain direction; specify at the time of order placement. See diagrams on this page for examples and exceptions.

Essentials Veneer

- Brickdust
- Cask
- Clay
- Fawn
- Flax
- Flint
- Loft
- Mesa
- Mineral
- Mocha
- Outback
- Pilsner
- Sienna
- Truffle
- Umber
- Valley

Artisan Veneer

- Barrel
- Buff
- Cinder
- Egret
- Raven
- Rye
- Sable
- Saddle

Flux Applied Materials

Horizontal Veneer Grain Direction

Linear grain patterns may be specified with a horizontal grain direction on all surfaces. Worksurfaces run long grain except for bridges, returns, peninsula and run-off tops, which run short grain. Below are typical examples of horizontal veneer grain direction.

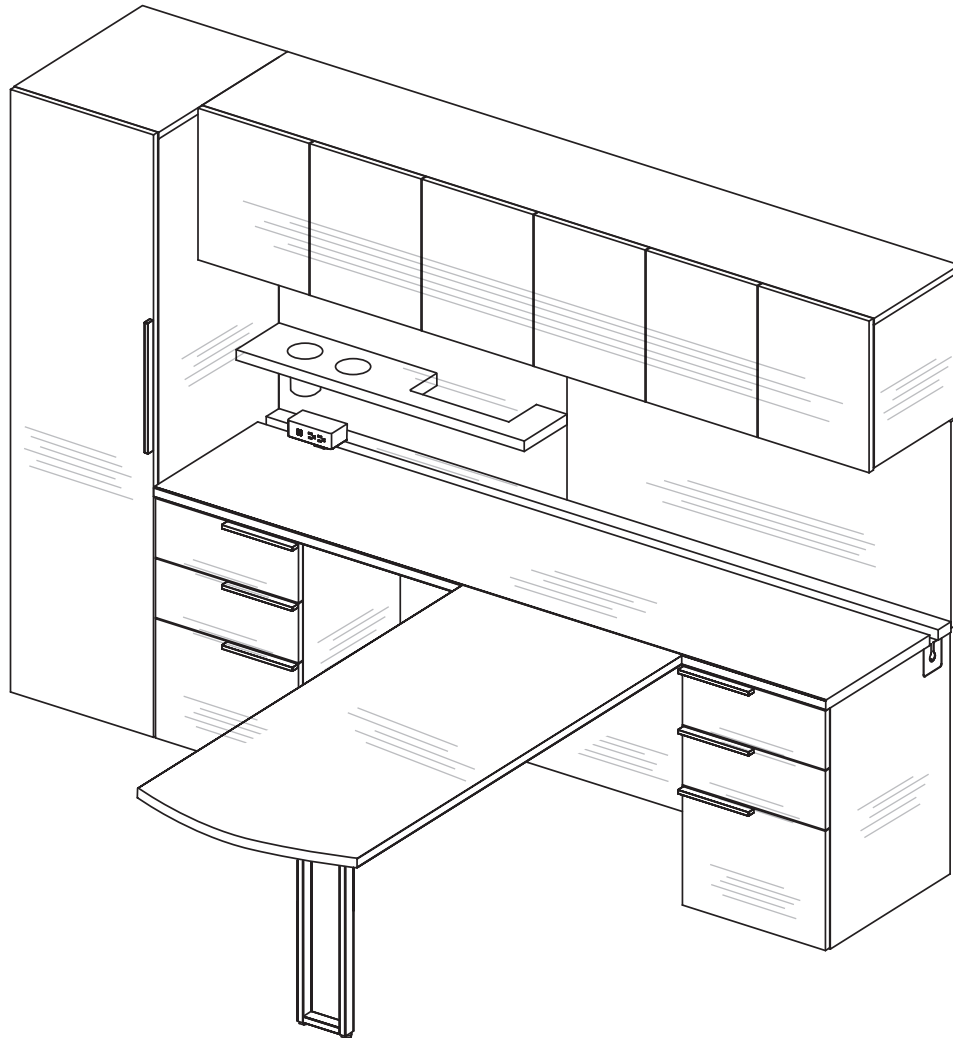

PRODUCT INFORMATION



Horizontal Grain Direction

Linear grain patterns may be specified to run horizontal; specify at the time of order placement. Refer to the diagrams on this page for examples.

Essentials Veneer Horizontal Grain Patterns: Fawn, Flint, Loft and Valley

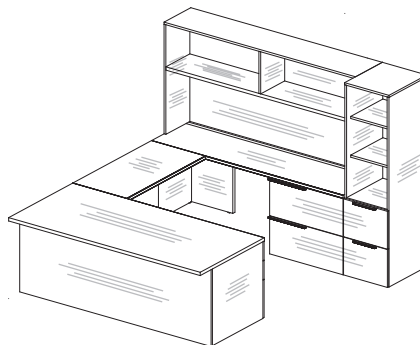

Flush Front Desk U Unit with Open Storage

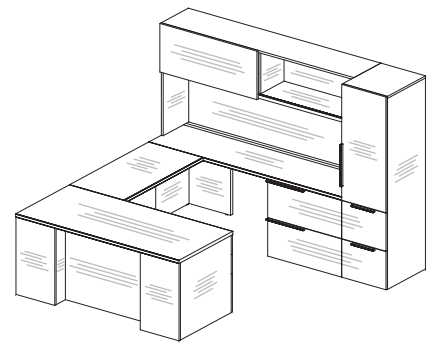

Breakfront Desk U Unit with Closed Storage

Flux Applied Materials

Flux Color Scheme

Flux offers the flexibility to specify contrasting drawer and door fronts, or a contrasting worksurface for laminates, separate from the standard chassis selection. See the options available below, depending on whether laminate or veneer is specified for the chassis.

PRODUCT INFORMATION

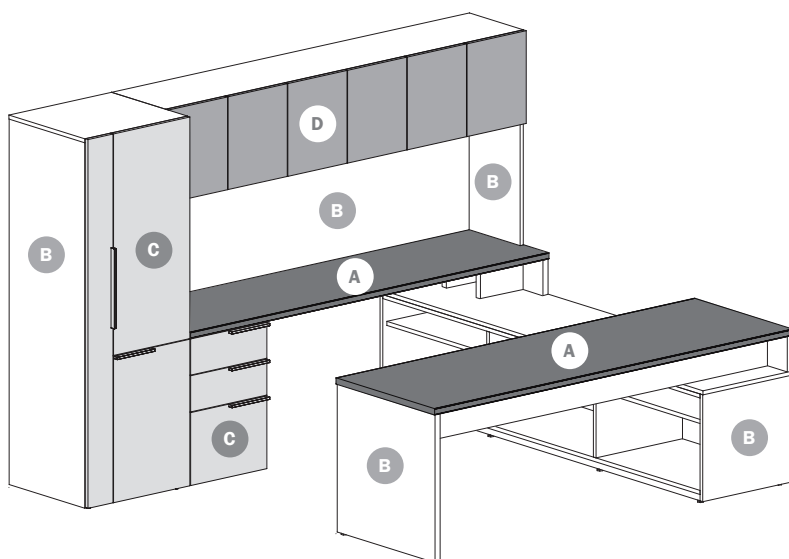

Laminate Surface Options

- A = Worksurface**
Laminate – see page 5 for selection
- B = Chassis**
Laminate – see page 5 for selection
- C = Drawer and Door Fronts**
 1. standard – same as chassis selection
 2. optional – contrasting laminate from standard selection
- D = Overhead and Worksurface Storage Doors**
 1. standard – same as chassis selection
 2. optional
 - a. contrasting laminate from standard selection
 - b. white back painted glass doors in an aluminum frame – see page 31
 - c. markerboard laminate with silver PVC edge see page 31

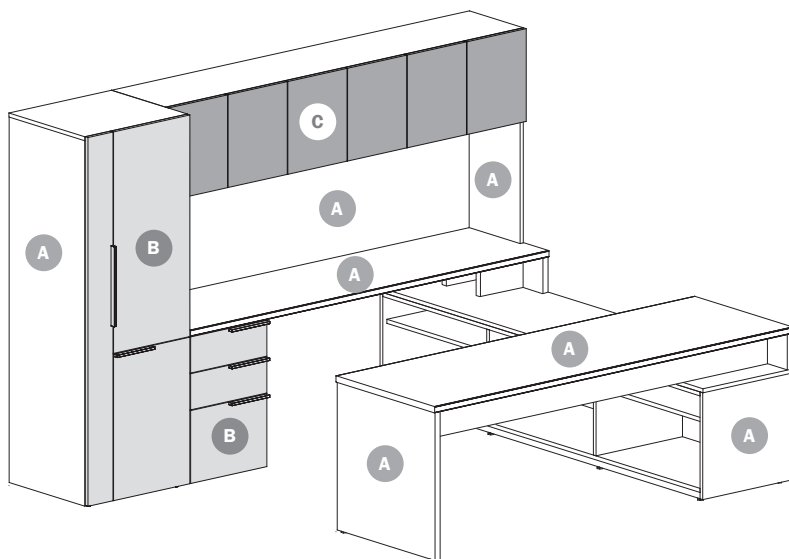

Veneer Surface Options

- A = Worksurface and Chassis**
Veneer – see page 5 for selection
- B = Drawer and Door Fronts**
 1. standard – same as chassis selection
 2. optional – paint color (vertical maple veneer substrate) – see page 5 for color selection
- C = Overhead and Worksurface Storage Doors**
 1. standard – same as chassis selection
 2. optional
 - a. paint color (vertical maple veneer substrate) see page 5 for color selection
 - b. white back painted glass doors in an aluminum frame – see page 31
 - c. markerboard laminate with silver PVC edge see page 31

Flux Desk Details

Pedestal Desks

Product Overview

The Flux pedestal desk is available with a break front or flush front. Options for wire management vary depending on the selected desk.

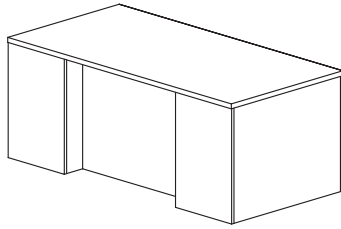

Break Front Desk

Pedestal access door optional

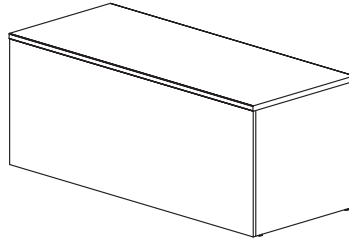

Flush Front Desk

Wire Manager Tray

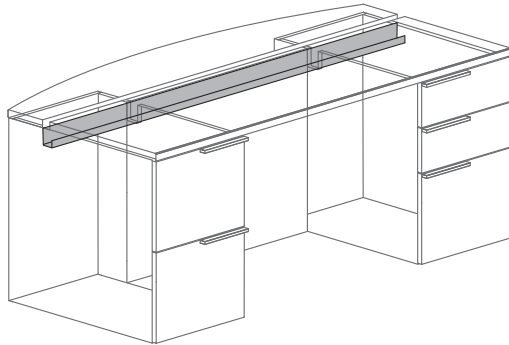

Desks with a split top have a continuous wire manager tray as a standard feature.

Note: desks do not have side end panel grommets.

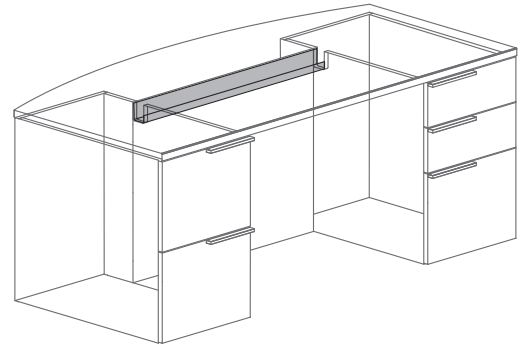

A wire manager tray can be ordered on desks with solid tops by optioning in the pedestal access door (available on break front desks) or by ordering a continuous wire manager tray.

Note: it is recommended that with either of these options, a top grommet be specified.

Pedestal Access Doors

Available on the front of break front desks to conceal cords. Both right and left pedestals of desk will have the access door with this option.

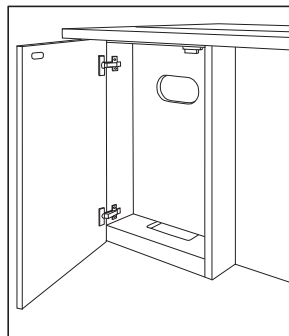

Flux Desk Details

Peninsula Desk with Secondary Credenza Support

Product Overview – Peninsula Desk

The Flux peninsula desk, which mounts to the top of a secondary height credenza for support, is available in a variety of top shapes and base styles. Edge profile and modesty panel options vary according to the style selected. Below are a few examples of top and base combinations.

PRODUCT INFORMATION

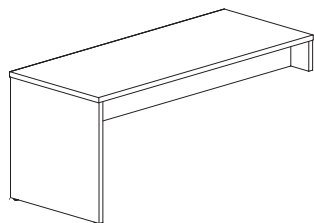

Rectangle Peninsula Table Desk with End Panel Support
Eased Edge only
Partial Modesty Panel standard

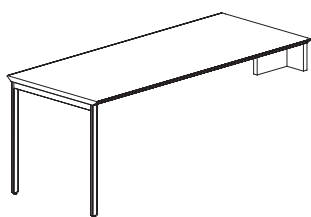

Rectangle Peninsula Table Desk with End Leg Assembly
Reverse Bevel Edge optional
Partial Modesty Panel optional

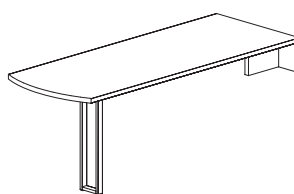

Arc End Peninsula Table Desk with Frame Base
Reverse Bevel Edge optional
Partial Modesty Panel optional

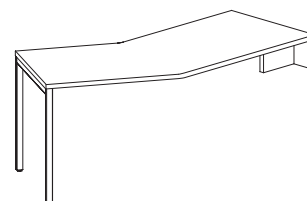

Boomerang Peninsula Table Desk with End Leg Assembly
Reverse Bevel Edge optional
Partial Modesty Panel optional

Product Overview – Secondary Height Credenza

The peninsula desk mounts to – and must be specified with – a secondary height credenza with an open compartment or sliding door compartment. See secondary height credenzas on pages 188-211 for pricing.

Secondary Credenza Examples

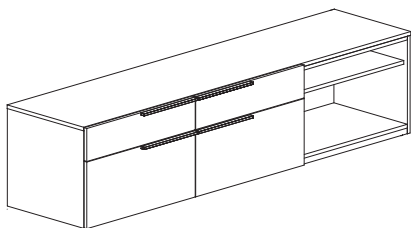

open compartment

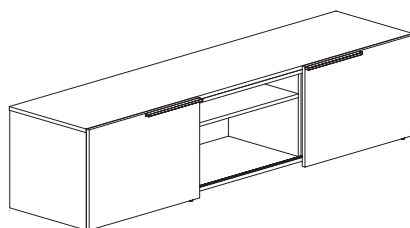

sliding door compartment

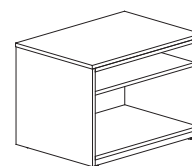

open compartment

Layout Requirements

27 1/2" desk can pair with any open compartment. 33 1/2" desk pairs with an open compartment 32" or greater in width.

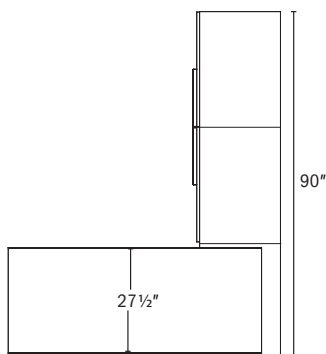

90" w credenza:
use 27 1/2" d desk

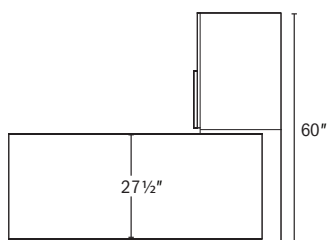

60" w credenza:
use 27 1/2" d desk

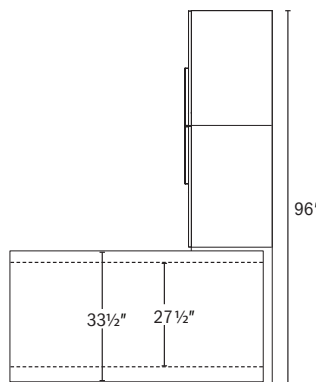

96" credenza:
use 27 1/2" d or 33 1/2" d desk

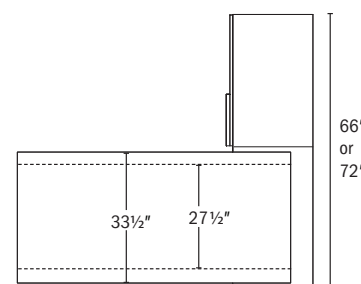

66" or 72" credenza:
use 27 1/2" d or 33 1/2" d desk

Flux Desk Details

Ordering the Secondary Height Credenza

When ordering the credenza, the mounting location for the peninsula desk must be specified as Left (L), Center (C) or Right (R), and the peninsula depth must be specified (22", 27 1/2" or 33 1/2"). A cut out for a power module in the credenza top may be specified by adding the letter E to the order code.

Mounting Code Table

Peninsula Depth	Left Mount	Center Mount	Right Mount	Left Mount with Power	Center Mount with Power	Right Mount with Power
22"	L22	C22	R22	L22E	C22E	R22E
27 1/2"	L28	C28	R28	L28E	C28E	R28E
33 1/2"	L34	C34	R34	L34E	C34E	R34E

Mounting Code Examples

L 28 = mounts **Left**, with a **27 1/2"-deep** peninsula desk

C 28 = mounts **Center**, with a **27 1/2"-deep** peninsula desk

R 28 = mounts **Right**, with a **27 1/2"-deep** peninsula desk

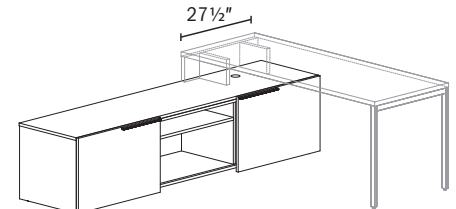
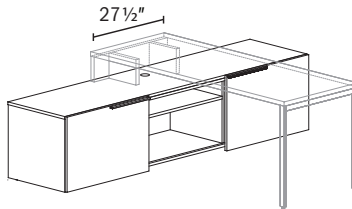
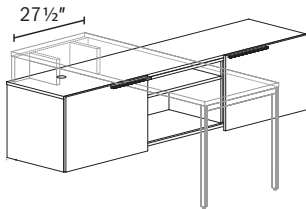

Technology Integration

Each mounting location comes with a 2 1/2"-diameter grommet for wire management. An EC26 power module cut out may also be added, and must be specified when ordering by adding the letter E to the mounting code. The power module must be ordered separately. See page 444.

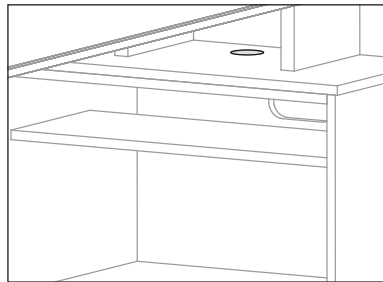

2 1/2"-diameter grommet

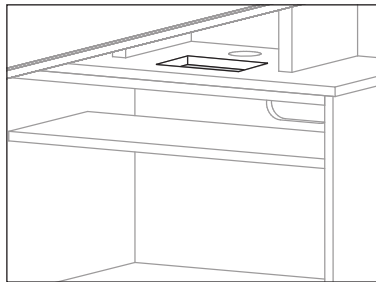

EC26 power module cut out

Power Module Cut Out Code

L 28 E

The grommet and EC26 power module locations are predetermined when selecting the peninsula mounting options; additional grommets or EC26 power modules can be specified at other locations on the secondary credenza. See page 45.

Flux Desk Details

Placement Locations

The peninsula desk may mount flush to the back panel of the credenza, or offset 5" to allow for an overhead hutch. Placement locations can be selected during field installation.

PRODUCT INFORMATION

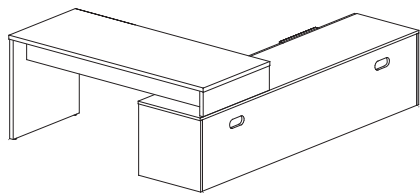

Placement 1 - Flush with Credenza Back

Can be used when no overhead storage is specified in the layout.

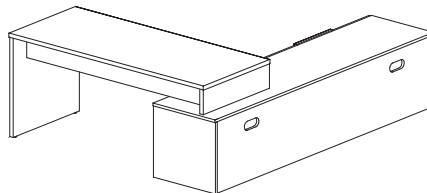

Placement 2 - Offset 5" from Back Panel

Must be used when placing an overhead on the secondary credenza.

Note: the overall foot print grows by 5"

Reverse Bevel Edge Rules

A reverse bevel edge adds 1 1/4" to the front of the desk top. Overheads that mount on the secondary credenza cannot be used with peninsula desks with reverse bevel edges. For more on edge profiles, see page 8.

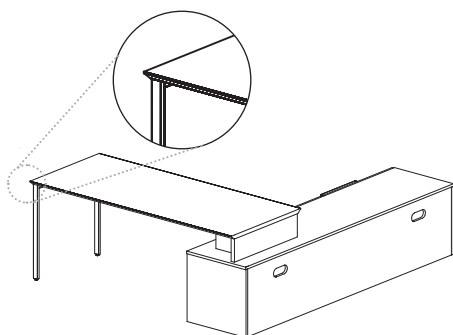

Peninsula desk with reverse bevel edge

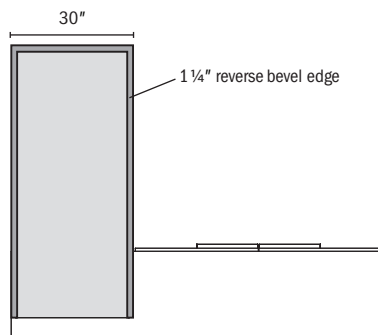

Plan view of peninsula with reverse bevel edge

Note: lacks required space for overhead mounting

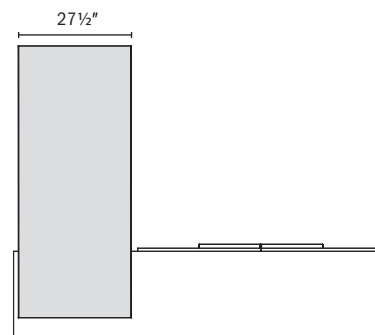

Plan view of peninsula with standard eased edge

Note: allows room for overhead mounting

Flux Desk Details

Run-off Desks

Product Overview

The Flux run-off desk, which mounts perpendicular to primary height credenzas, is available in a variety of top shapes and base styles. Edge profile and modesty panel options vary according to the style selected. Below are a few examples of top and base combinations.

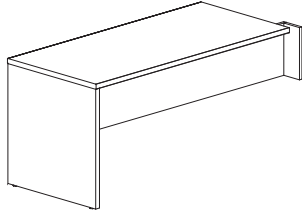

Rectangle Run-off Desk with End Panel Support
Eased Edge only
Partial Modesty Panel standard

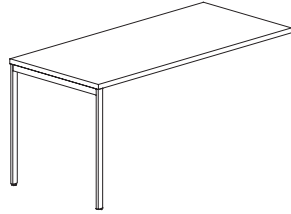

Rectangle Run-off Desk with End Leg Assembly
Reverse Bevel Edge optional
Partial Modesty Panel optional

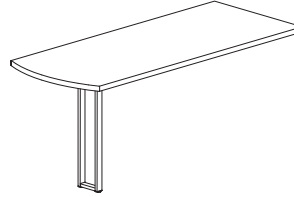

Arc End Run-off Desk with Frame Base
Reverse Bevel Edge optional
Partial Modesty Panel optional

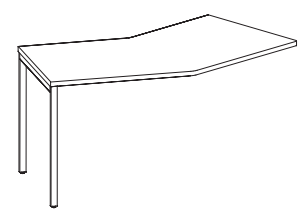

Boomerang Run-off Desk with End Leg Assembly
Reverse Bevel Edge optional
Partial Modesty Panel optional

Run-off Desk Attachment

The run-off desk mounts perpendicular to primary height units, and ships with two sets of brackets, for two types of credenzas attachments:

(1) Open Compartment Credenza

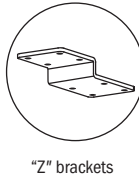
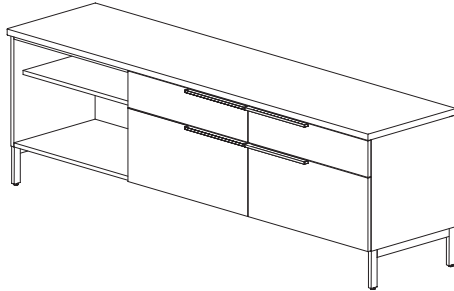

"Z" brackets

The run-off desk can be mounted to a credenza with open compartments. It attaches to the underside of the credenza with **"Z" brackets**. Run-off desks can not be mounted in sliding door compartments.

(2) Open Corner, Shell or Modular Credenza

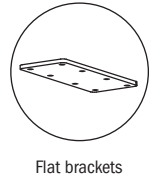
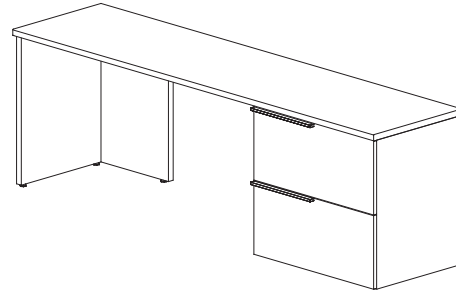

Flat brackets

The run-off desk can be mounted to an open corner credenza, credenza shell, or modular credenza. It attaches to the underside of the credenza with **flat brackets**. Use this type of credenza with run-off desks that have End Panel Supports with standard modesty panels.

Grain Direction

Grain direction runs "short" on run-off tops, though laminate tops longer than 60" run long grain. For more details, please reference grain direction on pages 11-13

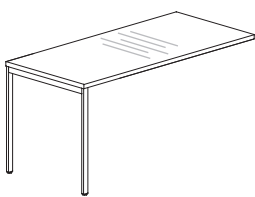

Short Grain
All veneer run-off tops
Laminate tops 60" or shorter

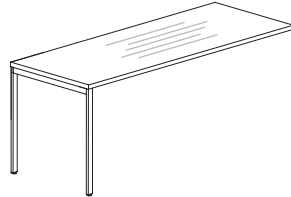

Long Grain
Laminate tops longer than 60"

Modesty Panels

13 1/2"-high hanging modesty panels are available for desks with End Leg Assembly or Frame Base. Desks with an End Panel Support come standard with an integrated modesty panel.

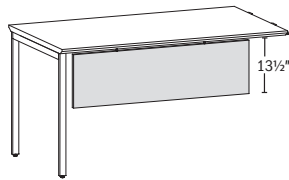

Hanging Modesty Panel
Optional for desks with metal bases

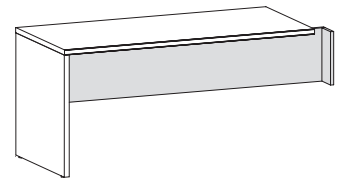

Integrated Modesty Panel
Standard with End Panel Support desks

Flux Desk Details

Adjustable Height Desks and Tables

Product Overview

Flux adjustable height desks and tables are available in a variety of top shapes and base styles, with pneumatic or electrical lift mechanisms. Metal finishes, wire management and modesty panel options vary according to the style selected. Below are various styles with adjustable height ranges.

PRODUCT INFORMATION

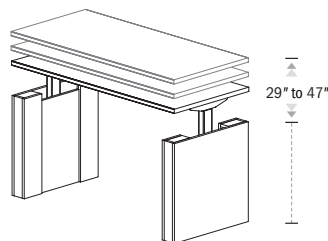

Adjustable Height Desks, Credenzas and Returns

Electrical lift mechanism
Adjustable range of 18"

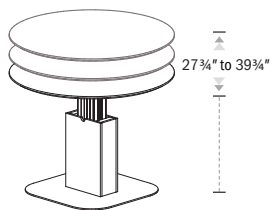

Adjustable Height Table Desks (meeting tables)

Electrical lift mechanism
Adjustable range of 18"
Round, square or rectangle shapes

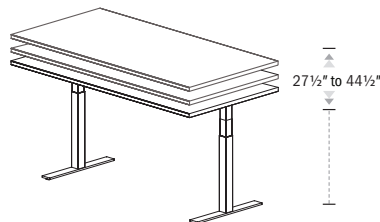

Adjustable Height Tables

Electrical or pneumatic lift mechanism
Adjustable range of 17"



Side Tables

Pneumatic lift mechanism
Adjustable range of 12"
Round, square or rectangle shapes
Nest with primary worksurfaces

Color Scheme

The finish on the adjustable lift column **A** will automatically be silver if you select Arctic Sliver or Soft Nickel metal. If Aged Bronze, Gold, Matte Black, Soft Bronze or Pewter metal is selected, the lift column **A** will be black.

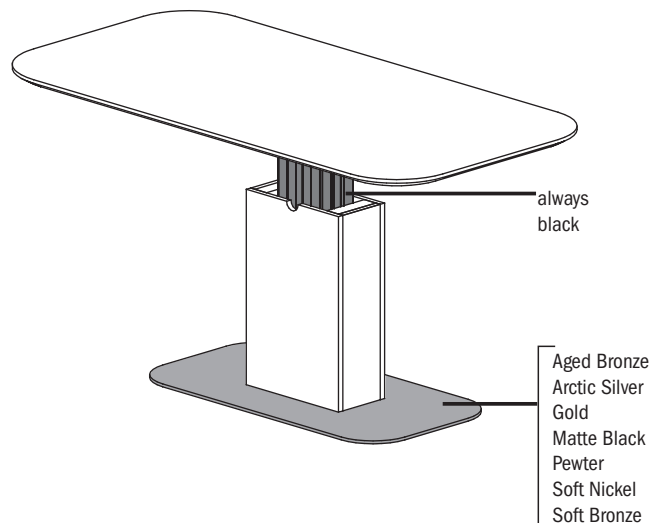
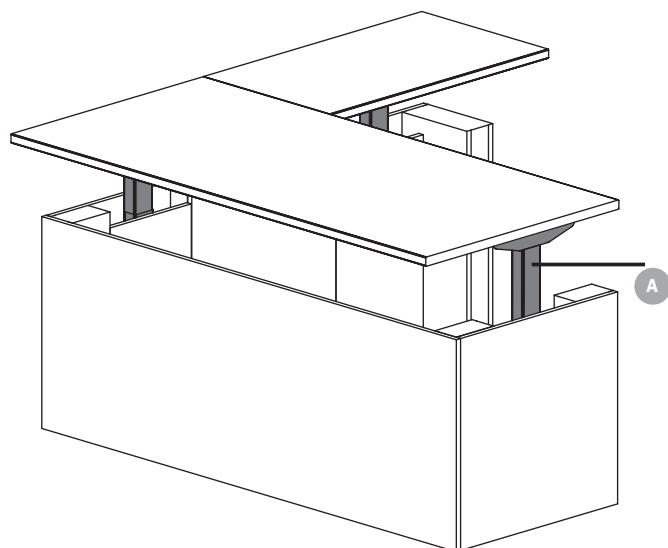

Metal finishes on electric adjustable height tables available in Alloy or Matte Black.
Metal finishes on pneumatic adjustable height tables available in Stardust Silver or Black Sandtex.

Flux Desk Details

Wire Management

Removable panels allow access to the lift columns and also provide wire management.

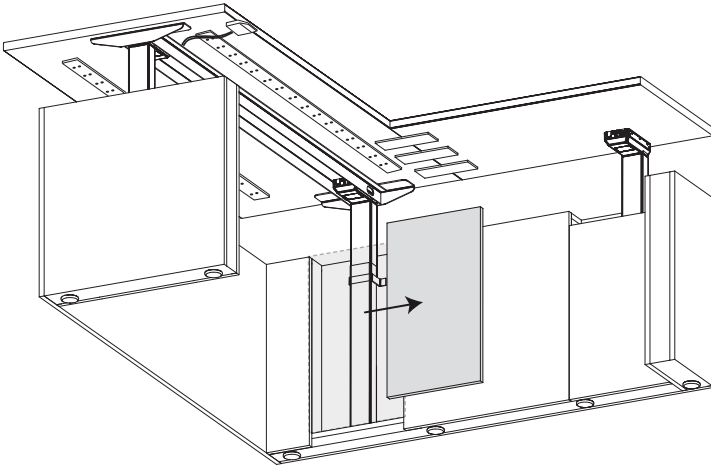

Removable panel shown from underside of adjustable height desk.

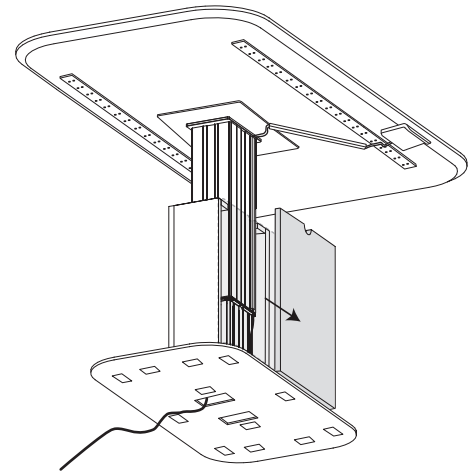

Electrical cord exits through the bottom side of the plate. Neoprene leveling pads allow the cord to lay flat.

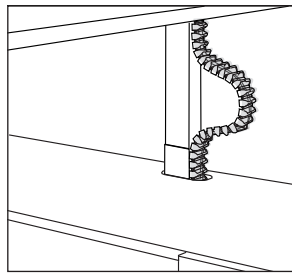

A flexible wire manager is included on adjustable desks, returns and credenzas.

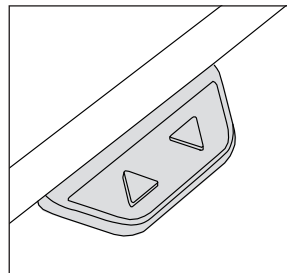

Controller can be mounted anywhere along top perimeter.

Optional Modesty Panel

An optional modesty panel can be added to an adjustable height desk or table desk.

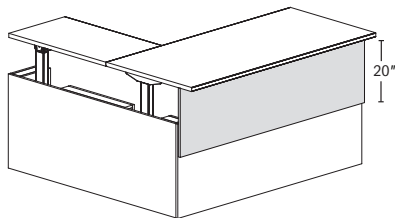

Adjustable Height Desk
Modesty panel mounts to the front of desk with overhang.

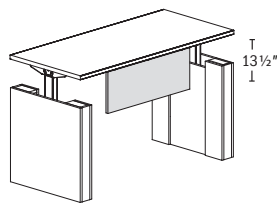

Adjustable Height Table Desk
Modesty panel mounts in between the end panels.

Nesting Side Table

Adjustable height side tables are designed to nest with primary height worksurfaces.

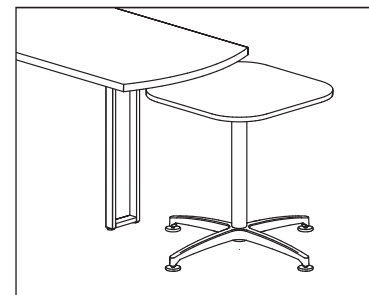

Flux Product Details

Credenzas

Product Overview

The Flux credenza is available as a 29 1/4" primary height credenza, or as a shorter, 21 1/4" secondary height credenza. Both heights come in three base styles as shown below.

PRODUCT INFORMATION

Primary Height

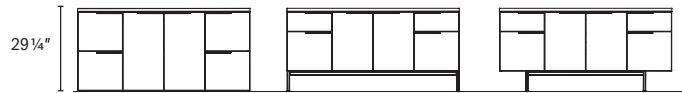

29F

Primary height
Extends to the floor

29L

Primary height
Elevated on legs

29S

Primary height
Elevated on inset legs

Secondary Height



21F

Secondary height
Extends to the floor

21L

Secondary height
Elevated on legs

21S

Secondary height
Elevated on inset legs

Drawer Alignment

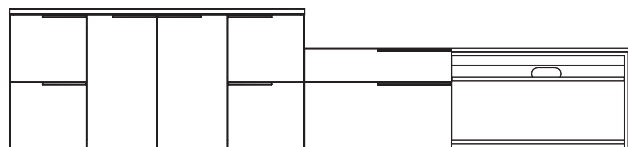

Drawers align between primary and secondary heights.

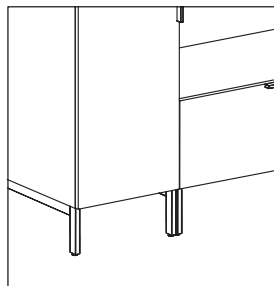

Legs pair up with adjacent units.

Credenza Oval Grommet Rules

Oval grommets for wire management are standard in all storage credenzas. Oval grommets in back panels can be eliminated upon request at no upcharge. Oval grommets are not offered in kneespace credenzas, open corner credenzas, modular pedestals, and pedestals under 18"w.

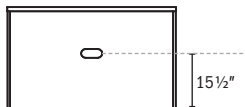
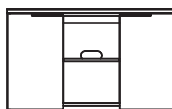
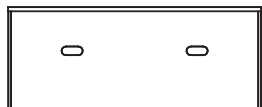
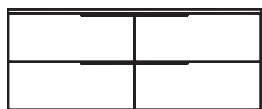
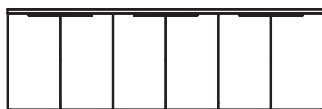

2 Grommets

Credenzas 60"w or greater with multiple storage compartments or drawer stacks have 2 grommets

1 Grommet

Credenzas under 60"w have 1 grommet

Flux Product Details

Credenza Options

Modesty Panel

A modesty panel can be added as an option to Kneespace and Open Corner Credenzas. A partial modesty panel, full modesty panel or removable modesty panel are available.

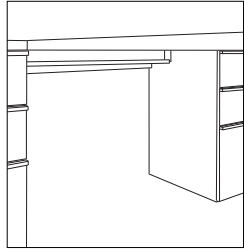

Standard without modesty panel

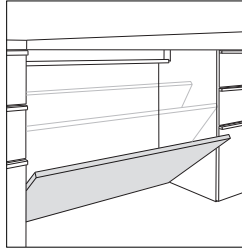

Removable modesty panel

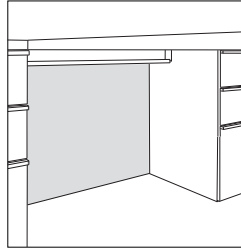

Fixed full height modesty panel

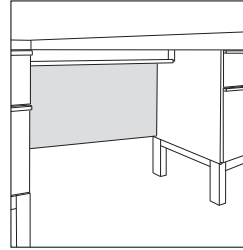

Fixed full height modesty panel with legs

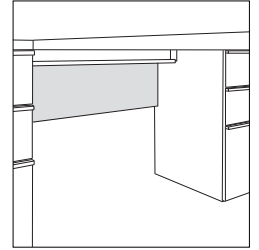

Fixed partial modesty panel

Concealed Drawers

Concealed drawers are available on credenzas with box/lateral file drawer configurations. This offers one continuous front.

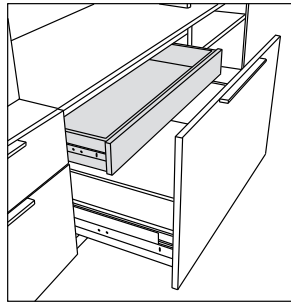

Trash Cans

Primary height credenzas with 18" wide hinge door storage can be outfitted with a trash can.

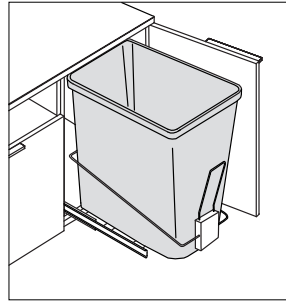

Seat Cushions

Seat Cushions are available in Rectangle, Oval, Square and Round and can be ordered separately for use on secondary credenzas.

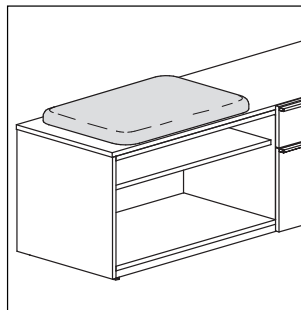

Rectangle seat cushion

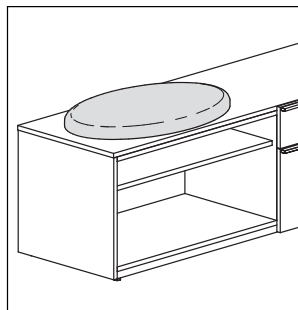

Oval seat cushion

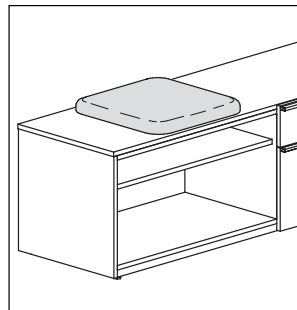

Square seat cushion

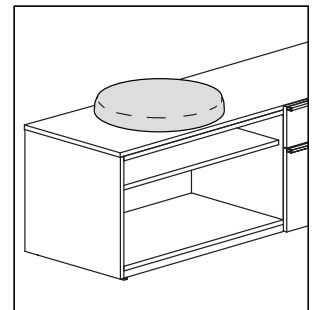

Round seat cushion

Flux General Options

Credenza Interior Compartment Heights

Primary height credenzas (29 1/4" h)

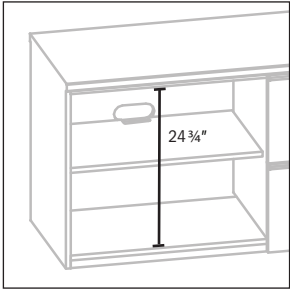

29F side compartment

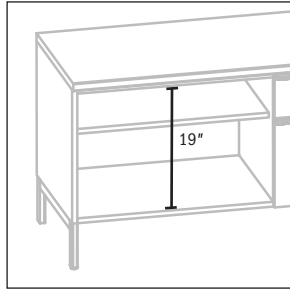

29L & 29S side compartment

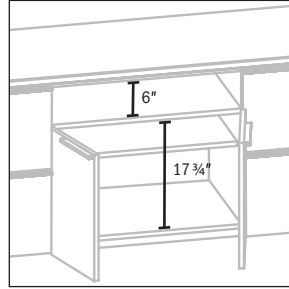

29F middle compartments

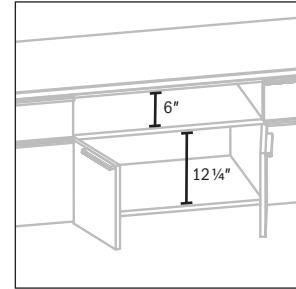

29L & 29S middle compartments

Secondary height credenzas (21 1/4" h)

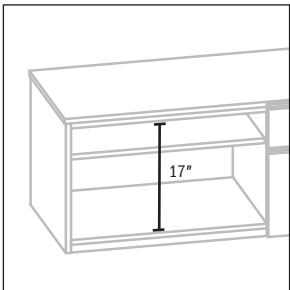

21F side compartment

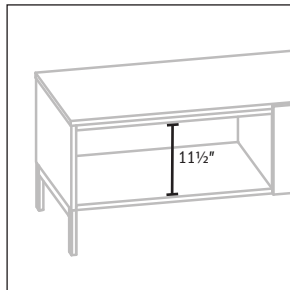

21L & 21S side compartment



Credenza Interior Compartment Widths



PRODUCT INFORMATION

Flux General Options

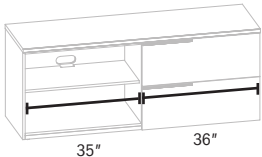
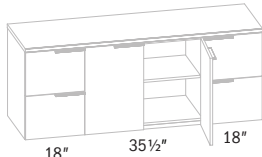
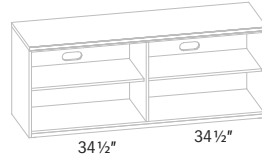
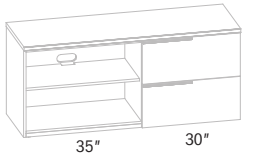
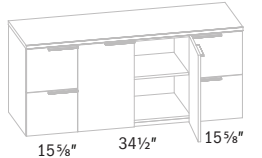
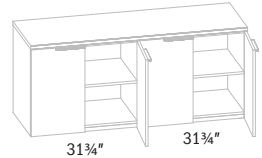
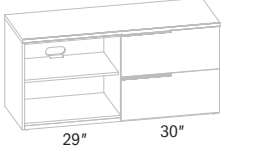
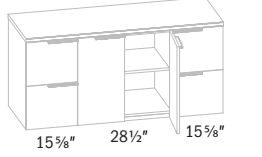
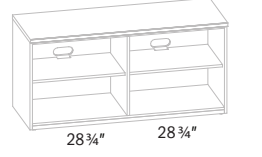
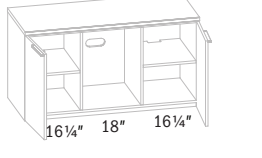
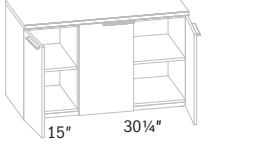
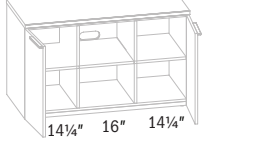
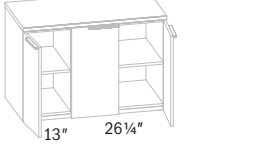
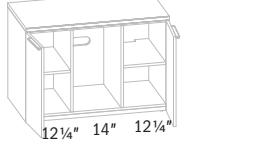
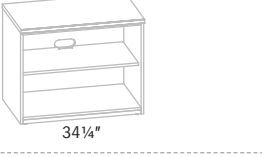
Credenza Interior Compartment Widths (continued)

72"w	 <p>35" 36"</p>	 <p>18" 35½" 18"</p>	 <p>34½" 34½"</p>
66"w	 <p>35" 30"</p>	 <p>15⅝" 34½" 15⅝"</p>	 <p>31¾" 31¾"</p>
60"w	 <p>29" 30"</p>	 <p>15⅝" 28½" 15⅝"</p>	 <p>28¾" 28¾"</p>
54"w	 <p>17" 34¼"</p>	 <p>16¼" 18" 16¼"</p>	
48"w	 <p>15" 30¼"</p>	 <p>14¼" 16" 14¼"</p>	
42"w	 <p>13" 26¼"</p>	 <p>12¼" 14" 12¼"</p>	
36"w	 <p>34¼"</p>		
30"w	 <p>28¼"</p>		

Credenza Interior Depths
 Standard shelf depth = 18"
 Interior cabinet depth = 20¼"

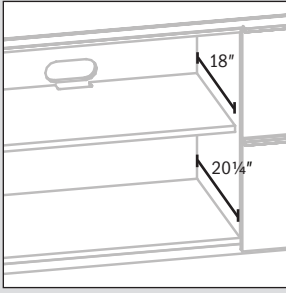

All dimensions are rounded down to the nearest quarter inch. Call Customer Service if exact dimensions are needed.

Flux Product Details

Overhead Cabinets, Wall Mount Overheads and Wall Panel Stack-ups

Product Overview

Flux overhead cabinets, wall mount overheads and wall panels, when combined with lower storage, create an overall height of 69 ¼" or 81 ¼". Overhead cabinets are available in three heights: 40", 48" or 52". Wall mount overheads are available in two heights: 17" or 29" (add ¼" to overall height for self-pull). Wall panels are available in four heights to accommodate various combinations of use to create the overall height of 69 ¼" or 81 ¼". Wall panels include laminate, veneer, tackboard, markerboard, magnetic glass, and workwall panels.

PRODUCT INFORMATION

Overhead Cabinets (side view)

Wall Mount Overheads (side view)

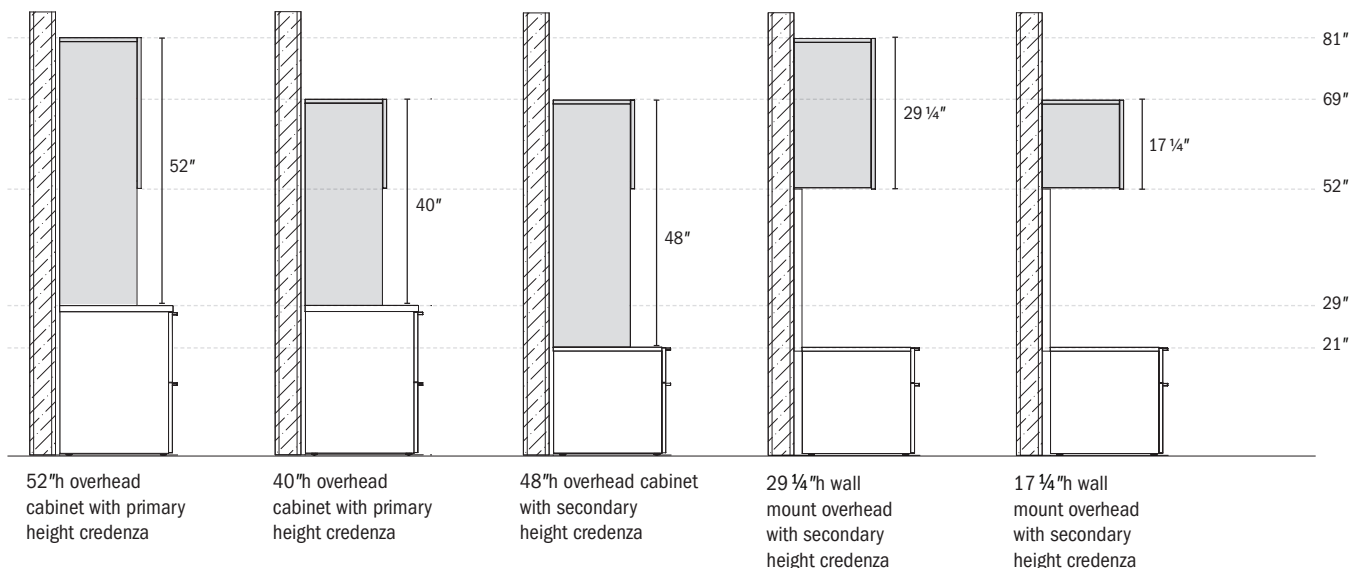

Wall Panels (side view)

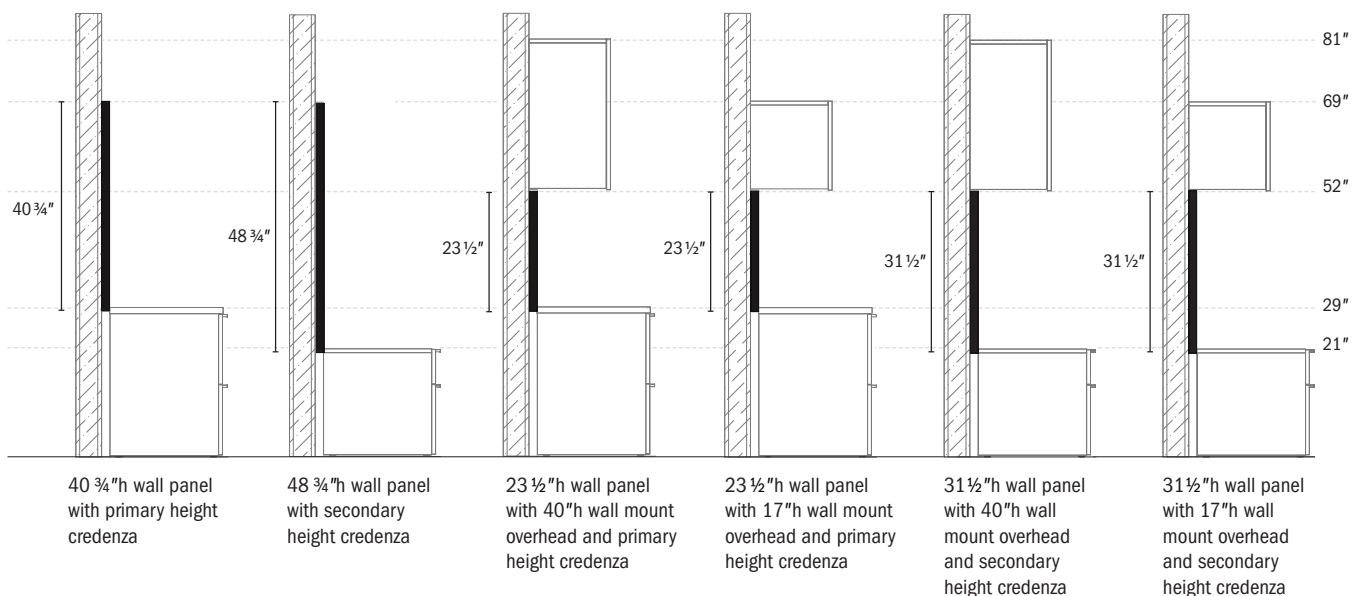

Flux Product Details

Wall Panel Installation

Proper installation when using wall panels will result in proper alignment.

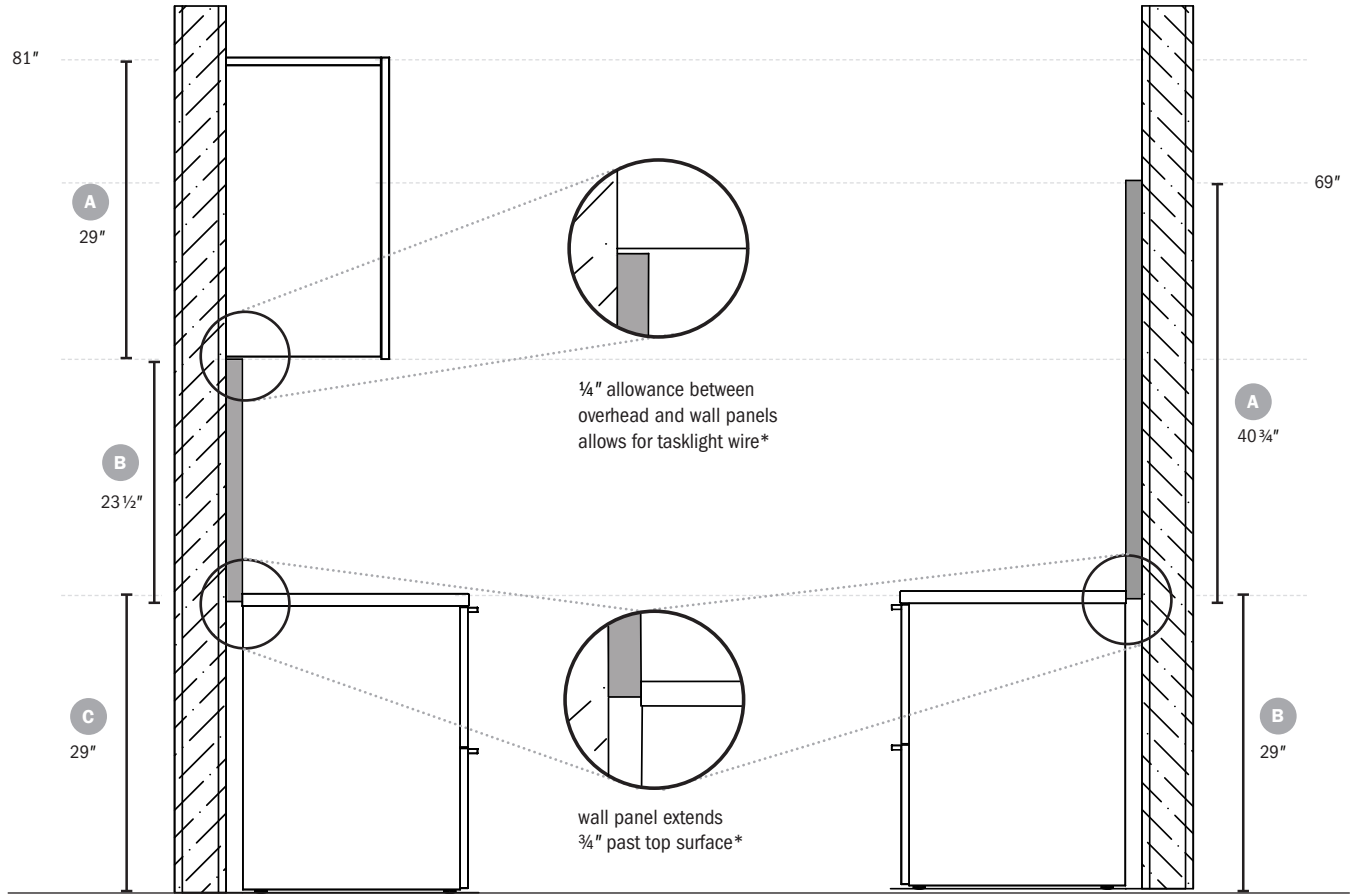

	Height	Notes
A	29.00" wall side	29.25" overall with extended door for self pull
B	23.50" overall	0.75" of panel extends past the credenza
C	29.00" overall	
	81.50"	
	+ .25" between overhead and wall panel	
	- .75" extended panel	
	81.00" finished height	

	Height	Notes
	40.75" overall	0.75" of panel extends past the credenza
	29.00" overall	
	69.75"	
	- .75" extended panel	
	69.00" finished height	

*For correct alignment with other Flux components, these allowances must be factored into mounting of the overheads and wall panels during installation (instructions included).

Flux Product Details

40" Overhead Stack-up Options (with Primary Height Credenza)

A 40" overhead may be composed of: **A** storage cabinets/towers, **B** wall mount overheads paired with wall panels or **C** tall wall panels, creating an overall unit height of 69" when added to a primary height credenza.

PRODUCT INFORMATION

A

40"

Open Storage Cabinet

Sliding Door Cabinet

Hinged Door Storage Tower

Sliding Door Storage Tower

Side Wardrobe with Open Shelf

See pages 314-323 and 396-399 for additional storage cabinet and tower options.

B

17 1/4"
23 1/2"

Open Storage

Sliding Door

Shelf

Cubby

Panel with Accessory File Shelf

Panel with Mini Shelf

Wall Panel
(laminite, veneer, tack panel, markerboard or glass)

See pages 321-335 for additional wall mount overhead options.

See pages 340-343 and 352-355 for additional wall mount wall panel options.

C

40 3/4"

Markerboard

Glass Markerboard

Tack Panel

See pages 336-339 for additional wall mount wall panel options.

Flux Product Details

Double Height Overhead Stack-up Options (with Primary and Secondary Credenza)

A 52" overhead may be composed of: **A** double height storage cabinets/towers, or **B** double height wall mount overheads and wall panels, creating an overall unit height of 81" when added to a primary height credenza. A 60" overhead composed of **C** double height wall mount overheads and wall panels can create an overall unit height of 81" when added to a secondary height credenza.

A

52"

Open Storage Cabinet Sliding Door Cabinet Hinged Door Storage Tower Sliding Door Storage Tower Side Wardrobe with Open Shelf

See pages 270-281 and 350-351 for additional double height storage cabinet and tower options.

B

29 1/4"

23 1/2"

Open Storage Sliding Door Shelf

Panel with Accessory File Shelf Panel with Mini Shelf Wall Panel (laminates, veneer, tack panel, markerboard or glass)

See pages 310-321 for additional wall mount overhead options.

See pages 340-343 and 352-355 for additional wall mount overhead options.

C

29 1/4"

31 1/2"

Open Storage Sliding Door Shelf

Panel with Accessory File Shelf Panel with Mini Shelf Wall Panel (laminates, veneer, tack panel, markerboard or glass)

See pages 310-321 for additional wall mount overhead options.

See pages 344-347 and 356-359 for additional wall mount wall panel options.

PRODUCT INFORMATION

Flux Product Details

48" Overhead Stack-up Options (with Secondary Height Credenza)

A 48" overhead may be composed of: **A** storage cabinets/towers, **B** wall mount overheads paired with wall panels or **C** tall wall panels, creating an overall unit height of 69" when added to a secondary height credenza.

PRODUCT INFORMATION

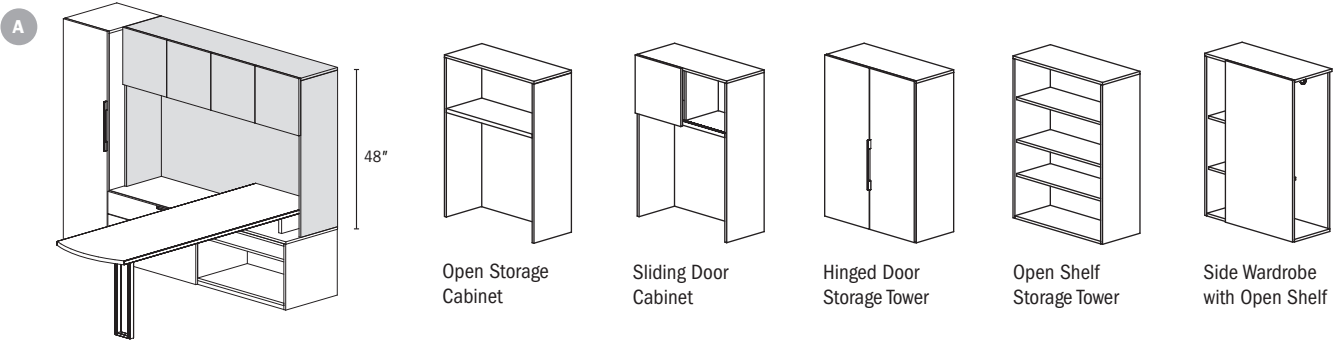

See pages 296-305 and 366-367 for additional storage cabinet and tower options.

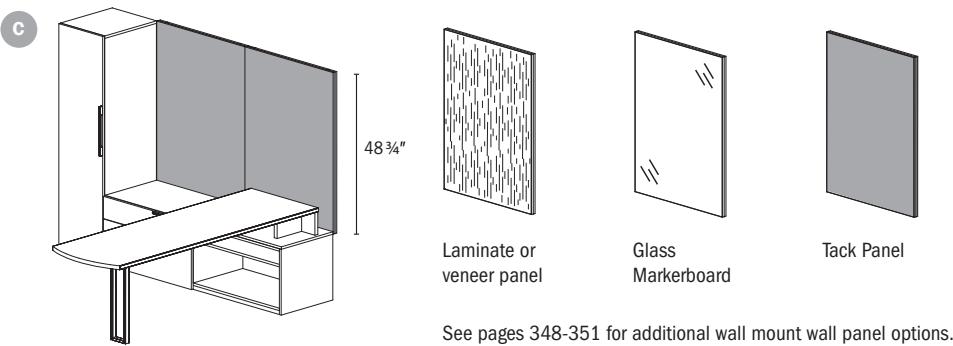
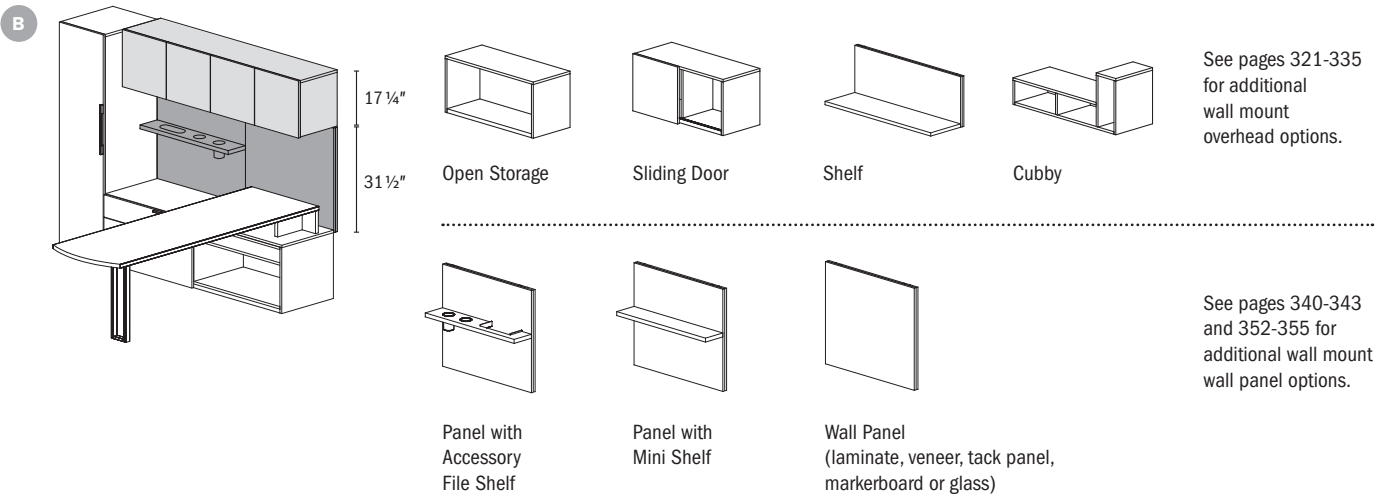

Flux Product Details

Overhead Options

Overhead Cabinet Doors

Contrasting door fronts, markerboard laminate fronts and white back painted glass fronts are available on overhead doors.

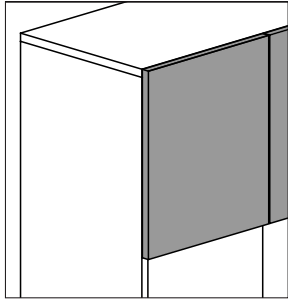

Contrasting laminate door fronts with any JSI standard laminate, or painted veneer fronts in JSI standard painted finishes.

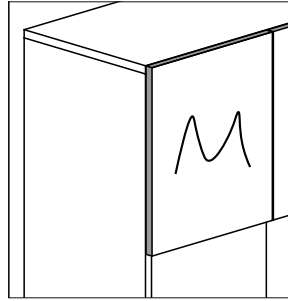

White markerboard laminate with silver vinyl wrapped door edges

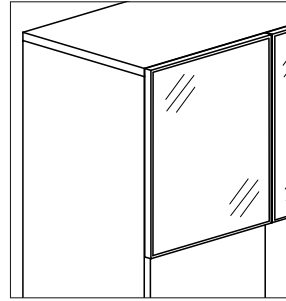

White back painted glass in a thin aluminum frame, with markerboard surface (locking not available on overhead with glass doors)

Overhead Cabinet Panels

Tackboard or laminate markerboard panels are available in overhead cabinets. Specify separately. Panels attach with dual lock fasteners.

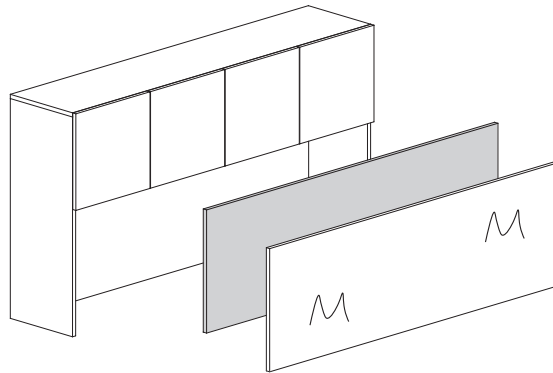

Tasklights

Flux tasklights are available for overhead cabinets. Specify separately. Grommet holes for wire management are $\frac{5}{8}$ " diameter for the LED tasklight. Refer to the chart to the right for the recommended tasklight length according to overhead cabinet width.

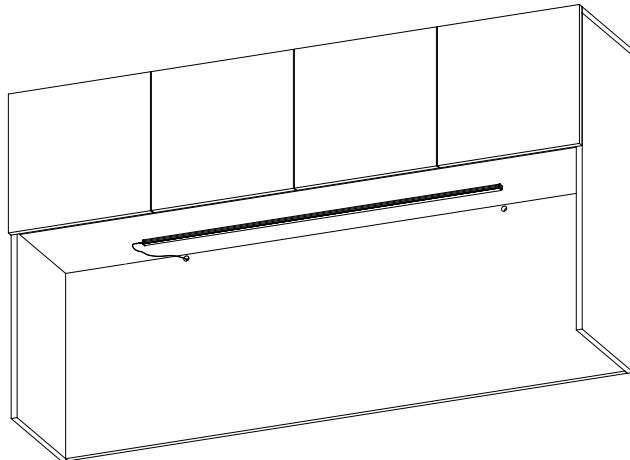

Overhead Width	Tasklight Model Number	Tasklight Length
96"	TL60LEDF	60"
90"	TL60LEDF	60"
84"	TL45LEDF	45"
78"	TL45LEDF	45"
72"	TL45LEDF	45"
66"	TL45LEDF	45"
60"	TL39LEDF	39"
54"	TL27LEDF	27"
48"	TL27LEDF	27"
42"	TL27LEDF	27"
36"	TL27LEDF	27"
30"	TL27LEDF	27"

Flux Product Details

Monitor Cabinets

Monitor cabinets allow a dual purpose layout: personal storage compartment and media compartment are available in various widths (96", 90", 84", 78", 72", 66", and 60") and configurations. Monitor cabinets should be used with primary height credenzas.

PRODUCT INFORMATION

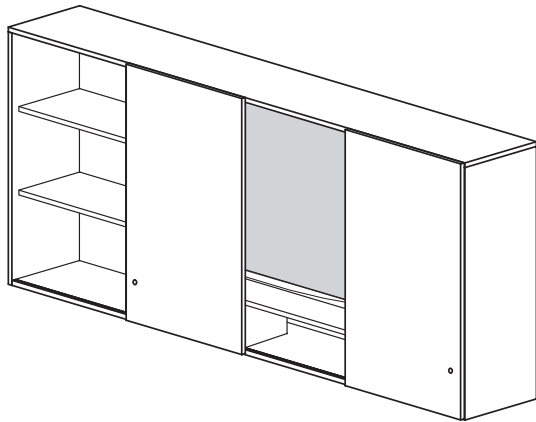

Center Monitor Cabinet

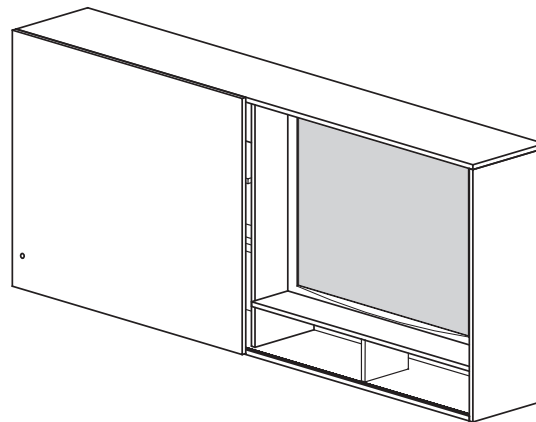

Right Monitor Cabinet

Center Monitor Cabinet Options

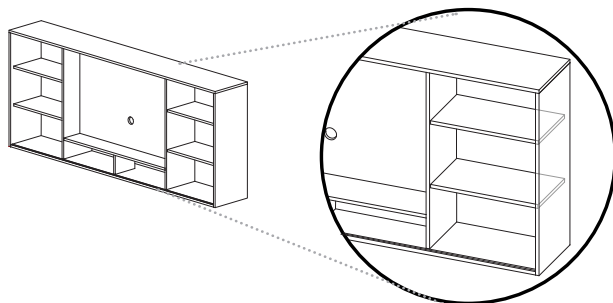

Center monitor with dual side shelf storage

Note: doors removed to show interior configurations

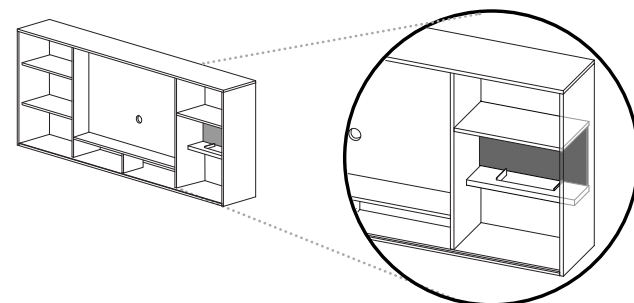

Center monitor with one side shelf storage and other side work-in-process storage (right or left), tackboard above filing shelf

Note: doors removed to show interior configurations

Flux Product Details

Right or Left Monitor Cabinet Options

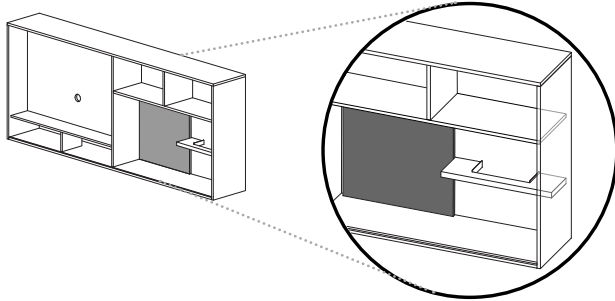

Right or left monitor with side work-in-process storage and side tackboard
Available only on 96", 90", and 84" cabinet widths

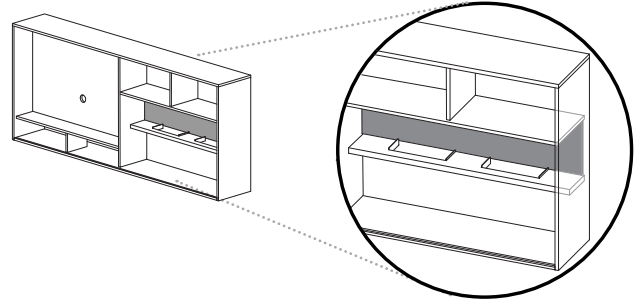

Right or left monitor with work-in-process storage and tackboard above filing shelf

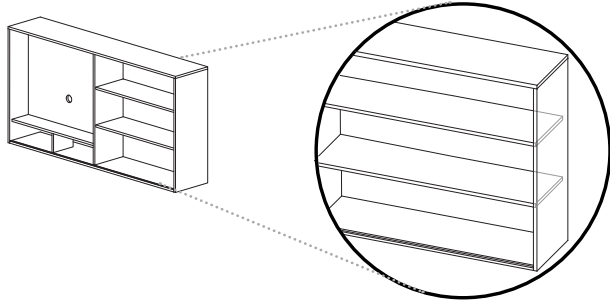

Right or left monitor with side shelf storage
Available only on 78", 72", 66" and 60" cabinet widths

Locking

Locks are standard on all sliding doors on monitor cabinets. Only the personal storage locations lock; monitor sections do not lock.

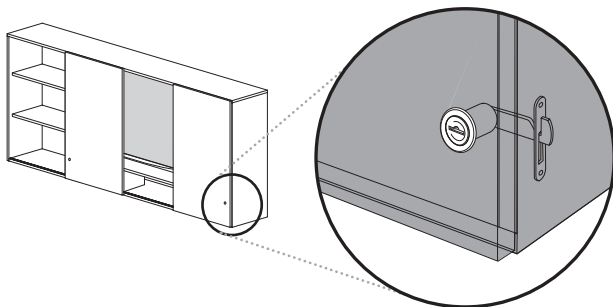

Compartment Sizes

Use the chart below to determine the maximum monitor size allowed.

Cabinet Width	Monitor Section Interior Width	Maximum Monitor Size
95 7/8"	48"	45"w x 29"h
89 7/8"	45"	42"w x 29"h
83 7/8"	42"	39"w x 29"h
77 7/8"	39"	36"w x 29"h
71 7/8"	36"	33"w x 29"h
65 7/8"	33"	30"w x 29"h
59 7/8"	30"	27"w x 29"h

Flux Product Details

Storage Cabinets and Wardrobes

Flux offers a large range of storage cabinets to align with primary height credenzas (18", 24", 30" and 36" widths; with 81 ¼" and 69 ¼" heights).

PRODUCT INFORMATION



Flux offers a large range of storage cabinets to align with secondary height credenzas (18", 24", 30" and 36" widths; with 81 ¼" and 69 ¼" heights).

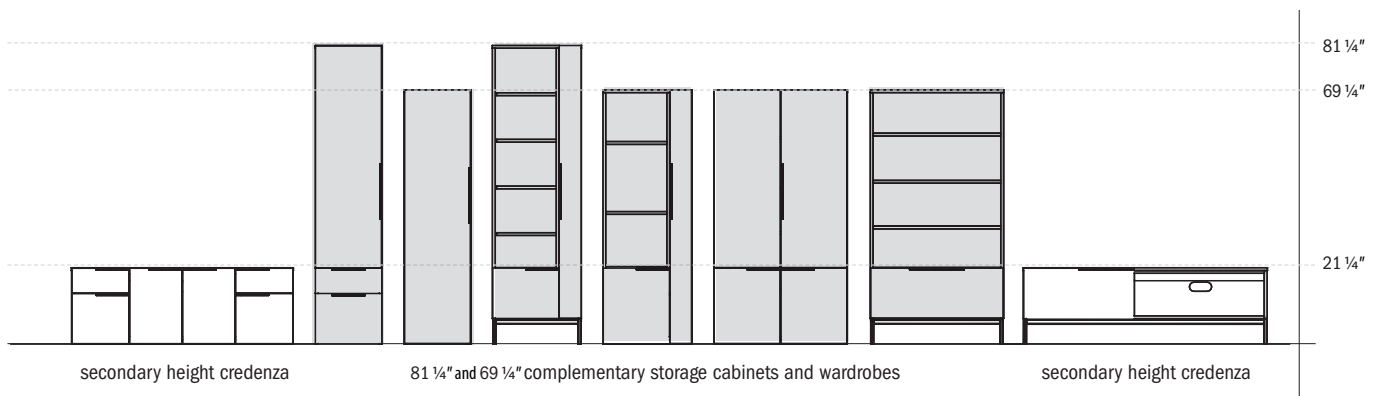

Fixed Shelf

All wardrobe cabinets with doors have a fixed shelf. All other shelves are adjustable.

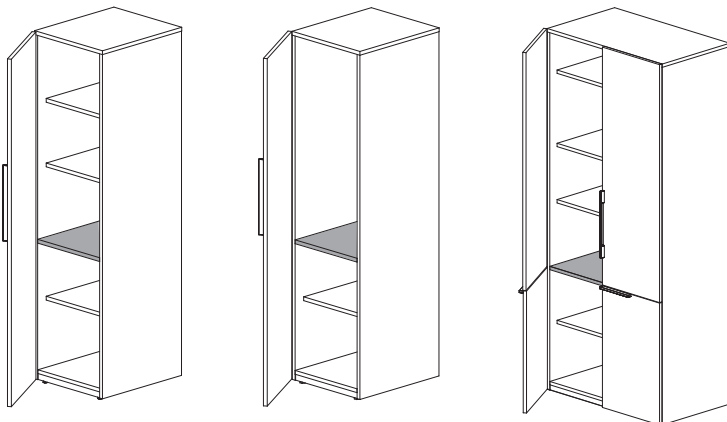

Flux Product Details

Vertical Storage Interior Dimensions

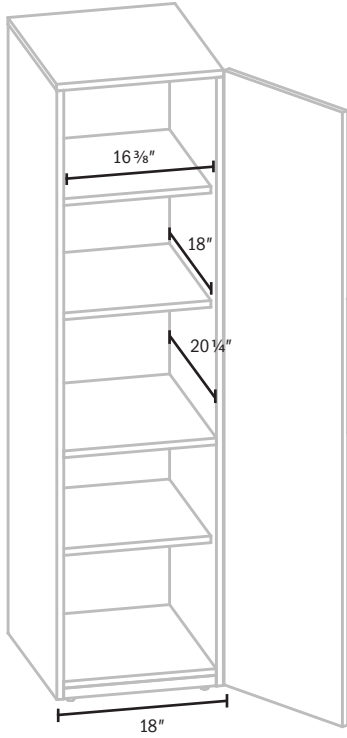

18"w full door storage cabinet

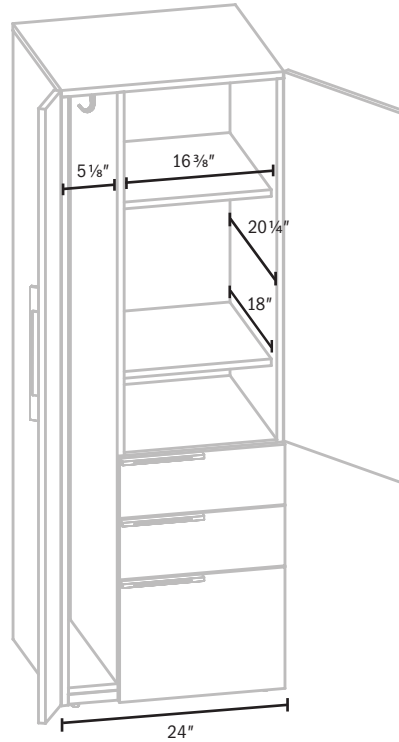

24"w side wardrobe with upper storage compartment

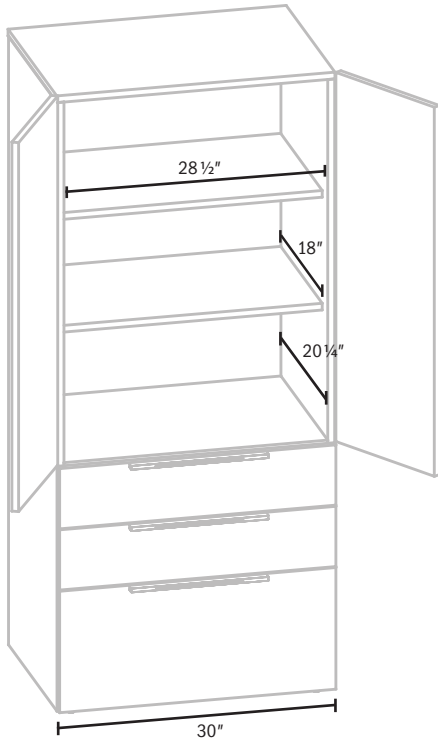

30"w upper storage compartment cabinet

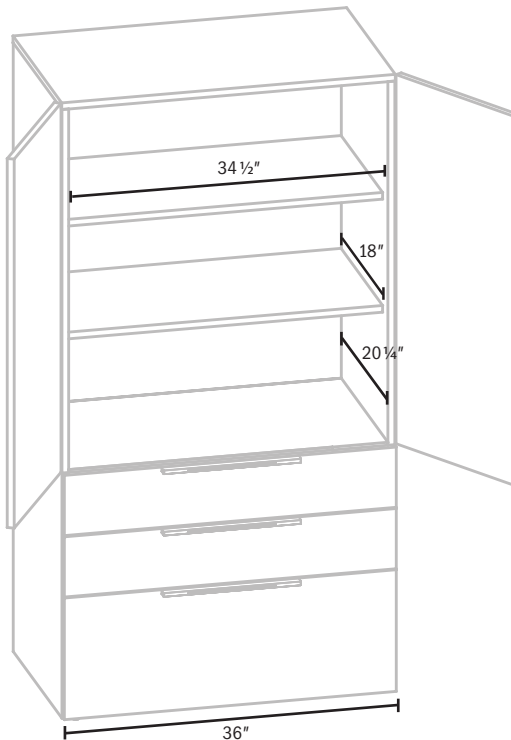

36"w upper storage compartment cabinet

Flux Product Details

Storage Cabinet and Wardrobe Options

Pantry Drawer

A pantry pull out drawer is a standard offering in storage cabinets and wardrobes without legs. Drawers are equipped with a support caster on the front underside of the drawer.

PRODUCT INFORMATION

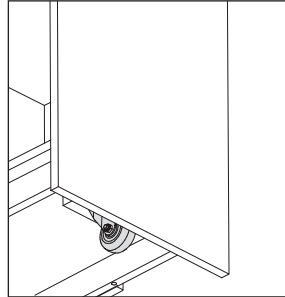
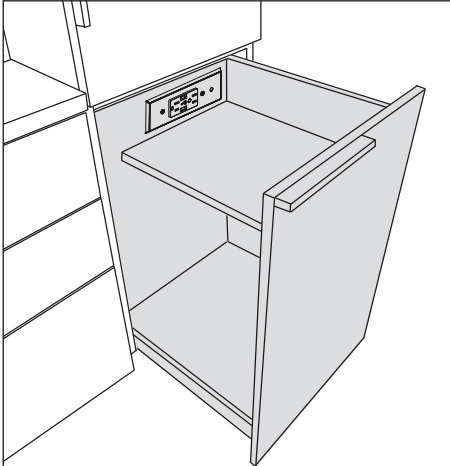

Underside of pantry pull out drawer highlighting support caster.

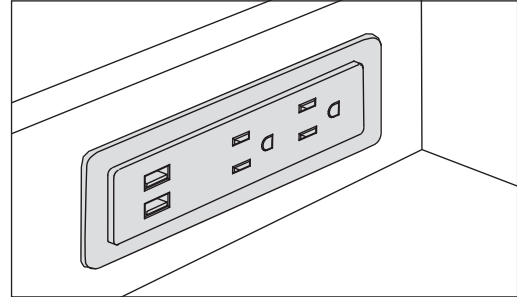

Optional electrical is available in the inside drawer and must be specified. Includes 2 grounded duplex and 2 USB charging outlets. Specify color.

Trash Cans

Storage Cabinets that work with primary height credenzas without legs, with lower hinge door storage, can be outfitted with a pull out trash can. Trash can is included.

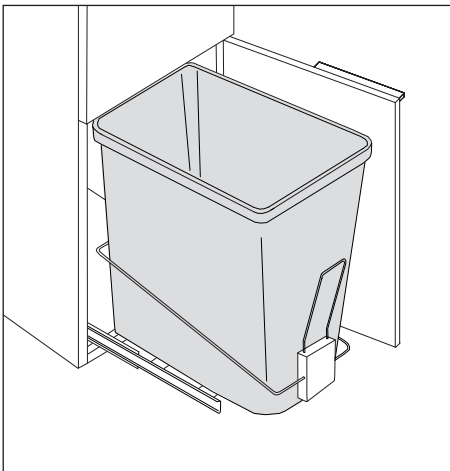

Flux Product Details

Modular Components

Modular items can be created by **(1)** adding tops to modular units or **(2)** using a credenza shell with a modular credenza shell pedestal. Hardware is included.

(1) Modular Top Construction

Example 1.1 - Open Corner Credenza

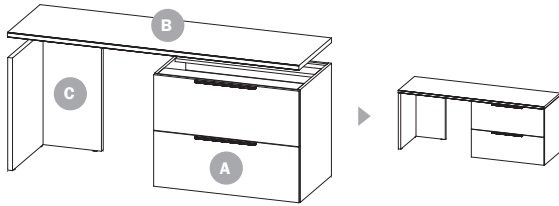

- A** = 36" w x 22" d modular lateral file
- B** = 72" w x 22" d modular primary height credenza top
- C** = 18" w x 22" d modular credenza wing end (left)
(Open spans over 48" require special consideration, consult with Customer Service)

Example 2.1 - Kneespace Credenza

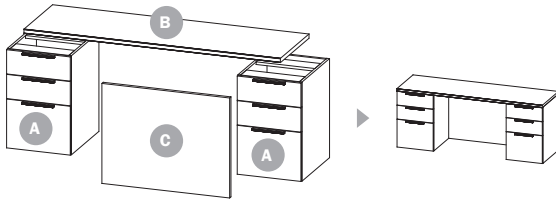

- A** = (qty 2) 18" w x 22" d modular pedestal
- B** = 72" w x 22" d modular primary height credenza top
- C** = 28" h x 36" w modular credenza modesty panel
(Open spans over 48" require special consideration, consult with Customer Service)

Example 3.1 - Storage Credenza

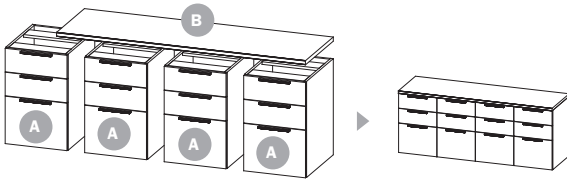

- A** = (qty 4) 18" w x 22" d modular pedestal
- B** = 72" w x 22" d modular primary height credenza top

Example 4.1 - Secondary Height Credenza

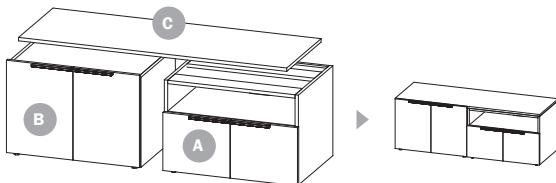

- A** = 30" w x 22" d modular hinged door storage with open shelf
- B** = 30" w x 22" d modular hinged door storage
- C** = 60" w x 21" d modular secondary height credenza top

(2) Credenza Shell Construction

Example 1.2 - Open Corner Credenza

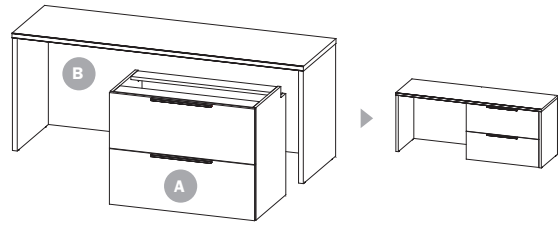

- A** = 36" w x 21" d modular credenza shell lateral file
- B** = 72" w x 22" d credenza shell
(Requires attachment to back of credenza and to underside of top)

Example 2.2 - Kneespace Credenza

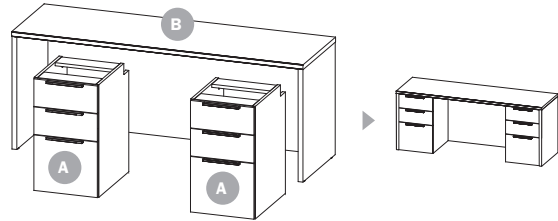

- A** = (qty 2) 18" w x 21" d modular credenza shell pedestal
- B** = 72" w x 22" d credenza shell
(Requires attachment to back of credenza and to underside of top)

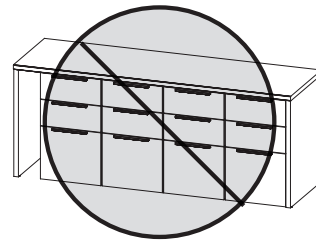

There is no combination of modular components that will allow a credenza shell to be filled between end panels; kneespace or open corner is required.

Flux Technology

Power Access and Wire Management Breakfront Pedestal Desk U Unit

PRODUCT INFORMATION

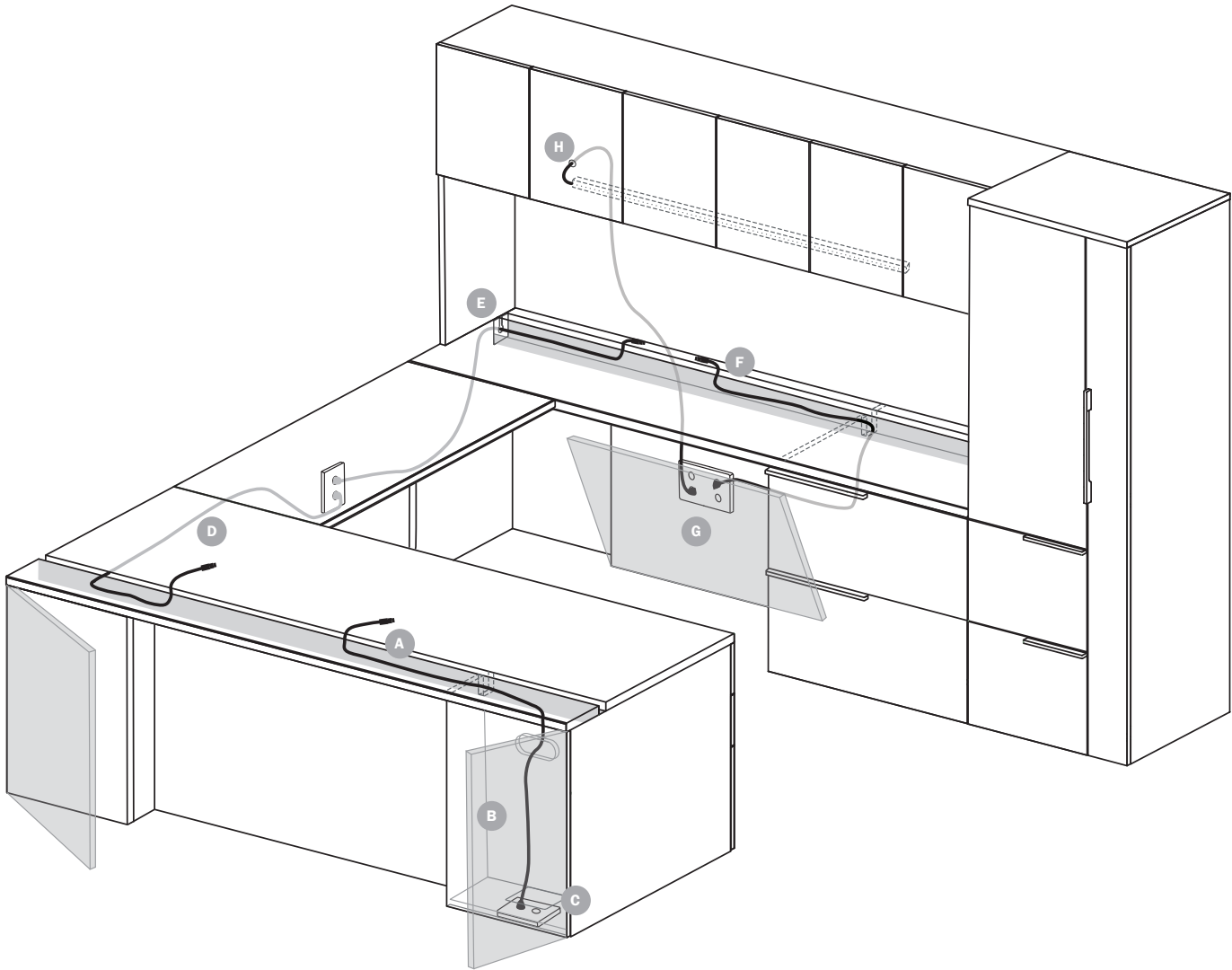

Wiring Paths

- A** = Split top allows wires to fall off at any location on the desk top
- B** = Pedestal access doors allow access to wiring or power supply
- C** = Hole in cabinet bottom allows for floor monument access
- D** = Wiring can be routed through the desk, under bridge and back to the credenza
- E** = End panel grommet in credenza allows wiring to exit the layout
- F** = Split top allows wires to fall off at any location on the credenza top
- G** = Optional removable modesty panel allows for access to wall electrical outlet
- H** = $\frac{5}{8}$ " holes in back panel allow TL-LED tasklight wires to be routed down the exterior of overhead back

Flux Technology

Power Access and Wire Management Peninsula Desk with Secondary Storage

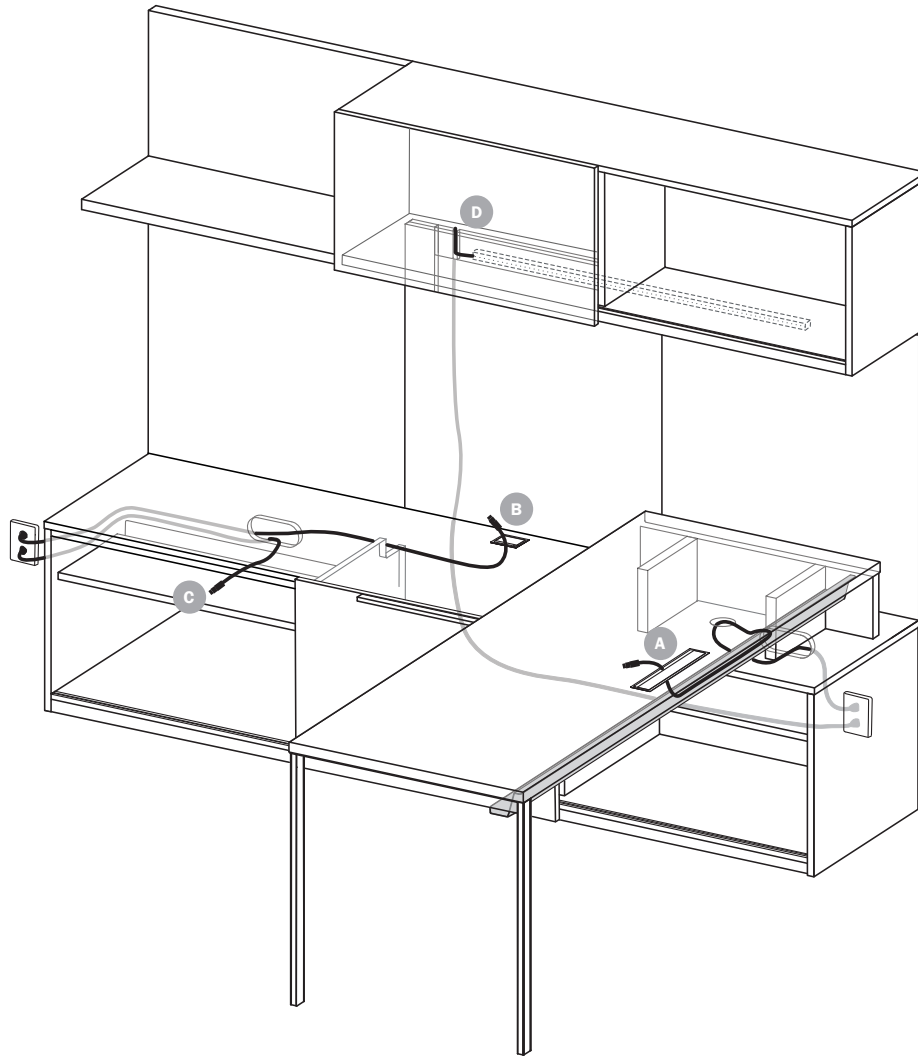

Adjustable Height Peninsula Desk with Secondary Storage

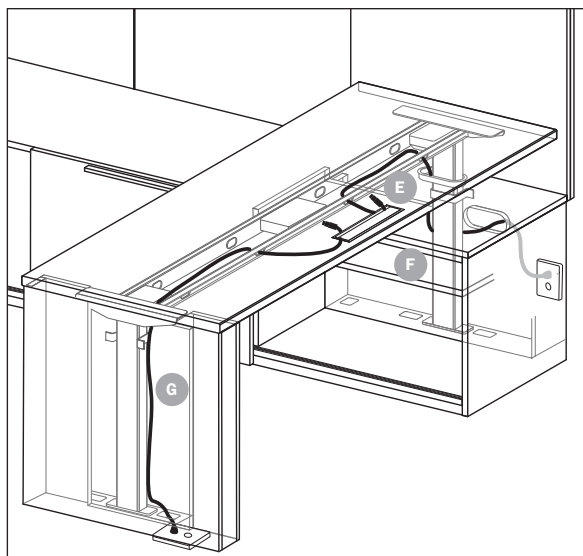

Wiring Paths

- A** = Optional 12" grommet allows wiring to run into optional wire channel, through the standard top credenza grommet and out the back panel's oval grommet
- B** = Optional 3" grommet allows wiring to enter the credenza compartment, move through the notched inside panels and out the back panel's oval grommet
- C** = Wiring for equipment can exit out the oval back grommet
- D** = Tasklight wiring can exit back side of the wall panels
- E** = Optional 12" grommet allows wiring to run into the adjustable height support rails then to a standard flexible wire manager into the lift mechanism compartment and out the back panel's oval grommet
- F** = Snap-on panel allows access to the lift mechanism compartment for access to the back oval grommet
- G** = Snap-on panel on the inside peninsula desk end allows access to the interior of the lift mechanism compartment to route wiring to floor monuments

Flux Technology

Grommets and Worksurface Power

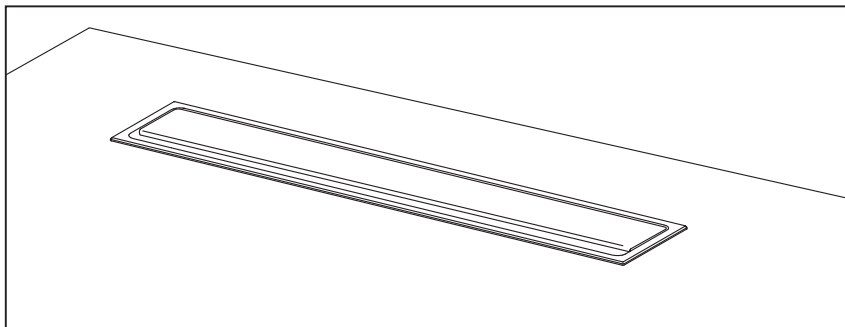
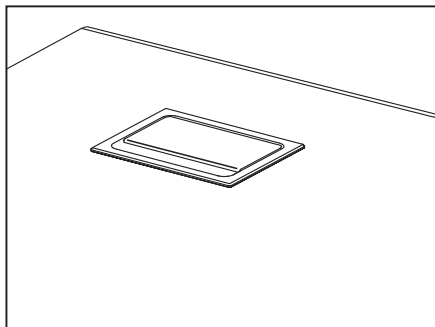

Optional Grommets

Flux offers two sizes of optional grommets: 3" (2½") and 12" (11½") grommets, available in arctic silver, soft nickel, matte black or pewter. Grommet locations are predetermined with a code; see the grommet and electrical locations in this section.

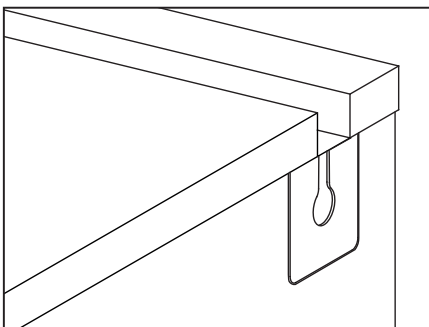
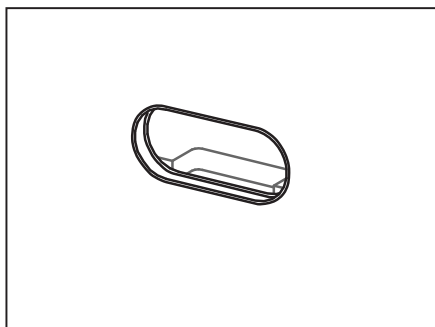

Oval Grommets

Oval grommets with a black trim ring are standard on the back of credenzas. See page 44 for actual location rules for the credenzas. These grommets can be eliminated at no charge. Must specify at the time of order entry.

Side Grommets

Magnetic side grommets are standard on credenza with split tops, and include an interior wire channel.

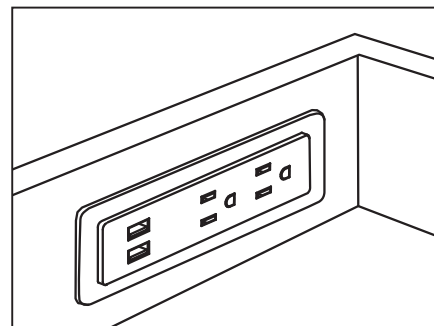
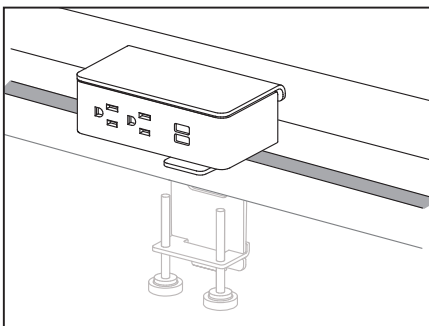
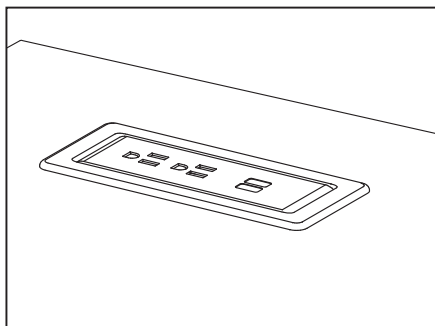

Optional EC26 Power Unit

Optional EC26 power unit can be located on tops, available in black or white; two power receptacles—120 volts and 15 amp dual powered USB. Locations are predetermined with a code; see the grommet and electrical locations in this section.

Optional EC28 Power Unit

Optional EC28 power unit can be clamped on desk or credenza with split tops, available in black or white; two power receptacles—120 volts and 15 amp dual power USB; 10 ft. cord.

Optional EC26 Pantry Power Unit

Optional EC26 power unit can be specified in the pantry drawer, available in black or white; two power receptacles—120 volts and 15 amp dual power USB.

Flux Technology

Dimensional Location of Grommets

The grommet locations below show standard dimensions for most products. If exact dimensional information is needed, contact Customer Service.

Desk (top view)

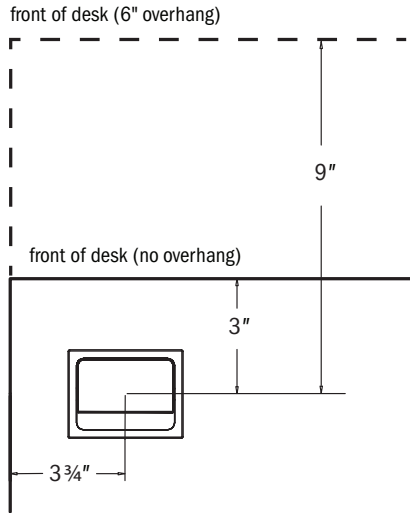

Grommet dimensions
 A and C positions on desk

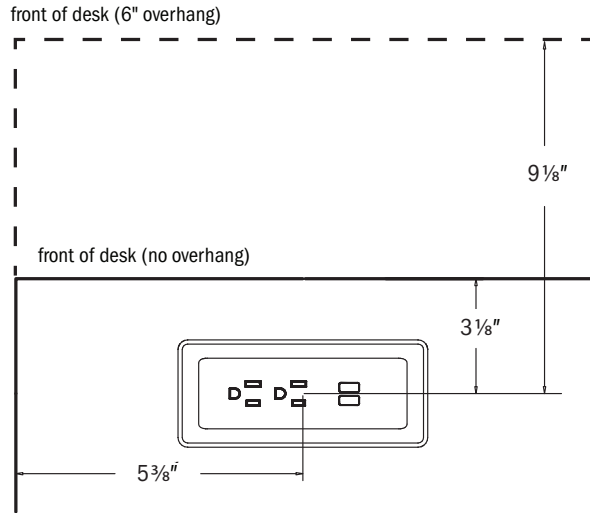

EC26 dimensions
 A and C positions on desk

Grommets or EC26 D position runs parallel to the side of the desk.

PRODUCT INFORMATION

Credenza (top view)

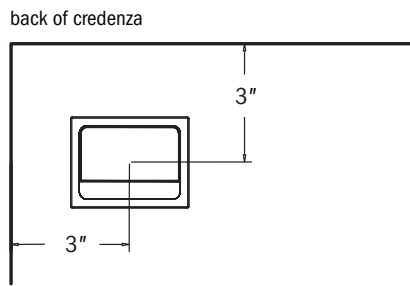

Grommet dimensions
 A and C positions on desk

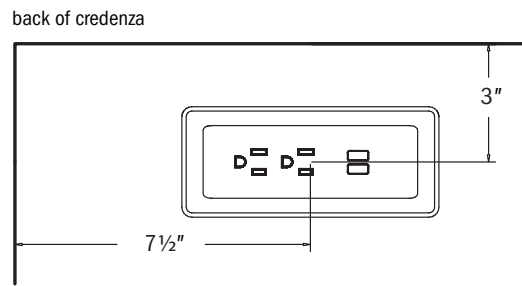

EC26 dimensions
 A and C positions on desk

Flux Technology

Location of Grommets and Worksurface Electrical

Reference the diagrams below to determine the letter code for specifying a desired grommet or power unit location. Available locations apply to all options listed within each category.

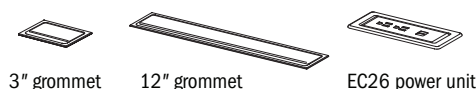

Double Pedestal Desks

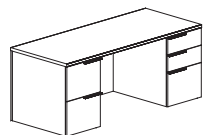

user side shown

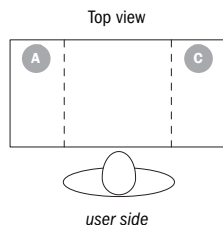

Available options:

- 3" grommet
- EC26 power unit

Available location codes:

- A or C
- Grommets are inset on desks with overhang tops

Single Pedestal Desks

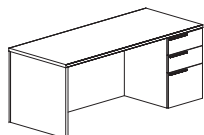

right side, user side shown

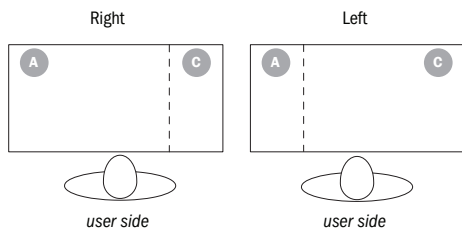

Available options:

- 3" grommet
- EC26 power unit

Available location codes:

- A or C
- Grommets are inset on desks with overhang tops

Peninsula Desks with End Panels

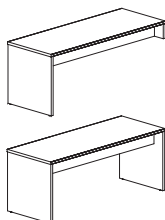

right side, approach view

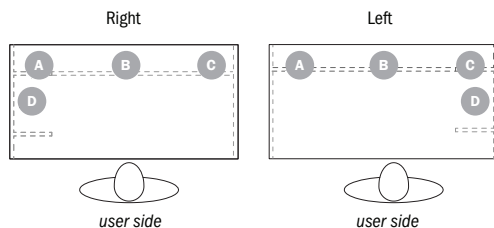

Available options:

- 3" grommet
- 12" grommet
- EC26 power unit

Available location codes:

- A B C or D

Peninsula Desks with End Frames or Post Frames

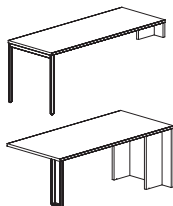

(frame post)

non-handed product - grommets hand units

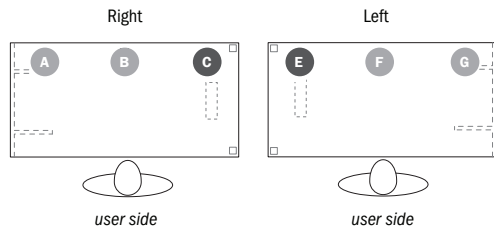

Dark gray locations (C & E) are not available on peninsula desks with frame post

Available options:

- 3" grommet
- 12" grommet
- EC26 power unit

Available location codes:

- A B or C (right)
- E F or G (left)
- Locations apply to rectangular and arc shape tops with end frames

Boomerang Peninsula Desks with End Frames

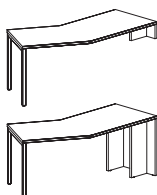

right side, approach view

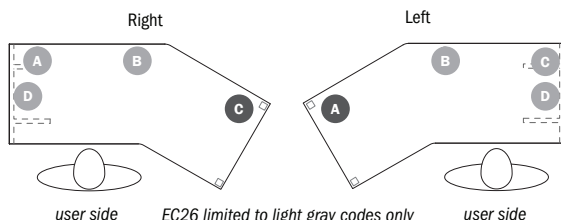

Available options:

- 3" grommet
- 12" grommet
- EC26 power unit (limited to 3 locations)

Available location codes:

- A B C or D
- EC26 power unit may not be located at outer end of bend

Flux Technology

Location of Grommets and Worksurface Electrical (continued)

Available locations apply to all options listed within each category.

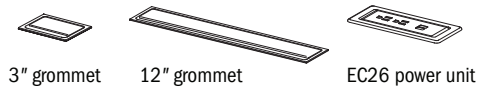

Rectangle Run-off Desks with End Panels

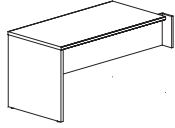

left side, approach view

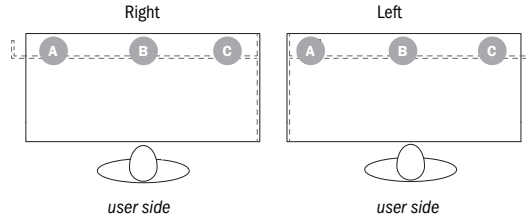

Available options:

- 3" grommet
- 12" grommet
- EC26 power unit

Available location codes:

- A B or C

Run-off Desks with End Frames or Post Frames

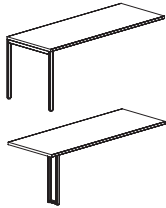

non-handed product – grommets hand units

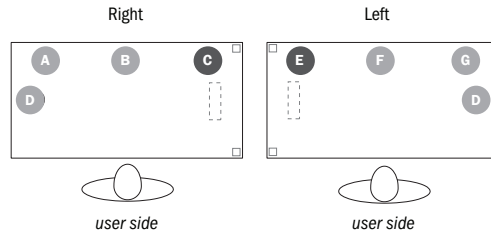

Dark gray locations (C & E) are not available on peninsula desks with frame post

Available options:

- 3" grommet
- 12" grommet
- EC26 power unit

Available location codes:

- A B C or D (right)
- E F G or D (left)
- Locations apply to rectangular and arc shape tops with end frames

Boomerang Run-off Desks with End Frames



right side, approach view

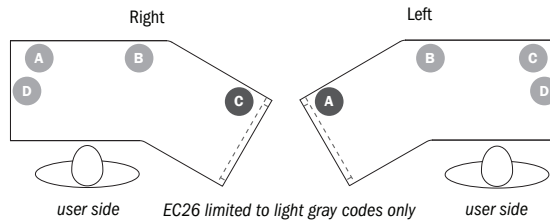

Available options:

- 3" grommet
- 12" grommet
- EC26 power unit (limited to 3 locations)

Available location codes:

- A B C or D
- EC26 power unit may not be located at outer end of bend

Bridge Tops

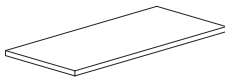

non-handed product

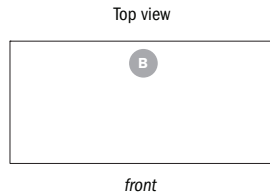

Available options:

- 3" grommet
- EC26 power unit

Available location codes:

- B

Returns

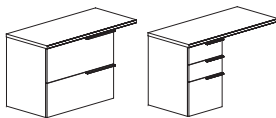

left side, user view

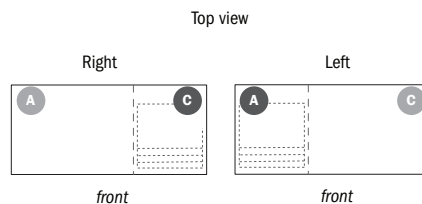

EC26 limited to light gray codes only

Available options:

- 3" grommet
- EC26 power unit (one location only)

Available location codes:

- A or C
- EC26 power unit may not be located above drawers

Flux Technology

Location of Grommets and Worksurface Electrical (continued)

Available locations apply to all credenza widths listed (primary or secondary height). EC26 power units may not be located above drawers.

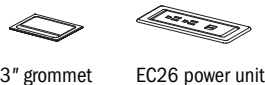

3" grommet EC26 power unit

Lateral File Credenzas and Lateral File Pedestals

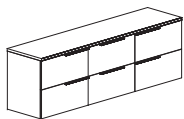

credenza with 3 file compartments, 90" w

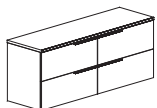
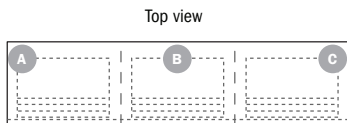

credenza with 2 file compartments, 72" w or 60" w

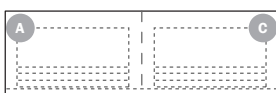

lateral file pedestal, 36" w or 30" w

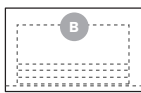

Available option:

- 3" grommet

Available location codes:

- A B or C (3 compartments)
- A or C (2 compartments)
- B (lateral file pedestal)
- Note: Grommets cannot be specified on secondary credenza at same location as the credenza mounts for a peninsula desk. See page 17 for additional information.

Storage Credenzas with Open Center Compartments

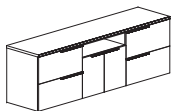

credenza with center storage/open compartment
96" w, 90" w, 84" w, 78" w, 72" w, 66" w or 60" w

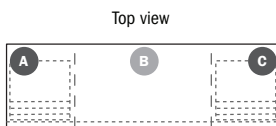

EC26 limited to center location B only

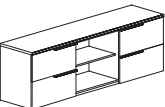

credenza with open center compartment
96" w or 90" w



Available options:

- 3" grommet
- EC26 power unit (one location only)

Available location codes:

- A B or C
- EC26 power unit may not be located above drawers; limited to center location B only
- Note: Grommets or EC26 power units cannot be specified on secondary credenza at same location as the credenza mounts for a peninsula desk. See page 17 for additional information.

Credenzas with Open, Sliding or Hinge Door Compartments

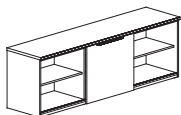

credenza without drawers, 96" w or 90" w

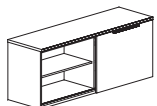
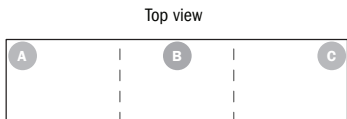

credenza without drawers, 72" w or 60" w

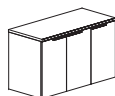

credenza without drawers, 54" w, 48" w or 42" w

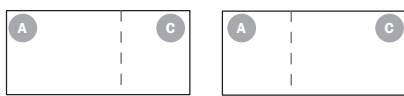

storage unit without drawers, 36" w or 30" w



Available options:

- 3" grommet
- EC26 power unit

Available location codes:

- A B or C (3 compartments)
- A or C (2 compartments)
- B (1 compartment)
- Note: Grommets or EC26 power units cannot be specified on secondary credenza at same location as the credenza mounts for a peninsula desk. See page 17 for additional information.

Flux Technology

Location of Grommets and Worksurface Electrical (continued)

Available locations apply to all credenza widths listed (primary or secondary height). EC26 power units may not be located above drawers.

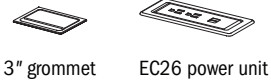

Lateral Storage Credenzas with End Open Compartment(s)

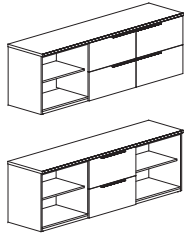

credenza with end open compartment(s)
96"w or 90"w

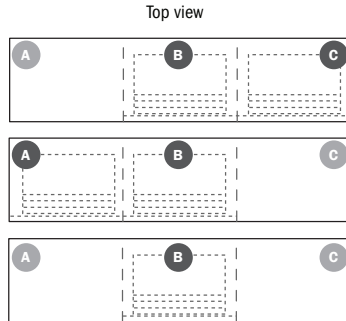

EC26 limited to open compartments only (light gray codes)

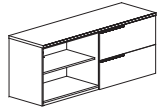

credenza with end open compartment
72"w, 66"w or 60"w

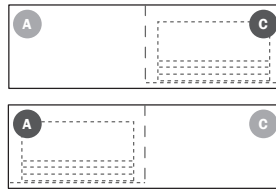

Available options:

- 3" grommet
- EC26 power unit (limited locations)

Available location codes:

- A, B or C (3 compartments)
- A or C (2 compartments)
- EC26 power unit may not be located above drawers

Kneespace Credenzas

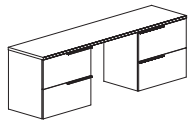

lateral drawer kneespace credenza
96"w or 90"w

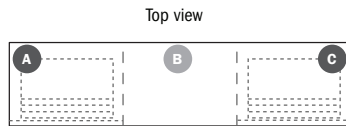

EC26 limited to center location B only

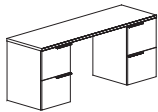

file drawer kneespace credenza
84"w, 78"w, 72"w, 66"w or 60"w



Available options:

- 3" grommet
- EC26 power unit (one location only)

Available location codes:

- A, B or C
- EC26 power unit may not be located above drawers; limited to center location B only

Lateral and File Credenzas

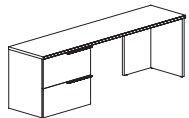

lateral drawer kneespace credenza
96"w, 90"w, 84"w, 78"w or 72"w

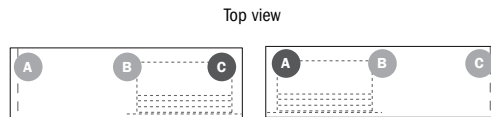

EC26 limited to open compartments only (light gray codes)

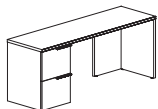

file drawer kneespace credenza
84"w, 78"w, 72"w, 66"w or 60"w

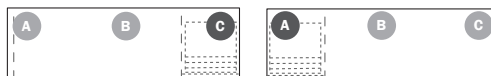

Available options:

- 3" grommet
- EC26 power unit (limited locations)

Available location codes:

- A, B or C
- EC26 power unit may not be located above drawers

Flux Technology

Location of Grommets and Worksurface Electrical (continued)

Available locations apply to all options listed within each category.
EC26 power units may not be located above drawers.

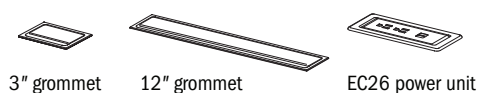

Peninsula Credenzas

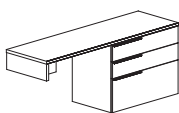

peninsula credenza , user view
96"w, 90"w, 84"w, 78"w or 72"w

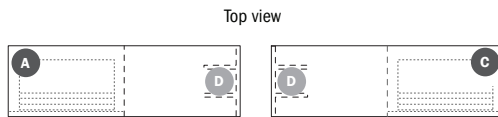

EC26 limited to location **D** only

Available options:

- 3" grommet
- EC26 power unit (one location only)

Available location codes:

- **A**, **C** or **D**
- EC26 power unit may not be located above drawers; limited to center location **D** only

PRODUCT INFORMATION

Credenza Shells and Return Shells

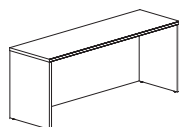

credenza shell and return
72"w or 66"w

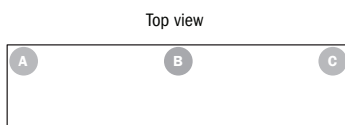

Available option:

- 3" grommet

Available location codes:

- **A**, **B** or **C** (72"w or 66"w units)
- **A** or **C** (units 60"w or less)

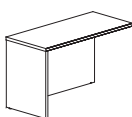

credenza shell and return
60"w, 54"w, 48"w or 42"w

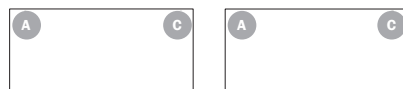

Adjustable Height Credenza Extensions and Return Shells

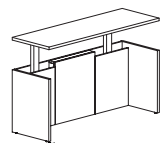

adjustable height credenza extension
72"w, 66"w, 60"w, 54"w or 48"w

Top view



Available option:

- 3" grommet

Available location codes:

- Codes apply only to adjustable height credenza extensions and adjustable height return shells.

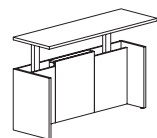

adjustable height return shell
72"w, 66"w, 60"w, 54"w or 48"w

Adjustable Height Credenza

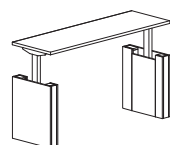

adjustable height credenza
72"w, 66"w, 60"w, 54"w or 48"w

Top view



Available option:

- 3" grommet

Available location codes:

- Codes apply only to adjustable height credenza.

Flux Technology

Location of Grommets and Worksurface Electrical (continued)

Available locations apply to all options listed within each category.



Adjustable Height Table Desks with End Panels

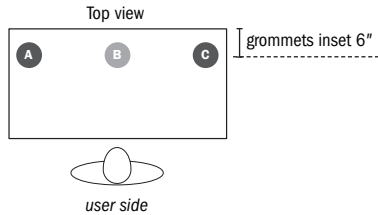
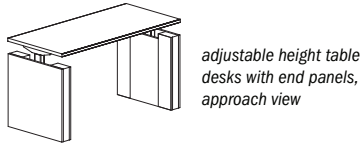

12" grommet limited to location **B** only

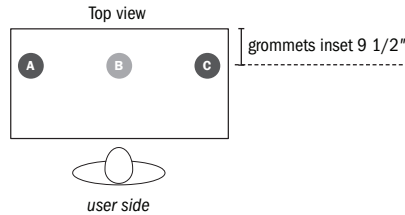
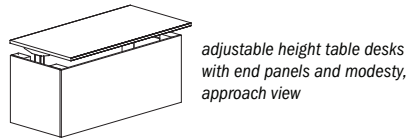

12" grommet limited to location **B** only

Available option:

- 3" grommet
- 12" grommet (one location only)

Available location codes:

- **A**, **B** or **C**
- 12" grommet limited to location **B** only
- Grommets are inset 6" to accommodate desk overhang
- Codes apply only to adjustable height table desks with end panels

Adjustable Height Peninsula Desk

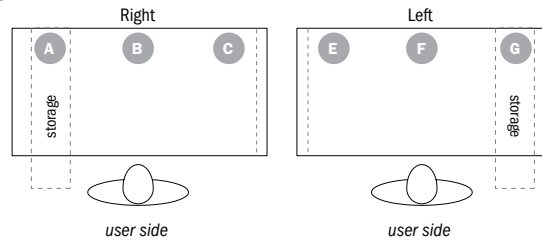
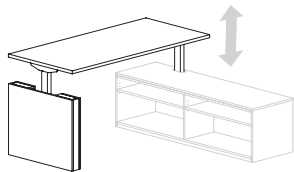

Available option:

- 3" grommet

Available location codes:

- **A**, **B** or **C** (right)
- **E**, **F** or **G** (left)
- Locations apply to rectangular adjustable height peninsula desk

Adjustable Height L Configuration Desks and Returns

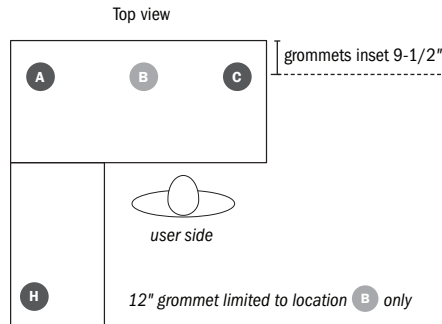
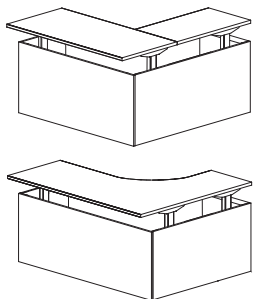

Available option:

- 3" grommet
- 12" grommet (one location only)

Available location codes:

- **A**, **B** or **C** (desk)
- **H** (return)
- 12" grommet limited to location **B** only
- Grommets are inset 6" to accommodate desk overhang

Adjustable Height Table Desks with Center Columns

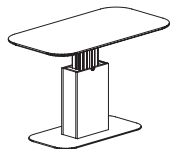

Meeting table, center mount

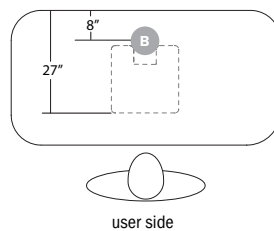

Desk, offset mount

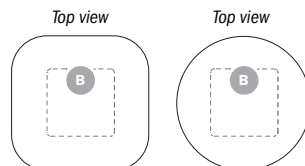
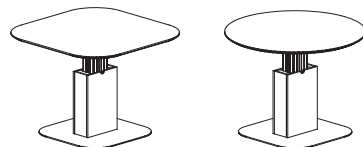
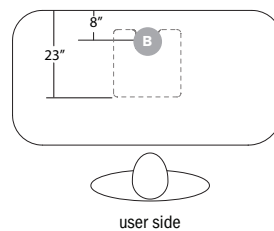

Available option:

- 3" grommet (grommets are off-center)

Available location codes:

- **B**
- Dimensional information for rectangular table desk is for a unit with a 36"d x 72"w top. Base can be mounted for a meeting table or a desk; grommet location remains the same on both mounting locations.

Flux Technology

Metal Wire Manager for Peninsula Desks and Run-off Desks

The wire manager is available in multiple lengths and four finishes: matte black, pewter, arctic silver and soft nickel. Use the charts on the following two pages to determine the appropriate wire manager model number for the selected peninsula or run-off desk.

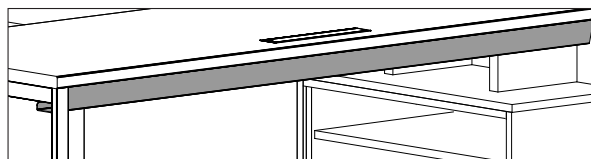

Recommend Size with Peninsula or Run-off Desk

Laminate/Veneer Model Number	Wire Manager Model Number	
	Eased Edge	Knife Edge
FLT/FLV2848ARCTP	FLB0438MWM	FLB0438MWM
FLT/FLV2848RRTN	FLB0444MWM	FLB0444MWM
FLT/FLV2848RRTP	FLB0444MWM	FLB0444MWM
FLT/FLV2848TD	FLB0444MWM	FLB0438MWM
FLT/FLV2854ARCTP	FLB0444MWM	FLB0444MWM
FLT/FLV2854RDEPL/R	FLB0450MWM	NA
FLT/FLV2854RRTN	FLB0450MWM	FLB0450MWM
FLT/FLV2854RRTP	FLB0450MWM	FLB0450MWM
FLT/FLV2854TD	FLB0450MWM	FLB0444MWM
FLT/FLV2860ARCTP	FLB0450MWM	FLB0450MWM
FLT/FLV2860BMTNL/R	FLB0432MWM	FLB0432MWM
FLT/FLV2860RDEPL/R	FLB0456MWM	NA
FLT/FLV2860RRTN	FLB0456MWM	FLB0456MWM
FLT/FLV2860RRTP	FLB0456MWM	FLB0456MWM
FLT/FLV2860TD	FLB0456MWM	FLB0450MWM
FLT/FLV2866ARCTP	FLB0456MWM	FLB0456MWM
FLT/FLV2866BMTNL/R	FLB0432MWM	FLB0432MWM
FLT/FLV2866DTEPL/R	FLB0456MWM	NA
FLT/FLV2866PARCP	FLB0456MWM	FLB0456MWM
FLT/FLV2866PARCPEP	FLB0456MWM	NA
FLT/FLV2866PBMNEPL/R	FLB0432MWM	NA
FLT/FLV2866PBMNL/R	FLB0432MWM	FLB0432MWM
FLT/FLV2866PDEPL	FLB0462MWM	NA
FLT/FLV2866PDEPPL/R	FLB0462MWM	NA
FLT/FLV2866PDEPR	FLB0462MWM	NA
FLT/FLV2866PDN	FLB0462MWM	FLB0456MWM
FLT/FLV2866PDNEP	FLB0462MWM	NA
FLT/FLV2866PDP	FLB0462MWM	FLB0456MWM
FLT/FLV2866PDPEP	FLB0462MWM	NA
FLT/FLV2866PDTEPL/R	FLB0456MWM	NA
FLT/FLV2866RDEPL/R	FLB0462MWM	NA
FLT/FLV2866RRTN	FLB0462MWM	FLB0462MWM
FLT/FLV2866RRTP	FLB0462MWM	FLB0462MWM
FLT/FLV2866TD	FLB0462MWM	FLB0456MWM
FLT/FLV2872ARCTP	FLB0462MWM	FLB0462MWM
FLT/FLV2872BMTNL/R	FLB0438MWM	FLB0438MWM
FLT/FLV2872DTEPL/R	FLB0462MWM	NA

Laminate/Veneer Model Number	Wire Manager Model Number	
	Eased Edge	Knife Edge
FLT/FLV2872PARCP	FLB0462MWM	FLB0462MWM
FLT/FLV2872PARCPEP	FLB0462MWM	NA
FLT/FLV2872PBMNEPL/R	FLB0438MWM	NA
FLT/FLV2872PBMNL/R	FLB0438MWM	FLB0438MWM
FLT/FLV2872PDEPL	FLB0468MWM	NA
FLT/FLV2872PDEPPL/R	FLB0468MWM	NA
FLT/FLV2872PDEPR	FLB0468MWM	NA
FLT/FLV2872PDN	FLB0468MWM	FLB0462MWM
FLT/FLV2872PDNEP	FLB0468MWM	NA
FLT/FLV2872PDP	FLB0468MWM	FLB0462MWM
FLT/FLV2872PDPEP	FLB0468MWM	NA
FLT/FLV2872PDTEPL/R	FLB0462MWM	NA
FLT/FLV2872RDEPL/R	FLB0468MWM	NA
FLT/FLV2872RRTN	FLB0468MWM	FLB0468MWM
FLT/FLV2872RRTP	FLB0468MWM	FLB0468MWM
FLT/FLV2872TD	FLB0468MWM	FLB0462MWM
FLT/FLV2878DTEPL/R	FLB0468MWM	NA
FLT/FLV2878PARCP	FLB0468MWM	FLB0468MWM
FLT/FLV2878PARCPEP	FLB0468MWM	NA
FLT/FLV2878PBMNEPL/R	FLB0444MWM	NA
FLT/FLV2878PBMNL/R	FLB0444MWM	FLB0444MWM
FLT/FLV2878PDEPL	FLB0474MWM	NA
FLT/FLV2878PDEPPR	FLB0474MWM	NA
FLT/FLV2878PDEPR	FLB0474MWM	NA
FLT/FLV2878PDN	FLB0474MWM	FLB0468MWM
FLT/FLV2878PDNEP	FLB0474MWM	NA
FLT/FLV2878PDP	FLB0474MWM	FLB0468MWM
FLT/FLV2878PDPEP	FLB0474MWM	NA
FLT/FLV2878PDTEPL/R	FLB0468MWM	NA
FLT/FLV2884DTEPL/R	FLB0474MWM	NA
FLT/FLV2884PARCP	FLB0474MWM	FLB0474MWM
FLT/FLV2884PARCPEP	FLB0474MWM	NA
FLT/FLV2884PBMNEPL/R	FLB0450MWM	NA
FLT/FLV2884PBMNL/R	FLB0450MWM	FLB0450MWM
FLT/FLV2884PDEPL	FLB0480MWM	NA
FLT/FLV2884PDEPPL/R	FLB0480MWM	NA
FLT/FLV2884PDEPR	FLB0480MWM	NA

Flux Technology

Recommend Size with Peninsula or Run-off Desk (continued)

Laminate/Veneer Model Number	Wire Manager Model Number	
	Eased Edge	Knife Edge
FLT/FLV2884PDN	FLB0480MWM	FLB0474MWM
FLT/FLV2884PDNEP	FLB0480MWM	NA
FLT/FLV2884PDP	FLB0480MWM	FLB0474MWM
FLT/FLV2884PDPEP	FLB0480MWM	NA
FLT/FLV2884PDTEPL/R	FLB0474MWM	NA
FLT/FLV3448ARCTP	FLB0438MWM	FLB0438MWM
FLT/FLV3448RRTN	FLB0444MWM	FLB0444MWM
FLT/FLV3448RRTP	FLB0444MWM	FLB0444MWM
FLT/FLV3454ARCTP	FLB0444MWM	FLB0444MWM
FLT/FLV3454RDEPL/R	FLB0450MWM	NA
FLT/FLV3454RRTN	FLB0450MWM	FLB0450MWM
FLT/FLV3454RRTP	FLB0450MWM	FLB0450MWM
FLT/FLV3460ARCTP	FLB0450MWM	FLB0450MWM
FLT/FLV3460BMTNL/R	FLB0432MWM	FLB0432MWM
FLT/FLV3460RDEPL/R	FLB0456MWM	NA
FLT/FLV3460RRTN	FLB0456MWM	FLB0456MWM
FLT/FLV3460RRTP	FLB0456MWM	FLB0456MWM
FLT/FLV3466ARCTP	FLB0456MWM	FLB0456MWM
FLT/FLV3466BMTNL/R	FLB0432MWM	FLB0432MWM
FLT/FLV3466DTEPL/R	FLB0456MWM	NA
FLT/FLV3466PARCP	FLB0456MWM	FLB0456MWM
FLT/FLV3466PARCPEP	FLB0456MWM	NA
FLT/FLV3466PBMNEPL/R	FLB0432MWM	NA
FLT/FLV3466PBMNL/R	FLB0432MWM	FLB0432MWM
FLT/FLV3466PDEPL	FLB0462MWM	NA
FLT/FLV3466PDEPPL/R	FLB0462MWM	NA
FLT/FLV3466PDEPR	FLB0462MWM	NA
FLT/FLV3466PDN	FLB0462MWM	FLB0456MWM
FLT/FLV3466PDNEP	FLB0462MWM	NA
FLT/FLV3466PDP	FLB0462MWM	FLB0456MWM
FLT/FLV3466PDPEP	FLB0462MWM	NA
FLT/FLV3466PDTEPL/R	FLB0456MWM	NA
FLT/FLV3466RDEPL/R	FLB0462MWM	NA
FLT/FLV3466RRTN	FLB0462MWM	FLB0462MWM
FLT/FLV3466RRTP	FLB0462MWM	FLB0462MWM
FLT/FLV3466TD	FLB0462MWM	FLB0456MWM
FLT/FLV3472ARCTP	FLB0462MWM	FLB0462MWM
FLT/FLV3472BMTNL/R	FLB0438MWM	FLB0438MWM
FLT/FLV3472DTEPL/R	FLB0462MWM	NA
FLT/FLV3472PARCP	FLB0462MWM	FLB0462MWM
FLT/FLV3472PARCPEP	FLB0462MWM	NA

Laminate/Veneer Model Number	Wire Manager Model Number	
	Eased Edge	Knife Edge
FLT/FLV3472PBMNEPL/R	FLB0438MWM	NA
FLT/FLV3472PBMNL/R	FLB0438MWM	FLB0438MWM
FLT/FLV3472PDEPL	FLB0468MWM	NA
FLT/FLV3472PDEPPL/R	FLB0468MWM	NA
FLT/FLV3472PDEPR	FLB0468MWM	NA
FLT/FLV3472PDN	FLB0468MWM	FLB0462MWM
FLT/FLV3472PDNEP	FLB0468MWM	NA
FLT/FLV3472PDP	FLB0468MWM	FLB0462MWM
FLT/FLV3472PDPEP	FLB0468MWM	NA
FLT/FLV3472PDTEPL/R	FLB0462MWM	NA
FLT/FLV3472RDEPL/R	FLB0468MWM	NA
FLT/FLV3472RRTN	FLB0468MWM	FLB0468MWM
FLT/FLV3472RRTP	FLB0468MWM	FLB0468MWM
FLT/FLV3472TD	FLB0468MWM	FLB0462MWM
FLT/FLV3478DTEPL/R	FLB0468MWM	NA
FLT/FLV3478PARCP	FLB0468MWM	FLB0468MWM
FLT/FLV3478PARCPEP	FLB0468MWM	NA
FLT/FLV3478PBMNEPL/R	FLB0444MWM	NA
FLT/FLV3478PBMNL/R	FLB0444MWM	FLB0444MWM
FLT/FLV3478PDEPL	FLB0474MWM	NA
FLT/FLV3478PDEPPL/R	FLB0474MWM	NA
FLT/FLV3478PDEPR	FLB0474MWM	NA
FLT/FLV3478PDN	FLB0474MWM	FLB0468MWM
FLT/FLV3478PDNEP	FLB0474MWM	NA
FLT/FLV3478PDP	FLB0474MWM	FLB0468MWM
FLT/FLV3478PDPEP	FLB0474MWM	NA
FLT/FLV3478PDTEPL/R	FLB0468MWM	NA
FLT/FLV3484DTEPL/R	FLB0474MWM	NA
FLT/FLV3484PARCP	FLB0474MWM	FLB0474MWM
FLT/FLV3484PARCPEP	FLB0474MWM	NA
FLT/FLV3484PBMNEPL/R	FLB0450MWM	NA
FLT/FLV3484PBMNL/R	FLB0450MWM	FLB0450MWM
FLT/FLV3484PDEPL	FLB0480MWM	NA
FLT/FLV3484PDEPPL/R	FLB0480MWM	NA
FLT/FLV3484PDEPR	FLB0480MWM	NA
FLT/FLV3484PDN	FLB0480MWM	FLB0474MWM
FLT/FLV3484PDNEP	FLB0480MWM	NA
FLT/FLV3484PDP	FLB0480MWM	FLB0474MWM
FLT/FLV3484PDPEP	FLB0480MWM	NA
FLT/FLV3484PDTEPL/R	FLB0474MWM	NA

Description	D	W	H	CTN WT	CU FT	① Model	HPL Laminate	Essentials Veneer	Artisan Veneer
Table Desk	33½	72	29	139	22	FLT3472TD	\$2,081		
	33½	72	29	139	22	FLV3472TD		\$2,540	\$2,796
	33½	66	29	130	20	FLT3466TD	\$2,056		
	33½	66	29	130	20	FLV3466TD		\$2,510	\$2,764

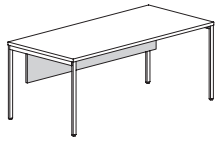

approach

Features:

- eased edge profile on approach and user sides

Options:

- reverse bevel edge available on approach and user sides, specify; add \$451 list for laminate or \$177 list for veneer; see page 8 for details
- casters available, two locking and two non-locking, specify and add \$103 list
- 13½" h modesty panel available, specify; add \$449 list for laminate or \$624 list for veneer; see page 21 for details
- 3" top grommet available, specify A or C location; add \$135 list each



eased



reverse bevel

edges

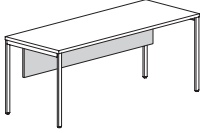
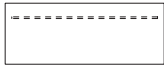
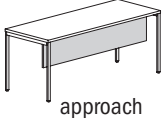
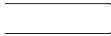
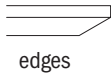
Description	D	W	H	CTN WT	CU FT	① Model	HPL Laminate	Essentials Veneer	Artisan Veneer
    eased  reverse bevel edges	27 1/2	72	29	112	18	FLT2872TD	\$1,986		
	27 1/2	72	29	112	18	FLV2872TD		\$2,439	\$2,682
	27 1/2	66	29	105	17	FLT2866TD	\$1,970		
	27 1/2	66	29	105	17	FLV2866TD		\$2,419	\$2,658
	27 1/2	60	29	99	15	FLT2860TD	\$1,952		
	27 1/2	60	29	99	15	FLV2860TD		\$2,394	\$2,634
	27 1/2	54	29	93	14	FLT2854TD	\$1,936		
	27 1/2	54	29	93	14	FLV2854TD		\$2,373	\$2,612
	27 1/2	48	29	87	12	FLT2848TD	\$1,911		
	27 1/2	48	29	87	12	FLV2848TD		\$2,346	\$2,459

Features:

- eased edge profile on approach and user sides

Options:

- reverse bevel edge available on approach and user sides, specify; add \$451 list for laminate or \$177 list for veneer; see page 8 for details
- casters available, two locking and two non-locking, specify and add \$103 list
- 13 1/2" h modesty panel available, specify; add \$449 list for laminate or \$624 list for veneer; see page 21 for details
- 3" top grommet available, specify A or C location; add \$135 list each

To Order, Specify:

① Laminate Model #	② Laminate Type	③ Laminate Selection	④ Metal Color	⑤ Other Product Options	
Laminate (FLT)	HPL	See Laminate Selection	See Metal Finish Color Options	See list of options for each specific unit; Specify and add accordingly.	
① Veneer Model #	② Wood Collection	③ Wood Finish	④ Metal Color	⑤ Other Product Options	
Veneer (FLV)	Essentials	See Essentials Wood Finish Options	See Metal Finish Color Options	See list of options for each specific unit; Specify and add accordingly.	
	Artisan	<table border="1"> <thead> <tr> <th>ⓐ Wood Finish</th> <th>ⓑ Chassis Grain Direction</th> </tr> </thead> <tbody> <tr> <td>See Artisan Wood Finish Options</td> <td>For Artisan Only: Vertical Horizontal</td> </tr> </tbody> </table>			ⓐ Wood Finish
ⓐ Wood Finish	ⓑ Chassis Grain Direction				
See Artisan Wood Finish Options	For Artisan Only: Vertical Horizontal				

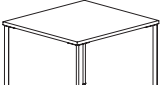
Description	D	W	H	CTN WT	CU FT	① Model	HPL Laminate	Essentials Veneer	Artisan Veneer
	48	48	29	94	14	FLT4848T	\$1,749		
	48	48	29	94	14	FLV4848T		\$2,300	\$2,530
	42	42	29	75	12	FLT4242T	\$1,486		
	42	42	29	75	12	FLV4242T		\$1,955	\$2,150

Features

- eased edge profile all sides

Options:

- reverse bevel edge available on top perimeter, specify; add \$451 list for laminate or \$177 list for veneer; see page 8 for details
- casters available, two locking and two non-locking, specify and add \$103 list



eased



reverse bevel

edges

	33½	33½	29	69	10	FLT3434T	\$1,412		
	33½	33½	29	69	10	FLV3434T		\$1,857	\$2,043
	27½	27½	29	51	9	FLT2828T	\$1,343		
	27½	27½	29	51	9	FLV2828T		\$1,763	\$1,942

Features:

- eased edge profile all sides

Options:

- reverse bevel edge available on top perimeter, specify; add \$451 list for laminate or \$177 list for veneer; see page 8 for details
- casters available, two locking and two non-locking, specify and add \$103 list



eased



reverse bevel

edges

	48	48	29	301	46	FLT4848RT	\$1,833		
	48	48	29	77	14	FLV4848RT		\$2,411	\$2,653
	42	42	29	62	12	FLT4242RT	\$1,557		
	42	42	29	62	12	FLV4242RT		\$2,047	\$2,253

Features:

- eased edge profile

Options:

- reverse bevel edge available on top perimeter, specify; add \$451 list for laminate or \$177 list for veneer; see page 8 for details
- casters available, two locking and two non-locking, specify and add \$103 list



eased



reverse bevel

edges

Description	D	W	H	CTN WT	CU FT	① Model	HPL Laminate	Essentials Veneer	Artisan Veneer
Square Stationary Height Table with Eased Edge Profile - Four Star Base 	30	30	29	39	19	FLT3030ST4B	\$1,553		
	30	30	29	39	19	FLV3030ST4B		\$2,040	\$2,243
	24	24	29	31	13	FLT2424ST4B	\$1,512		
	24	24	29	31	13	FLV2424ST4B		\$1,988	\$2,189

Features:

- ¾" top with flat edge
- 4-star cast aluminum base

Options:

- casters available, two locking and two non-locking, specify and add \$103 list

Description	D	W	H	CTN WT	CU FT	① Model	HPL Laminate	Essentials Veneer	Artisan Veneer
Round Stationary Height Table 	36	36	29	43	27	FLT3636R4B	\$1,592		
	36	36	29	43	27	FLV3636R4B		\$2,093	\$2,301
	30	30	29	36	19	FLT3030R4B	\$1,553		
	30	30	29	36	19	FLV3030R4B		\$2,040	\$2,243

Features:

- ¾" top with flat edge
- 4-star cast aluminum base

Options:

- casters available, two locking and two non-locking, specify and add \$103 list

Description	D	W	H	CTN WT	CU FT	① Model	HPL Laminate	Essentials Veneer	Artisan Veneer
Oval Stationary Height Table 	26	36	29	39	20	FLT2636O4B	\$1,635		
	26	36	29	39	20	FLV2636O4B		\$2,146	\$2,360

Features:

- ¾" top with flat edge
- 4-star cast aluminum base

Options:

- casters available, two locking and two non-locking, specify and add \$103 list

To Order, Specify:

① Laminate Model #	② Laminate Type	③ Laminate Selection		④ Metal Color	⑤ Other Product Options
Laminate (FLT)	HPL	See Laminate Selection		See Metal Finish Color Options	See list of options for each specific unit; Specify and add accordingly.
① Veneer Model #	② Wood Collection	③ Wood Finish		④ Metal Color	⑤ Other Product Options
Veneer (FLV)	Essentials	See Essentials Wood Finish Options		See Metal Finish Color Options	See list of options for each specific unit; Specify and add accordingly.
	Artisan	ⓐ Wood Finish See Artisan Wood Finish Options	ⓑ Chassis Grain Direction For Artisan Only: Vertical Horizontal		

FLUX

Description	D	W	H	CTN WT	CU FT	① Model	HPL Laminate	Essentials Veneer	Artisan Veneer
Bow Front Double Pedestal Desk with Break Front Modesty Continuous Wire Channel - Split Top	42	84	29	359	69	FLT4284BDST	\$3,728		
	42	84	29	359	69	FLV4284BDST		\$5,120	\$5,632
	42	78	29	348	64	FLT4278BDST	\$3,641		
	42	78	29	348	64	FLV4278BDST		\$5,003	\$5,500
	42	72	29	337	59	FLT4272BDST	\$3,558		
	42	72	29	337	59	FLV4272BDST		\$4,885	\$5,372

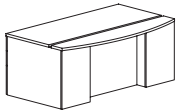
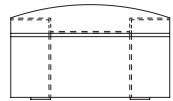
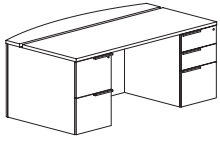

approach

Features:

- eased edge profile on approach and user sides
- built in horizontal wire channel
- 6" overhang on approach side
- pedestal front locking
- FLT4284BDST or FLV4284BDST - chassis 36" x 84"
- FLT4278BDST or FLV4278BDST - chassis 36" x 78"
- FLT4272BDST or FLV4272BDST - chassis 36" x 72"
- FLT4284BDST or FLV4284BDST - kneespace 48"
- FLT4278BDST or FLV4278BDST - kneespace 42"
- FLT4272BDST or FLV4272BDST - kneespace 36"

Options:

- must specify chassis grain direction on artisan veneer, see pages 13-15 for details
- veneer drawer fronts in paint available, specify paint color; add \$354 list; see page 16 for details
- on laminate units, contrasting worksurface tops and drawer fronts available, no upcharge; specify color, see page 16 for details
- must specify ledge or prism pull, specify and see page 9 for details
- pedestal access doors available, specify; add \$298 list for laminate or \$354 list for veneer; see page 17 for details

Description	D	W	H	CTN WT	CU FT	① Model	HPL Laminate	Essentials Veneer	Artisan Veneer
Bow Front Double Pedestal Desk with Break Front Modesty - Continuous Wire Channel - Split Top	36	84	29	341	60	FLT3684BDST	\$3,614		
	36	84	29	341	60	FLV3684BDST		\$4,880	\$5,367
	36	78	29	331	55	FLT3678BDST	\$3,538		
	36	78	29	331	55	FLV3678BDST		\$4,771	\$5,245
	36	72	29	320	51	FLT3672BDST	\$3,461		
	36	72	29	320	51	FLV3672BDST		\$4,665	\$5,131
	36	66	29	309	47	FLT3666BDST	\$3,401		
	36	66	29	309	47	FLV3666BDST		\$4,580	\$5,037
	36	60	29	298	43	FLT3660BDST	\$3,341		
	36	60	29	298	43	FLV3660BDST		\$4,499	\$4,946

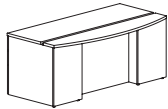
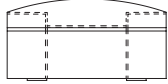
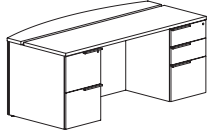

approach

Features:

- eased edge profile on approach and user sides
- built in horizontal wire channel
- 6" overhang on approach side
- pedestal front locking
- FLT3684BDST or FLV3684BDST - chassis 30" x 84"
- FLT3678BDST or FLV3678BDST - chassis 30" x 78"
- FLT3672BDST or FLV3672BDST - chassis 30" x 72"
- FLT3666BDST or FLV3666BDST - chassis 30" x 66"
- FLT3660BDST or FLV3660BDST - chassis 30" x 60"
- FLT3684BDST or FLV3684BDST - kneespace 48"
- FLT3678BDST or FLV3678BDST - kneespace 42"
- FLT3672BDST or FLV3672BDST - kneespace 36"
- FLT3666BDST or FLV3666BDST - kneespace 34 3/4"
- FLT3660BDST or FLV3660BDST - kneespace 28 3/4"

Options:

- veneer drawer fronts in paint available, specify paint color; add \$354 list; see page 16 for details
- on laminate units, contrasting worksurface tops and drawer fronts available, no upcharge; specify color, see page 16 for details
- ledge pulls standard; prism pulls available, specify and see page 9
- pedestal access doors available, specify; add \$298 list for laminate or \$354 list for veneer; see page 17 for details

To Order, Specify:

① Laminate Model #	② Laminate Type	③ Laminate Selection	④ Metal Color	⑤ Other Product Options		
Laminate (FLT)	HPL	See Laminate Selection	See Metal Finish Color Options	See list of options for each specific unit; Specify and add accordingly.		
① Veneer Model #	② Wood Collection	③ Wood Finish	④ Metal Color	⑤ Other Product Options		
Veneer (FLV)	Essentials	See Essentials Wood Finish Options	See Metal Finish Color Options	See list of options for each specific unit; Specify and add accordingly.		
	Artisan	<table border="1"> <thead> <tr> <th>③a Wood Finish</th> <th>③b Chassis Grain Direction</th> </tr> </thead> <tbody> <tr> <td>See Artisan Wood Finish Options</td> <td>For Artisan Only: Vertical Horizontal</td> </tr> </tbody> </table>	③a Wood Finish		③b Chassis Grain Direction	See Artisan Wood Finish Options
③a Wood Finish	③b Chassis Grain Direction					
See Artisan Wood Finish Options	For Artisan Only: Vertical Horizontal					

Description	D	W	H	CTN WT	CU FT	① Model	HPL Laminate	Essentials Veneer	Artisan Veneer
Bow Front Double Pedestal Desk with Break Front Modesty	42	84	29	359	69	FLT4284BD	\$3,519		
	42	84	29	359	69	FLV4284BD		\$4,914	\$5,405
	42	78	29	348	64	FLT4278BD	\$3,435		
	42	78	29	348	64	FLV4278BD		\$4,796	\$5,276
	42	72	29	337	59	FLT4272BD	\$3,352		
	42	72	29	337	59	FLV4272BD		\$4,676	\$5,145

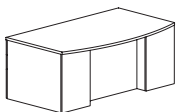
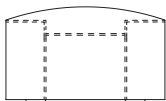
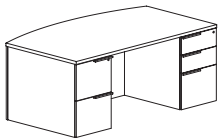

approach

Features:

- eased edge profile on approach and user sides
- 6" overhang on approach side
- pedestal front locking
- FLT4284BD or FLV4284BD - chassis 36" x 84"
- FLT4278BD or FLV4278BD - chassis 36" x 78"
- FLT4272BD or FLV4272BD - chassis 36" x 72"
- FLT4284BD or FLV4284BD - kneespace 48"
- FLT4278BD or FLV4278BD - kneespace 42"
- FLT4272BD or FLV4272BD - kneespace 36"

Options:

- must specify chassis grain direction on artisan veneer, see pages 13-15 for details
- veneer drawer fronts in paint available, specify paint color; add \$354 list; see page 16 for details
- on laminate units, contrasting worksurface tops and drawer fronts available, no upcharge; specify color, see page 16 for details
- ledge pulls standard; prism pulls available, specify and see page 9
- top grommet available, specify location; add \$135 list each; see page 44 for details
- worksurface power available, specify "to accommodate EC26" on your purchase order; EC26 unit must be ordered separately, see page 44
- pedestal access door with wire manager available, use with top grommet, specify; add \$354 list for laminate or \$410 list for veneer; see page 17 for details
- interior kneespace wire manager available, use with top grommet or power unit, specify and add \$120 list; see page 17 for details

Description	D	W	H	CTN WT	CU FT	① Model	HPL Laminate	Essentials Veneer	Artisan Veneer
Bow Front Double Pedestal Desk with Break Front Modesty	36	84	29	341	60	FLT3684BD	\$3,408		
	36	84	29	341	60	FLV3684BD		\$4,671	\$5,141
	36	78	29	331	55	FLT3678BD	\$3,331		
	36	78	29	331	55	FLV3678BD		\$4,561	\$5,018
	36	72	29	320	51	FLT3672BD	\$3,253		
	36	72	29	320	51	FLV3672BD		\$4,459	\$4,902
	36	66	29	309	47	FLT3666BD	\$3,197		
	36	66	29	309	47	FLV3666BD		\$4,374	\$4,811
	36	60	29	298	43	FLT3660BD	\$3,134		
	36	60	29	298	43	FLV3660BD		\$4,292	\$4,719

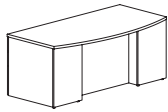
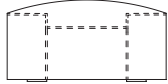
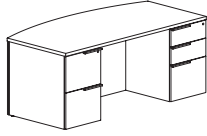

approach

Features:

- eased edge profile on approach and user sides
- 6" overhang on approach side
- pedestal front locking
- FLT3684BD or FLV3684BD - chassis 30" x 84"
- FLT3678BD or FLV3678BD - chassis 30" x 78"
- FLT3672BD or FLV3672BD - chassis 30" x 72"
- FLT3666BD or FLV3666BD - chassis 30" x 66"
- FLT3660BD or FLV3660BD - chassis 30" x 60"
- FLT3684BD or FLV3684BD - kneespace 48"
- FLT3678BD or FLV3678BD - kneespace 42"
- FLT3672BD or FLV3672BD - kneespace 36"
- FLT3666BD or FLV3666BD - kneespace 34 3/4"
- FLT3660BD or FLV3660BD - kneespace 28 3/4"

Options:

- must specify chassis grain direction on artisan veneer, see pages 13-15 for details
- veneer drawer fronts in paint available, specify paint color; add \$354 list; see page 16 for details
- on laminate units, contrasting worksurface tops and drawer fronts available, no upcharge; specify laminate color, see page 16 for details
- ledge pulls standard; prism pulls available, specify and see page 9
- top grommet available, specify location; add \$135 list each; see page 44 for details
- worksurface power available, specify "to accommodate EC26" on your purchase order; EC26 unit must be ordered separately, see page 44
- pedestal access door with wire manager available, use with top grommet, specify; add \$354 list for laminate or \$410 list for veneer; see page 17 for details

To Order, Specify:

① Laminate Model #	② Laminate Type	③ Laminate Selection	④ Metal Color	⑤ Other Product Options		
Laminate (FLT)	HPL	See Laminate Selection	See Metal Finish Color Options	See list of options for each specific unit; Specify and add accordingly.		
① Veneer Model #	② Wood Collection	③ Wood Finish	④ Metal Color	⑤ Other Product Options		
Veneer (FLV)	Essentials	See Essentials Wood Finish Options	See Metal Finish Color Options	See list of options for each specific unit; Specify and add accordingly.		
	Artisan	<table border="1"> <thead> <tr> <th>ⓐ Wood Finish</th> <th>ⓑ Chassis Grain Direction</th> </tr> </thead> <tbody> <tr> <td>See Artisan Wood Finish Options</td> <td>For Artisan Only: Vertical Horizontal</td> </tr> </tbody> </table>	ⓐ Wood Finish		ⓑ Chassis Grain Direction	See Artisan Wood Finish Options
ⓐ Wood Finish	ⓑ Chassis Grain Direction					
See Artisan Wood Finish Options	For Artisan Only: Vertical Horizontal					

Description	D	W	H	CTN WT	CU FT	① Model	HPL Laminate	Essentials Veneer	Artisan Veneer
Double Pedestal Desk with Break	42	84	29	370	69	FLT4284EDST	\$3,564		
Front Modesty Modesty	42	84	29	370	69	FLV4284EDST		\$4,895	\$5,384
Continuous Wire Channel - Split Top	42	78	29	357	64	FLT4278EDST	\$3,481		
	42	78	29	357	64	FLV4278EDST		\$4,778	\$5,260
	42	72	29	359	59	FLT4272EDST	\$3,404		
	42	72	29	359	59	FLV4272EDST		\$4,668	\$5,134

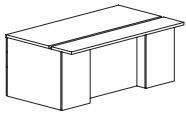
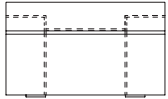
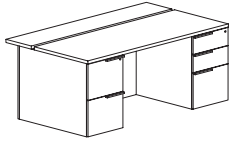

approach

Features:

- eased edge profile on approach and user sides
- built in horizontal wire channel
- 6" overhang on approach side
- pedestal front locking
- FLT4284EDST or FLV4284EDST - chassis 36" x 84"
- FLT4278EDST or FLV4278EDST - chassis 36" x 78"
- FLT4272EDST or FLV4272EDST - chassis 36" x 72"
- FLT4284EDST or FLV4284EDST - kneespace 48"
- FLT4278EDST or FLV4278EDST - kneespace 42"
- FLT4272EDST or FLV4272EDST - kneespace 36"

Options:

- must specify chassis grain direction on artisan veneer, see pages 13-15 for details
- veneer drawer fronts in paint available, specify paint color; add \$354 list; see page 16 for details
- on laminate units, contrasting worksurface tops and drawer fronts available, no upcharge; specify color, see page 16 for details
- ledge pulls standard; prism pulls available, specify and see page 9
- pedestal access doors available, specify; add \$298 list for laminate or \$354 list for veneer; see page 17 for details

Description	D	W	H	CTN WT	CU FT	① Model	HPL Laminate	Essentials Veneer	Artisan Veneer
Double Pedestal Desk with Break	36	84	29	325	60	FLT3684EDST	\$3,398		
Front Modesty - Continuous Wire Channel - Split Top	36	84	29	325	60	FLV3684EDST		\$4,664	\$5,130
	36	78	29	314	55	FLT3678EDST	\$3,321		
	36	78	29	314	55	FLV3678EDST		\$4,553	\$5,010
	36	72	29	303	51	FLT3672EDST	\$3,245		
	36	72	29	303	51	FLV3672EDST		\$4,447	\$4,892
	36	66	29	315	47	FLT3666EDST	\$3,182		
	36	66	29	315	47	FLV3666EDST		\$4,363	\$4,801
	36	60	29	304	43	FLT3660EDST	\$3,124		
	36	60	29	304	43	FLV3660EDST		\$4,281	\$4,709

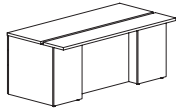
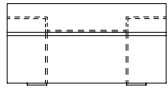
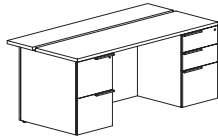

approach

Features:

- eased edge profile on approach and user sides
- built in horizontal wire channel
- 6" overhang on approach side
- pedestal front locking
- FLT3684EDST or FLV3684EDST - chassis 30" x 84"
- FLT3678EDST or FLV3678EDST - chassis 30" x 78"
- FLT3672EDST or FLV3672EDST - chassis 30" x 72"
- FLT3666EDST or FLV3666EDST - chassis 30" x 66"
- FLT3660EDST or FLV3660EDST - chassis 30" x 60"
- FLT3684EDST or FLV3684EDST - kneespace 48"
- FLT3678EDST or FLV3678EDST - kneespace 42"
- FLT3672EDST or FLV3672EDST - kneespace 36"
- FLT3666EDST or FLV3666EDST - kneespace 34 3/4"
- FLT3660EDST or FLV3660EDST - kneespace 28 3/4"

Options:

- must specify chassis grain direction on artisan veneer, see pages 13-15 for details
- veneer drawer fronts in paint available, specify paint color; add \$354 list; see page 16 for details
- on laminate units, contrasting worksurface tops and drawer fronts available, no upcharge; specify laminate color, see page 16 for details
- ledge pulls standard; prism pulls available, specify and see page 9
- pedestal access doors available, specify; add \$298 list for laminate or \$354 list for veneer; see page 17 for details

To Order, Specify:

① Laminate Model #	② Laminate Type	③ Laminate Selection	④ Metal Color	⑤ Other Product Options		
Laminate (FLT)	HPL	See Laminate Selection	See Metal Finish Color Options	See list of options for each specific unit; Specify and add accordingly.		
① Veneer Model #	② Wood Collection	③ Wood Finish	④ Metal Color	⑤ Other Product Options		
Veneer (FLV)	Essentials	See Essentials Wood Finish Options	See Metal Finish Color Options	See list of options for each specific unit; Specify and add accordingly.		
	Artisan	<table border="1"> <thead> <tr> <th>ⓐ Wood Finish</th> <th>ⓑ Chassis Grain Direction</th> </tr> </thead> <tbody> <tr> <td>See Artisan Wood Finish Options</td> <td>For Artisan Only: Vertical Horizontal</td> </tr> </tbody> </table>	ⓐ Wood Finish		ⓑ Chassis Grain Direction	See Artisan Wood Finish Options
ⓐ Wood Finish	ⓑ Chassis Grain Direction					
See Artisan Wood Finish Options	For Artisan Only: Vertical Horizontal					

Description	D	W	H	CTN WT	CU FT	① Model	HPL Laminate	Essentials Veneer	Artisan Veneer
Double Pedestal Desk with Break Front Modesty	42	84	29	357	69	FLT4284ED	\$3,358		
	42	84	29	357	69	FLV4284ED		\$4,689	\$5,158
	42	78	29	359	64	FLT4278ED	\$3,276		
	42	78	29	359	64	FLV4278ED		\$4,573	\$5,031
	42	72	29	349	59	FLT4272ED	\$3,198		
	42	72	29	349	59	FLV4272ED		\$4,462	\$4,906

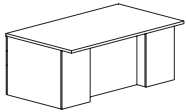
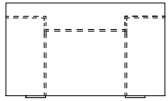
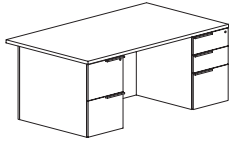

approach

Features:

- eased edge profile on approach and user sides
- 6" overhang on approach side
- pedestal front locking
- FLT4284ED or FLV4284ED - chassis 36" x 84"
- FLT4278ED or FLV4278ED - chassis 36" x 78"
- FLT4272ED or FLV4272ED - chassis 36" x 72"
- FLT4284ED or FLV4284ED - kneespace 48"
- FLT4278ED or FLV4278ED - kneespace 42"
- FLT4272ED or FLV4272ED - kneespace 36"

Options:

- must specify chassis grain direction on artisan veneer, see pages 13-15 for details
- veneer drawer fronts in paint available, specify paint color; add \$354 list; see page 16 for details
- on laminate units, contrasting worksurface tops and drawer fronts available, no upcharge; specify color, see page 16 for details
- ledge pulls standard; prism pulls available, specify and see page 9
- top grommet available, specify location; add \$135 list each; see page 44 for details
- worksurface power available, specify "to accommodate EC26" on your purchase order; EC26 unit must be ordered separately, see page 44
- pedestal access door with wire manager available, use with top grommet, specify; add \$354 list for laminate or \$410 list for veneer; see page 17 for details
- interior kneespace wire manager available, use with top grommet or power unit, specify and add \$120 list; see page 17 for details

Description	D	W	H	CTN WT	CU FT	① Model	HPL Laminate	Essentials Veneer	Artisan Veneer
Double Pedestal Desk with Break Front Modesty	36	84	29	325	60	FLT3684ED	\$3,192		
	36	84	29	325	60	FLV3684ED		\$4,457	\$4,901
	36	78	29	314	55	FLT3678ED	\$3,115		
	36	78	29	314	55	FLV3678ED		\$4,347	\$4,782
	36	72	29	303	51	FLT3672ED	\$3,039		
	36	72	29	303	51	FLV3672ED		\$4,240	\$4,666
	36	66	29	315	47	FLT3666ED	\$2,978		
	36	66	29	315	47	FLV3666ED		\$4,157	\$4,573
	36	60	29	304	43	FLT3660ED	\$2,918		
	36	60	29	304	43	FLV3660ED		\$4,076	\$4,482

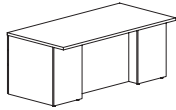
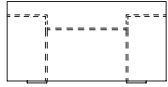
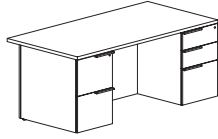

approach

Features:

- eased edge profile on approach and user sides
- 6" overhang on approach side
- pedestal front locking
- FLT3684ED or FLV3684ED - chassis 30" x 84"
- FLT3678ED or FLV3678ED - chassis 30" x 78"
- FLT3672ED or FLV3672ED - chassis 30" x 72"
- FLT3666ED or FLV3666ED - chassis 30" x 66"
- FLT3660ED or FLV3660ED - chassis 30" x 72"
- FLT3684ED or FLV3684ED - kneespace 48"
- FLT3678ED or FLV3678ED - kneespace 42"
- FLT3672ED or FLV3672ED - kneespace 36"
- FLT3666ED or FLV3666ED - kneespace 28 3/4"
- FLT3660ED or FLV3660ED - kneespace 28 3/4"

Options:

- must specify chassis grain direction on artisan veneer, see pages 13-15 for details
- veneer drawer fronts in paint available, specify paint color; add \$354 list; see page 16 for details
- on laminate units, contrasting worksurface tops and drawer fronts available, no upcharge; specify laminate color, see page 16 for details
- ledge pulls standard; prism pulls available, specify and see page 9
- top grommet available, specify location; add \$135 list each; see page 44 for details
- worksurface power available, specify "to accommodate EC26" on your purchase order; EC26 unit must be ordered separately, see page 44
- pedestal access door with wire manager available, use with top grommet, specify; add \$354 list for laminate or \$410 list for veneer; see page 17 for details

To Order, Specify:

① Laminate Model #	② Laminate Type	③ Laminate Selection	④ Metal Color	⑤ Other Product Options		
Laminate (FLT)	HPL	See Laminate Selection	See Metal Finish Color Options	See list of options for each specific unit; Specify and add accordingly.		
① Veneer Model #	② Wood Collection	③ Wood Finish	④ Metal Color	⑤ Other Product Options		
Veneer (FLV)	Essentials	See Essentials Wood Finish Options	See Metal Finish Color Options	See list of options for each specific unit; Specify and add accordingly.		
	Artisan	<table border="1"> <thead> <tr> <th>ⓐ Wood Finish</th> <th>ⓑ Chassis Grain Direction</th> </tr> </thead> <tbody> <tr> <td>See Artisan Wood Finish Options</td> <td>For Artisan Only: Vertical Horizontal</td> </tr> </tbody> </table>	ⓐ Wood Finish		ⓑ Chassis Grain Direction	See Artisan Wood Finish Options
ⓐ Wood Finish	ⓑ Chassis Grain Direction					
See Artisan Wood Finish Options	For Artisan Only: Vertical Horizontal					

Description	D	W	H	CTN WT	CU FT	① Model	HPL Laminate	Essentials Veneer	Artisan Veneer
Double Pedestal Desk with Break	36	84	29	352	60	FLT3684DDST	\$3,497		
Front Modesty Continuous Wire Channel - Split Top	36	84	29	352	60	FLV3684DDST		\$4,801	\$5,281
	36	78	29	342	55	FLT3678DDST	\$3,418		
	36	78	29	342	55	FLV3678DDST		\$4,689	\$5,158
	36	72	29	331	51	FLT3672DDST	\$3,339		
	36	72	29	331	51	FLV3672DDST		\$4,578	\$5,036

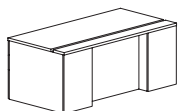
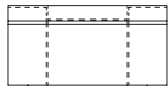
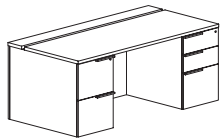

approach

Features:

- eased edge profile on approach and user sides
- built in horizontal wire channel
- pedestal front locking
- FLT3684DDST or FLV3684DDST - chassis 36" x 84"
- FLT3678DDST or FLV3678DDST - chassis 36" x 78"
- FLT3672DDST or FLV3672DDST - chassis 36" x 72"
- FLT3684DDST or FLV3684DDST - kneespace - 48"
- FLT3678DDST or FLV3678DDST - kneespace - 42"
- FLT3672DDST or FLV3672DDST - kneespace - 36"

Options:

- must specify chassis grain direction on artisan veneer, see pages 13-15 for details
- veneer drawer fronts in paint available, specify paint color; add \$354 list; see page 16 for details
- on laminate units, contrasting worksurface tops and drawer fronts available, no upcharge; specify color, see page 16 for details
- ledge pulls standard; prism pulls available, specify and see page 9
- pedestal access doors available, specify; add \$298 list for laminate or \$354 list for veneer; see page 17 for details

Description	D	W	H	CTN WT	CU FT	① Model	HPL Laminate	Essentials Veneer	Artisan Veneer
Double Pedestal Desk with Break	30	84	29	307	50	FLT3084DDST	\$3,364		
Front Modesty - Continuous Wire Channel - Split Top	30	84	29	307	50	FLV3084DDST		\$4,614	\$5,074
	30	78	29	297	47	FLT3078DDST	\$3,287		
	30	78	29	297	47	FLV3078DDST		\$4,505	\$4,958
	30	72	29	287	43	FLT3072DDST	\$3,211		
	30	72	29	287	43	FLV3072DDST		\$4,401	\$4,842
	30	66	29	278	40	FLT3066DDST	\$3,137		
	30	66	29	278	40	FLV3066DDST		\$4,299	\$4,731
	30	60	29	269	36	FLT3060DDST	\$3,066		
	30	60	29	269	36	FLV3060DDST		\$4,200	\$4,620

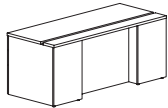
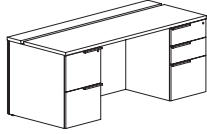

approach

Features:

- eased edge profile on approach and user sides
- built in horizontal wire channel
- pedestal front locking
- FLT3084DDST or FLV3084DDST - chassis 30" x 84"
- FLT3078DDST or FLV3078DDST - chassis 30" x 78"
- FLT3072DDST or FLV3072DDST - chassis 30" x 72"
- FLT3066DDST or FLV3066DDST - chassis 30" x 66"
- FLT3060DDST or FLV3060DDST - chassis 30" x 60"
- FLT3084DDST or FLV3084DDST - kneespace - 48"
- FLT3078DDST or FLV3078DDST - kneespace - 42"
- FLT3072DDST or FLV3072DDST - kneespace - 36"
- FLT3066DDST or FLV3066DDST - kneespace 34 3/4"
- FLT3060DDST or FLV3060DDST - kneespace 28 3/4"

Options:

- must specify chassis grain direction on artisan veneer, see pages 13-15 for details
- veneer drawer fronts in paint available, specify paint color; add \$354 list; see page 16 for details
- on laminate units, contrasting worksurface tops and drawer fronts available, no upcharge; specify laminate color, see page 16 for details
- pedestal access doors available, specify; add \$298 list for laminate or \$354 list for veneer; see page 17 for details

To Order, Specify:

① Laminate Model #	② Laminate Type	③ Laminate Selection	④ Metal Color	⑤ Other Product Options		
Laminate (FLT)	HPL	See Laminate Selection	See Metal Finish Color Options	See list of options for each specific unit; Specify and add accordingly.		
① Veneer Model #	② Wood Collection	③ Wood Finish	④ Metal Color	⑤ Other Product Options		
Veneer (FLV)	Essentials	See Essentials Wood Finish Options	See Metal Finish Color Options	See list of options for each specific unit; Specify and add accordingly.		
	Artisan	<table border="1"> <tr> <th>③a Wood Finish</th> <th>③b Chassis Grain Direction</th> </tr> <tr> <td>See Artisan Wood Finish Options</td> <td>For Artisan Only: Vertical Horizontal</td> </tr> </table>	③a Wood Finish		③b Chassis Grain Direction	See Artisan Wood Finish Options
③a Wood Finish	③b Chassis Grain Direction					
See Artisan Wood Finish Options	For Artisan Only: Vertical Horizontal					

Description	D	W	H	CTN WT	CU FT	① Model	HPL Laminate	Essentials Veneer	Artisan Veneer
Double Pedestal Desk with Break Front Modesty	36	84	29	352	60	FLT3684DD	\$3,290		
	36	84	29	352	60	FLV3684DD		\$4,593	\$5,053
	36	78	29	342	55	FLT3678DD	\$3,211		
	36	78	29	342	55	FLV3678DD		\$4,482	\$4,931
	36	72	29	331	51	FLT3672DD	\$3,133		
	36	72	29	331	51	FLV3672DD		\$4,373	\$4,809

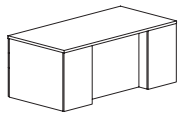
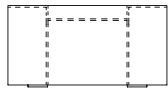
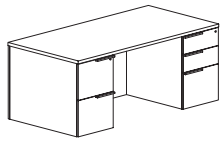

approach

Features:

- eased edge profile on approach and user sides
- pedestal front locking
- FLT3684DD or FLV3684DD - chassis 36" x 84"
- FLT3678DD or FLV3678DD - chassis 36" x 78"
- FLT3672DD or FLV3672DD - chassis 36" x 72"
- FLT3684DD or FLV3684DD - kneespace 48"
- FLT3678DD or FLV3678DD - kneespace 42"
- FLT3672DD or FLV3672DD - kneespace 36"

Options:

- must specify chassis grain direction on artisan veneer, see pages 13-15 for details
- veneer drawer fronts in paint available, specify paint color; add \$354 list; see page 16 for details
- on laminate units, contrasting worksurface tops and drawer fronts available, no upcharge; specify color, see page 16 for details
- ledge pulls standard; prism pulls available, specify and see page 9
- top grommet available, specify location; add \$135 list each; see page 44 for details
- worksurface power available, specify "to accommodate EC26" on your purchase order; EC26 unit must be ordered separately, see page 44
- pedestal access door with wire manager available, use with top grommet, specify; add \$354 list for laminate or \$410 list for veneer; see page 17 for details
- interior kneespace wire manager available, use with top grommet or power unit, specify and add \$120 list; see page 17 for details

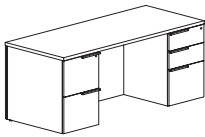
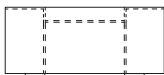
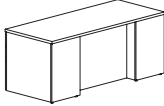
Description	D	W	H	CTN WT	CU FT	① Model	HPL Laminate	Essentials Veneer	Artisan Veneer
   approach	30	84	29	307	50	FLT3084DD	\$3,158		
	30	84	29	307	50	FLV3084DD		\$4,406	\$4,847
	30	78	29	297	47	FLT3078DD	\$3,081		
	30	78	29	297	47	FLV3078DD		\$4,299	\$4,731
	30	72	29	287	43	FLT3072DD	\$3,006		
	30	72	29	287	43	FLV3072DD		\$4,195	\$4,615
	30	66	29	278	40	FLT3066DD	\$2,932		
	30	66	29	278	40	FLV3066DD		\$4,093	\$4,503
	30	60	29	269	36	FLT3060DD	\$2,860		
	30	60	29	269	36	FLV3060DD		\$3,995	\$4,394

Features:

- eased edge profile on approach and user sides
- pedestal front locking
- FLT3084DD or FLV3084DD - chassis 30" x 84"
- FLT3078DD or FLV3078DD - chassis 30" x 78"
- FLT3072DD or FLV3072DD - chassis 30" x 72"
- FLT3066DD or FLV3066DD - chassis 30" x 66"
- FLT3060DD or FLV3060DD - chassis 30" x 60"
- FLT3084DD or FLV3084DD - kneespace 48"
- FLT3078DD or FLV3078DD - kneespace 42"
- FLT3072DD or FLV3072DD - kneespace 36"
- FLT3066DD or FLV3066DD - kneespace 34 3/4"
- FLT3060DD or FLV3060DD - kneespace 28 3/4"

Options:

- must specify chassis grain direction on artisan veneer, see pages 13-15 for details
- veneer drawer fronts in paint available, specify paint color; add \$354 list; see page 16 for details
- on laminate units, contrasting worksurface tops and drawer fronts available, no upcharge; specify laminate color, see page 16 for details
- ledge pulls standard; prism pulls available, specify and see page 9
- top grommet available, specify location; add \$135 list each; see page 44 for details
- worksurface power available, specify "to accommodate EC26" on your purchase order; EC26 unit must be ordered separately, see page 44
- pedestal access door with wire manager available, use with top grommet, specify; add \$354 list for laminate or \$410 list for veneer; see page 17 for details

To Order, Specify:

① Laminate Model #	② Laminate Type	③ Laminate Selection	④ Metal Color	⑤ Other Product Options		
Laminate (FLT)	HPL	See Laminate Selection	See Metal Finish Color Options	See list of options for each specific unit; Specify and add accordingly.		
① Veneer Model #	② Wood Collection	③ Wood Finish	④ Metal Color	⑤ Other Product Options		
Veneer (FLV)	Essentials	See Essentials Wood Finish Options	See Metal Finish Color Options	See list of options for each specific unit; Specify and add accordingly.		
	Artisan	<table border="1"> <thead> <tr> <th>ⓐ Wood Finish</th> <th>ⓑ Chassis Grain Direction</th> </tr> </thead> <tbody> <tr> <td>See Artisan Wood Finish Options</td> <td>For Artisan Only: Vertical Horizontal</td> </tr> </tbody> </table>	ⓐ Wood Finish		ⓑ Chassis Grain Direction	See Artisan Wood Finish Options
ⓐ Wood Finish	ⓑ Chassis Grain Direction					
See Artisan Wood Finish Options	For Artisan Only: Vertical Horizontal					

Description	D	W	H	CTN WT	CU FT	① Model	HPL Laminate	Essentials Veneer	Artisan Veneer
Double Pedestal Desk with Flush Modesty	36	84	29	333	60	FLT3684EDF	\$3,318		
	36	84	29	333	60	FLV3684EDF		\$4,349	\$4,783
	36	78	29	322	55	FLT3678EDF	\$3,238		
	36	78	29	322	55	FLV3678EDF		\$4,242	\$4,668
	36	72	29	312	51	FLT3672EDF	\$3,158		
	36	72	29	312	51	FLV3672EDF		\$4,139	\$4,551

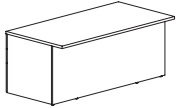
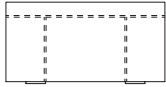
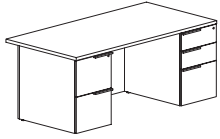

approach

Features:

- eased edge profile on approach and user sides
- 6" overhang on approach side
- pedestal front locking
- FLT3684EDF or FLV3684EDF - chassis 30" x 84"
- FLT3678EDF or FLV3678EDF - chassis 30" x 78"
- FLT3672EDF or FLV3672EDF - chassis 30" x 72"
- FLT3684EDF or FLV3684EDF - kneespace 48"
- FLT3678EDF or FLV3678EDF - kneespace 42"
- FLT3672EDF or FLV3672EDF - kneespace 36"

Options:

- must specify chassis grain direction on artisan veneer, see pages 13-15 for details
- veneer drawer fronts in paint available, specify paint color; add \$354 list; see page 16 for details
- on laminate units, contrasting worksurface tops and drawer fronts available, no upcharge; specify laminate color, see page 16 for details
- ledge pulls standard; prism pulls available, specify and see page 9
- top grommet available, specify location; add \$135 list each; see page 44 for details
- worksurface power available, specify "to accommodate EC26" on your purchase order; EC26 unit must be ordered separately, see page 44
- interior kneespace wire manager available, use with top grommet or power unit, specify and add \$120 list; see page 17 for details

Description	D	W	H	CTN WT	CU FT	① Model	HPL Laminate	Essentials Veneer	Artisan Veneer
Double Pedestal Desk with Flush Modesty	30	72	29	268	43	FLT3072EDF	\$2,859		
	30	72	29	268	43	FLV3072EDF		\$3,990	\$4,387
	30	66	29	261	40	FLT3066EDF	\$2,803		
	30	66	29	261	40	FLV3066EDF		\$3,910	\$4,301
	30	60	29	254	36	FLT3060EDF	\$2,745		
	30	60	29	254	36	FLV3060EDF		\$3,832	\$4,216

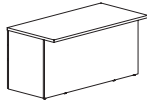
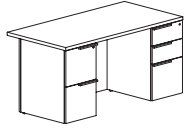

approach

Features:

- eased edge profile on approach and user sides
- 6" overhang on approach side
- pedestal front locking
- FLT3072EDF or FLV3072EDF - chassis 24" x 72"
- FLT3066EDF or FLV3066EDF - chassis 24" x 66"
- FLT3060EDF or FLV3060EDF - chassis 24" x 60"
- FLT3072EDF or FLV3072EDF - kneespace 36"
- FLT3066EDF or FLV3066EDF - kneespace 34 3/4"
- FLT3060EDF or FLV3060EDF - kneespace 28 3/4"

Options:

- must specify chassis grain direction on artisan veneer, see pages 13-15 for details
- veneer drawer fronts in paint available, specify paint color; add \$354 list; see page 16 for details
- on laminate units, contrasting worksurface tops and drawer fronts available, no upcharge; specify laminate color, see page 16 for details
- ledge pulls standard; prism pulls available, specify and see page 9
- top grommet available, specify location; add \$135 list each; see page 44 for details
- worksurface power available, specify "to accommodate EC26" on your purchase order; EC26 unit must be ordered separately, see page 44
- interior kneespace wire manager available, use with top grommet or power unit, specify and add \$120 list; see page 17 for details

To Order, Specify:

① Laminate Model #	② Laminate Type	③ Laminate Selection	④ Metal Color	⑤ Other Product Options		
Laminate (FLT)	HPL	See Laminate Selection	See Metal Finish Color Options	See list of options for each specific unit; Specify and add accordingly.		
① Veneer Model #	② Wood Collection	③ Wood Finish	④ Metal Color	⑤ Other Product Options		
Veneer (FLV)	Essentials	See Essentials Wood Finish Options	See Metal Finish Color Options	See list of options for each specific unit; Specify and add accordingly.		
	Artisan	<table border="1"> <thead> <tr> <th>ⓐ Wood Finish</th> <th>ⓑ Chassis Grain Direction</th> </tr> </thead> <tbody> <tr> <td>See Artisan Wood Finish Options</td> <td>For Artisan Only: Vertical Horizontal</td> </tr> </tbody> </table>	ⓐ Wood Finish		ⓑ Chassis Grain Direction	See Artisan Wood Finish Options
ⓐ Wood Finish	ⓑ Chassis Grain Direction					
See Artisan Wood Finish Options	For Artisan Only: Vertical Horizontal					

Description	D	W	H	CTN WT	CU FT	① Model	HPL Laminate	Essentials Veneer	Artisan Veneer
Double Pedestal Desk with Flush Modesty - Continuous Wire Channel - Split Top	30	84	29	307	50	FLT3084DDSTF	\$3,265		
	30	84	29	307	50	FLV3084DDSTF		\$4,687	\$5,155
	30	78	29	297	47	FLT3078DDSTF	\$3,191		
	30	78	29	297	47	FLV3078DDSTF		\$4,472	\$4,920
	30	72	29	287	43	FLT3072DDSTF	\$3,117		
	30	72	29	287	43	FLV3072DDSTF		\$4,271	\$4,696
	30	66	29	278	40	FLT3066DDSTF	\$3,057		
	30	66	29	278	40	FLV3066DDSTF		\$4,188	\$4,610
	30	60	29	269	36	FLT3060DDSTF	\$3,002		
	30	60	29	269	36	FLV3060DDSTF		\$4,110	\$4,520

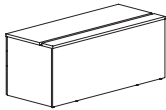
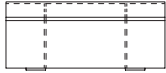
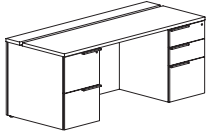

approach

Features:

- eased edge profile on approach and user sides
- built in horizontal wire channel
- pedestal front locking
- FLT3084DDSTF or FLV3084DDSTF - chassis 30" x 84"
- FLT3078DDSTF or FLV3078DDSTF - chassis 30" x 78"
- FLT3072DDSTF or FLV3072DDSTF - chassis 30" x 72"
- FLT3066DDSTF or FLV3066DDSTF - chassis 30" x 66"
- FLT3060DDSTF or FLV3060DDSTF - chassis 30" x 60"
- FLT3084DDSTF or FLV3084DDSTF - kneespace 48"
- FLT3078DDSTF or FLV3078DDSTF - kneespace 42"
- FLT3072DDSTF or FLV3072DDSTF - kneespace 36"
- FLT3066DDSTF or FLV3066DDSTF - kneespace 34 3/4"
- FLT3060DDSTF or FLV3060DDSTF - kneespace 28 3/4"

Options:

- must specify chassis grain direction on artisan veneer, see pages 13-15 for details
- veneer drawer fronts in paint available, specify paint color; add \$354 list; see page 16 for details
- on laminate units, contrasting worksurface tops and drawer fronts available, no upcharge; specify laminate color, see page 16 for details
- ledge pulls standard; prism pulls available, specify and see page 9

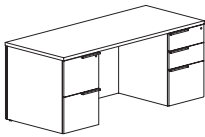
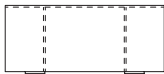
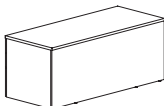
Description	D	W	H	CTN WT	CU FT	① Model	HPL Laminate	Essentials Veneer	Artisan Veneer
   approach	30	84	29	307	50	FLT3084DDF	\$3,057		
	30	84	29	307	50	FLV3084DDF		\$4,480	\$4,928
	30	78	29	297	47	FLT3078DDF	\$2,984		
	30	78	29	297	47	FLV3078DDF		\$4,268	\$4,692
	30	72	29	287	43	FLT3072DDF	\$2,909		
	30	72	29	287	43	FLV3072DDF		\$4,063	\$4,468
	30	66	29	278	40	FLT3066DDF	\$2,852		
	30	66	29	278	40	FLV3066DDF		\$3,981	\$4,381
	30	60	29	269	36	FLT3060DDF	\$2,796		
	30	60	29	269	36	FLV3060DDF		\$3,903	\$4,294

Features:

- eased edge profile on approach and user sides
- pedestal front locking
- FLT3084DDF or FLV3084DDF - chassis 30" x 84"
- FLT3078DDF or FLV3078DDF - chassis 30" x 78"
- FLT3072DDF or FLV3072DDF - chassis 30" x 72"
- FLT3066DDF or FLV3066DDF - chassis 30" x 60"
- FLT3060DDF or FLV3060DDF - chassis 30" x 60"
- FLT3084DDF or FLV3084DDF - kneespace 48"
- FLT3078DDF or FLV3078DDF - kneespace 42"
- FLT3072DDF or FLV3072DDF - kneespace 36"
- FLT3066DDF or FLV3066DDF - kneespace 34 ¾"
- FLT3060DDF or FLV3060DDF - kneespace 28 ¾"

Options:

- must specify chassis grain direction on artisan veneer, see pages 13-15 for details
- veneer drawer fronts in paint available, specify paint color; add \$354 list; see page 16 for details
- on laminate units, contrasting worksurface tops and drawer fronts available, no upcharge; specify laminate color, see page 16 for details
- ledge pulls standard; prism pulls available, specify and see page 9
- top grommet available, specify location; add \$135 list each; see page 44 for details
- worksurface power available, specify "to accommodate EC26" on your purchase order; EC26 unit must be ordered separately, see page 44

To Order, Specify:

① Laminate Model #	② Laminate Type	③ Laminate Selection	④ Metal Color	⑤ Other Product Options		
Laminate (FLT)	HPL	See Laminate Selection	See Metal Finish Color Options	See list of options for each specific unit; Specify and add accordingly.		
① Veneer Model #	② Wood Collection	③ Wood Finish	④ Metal Color	⑤ Other Product Options		
Veneer (FLV)	Essentials	See Essentials Wood Finish Options	See Metal Finish Color Options	See list of options for each specific unit; Specify and add accordingly.		
	Artisan	<table border="1"> <thead> <tr> <th>ⓐ Wood Finish</th> <th>ⓑ Chassis Grain Direction</th> </tr> </thead> <tbody> <tr> <td>See Artisan Wood Finish Options</td> <td>For Artisan Only: Vertical Horizontal</td> </tr> </tbody> </table>	ⓐ Wood Finish		ⓑ Chassis Grain Direction	See Artisan Wood Finish Options
ⓐ Wood Finish	ⓑ Chassis Grain Direction					
See Artisan Wood Finish Options	For Artisan Only: Vertical Horizontal					

Description	D	W	H	CTN WT	CU FT	① Model	HPL Laminate	Essentials Veneer	Artisan Veneer
Bow Front Single Pedestal Desk with Break Front Modesty Continuous Wire Channel - Split Top	42	84	29	318	69	FLT4284RBDST	\$3,252		
	42	84	29	318	69	FLV4284RBDST		\$4,375	\$4,812
	42	84	29	318	69	FLT4284LBDST	\$3,252		
	42	84	29	318	69	FLV4284LBDST		\$4,375	\$4,812
	42	78	29	307	64	FLT4278RBDST	\$3,182		
	42	78	29	307	64	FLV4278RBDST		\$4,278	\$4,707
	42	78	29	307	64	FLT4278LBDST	\$3,182		
	42	78	29	307	64	FLV4278LBDST		\$4,278	\$4,707
	42	72	29	296	59	FLT4272RBDST	\$3,117		
	42	72	29	296	59	FLV4272RBDST		\$4,185	\$4,601
	42	72	29	296	59	FLT4272LBDST	\$3,117		
	42	72	29	296	59	FLV4272LBDST		\$4,185	\$4,601

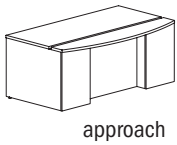
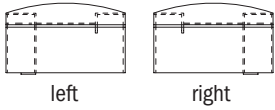
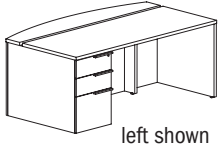

Features:

- eased edge profile on approach and user sides
- built in horizontal wire channel
- 6" overhang on approach side
- pedestal front locking
- FLT4284RBDST or FLT4284LBDST and FLV4284RBDST or FLV4284LBDST - chassis 36" x 84"
- FLT4278RBDST or FLT4278LBDST and FLV4278RBDST or FLV4278LBDST - chassis 36" x 78"
- FLT4272RBDST or FLT4272LBDST and FLV4272RBDST or FLV4272LBDST - chassis 36" x 72"

Options:

- must specify chassis grain direction on artisan veneer, see pages 13-15 for details
- veneer drawer fronts in paint available, specify paint color; add \$354 list; see page 16 for details
- on laminate units, contrasting worksurface tops and drawer fronts available, no upcharge; specify color, see page 16 for details
- ledge pulls standard; prism pulls available, specify and see page 9
- pedestal access doors available, specify; add \$298 list for laminate or \$354 list for veneer; see page 17 for details

Description	D	W	H	CTN WT	CU FT	① Model	HPL Laminate	Essentials Veneer	Artisan Veneer
Bow Front Single Pedestal Desk with Break Front Modesty Continuous Wire Channel - Split Top	36	84	29	285	60	FLT3684RBDST	\$3,098		
	36	84	29	285	60	FLV3684RBDST		\$4,242	\$4,668
	36	84	29	285	60	FLT3684LBDST	\$3,098		
	36	84	29	285	60	FLV3684LBDST		\$4,242	\$4,668
	36	78	29	276	55	FLT3678RBDST	\$3,027		
	36	78	29	276	55	FLV3678RBDST		\$4,146	\$4,557
	36	78	29	276	55	FLT3678LBDST	\$3,027		
	36	78	29	276	55	FLV3678LBDST		\$4,146	\$4,557
	36	72	29	267	51	FLT3672RBDST	\$2,960		
	36	72	29	267	51	FLV3672RBDST		\$4,047	\$4,454
	36	72	29	267	51	FLT3672LBDST	\$2,960		
	36	72	29	267	51	FLV3672LBDST		\$4,047	\$4,454
	36	66	29	258	47	FLT3666RBDST	\$2,893		
	36	66	29	258	47	FLV3666RBDST		\$3,956	\$4,352
	36	66	29	258	47	FLT3666LBDST	\$2,893		
	36	66	29	258	47	FLV3666LBDST		\$3,956	\$4,352
	36	60	29	249	43	FLT3660RBDST	\$2,826		
	36	60	29	249	43	FLV3660RBDST		\$3,864	\$4,251
	36	60	29	249	43	FLT3660LBDST	\$2,826		
	36	60	29	249	43	FLV3660LBDST		\$3,864	\$4,251

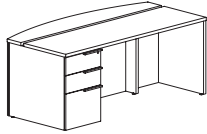

left shown

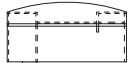

left

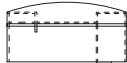

right

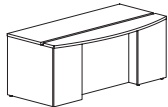

approach

Features:

- eased edge profile on approach and user sides
- built in horizontal wire channel
- 6" overhang on approach side
- pedestal front locking
- FLT3684RBDST or FLT3684LBDST and FLV3684RBDST or FLV3684LBDST - chassis 30" x 84"
- FLT3678RBDST or FLT3678LBDST and FLV3678RBDST or FLV3678LBDST - chassis 30" x 78"
- FLT3672RBDST or FLT3672LBDST and FLV3672RBDST or FLV3672LBDST - chassis 30" x 72"
- FLT3666RBDST or FLT3666LBDST and FLV3666RBDST or FLV3666LBDST - chassis 30" x 66"
- FLT3660RBDST or FLT3660LBDST and FLV3660RBDST or FLV3660LBDST - chassis 30" x 60"

Options:

- must specify chassis grain direction on artisan veneer, see pages 13-15 for details
- veneer drawer fronts in paint available, specify paint color; add \$354 list; see page 16 for details
- on laminate units, contrasting worksurface tops and drawer fronts available, no upcharge; specify laminate color, see page 16 for details
- ledge pulls standard; prism pulls available, specify and see page 9
- pedestal access doors available, specify; add \$298 list for laminate or \$354 list for veneer; see page 17 for details

To Order, Specify:

① Laminate Model #	② Laminate Type	③ Laminate Selection	④ Metal Color	⑤ Other Product Options		
Laminate (FLT)	HPL	See Laminate Selection	See Metal Finish Color Options	See list of options for each specific unit; Specify and add accordingly.		
① Veneer Model #	② Wood Collection	③ Wood Finish	④ Metal Color	⑤ Other Product Options		
Veneer (FLV)	Essentials	See Essentials Wood Finish Options	See Metal Finish Color Options	See list of options for each specific unit; Specify and add accordingly.		
	Artisan	<table border="1"> <tr> <th>ⓐ Wood Finish</th> <th>ⓑ Chassis Grain Direction</th> </tr> <tr> <td>See Artisan Wood Finish Options</td> <td>For Artisan Only: Vertical Horizontal</td> </tr> </table>	ⓐ Wood Finish		ⓑ Chassis Grain Direction	See Artisan Wood Finish Options
ⓐ Wood Finish	ⓑ Chassis Grain Direction					
See Artisan Wood Finish Options	For Artisan Only: Vertical Horizontal					

Description	D	W	H	CTN WT	CU FT	① Model	HPL Laminate	Essentials Veneer	Artisan Veneer
Bow Front Single Pedestal Desk with Break Front Modesty	42	84	29	318	69	FLT4284RBD	\$3,047		
	42	84	29	318	69	FLV4284RBD		\$4,167	\$4,584
	42	84	29	318	69	FLT4284LBD	\$3,047		
	42	84	29	318	69	FLV4284LBD		\$4,167	\$4,584
	42	78	29	307	64	FLT4278RBD	\$2,978		
	42	78	29	307	64	FLV4278RBD		\$4,072	\$4,480
	42	78	29	307	64	FLT4278LBD	\$2,978		
	42	78	29	307	64	FLV4278LBD		\$4,072	\$4,480
	42	72	29	296	59	FLT4272RBD	\$2,909		
	42	72	29	296	59	FLV4272RBD		\$3,978	\$4,375
	42	72	29	296	59	FLT4272LBD	\$2,909		
	42	72	29	296	59	FLV4272LBD		\$3,978	\$4,375

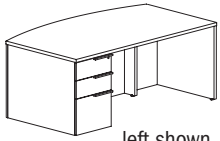

left shown

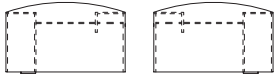

left

right

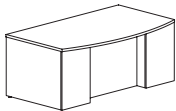





approach

Features:

- eased edge profile on approach and user sides
- 6" overhang on approach side
- pedestal front locking
- FLT4284RBD or FLT4284LBD and FLV4284RBD or FLV4284LBD - chassis 36" x 84"
- FLT4278RBD or FLT4278LBD and FLV4278RBD or FLV4278LBD - chassis 36" x 78"
- FLT4272RBD or FLT4272LBD and FLV4272RBD or FLV4272LBD - chassis 36" x 72"

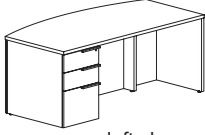
Options:

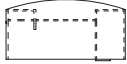
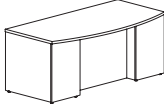
- must specify chassis grain direction on artisan veneer, see pages 13-15 for details
- veneer drawer fronts in paint available, specify paint color and add \$354 list; see page 16 for details
- on laminate units, contrasting worksurface tops and drawer fronts available, no upcharge; specify laminate color, see page 16 for details
- ledge pulls standard; prism pulls available, specify and see page 9
- top grommet available, specify location; add \$135 list each; see page 44 for details
- worksurface power available, specify "to accommodate EC26" on your purchase order; EC26 unit must be ordered separately, see page 44
- pedestal access door with wire manager available, use with top grommet, specify; add \$354 list for laminate or \$410 list for veneer; see page 17 for details
- interior kneespace wire manager available, use with top grommet or power unit, specify and add \$120 list; see page 17 for details

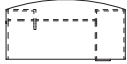
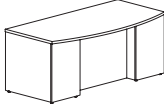
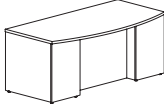
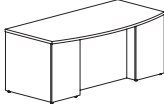
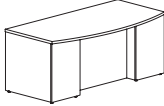
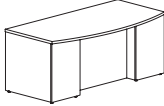
Description	D	W	H	CTN WT	CU FT	① Model	HPL Laminate	Essentials Veneer	Artisan Veneer
Bow Front Single Pedestal Desk with Break Front Modesty	36	84	29	285	60	FLT3684RBD	\$2,893		
	36	84	29	285	60	FLV3684RBD		\$4,037	\$4,440
	36	84	29	285	60	FLT3684LBD	\$2,893		
	36	84	29	285	60	FLV3684LBD		\$4,037	\$4,440
 	36	78	29	276	55	FLT3678RBD	\$2,822		
	36	78	29	276	55	FLV3678RBD		\$3,939	\$4,332
	36	78	29	276	55	FLT3678LBD	\$2,822		
	36	78	29	276	55	FLV3678LBD		\$3,939	\$4,332
 	36	72	29	267	51	FLT3672RBD	\$2,753		
	36	72	29	267	51	FLV3672RBD		\$3,842	\$4,228
	36	72	29	267	51	FLT3672LBD	\$2,753		
	36	72	29	267	51	FLV3672LBD		\$3,842	\$4,228
	36	66	29	258	47	FLT3666RBD	\$2,687		
	36	66	29	258	47	FLV3666RBD		\$3,750	\$4,123
	36	66	29	258	47	FLT3666LBD	\$2,687		
	36	66	29	258	47	FLV3666LBD		\$3,750	\$4,123
	36	60	29	249	43	FLT3660RBD	\$2,620		
	36	60	29	249	43	FLV3660RBD		\$3,657	\$4,024
	36	60	29	249	43	FLT3660LBD	\$2,620		
	36	60	29	249	43	FLV3660LBD		\$3,657	\$4,024

Features:

- eased edge profile on approach and user sides
- 6" overhang on approach side
- pedestal front locking
- FLT3684RBD or FLT3684LBD and FLV3684RBD or FLV3684LBD - chassis 30" x 84"
- FLT3678RBD or FLT3678LBD and FLV3678RBD or FLV3678LBD - chassis 30" x 78"
- FLT3672RBD or FLT3672LBD and FLV3672RBD or FLV3672LBD - chassis 30" x 72"
- FLT3666RBD or FLT3666LBD and FLV3666RBD or FLV3666LBD - chassis 30" x 66"
- FLT3660RBD or FLT3660LBD and FLV3660RBD or FLV3660LBD - chassis 30" x 60"

Options:

- must specify chassis grain direction on artisan veneer, see pages 13-15 for details
- veneer drawer fronts in paint available, specify paint color; add \$354 list; see page 16 for details
- on laminate units, contrasting worksurface tops and drawer fronts available, no upcharge; specify laminate color, see page 16 for details
- ledge pulls standard; prism pulls available, specify and see page 9
- top grommet available, specify location; add \$135 list each; see page 44 for details
- worksurface power available, specify "to accommodate EC26" on your purchase order; EC26 unit must be ordered separately, see page 44
- pedestal access door with wire manager available, use with top grommet, specify; add \$354 list for laminate or \$410 list for veneer; see page 17 for details
- interior kneespace wire manager available, use with top grommet or power unit, specify and add \$120 list; see page 17 for details

To Order, Specify:

① Laminate Model #	② Laminate Type	③ Laminate Selection	④ Metal Color	⑤ Other Product Options		
Laminate (FLT)	HPL	See Laminate Selection	See Metal Finish Color Options	See list of options for each specific unit; Specify and add accordingly.		
① Veneer Model #	② Wood Collection	③ Wood Finish	④ Metal Color	⑤ Other Product Options		
Veneer (FLV)	Essentials	See Essentials Wood Finish Options	See Metal Finish Color Options	See list of options for each specific unit; Specify and add accordingly.		
	Artisan	<table border="1"> <tr> <th>ⓐ Wood Finish</th> <th>ⓑ Chassis Grain Direction</th> </tr> <tr> <td>See Artisan Wood Finish Options</td> <td>For Artisan Only: Vertical Horizontal</td> </tr> </table>	ⓐ Wood Finish		ⓑ Chassis Grain Direction	See Artisan Wood Finish Options
ⓐ Wood Finish	ⓑ Chassis Grain Direction					
See Artisan Wood Finish Options	For Artisan Only: Vertical Horizontal					

Description	D	W	H	CTN WT	CU FT	① Model	HPL Laminate	Essentials Veneer	Artisan Veneer
Single Pedestal Desk with Break	42	84	29	325	69	FLT4284REDST	\$3,038		
Front Modesty - Continuous Wire Channel - Split Top	42	84	29	325	69	FLV4284REDST		\$4,158	\$4,575
	42	84	29	325	69	FLT4284LEDST	\$3,038		
	42	84	29	325	69	FLV4284LEDST		\$4,158	\$4,575
	42	78	29	314	64	FLT4278REDST	\$2,969		
	42	78	29	314	64	FLV4278REDST		\$4,063	\$4,468
	42	78	29	314	64	FLT4278LEDST	\$2,969		
	42	78	29	314	64	FLV4278LEDST		\$4,063	\$4,468
	42	72	29	303	59	FLT4272REDST	\$2,901		
	42	72	29	303	59	FLV4272REDST		\$3,968	\$4,364
	42	72	29	303	59	FLT4272LEDST	\$2,901		
	42	72	29	303	59	FLV4272LEDST		\$3,968	\$4,364

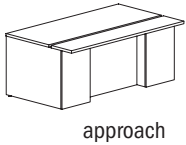
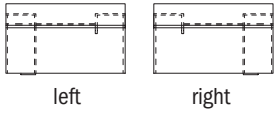
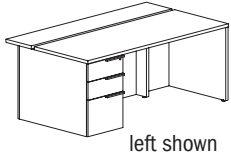

Features:

- eased edge profile on approach and user sides
- built in horizontal wire channel
- 6" overhang on approach side
- pedestal front locking
- FLT4284REDST or FLT4284LEDST and FLV4284REDST or FLV4284LEDST - chassis 36" x 84"
- FLT4278REDST or FLT4278LEDST and FLV4278REDST or FLV4278LEDST - chassis 36" x 78"
- FLT4272REDST or FLT4272LEDST and FLV4272REDST or FLV4272LEDST - chassis 36" x 72"

Options:

- must specify chassis grain direction on artisan veneer, see pages 13-15 for details
- veneer drawer fronts in paint available, specify paint color; add \$354 list; see page 16 for details
- on laminate units, contrasting worksurface tops and drawer fronts available, no upcharge; specify laminate color, see page 16 for details
- ledge pulls standard; prism pulls available, specify and see page 9
- pedestal access doors available, specify; add \$298 list for laminate or \$354 list for veneer; see page 17 for details

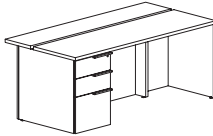
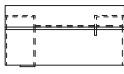
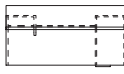
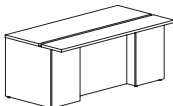
Description	D	W	H	CTN WT	CU FT	① Model	HPL Laminate	Essentials Veneer	Artisan Veneer
Single Pedestal Desk with Break Front Modesty - Continuous Wire Channel - Split Top	36	84	29	289	60	FLT3684REDST	\$2,903		
	36	84	29	289	60	FLV3684REDST		\$3,971	\$4,368
	36	84	29	289	60	FLT3684LEDST	\$2,903		
	36	84	29	289	60	FLV3684LEDST		\$3,971	\$4,368
 	36	78	29	280	55	FLT3678REDST	\$2,837		
	36	78	29	280	55	FLV3678REDST		\$3,881	\$4,269
	36	78	29	280	55	FLT3678LEDST	\$2,837		
	36	78	29	280	55	FLV3678LEDST		\$3,881	\$4,269
	36	72	29	271	51	FLT3672REDST	\$2,774		
	36	72	29	271	51	FLV3672REDST		\$3,788	\$4,167
	36	72	29	271	51	FLT3672LEDST	\$2,774		
	36	72	29	271	51	FLV3672LEDST		\$3,788	\$4,167
	36	66	29	264	47	FLT3666REDST	\$2,722		
	36	66	29	264	47	FLV3666REDST		\$3,717	\$4,088
	36	66	29	264	47	FLT3666LEDST	\$2,722		
	36	66	29	264	47	FLV3666LEDST		\$3,717	\$4,088
	36	60	29	255	43	FLT3660REDST	\$2,672		
	36	60	29	255	43	FLV3660REDST		\$3,648	\$4,014
	36	60	29	255	43	FLT3660LEDST	\$2,672		
	36	60	29	255	43	FLV3660LEDST		\$3,648	\$4,014

Features:

- eased edge profile on approach and user sides
- built in horizontal wire channel
- 6" overhang on approach side
- pedestal front locking
- FLT3684REDST or FLT3684LEDST and FLV3684REDST or FLV3684LEDST - chassis 30" x 84"
- FLT3678REDST or FLT3678LEDST and FLV3678REDST or FLV3678LEDST - chassis 30" x 78"
- FLT3672REDST or FLT3672LEDST and FLV3672REDST or FLV3672LEDST - chassis 30" x 72"
- FLT3666REDST or FLT3666LEDST and FLV3666REDST or FLV3666LEDST - chassis 30" x 66"
- FLT3660REDST or FLT3660LEDST and FLV3660REDST or FLV3660LEDST - chassis 30" x 60"

Options:

- must specify chassis grain direction on artisan veneer, see pages 13-15 for details
- veneer drawer fronts in paint available, specify paint color; add \$354 list; see page 16 for details
- on laminate units, contrasting worksurface tops and drawer fronts available, no upcharge; specify laminate color, see page 16 for details
- ledge pulls standard; prism pulls available, specify and see page 9
- pedestal access doors available, specify; add \$298 list for laminate or \$354 list for veneer; see page 17 for details

To Order, Specify:

① Laminate Model #	② Laminate Type	③ Laminate Selection	④ Metal Color	⑤ Other Product Options		
Laminate (FLT)	HPL	See Laminate Selection	See Metal Finish Color Options	See list of options for each specific unit; Specify and add accordingly.		
① Veneer Model #	② Wood Collection	③ Wood Finish	④ Metal Color	⑤ Other Product Options		
Veneer (FLV)	Essentials	See Essentials Wood Finish Options	See Metal Finish Color Options	See list of options for each specific unit; Specify and add accordingly.		
	Artisan	<table border="1"> <tr> <th>ⓐ Wood Finish</th> <th>ⓑ Chassis Grain Direction</th> </tr> <tr> <td>See Artisan Wood Finish Options</td> <td>For Artisan Only: Vertical Horizontal</td> </tr> </table>	ⓐ Wood Finish		ⓑ Chassis Grain Direction	See Artisan Wood Finish Options
ⓐ Wood Finish	ⓑ Chassis Grain Direction					
See Artisan Wood Finish Options	For Artisan Only: Vertical Horizontal					

Description	D	W	H	CTN WT	CU FT	① Model	HPL Laminate	Essentials Veneer	Artisan Veneer
Single Pedestal Desk with Break Front Modesty	42	84	29	325	69	FLT4284RED	\$2,830		
	42	84	29	325	69	FLV4284RED		\$3,953	\$4,347
	42	84	29	325	69	FLT4284LED	\$2,830		
	42	84	29	325	69	FLV4284LED		\$3,953	\$4,347
	42	78	29	314	64	FLT4278RED	\$2,764		
	42	78	29	314	64	FLV4278RED		\$3,855	\$4,240
	42	78	29	314	64	FLT4278LED	\$2,764		
	42	78	29	314	64	FLV4278LED		\$3,855	\$4,240
	42	72	29	303	59	FLT4272RED	\$2,696		
	42	72	29	303	59	FLV4272RED		\$3,763	\$4,139
	42	72	29	303	59	FLT4272LED	\$2,696		
	42	72	29	303	59	FLV4272LED		\$3,763	\$4,139

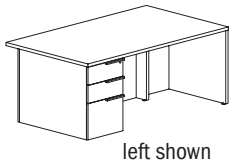

left shown



left

right

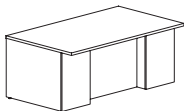

approach

Features:

- eased edge profile on approach and user sides
- 6" overhang on approach side
- pedestal front locking
- FLT4284RED or FLT4284LED and FLV4284RED or FLV4284LED - chassis 36" X 84"
- FLT4278RED or FLT4278LED and FLV4278RED or FLV4278LED - chassis 36" X 78"
- FLT4272RED or FLT4272LED and FLV4272RED or FLV4272LED - chassis 36" X 72"

Options:

- must specify chassis grain direction on artisan veneer, see pages 13-15 for details
- veneer drawer fronts in paint available, specify paint color and add \$354 list; see page 16 for details
- on laminate units, contrasting worksurface tops and drawer fronts available, no upcharge; specify laminate color, see page 16 for details
- ledge pulls standard; prism pulls available, specify and see page 9
- top grommet available, specify location; add \$135 list each; see page 44 for details
- worksurface power available, specify "to accommodate EC26" on your purchase order; EC26 unit must be ordered separately, see page 44
- pedestal access door with wire manager available, use with top grommet, specify; add \$354 list for laminate or \$410 list for veneer; see page 17 for details
- interior kneespace wire manager available, use with top grommet or power unit, specify and add \$120 list; see page 17 for details

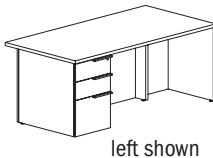
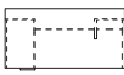
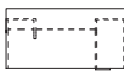
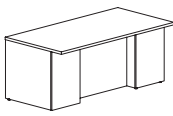
Description	D	W	H	CTN WT	CU FT	① Model	HPL Laminate	Essentials Veneer	Artisan Veneer
Single Pedestal Desk with Break Front Modesty	36	84	29	289	60	FLT3684RED	\$2,697		
	36	84	29	289	60	FLV3684RED		\$3,765	\$4,142
 left shown  left  right  approach	36	84	29	289	60	FLT3684LED	\$2,697		
	36	84	29	289	60	FLV3684LED		\$3,765	\$4,142
	36	78	29	280	55	FLT3678RED	\$2,630		
	36	78	29	280	55	FLV3678RED		\$3,674	\$4,040
	36	78	29	280	55	FLT3678LED	\$2,630		
	36	78	29	280	55	FLV3678LED		\$3,674	\$4,040
	36	72	29	271	51	FLT3672RED	\$2,567		
	36	72	29	271	51	FLV3672RED		\$3,583	\$3,941
	36	72	29	271	51	FLT3672LED	\$2,567		
	36	72	29	271	51	FLV3672LED		\$3,583	\$3,941
	36	66	29	264	47	FLT3666RED	\$2,515		
	36	66	29	264	47	FLV3666RED		\$3,512	\$3,862
	36	66	29	264	47	FLT3666LED	\$2,515		
	36	66	29	264	47	FLV3666LED		\$3,512	\$3,862
	36	60	29	255	43	FLT3660RED	\$2,466		
	36	60	29	255	43	FLV3660RED		\$3,441	\$3,786
	36	60	29	255	43	FLT3660LED	\$2,466		
	36	60	29	255	43	FLV3660LED		\$3,441	\$3,786

Features:

- eased edge profile on approach and user sides
- 6" overhang on approach side
- pedestal front locking
- FLT3684RED or FLT3684LED and FLV3684RED or FLV3684LED - chassis 30" x 84"
- FLT3678RED or FLT3678LED and FLV3678RED or FLV3678LED - chassis 30" x 78"
- FLT3672RED or FLT3672LED and FLV3672RED or FLV3672LED - chassis 30" x 72"
- FLV3666RED or FLV3666LED and FLT3666RED or FLT3666LED - chassis 30" x 66"
- FLT3660RED or FLT3660LED and FLV3660RED or FLV3660LED - chassis 30" x 60"

Options:

- must specify chassis grain direction on artisan veneer, see pages 13-15 for details
- veneer drawer fronts in paint available, specify paint color; add \$354 list; see page 16 for details
- on laminate units, contrasting worksurface tops and drawer fronts available, no upcharge; specify laminate color, see page 16 for details
- ledge pulls standard; prism pulls available, specify and see page 9
- top grommet available, specify location; add \$135 list each; see page 44 for details
- worksurface power available, specify "to accommodate EC26" on your purchase order; EC26 unit must be ordered separately, see page 44
- pedestal access door with wire manager available, use with top grommet, specify; add \$354 list for laminate or \$410 list for veneer; see page 17 for details
- interior kneespace wire manager available, use with top grommet or power unit, specify and add \$120 list; see page 17 for details

To Order, Specify:

① Laminate Model #	② Laminate Type	③ Laminate Selection	④ Metal Color	⑤ Other Product Options
Laminate (FLT)	HPL	See Laminate Selection	See Metal Finish Color Options	See list of options for each specific unit; Specify and add accordingly.
① Veneer Model #	② Wood Collection	③ Wood Finish	④ Metal Color	⑤ Other Product Options
Veneer (FLV)	Essentials	See Essentials Wood Finish Options	See Metal Finish Color Options	See list of options for each specific unit; Specify and add accordingly.
	Artisan	a Wood Finish See Artisan Wood Finish Options	b Chassis Grain Direction For Artisan Only: Vertical Horizontal	

Description	D	W	H	CTN WT	CU FT	① Model	HPL Laminate	Essentials Veneer	Artisan Veneer
Single Pedestal Desk with Break	36	84	29	306	60	FLT3684RDST	\$2,970		
Front Modesty -Continuous Wire Channel - Split Top	36	84	29	306	60	FLV3684RDST		\$4,065	\$4,471
	36	84	29	306	60	FLT3684LDST	\$2,970		
	36	84	29	306	60	FLV3684LDST		\$4,065	\$4,471
	36	78	29	295	55	FLT3678RDST	\$2,903		
	36	78	29	295	55	FLV3678RDST		\$3,971	\$4,368
	36	78	29	295	55	FLT3678LDST	\$2,903		
	36	78	29	295	55	FLV3678LDST		\$3,971	\$4,368
	36	72	29	284	51	FLT3672RDST	\$2,890		
	36	72	29	284	51	FLV3672RDST		\$3,880	\$4,268
	36	72	29	284	51	FLT3672LDST	\$2,890		
	36	72	29	284	51	FLV3672LDST		\$3,880	\$4,268

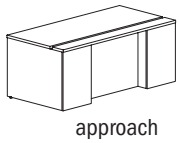
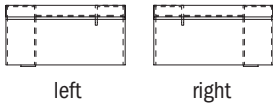
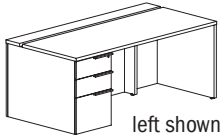



Features:

- eased edge profile on approach and user sides
- built in horizontal wire channel
- pedestal front locking
- FLT3684RDST or FLT3684LDST and FLV3684RDST or FLV3684LDST - chassis 36" x 84"
- FLT3678RDST or FLT3678LDST and FLV3678RDST or FLV3678LDST - chassis 36" x 78"
- FLT3672RDST or FLT3672LDST and FLV3672RDST or FLV3672LDST - chassis 36" x 72"

Options:

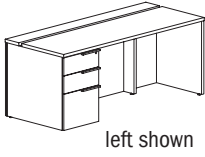
- must specify chassis grain direction on artisan veneer, see pages 13-15 for details
- veneer drawer fronts in paint available, specify paint color and add \$354 list; see page 16 for details
- on laminate units, contrasting worksurface tops and drawer fronts available, no upcharge; specify laminate color, see page 16 for details
- ledge pulls standard; prism pulls available, specify and see page 9
- pedestal access doors available, specify; add \$298 list for laminate or \$354 list for veneer; see page 17 for details

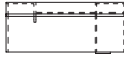
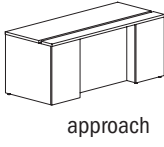
Description	D	W	H	CTN WT	CU FT	① Model	HPL Laminate	Essentials Veneer	Artisan Veneer
Single Pedestal Desk with Break Front Modesty - Continuous Wire Channel - Split Top	30	84	29	272	50	FLT3084RDST	\$2,867		
	30	84	29	272	50	FLV3084RDST		\$3,920	\$4,313
	30	84	29	272	50	FLT3084LDST	\$2,867		
	30	84	29	272	50	FLV3084LDST		\$3,920	\$4,313
 	30	78	29	264	47	FLT3078RDST	\$2,805		
	30	78	29	264	47	FLV3078RDST		\$3,830	\$4,213
	30	78	29	264	47	FLT3078LDST	\$2,805		
	30	78	29	264	47	FLV3078LDST		\$3,830	\$4,213
	30	72	29	256	43	FLT3072RDST	\$2,740		
	30	72	29	256	43	FLV3072RDST		\$3,743	\$4,115
	30	72	29	256	43	FLT3072LDST	\$2,740		
	30	72	29	256	43	FLV3072LDST		\$3,743	\$4,115
	30	66	29	248	40	FLT3066RDST	\$2,678		
	30	66	29	248	40	FLV3066RDST		\$3,656	\$4,023
	30	66	29	248	40	FLT3066LDST	\$2,678		
	30	66	29	248	40	FLV3066LDST		\$3,656	\$4,023
	30	60	29	240	36	FLT3060RDST	\$2,619		
	30	60	29	240	36	FLV3060RDST		\$3,572	\$3,931
	30	60	29	240	36	FLT3060LDST	\$2,619		
	30	60	29	240	36	FLV3060LDST		\$3,572	\$3,931

Features:

- eased edge profile on approach and user sides
- built in horizontal wire channel
- pedestal front locking
- FLT3084RDST or FLT3084LDST and FLV3084RDST or FLV3084LDST - chassis 30" x 84"
- FLT3078RDST or FLT3078LDST and FLV3078RDST or FLV3078LDST - chassis 30" x 78"
- FLT3072RDST or FLT3072LDST and FLV3072RDST or FLV3072LDST - chassis 30" x 72"
- FLT3066RDST or FLT3066LDST and FLV3066RDST or FLV3066LDST - chassis 30" x 66"
- FLT3060RDST or FLT3060LDST and FLV3060RDST or FLV3060LDST - chassis 30" x 60"

Options:

- must specify chassis grain direction on artisan veneer, see pages 13-15 for details
- veneer drawer fronts in paint available, specify paint color; add \$354 list; see page 16 for details
- on laminate units, contrasting worksurface tops and drawer fronts available, no upcharge; specify laminate color, see page 16 for details
- ledge pulls standard; prism pulls available, specify and see page 9
- pedestal access doors available, specify; add \$298 list for laminate or \$354 list for veneer; see page 17 for details

To Order, Specify:

① Laminate Model #	② Laminate Type	③ Laminate Selection	④ Metal Color	⑤ Other Product Options
Laminate (FLT)	HPL	See Laminate Selection	See Metal Finish Color Options	See list of options for each specific unit; Specify and add accordingly.
① Veneer Model #	② Wood Collection	③ Wood Finish	④ Metal Color	⑤ Other Product Options
Veneer (FLV)	Essentials	See Essentials Wood Finish Options	See Metal Finish Color Options	See list of options for each specific unit; Specify and add accordingly.
	Artisan	ⓐ Wood Finish See Artisan Wood Finish Options	ⓑ Chassis Grain Direction For Artisan Only: Vertical Horizontal	

Description	D	W	H	CTN WT	CU FT	① Model	HPL Laminate	Essentials Veneer	Artisan Veneer
Single Pedestal Desk with Break Front Modesty	36	84	29	306	60	FLT3684RD	\$2,765		
	36	84	29	306	60	FLV3684RD		\$3,858	\$4,244
	36	84	29	306	60	FLT3684LD	\$2,765		
	36	84	29	306	60	FLV3684LD		\$3,858	\$4,244
	36	78	29	295	55	FLT3678RD	\$2,697		
	36	78	29	295	55	FLV3678RD		\$3,765	\$4,142
	36	78	29	295	55	FLT3678LD	\$2,697		
	36	78	29	295	55	FLV3678LD		\$3,765	\$4,142
	36	72	29	284	51	FLT3672RD	\$2,682		
	36	72	29	284	51	FLV3672RD		\$3,673	\$4,039
	36	72	29	284	51	FLT3672LD	\$2,682		
	36	72	29	284	51	FLV3672LD		\$3,673	\$4,039

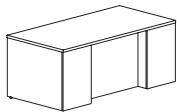
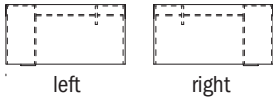
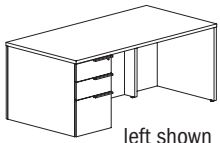

Features:

- eased edge profile on approach and user sides
- pedestal front locking
- FLT3684RD or FLT3684RD and FLV3684LD or FLV3684LD - chassis 36" x 84"
- FLT3678RD or FLT3678LD and FLV3678RD or FLV3678LD - chassis 36" x 78"
- FLT3672RD or FLT3672LD and FLV3672RD or FLV3672LD - chassis 36" x 72"

Options:

- must specify chassis grain direction on artisan veneer, see pages 13-15 for details
- veneer drawer fronts in paint available, specify paint color and add \$354 list; see page 16 for details
- on laminate units, contrasting worksurface tops and drawer fronts available, no upcharge; specify laminate color, see page 16 for details
- ledge pulls standard; prism pulls available, specify and see page 9
- top grommet available, specify location; add \$135 list each; see page 44 for details
- worksurface power available, specify "to accommodate EC26" on your purchase order; EC26 unit must be ordered separately, see page 44
- pedestal access door with wire manager available, use with top grommet, specify; add \$354 list for laminate or \$410 list for veneer; see page 17 for details
- interior kneespace wire manager available, use with top grommet or power unit, specify and add \$120 list; see page 17 for details

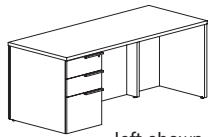
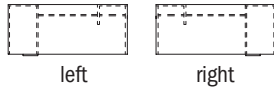
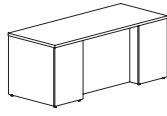
Description	D	W	H	CTN WT	CU FT	① Model	HPL Laminate	Essentials Veneer	Artisan Veneer
 <p>left shown</p>  <p>left right</p>  <p>approach</p>	30	84	29	272	50	FLT3084RD	\$2,659		
	30	84	29	272	50	FLV3084RD		\$3,713	\$4,086
	30	84	29	272	50	FLT3084LD	\$2,659		
	30	84	29	272	50	FLV3084LD		\$3,713	\$4,086
	30	78	29	264	47	FLT3078RD	\$2,595		
	30	78	29	264	47	FLV3078RD		\$3,625	\$3,985
	30	78	29	264	47	FLT3078LD	\$2,595		
	30	78	29	264	47	FLV3078LD		\$3,625	\$3,985
	30	72	29	256	43	FLT3072RD	\$2,534		
	30	72	29	256	43	FLV3072RD		\$3,537	\$3,889
	30	72	29	256	43	FLT3072LD	\$2,534		
	30	72	29	256	43	FLV3072LD		\$3,537	\$3,889
	30	66	29	248	40	FLT3066RD	\$2,471		
	30	66	29	248	40	FLV3066RD		\$3,450	\$3,796
	30	66	29	248	40	FLT3066LD	\$2,471		
	30	66	29	248	40	FLV3066LD		\$3,450	\$3,796
	30	60	29	240	36	FLT3060RD	\$2,411		
	30	60	29	240	36	FLV3060RD		\$3,366	\$3,703
	30	60	29	240	36	FLT3060LD	\$2,411		
	30	60	29	240	36	FLV3060LD		\$3,366	\$3,703

Features:

- eased edge profile on approach and user sides
- pedestal front locking
- FLT3084RD or FLT3084LD and FLV3084RD or FLV3084LD - chassis 30" x 84"
- FLT3078RD or FLT3078LD and FLV3078RD or FLV3078LD - chassis 30" x 78"
- FLT3072RD or FLT3072LD and FLV3072RD or FLV3072LD - chassis 30" x 72"
- FLT3066RD or FLT3066LD and FLV3066RD or FLV3066LD - chassis 30" x 66"
- FLT3060RD or FLT3060LD and FLV3060RD or FLV3060LD - chassis 30" x 60"

Options:

- must specify chassis grain direction on artisan veneer, see pages 13-15 for details
- veneer drawer fronts in paint available, specify paint color; add \$354 list; see page 16 for details
- on laminate units, contrasting worksurface tops and drawer fronts available, no upcharge; specify laminate color, see page 16 for details
- ledge pulls standard; prism pulls available, specify and see page 9
- top grommet available, specify location; add \$135 list each; see page 44 for details
- worksurface power available, specify "to accommodate EC26" on your purchase order; EC26 unit must be ordered separately, see page 44
- pedestal access door with wire manager available, use with top grommet, specify; add \$354 list for laminate or \$410 list for veneer; see page 17 for details
- interior kneespace wire manager available, use with top grommet or power unit, specify and add \$120 list; see page 17 for details

To Order, Specify:

① Laminate Model #	② Laminate Type	③ Laminate Selection	④ Metal Color	⑤ Other Product Options		
Laminate (FLT)	HPL	See Laminate Selection	See Metal Finish Color Options	See list of options for each specific unit; Specify and add accordingly.		
① Veneer Model #	② Wood Collection	③ Wood Finish	④ Metal Color	⑤ Other Product Options		
Veneer (FLV)	Essentials	See Essentials Wood Finish Options	See Metal Finish Color Options	See list of options for each specific unit; Specify and add accordingly.		
	Artisan	<table border="1"> <tr> <th>ⓐ Wood Finish</th> <th>ⓑ Chassis Grain Direction</th> </tr> <tr> <td>See Artisan Wood Finish Options</td> <td>For Artisan Only: Vertical Horizontal</td> </tr> </table>	ⓐ Wood Finish		ⓑ Chassis Grain Direction	See Artisan Wood Finish Options
ⓐ Wood Finish	ⓑ Chassis Grain Direction					
See Artisan Wood Finish Options	For Artisan Only: Vertical Horizontal					

Description	D	W	H	CTN WT	CU FT	① Model	HPL Laminate	Essentials Veneer	Artisan Veneer
Single Pedestal Desk with Flush Modesty	36	84	29	272	60	FLT3684REDF	\$2,558		
	36	84	29	272	60	FLV3684REDF		\$3,570	\$3,930
	36	84	29	272	60	FLT3684LEDF	\$2,558		
	36	84	29	272	60	FLV3684LEDF		\$3,570	\$3,930
	36	78	29	263	55	FLT3678REDF	\$2,496		
	36	78	29	263	55	FLV3678REDF		\$3,483	\$3,832
	36	78	29	263	55	FLT3678LEDF	\$2,496		
	36	78	29	263	55	FLV3678LEDF		\$3,483	\$3,832
	36	72	29	254	51	FLT3672REDF	\$2,436		
	36	72	29	254	51	FLV3672REDF		\$3,399	\$3,741
	36	72	29	254	51	FLT3672LEDF	\$2,436		
	36	72	29	254	51	FLV3672LEDF		\$3,399	\$3,741

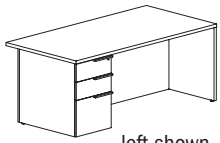

left shown

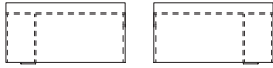

left

right

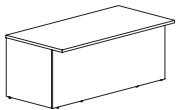

approach

Features:

- eased edge profile on approach and user sides
- 6" overhang on approach side
- pedestal front locking
- FLT3684REDF or FLT3684LEDF and FLV3684REDF or FLV3684LEDF - chassis 30" x 84"
- FLT3678REDF or FLV3678LEDF and FLV3678REDF or FLV3678LEDF - chassis 30" x 78"
- FLT3672REDF or FLT3672LEDF and FLV3672REDF or FLV3672LEDF - chassis 30" x 72"

Options:

- must specify chassis grain direction on artisan veneer, see pages 13-15 for details
- veneer drawer fronts in paint available, specify paint color and add \$354 list; see page 16 for details
- on laminate units, contrasting worksurface tops and drawer fronts available, no upcharge; specify laminate color, see page 16 for details
- ledge pulls standard; prism pulls available, specify and see page 9
- top grommet available, specify location; add \$135 list each; see page 44 for details
- worksurface power available, specify "to accommodate EC26" on your purchase order; EC26 unit must be ordered separately, see page 44
- interior kneespace wire manager available, use with top grommet or power unit, specify and add \$120 list; see page 17 for details

Description	D	W	H	CTN WT	CU FT	① Model	HPL Laminate	Essentials Veneer	Artisan Veneer
Single Pedestal Desk with Flush Modesty	30	72	29	219	43	FLT3072REDF	\$2,323		
	30	72	29	219	43	FLV3072REDF		\$3,244	\$3,568
	30	72	29	219	43	FLT3072LEDF	\$2,323		
	30	72	29	219	43	FLV3072LEDF		\$3,244	\$3,568
	30	66	29	212	40	FLT3066REDF	\$2,267		
	30	66	29	212	40	FLV3066REDF		\$3,164	\$3,480
	30	66	29	212	40	FLT3066LEDF	\$2,267		
	30	66	29	212	40	FLV3066LEDF		\$3,164	\$3,480
	30	60	29	205	36	FLT3060REDF	\$2,213		
	30	60	29	205	36	FLV3060REDF		\$3,087	\$3,397
	30	60	29	205	36	FLT3060LEDF	\$2,213		
	30	60	29	205	36	FLV3060LEDF		\$3,087	\$3,397

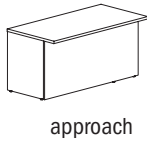
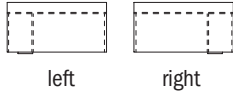
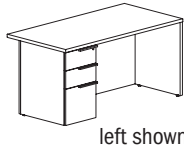

Features:

- eased edge profile on approach and user sides
- 6" overhang on approach side
- pedestal front locking
- FLT3072REDF or FLT3072LEDF and FLV3072REDF or FLV3072LEDF - chassis 24" x 72"
- FLT3066REDF or FLT3066LEDF and FLV3066REDF or FLV3066LEDF - chassis 24" x 66"
- FLT3060REDF or FLT3060LEDF and FLV3060REDF or FLV3060LEDF - chassis 24" x 60"

Options:

- must specify chassis grain direction on artisan veneer, see pages 13-15 for details
- veneer drawer fronts in paint available, specify paint color and add \$354 list; see page 16 for details
- on laminate units, contrasting worksurface tops and drawer fronts available, no upcharge; specify laminate color, see page 16 for details
- ledge pulls standard; prism pulls available, specify and see page 9
- top grommet available, specify location; add \$135 list each; see page 44 for details
- worksurface power available, specify "to accommodate EC26" on your purchase order; EC26 unit must be ordered separately, see page 44
- interior kneespace wire manager available, use with top grommet or power unit, specify and add \$120 list; see page 17 for details

To Order, Specify:

① Laminate Model #	② Laminate Type	③ Laminate Selection	④ Metal Color	⑤ Other Product Options		
Laminate (FLT)	HPL	See Laminate Selection	See Metal Finish Color Options	See list of options for each specific unit; Specify and add accordingly.		
① Veneer Model #	② Wood Collection	③ Wood Finish	④ Metal Color	⑤ Other Product Options		
Veneer (FLV)	Essentials	See Essentials Wood Finish Options	See Metal Finish Color Options	See list of options for each specific unit; Specify and add accordingly.		
	Artisan	<table border="1"> <thead> <tr> <th>ⓐ Wood Finish</th> <th>ⓑ Chassis Grain Direction</th> </tr> </thead> <tbody> <tr> <td>See Artisan Wood Finish Options</td> <td>For Artisan Only: Vertical Horizontal</td> </tr> </tbody> </table>	ⓐ Wood Finish		ⓑ Chassis Grain Direction	See Artisan Wood Finish Options
ⓐ Wood Finish	ⓑ Chassis Grain Direction					
See Artisan Wood Finish Options	For Artisan Only: Vertical Horizontal					

Description	D	W	H	CTN WT	CU FT	① Model	HPL Laminate	Essentials Veneer	Artisan Veneer
Single Pedestal Desk with Flush Modesty - Continuous Wire Channel - Split Top	30	84	29	259	50	FLT3084RDSTF	\$2,697		
	30	84	29	259	50	FLV3084RDSTF		\$3,681	\$4,049
	30	84	29	259	50	FLT3084LDSTF	\$2,697		
	30	84	29	259	50	FLV3084LDSTF		\$3,681	\$4,049
	30	78	29	251	47	FLT3078RDSTF	\$2,635		
	30	78	29	251	47	FLV3078RDSTF		\$3,598	\$3,958
	30	78	29	251	47	FLT3078LDSTF	\$2,635		
	30	78	29	251	47	FLV3078LDSTF		\$3,598	\$3,958
	30	72	29	243	43	FLT3072RDSTF	\$2,693		
	30	72	29	243	43	FLV3072RDSTF		\$3,514	\$3,866
	30	72	29	243	43	FLT3072LDSTF	\$2,693		
	30	72	29	243	43	FLV3072LDSTF		\$3,514	\$3,866
	30	66	29	235	40	FLT3066RDSTF	\$2,528		
	30	66	29	235	40	FLV3066RDSTF		\$3,448	\$3,794
	30	66	29	235	40	FLT3066LDSTF	\$2,528		
	30	66	29	235	40	FLV3066LDSTF		\$3,448	\$3,794
	30	60	29	227	36	FLT3060RDSTF	\$2,484		
	30	60	29	227	36	FLV3060RDSTF		\$3,383	\$3,722
	30	60	29	227	36	FLT3060LDSTF	\$2,484		
	30	60	29	227	36	FLV3060LDSTF		\$3,383	\$3,722

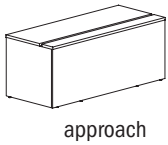
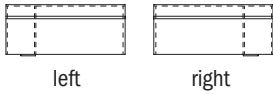
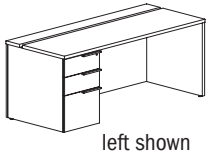

Features:

- eased edge profile on approach and user sides
- built in horizontal wire channel
- pedestal front locking
- FLT3084RDSTF or FLT3084LDSTF and FLV3084RDSTF or FLV3084LDSTF - chassis 30" x 84"
- FLT3078RDSTF or FLT3078LDSTF and FLV3078RDSTF or FLV3078LDSTF - chassis 30" x 78"
- FLT3072RDSTF or FLT3072LDSTF and FLV3072RDSTF or FLV3072LDSTF - chassis 30" x 72"
- FLT3066RDSTF or FLT3066LDSTF and FLV3066RDSTF or FLV3066LDSTF - chassis 30" x 66"
- FLT3060RDSTF or FLT3060LDSTF and FLV3060RDSTF or FLV3060LDSTF - chassis 30" x 60"

Options:

- must specify chassis grain direction on artisan veneer, see pages 13-15 for details
- veneer drawer fronts in paint available, specify paint color; add \$354 list; see page 16 for details
- on laminate units, contrasting worksurface tops and drawer fronts available, no upcharge; specify laminate color, see page 16 for details
- ledge pulls standard; prism pulls available, specify and see page 9

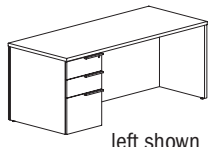
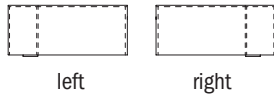
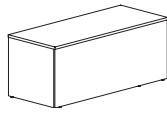
Description	D	W	H	CTN WT	CU FT	① Model	HPL Laminate	Essentials Veneer	Artisan Veneer
 <p>left shown</p>  <p>left right</p>  <p>approach</p>	30	84	29	259	50	FLT3084RDF	\$2,490		
	30	84	29	259	50	FLV3084RDF		\$3,475	\$3,822
	30	84	29	259	50	FLT3084LDF	\$2,490		
	30	84	29	259	50	FLV3084LDF		\$3,475	\$3,822
	30	78	29	251	47	FLT3078RDF	\$2,429		
	30	78	29	251	47	FLV3078RDF		\$3,391	\$3,731
	30	78	29	251	47	FLT3078LDF	\$2,429		
	30	78	29	251	47	FLV3078LDF		\$3,391	\$3,731
	30	72	29	243	43	FLT3072RDF	\$2,372		
	30	72	29	243	43	FLV3072RDF		\$3,308	\$3,638
	30	72	29	243	43	FLT3072LDF	\$2,372		
	30	72	29	243	43	FLV3072LDF		\$3,308	\$3,638
	30	66	29	235	40	FLT3066RDF	\$2,321		
	30	66	29	235	40	FLV3066RDF		\$3,242	\$3,565
	30	66	29	235	40	FLT3066LDF	\$2,321		
	30	66	29	235	40	FLV3066LDF		\$3,242	\$3,565
	30	60	29	227	36	FLT3060RDF	\$2,277		
	30	60	29	227	36	FLV3060RDF		\$3,176	\$3,495
	30	60	29	227	36	FLT3060LDF	\$2,277		
	30	60	29	227	36	FLV3060LDF		\$3,176	\$3,495

Features:



- eased edge profile on approach and user sides
- pedestal front locking
- FLT3084RDF or FLT3084LDF and FLV3084RDF or FLV3084LDF - chassis 30" x 84"
- FLT3078RDF or FLT3078LDF and FLV3078RDF or FLV3078LDF - chassis 30" x 78"
- FLT3072RDF or FLT3072LDF and FLV3072RDF or FLV3072LDF - chassis 30" x 72"
- FLT3066RDF or FLT3066LDF and FLV3066RDF or FLV3066LDF - chassis 30" x 66"
- FLT3060RDF or FLT3060LDF and FLV3060RDF or FLV3060LDF - chassis 30" x 60"

Options:

- must specify chassis grain direction on artisan veneer, see pages 13-15 for details
- veneer drawer fronts in paint available, specify paint color; add \$354 list; see page 16 for details
- on laminate units, contrasting worksurface tops and drawer fronts available, no upcharge; specify laminate color, see page 16 for details
- ledge pulls standard; prism pulls available, specify and see page 9
- top grommet available, specify location; add \$135 list each; see page 44 for details
- worksurface power available, specify "to accommodate EC26" on your purchase order; EC26 unit must be ordered separately, see page 44
- interior kneespace wire manager available, use with top grommet or power unit, specify and add \$120 list; see page 17 for details

To Order, Specify:

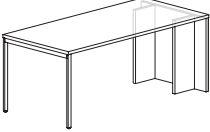
① Laminate Model #	② Laminate Type	③ Laminate Selection	④ Metal Color	⑤ Other Product Options		
Laminate (FLT)	HPL	See Laminate Selection	See Metal Finish Color Options	See list of options for each specific unit; Specify and add accordingly.		
① Veneer Model #	② Wood Collection	③ Wood Finish	④ Metal Color	⑤ Other Product Options		
Veneer (FLV)	Essentials	See Essentials Wood Finish Options	See Metal Finish Color Options	See list of options for each specific unit; Specify and add accordingly.		
	Artisan	<table border="1"> <tr> <th>ⓐ Wood Finish</th> <th>ⓑ Chassis Grain Direction</th> </tr> <tr> <td>See Artisan Wood Finish Options</td> <td>For Artisan Only: Vertical Horizontal</td> </tr> </table>	ⓐ Wood Finish		ⓑ Chassis Grain Direction	See Artisan Wood Finish Options
ⓐ Wood Finish	ⓑ Chassis Grain Direction					
See Artisan Wood Finish Options	For Artisan Only: Vertical Horizontal					

Description	D	W	H	CTN WT	CU FT	① Model	HPL Laminate	Essentials Veneer	Artisan Veneer
Rectangular Peninsula Table Desk with End Leg Assembly and Panel End  	33½	84	29	169	56	FLT3484PDNEP	\$2,303		
	33½	84	29	169	56	FLV3484PDNEP		\$3,038	\$3,342
	33½	78	29	161	52	FLT3478PDNEP	\$2,265		
	33½	78	29	161	52	FLV3478PDNEP		\$2,985	\$3,285
	33½	72	29	153	48	FLT3472PDNEP	\$2,226		
	33½	72	29	153	48	FLV3472PDNEP		\$2,935	\$3,228
	33½	66	29	145	44	FLT3466PDNEP	\$2,190		
	33½	66	29	145	44	FLV3466PDNEP		\$2,885	\$3,174

Features:

- intended to be used with bridges or return units, see pages 154-159
- eased edge profile on approach and user sides

Options:

- must specify support panels grain direction on artisan veneer, see pages 13-15 for details
- on laminate units, contrasting worksurface tops and chassis available, no upcharge; specify color see page 16 for details
- 13 ½”h modesty panel available, specify; add \$449 list for laminate or \$624 list for veneer; see page 21 for details
- top grommet available, specify location; add \$135 list each; see page 44 for details
- 12” wide top grommet available, specify location; add \$177 list each; see page 44 for details
- worksurface power available, specify “to accommodate EC26” on your purchase order; EC26 unit must be ordered separately, see page 44
- wire manager tray available see accessory section on pages 50-51 for details

Description	D	W	H	CTN WT	CU FT	① Model	HPL Laminate	Essentials Veneer	Artisan Veneer
Rectangular Peninsula Table	27 1/2	84	29	145	46	FLT2884PDNEP	\$2,222		
Desk with End Leg Assembly and Panel End	27 1/2	84	29	145	46	FLV2884PDNEP		\$2,931	\$3,223
	27 1/2	78	29	139	43	FLT2878PDNEP	\$2,186		
	27 1/2	78	29	139	43	FLV2878PDNEP		\$2,882	\$3,169
	27 1/2	72	29	133	40	FLT2872PDNEP	\$2,150		
	27 1/2	72	29	133	40	FLV2872PDNEP		\$2,830	\$3,115
	27 1/2	66	29	127	37	FLT2866PDNEP	\$2,124		
	27 1/2	66	29	127	37	FLV2866PDNEP		\$2,796	\$3,077

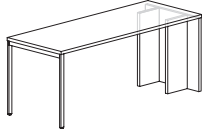

Features:



- intended to be used with bridges or return units, see pages 154-159
- eased edge profile on approach and user sides

Options:

- must specify support panels grain direction on artisan veneer, see pages 13-15 for details
- on laminate units, contrasting worksurface tops and chassis available, no upcharge; specify color see page 16 for details
- 13 1/2" h modesty panel available, specify; add \$449 list for laminate or \$624 list for veneer; see page 21 for details
- top grommet available, specify location; add \$135 list each; see page 44 for details
- 12" wide top grommet available, specify location; add \$177 list each; see page 44 for details
- worksurface power available, specify "to accommodate EC26" on your purchase order; EC26 unit must be ordered separately, see page 44
- wire manager tray available see accessory section on pages 50-51 for details

To Order, Specify:

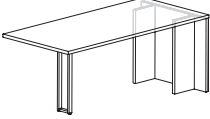
① Laminate Model #	② Laminate Type	③ Laminate Selection	④ Metal Color	⑤ Other Product Options		
Laminate (FLT)	HPL	See Laminate Selection	See Metal Finish Color Options	See list of options for each specific unit; Specify and add accordingly.		
① Veneer Model #	② Wood Collection	③ Wood Finish	④ Metal Color	⑤ Other Product Options		
Veneer (FLV)	Essentials	See Essentials Wood Finish Options	See Metal Finish Color Options	See list of options for each specific unit; Specify and add accordingly.		
	Artisan	<table border="1"> <thead> <tr> <th>ⓐ Wood Finish</th> <th>ⓑ Chassis Grain Direction</th> </tr> </thead> <tbody> <tr> <td>See Artisan Wood Finish Options</td> <td>For Artisan Only: Vertical Horizontal</td> </tr> </tbody> </table>	ⓐ Wood Finish		ⓑ Chassis Grain Direction	See Artisan Wood Finish Options
ⓐ Wood Finish	ⓑ Chassis Grain Direction					
See Artisan Wood Finish Options	For Artisan Only: Vertical Horizontal					

Description	D	W	H	CTN WT	CU FT	① Model	HPL Laminate	Essentials Veneer	Artisan Veneer
Rectangular Peninsula Table Desk with Frame Base and Panel End  	33½	84	29	169	56	FLT3484PDPEP	\$2,303		
	33½	84	29	169	56	FLV3484PDPEP		\$3,038	\$3,342
	33½	78	29	161	52	FLT3478PDPEP	\$2,265		
	33½	78	29	161	52	FLV3478PDPEP		\$2,985	\$3,285
	33½	72	29	153	48	FLT3472PDPEP	\$2,226		
	33½	72	29	153	48	FLV3472PDPEP		\$2,935	\$3,228
	33½	66	29	145	44	FLT3466PDPEP	\$2,190		
	33½	66	29	145	44	FLV3466PDPEP		\$2,885	\$3,174

Features:

- must be used with run-off credenza or return units, see pages 154-159
- eased edge profile on approach and user sides

Options:

- must specify support panels grain direction on artisan veneer, see pages 13-15 for details
- on laminate units, contrasting worksurface tops and chassis available, no upcharge; specify color see page 16 for details
- 13 ½”h modesty panel available, specify; add \$449 list for laminate or \$624 list for veneer; see page 21 for details
- top grommet available, specify location; add \$135 list each; see page 44 for details
- 12” wide top grommet available, specify location; add \$177 list each; see page 44 for details
- worksurface power available, specify “to accommodate EC26” on your purchase order; EC26 unit must be ordered separately, see page 44
- wire manager tray available see accessory section on pages 50-51 for details

Description	D	W	H	CTN WT	CU FT	① Model	HPL Laminate	Essentials Veneer	Artisan Veneer
Rectangular Peninsula Table	27 1/2	84	29	145	46	FLT2884PDPEP	\$2,222		
Desk with Frame Base and Panel End	27 1/2	84	29	145	46	FLV2884PDPEP		\$2,931	\$3,223
	27 1/2	78	29	139	43	FLT2878PDPEP	\$2,186		
	27 1/2	78	29	139	43	FLV2878PDPEP		\$2,882	\$3,169
	27 1/2	72	29	133	40	FLT2872PDPEP	\$2,150		
	27 1/2	72	29	133	40	FLV2872PDPEP		\$2,830	\$3,115
	27 1/2	66	29	127	37	FLT2866PDPEP	\$2,124		
	27 1/2	66	29	127	37	FLV2866PDPEP		\$2,796	\$3,077

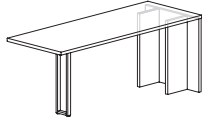

Features:

- must be used with run-off credenza or return units, see pages 154-159
- eased edge profile on approach and user sides

Options:

- must specify support panels grain direction on artisan veneer, see pages 13-15 for details
- on laminate units, contrasting worksurface tops and chassis available, no upcharge; specify color see page 16 for details
- 13 1/2" h modesty panel available, specify; add \$449 list for laminate or \$624 list for veneer; see page 21 for details
- top grommet available, specify location; add \$135 list each; see page 44 for details
- 12" wide top grommet available, specify location; add \$177 list each; see page 44 for details
- worksurface power available, specify "to accommodate EC26" on your purchase order; EC26 unit must be ordered separately, see page 44
- wire manager tray available see accessory section on pages 50-51 for details

FLUX

To Order, Specify:

① Laminate Model #	② Laminate Type	③ Laminate Selection	④ Metal Color	⑤ Other Product Options		
Laminate (FLT)	HPL	See Laminate Selection	See Metal Finish Color Options	See list of options for each specific unit; Specify and add accordingly.		
① Veneer Model #	② Wood Collection	③ Wood Finish	④ Metal Color	⑤ Other Product Options		
Veneer (FLV)	Essentials	See Essentials Wood Finish Options	See Metal Finish Color Options	See list of options for each specific unit; Specify and add accordingly.		
	Artisan	<table border="1"> <tr> <th>ⓐ Wood Finish</th> <th>ⓑ Chassis Grain Direction</th> </tr> <tr> <td>See Artisan Wood Finish Options</td> <td>For Artisan Only: Vertical Horizontal</td> </tr> </table>	ⓐ Wood Finish		ⓑ Chassis Grain Direction	See Artisan Wood Finish Options
ⓐ Wood Finish	ⓑ Chassis Grain Direction					
See Artisan Wood Finish Options	For Artisan Only: Vertical Horizontal					

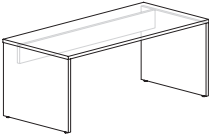
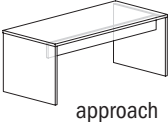
Description	D	W	H	CTN WT	CU FT	① Model	HPL Laminate	Essentials Veneer	Artisan Veneer
 	33½	84	29	181	56	FLT3484PDEPPR	\$1,520		
	33½	84	29	181	56	FLV3484PDEPPR		\$2,300	\$2,530
	33½	84	29	181	56	FLT3484PDEPPL	\$1,520		
	33½	84	29	181	56	FLV3484PDEPPL		\$2,300	\$2,530
	33½	78	29	172	52	FLT3478PDEPPR	\$1,483		
	33½	78	29	172	52	FLV3478PDEPPR		\$2,243	\$2,469
	33½	78	29	172	52	FLT3478PDEPPL	\$1,483		
	33½	78	29	172	52	FLV3478PDEPPL		\$2,243	\$2,469
	33½	72	29	163	48	FLT3472PDEPPR	\$1,447		
	33½	72	29	163	48	FLV3472PDEPPR		\$2,190	\$2,409
	33½	72	29	163	48	FLT3472PDEPPL	\$1,447		
	33½	72	29	163	48	FLV3472PDEPPL		\$2,190	\$2,409
	33½	66	29	154	44	FLT3466PDEPPR	\$1,427		
	33½	66	29	154	44	FLV3466PDEPPR		\$2,158	\$2,373
	33½	66	29	154	44	FLT3466PDEPPL	\$1,427		
	33½	66	29	154	44	FLV3466PDEPPL		\$2,158	\$2,373



*desks are handed when grommets are applied; see page 44

Features:

- eased edge profile on approach and user sides
- 6¾" h modesty with horizontal wire channel

Options:

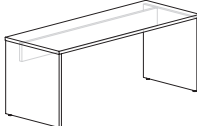
- must specify support panels grain direction on artisan veneer, see pages 13-15 for details
- on laminate units, contrasting worksurface tops and chassis available, no upcharge; specify color see page 16 for details
- top grommet available, specify location; add \$135 list each; see page 44 for details
- 12" wide top grommet available, specify location; add \$177 list each; see page 44 for details
- worksurface power available, specify "to accommodate EC26" on your purchase order; EC26 unit must be ordered separately, see page 44
- wire manager tray available see accessory section on pages 50-51 for details

Description	D	W	H	CTN WT	CU FT	① Model	HPL Laminate	Essentials Veneer	Artisan Veneer
  approach	27 1/2	84	29	154	46	FLT2884PDEPPR	\$1,437		
	27 1/2	84	29	154	46	FLV2884PDEPPR		\$2,175	\$2,392
	27 1/2	84	29	154	46	FLT2884PDEPPL	\$1,437		
	27 1/2	84	29	154	46	FLV2884PDEPPL		\$2,175	\$2,392
	27 1/2	78	29	148	43	FLT2878PDEPPR	\$1,403		
	27 1/2	78	29	148	43	FLV2878PDEPPR		\$2,121	\$2,334
	27 1/2	78	29	148	43	FLT2878PDEPPL	\$1,403		
	27 1/2	78	29	148	43	FLV2878PDEPPL		\$2,121	\$2,334
	27 1/2	72	29	142	40	FLT2872PDEPPR	\$1,367		
	27 1/2	72	29	142	40	FLV2872PDEPPR		\$2,071	\$2,278
	27 1/2	72	29	142	40	FLT2872PDEPPL	\$1,367		
	27 1/2	72	29	142	40	FLV2872PDEPPL		\$2,071	\$2,278
	27 1/2	66	29	136	37	FLT2866PDEPPR	\$1,348		
	27 1/2	66	29	136	37	FLV2866PDEPPR		\$2,039	\$2,242
	27 1/2	66	29	136	37	FLT2866PDEPPL	\$1,348		
27 1/2	66	29	136	37	FLV2866PDEPPL		\$2,039	\$2,242	

*desks are handed when grommets are applied; see page 44

Features:

- eased edge profile on approach and user sides
- 6 3/4" h modesty with horizontal wire channel

Options:

- must specify support panels grain direction on artisan veneer, see pages 13-15 for details
- on laminate units, contrasting worksurface tops and chassis available, no upcharge; specify color see page 16 for details
- top grommet available, specify location; add \$135 list each; see page 44 for details
- 12" wide top grommet available, specify location; add \$177 list each; see page 44 for details
- worksurface power available, specify "to accommodate EC26" on your purchase order; EC26 unit must be ordered separately, see page 44
- wire manager tray available see accessory section on pages 50-51 for details

To Order, Specify:

① Laminate Model #	② Laminate Type	③ Laminate Selection	④ Metal Color	⑤ Other Product Options		
Laminate (FLT)	HPL	See Laminate Selection	See Metal Finish Color Options	See list of options for each specific unit; Specify and add accordingly.		
① Veneer Model #	② Wood Collection	③ Wood Finish	④ Metal Color	⑤ Other Product Options		
Veneer (FLV)	Essentials	See Essentials Wood Finish Options	See Metal Finish Color Options	See list of options for each specific unit; Specify and add accordingly.		
	Artisan	<table border="1"> <thead> <tr> <th>ⓐ Wood Finish</th> <th>ⓑ Chassis Grain Direction</th> </tr> </thead> <tbody> <tr> <td>See Artisan Wood Finish Options</td> <td>For Artisan Only: Vertical Horizontal</td> </tr> </tbody> </table>	ⓐ Wood Finish		ⓑ Chassis Grain Direction	See Artisan Wood Finish Options
ⓐ Wood Finish	ⓑ Chassis Grain Direction					
See Artisan Wood Finish Options	For Artisan Only: Vertical Horizontal					

Description	D	W	H	CTN WT	CU FT	① Model	HPL Laminate	Essentials Veneer	Artisan Veneer
Rectangular Peninsula Table	33½	84	29	207	56	FLT3484PDTEPR	\$2,041		
Desk with 6" w Full Support Panel and Panel End	33½	84	29	207	56	FLV3484PDTEPR		\$3,091	\$3,401
	33½	84	29	207	56	FLT3484PDTEPL	\$2,041		
	33½	84	29	207	56	FLV3484PDTEPL		\$3,091	\$3,401
	33½	78	29	198	52	FLT3478PDTEPR	\$1,991		
	33½	78	29	198	52	FLV3478PDTEPR		\$3,016	\$3,317
	33½	78	29	198	52	FLT3478PDTEPL	\$1,991		
	33½	78	29	198	52	FLV3478PDTEPL		\$3,016	\$3,317
	33½	72	29	189	48	FLT3472PDTEPR	\$1,944		
	33½	72	29	189	48	FLV3472PDTEPR		\$2,943	\$3,238
	33½	72	29	189	48	FLT3472PDTEPL	\$1,944		
	33½	72	29	189	48	FLV3472PDTEPL		\$2,943	\$3,238
	33½	66	29	180	44	FLT3466PDTEPR	\$1,915		
	33½	66	29	180	44	FLV3466PDTEPR		\$2,898	\$3,190
	33½	66	29	180	44	FLT3466PDTEPL	\$1,915		
	33½	66	29	180	44	FLV3466PDTEPL		\$2,898	\$3,190

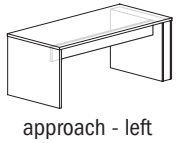
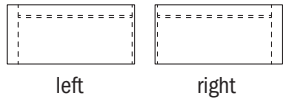
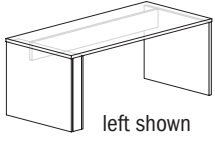

Features:

- eased edge profile on approach and user sides
- 6¾" h modesty with horizontal wire channel

Options:

- must specify support panels grain direction on artisan veneer, see pages 13-15 for details
- on laminate units, contrasting worksurface tops and chassis available, no upcharge; specify color see page 16 for details
- top grommet available, specify location; add \$135 list each; see page 44 for details
- 12" wide top grommet available, specify location; add \$177 list each; see page 44 for details
- worksurface power available, specify "to accommodate EC26" on your purchase order; EC26 unit must be ordered separately, see page 44
- wire manager tray available see accessory section on pages 50-51 for details

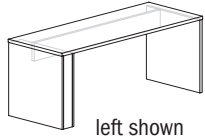
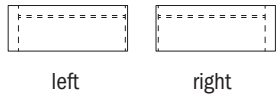
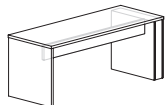
Description	D	W	H	CTN WT	CU FT	① Model	HPL Laminate	Essentials Veneer	Artisan Veneer
 left shown  left right  approach - left	27 1/2	84	29	177	46	FLT2884PDTEPR	\$1,943		
	27 1/2	84	29	177	46	FLV2884PDTEPR		\$2,940	\$3,236
	27 1/2	84	29	177	46	FLT2884PDTEPL	\$1,943		
	27 1/2	84	29	177	46	FLV2884PDTEPL		\$2,940	\$3,236
	27 1/2	78	29	171	43	FLT2878PDTEPR	\$1,897		
	27 1/2	78	29	171	43	FLV2878PDTEPR		\$2,868	\$3,157
	27 1/2	78	29	171	43	FLT2878PDTEPL	\$1,897		
	27 1/2	78	29	171	43	FLV2878PDTEPL		\$2,868	\$3,157
	27 1/2	72	29	165	40	FLT2872PDTEPR	\$1,848		
	27 1/2	72	29	165	40	FLV2872PDTEPR		\$2,801	\$3,081
	27 1/2	72	29	165	40	FLT2872PDTEPL	\$1,848		
	27 1/2	72	29	165	40	FLV2872PDTEPL		\$2,801	\$3,081
	27 1/2	66	29	159	37	FLT2866PDTEPR	\$1,822		
	27 1/2	66	29	159	37	FLV2866PDTEPR		\$2,758	\$3,035
	27 1/2	66	29	159	37	FLT2866PDTEPL	\$1,822		
27 1/2	66	29	159	37	FLV2866PDTEPL		\$2,758	\$3,035	

Features:

- eased edge profile on approach and user sides
- 6 3/4" h modesty with horizontal wire channel

Options:

- must specify support panels grain direction on artisan veneer, see pages 13-15 for details
- on laminate units, contrasting worksurface tops and chassis available, no upcharge; specify color see page 16 for details
- top grommet available, specify location; add \$135 list each; see page 44 for details
- 12" wide top grommet available, specify location; add \$177 list each; see page 44 for details
- worksurface power available, specify "to accommodate EC26" on your purchase order; EC26 unit must be ordered separately, see page 44
- wire manager tray available see accessory section on pages 50-51 for details

To Order, Specify:

① Laminate Model #	② Laminate Type	③ Laminate Selection	④ Metal Color	⑤ Other Product Options		
Laminate (FLT)	HPL	See Laminate Selection	See Metal Finish Color Options	See list of options for each specific unit; Specify and add accordingly.		
① Veneer Model #	② Wood Collection	③ Wood Finish	④ Metal Color	⑤ Other Product Options		
Veneer (FLV)	Essentials	See Essentials Wood Finish Options	See Metal Finish Color Options	See list of options for each specific unit; Specify and add accordingly.		
	Artisan	<table border="1"> <tr> <th>ⓐ Wood Finish</th> <th>ⓑ Chassis Grain Direction</th> </tr> <tr> <td>See Artisan Wood Finish Options</td> <td>For Artisan Only: Vertical Horizontal</td> </tr> </table>	ⓐ Wood Finish		ⓑ Chassis Grain Direction	See Artisan Wood Finish Options
ⓐ Wood Finish	ⓑ Chassis Grain Direction					
See Artisan Wood Finish Options	For Artisan Only: Vertical Horizontal					

Description	D	W	H	CTN WT	CU FT	① Model	HPL Laminate	Essentials Veneer	Artisan Veneer
Arc Peninsula Table Desk with Frame Base and Panel End	33½	84	29	169	56	FLT3484PARCPEP	\$2,490		
	33½	84	29	169	56	FLV3484PARCPEP		\$3,290	\$3,620
	33½	78	29	161	52	FLT3478PARCPEP	\$2,438		
	33½	78	29	161	52	FLV3478PARCPEP		\$3,219	\$3,541
	33½	72	29	153	48	FLT3472PARCPEP	\$2,387		
	33½	72	29	153	48	FLV3472PARCPEP		\$3,153	\$3,468
	33½	66	29	145	44	FLT3466PARCPEP	\$2,366		
	33½	66	29	145	44	FLV3466PARCPEP		\$3,123	\$3,435

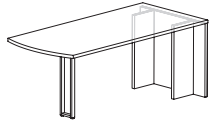



Features:

- must be used with run-off credenza or return units, see pages 122-127
- eased edge profile on approach and user sides

Options:

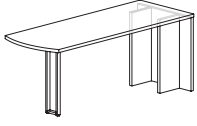
- must specify support panels grain direction on artisan veneer, see pages 13-15 for details
- on laminate units, contrasting worksurface tops and chassis available, no upcharge; specify color see page 16 for details
- 13 ½”h modesty panel available, specify; add \$449 list for laminate or \$624 list for veneer; see page 21 for details
- top grommet available, specify location; add \$135 list each; see page 44 for details
- 12” wide top grommet available, specify location; add \$177 list each; see page 44 for details
- worksurface power available, specify “to accommodate EC26” on your purchase order; EC26 unit must be ordered separately, see page 44
- wire manager tray available see accessory section on pages 50-51 for details

Description	D	W	H	CTN WT	CU FT	① Model	HPL Laminate	Essentials Veneer	Artisan Veneer
Arc Peninsula Table Desk with Frame Base and Panel End  	27 1/2	84	29	145	46	FLT2884PARCPEP	\$2,410		
	27 1/2	84	29	145	46	FLV2884PARCPEP		\$3,180	\$3,500
	27 1/2	78	29	139	43	FLT2878PARCPEP	\$2,359		
	27 1/2	78	29	139	43	FLV2878PARCPEP		\$3,115	\$3,428
	27 1/2	72	29	133	40	FLT2872PARCPEP	\$2,309		
	27 1/2	72	29	133	40	FLV2872PARCPEP		\$3,047	\$3,353
	27 1/2	66	29	127	37	FLT2866PARCPEP	\$2,291		
	27 1/2	66	29	127	37	FLV2866PARCPEP		\$3,020	\$3,323

Features:

- must be used with run-off credenza or return units, see pages 122-127
- eased edge profile on approach and user sides

Options:

- must specify support panels grain direction on artisan veneer, see pages 13-15 for details
- on laminate units, contrasting worksurface tops and chassis available, no upcharge; specify color see page 16 for details
- 13 1/2" h modesty panel available, specify; add \$449 list for laminate or \$624 list for veneer; see page 21 for details
- top grommet available, specify location; add \$135 list each; see page 44 for details
- 12" wide top grommet available, specify location; add \$177 list each; see page 44 for details
- worksurface power available, specify "to accommodate EC26" on your purchase order; EC26 unit must be ordered separately, see page 44
- wire manager tray available see accessory section on pages 50-51 for details

FLUX

To Order, Specify:

① Laminate Model #	② Laminate Type	③ Laminate Selection	④ Metal Color	⑤ Other Product Options		
Laminate (FLT)	HPL	See Laminate Selection	See Metal Finish Color Options	See list of options for each specific unit; Specify and add accordingly.		
① Veneer Model #	② Wood Collection	③ Wood Finish	④ Metal Color	⑤ Other Product Options		
Veneer (FLV)	Essentials	See Essentials Wood Finish Options	See Metal Finish Color Options	See list of options for each specific unit; Specify and add accordingly.		
	Artisan	<table border="1"> <tr> <th>ⓐ Wood Finish</th> <th>ⓑ Chassis Grain Direction</th> </tr> <tr> <td>See Artisan Wood Finish Options</td> <td>For Artisan Only: Vertical Horizontal</td> </tr> </table>	ⓐ Wood Finish		ⓑ Chassis Grain Direction	See Artisan Wood Finish Options
ⓐ Wood Finish	ⓑ Chassis Grain Direction					
See Artisan Wood Finish Options	For Artisan Only: Vertical Horizontal					

Description	D	W	H	CTN WT	CU FT	① Model	HPL Laminate	Essentials Veneer	Artisan Veneer
Boomerang Peninsula Table Desk with End Leg Assembly and Panel End	33½	84	29	169	56	FLT3484PBMNEPR	\$3,161		
	33½	84	29	169	56	FLV3484PBMNEPR		\$4,198	\$4,618
	33½	84	29	169	56	FLT3484PBMNEPL	\$3,161		
	33½	84	29	169	56	FLV3484PBMNEPL		\$4,198	\$4,618
	33½	78	29	161	52	FLT3478PBMNEPR	\$3,092		
	33½	78	29	161	52	FLV3478PBMNEPR		\$4,106	\$4,514
	33½	78	29	161	52	FLT3478PBMNEPL	\$3,092		
	33½	78	29	161	52	FLV3478PBMNEPL		\$4,106	\$4,514
	33½	72	29	153	48	FLT3472PBMNEPR	\$3,024		
	33½	72	29	153	48	FLV3472PBMNEPR		\$4,016	\$4,417
	33½	72	29	153	48	FLT3472PBMNEPL	\$3,024		
	33½	72	29	153	48	FLV3472PBMNEPL		\$4,016	\$4,417
	33½	66	29	145	44	FLT3466PBMNEPR	\$2,985		
	33½	66	29	145	44	FLV3466PBMNEPR		\$3,960	\$4,358
	33½	66	29	145	44	FLT3466PBMNEPL	\$2,985		
	33½	66	29	145	44	FLV3466PBMNEPL		\$3,960	\$4,358

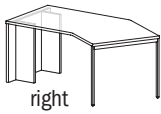
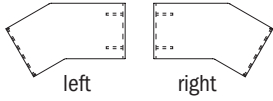
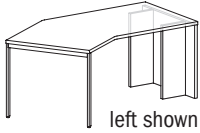

Features:

- must be used with run-off credenza or return units, see pages 122-127
- eased edge profile on approach and user sides

Options:

- must specify support panels grain direction on artisan veneer, see pages 13-15 for details
- on laminate units, contrasting worksurface tops and chassis available, no upcharge; specify color see page 16 for details
- 13 ½" h modesty panel available for 84" w and 78" w desk, specify; add \$449 list for laminate or \$624 list for veneer; see page 21 for details
- top grommet available, specify location; add \$135 list each; see page 44 for details
- 12" wide top grommet available, specify location; add \$177 list each; see page 44 for details
- worksurface power available, specify "to accommodate EC26" on your purchase order; EC26 unit must be ordered separately, see page 44
- wire manager tray available see accessory section on pages 50-51 for details

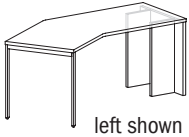
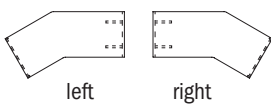
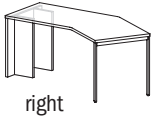
Description	D	W	H	CTN WT	CU FT	① Model	HPL Laminate	Essentials Veneer	Artisan Veneer
Boomerang Peninsula Table Desk with End Leg Assembly and Panel End  left shown  left right  right	27 1/2	84	29	145	46	FLT2884PBMNEPR	\$3,100		
	27 1/2	84	29	145	46	FLV2884PBMNEPR		\$4,115	\$4,529
	27 1/2	84	29	145	46	FLT2884PBMNEPL	\$3,100		
	27 1/2	84	29	145	46	FLV2884PBMNEPL		\$4,115	\$4,529
	27 1/2	78	29	139	43	FLT2878PBMNEPR	\$3,035		
	27 1/2	78	29	139	43	FLV2878PBMNEPR		\$4,025	\$4,428
	27 1/2	78	29	133	43	FLT2878PBMNEPL	\$3,035		
	27 1/2	78	29	133	43	FLV2878PBMNEPL		\$4,025	\$4,428
	27 1/2	72	29	133	40	FLT2872PBMNEPR	\$2,968		
	27 1/2	72	29	133	40	FLV2872PBMNEPR		\$3,937	\$4,330
	27 1/2	72	29	133	40	FLT2872PBMNEPL	\$2,968		
	27 1/2	72	29	133	40	FLV2872PBMNEPL		\$3,937	\$4,330
	27 1/2	66	29	127	37	FLT2866PBMNEPR	\$2,914		
	27 1/2	66	29	127	37	FLV2866PBMNEPR		\$3,883	\$4,272
	27 1/2	66	29	127	37	FLT2866PBMNEPL	\$2,914		
	27 1/2	66	29	127	37	FLV2866PBMNEPL		\$3,883	\$4,272

Features:

- must be used with run-off credenza or return units, see pages 122-127
- eased edge profile on approach and user sides

Options:

- must specify support panels grain direction on artisan veneer, see pages 13-15 for details
- on laminate units, contrasting worksurface tops and chassis available, no upcharge; specify color see page 16 for details
- 13 1/2" h modesty panel available for 84" w and 78" w desk, specify; add \$449 list for laminate or \$624 list for veneer; see page 21 for details
- top grommet available, specify location; add \$135 list each; see page 44 for details
- 12" wide top grommet available, specify location; add \$177 list each; see page 44 for details
- worksurface power available, specify "to accommodate EC26" on your purchase order; EC26 unit must be ordered separately, see page 44
- wire manager tray available see accessory section on pages 50-51 for details

To Order, Specify:

① Laminate Model #	② Laminate Type	③ Laminate Selection	④ Metal Color	⑤ Other Product Options
Laminate (FLT)	HPL	See Laminate Selection	See Metal Finish Color Options	See list of options for each specific unit; Specify and add accordingly.
① Veneer Model #	② Wood Collection	③ Wood Finish	④ Metal Color	⑤ Other Product Options
Veneer (FLV)	Essentials	See Essentials Wood Finish Options	See Metal Finish Color Options	See list of options for each specific unit; Specify and add accordingly.
	Artisan	ⓐ Wood Finish See Artisan Wood Finish Options	ⓑ Chassis Grain Direction For Artisan Only: Vertical Horizontal	

Description	D	W	H	CTN WT	CU FT	① Model	HPL Laminate	Essentials Veneer	Artisan Veneer
Rectangular Peninsula Table Desk with End Leg Assembly and Secondary Support End	33½	84	29	149	31	FLT3484PDN	\$2,170		
	33½	84	29	149	31	FLV3484PDN		\$2,856	\$3,143
	33½	78	29	140	28	FLT3478PDN	\$2,132		
	33½	78	29	140	28	FLV3478PDN		\$2,807	\$3,086
	33½	72	29	131	26	FLT3472PDN	\$2,093		
	33½	72	29	131	26	FLV3472PDN		\$2,754	\$3,029
	33½	66	29	122	24	FLT3466PDN	\$2,056		
	33½	66	29	122	24	FLV3466PDN		\$2,703	\$2,975

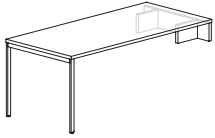

eased



reverse bevel

edges

Features:

- peninsula desk mounting included in the list price of the unit, but must be specified when ordering secondary credenza; see pages 18-20 for details
- eased edge profile on approach and user sides

Options:

- must specify support panels grain direction on artisan veneer, see pages 13-15 for details
- on laminate units, contrasting worksurface tops and chassis available, no upcharge; specify color see page 16 for details
- reverse bevel edge available on three sides, specify; add \$451 list for laminate or \$177 list for veneer; see page 8 for details
- 13 ½" h modesty panel available, specify; add \$449 list for laminate or \$624 list for veneer; see page 21 for details
- top grommet available, specify location; add \$135 list each; see page 47 for details
- 12" wide top grommet available, specify location; add \$177 list each; see page 44 for details
- worksurface power available, specify "to accommodate EC26" on your purchase order; EC26 unit must be ordered separately, see page 44
- wire manager tray available see accessory section on pages 50-51 for details

Description	D	W	H	CTN WT	CU FT	① Model	HPL Laminate	Essentials Veneer	Artisan Veneer
Rectangular Peninsula Table	27 1/2	84	29	128	25	FLT2884PDN	\$2,091		
Desk with End Leg Assembly and Secondary Support End	27 1/2	84	29	128	25	FLV2884PDN		\$2,748	\$3,024
	27 1/2	78	29	122	24	FLT2878PDN	\$2,053		
	27 1/2	78	29	122	24	FLV2878PDN		\$2,700	\$2,970
	27 1/2	72	29	116	22	FLT2872PDN	\$2,016		
	27 1/2	72	29	116	22	FLV2872PDN		\$2,651	\$2,917
	27 1/2	66	29	110	20	FLT2866PDN	\$1,990		
	27 1/2	66	29	110	20	FLV2866PDN		\$2,616	\$2,877

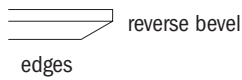
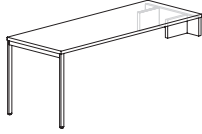

Features:

- peninsula desk mounting included in the list price of the unit, but must be specified when ordering secondary credenza; see pages 18-20 for details
- eased edge profile on approach and user sides

Options:

- must specify support panels grain direction on artisan veneer, see pages 13-15 for details
- on laminate units, contrasting worksurface tops and chassis available, no upcharge; specify color see page 16 for details
- reverse bevel edge available on three sides, specify; add \$451 list for laminate or \$177 list for veneer; see page 8 for details
- 13 1/2" h modesty panel available, specify; add \$449 list for laminate or \$624 list for veneer; see page 21 for details
- top grommet available, specify location; add \$135 list each; see page 47 for details
- 12" wide top grommet available, specify location; add \$177 list each; see page 44 for details
- worksurface power available, specify "to accommodate EC26" on your purchase order; EC26 unit must be ordered separately, see page 44
- wire manager tray available see accessory section on pages 50-51 for details

To Order, Specify:

① Laminate Model #	② Laminate Type	③ Laminate Selection		④ Metal Color	⑤ Other Product Options
Laminate (FLT)	HPL	See Laminate Selection		See Metal Finish Color Options	See list of options for each specific unit; Specify and add accordingly.
① Veneer Model #	② Wood Collection	③ Wood Finish		④ Metal Color	⑤ Other Product Options
Veneer (FLV)	Essentials	See Essentials Wood Finish Options		See Metal Finish Color Options	See list of options for each specific unit; Specify and add accordingly.
	Artisan	ⓐ Wood Finish See Artisan Wood Finish Options	ⓑ Chassis Grain Direction For Artisan Only: Vertical Horizontal		

Description	D	W	H	CTN WT	CU FT	① Model	HPL Laminate	Essentials Veneer	Artisan Veneer
Rectangular Peninsula Table Desk with Frame Base and Secondary Support End	33½	84	29	149	31	FLT3484PDP	\$2,170		
	33½	84	29	149	31	FLV3484PDP		\$2,856	\$3,143
	33½	78	29	140	28	FLT3478PDP	\$2,132		
	33½	78	29	140	28	FLV3478PDP		\$2,807	\$3,086
	33½	72	29	131	26	FLT3472PDP	\$2,093		
	33½	72	29	131	26	FLV3472PDP		\$2,754	\$3,029
	33½	66	29	122	24	FLT3466PDP	\$2,056		
	33½	66	29	122	24	FLV3466PDP		\$2,703	\$2,975

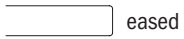
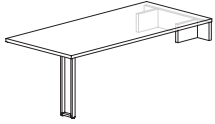

eased



reverse bevel

edges

Features:

- peninsula desk mounting included in the list price of the unit, but must be specified when ordering secondary credenza; see pages 18-20 for details
- eased edge profile on approach and user sides

Options:

- must specify support panels grain direction on artisan veneer, see pages 13-15 for details
- on laminate units, contrasting worksurface tops and chassis available, no upcharge; specify color see page 16 for details
- reverse bevel edge available on three sides, specify; add \$451 list for laminate or \$177 list for veneer; see page 8 for details
- 13 ½" h modesty panel available, specify; add \$449 list for laminate or \$624 list for veneer; see page 21 for details
- top grommet available, specify location; add \$135 list each; see page 47 for details
- 12" wide top grommet available, specify location; add \$177 list each; see page 44 for details
- worksurface power available, specify "to accommodate EC26" on your purchase order; EC26 unit must be ordered separately, see page 44
- wire manager tray available see accessory section on pages 50-51 for details

Description	D	W	H	CTN WT	CU FT	① Model	HPL Laminate	Essentials Veneer	Artisan Veneer
Rectangular Peninsula Table Desk with Frame Base and Secondary Support End 	27 1/2	84	29	128	25	FLT2884PDP	\$2,091		
	27 1/2	84	29	128	25	FLV2884PDP		\$2,748	\$3,024
	27 1/2	78	29	122	24	FLT2878PDP	\$2,053		
	27 1/2	78	29	122	24	FLV2878PDP		\$2,700	\$2,970
	27 1/2	72	29	116	22	FLT2872PDP	\$2,016		
	27 1/2	72	29	116	22	FLV2872PDP		\$2,651	\$2,917
	27 1/2	66	29	110	20	FLT2866PDP	\$1,990		
	27 1/2	66	29	110	20	FLV2866PDP		\$2,616	\$2,877

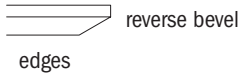

Features:

- peninsula desk mounting included in the list price of the unit, but must be specified when ordering secondary credenza; see pages 18-20 for details
- eased edge profile on approach and user sides

Options:

- must specify support panels grain direction on artisan veneer, see pages 13-15 for details
- on laminate units, contrasting worksurface tops and chassis available, no upcharge; specify color see page 16 for details
- reverse bevel edge available on three sides, specify; add \$451 list for laminate or \$177 list for veneer; see page 8 for details
- 13 1/2" h modesty panel available, specify; add \$449 list for laminate or \$624 list for veneer; see page 21 for details
- top grommet available, specify location; add \$135 list each; see page 47 for details
- 12" wide top grommet available, specify location; add \$177 list each; see page 44 for details
- worksurface power available, specify "to accommodate EC26" on your purchase order; EC26 unit must be ordered separately, see page 44
- wire manager tray available see accessory section on pages 50-51 for details

FLUX

To Order, Specify:

① Laminate Model #	② Laminate Type	③ Laminate Selection		④ Metal Color	⑤ Other Product Options
Laminate (FLT)	HPL	See Laminate Selection		See Metal Finish Color Options	See list of options for each specific unit; Specify and add accordingly.
① Veneer Model #	② Wood Collection	③ Wood Finish		④ Metal Color	⑤ Other Product Options
Veneer (FLV)	Essentials	See Essentials Wood Finish Options		See Metal Finish Color Options	See list of options for each specific unit; Specify and add accordingly.
	Artisan	ⓐ Wood Finish See Artisan Wood Finish Options	ⓑ Chassis Grain Direction For Artisan Only: Vertical Horizontal		

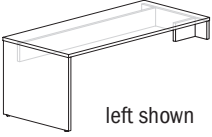
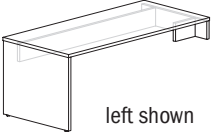
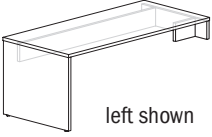
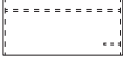
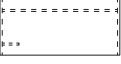
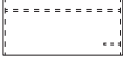
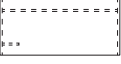
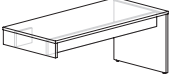
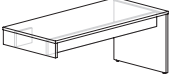
Description	D	W	H	CTN WT	CU FT	① Model	HPL Laminate	Essentials Veneer	Artisan Veneer
Rectangular Peninsula Table	33½	84	29	163	56	FLT3484PDEPR	\$1,518		
Desk with Full Support Panel and Secondary Support End	33½	84	29	163	56	FLV3484PDEPR		\$2,297	\$2,526
	33½	84	29	163	56	FLT3484PDEPL	\$1,518		
	33½	84	29	163	56	FLV3484PDEPL		\$2,297	\$2,526
	33½	78	29	154	52	FLT3478PDEPR	\$1,481		
	33½	78	29	154	52	FLV3478PDEPR		\$2,239	\$2,465
	33½	78	29	154	52	FLT3478PDEPL	\$1,481		
	33½	78	29	154	52	FLV3478PDEPL		\$2,239	\$2,465
	33½	72	29	146	48	FLT3472PDEPR	\$1,443		
 	33½	72	29	146	48	FLV3472PDEPR		\$2,183	\$2,404
	33½	72	29	146	48	FLT3472PDEPL	\$1,443		
 	33½	72	29	146	48	FLV3472PDEPL		\$2,183	\$2,404
	33½	66	29	158	44	FLT3466PDEPR	\$1,415		
	33½	66	29	158	44	FLV3466PDEPR		\$2,142	\$2,356
	33½	66	29	158	44	FLT3466PDEPL	\$1,415		
	33½	66	29	158	44	FLV3466PDEPL		\$2,142	\$2,356

Features:

- peninsula desk mounting included in the list price of the unit, but must be specified when ordering secondary credenza; see pages 18-20 for details
- eased edge profile on approach and user sides
- 6¾" h modesty with horizontal wire channel

Options:

- must specify support panels grain direction on artisan veneer, see pages 13-15 for details
- on laminate units, contrasting worksurface tops and drawer fronts available, no upcharge; specify laminate color, see page 16 for details
- top grommet available, specify location; add \$135 list each; see page 44 for details
- 12" wide top grommet available, specify location; add \$177 list each; see page 44 for details
- worksurface power available, specify "to accommodate EC26" on your purchase order; EC26 unit must be ordered separately, see page 44
- wire manager tray available see accessory section on pages 50-51 for details

FLUX

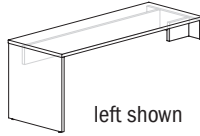
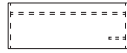
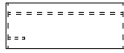
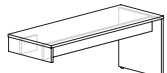
Description	D	W	H	CTN WT	CU FT	① Model	HPL Laminate	Essentials Veneer	Artisan Veneer
Rectangular Peninsula Table	27 1/2	84	29	144	46	FLT2884PDEPR	\$1,255		
Desk with Full Support Panel and Secondary Support End	27 1/2	84	29	144	46	FLV2884PDEPR		\$1,900	\$2,091
	27 1/2	84	29	144	46	FLT2884PDEPL	\$1,255		
 left shown  left  right  approach - left	27 1/2	84	29	144	46	FLV2884PDEPL		\$1,900	\$2,091
	27 1/2	78	29	137	43	FLT2878PDEPR	\$1,225		
	27 1/2	78	29	137	43	FLV2878PDEPR		\$1,854	\$2,039
	27 1/2	78	29	137	43	FLT2878PDEPL	\$1,225		
	27 1/2	78	29	137	43	FLV2878PDEPL		\$1,854	\$2,039
	27 1/2	72	29	130	40	FLT2872PDEPR	\$1,195		
	27 1/2	72	29	130	40	FLV2872PDEPR		\$1,809	\$1,990
	27 1/2	72	29	130	40	FLT2872PDEPL	\$1,195		
	27 1/2	72	29	130	40	FLV2872PDEPL		\$1,809	\$1,990
	27 1/2	66	29	123	37	FLT2866PDEPR	\$1,172		
	27 1/2	66	29	123	37	FLV2866PDEPR		\$1,773	\$1,949
	27 1/2	66	29	123	37	FLT2866PDEPL	\$1,172		
	27 1/2	66	29	123	37	FLV2866PDEPL		\$1,773	\$1,949

Features:

- peninsula desk mounting included in the list price of the unit, but must be specified when ordering secondary credenza; see pages 18-20 for details
- eased edge profile on approach and user sides
- 6 3/4" h modesty with horizontal wire channel

Options:

- must specify support panels grain direction on artisan veneer, see pages 13-15 for details
- on laminate units, contrasting worksurface tops and drawer fronts available, no upcharge; specify laminate color, see page 16 for details
- top grommet available, specify location; add \$135 list each; see page 44 for details
- 12" wide top grommet available, specify location; add \$177 list each; see page 44 for details
- worksurface power available, specify "to accommodate EC26" on your purchase order; EC26 unit must be ordered separately, see page 44
- wire manager tray available see accessory section on pages 50-51 for details

To Order, Specify:

① Laminate Model #	② Laminate Type	③ Laminate Selection	④ Metal Color	⑤ Other Product Options
Laminate (FLT)	HPL	See Laminate Selection	See Metal Finish Color Options	See list of options for each specific unit; Specify and add accordingly.
① Veneer Model #	② Wood Collection	③ Wood Finish	④ Metal Color	⑤ Other Product Options
Veneer (FLV)	Essentials	See Essentials Wood Finish Options	See Metal Finish Color Options	See list of options for each specific unit; Specify and add accordingly.
	Artisan	ⓐ Wood Finish See Artisan Wood Finish Options	ⓑ Chassis Grain Direction For Artisan Only: Vertical Horizontal	

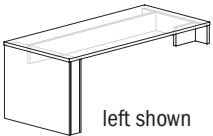
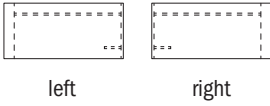
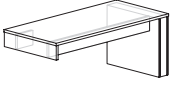
Description	D	W	H	CTN WT	CU FT	① Model	HPL Laminate	Essentials Veneer	Artisan Veneer
 left shown  left right  approach - left	33½	84	29	189	56	FLT3484DTEPR	\$2,039		
	33½	84	29	189	56	FLV3484DTEPR		\$3,086	\$3,395
	33½	84	29	189	56	FLT3484DTEPL	\$2,039		
	33½	84	29	189	56	FLV3484DTEPL		\$3,086	\$3,395
	33½	78	29	181	52	FLT3478DTEPR	\$1,988		
	33½	78	29	181	52	FLV3478DTEPR		\$3,012	\$3,312
	33½	78	29	181	52	FLT3478DTEPL	\$1,988		
	33½	78	29	181	52	FLV3478DTEPL		\$3,012	\$3,312
	33½	72	29	173	48	FLT3472DTEPR	\$1,942		
	33½	72	29	173	48	FLV3472DTEPR		\$2,938	\$3,232
	33½	72	29	173	48	FLT3472DTEPL	\$1,942		
	33½	72	29	173	48	FLV3472DTEPL		\$2,938	\$3,232
	33½	66	29	165	44	FLT3466DTEPR	\$1,901		
	33½	66	29	165	44	FLV3466DTEPR		\$2,881	\$3,167
	33½	66	29	165	44	FLT3466DTEPL	\$1,901		
	33½	66	29	165	44	FLV3466DTEPL		\$2,881	\$3,167

Features:

- peninsula desk mounting included in the list price of the unit, but must be specified when ordering secondary credenza; see pages 18-20 for details
- eased edge profile on approach and user sides
- 6¾" h modesty with horizontal wire channel

Options:

- must specify support panels grain direction on artisan veneer, see pages 13-15 for details
- on laminate units, contrasting worksurface tops and drawer fronts available, no upcharge; specify laminate color, see page 16 for details
- top grommet available, specify location; add \$135 list each; see page 44 for details
- 12" wide top grommet available, specify location; add \$177 list each; see page 44 for details
- worksurface power available, specify "to accommodate EC26" on your purchase order; EC26 unit must be ordered separately, see page 44
- wire manager tray available see accessory section on pages 50-51 for details

FLUX

Description	D	W	H	CTN WT	CU FT	① Model	HPL Laminate	Essentials Veneer	Artisan Veneer
Rectangular Peninsula Table Desk with 6" Full Support Panel and Secondary Support End	27 1/2	84	29	162	46	FLT2884DTEPR	\$1,759		
	27 1/2	84	29	162	46	FLV2884DTEPR		\$2,666	\$2,933
	27 1/2	84	29	162	46	FLT2884DTEPL	\$1,759		
	27 1/2	84	29	162	46	FLV2884DTEPL		\$2,666	\$2,933
	27 1/2	78	29	155	43	FLT2878DTEPR	\$1,716		
	27 1/2	78	29	155	43	FLV2878DTEPR		\$2,602	\$2,861
	27 1/2	78	29	155	43	FLT2878DTEPL	\$1,716		
	27 1/2	78	29	155	43	FLV2878DTEPL		\$2,602	\$2,861
	27 1/2	72	29	148	40	FLT2872DTEPR	\$1,677		
	27 1/2	72	29	148	40	FLV2872DTEPR		\$2,538	\$2,790
	27 1/2	72	29	148	40	FLT2872DTEPL	\$1,677		
	27 1/2	72	29	148	40	FLV2872DTEPL		\$2,538	\$2,790
	27 1/2	66	29	141	37	FLT2866DTEPR	\$1,643		
	27 1/2	66	29	141	37	FLV2866DTEPR		\$2,487	\$2,737
	27 1/2	66	29	141	37	FLT2866DTEPL	\$1,643		
	27 1/2	66	29	141	37	FLV2866DTEPL		\$2,487	\$2,737

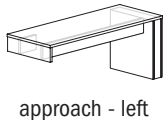
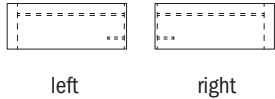
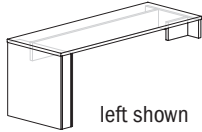

Features:

- peninsula desk mounting included in the list price of the unit, but must be specified when ordering secondary credenza; see pages 18-20 for details
- eased edge profile on approach and user sides
- 6 3/4" h modesty with horizontal wire channel

Options:

- must specify support panels grain direction on artisan veneer, see pages 13-15 for details
- on laminate units, contrasting worksurface tops and drawer fronts available, no upcharge; specify laminate color, see page 16 for details
- top grommet available, specify location; add \$135 list each; see page 44 for details
- 12" wide top grommet available, specify location; add \$177 list each; see page 44 for details
- worksurface power available, specify "to accommodate EC26" on your purchase order; EC26 unit must be ordered separately, see page 44
- wire manager tray available see accessory section on pages 50-51 for details

To Order, Specify:

① Laminate Model #	② Laminate Type	③ Laminate Selection	④ Metal Color	⑤ Other Product Options		
Laminate (FLT)	HPL	See Laminate Selection	See Metal Finish Color Options	See list of options for each specific unit; Specify and add accordingly.		
① Veneer Model #	② Wood Collection	③ Wood Finish	④ Metal Color	⑤ Other Product Options		
Veneer (FLV)	Essentials	See Essentials Wood Finish Options	See Metal Finish Color Options	See list of options for each specific unit; Specify and add accordingly.		
	Artisan	<table border="1"> <thead> <tr> <th>ⓐ Wood Finish</th> <th>ⓑ Chassis Grain Direction</th> </tr> </thead> <tbody> <tr> <td>See Artisan Wood Finish Options</td> <td>For Artisan Only: Vertical Horizontal</td> </tr> </tbody> </table>	ⓐ Wood Finish		ⓑ Chassis Grain Direction	See Artisan Wood Finish Options
ⓐ Wood Finish	ⓑ Chassis Grain Direction					
See Artisan Wood Finish Options	For Artisan Only: Vertical Horizontal					

Description	D	W	H	CTN WT	CU FT	① Model	HPL Laminate	Essentials Veneer	Artisan Veneer
Arc Peninsula Table Desk with Frame Base and Secondary Support End	33½	84	29	149	31	FLT3484PARCP	\$2,356		
	33½	84	29	149	31	FLV3484PARCP		\$3,112	\$3,421
	33½	78	29	140	28	FLT3478PARCP	\$2,305		
	33½	78	29	140	28	FLV3478PARCP		\$3,039	\$3,343
	33½	72	29	131	26	FLT3472PARCP	\$2,254		
	33½	72	29	131	26	FLV3472PARCP		\$2,970	\$3,268
	33½	66	29	122	24	FLT3466PARCP	\$2,233		
	33½	66	29	122	24	FLV3466PARCP		\$2,943	\$3,238

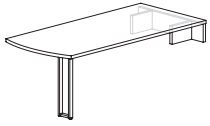

eased



reverse bevel

edges

Features:

- peninsula desk mounting included in the list price of the unit, but must be specified when ordering secondary credenza; see pages 18-20 for details
- eased edge profile on approach and user sides

Options:

- must specify support panels grain direction on artisan veneer, see pages 13-15 for details
- on laminate units, contrasting worksurface tops and chassis available, no upcharge; specify color see page 16 for details
- reverse bevel edge available on three sides, specify; add \$451 list for laminate or \$177 list for veneer; see page 8 for details
- 13 ½" h modesty panel available, specify; add \$449 list for laminate or \$624 list for veneer; see page 21 for details
- top grommet available, specify location; add \$135 list each; see page 47 for details
- 12" wide top grommet available, specify location; add \$177 list each; see page 44 for details
- worksurface power available, specify "to accommodate EC26" on your purchase order; EC26 unit must be ordered separately, see page 44
- wire manager tray available see accessory section on pages 50-51 for details

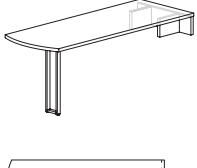
Description	D	W	H	CTN WT	CU FT	① Model	HPL Laminate	Essentials Veneer	Artisan Veneer
	27 1/2	84	29	128	25	FLT2884PARCP	\$2,277		
	27 1/2	84	29	128	25	FLV2884PARCP		\$3,002	\$3,301
	27 1/2	78	29	122	24	FLT2878PARCP	\$2,226		
	27 1/2	78	29	122	24	FLV2878PARCP		\$2,935	\$3,228
	27 1/2	72	29	116	22	FLT2872PARCP	\$2,176		
	27 1/2	72	29	116	22	FLV2872PARCP		\$2,867	\$3,156
	27 1/2	66	29	110	20	FLT2866PARCP	\$2,158		
	27 1/2	66	29	110	20	FLV2866PARCP		\$2,841	\$3,125

Features:

- peninsula desk mounting included in the list price of the unit, but must be specified when ordering secondary credenza; see pages 18-20 for details
- eased edge profile on approach and user sides

Options:

- must specify support panels grain direction on artisan veneer, see pages 13-15 for details
- on laminate units, contrasting worksurface tops and chassis available, no upcharge; specify color see page 16 for details
- reverse bevel edge available on three sides, specify; add \$451 list for laminate or \$177 list for veneer; see page 8 for details
- 13 1/2" h modesty panel available, specify; add \$449 list for laminate or \$624 list for veneer; see page 21 for details
- top grommet available, specify location; add \$135 list each; see page 47 for details
- 12" wide top grommet available, specify location; add \$177 list each; see page 44 for details
- worksurface power available, specify "to accommodate EC26" on your purchase order; EC26 unit must be ordered separately, see page 44
- wire manager tray available see accessory section on pages 50-51 for details

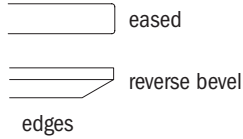

To Order, Specify:

① Laminate Model #	② Laminate Type	③ Laminate Selection		④ Metal Color	⑤ Other Product Options
Laminate (FLT)	HPL	See Laminate Selection		See Metal Finish Color Options	See list of options for each specific unit; Specify and add accordingly.
① Veneer Model #	② Wood Collection	③ Wood Finish		④ Metal Color	⑤ Other Product Options
Veneer (FLV)	Essentials	See Essentials Wood Finish Options		See Metal Finish Color Options	See list of options for each specific unit; Specify and add accordingly.
	Artisan	See Artisan Wood Finish Options	ⓐ Chassis Grain Direction For Artisan Only: Vertical Horizontal		

Description	D	W	H	CTN WT	CU FT	① Model	HPL Laminate	Essentials Veneer	Artisan Veneer
Boomerang Peninsula Table Desk with End Leg Assembly and Secondary Support End	33½	84	29	149	31	FLT3484PBMNR	\$2,822		
	33½	84	29	149	31	FLV3484PBMNR		\$3,811	\$4,192
	33½	84	29	149	31	FLT3484PBMNL	\$2,822		
	33½	84	29	149	31	FLV3484PBMNL		\$3,811	\$4,192
	33½	78	29	140	28	FLT3478PBMNR	\$2,753		
	33½	78	29	140	28	FLV3478PBMNR		\$3,719	\$4,089
	33½	78	29	140	28	FLT3478PBMNL	\$2,753		
	33½	78	29	140	28	FLV3478PBMNL		\$3,719	\$4,089
	33½	72	29	131	26	FLT3472PBMNR	\$2,687		
	33½	72	29	131	26	FLV3472PBMNR		\$3,628	\$3,992
	33½	72	29	131	26	FLT3472PBMNL	\$2,687		
	33½	72	29	131	26	FLV3472PBMNL		\$3,628	\$3,992
	33½	66	29	122	24	FLT3466PBMNR	\$2,645		
	33½	66	29	122	24	FLV3466PBMNR		\$3,573	\$3,932
	33½	66	29	122	24	FLT3466PBMNL	\$2,645		
	33½	66	29	122	24	FLV3466PBMNL		\$3,573	\$3,932

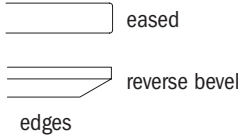
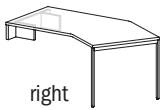
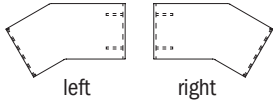
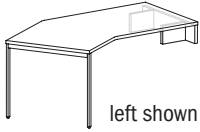

Features:

- peninsula desk mounting included in the list price of the unit, but must be specified when ordering secondary credenza; see pages 18-20 for details
- eased edge profile on approach and user sides

Options:

- must specify support panels grain direction on artisan veneer, see pages 13-15 for details
- on laminate units, contrasting worksurface tops and chassis available, no upcharge; specify color see page 16 for details
- reverse bevel edge available on three sides, specify; add \$451 list for laminate or \$177 list for veneer; see page 8 for details
- 13½" h modesty panel available for 84" w and 78" w desk, specify; add \$449 list for laminate or \$624 list for veneer; see page 21 for details
- top grommet available, specify location; add \$135 list each; see page 44 for details
- 12" wide top grommet available, specify location; add \$177 list each; see page 44 for details
- worksurface power available, specify "to accommodate EC26" on your purchase order; EC26 unit must be ordered separately, see page 44
- wire manager tray available see accessory section on pages 50-51 for details

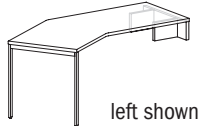
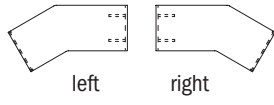
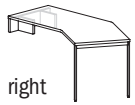
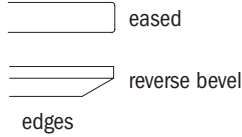
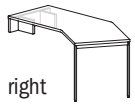
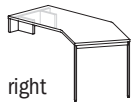
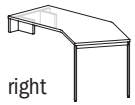
Description	D	W	H	CTN WT	CU FT	① Model	HPL Laminate	Essentials Veneer	Artisan Veneer
Boomerang Peninsula Table	27 1/2	84	29	128	25	FLT2884PBMNR	\$2,762		
Desk with End Leg Assembly and Secondary Support End	27 1/2	84	29	128	25	FLV2884PBMNR		\$3,730	\$4,102
	27 1/2	84	29	128	25	FLT2884PBMNL	\$2,762		
 left shown	27 1/2	84	29	128	25	FLV2884PBMNL		\$3,730	\$4,102
	27 1/2	78	29	122	24	FLT2878PBMNR	\$2,694		
 left right	27 1/2	78	29	122	24	FLV2878PBMNR		\$3,638	\$4,003
	27 1/2	78	29	122	24	FLT2878PBMNL	\$2,694		
 right	27 1/2	78	29	122	24	FLV2878PBMNL		\$3,638	\$4,003
	27 1/2	72	29	116	22	FLT2872PBMNR	\$2,627		
 eased reverse bevel edges	27 1/2	72	29	116	22	FLV2872PBMNR		\$3,549	\$3,904
	27 1/2	72	29	116	22	FLT2872PBMNL	\$2,627		
 right	27 1/2	72	29	116	22	FLV2872PBMNL		\$3,549	\$3,904
	27 1/2	66	29	110	20	FLT2866PBMNR	\$1,916		
 right	27 1/2	66	29	110	20	FLV2866PBMNR		\$2,589	\$2,849
	27 1/2	66	29	110	20	FLT2866PBMNL	\$1,916		
 right	27 1/2	66	29	110	20	FLV2866PBMNL		\$2,589	\$2,849

Features:

- peninsula desk mounting included in the list price of the unit, but must be specified when ordering secondary credenza; see pages 18-20 for details
- eased edge profile on approach and user sides

Options:

- must specify support panels grain direction on artisan veneer, see pages 13-15 for details
- on laminate units, contrasting worksurface tops and chassis available, no upcharge; specify color see page 16 for details
- reverse bevel edge available on three sides, specify; add \$451 list for laminate or \$177 list for veneer; see page 8 for details
- 13 1/2" h modesty panel available for 84" w and 78" w desk, specify; add \$449 list for laminate or \$624 list for veneer; see page 21 for details
- top grommet available, specify location; add \$135 list each; see page 44 for details
- 12" wide top grommet available, specify location; add \$177 list each; see page 44 for details
- worksurface power available, specify "to accommodate EC26" on your purchase order; EC26 unit must be ordered separately, see page 44
- wire manager tray available see accessory section on pages 50-51 for details

To Order, Specify:

① Laminate Model #	② Laminate Type	③ Laminate Selection	④ Metal Color	⑤ Other Product Options		
Laminate (FLT)	HPL	See Laminate Selection	See Metal Finish Color Options	See list of options for each specific unit; Specify and add accordingly.		
① Veneer Model #	② Wood Collection	③ Wood Finish	④ Metal Color	⑤ Other Product Options		
Veneer (FLV)	Essentials	See Essentials Wood Finish Options	See Metal Finish Color Options	See list of options for each specific unit; Specify and add accordingly.		
	Artisan	<table border="1"> <tr> <th>ⓐ Wood Finish</th> <th>ⓑ Chassis Grain Direction</th> </tr> <tr> <td>See Artisan Wood Finish Options</td> <td>For Artisan Only: Vertical Horizontal</td> </tr> </table>	ⓐ Wood Finish		ⓑ Chassis Grain Direction	See Artisan Wood Finish Options
ⓐ Wood Finish	ⓑ Chassis Grain Direction					
See Artisan Wood Finish Options	For Artisan Only: Vertical Horizontal					

Description	D	W	H	CTN WT	CU FT	① Model	HPL Laminate	Essentials Veneer	Artisan Veneer
Rectangular Run-off Desk with End Leg Assembly	33½	72	29	119	22	FLT3472RRTN	\$1,721		
	33½	72	29	119	22	FLV3472RRTN		\$2,253	\$2,478
	33½	66	29	112	20	FLT3466RRTN	\$1,685		
	33½	66	29	112	20	FLV3466RRTN		\$2,203	\$2,423
	33½	60	29	105	18	FLT3460RRTN	\$1,648		
	33½	60	29	105	18	FLV3460RRTN		\$2,155	\$2,371
	33½	54	29	98	17	FLT3454RRTN	\$1,614		
	33½	54	29	98	17	FLV3454RRTN		\$2,105	\$2,316
	33½	48	29	91	16	FLT3448RRTN	\$1,592		
	33½	48	29	91	16	FLV3448RRTN		\$2,079	\$2,287

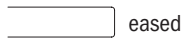

eased



reverse bevel



edges

Features:

- mounts perpendicular to primary height units
- eased edge profile on approach and user sides
- laminate tops wider than 60" are long grain

Options:

- reverse bevel edge available on three sides, specify; add \$451 list for laminate or \$177 list for veneer; see page 8 for details
- 13 ½" h modesty panel available, specify; add \$449 list for laminate or \$624 list for veneer; see page 21 for details
- top grommet available, specify location; add \$135 list each; see page 45 for details
- 12" wide top grommet available, specify location; add \$177 list each; see page 45 for details
- worksurface power available, specify "to accommodate EC26" on your purchase order; EC26 unit must be ordered separately, see page 45
- wire manager tray available see accessory section on pages 50-51 for details

Description	D	W	H	CTN WT	CU FT	① Model	HPL Laminate	Essentials Veneer	Artisan Veneer
 	27 1/2	72	29	101	18	FLT2872RRTN	\$1,699		
	27 1/2	72	29	101	18	FLV2872RRTN		\$2,220	\$2,443
	27 1/2	66	29	94	17	FLT2866RRTN	\$1,662		
	27 1/2	66	29	94	17	FLV2866RRTN		\$2,171	\$2,388
	27 1/2	60	29	87	15	FLT2860RRTN	\$1,626		
	27 1/2	60	29	87	15	FLV2860RRTN		\$2,123	\$2,335
	27 1/2	54	29	80	14	FLT2854RRTN	\$1,591		
	27 1/2	54	29	80	14	FLV2854RRTN		\$2,077	\$2,284
	27 1/2	48	29	80	13	FLT2848RRTN	\$1,570		
	27 1/2	48	29	80	13	FLV2848RRTN		\$2,049	\$2,254

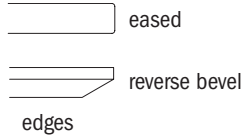

Features:

- mounts perpendicular to primary height units
- eased edge profile on approach and user sides
- laminate tops wider than 60" are long grain

Options:

- reverse bevel edge available on three sides, specify; add \$451 list for laminate or \$177 list for veneer; see page 8 for details
- 13 1/2" h modesty panel available, specify; add \$449 list for laminate or \$624 list for veneer; see page 21 for details
- top grommet available, specify location; add \$135 list each; see page 45 for details
- 12" wide top grommet available, specify location; add \$177 list each; see page 45 for details
- worksurface power available, specify "to accommodate EC26" on your purchase order; EC26 unit must be ordered separately, see page 45
- wire manager tray available see accessory section on pages 50-51 for details

To Order, Specify:

① Laminate Model #	② Laminate Type	③ Laminate Selection	④ Metal Color	⑤ Other Product Options	
Laminate (FLT)	HPL	See Laminate Selection	See Metal Finish Color Options	See list of options for each specific unit; Specify and add accordingly.	
① Veneer Model #	② Wood Collection	③ Wood Finish	④ Metal Color	⑤ Other Product Options	
Veneer (FLV)	Essentials	See Essentials Wood Finish Options	See Metal Finish Color Options	See list of options for each specific unit; Specify and add accordingly.	
	Artisan	<table border="1"> <tr> <th>ⓐ Wood Finish</th> <th>ⓑ Chassis Grain Direction</th> </tr> <tr> <td>See Artisan Wood Finish Options</td> <td>For Artisan Only: Vertical Horizontal</td> </tr> </table>			ⓐ Wood Finish
ⓐ Wood Finish	ⓑ Chassis Grain Direction				
See Artisan Wood Finish Options	For Artisan Only: Vertical Horizontal				

Description	D	W	H	CTN WT	CU FT	① Model	HPL Laminate	Essentials Veneer	Artisan Veneer
Rectangular Run-off Desk with Frame Base	33½	72	29	119	22	FLT3472RRTP	\$1,721		
	33½	72	29	119	22	FLV3472RRTP		\$2,253	\$2,478
	33½	66	29	112	20	FLT3466RRTP	\$1,685		
	33½	66	29	112	20	FLV3466RRTP		\$2,203	\$2,423
	33½	60	29	105	18	FLT3460RRTP	\$1,648		
	33½	60	29	105	18	FLV3460RRTP		\$2,155	\$2,371
	33½	54	29	98	17	FLT3454RRTP	\$1,614		
	33½	54	29	98	17	FLV3454RRTP		\$2,105	\$2,316
	33½	48	29	91	16	FLT3448RRTP	\$1,592		
	33½	48	29	91	16	FLV3448RRTP		\$2,079	\$2,287

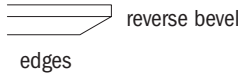
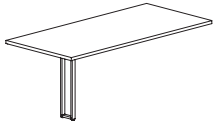



Features:

- mounts perpendicular to primary height units
- eased edge profile on approach and user sides
- laminate tops wider than 60" are long grain

Options:

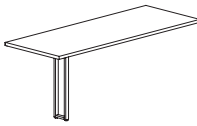
- reverse bevel edge available on three sides, specify; add \$451 list for laminate or \$177 list for veneer; see page 8 for details
- 13 ½" h modesty panel available, specify; add \$449 list for laminate or \$624 list for veneer; see page 21 for details
- top grommet available, specify location; add \$135 list each; see page 45 for details
- 12" wide top grommet available, specify location; add \$177 list each; see page 45 for details
- worksurface power available, specify "to accommodate EC26" on your purchase order; EC26 unit must be ordered separately, see page 45
- wire manager tray available see accessory section on pages 50-51 for details

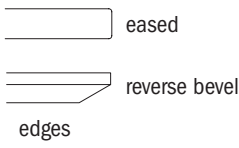
Description	D	W	H	CTN WT	CU FT	① Model	HPL Laminate	Essentials Veneer	Artisan Veneer
  	27 1/2	72	29	101	18	FLT2872RRTP	\$1,699		
	27 1/2	72	29	101	18	FLV2872RRTP		\$2,220	\$2,443
	27 1/2	66	29	94	17	FLT2866RRTP	\$1,662		
	27 1/2	66	29	94	17	FLV2866RRTP		\$2,171	\$2,388
	27 1/2	60	29	87	15	FLT2860RRTP	\$1,626		
	27 1/2	60	29	87	15	FLV2860RRTP		\$2,123	\$2,335
	27 1/2	54	29	80	14	FLT2854RRTP	\$1,591		
	27 1/2	54	29	80	14	FLV2854RRTP		\$2,077	\$2,284
	27 1/2	48	29	80	13	FLT2848RRTP	\$1,570		
	27 1/2	48	29	80	13	FLV2848RRTP		\$2,049	\$2,254

Features:

- mounts perpendicular to primary height units
- eased edge profile on approach and user sides
- laminate tops wider than 60" are long grain

Options:

- reverse bevel edge available on three sides, specify; add \$451 list for laminate or \$177 list for veneer; see page 8 for details
- 13 1/2" h modesty panel available, specify; add \$449 list for laminate or \$624 list for veneer; see page 21 for details
- top grommet available, specify location; add \$135 list each; see page 45 for details
- 12" wide top grommet available, specify location; add \$177 list each; see page 45 for details
- worksurface power available, specify "to accommodate EC26" on your purchase order; EC26 unit must be ordered separately, see page 45
- wire manager tray available see accessory section on pages 50-51 for details

To Order, Specify:

① Laminate Model #	② Laminate Type	③ Laminate Selection		④ Metal Color	⑤ Other Product Options
Laminate (FLT)	HPL	See Laminate Selection		See Metal Finish Color Options	See list of options for each specific unit; Specify and add accordingly.
① Veneer Model #	② Wood Collection	③ Wood Finish		④ Metal Color	⑤ Other Product Options
Veneer (FLV)	Essentials	See Essentials Wood Finish Options		See Metal Finish Color Options	See list of options for each specific unit; Specify and add accordingly.
	Artisan	ⓐ Wood Finish See Artisan Wood Finish Options	ⓑ Chassis Grain Direction For Artisan Only: Vertical Horizontal		

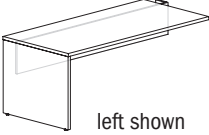
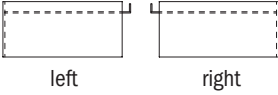
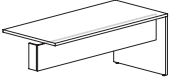
Description	D	W	H	CTN WT	CU FT	① Model	HPL Laminate	Essentials Veneer	Artisan Veneer
Rectangular Run-off Desk with End Panel Support  left shown  left right  approach - left	33½	72	29	141	48	FLT3472RDEPR	\$1,433		
	33½	72	29	141	48	FLV3472RDEPR		\$2,168	\$2,384
	33½	72	29	141	48	FLT3472RDEPL	\$1,433		
	33½	72	29	141	48	FLV3472RDEPL		\$2,168	\$2,384
	33½	66	29	130	44	FLT3466RDEPR	\$1,404		
	33½	66	29	130	44	FLV3466RDEPR		\$2,124	\$2,338
	33½	66	29	130	44	FLT3466RDEPL	\$1,404		
	33½	66	29	130	44	FLV3466RDEPL		\$2,124	\$2,338
	33½	60	29	119	40	FLT3460RDEPR	\$1,374		
	33½	60	29	119	40	FLV3460RDEPR		\$2,082	\$2,289
	33½	60	29	119	40	FLT3460RDEPL	\$1,374		
	33½	60	29	119	40	FLV3460RDEPL		\$2,082	\$2,289
	33½	54	29	108	36	FLT3454RDEPR	\$1,350		
	33½	54	29	108	36	FLV3454RDEPR		\$2,040	\$2,243
	33½	54	29	108	36	FLT3454RDEPL	\$1,350		
33½	54	29	108	36	FLV3454RDEPL		\$2,040	\$2,243	

Features:

- to be used with open corner primary height credenzas; see page 19
- mounts perpendicular to primary height units
- eased edge profile on approach and user sides
- laminate tops wider than 60" are long grain
- 6¾" h modesty with horizontal wire channel

Options:

- must specify support panels grain direction on artisan veneer, see pages 13-15 for details
- on laminate units, contrasting worksurface tops and chassis available, no upcharge; specify color, see page 16 for details
- top grommet available, specify location; add \$135 list each; see page 45 for details
- 12" wide top grommet available, specify location; add \$177 list each; see page 45 for details
- worksurface power available, specify "to accommodate EC26" on your purchase order; EC26 unit must be ordered separately, see page 45
- wire manager tray available see accessory section on pages 50-51 for details

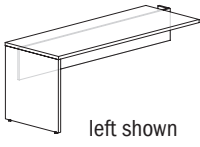
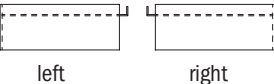
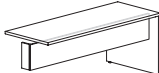
Description	D	W	H	CTN WT	CU FT	① Model	HPL Laminate	Essentials Veneer	Artisan Veneer
 left shown  left right  approach - left	27 1/2	72	29	120	40	FLT2872RDEPR	\$1,182		
	27 1/2	72	29	120	40	FLV2872RDEPR		\$1,791	\$1,970
	27 1/2	72	29	120	40	FLT2872RDEPL	\$1,182		
	27 1/2	72	29	120	40	FLV2872RDEPL		\$1,791	\$1,970
	27 1/2	66	29	111	37	FLT2866RDEPR	\$1,160		
	27 1/2	66	29	111	37	FLV2866RDEPR		\$1,755	\$1,932
	27 1/2	66	29	111	37	FLT2866RDEPL	\$1,160		
	27 1/2	66	29	111	37	FLV2866RDEPL		\$1,755	\$1,932
	27 1/2	60	29	102	34	FLT2860RDEPR	\$1,137		
	27 1/2	60	29	102	34	FLV2860RDEPR		\$1,718	\$1,893
	27 1/2	60	29	102	34	FLT2860RDEPL	\$1,137		
	27 1/2	60	29	102	34	FLV2860RDEPL		\$1,718	\$1,893
	27 1/2	60	29	102	34	FLT2860RDEPL		\$1,718	\$1,893
	27 1/2	54	29	93	30	FLT2854RDEPR	\$1,115		
	27 1/2	54	29	93	30	FLV2854RDEPR		\$1,685	\$1,855
	27 1/2	54	29	93	30	FLT2854RDEPL	\$1,115		
	27 1/2	54	29	93	30	FLV2854RDEPL		\$1,685	\$1,855

Features:

- to be used with open corner primary height credenzas; see page 19
- mounts perpendicular to primary height units
- eased edge profile on approach and user sides
- laminate tops wider than 60" are long grain
- 6 3/4" h modesty with horizontal wire channel

Options:

- must specify support panels grain direction on artisan veneer, see pages 13-15 for details
- on laminate units, contrasting worksurface tops and chassis available, no upcharge; specify color, see page 16 for details
- top grommet available, specify location; add \$135 list each; see page 45 for details
- 12" wide top grommet available, specify location; add \$177 list each; see page 45 for details
- worksurface power available, specify "to accommodate EC26" on your purchase order; EC26 unit must be ordered separately, see page 45
- wire manager tray available see accessory section on pages 50-51 for details

To Order, Specify:

① Laminate Model #	② Laminate Type	③ Laminate Selection	④ Metal Color	⑤ Other Product Options		
Laminate (FLT)	HPL	See Laminate Selection	See Metal Finish Color Options	See list of options for each specific unit; Specify and add accordingly.		
① Veneer Model #	② Wood Collection	③ Wood Finish	④ Metal Color	⑤ Other Product Options		
Veneer (FLV)	Essentials	See Essentials Wood Finish Options	See Metal Finish Color Options	See list of options for each specific unit; Specify and add accordingly.		
	Artisan	<table border="1"> <tr> <th>ⓐ Wood Finish</th> <th>ⓑ Chassis Grain Direction</th> </tr> <tr> <td>See Artisan Wood Finish Options</td> <td>For Artisan Only: Vertical Horizontal</td> </tr> </table>	ⓐ Wood Finish		ⓑ Chassis Grain Direction	See Artisan Wood Finish Options
ⓐ Wood Finish	ⓑ Chassis Grain Direction					
See Artisan Wood Finish Options	For Artisan Only: Vertical Horizontal					

Description	D	W	H	CTN WT	CU FT	① Model	HPL Laminate	Essentials Veneer	Artisan Veneer
Arc End Run-off Desk with Frame Base	33½	72	29	119	22	FLT3472ARCTP	\$1,889		
	33½	72	29	119	22	FLV3472ARCTP		\$2,481	\$2,728
	33½	66	29	112	20	FLT3466ARCTP	\$1,848		
	33½	66	29	112	20	FLV3466ARCTP		\$2,426	\$2,667
	33½	60	29	105	18	FLT3460ARCTP	\$1,809		
	33½	60	29	105	18	FLV3460ARCTP		\$2,371	\$2,607
	33½	54	29	98	17	FLT3454ARCTP	\$1,785		
	33½	54	29	98	17	FLV3454ARCTP		\$2,339	\$2,573
	33½	48	29	91	16	FLT3448ARCTP	\$1,761		
	33½	48	29	91	16	FLV3448ARCTP		\$2,307	\$2,538

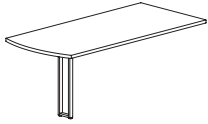

eased



reverse bevel



edges

Features:

- mounts perpendicular to primary height units
- eased edge profile on approach and user sides
- laminate tops wider than 60" are long grain

Options:

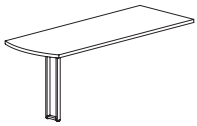
- reverse bevel edge available on three sides, specify; add \$451 list for laminate or \$177 list for veneer; see page 8 for details
- 13 ½" h modesty panel available, specify; add \$449 list for laminate or \$624 list for veneer; see page 21 for details
- top grommet available, specify location; add \$135 list each; see page 45 for details
- 12" wide top grommet available, specify location; add \$177 list each; see page 45 for details
- worksurface power available, specify "to accommodate EC26" on your purchase order; EC26 unit must be ordered separately, see page 45
- wire manager tray available see accessory section on pages 50-51 for details

Description	D	W	H	CTN WT	CU FT	① Model	HPL Laminate	Essentials Veneer	Artisan Veneer
Arc End Run-off Desk with Frame Base  	27 1/2	72	29	101	18	FLT2872ARCTP	\$1,843		
	27 1/2	72	29	101	18	FLV2872ARCTP		\$2,419	\$2,658
	27 1/2	66	29	94	17	FLT2866ARCTP	\$1,802		
	27 1/2	66	29	94	17	FLV2866ARCTP		\$2,364	\$2,601
	27 1/2	60	29	87	15	FLT2860ARCTP	\$1,763		
	27 1/2	60	29	87	15	FLV2860ARCTP		\$2,310	\$2,543
	27 1/2	54	29	80	14	FLT2854ARCTP	\$1,727		
	27 1/2	54	29	80	14	FLV2854ARCTP		\$2,259	\$2,486
	27 1/2	48	29	80	13	FLT2848ARCTP	\$1,705		
	27 1/2	48	29	80	13	FLV2848ARCTP		\$2,231	\$2,451

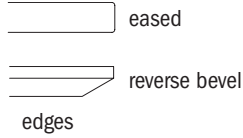

Features:

- mounts perpendicular to primary height units
- eased edge profile on approach and user sides
- laminate tops wider than 60" are long grain

Options:

- reverse bevel edge available on three sides, specify; add \$451 list for laminate or \$177 list for veneer; see page 8 for details
- 13 1/2" h modesty panel available, specify; add \$449 list for laminate or \$624 list for veneer; see page 21 for details
- top grommet available, specify location; add \$135 list each; see page 45 for details
- 12" wide top grommet available, specify location; add \$177 list each; see page 45 for details
- worksurface power available, specify "to accommodate EC26" on your purchase order; EC26 unit must be ordered separately, see page 45
- wire manager tray available see accessory section on pages 50-51 for details

To Order, Specify:

① Laminate Model #	② Laminate Type	③ Laminate Selection	④ Metal Color	⑤ Other Product Options		
Laminate (FLT)	HPL	See Laminate Selection	See Metal Finish Color Options	See list of options for each specific unit; Specify and add accordingly.		
① Veneer Model #	② Wood Collection	③ Wood Finish	④ Metal Color	⑤ Other Product Options		
Veneer (FLV)	Essentials	See Essentials Wood Finish Options	See Metal Finish Color Options	See list of options for each specific unit; Specify and add accordingly.		
	Artisan	<table border="1"> <tr> <th>ⓐ Wood Finish</th> <th>ⓑ Chassis Grain Direction</th> </tr> <tr> <td>See Artisan Wood Finish Options</td> <td>For Artisan Only: Vertical Horizontal</td> </tr> </table>	ⓐ Wood Finish		ⓑ Chassis Grain Direction	See Artisan Wood Finish Options
ⓐ Wood Finish	ⓑ Chassis Grain Direction					
See Artisan Wood Finish Options	For Artisan Only: Vertical Horizontal					

Description	D	W	H	CTN WT	CU FT	① Model	HPL Laminate	Essentials Veneer	Artisan Veneer
Boomerang Run-off Desk with End Leg Assembly	33½	72	29	119	22	FLT3472BMTNR	\$2,520		
	33½	72	29	119	22	FLV3472BMTNR		\$3,332	\$3,666
	33½	72	29	119	22	FLT3472BMTNL	\$2,520		
	33½	72	29	119	22	FLV3472BMTNL		\$3,332	\$3,666
	33½	66	29	112	20	FLT3466BMTNR	\$2,474		
	33½	66	29	112	20	FLV3466BMTNR		\$3,271	\$3,598
	33½	66	29	112	20	FLT3466BMTNL	\$2,474		
	33½	66	29	112	20	FLV3466BMTNL		\$3,271	\$3,598
	33½	60	29	105	18	FLT3460BMTNR	\$2,429		
	33½	60	29	105	18	FLV3460BMTNR		\$3,209	\$3,530
	33½	60	29	105	18	FLT3460BMTNL	\$2,429		
	33½	60	29	105	18	FLV3460BMTNL		\$3,209	\$3,530

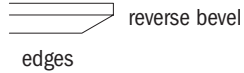
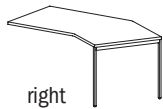
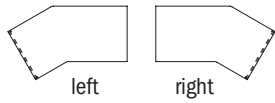
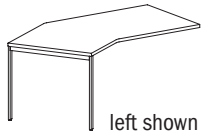

Features:

- mounts perpendicular to primary height units
- eased edge profile on approach and user sides
- laminate tops wider than 60" are long grain

Options:

- reverse bevel edge available on three sides, specify; add \$451 list for laminate or \$177 list for veneer; see page 8 for details
- 13 ½" h modesty panel available, specify; add \$449 list for laminate or \$624 list for veneer; see page 21 for details
- top grommet available, specify location; add \$135 list each; see page 45 for details
- 12" wide top grommet available, specify location; add \$177 list each; see page 45 for details
- worksurface power available, specify "to accommodate EC26" on your purchase order; EC26 unit must be ordered separately, see page 45
- wire manager tray available see accessory section on pages 50-51 for details

Description	D	W	H	CTN WT	CU FT	① Model	HPL Laminate	Essentials Veneer	Artisan Veneer
Boomerang Run-off Desk with End Leg Assembly	27 1/2	72	29	101	18	FLT2872BMTNR	\$2,463		
	27 1/2	72	29	101	18	FLV2872BMTNR		\$3,252	\$3,580
	27 1/2	66	29	94	17	FLT2866BMTNL	\$2,420		
	27 1/2	66	29	94	17	FLV2866BMTNL		\$3,194	\$3,513
	27 1/2	60	29	87	15	FLT2860BMTNR	\$2,375		
	27 1/2	60	29	87	15	FLV2860BMTNR		\$3,134	\$3,448
	27 1/2	72	29	101	18	FLT2872BMTNL	\$2,463		
	27 1/2	72	29	101	18	FLV2872BMTNL		\$3,252	\$3,580
	27 1/2	66	29	94	17	FLT2866BMTNR	\$2,420		
	27 1/2	66	29	94	17	FLV2866BMTNR		\$3,194	\$3,513
	27 1/2	60	29	87	15	FLT2860BMTNL	\$2,375		
	27 1/2	60	29	87	15	FLV2860BMTNL		\$3,134	\$3,448

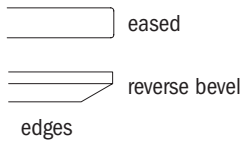
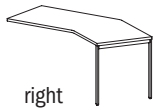
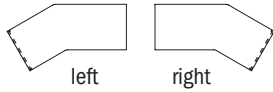
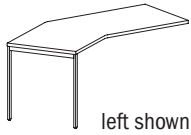

Features:

- mounts perpendicular to primary height units
- eased edge profile on approach and user sides
- laminate tops wider than 60" are long grain

Options:

- reverse bevel edge available on three sides, specify; add \$451 list for laminate or \$177 list for veneer; see page 8 for details
- 13 1/2" h modesty panel available, specify; add \$449 list for laminate or \$624 list for veneer; see page 21 for details
- top grommet available, specify location; add \$135 list each; see page 45 for details
- 12" wide top grommet available, specify location; add \$177 list each; see page 45 for details
- worksurface power available, specify "to accommodate EC26" on your purchase order; EC26 unit must be ordered separately, see page 45
- wire manager tray available see accessory section on pages 50-51 for details

To Order, Specify:

① Laminate Model #	② Laminate Type	③ Laminate Selection	④ Metal Color	⑤ Other Product Options		
Laminate (FLT)	HPL	See Laminate Selection	See Metal Finish Color Options	See list of options for each specific unit; Specify and add accordingly.		
① Veneer Model #	② Wood Collection	③ Wood Finish	④ Metal Color	⑤ Other Product Options		
Veneer (FLV)	Essentials	See Essentials Wood Finish Options	See Metal Finish Color Options	See list of options for each specific unit; Specify and add accordingly.		
	Artisan	<table border="1"> <thead> <tr> <th>ⓐ Wood Finish</th> <th>ⓑ Chassis Grain Direction</th> </tr> </thead> <tbody> <tr> <td>See Artisan Wood Finish Options</td> <td>For Artisan Only: Vertical Horizontal</td> </tr> </tbody> </table>	ⓐ Wood Finish		ⓑ Chassis Grain Direction	See Artisan Wood Finish Options
ⓐ Wood Finish	ⓑ Chassis Grain Direction					
See Artisan Wood Finish Options	For Artisan Only: Vertical Horizontal					

Description	D	W	H	CTN WT	CU FT	① Model	HPL Laminate	Essentials Veneer	Artisan Veneer
<p>left shown</p>	22	60	29	129	27	FLT2260-29FERR	\$1,678		
	22	60	29	129	27	FLV2260-29FERR		\$2,343	\$2,576
	22	60	29	129	27	FLT2260-29FELR	\$1,678		
	22	60	29	129	27	FLV2260-29FELR		\$2,343	\$2,576
	22	54	29	124	25	FLT2254-29FERR	\$1,645		
	22	54	29	124	25	FLV2254-29FERR		\$2,297	\$2,526
	22	54	29	124	25	FLT2254-29FELR	\$1,645		
	22	54	29	124	25	FLV2254-29FELR		\$2,297	\$2,526
	22	48	29	119	22	FLT2248-29FERR	\$1,614		
	22	48	29	119	22	FLV2248-29FERR		\$2,253	\$2,478
	22	48	29	119	22	FLT2248-29FELR	\$1,614		
	22	48	29	119	22	FLV2248-29FELR		\$2,253	\$2,478
	22	42	29	114	20	FLT2242-29FERR	\$1,582		
	22	42	29	114	20	FLV2242-29FERR		\$2,209	\$2,428
	22	42	29	114	20	FLT2242-29FELR	\$1,582		
22	42	29	114	20	FLV2242-29FELR		\$2,209	\$2,428	

Features:

- eased edge user side only
- pedestal front locking

Options:

- must specify chassis grain direction on artisan veneer, see pages 13-15 for details
- standard without kneespace modesty panel, partial and full modesty panels available; add \$170 list for laminate or \$212 list for veneer; see page 12 for details
- veneer drawer fronts in paint available, specify paint color; add \$354 list; see page 16 for details
- on laminate units, contrasting worksurface tops and drawer fronts available, no upcharge; specify color, see page 16 for details
- ledge pulls standard; prism pulls available, specify and see page 9
- interior wire manager from side to side in upper back, specify and add \$120 list; see page 17 for details
- top grommet available, specify location and add \$135 list each; see page 45 for details
- worksurface power available, specify "to accommodate EC26" on your purchase order; EC26 unit must be ordered separately, see page 45

Description	D	W	H	CTN WT	CU FT	① Model	HPL Laminate	Essentials Veneer	Artisan Veneer
 <p>left shown</p>	22	60	29	129	27	FLT2260-29FERY	\$1,687		
	22	60	29	129	27	FLV2260-29FERY		\$2,350	\$2,583
	22	60	29	129	27	FLT2260-29FELY	\$1,687		
	22	60	29	129	27	FLV2260-29FELY		\$2,350	\$2,583
	22	54	29	124	25	FLT2254-29FERY	\$1,654		
	22	54	29	124	25	FLV2254-29FERY		\$2,305	\$2,536
	22	54	29	124	25	FLT2254-29FELY	\$1,654		
	22	54	29	124	25	FLV2254-29FELY		\$2,305	\$2,536
	22	48	29	119	22	FLT2248-29FERY	\$1,623		
	22	48	29	119	22	FLV2248-29FERY		\$2,259	\$2,486
	22	48	29	119	22	FLT2248-29FELY	\$1,623		
	22	48	29	119	22	FLV2248-29FELY		\$2,259	\$2,486
	22	42	29	114	20	FLT2242-29FERY	\$1,590		
	22	42	29	114	20	FLV2242-29FERY		\$2,215	\$2,436
	22	42	29	114	20	FLT2242-29FELY	\$1,590		
	22	42	29	114	20	FLV2242-29FELY		\$2,215	\$2,436

Features:

- eased edge user side only
- pedestal front locking

Options:

- must specify chassis grain direction on artisan veneer, see pages 13-15 for details
- standard without kneespace modesty panel, partial and full modesty panels available; add \$170 list for laminate or \$212 list for veneer; see page 12 for details
- veneer drawer fronts in paint available, specify paint color; add \$354 list; see page 16 for details
- on laminate units, contrasting worksurface tops and drawer fronts available, no upcharge; specify color, see page 16 for details
- ledge pulls standard; prism pulls available, specify and see page 9
- interior wire manager from side to side in upper back, specify and add \$120 list; see page 17 for details
- top grommet available, specify location and add \$135 list each; see page 45 for details
- worksurface power available, specify "to accommodate EC26" on your purchase order; EC26 unit must be ordered separately, see page 45

To Order, Specify:

① Laminate Model #	② Laminate Type	③ Laminate Selection	④ Metal Color	⑤ Other Product Options		
Laminate (FLT)	HPL	See Laminate Selection	See Metal Finish Color Options	See list of options for each specific unit; Specify and add accordingly.		
① Veneer Model #	② Wood Collection	③ Wood Finish	④ Metal Color	⑤ Other Product Options		
Veneer (FLV)	Essentials	See Essentials Wood Finish Options	See Metal Finish Color Options	See list of options for each specific unit; Specify and add accordingly.		
	Artisan	<table border="1"> <tr> <th>ⓐ Wood Finish</th> <th>ⓑ Chassis Grain Direction</th> </tr> <tr> <td>See Artisan Wood Finish Options</td> <td>For Artisan Only: Vertical Horizontal</td> </tr> </table>	ⓐ Wood Finish		ⓑ Chassis Grain Direction	See Artisan Wood Finish Options
ⓐ Wood Finish	ⓑ Chassis Grain Direction					
See Artisan Wood Finish Options	For Artisan Only: Vertical Horizontal					

Description	D	W	H	CTN WT	CU FT	① Model	HPL Laminate	Essentials Veneer	Artisan Veneer
 left shown	22	60	29	185	27	FLT2260-29FLRR	\$1,981		
	22	60	29	185	27	FLV2260-29FLRR		\$2,766	\$3,041
	22	60	29	185	27	FLT2260-29FLLR	\$1,981		
	22	60	29	185	27	FLV2260-29FLLR		\$2,766	\$3,041
	22	54	29	180	25	FLT2254-29FLRR	\$1,934		
	22	54	29	180	25	FLV2254-29FLRR		\$2,698	\$2,968
	22	54	29	180	25	FLT2254-29FLLR	\$1,934		
	22	54	29	180	25	FLV2254-29FLLR		\$2,698	\$2,968
	22	48	29	175	22	FLT2248-29FLRR	\$1,886		
	22	48	29	175	22	FLV2248-29FLRR		\$2,633	\$2,897
22	48	29	175	22	FLT2248-29FLLR	\$1,886			
22	48	29	175	22	FLV2248-29FLLR		\$2,633	\$2,897	

Features:

- eased edge user side only
- pedestal front locking

Options:

- must specify chassis grain direction on artisan veneer, see pages 13-15 for details
- standard without kneespace modesty panel, partial and full modesty panels available; add \$170 list for laminate or \$212 list for veneer; see page 12 for details
- veneer drawer fronts in paint available, specify paint color; add \$354 list; see page 16 for details
- on laminate units, contrasting worksurface tops and drawer fronts available, no upcharge; specify color, see page 16 for details
- ledge pulls standard; prism pulls available, specify and see page 9
- interior wire manager from side to side in upper back, specify and add \$120 list; see page 17 for details
- top grommet available, specify location and add \$135 list each; see page 45 for details
- worksurface power available, specify "to accommodate EC26" on your purchase order; EC26 unit must be ordered separately, see page 45

Description	D	W	H	CTN WT	CU FT	① Model	HPL Laminate	Essentials Veneer	Artisan Veneer
 left shown	22	60	29	185	27	FLT2260-29FLRY	\$1,991		
	22	60	29	185	27	FLV2260-29FLRY		\$2,780	\$3,057
	22	60	29	185	27	FLT2260-29FLLY	\$1,991		
	22	60	29	185	27	FLV2260-29FLLY		\$2,780	\$3,057
	22	54	29	180	25	FLT2254-29FLRY	\$1,944		
	22	54	29	180	25	FLV2254-29FLRY		\$2,712	\$2,984
	22	54	29	180	25	FLT2254-29FLLY	\$1,944		
	22	54	29	180	25	FLV2254-29FLLY		\$2,712	\$2,984
	22	48	29	175	22	FLT2248-29FLRY	\$1,897		
	22	48	29	175	22	FLV2248-29FLRY		\$2,646	\$2,910
22	48	29	175	22	FLT2248-29FLLY	\$1,897			
22	48	29	175	22	FLV2248-29FLLY		\$2,646	\$2,910	

Features:

- eased edge user side only
- pedestal front locking

Options:

- must specify chassis grain direction on artisan veneer, see pages 13-15 for details
- standard without kneespace modesty panel, partial and full modesty panels available; add \$170 list for laminate or \$212 list for veneer; see page 12 for details
- veneer drawer fronts in paint available, specify paint color; add \$354 list; see page 16 for details
- on laminate units, contrasting worksurface tops and drawer fronts available, no upcharge; specify color, see page 16 for details
- ledge pulls standard; prism pulls available, specify and see page 9
- interior wire manager from side to side in upper back, specify and add \$120 list; see page 17 for details
- top grommet available, specify location and add \$135 list each; see page 45 for details
- worksurface power available, specify "to accommodate EC26" on your purchase order; EC26 unit must be ordered separately, see page 45

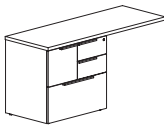
Description	D	W	H	CTN WT	CU FT	① Model	HPL Laminate	Essentials Veneer	Artisan Veneer
 Multi-File Return left shown	22	60	29	191	27	FLT2260-29FMRR	\$2,118		
	22	60	29	191	27	FLV2260-29FMRR		\$2,959	\$3,252
	22	60	29	191	27	FLT2260-29FMLR	\$2,118		
	22	60	29	191	27	FLV2260-29FMLR		\$2,959	\$3,252
	22	54	29	186	25	FLT2254-29FMRR	\$2,069		
	22	54	29	186	25	FLV2254-29FMRR		\$2,887	\$3,175
	22	54	29	186	25	FLT2254-29FMLR	\$2,069		
	22	54	29	186	25	FLV2254-29FMLR		\$2,887	\$3,175
	22	48	29	181	22	FLT2248-29FMRR	\$2,016		
	22	48	29	181	22	FLV2248-29FMRR		\$2,817	\$3,098
	22	48	29	181	22	FLT2248-29FMLR	\$2,016		
	22	48	29	181	22	FLV2248-29FMLR		\$2,817	\$3,098

Features:

- eased edge user side only
- pedestal front locking

Options:

- must specify chassis grain direction on artisan veneer, see pages 13-15 for details
- standard without kneespace modesty panel, partial and full modesty panels available; add \$170 list for laminate or \$212 list for veneer; see page 12 for details
- veneer drawer fronts in paint available, specify paint color; add \$354 list; see page 16 for details
- on laminate units, contrasting worksurface tops and drawer fronts available, no upcharge; specify color, see page 16 for details
- ledge pulls standard; prism pulls available, specify and see page 9
- interior wire manager from side to side in upper back, specify and add \$120 list; see page 17 for details
- top grommet available, specify location and add \$135 list each; see page 45 for details
- worksurface power available, specify "to accommodate EC26" on your purchase order; EC26 unit must be ordered separately, see page 45

FLUX

To Order, Specify:

① Laminate Model #	② Laminate Type	③ Laminate Selection	④ Metal Color	⑤ Other Product Options		
Laminate (FLT)	HPL	See Laminate Selection	See Metal Finish Color Options	See list of options for each specific unit; Specify and add accordingly.		
① Veneer Model #	② Wood Collection	③ Wood Finish	④ Metal Color	⑤ Other Product Options		
Veneer (FLV)	Essentials	See Essentials Wood Finish Options	See Metal Finish Color Options	See list of options for each specific unit; Specify and add accordingly.		
	Artisan	<table border="1"> <tr> <th>ⓐ Wood Finish</th> <th>ⓑ Chassis Grain Direction</th> </tr> <tr> <td>See Artisan Wood Finish Options</td> <td>For Artisan Only: Vertical Horizontal</td> </tr> </table>	ⓐ Wood Finish		ⓑ Chassis Grain Direction	See Artisan Wood Finish Options
ⓐ Wood Finish	ⓑ Chassis Grain Direction					
See Artisan Wood Finish Options	For Artisan Only: Vertical Horizontal					

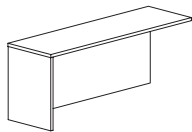
Description	D	W	H	CTN WT	CU FT	① Model	HPL Laminate	Essentials Veneer	Artisan Veneer
 left shown	22	72	29	119	33	FLT2272RSHR	\$1,187		
	22	72	29	119	33	FLV2272RSHR		\$1,796	\$1,977
	22	72	29	119	33	FLT2272LSHR	\$1,187		
	22	72	29	119	33	FLV2272LSHR		\$1,796	\$1,977
	22	66	29	114	30	FLT2266RSHR	\$1,154		
	22	66	29	114	30	FLV2266RSHR		\$1,745	\$1,917
	22	66	29	114	30	FLT2266LSHR	\$1,154		
	22	66	29	114	30	FLV2266LSHR		\$1,745	\$1,917
	22	60	29	109	27	FLT2260RSHR	\$1,118		
	22	60	29	109	27	FLV2260RSHR		\$1,691	\$1,861
	22	60	29	109	27	FLT2260LSHR	\$1,118		
	22	60	29	109	27	FLV2260LSHR		\$1,691	\$1,861
	22	54	29	104	25	FLT2254RSHR	\$1,085		
	22	54	29	104	25	FLV2254RSHR		\$1,641	\$1,805
	22	54	29	104	25	FLT2254LSHR	\$1,085		
	22	54	29	104	25	FLV2254LSHR		\$1,641	\$1,805
	22	48	29	99	22	FLT2248RSHR	\$1,052		
	22	48	29	99	22	FLV2248RSHR		\$1,591	\$1,752
	22	48	29	99	22	FLT2248LSHR	\$1,052		
	22	48	29	99	22	FLV2248LSHR		\$1,591	\$1,752
22	42	29	94	20	FLT2242RSHR	\$1,020			
22	42	29	94	20	FLV2242RSHR		\$1,545	\$1,699	
22	42	29	94	20	FLT2242LSHR	\$1,020			
22	42	29	94	20	FLV2242LSHR		\$1,545	\$1,699	
22	36	29	89	17	FLT2236RSHR	\$991			
22	36	29	89	17	FLV2236RSHR		\$1,499	\$1,647	
22	36	29	89	17	FLT2236LSHR	\$991			
22	36	29	89	17	FLV2236LSHR		\$1,499	\$1,647	

Features:

- eased edge user side only
- laminate tops wider than 60" are long grain

Options:

- must specify chassis grain direction on artisan veneer, see pages 13-15 for details
- top grommet available, specify location; add \$135 list each; see page 45 for details

FLUX

Description	D	W	H	CTN WT	CU FT	① Model	HPL Laminate	Essentials Veneer	Artisan Veneer
Bridge 	22	50	1 3/16	69	3	FLT2250EB	\$626		
	22	50	1 3/16	69	3	FLV2250EB		\$781	\$858
	22	44	1 3/16	64	3	FLT2244EB	\$585		
	22	44	1 3/16	64	3	FLV2244EB		\$731	\$806
	22	38	1 3/16	59	2	FLT2238EB	\$576		
	22	38	1 3/16	59	2	FLV2238EB		\$720	\$791

Features:

- eased edge user side only

Options:

- standard without kneespace modesty panel, partial and full modesty panels available; add \$170 list for laminate or \$212 list for veneer; see page 12 for details
- when specify modesty with artisan veneer, specify grain direction, see pages 13-15 for details
- top grommet available, specify location; add \$135 list each; see page 45 for details
- worksurface power available, specify "to accommodate EC26" on your purchase order; EC26 unit must be ordered separately, see page 45

FLUX

To Order, Specify:

① Laminate Model #	② Laminate Type	③ Laminate Selection		④ Metal Color	⑤ Other Product Options
Laminate (FLT)	HPL	See Laminate Selection		See Metal Finish Color Options	See list of options for each specific unit; Specify and add accordingly.
① Veneer Model #	② Wood Collection	③ Wood Finish		④ Metal Color	⑤ Other Product Options
Veneer (FLV)	Essentials	See Essentials Wood Finish Options		See Metal Finish Color Options	See list of options for each specific unit; Specify and add accordingly.
	Artisan	③a Wood Finish See Artisan Wood Finish Options	③b Chassis Grain Direction For Artisan Only: Vertical Horizontal		

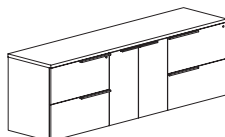
Description	D	W	H	CTN WT	CU FT	① Model	HPL Laminate	Essentials Veneer	Artisan Veneer
	22	96	29	437	43	FLT2296-29F474	\$3,663		
	22	96	29	437	43	FLV2296-29F474		\$5,110	\$5,622
	22	90	29	416	40	FLT2290-29F474	\$3,556		
	22	90	29	416	40	FLV2290-29F474		\$4,963	\$5,459
	22	84	29	395	38	FLT2284-29F474	\$3,450		
	22	84	29	395	38	FLV2284-29F474		\$4,818	\$5,300

Features:

- eased edge profile user side
- pedestal front locking
- hinged door compartment has one adjustable shelf

Options:

- must specify chassis grain direction on artisan veneer, see pages 13-15 for details
- locking doors available, specify and add \$147 list
- veneer door and drawer fronts in paint available, specify paint color and add \$354; see page 16 for details
- on laminate units, contrasting worksurface tops and door fronts available, no upcharge; specify laminate color, see page 16 for details
- ledge pulls standard; prism pulls available, specify and see page 9
- oval grommets in back panel can be eliminated upon request, no upcharge
- interior horizontal wire manager with end grommets available, specify and add \$189 list; see page 40 for details
- top grommet available, specify location; add \$135 list each; see page 45 for details
- worksurface power available, specify "to accommodate EC26" on your purchase order; EC26 unit must be ordered separately, see page 45

FLUX

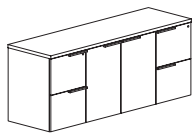
	22	78	29	354	35	FLT2278-29F272	\$3,029		
	22	78	29	354	35	FLV2278-29F272		\$4,230	\$4,653
	22	72	29	333	32	FLT2272-29F272	\$2,942		
	22	72	29	333	32	FLV2272-29F272		\$4,106	\$4,514
	22	66	29	310	30	FLT2266-29F272	\$2,883		
	22	66	29	310	30	FLV2266-29F272		\$4,024	\$4,427
	22	60	29	289	27	FLT2260-29F272	\$2,824		
	22	60	29	289	27	FLV2260-29F272		\$3,942	\$4,339

Features:

- eased edge profile user side
- pedestal front locking
- hinged door compartment has one adjustable shelf

Options:

- must specify chassis grain direction on artisan veneer, see pages 13-15 for details
- locking doors available, specify and add \$147 list
- veneer door and drawer fronts in paint available, specify paint color and add \$354; see page 16 for details
- on laminate units, contrasting worksurface tops and door fronts available, no upcharge; specify laminate color, see page 16 for details
- ledge pulls standard; prism pulls available, specify and see page 9
- oval grommets in back panel can be eliminated upon request, no upcharge
- interior horizontal wire manager with end grommets available, specify and add \$189 list; see page 40 for details
- top grommet available, specify location; add \$135 list each; see page 45 for details
- worksurface power available, specify "to accommodate EC26" on your purchase order; EC26 unit must be ordered separately, see page 45

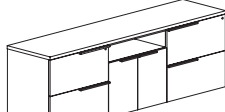
Description	D	W	H	CTN WT	CU FT	① Model	HPL Laminate	Essentials Veneer	Artisan Veneer
Storage Credenza with Open Center 	22	96	29	447	43	FLT2296-29F484	\$3,745		
	22	96	29	447	43	FLV2296-29F484		\$5,229	\$5,752
	22	90	29	425	40	FLT2290-29F484	\$3,636		
	22	90	29	425	40	FLV2290-29F484		\$5,077	\$5,582
	22	84	29	402	38	FLT2284-29F484	\$3,530		
	22	84	29	402	38	FLV2284-29F484		\$4,930	\$5,422

Features:

- eased edge profile user side
- pedestal front locking
- hinged door compartment has one adjustable shelf

Options:

- must specify chassis grain direction on artisan veneer, see pages 13-15 for details
- locking doors available, specify and add \$147 list
- veneer door and drawer fronts in paint available, specify paint color and add \$354; see page 16 for details
- on laminate units, contrasting worksurface tops and door fronts available, no upcharge; specify laminate color, see page 16 for details
- ledge pulls standard; prism pulls available, specify and see page 9
- oval grommets in back panel can be eliminated upon request, no upcharge
- interior horizontal wire manager with end grommets available, specify and add \$189 list; see page 40 for details
- top grommet available, specify location; add \$135 list each; see page 45 for details
- worksurface power available, specify "to accommodate EC26" on your purchase order; EC26 unit must be ordered separately, see page 45

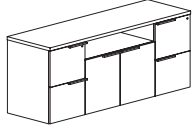
Storage Credenza with Open Center 	22	78	29	366	35	FLT2278-29F282	\$3,045		
	22	78	29	366	35	FLV2278-29F282		\$4,251	\$4,675
	22	72	29	344	32	FLT2272-29F282	\$2,957		
	22	72	29	344	32	FLV2272-29F282		\$4,127	\$4,541
	22	66	29	320	30	FLT2266-29F282	\$2,897		
	22	66	29	320	30	FLV2266-29F282		\$4,045	\$4,451
	22	60	29	298	27	FLT2260-29F282	\$2,840		
	22	60	29	298	27	FLV2260-29F282		\$3,964	\$4,361

Features:

- eased edge profile user side
- pedestal front locking
- hinged door compartment has one adjustable shelf

Options:

- must specify chassis grain direction on artisan veneer, see pages 13-15 for details
- locking doors available, specify and add \$147 list
- veneer door and drawer fronts in paint available, specify paint color and add \$354; see page 16 for details
- on laminate units, contrasting worksurface tops and door fronts available, no upcharge; specify laminate color, see page 16 for details
- ledge pulls standard; prism pulls available, specify and see page 9
- oval grommets in back panel can be eliminated upon request, no upcharge
- interior horizontal wire manager with end grommets available, specify and add \$189 list; see page 40 for details
- top grommet available, specify location; add \$135 list each; see page 45 for details
- worksurface power available, specify "to accommodate EC26" on your purchase order; EC26 unit must be ordered separately, see page 45

To Order, Specify:

① Laminate Model #	② Laminate Type	③ Laminate Selection	④ Metal Color	⑤ Other Product Options
Laminate (FLT)	HPL	See Laminate Selection	See Metal Finish Color Options	See list of options for each specific unit; Specify and add accordingly.
① Veneer Model #	② Wood Collection	③ Wood Finish	④ Metal Color	⑤ Other Product Options
Veneer (FLV)	Essentials	See Essentials Wood Finish Options	See Metal Finish Color Options	See list of options for each specific unit; Specify and add accordingly.
	Artisan	Ⓐ Wood Finish See Artisan Wood Finish Options	Ⓑ Chassis Grain Direction For Artisan Only: Vertical Horizontal	

Description	D	W	H	CTN WT	CU FT	① Model	HPL Laminate	Essentials Veneer	Artisan Veneer
Lateral File Credenza	22	90	29	448	40	FLT2290-29F444	\$3,311		
	22	90	29	448	40	FLV2290-29F444		\$4,616	\$5,078

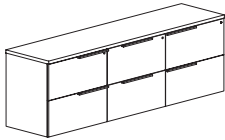

Features:

- eased edge profile user side
- pedestal front locking

Options:

- must specify chassis grain direction on artisan veneer, see pages 13-15 for details
- veneer drawer fronts in paint available, specify paint color and add \$354 list; see page 16 for details
- on laminate units, contrasting worksurface tops and drawer fronts available, no upcharge; specify color, see page 16 for details
- ledge pulls standard; prism pulls available, specify and see page 9
- oval grommets in back panel can be eliminated upon request, no upcharge
- top grommet available, specify location and add \$135 list each; see page 45 for details

Lateral File Credenza	22	72	29	354	32	FLT2272-29F44	\$2,475		
	22	72	29	354	32	FLV2272-29F44		\$3,456	\$3,801
	22	60	29	310	27	FLT2260-29F44	\$2,381		
	22	60	29	310	27	FLV2260-29F44		\$3,322	\$3,654

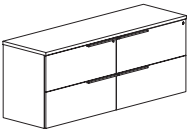

Features:

- eased edge profile user side
- pedestal front locking

Options:

- must specify chassis grain direction on artisan veneer, see pages 13-15 for details
- veneer drawer fronts in paint available, specify paint color and add \$354 list; see page 16 for details
- on laminate units, contrasting worksurface tops and drawer fronts available, no upcharge; specify color, see page 16 for details
- ledge pulls standard; prism pulls available, specify and see page 9
- oval grommets in back panel can be eliminated upon request, no upcharge
- top grommet available, specify location and add \$135 list each; see page 45 for details

Lateral File Pedestal	22	36	29	166	17	FLT2236-29F4	\$1,832		
	22	36	29	166	17	FLV2236-29F4		\$2,557	\$2,813
	22	30	29	150	14	FLT2230-29F4	\$1,569		
	22	30	29	150	17	FLV2230-29F4		\$2,190	\$2,409

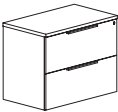

Features:

- eased edge profile user side
- pedestal front locking
- anti-tip interlock mechanism

Options:

- must specify chassis grain direction on artisan veneer, see pages 13-15 for details
- veneer drawer fronts in paint available, specify paint color and add \$354 list; see page 16 for details
- on laminate units, contrasting worksurface tops and drawer fronts available, no upcharge; specify color, see page 16 for details
- ledge pulls standard; prism pulls available, specify and see page 9
- oval grommet in back panel can be eliminated upon request, no upcharge
- top grommet available, specify location and add \$135 list each; see page 45 for details

FLUX

Description	D	W	H	CTN WT	CU FT	① Model	HPL Laminate	Essentials Veneer	Artisan Veneer
 Box/Box/Lateral File Pedestal	22	36	29	166	17	FLT2236-29F3	\$1,844		
	22	36	29	166	17	FLV2236-29F3		\$2,570	\$2,827
	22	30	29	150	14	FLT2230-29F3	\$1,581		
	22	30	29	150	17	FLV2230-29F3		\$2,201	\$2,422

Features:

- eased edge profile user side
- pedestal front locking
- anti-tip interlock mechanism

Options:

- must specify chassis grain direction on artisan veneer, see pages 13-15 for details
- veneer drawer fronts in paint available, specify paint color and add \$354 list; see page 16 for details
- on laminate units, contrasting worksurface tops and drawer fronts available, no upcharge; specify color, see page 16 for details
- ledge pulls standard; prism pulls available, specify and see page 9
- oval grommet in back panel can be eliminated upon request, no upcharge
- top grommet available, specify location and add \$135 list each; see page 45 for details

FLUX

To Order, Specify:

① Laminate Model #	② Laminate Type	③ Laminate Selection		④ Metal Color	⑤ Other Product Options
Laminate (FLT)	HPL	See Laminate Selection		See Metal Finish Color Options	See list of options for each specific unit; Specify and add accordingly.
① Veneer Model #	② Wood Collection	③ Wood Finish		④ Metal Color	⑤ Other Product Options
Veneer (FLV)	Essentials	See Essentials Wood Finish Options		See Metal Finish Color Options	See list of options for each specific unit; Specify and add accordingly.
	Artisan	ⓐ Wood Finish See Artisan Wood Finish Options	ⓑ Chassis Grain Direction For Artisan Only: Vertical Horizontal		

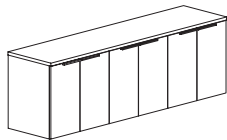
Description	D	W	H	CTN WT	CU FT	① Model	HPL Laminate	Essentials Veneer	Artisan Veneer
	22	96	29	386	43	FLT2296-29F777	\$3,018		
	22	96	29	386	43	FLV2296-29F777		\$4,437	\$4,882
	22	90	29	365	40	FLT2290-29F777	\$2,931		
	22	90	29	365	40	FLV2290-29F777		\$4,308	\$4,739
	22	84	29	344	38	FLT2284-29F777	\$2,856		
	22	84	29	344	38	FLV2284-29F777		\$4,200	\$4,620

Features:

- eased edge profile user side
- each hinged door compartment has one adjustable shelf

Options:

- must specify chassis grain direction on artisan veneer, see pages 13-15 for details
- locking doors available, specify and add \$441 list
- veneer door fronts in paint available, specify paint color and add \$354 list; see page 16 for details
- on laminate units, contrasting worksurface tops and door fronts available, no upcharge; specify color, see page 16 for details
- ledge pulls standard; prism pulls available, specify and see page 9
- oval grommets in back panel can be eliminated upon request, no upcharge
- interior horizontal wire manager with end grommets available, specify and add \$189 list; see page 40 for details
- top grommet available, specify location; add \$135 list each; see page 45 for details
- worksurface power available, specify "to accommodate EC26" on your purchase order; EC26 unit must be ordered separately, see page 45

FLUX

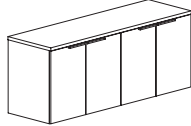
Description	D	W	H	CTN WT	CU FT	① Model	HPL Laminate	Essentials Veneer	Artisan Veneer
	22	78	29	312	34	FLT2278-29F77	\$2,621		
	22	78	29	312	34	FLV2278-29F77		\$3,851	\$4,236
	22	72	29	291	32	FLT2272-29F77	\$2,546		
	22	72	29	291	32	FLV2272-29F77		\$3,741	\$4,113
	22	66	29	270	29	FLT2266-29F77	\$2,443		
	22	66	29	270	29	FLV2266-29F77		\$3,590	\$3,950
	22	60	29	265	27	FLT2260-29F77	\$2,346		
	22	60	29	265	27	FLV2260-29F77		\$3,448	\$3,794

Features:

- eased edge profile user side
- each hinged door compartment has one adjustable shelf

Options:

- must specify chassis grain direction on artisan veneer, see pages 13-15 for details
- locking doors available, specify and add \$294 list
- veneer door fronts in paint available, specify paint color and add \$354 list; see page 16 for details
- on laminate units, contrasting worksurface tops and door fronts available, no upcharge; specify color, see page 16 for details
- ledge pulls standard; prism pulls available, specify and see page 9
- oval grommets in back panel can be eliminated upon request, no upcharge
- interior horizontal wire manager with end grommets available, specify and add \$189 list; see page 40 for details
- top grommet available, specify location; add \$135 list each; see page 45 for details
- worksurface power available, specify "to accommodate EC26" on your purchase order; EC26 unit must be ordered separately, see page 45

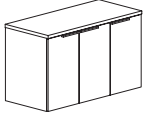
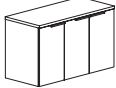
Description	D	W	H	CTN WT	CU FT	① Model	HPL Laminate	Essentials Veneer	Artisan Veneer
 right shown  left	22	54	29	228	24	FLT2254-29F77R	\$2,136		
	22	54	29	228	24	FLV2254-29F77R		\$3,136	\$3,450
	22	54	29	228	24	FLT2254-29F77L	\$2,136		
	22	54	29	228	24	FLV2254-29F77L		\$3,136	\$3,450
	22	48	29	206	22	FLT2248-29F77R	\$2,028		
	22	48	29	206	22	FLV2248-29F77R		\$2,980	\$3,281
	22	48	29	206	22	FLT2248-29F77L	\$2,028		
	22	48	29	206	22	FLV2248-29F77L		\$2,980	\$3,281
	22	42	29	185	19	FLT2242-29F77R	\$1,926		
	22	42	29	185	19	FLV2242-29F77R		\$2,830	\$3,115
	22	42	29	185	19	FLT2242-29F77L	\$1,926		
	22	42	29	185	19	FLV2242-29F77L		\$2,830	\$3,115

Features:

- eased edge profile user side
- each hinged door compartment has one adjustable shelf

Options:

- must specify chassis grain direction on artisan veneer, see pages 13-15 for details
- locking doors available, specify and add \$294 list
- veneer door fronts in paint available, specify paint color and add \$354 list; see page 16 for details
- on laminate units, contrasting worksurface tops and door fronts available, no upcharge; specify color, see page 16 for details
- ledge pulls standard; prism pulls available, specify and see page 9
- oval grommets in back panel can be eliminated upon request, no upcharge
- interior horizontal wire manager with end grommets available, specify and add \$189 list; see page 40 for details
- top grommet available, specify location; add \$135 list each; see page 45 for details
- worksurface power available, specify "to accommodate EC26" on your purchase order; EC26 unit must be ordered separately, see page 45
- pull out trash can available, specify and add \$479 list; see page 36 for details

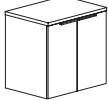
Description	D	W	H	CTN WT	CU FT	① Model	HPL Laminate	Essentials Veneer	Artisan Veneer
	22	36	29	156	17	FLT2236-29F7	\$1,369		
	22	36	29	156	17	FLV2236-29F7		\$2,013	\$2,214
	22	30	29	132	14	FLT2230-29F7	\$1,315		
	22	30	29	132	14	FLV2230-29F7		\$1,932	\$2,125

Features:

- eased edge profile user side
- each hinged door compartment has one adjustable shelf

Options:

- must specify chassis grain direction on artisan veneer, see pages 13-15 for details
- locking doors available, specify and add \$147 list
- veneer door fronts in paint available, specify paint color and add \$354 list; see page 16 for details
- on laminate units, contrasting worksurface tops and door fronts available, no upcharge; specify color, see page 16 for details
- ledge pulls standard; prism pulls available, specify and see page 9
- oval grommets in back panel can be eliminated upon request, no upcharge
- interior horizontal wire manager with end grommets available, specify and add \$189 list; see page 40 for details
- top grommet available, specify location; add \$135 list each; see page 45 for details
- worksurface power available, specify "to accommodate EC26" on your purchase order; EC26 unit must be ordered separately, see page 45

To Order, Specify:

① Laminate Model #	② Laminate Type	③ Laminate Selection	④ Metal Color	⑤ Other Product Options			
Laminate (FLT)	HPL	See Laminate Selection	See Metal Finish Color Options	See list of options for each specific unit; Specify and add accordingly.			
① Veneer Model #	② Wood Collection	③ Wood Finish	④ Metal Color	⑤ Other Product Options			
Veneer (FLV)	Essentials	See Essentials Wood Finish Options	See Metal Finish Color Options	See list of options for each specific unit; Specify and add accordingly.			
	Artisan	<table border="1"> <thead> <tr> <th>Ⓐ Wood Finish</th> <th>Ⓑ Chassis Grain Direction</th> </tr> </thead> <tbody> <tr> <td>See Artisan Wood Finish Options</td> <td>For Artisan Only: Vertical Horizontal</td> </tr> </tbody> </table>	Ⓐ Wood Finish	Ⓑ Chassis Grain Direction	See Artisan Wood Finish Options	For Artisan Only: Vertical Horizontal	
Ⓐ Wood Finish	Ⓑ Chassis Grain Direction						
See Artisan Wood Finish Options	For Artisan Only: Vertical Horizontal						

Description	D	W	H	CTN WT	CU FT	① Model	HPL Laminate	Essentials Veneer	Artisan Veneer
Six Door Credenza with Open Center	22	96	29	394	43	FLT2296-29F787	\$3,145		
	22	96	29	394	43	FLV2296-29F787		\$4,389	\$4,828
	22	90	29	372	40	FLT2290-29F787	\$3,054		
	22	90	29	372	40	FLV2290-29F787		\$4,266	\$4,690
	22	84	29	353	38	FLT2284-29F787	\$2,965		
	22	84	29	353	38	FLV2284-29F787		\$4,139	\$4,551

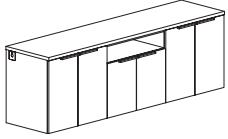

Features:

- eased edge profile user side
- each hinged door compartment has one adjustable shelf

Options:

- must specify chassis grain direction on artisan veneer, see pages 13-15 for details
- locking doors available, specify and add \$441 list
- veneer door and drawer fronts in paint available, specify paint color and add \$354; see page 16 for details
- on laminate units, contrasting worksurface tops and door fronts available, no upcharge; specify color, see page 16 for details
- ledge pulls standard; prism pulls available, specify and see page 9
- oval grommets in back panel can be eliminated upon request, no upcharge
- interior horizontal wire manager with end grommets available, specify and add \$189 list; see page 40 for details
- top grommet available, specify location; add \$135 list each; see page 45 for details
- worksurface power available, specify "to accommodate EC26" on your purchase order; EC26 unit must be ordered separately, see page 45

Four Door Credenza with Open Center	22	78	29	339	35	FLT2278-29F787	\$2,712		
	22	78	29	339	35	FLV2278-29F787		\$3,985	\$4,385
	22	72	29	310	32	FLT2272-29F787	\$2,621		
	22	72	29	310	32	FLV2272-29F787		\$3,851	\$4,236
	22	66	29	288	30	FLT2266-29F787	\$2,543		
	22	66	29	288	30	FLV2266-29F787		\$3,738	\$4,112
	22	60	29	266	27	FLT2260-29F787	\$2,468		
	22	60	29	266	27	FLV2260-29F787		\$3,626	\$3,986

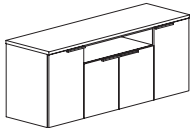

Features:

- eased edge profile user side
- each hinged door compartment has one adjustable shelf

Options:

- must specify chassis grain direction on artisan veneer, see pages 13-15 for details
- locking doors available, specify and add \$441 list
- veneer door and drawer fronts in paint available, specify paint color and add \$354; see page 16 for details
- on laminate units, contrasting worksurface tops and door fronts available, no upcharge; specify color, see page 16 for details
- ledge pulls standard; prism pulls available, specify and see page 9
- oval grommets in back panel can be eliminated upon request, no upcharge
- interior horizontal wire manager with end grommets available, specify and add \$189 list; see page 40 for details
- top grommet available, specify location; add \$135 list each; see page 45 for details
- worksurface power available, specify "to accommodate EC26" on your purchase order; EC26 unit must be ordered separately, see page 45
- pull out trash can available, specify and add \$479 list; see page 40 for details

Description	D	W	H	CTN WT	CU FT	① Model	HPL Laminate	Essentials Veneer	Artisan Veneer
Two Door Credenza with Open Storage Compartment	22	54	29	228	25	FLT2254-29F707	\$2,245		
	22	54	29	228	25	FLV2254-29F707		\$3,297	\$3,630
	22	48	29	208	22	FLT2248-29F707	\$2,135		
	22	48	29	208	22	FLV2248-29F707		\$3,135	\$3,449
	22	42	29	189	19	FLT2242-29F707	\$2,027		
	22	42	29	189	19	FLV2242-29F707		\$2,978	\$3,278

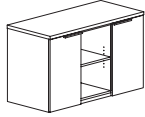

Features:

- eased edge profile user side
- each compartment has one adjustable shelf

Options:

- must specify chassis grain direction on artisan veneer, see pages 13-15 for details
- locking doors available, specify and add \$294 list
- veneer door fronts in paint available, specify paint color and add \$354 list; see page 16 for details
- on laminate units, contrasting worksurface tops and door fronts available, no upcharge; specify color, see page 16 for details
- ledge pulls standard; prism pulls available, specify and see page 9
- oval grommets in back panel can be eliminated upon request, no upcharge
- interior horizontal wire manager with end grommets available, specify and add \$189 list; see page 40 for details
- top grommet available, specify location; add \$135 list each; see page 45 for details
- worksurface power available, specify "to accommodate EC26" on your purchase order; EC26 unit must be ordered separately, see page 45
- pull out trash can available, specify and add \$479 list; see page 40 for details

FLUX

To Order, Specify:

① Laminate Model #	② Laminate Type	③ Laminate Selection	④ Metal Color	⑤ Other Product Options
Laminate (FLT)	HPL	See Laminate Selection	See Metal Finish Color Options	See list of options for each specific unit; Specify and add accordingly.

① Veneer Model #	② Wood Collection	③ Wood Finish	④ Metal Color	⑤ Other Product Options	
Veneer (FLV)	Essentials	See Essentials Wood Finish Options	See Metal Finish Color Options	See list of options for each specific unit; Specify and add accordingly.	
	Artisan	<table border="1"> <thead> <tr> <th>ⓐ Wood Finish</th> <th>ⓑ Chassis Grain Direction</th> </tr> </thead> <tbody> <tr> <td>See Artisan Wood Finish Options</td> <td>For Artisan Only: Vertical Horizontal</td> </tr> </tbody> </table>			ⓐ Wood Finish
ⓐ Wood Finish	ⓑ Chassis Grain Direction				
See Artisan Wood Finish Options	For Artisan Only: Vertical Horizontal				

Description	D	W	H	CTN WT	CU FT	① Model	HPL Laminate	Essentials Veneer	Artisan Veneer
Lateral File and Open Storage Credenza	22	96	29	426	43	FLT2296-29F044	\$3,234		
	22	96	29	426	43	FLV2296-29F044		\$4,511	\$4,964
	22	96	29	436	43	FLT2296-29F440	\$3,234		
	22	96	29	436	43	FLV2296-29F440		\$4,511	\$4,964
	22	90	29	409	40	FLT2290-29F044	\$3,135		
	22	90	29	409	40	FLV2290-29F044		\$4,377	\$4,816
	22	90	29	409	40	FLT2290-29F440	\$3,135		
	22	90	29	409	40	FLV2290-29F440		\$4,377	\$4,816

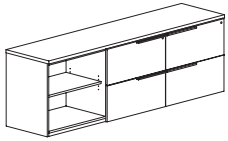

*044 shown

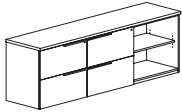

*440

Features:

- eased edge profile user side
- pedestal front locking
- open compartment with adjustable shelf
- shelf 12 1/2"d

Options:

- must specify chassis grain direction on artisan veneer, see pages 13-15 for details
- veneer drawer fronts in paint available, specify paint color and add \$354 list; see page 16 for details
- on laminate units, contrasting worksurface tops and drawer fronts available, no upcharge; specify color, see page 16 for details
- ledge pulls standard; prism pulls available, specify and see page 9
- oval grommets in back panel can be eliminated upon request, no upcharge
- interior horizontal wire manager with end grommets available, specify and add \$189 list; see page 40 for details
- top grommet available, specify location; add \$135 list each; see page 45 for details
- worksurface power available, specify "to accommodate EC26" on your purchase order; EC26 unit must be ordered separately, see page 45

Lateral File and Open Storage Credenza	22	72	29	295	32	FLT2272-29F04	\$2,492		
	22	72	29	295	32	FLV2272-29F04		\$3,479	\$3,827
	22	72	29	295	32	FLT2272-29F40	\$2,492		
	22	72	29	295	32	FLV2272-29F40		\$3,479	\$3,827
	22	66	29	273	30	FLT2266-29F04	\$2,370		
	22	66	29	273	30	FLV2266-29F04		\$3,306	\$3,636
	22	66	29	273	30	FLT2266-29F40	\$2,370		
	22	66	29	273	30	FLV2266-29F40		\$3,306	\$3,636
	22	60	29	256	27	FLT2260-29F04	\$2,252		
	22	60	29	256	27	FLV2260-29F04		\$3,139	\$3,454
22	60	29	256	27	FLT2260-29F40	\$2,252			
22	60	29	256	27	FLV2260-29F40		\$3,139	\$3,454	

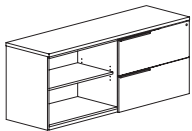

*04 shown

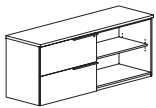

*40

Features:

- eased edge profile user side
- pedestal front locking
- open compartment with adjustable shelf
- shelf 12 1/2"d

Options:

- must specify chassis grain direction on artisan veneer, see pages 13-15 for details
- veneer drawer fronts in paint available, specify paint color and add \$354 list; see page 16 for details
- on laminate units, contrasting worksurface tops and drawer fronts available, no upcharge; specify color, see page 14 for details
- ledge pulls standard; prism pulls available, specify and see page 9
- oval grommets in back panel can be eliminated upon request, no upcharge
- interior horizontal wire manager with end grommets available, specify and add \$189 list; see page 40 for details
- top grommet available, specify location; add \$135 list each; see page 45 for details
- worksurface power available, specify "to accommodate EC26" on your purchase order; EC26 unit must be ordered separately, see page 44

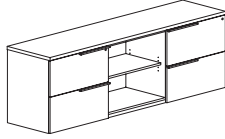
Description	D	W	H	CTN WT	CU FT	① Model	HPL Laminate	Essentials Veneer	Artisan Veneer
Lateral Files and Open Storage Credenza 	22	96	29	416	43	FLT2296-29F404	\$3,234		
	22	96	29	416	43	FLV2296-29F404		\$4,511	\$4,964
	22	90	29	399	40	FLT2290-29F404	\$3,135		
	22	90	29	399	40	FLV2290-29F404		\$4,377	\$4,816

Features:

- eased edge profile user side
- pedestal front locking
- open compartment with adjustable shelf
- shelf 12 1/2"d

Options:

- must specify chassis grain direction on artisan veneer, see pages 13-15 for details
- veneer drawer fronts in paint available, specify paint color and add \$354 list; see page 16 for details
- on laminate units, contrasting worksurface tops and drawer fronts available, no upcharge; specify color, see page 16 for details
- ledge pulls standard; prism pulls available, specify and see page 9
- oval grommets in back panel can be eliminated upon request, no upcharge
- interior horizontal wire manager with end grommets available, specify and add \$189 list; see page 40 for details
- top grommet available, specify location; add \$135 list each; see page 45 for details
- worksurface power available, specify "to accommodate EC26" on your purchase order; EC26 unit must be ordered separately, see page 45

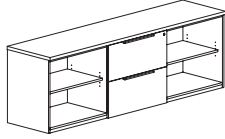
Description	D	W	H	CTN WT	CU FT	① Model	HPL Laminate	Essentials Veneer	Artisan Veneer
Lateral File and Open Storage Credenza 	22	96	29	375	43	FLT2296-29F040	\$2,998		
	22	96	29	375	43	FLV2296-29F040		\$4,186	\$4,604
	22	90	29	353	40	FLT2290-29F040	\$2,907		
	22	90	29	353	40	FLV2290-29F040		\$4,061	\$4,466

Features:

- eased edge profile user side
- pedestal front locking
- open compartment with adjustable shelf
- shelf 12 1/2"d

Options:

- must specify chassis grain direction on artisan veneer, see pages 13-15 for details
- veneer drawer fronts in paint available, specify paint color and add \$354 list; see page 16 for details
- on laminate units, contrasting worksurface tops and drawer fronts available, no upcharge; specify color, see page 16 for details
- ledge pulls standard; prism pulls available, specify and see page 9
- oval grommets in back panel can be eliminated upon request, no upcharge
- interior horizontal wire manager with end grommets available, specify and add \$189 list; see page 40 for details
- top grommet available, specify location; add \$135 list each; see page 45 for details
- worksurface power available, specify "to accommodate EC26" on your purchase order; EC26 unit must be ordered separately, see page 45

To Order, Specify:

① Laminate Model #	② Laminate Type	③ Laminate Selection	④ Metal Color	⑤ Other Product Options		
Laminate (FLT)	HPL	See Laminate Selection	See Metal Finish Color Options	See list of options for each specific unit; Specify and add accordingly.		
① Veneer Model #	② Wood Collection	③ Wood Finish	④ Metal Color	⑤ Other Product Options		
Veneer (FLV)	Essentials	See Essentials Wood Finish Options	See Metal Finish Color Options	See list of options for each specific unit; Specify and add accordingly.		
	Artisan	<table border="1"> <thead> <tr> <th>ⓐ Wood Finish</th> <th>ⓑ Chassis Grain Direction</th> </tr> </thead> <tbody> <tr> <td>See Artisan Wood Finish Options</td> <td>For Artisan Only: Vertical Horizontal</td> </tr> </tbody> </table>	ⓐ Wood Finish		ⓑ Chassis Grain Direction	See Artisan Wood Finish Options
ⓐ Wood Finish	ⓑ Chassis Grain Direction					
See Artisan Wood Finish Options	For Artisan Only: Vertical Horizontal					

Description	D	W	H	CTN WT	CU FT	① Model	HPL Laminate	Essentials Veneer	Artisan Veneer
Double Sliding Door Credenza	22	90	29	345	40	FLT2290-29F909	\$2,598		
	22	90	29	345	40	FLV2290-29F909		\$3,816	\$4,199

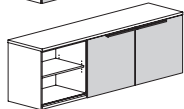
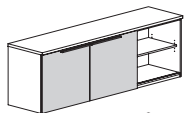
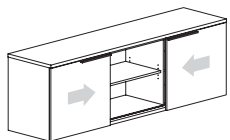

Features:

- eased edge profile user side
- locking doors not available
- each compartment has one adjustable shelf
- shelves 12 1/2" d

Options:

- must specify chassis grain direction on artisan veneer, see pages 13-15 for details
- veneer door fronts in paint available, specify paint color and add \$354 list; see page 16 for details
- on laminate units, contrasting worksurface tops and door fronts available, no upcharge; specify color, see page 16 for details
- ledge pulls standard; prism pulls available, specify and see page 9
- oval grommets in back panel can be eliminated upon request, no upcharge
- interior horizontal wire manager with end grommets available, specify and add \$189 list; see page 40 for details
- top grommet available, specify location; add \$135 list each; see page 45 for details
- worksurface power available, specify "to accommodate EC26" on your purchase order; EC26 unit must be ordered separately, see page 45

Sliding Door Credenza	22	90	29	327	40	FLT2290-29F090	\$2,468		
	22	90	29	327	40	FLV2290-29F090		\$3,626	\$3,986

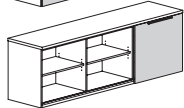
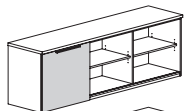
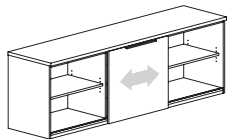

Features:

- eased edge profile user side
- locking doors not available
- each compartment has one adjustable shelf
- shelves 12 1/2" d

Options:

- must specify chassis grain direction on artisan veneer, see pages 13-15 for details
- veneer door fronts in paint available, specify paint color and add \$354 list; see page 16 for details
- on laminate units, contrasting worksurface tops and door fronts available, no upcharge; specify color, see page 16 for details
- ledge pulls standard; prism pulls available, specify and see page 9
- oval grommets in back panel can be eliminated upon request, no upcharge
- interior horizontal wire manager with end grommets available, specify and add \$189 list; see page 40 for details
- top grommet available, specify location; add \$135 list each; see page 45 for details
- worksurface power available, specify "to accommodate EC26" on your purchase order; EC26 unit must be ordered separately, see page 45

Description	D	W	H	CTN WT	CU FT	① Model	HPL Laminate	Essentials Veneer	Artisan Veneer
Sliding Door Credenza	22	72	29	268	32	FLT2272-29F09	\$2,171		
	22	72	29	268	32	FLV2272-29F09		\$3,191	\$3,511
	22	60	29	228	27	FLT2260-29F09	\$2,049		
	22	60	29	228	27	FLV2260-29F09		\$3,011	\$3,311

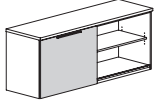
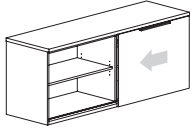

Features:

- eased edge profile user side
- locking doors not available
- each compartment has one adjustable shelf
- shelves 12 1/2"d

Options:

- must specify chassis grain direction on artisan veneer, see pages 13-15 for details
- veneer door fronts in paint available, specify paint color and add \$354 list; see page 16 for details
- on laminate units, contrasting worksurface tops and door fronts available, no upcharge; specify color, see page 16 for details
- ledge pulls standard; prism pulls available, specify and see page 9
- oval grommets in back panel can be eliminated upon request, no upcharge
- interior horizontal wire manager with end grommets available, specify and add \$189 list; see page 40 for details
- top grommet available, specify location; add \$135 list each; see page 45 for details
- worksurface power available, specify "to accommodate EC26" on your purchase order; EC26 unit must be ordered separately, see page 45

FLUX

To Order, Specify:

① Laminate Model #	② Laminate Type	③ Laminate Selection	④ Metal Color	⑤ Other Product Options		
Laminate (FLT)	HPL	See Laminate Selection	See Metal Finish Color Options	See list of options for each specific unit; Specify and add accordingly.		
① Veneer Model #	② Wood Collection	③ Wood Finish	④ Metal Color	⑤ Other Product Options		
Veneer (FLV)	Essentials	See Essentials Wood Finish Options	See Metal Finish Color Options	See list of options for each specific unit; Specify and add accordingly.		
	Artisan	<table border="1"> <thead> <tr> <th>ⓐ Wood Finish</th> <th>ⓑ Chassis Grain Direction</th> </tr> </thead> <tbody> <tr> <td>See Artisan Wood Finish Options</td> <td>For Artisan Only: Vertical Horizontal</td> </tr> </tbody> </table>	ⓐ Wood Finish		ⓑ Chassis Grain Direction	See Artisan Wood Finish Options
ⓐ Wood Finish	ⓑ Chassis Grain Direction					
See Artisan Wood Finish Options	For Artisan Only: Vertical Horizontal					

Description	D	W	H	CTN WT	CU FT	① Model	HPL Laminate	Essentials Veneer	Artisan Veneer
Open Compartment Credenza	22	96	29	325	43	FLT2296-29F000	\$2,308		
	22	96	29	325	43	FLV2296-29F000		\$3,392	\$3,732
	22	90	29	308	40	FLT2290-29F000	\$2,241		
	22	90	29	308	40	FLV2290-29F000		\$3,293	\$3,625

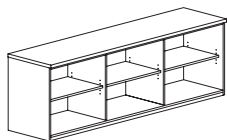

Features:

- eased edge profile user side
- each open compartment has one adjustable shelf
- shelves 12 1/2" d

Options:

- must specify chassis grain direction on artisan veneer, see pages 13-15 for details
- contrasting laminate worksurface tops, no upcharge; specify laminate color, see page 16 for details
- oval grommets in back panel can be eliminated upon request, no upcharge
- interior horizontal wire manager with end grommets available, specify and add \$189 list; see page 40 for details
- top grommet available, specify location and add \$135 list each; see page 45 for details
- worksurface power available, specify "to accommodate EC26" on your purchase order; EC26 unit must be ordered separately, see page 45

Open Compartment Credenza	22	72	29	245	32	FLT2272-29F00	\$2,043		
	22	72	29	245	32	FLV2272-29F00		\$3,005	\$3,304
	22	60	29	210	27	FLT2260-29F00	\$1,928		
	22	60	29	210	27	FLV2260-29F00		\$2,831	\$3,116

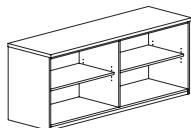

Features:

- eased edge profile user side
- each open compartment has one adjustable shelf
- shelves 12 1/2" d

Options:

- must specify chassis grain direction on artisan veneer, see pages 13-15 for details
- contrasting laminate worksurface tops, no upcharge; specify laminate color, see page 16 for details
- oval grommets in back panel can be eliminated upon request, no upcharge
- interior horizontal wire manager with end grommets available, specify and add \$189 list; see page 40 for details
- top grommet available, specify location and add \$135 list each; see page 45 for details
- worksurface power available, specify "to accommodate EC26" on your purchase order; EC26 unit must be ordered separately, see page 45

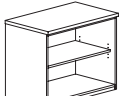
Description	D	W	H	CTN WT	CU FT	① Model	HPL Laminate	Essentials Veneer	Artisan Veneer
 Open Compartment	22	36	29	131	17	FLT2236-29F0	\$1,306		
	22	36	29	131	17	FLV2236-29F0		\$1,916	\$2,106
	22	30	29	113	14	FLT2230-29F0	\$1,254		
	22	30	29	113	14	FLV2230-29F0		\$1,843	\$2,028

Features:

- eased edge profile user side
- open compartment with adjustable shelf
- shelf 12 1/2" d

Options:

- must specify chassis grain direction on artisan veneer, see pages 13-15 for details
- contrasting laminate worksurface tops, no upcharge; specify laminate color, see page 16 for details
- oval grommet in back panel can be eliminated upon request, no upcharge
- top grommet available, specify location; add \$135 list each; see page 45 for details
- worksurface power available, specify "to accommodate EC26" on your purchase order; EC26 unit must be ordered separately, see page 45

FLUX

To Order, Specify:

① Laminate Model #	② Laminate Type	③ Laminate Selection		④ Metal Color	⑤ Other Product Options
Laminate (FLT)	HPL	See Laminate Selection		See Metal Finish Color Options	See list of options for each specific unit; Specify and add accordingly.
① Veneer Model #	② Wood Collection	③ Wood Finish		④ Metal Color	⑤ Other Product Options
Veneer (FLV)	Essentials	See Essentials Wood Finish Options		See Metal Finish Color Options	See list of options for each specific unit; Specify and add accordingly.
	Artisan	ⓐ Wood Finish See Artisan Wood Finish Options	ⓑ Chassis Grain Direction For Artisan Only: Vertical Horizontal		

Description	D	W	H	CTN WT	CU FT	① Model	HPL Laminate	Essentials Veneer	Artisan Veneer
Split Top Lateral File	22	96	29	336	43	FLT2296-29F4K4ST	\$3,738		
Kneespace Credenza	22	96	29	336	43	FLV2296-29F4K4ST		\$5,102	\$5,613
	22	90	29	328	40	FLT2290-29F4K4ST	\$3,653		
	22	90	29	328	40	FLV2290-29F4K4ST		\$4,984	\$5,487

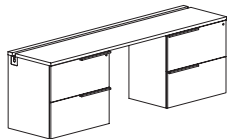

modesty panel options:

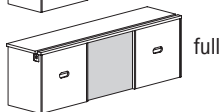
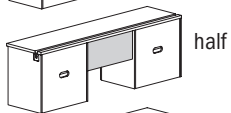
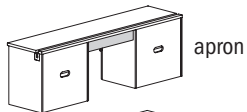

Features:

- eased edge profile user side
- built in horizontal wire channel
- 5”h back apron rail standard in kneespace
- pedestal front locking

Options:

- must specify chassis grain direction on artisan veneer, see pages 13-15 for details
- fixed half or full modesty panel available, specify style; add \$170 list for laminate panel or \$212 list for veneer panel, see page 25 for details
- removable modesty panel available, specify; add \$258 list for laminate or \$341 for veneer panel, see page 25 for details
- veneer drawer fronts in paint available, specify paint color and add \$354 list; see page 16 for details
- on laminate units, contrasting worksurface tops and drawer fronts available, no upcharge; specify color, see page 16 for details
- ledge pulls standard; prism pulls available, specify and see page 9

Description	D	W	H	CTN WT	CU FT	① Model	HPL Laminate	Essentials Veneer	Artisan Veneer
Lateral File Kneespace Credenza	22	96	29	343	43	FLT2296-29F4K4	\$3,449		
	22	96	29	343	43	FLV2296-29F4K4		\$4,814	\$5,295
	22	90	29	235	40	FLT2290-29F4K4	\$3,365		
	22	90	29	235	40	FLV2290-29F4K4		\$4,697	\$5,166

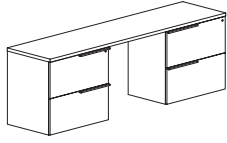

modesty panel options:

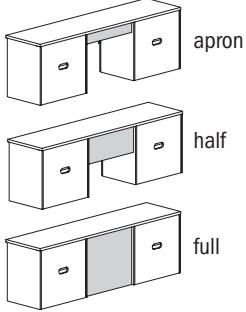

Features:

- eased edge profile user side
- 5”h back apron rail standard in kneespace
- pedestal front locking



Options:

- must specify chassis grain direction on artisan veneer, see pages 13-15 for details
- fixed half or full modesty panel available, specify style; add \$170 list for laminate panel or \$212 list for veneer panel, see page 25 for details
- removable modesty panel available, specify; add \$258 list for laminate or \$341 for veneer panel, see page 25 for details
- veneer drawer fronts in paint available, specify paint color and add \$354 list; see page 16 for details
- on laminate units, contrasting worksurface tops and drawer fronts available, no upcharge; specify color, see page 16 for details
- ledge pulls standard; prism pulls available, specify and see page 9
- interior horizontal wire manager with end grommets available, specify and add \$189 list; see page 40 for details
- top grommet available, specify location; add \$135 list each; see page 45 for details
- worksurface power available, specify “to accommodate EC26” on your purchase order; EC26 unit must be ordered separately, see page 45

FLUX

To Order, Specify:

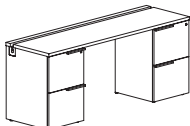
① Laminate Model #	② Laminate Type	③ Laminate Selection	④ Metal Color	⑤ Other Product Options
Laminate (FLT)	HPL	See Laminate Selection	See Metal Finish Color Options	See list of options for each specific unit; Specify and add accordingly.
① Veneer Model #	② Wood Collection	③ Wood Finish	④ Metal Color	⑤ Other Product Options
Veneer (FLV)	Essentials	See Essentials Wood Finish Options	See Metal Finish Color Options	See list of options for each specific unit; Specify and add accordingly.
	Artisan	See Artisan Wood Finish Options	④b Chassis Grain Direction For Artisan Only: Vertical Horizontal	

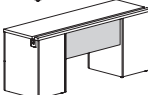
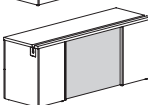
Description	D	W	H	CTN WT	CU FT	① Model	HPL Laminate	Essentials Veneer	Artisan Veneer
Split Top File/File	22	84	29	261	38	FLT2284-29F2K2ST	\$3,231		
Kneespace Credenza	22	84	29	261	38	FLV2284-29F2K2ST		\$4,395	\$4,834
	22	78	29	253	35	FLT2278-29F2K2ST	\$3,159		
	22	78	29	253	35	FLV2278-29F2K2ST		\$4,294	\$4,724
	22	72	29	245	32	FLT2272-29F2K2ST	\$3,089		
	22	72	29	245	32	FLV2272-29F2K2ST		\$4,197	\$4,616
	22	66	29	227	30	FLT2266-29F2K2ST	\$3,018		
modesty panel options:	22	66	29	227	30	FLV2266-29F2K2ST		\$4,100	\$4,509
 apron	22	60	29	219	27	FLT2260-29F2K2ST	\$2,949		
 half	22	60	29	219	27	FLV2260-29F2K2ST		\$4,003	\$4,404
 full									

Features:

- eased edge profile user side
- built in horizontal wire channel
- 5”h back apron rail standard in kneespace
- pedestal front locking

Options:

- must specify chassis grain direction on artisan veneer, see pages 13-15 for details
- fixed half or full modesty panel available, specify style; add \$170 list for laminate panel or \$212 list for veneer panel, see page 25 for details
- removable modesty panel available, specify; add \$258 list for laminate or \$341 for veneer panel, see page 25 for details
- veneer drawer fronts in paint available, specify paint color and add \$354 list; see page 16 for details
- on laminate units, contrasting worksurface tops and drawer fronts available, no upcharge; specify color, see page 16 for details
- ledge pulls standard; prism pulls available, specify and see page 9

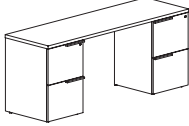
Description	D	W	H	CTN WT	CU FT	① Model	HPL Laminate	Essentials Veneer	Artisan Veneer
File/File Kneespace Credenza 	22	84	29	265	38	FLT2284-29F2K2	\$2,942		
	22	84	29	265	38	FLV2284-29F2K2		\$4,106	\$4,514
	22	78	29	257	35	FLT2278-29F2K2	\$2,870		
	22	78	29	257	35	FLV2278-29F2K2		\$4,004	\$4,405
	22	72	29	249	32	FLT2272-29F2K2	\$2,801		
	22	72	29	249	32	FLV2272-29F2K2		\$3,906	\$4,298
	22	66	29	230	30	FLT2266-29F2K2	\$2,732		
	22	66	29	230	30	FLV2266-29F2K2		\$3,811	\$4,192
	22	60	29	222	27	FLT2260-29F2K2	\$2,659		
	22	60	29	222	27	FLV2260-29F2K2		\$3,713	\$4,086

modesty panel options:

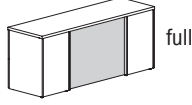
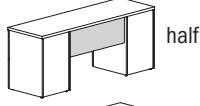
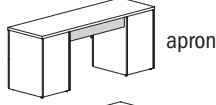

Features:

- eased edge profile user side
- 5”h back apron rail standard in kneespace
- pedestal front locking

Options:

- must specify chassis grain direction on artisan veneer, see pages 13-15 for details
- fixed half or full modesty panel available, specify style; add \$170 list for laminate panel or \$212 list for veneer panel, see page 25 for details
- removable modesty panel available, specify; add \$258 list for laminate or \$341 for veneer panel, see page 25 for details
- veneer drawer fronts in paint available, specify paint color and add \$354 list; see page 16 for details
- on laminate units, contrasting worksurface tops and drawer fronts available, no upcharge; specify color, see page 16 for details
- ledge pulls standard; prism pulls available, specify and see page 9
- interior horizontal wire manager with end grommets available, specify and add \$189 list; see page 40 for details
- top grommet available, specify location; add \$135 list each; see page 45 for details
- worksurface power available, specify “to accommodate EC26” on your purchase order; EC26 unit must be ordered separately, see page 45

To Order, Specify:

① Laminate Model #	② Laminate Type	③ Laminate Selection	④ Metal Color	⑤ Other Product Options		
Laminate (FLT)	HPL	See Laminate Selection	See Metal Finish Color Options	See list of options for each specific unit; Specify and add accordingly.		
① Veneer Model #	② Wood Collection	③ Wood Finish	④ Metal Color	⑤ Other Product Options		
Veneer (FLV)	Essentials	See Essentials Wood Finish Options	See Metal Finish Color Options	See list of options for each specific unit; Specify and add accordingly.		
	Artisan	<table border="1"> <thead> <tr> <th>ⓐ Wood Finish</th> <th>ⓑ Chassis Grain Direction</th> </tr> </thead> <tbody> <tr> <td>See Artisan Wood Finish Options</td> <td>For Artisan Only: Vertical Horizontal</td> </tr> </tbody> </table>	ⓐ Wood Finish		ⓑ Chassis Grain Direction	See Artisan Wood Finish Options
ⓐ Wood Finish	ⓑ Chassis Grain Direction					
See Artisan Wood Finish Options	For Artisan Only: Vertical Horizontal					

FLUX

Description	D	W	H	CTN WT	CU FT	① Model	HPL Laminate	Essentials Veneer	Artisan Veneer
Lateral File Pedestal Credenza with Continuous Wire Channel - Split Top	22	96	29	269	43	FLT2296-29FK4ST	\$2,852		
	22	96	29	269	43	FLV2296-29FK4ST		\$3,866	\$4,252
	22	96	29	269	43	FLT2296-29F4KST	\$2,852		
	22	96	29	269	43	FLV2296-29F4KST		\$3,866	\$4,252
	22	90	29	261	40	FLT2290-29FK4ST	\$2,775		
	22	90	29	261	40	FLV2290-29FK4ST		\$3,762	\$4,136
	22	90	29	261	40	FLT2290-29F4KST	\$2,775		
	22	90	29	261	40	FLV2290-29F4KST		\$3,762	\$4,136
	22	84	29	254	38	FLT2284-29FK4ST	\$2,700		
	22	84	29	254	38	FLV2284-29FK4ST		\$3,654	\$4,022
	22	84	29	254	38	FLT2284-29F4KST	\$2,700		
	22	84	29	254	38	FLV2284-29F4KST		\$3,654	\$4,022
	22	78	29	246	35	FLT2278-29FK4ST	\$2,629		
	22	78	29	246	35	FLV2278-29FK4ST		\$3,556	\$3,910
	22	78	29	246	35	FLT2278-29F4KST	\$2,629		
	22	78	29	246	35	FLV2278-29F4KST		\$3,556	\$3,910
	22	72	29	238	32	FLT2272-29FK4ST	\$2,558		
	22	72	29	238	32	FLV2272-29FK4ST		\$3,457	\$3,804
22	72	29	238	32	FLT2272-29F4KST	\$2,558			
22	72	29	238	32	FLV2272-29F4KST		\$3,457	\$3,804	

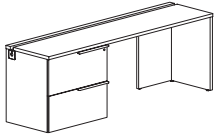

*4KST shown

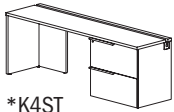

*K4ST

modesty panel options:

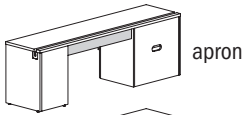

apron

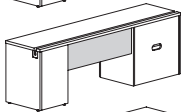

half

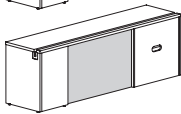

full

Features:

- eased edge profile user side
- built in horizontal wire channel
- 5”h back apron rail standard in kneespace
- pedestal front locking

Options:

- must specify chassis grain direction on artisan veneer, see pages 13-15 for details
- fixed half or full modesty panel available, specify style; add \$170 list for laminate panel or \$212 list for veneer panel, see page 25 for details
- removable modesty panel available, specify; add \$258 list for laminate or \$341 for veneer panel, see page 25 for details
- veneer drawer fronts in paint available, specify paint color and add \$354 list; see page 16 for details
- on laminate units, contrasting worksurface tops and drawer fronts available, no upcharge; specify color, see page 16 for details
- ledge pulls standard; prism pulls available, specify and see page 9
- knee clearance end panel available 13” depth, specify; no upcharge

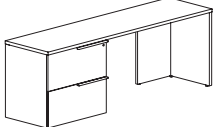
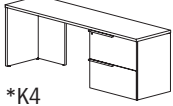
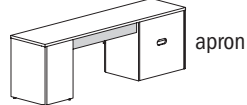
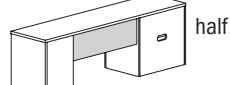
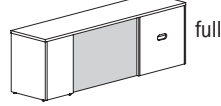
Description	D	W	H	CTN WT	CU FT	① Model	HPL Laminate	Essentials Veneer	Artisan Veneer
 <p>*4K shown</p>  <p>*K4</p> <p>modesty panel options:</p>  <p>apron</p>  <p>half</p>  <p>full</p>	22	96	29	275	43	FLT2296-29FK4	\$2,562		
	22	96	29	275	43	FLV2296-29FK4		\$3,577	\$3,935
	22	96	29	275	43	FLT2296-29F4K	\$2,562		
	22	96	29	275	43	FLV2296-29F4K		\$3,577	\$3,935
	22	90	29	267	40	FLT2290-29FK4	\$2,486		
	22	90	29	267	40	FLV2290-29FK4		\$3,472	\$3,818
	22	90	29	267	40	FLT2290-29F4K	\$2,486		
	22	90	29	267	40	FLV2290-29F4K		\$3,472	\$3,818
	22	84	29	259	38	FLT2284-29FK4	\$2,411		
	22	84	29	259	38	FLV2284-29FK4		\$3,366	\$3,703
	22	84	29	259	38	FLT2284-29F4K	\$2,411		
	22	84	29	259	38	FLV2284-29F4K		\$3,366	\$3,703
	22	78	29	251	35	FLT2278-29FK4	\$2,341		
	22	78	29	251	35	FLV2278-29FK4		\$3,266	\$3,594
	22	78	29	251	35	FLT2278-29F4K	\$2,341		
	22	78	29	251	35	FLV2278-29F4K		\$3,266	\$3,594
	22	72	29	243	32	FLT2272-29FK4	\$2,270		
	22	72	29	243	32	FLV2272-29FK4		\$3,168	\$3,483
22	72	29	243	32	FLT2272-29F4K	\$2,270			
22	72	29	243	32	FLV2272-29F4K		\$3,168	\$3,483	

Features:

- eased edge profile user side
- 5”h back apron rail standard in kneespace
- pedestal front locking

Options:

- must specify chassis grain direction on artisan veneer, see pages 13-15 for details
- fixed half or full modesty panel available, specify style; add \$170 list for laminate panel or \$212 list for veneer panel, see page 25 for details
- removable modesty panel available, specify; add \$258 list for laminate or \$341 for veneer panel, see page 25 for details
- veneer drawer fronts in paint available, specify paint color and add \$354 list; see page 16 for details
- on laminate units, contrasting worksurface tops and drawer fronts available, no upcharge; specify color, see page 16 for details
- ledge pulls standard; prism pulls available, specify and see page 9
- interior horizontal wire manager with end grommets available, specify and add \$189 list; see page 40 for details
- top grommet available, specify location; add \$135 list each; see page 45 for details
- worksurface power available, specify “to accommodate EC26” on your purchase order; EC26 unit must be ordered separately, see page 45
- knee clearance end panel available 13” depth, specify; no upcharge

To Order, Specify:

① Laminate Model #	② Laminate Type	③ Laminate Selection	④ Metal Color	⑤ Other Product Options		
Laminate (FLT)	HPL	See Laminate Selection	See Metal Finish Color Options	See list of options for each specific unit; Specify and add accordingly.		
① Veneer Model #	② Wood Collection	③ Wood Finish	④ Metal Color	⑤ Other Product Options		
Veneer (FLV)	Essentials	See Essentials Wood Finish Options	See Metal Finish Color Options	See list of options for each specific unit; Specify and add accordingly.		
	Artisan	<table border="1"> <tr> <th>ⓐ Wood Finish</th> <th>ⓑ Chassis Grain Direction</th> </tr> <tr> <td>See Artisan Wood Finish Options</td> <td>For Artisan Only: Vertical Horizontal</td> </tr> </table>	ⓐ Wood Finish		ⓑ Chassis Grain Direction	See Artisan Wood Finish Options
ⓐ Wood Finish	ⓑ Chassis Grain Direction					
See Artisan Wood Finish Options	For Artisan Only: Vertical Horizontal					

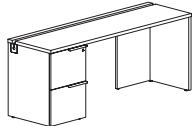
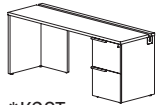
Description	D	W	H	CTN WT	CU FT	① Model	HPL Laminate	Essentials Veneer	Artisan Veneer
File/File Pedestal Credenza with Continuous Wire Channel - Split Top	22	84	29	224	38	FLT2284-29FK2ST	\$2,549		
	22	84	29	224	38	FLV2284-29FK2ST		\$3,442	\$3,787
 *2KST shown	22	84	29	224	38	FLT2284-29F2KST	\$2,549		
	22	84	29	224	38	FLV2284-29F2KST		\$3,442	\$3,787
	22	78	29	216	35	FLT2278-29FK2ST	\$2,481		
	22	78	29	216	35	FLV2278-29FK2ST		\$3,350	\$3,685
	22	78	29	216	35	FLT2278-29F2KST	\$2,481		
	22	78	29	216	35	FLV2278-29F2KST		\$3,350	\$3,685
	22	72	29	208	32	FLT2272-29FK2ST	\$2,417		
	22	72	29	208	32	FLV2272-29FK2ST		\$3,254	\$3,583
	22	72	29	208	32	FLT2272-29F2KST	\$2,417		
	22	72	29	208	32	FLV2272-29F2KST		\$3,254	\$3,583
 *K2ST	22	66	29	193	30	FLT2266-29FK2ST	\$2,351		
	22	66	29	193	30	FLV2266-29FK2ST		\$3,168	\$3,483
	22	66	29	193	30	FLT2266-29F2KST	\$2,351		
	22	66	29	193	30	FLV2266-29F2KST		\$3,168	\$3,483
	22	60	29	185	27	FLT2260-29FK2ST	\$2,289		
	22	60	29	185	27	FLV2260-29FK2ST		\$3,082	\$3,389
	22	60	29	185	27	FLT2260-29F2KST	\$2,289		
	22	60	29	185	27	FLV2260-29F2KST		\$3,082	\$3,389

modesty panel options:

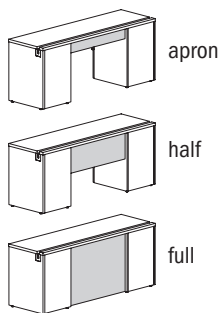

Features:

- eased edge profile user side
- built in horizontal wire channel
- 5”h back apron rail standard in kneespace
- pedestal front locking

Options:

- must specify chassis grain direction on artisan veneer, see pages 13-15 for details
- fixed half or full modesty panel available, specify style; add \$170 list for laminate panel or \$212 list for veneer panel, see page 25 for details
- removable modesty panel available, specify; add \$258 list for laminate or \$341 for veneer panel, see page 25 for details
- veneer drawer fronts in paint available, specify paint color and add \$354 list; see page 16 for details
- on laminate units, contrasting worksurface tops and drawer fronts available, no upcharge; specify color, see page 16 for details
- ledge pulls standard; prism pulls available, specify and see page 9
- knee clearance end panel available 13” depth, specify; no upcharge

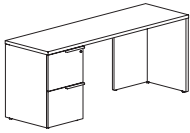
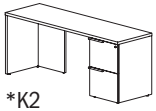
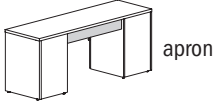
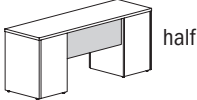
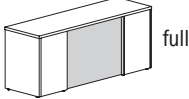
Description	D	W	H	CTN WT	CU FT	① Model	HPL Laminate	Essentials Veneer	Artisan Veneer
 <p>*2K shown</p>  <p>*K2</p> <p>modesty panel options:</p>  <p>apron</p>  <p>half</p>  <p>full</p>	22	84	29	228	38	FLT2284-29FK2	\$2,258		
	22	84	29	228	38	FLV2284-29FK2		\$3,156	\$3,471
	22	84	29	228	38	FLT2284-29F2K	\$2,258		
	22	84	29	228	38	FLV2284-29F2K		\$3,156	\$3,471
	22	78	29	220	35	FLT2278-29FK2	\$2,191		
	22	78	29	220	35	FLV2278-29FK2		\$3,059	\$3,366
	22	78	29	220	35	FLT2278-29F2K	\$2,191		
	22	78	29	220	35	FLV2278-29F2K		\$3,059	\$3,366
	22	72	29	212	32	FLT2272-29FK2	\$2,127		
	22	72	29	212	32	FLV2272-29FK2		\$2,968	\$3,265
	22	72	29	212	32	FLT2272-29F2K	\$2,127		
	22	72	29	212	32	FLV2272-29F2K		\$2,968	\$3,265
	22	66	29	200	30	FLT2266-29FK2	\$2,061		
	22	66	29	200	30	FLV2266-29FK2		\$2,881	\$3,167
	22	66	29	200	30	FLT2266-29F2K	\$2,061		
	22	66	29	200	30	FLV2266-29F2K		\$2,881	\$3,167
	22	60	29	192	27	FLT2260-29FK2	\$2,002		
	22	60	29	192	27	FLV2260-29FK2		\$2,790	\$3,074
22	60	29	192	27	FLT2260-29F2K	\$2,002			
22	60	29	192	27	FLV2260-29F2K		\$2,790	\$3,074	

Features:

- eased edge profile user side
- 5”h back apron rail standard in kneespace
- pedestal front locking

Options:

- must specify chassis grain direction on artisan veneer, see pages 13-15 for details
- fixed half or full modesty panel available, specify style; add \$170 list for laminate panel or \$212 list for veneer panel, see page 25 for details
- removable modesty panel available, specify; add \$258 list for laminate or \$341 for veneer panel, see page 25 for details
- veneer drawer fronts in paint available, specify paint color and add \$354 list; see page 16 for details
- on laminate units, contrasting worksurface tops and drawer fronts available, no upcharge; specify color, see page 16 for details
- ledge pulls standard; prism pulls available, specify and see page 9
- interior horizontal wire manager with end grommets available, specify and add \$189 list; see page 40 for details
- top grommet available, specify location; add \$135 list each; see page 45 for details
- worksurface power available, specify “to accommodate EC26” on your purchase order; EC26 unit must be ordered separately, see page 45
- knee clearance end panel available 13” depth, specify; no upcharge

To Order, Specify:

① Laminate Model #	② Laminate Type	③ Laminate Selection	④ Metal Color	⑤ Other Product Options		
Laminate (FLT)	HPL	See Laminate Selection	See Metal Finish Color Options	See list of options for each specific unit; Specify and add accordingly.		
① Veneer Model #	② Wood Collection	③ Wood Finish	④ Metal Color	⑤ Other Product Options		
Veneer (FLV)	Essentials	See Essentials Wood Finish Options	See Metal Finish Color Options	See list of options for each specific unit; Specify and add accordingly.		
	Artisan	<table border="1"> <tr> <th>ⓐ Wood Finish</th> <th>ⓑ Chassis Grain Direction</th> </tr> <tr> <td>See Artisan Wood Finish Options</td> <td>For Artisan Only: Vertical Horizontal</td> </tr> </table>	ⓐ Wood Finish		ⓑ Chassis Grain Direction	See Artisan Wood Finish Options
ⓐ Wood Finish	ⓑ Chassis Grain Direction					
See Artisan Wood Finish Options	For Artisan Only: Vertical Horizontal					

Description	D	W	H	CTN WT	CU FT	① Model	HPL Laminate	Essentials Veneer	Artisan Veneer
Credenza Shell	22	72	29	151	32	FLT2272-29FK	\$1,439		
	22	72	29	151	32	FLV2272-29FK		\$2,177	\$2,394
	22	66	29	142	30	FLT2266-29FK	\$1,396		
	22	66	29	142	30	FLV2266-29FK		\$2,114	\$2,324

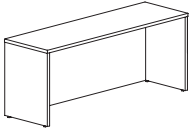

Features:

- freestanding shell, modular pedestal units below and on the following two pages may be ordered: see page 39 for details
- eased edge profile user side

Options:

- must specify chassis grain direction on artisan veneer, see pages 13-15 for details
- top grommet available, specify location and add \$135 list each; see page 46 for details

Modular File/File Credenza Shell Pedestal	20 ¹⁵ / ₁₆	18	28	74	9	FLT2118-CSM2	\$1,173		
	20 ¹⁵ / ₁₆	18	28	74	9	FLV2118-CSM2		\$1,759	\$1,938
	20 ¹⁵ / ₁₆	15 ⁵ / ₈	28	74	9	FLT2116-CSM2	\$1,160		
	20 ¹⁵ / ₁₆	15 ⁵ / ₈	28	74	9	FLV2116-CSM2		\$1,741	\$1,915



Features:

- use inside of credenza shells or return shells, see page 39
- pedestal front locking

Options:

- must specify chassis grain direction on artisan veneer, see pages 13-15 for details
- veneer drawer fronts in paint available, specify paint color and add \$354 list; see page 16 for details
- on laminate units, contrasting fronts available, no upcharge; specify color, see page 16 for details
- ledge pulls standard; prism pulls available, specify and see page 9

Modular Box/Box/File Credenza Shell Pedestal	20 ¹⁵ / ₁₆	18	28	87	9	FLT2118-CSM1	\$1,179		
	20 ¹⁵ / ₁₆	18	28	87	9	FLV2118-CSM1		\$1,770	\$1,947
	20 ¹⁵ / ₁₆	15 ⁵ / ₈	28	80	8	FLT2116-CSM1	\$1,165		
	20 ¹⁵ / ₁₆	15 ⁵ / ₈	28	80	8	FLV2116-CSM1		\$1,749	\$1,922



Features:

- use inside of credenza shells or return shells, see page 39
- pedestal front locking

Options:

- must specify chassis grain direction on artisan veneer, see pages 13-15 for details
- veneer drawer fronts in paint available, specify paint color and add \$354 list; see page 16 for details
- on laminate units, contrasting fronts available, no upcharge; specify color, see page 16 for details
- ledge pulls standard; prism pulls available, specify and see page 9

Modular Hinge Door Shell Storage Pedestal	20 ¹⁵ / ₁₆	18	28	68	8	FLT2118-CSM7R	\$725		
	20 ¹⁵ / ₁₆	18	28	68	8	FLV2118-CSM7R		\$1,090	\$1,199
	20 ¹⁵ / ₁₆	18	28	68	8	FLT2118-CSM7L	\$725		
	20 ¹⁵ / ₁₆	18	28	68	8	FLV2118-CSM7L		\$1,090	\$1,199
	20 ¹⁵ / ₁₆	15 ⁵ / ₈	28	141	16	FLT2116-CSM7R	\$713		
	20 ¹⁵ / ₁₆	15 ⁵ / ₈	28	141	16	FLV2116-CSM7R		\$1,069	\$1,176
	20 ¹⁵ / ₁₆	15 ⁵ / ₈	28	129	14	FLT2116-CSM7L	\$713		
	20 ¹⁵ / ₁₆	15 ⁵ / ₈	28	129	14	FLV2116-CSM7L		\$1,069	\$1,176

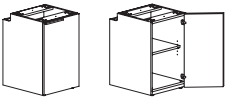

right shown

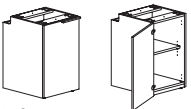

left

Features:

- use inside of credenza shells or return shells, see page 39

Options:

- hinged door compartment has one adjustable shelf
- must specify chassis grain direction on artisan veneer, see pages 13-15 for details
- locking door available, specify and add \$147 list
- veneer door fronts in paint available, specify paint color and add \$354 list; see page 16 for details
- on laminate units, contrasting fronts available, no upcharge; specify color, see page 16 for details
- ledge pulls standard; prism pulls available, specify and see page 9

Description	D	W	H	CTN WT	CU FT	① Model	HPL Laminate	Essentials Veneer	Artisan Veneer
Modular Lateral Credenza	20 ¹⁵ / ₁₆	36	28	141	16	FLT2136-CSM4	\$1,426		
Shell Pedestal	20 ¹⁵ / ₁₆	36	28	141	16	FLV2136-CSM4		\$2,138	\$2,352
	20 ¹⁵ / ₁₆	30	28	128	14	FLT2130-CSM4	\$1,390		
	20 ¹⁵ / ₁₆	30	28	128	14	FLV2130-CSM4		\$2,085	\$2,296

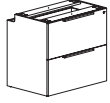

Features:

- use inside of credenza shells or return shells, see page 39
- pedestal front locking

Options:

- must specify chassis grain direction on artisan veneer, see pages 13-15 for details
- veneer drawer fronts in paint available, specify paint color and add \$354 list; see page 16 for details
- on laminate units, contrasting fronts available, no upcharge; specify color, see page 16 for details
- ledge pulls standard; prism pulls available, specify and see page 9

Modular Lateral Credenza	20 ¹⁵ / ₁₆	36	28	141	16	FLT2136-CSM3	\$1,433		
Shell Pedestal	20 ¹⁵ / ₁₆	36	28	141	16	FLV2136-CSM3		\$2,150	\$2,365
	20 ¹⁵ / ₁₆	30	28	128	14	FLT2130-CSM3	\$1,396		
	20 ¹⁵ / ₁₆	30	28	128	14	FLV2130-CSM3		\$2,096	\$2,307



Features:

- use inside of credenza shells or return shells, see page 39
- pedestal front locking

Options:

- must specify chassis grain direction on artisan veneer, see pages 13-15 for details
- veneer drawer fronts in paint available, specify paint color and add \$354 list; see page 16 for details
- on laminate units, contrasting fronts available, no upcharge; specify color, see page 16 for details
- ledge pulls standard; prism pulls available, specify and see page 9

FLUX

To Order, Specify:

① Laminate Model #	② Laminate Type	③ Laminate Selection	④ Metal Color	⑤ Other Product Options
Laminate (FLT)	HPL	See Laminate Selection	See Metal Finish Color Options	See list of options for each specific unit; Specify and add accordingly.
① Veneer Model #	② Wood Collection	③ Wood Finish	④ Metal Color	⑤ Other Product Options
Veneer (FLV)	Essentials	See Essentials Wood Finish Options	See Metal Finish Color Options	See list of options for each specific unit; Specify and add accordingly.
	Artisan	See Artisan Wood Finish Options		

Description	D	W	H	CTN WT	CU FT	① Model	HPL Laminate	Essentials Veneer	Artisan Veneer
Modular Credenza Shell	20 15/16	30	28	138	14	FLT2130-CSMRM	\$1,510		
Multi-File Pedestal	20 15/16	30	28	138	14	FLV2130-CSMRM		\$2,268	\$2,495
	20 15/16	30	28	138	14	FLT2130-CSMLM	\$1,510		
	20 15/16	30	28	138	14	FLV2130-CSMLM		\$2,268	\$2,495



right shown



left

Features:

- use inside of credenza shells or return shells, see page 39
- pedestal front locking

Options:

- must specify chassis grain direction on artisan veneer, see pages 13-15 for details
- veneer drawer fronts in paint available, specify paint color and add \$354 list; see page 16 for details
- on laminate units, contrasting fronts available, no upcharge; specify color, see page 16 for details
- ledge pulls standard; prism pulls available, specify and see page 9

Modular Hinge Door Credenza Shell Pedestal	20 15/16	36	28	122	16	FLT2136-CSM7	\$1,209		
	20 15/16	36	28	122	16	FLV2136-CSM7		\$1,815	\$1,993
	20 15/16	30	28	108	14	FLT2130-CSM7	\$1,160		
	20 15/16	30	28	108	14	FLV2130-CSM7		\$1,742	\$1,916

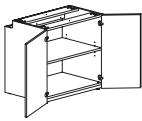
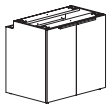

Features:

- use inside of credenza shells or return shells, see page 39
- hinged door compartment has one adjustable shelf

Options:

- must specify chassis grain direction on artisan veneer, see pages 13-15 for details
- locking doors available, specify and add \$147 list
- veneer door fronts in paint available, specify paint color and add \$354 list; see page 16 for details
- on laminate units, contrasting laminate door fronts available, no upcharge; specify laminate color, see page 16 for details
- ledge pulls standard; prism pulls available, specify and see page 9

Modular Hinge Door Credenza Shell Pedestal	20 15/16	36	28	132	16	FLT2136-CSM8	\$1,227		
	20 15/16	36	28	132	16	FLV2136-CSM8		\$1,841	\$2,027
	20 15/16	30	28	116	14	FLT2130-CSM8	\$1,180		
	20 15/16	30	28	116	14	FLV2130-CSM8		\$1,773	\$1,949

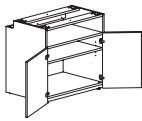
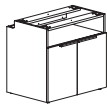

Features:

- use inside of credenza shells or return shells, see page 39
- hinged door compartment has one adjustable shelf

Options:

- must specify chassis grain direction on artisan veneer, see pages 13-15 for details
- locking doors available, specify and add \$147 list
- veneer door fronts in paint available, specify paint color and add \$354 list; see page 16 for details
- on laminate units, contrasting laminate door fronts available, no upcharge; specify laminate color, see page 16 for details
- ledge pulls standard; prism pulls available, specify and see page 9

Modular Open Credenza Shell Compartment	20 15/16	36	28	101	16	FLT2136-CSMO	\$1,070		
	20 15/16	36	28	101	16	FLV2136-CSMO		\$1,607	\$1,769
	20 15/16	30	28	91	14	FLT2130-CSMO	\$1,045		
	20 15/16	30	28	91	14	FLV2130-CSMO		\$1,568	\$1,725



Features:

- use inside of credenza shells or return shells, see page 39
- compartment has one adjustable shelf

Options:

- must specify chassis grain direction on artisan veneer, see pages 13-15 for details

Description	D	W	H	CTN WT	CU FT	① Model	HPL Laminate	Essentials Veneer	Artisan Veneer
Mobile Pedestal	18	15½	25	91	6	FLT1816-25FMP	\$1,416		
	18	15½	25	91	6	FLV1816-25FMP		\$1,898	\$2,086



Features:

- box, box file only; letter width pedestal
- pedestal front locking
- no additional top needed
- dual wheel casters

Options:

- must specify chassis grain direction on artisan veneer, see pages 13-15 for details
- ledge pulls standard; prism pulls available, specify and see page 9

Box/File Mobile Pedestal	18	15¾	21	67	5	FLT1816-21FMP	\$1,274		
	18	15¾	21	67	5	FLV1816-21FMP		\$1,776	\$1,952



Features:

- dual wheel casters
- pedestal front locking

Options:

- must specify chassis grain direction on artisan veneer, see pages 13-15 for details
- veneer drawer fronts in paint available, specify paint color and add \$354 list; see page 16 for details
- on laminate units, contrasting fronts available, no upcharge; specify color, see page 16 for details
- ledge pulls standard; prism pulls available, specify and see page 9
- round or square seat cushion available, see page 17 for more details and page 213 for pricing

Mobile Pedestal - Top Storage	12¾	15¾	22	65	7	FLT1816-21FMPT	\$1,397		
	12¾	15¾	22	65	7	FLV1816-21FMPT		\$1,910	\$2,100



Features:

- pedestal front locking

Options:

- must specify chassis grain direction on artisan veneer, see pages 13-15 for details
- veneer drawer front available in contrasting paint color, specify paint color and add \$354 list
- laminate drawer fronts available in contrasting color, no upcharge, specify color; see pages 14 for details

To Order, Specify:

① Laminate Model #	② Laminate Type	③ Laminate Selection	④ Metal Color	⑤ Other Product Options		
Laminate (FLT)	HPL	See Laminate Selection	See Metal Finish Color Options	See list of options for each specific unit; Specify and add accordingly.		
① Veneer Model #	② Wood Collection	③ Wood Finish	④ Metal Color	⑤ Other Product Options		
Veneer (FLV)	Essentials	See Essentials Wood Finish Options	See Metal Finish Color Options	See list of options for each specific unit; Specify and add accordingly.		
	Artisan	<table border="1"> <thead> <tr> <th>ⓐ Wood Finish</th> <th>ⓑ Chassis Grain Direction</th> </tr> </thead> <tbody> <tr> <td>See Artisan Wood Finish Options</td> <td>For Artisan Only: Vertical Horizontal</td> </tr> </tbody> </table>	ⓐ Wood Finish		ⓑ Chassis Grain Direction	See Artisan Wood Finish Options
ⓐ Wood Finish	ⓑ Chassis Grain Direction					
See Artisan Wood Finish Options	For Artisan Only: Vertical Horizontal					

Description	D	W	H	CTN WT	CU FT	① Model	HPL Laminate	Essentials Veneer	Artisan Veneer
Split Top Box/File Kneespace	22	96	29	314	43	FLT2296-29L6K6ST	\$4,093		
Credenza - Flush Legs	22	96	29	314	43	FLV2296-29L6K6ST		\$5,228	\$5,750
	22	90	29	307	40	FLT2290-29L6K6ST	\$3,982		
	22	90	29	307	40	FLV2290-29L6K6ST		\$5,084	\$5,592

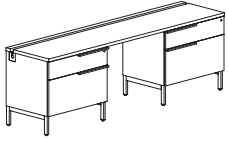

modesty panel options:

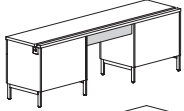

apron

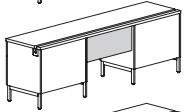

half

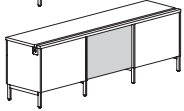

full

Features:

- eased edge profile user side
- built in horizontal wire channel
- 5”h back apron rail standard in kneespace
- pedestal front locking

Options:

- must specify chassis grain direction on artisan veneer, see pages 13-15 for details
- concealed box drawer(s) available, specify location in unit; add \$246 list for each laminate drawer or \$375 for each veneer drawer, see page 25 for details
- fixed half or full modesty panel available, specify style; add \$170 list for laminate panel or \$212 list for veneer panel, see page 25 for details
- veneer drawer fronts in paint available, specify paint color and add \$354 list; see page 16 for details
- on laminate units, contrasting worksurface tops and drawer fronts available, no upcharge; specify color, see page 16 for details
- ledge pulls standard; prism pulls available, specify and see page 9

Description	D	W	H	CTN WT	CU FT	① Model	HPL Laminate	Essentials Veneer	Artisan Veneer
Box/File Kneespace Credenza - Flush Legs	22	96	29	320	43	FLT2296-29L6K6	\$3,805		
	22	96	29	320	43	FLV2296-29L6K6		\$4,939	\$5,433
	22	90	29	320	40	FLT2290-29L6K6	\$3,694		
	22	90	29	320	40	FLV2290-29L6K6		\$4,796	\$5,276

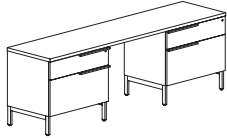

modesty panel options:

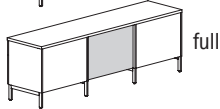
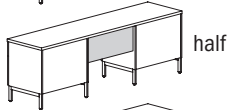
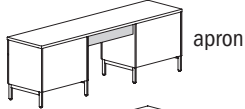

Features:

- eased edge profile user side
- 5”h back apron rail standard in kneespace
- pedestal front locking

Options:

- must specify chassis grain direction on artisan veneer, see pages 13-15 for details
- concealed box drawer(s) available, specify location in unit; add \$246 list for each laminate drawer or \$375 for each veneer drawer, see page 25 for details
- fixed half or full modesty panel available, specify style; add \$170 list for laminate panel or \$212 list for veneer panel, see page 25 for details
- veneer drawer fronts in paint available, specify paint color and add \$354 list; see page 16 for details
- on laminate units, contrasting worksurface tops and drawer fronts available, no upcharge; specify color, see page 16 for details
- ledge pulls standard; prism pulls available, specify and see page 9
- interior horizontal wire manager with end grommets available, specify and add \$189 list; see page 40 for details
- top grommet available, specify location; add \$135 list each; see page 45 for details
- worksurface power available, specify “to accommodate EC26” on your purchase order; EC26 unit must be ordered separately, see page 45

FLUX

To Order, Specify:

① Laminate Model #	② Laminate Type	③ Laminate Selection		④ Metal Color	⑤ Other Product Options
Laminate (FLT)	HPL	See Laminate Selection		See Metal Finish Color Options	See list of options for each specific unit; Specify and add accordingly.
① Veneer Model #	② Wood Collection	③ Wood Finish		④ Metal Color	⑤ Other Product Options
Veneer (FLV)	Essentials	See Essentials Wood Finish Options		See Metal Finish Color Options	See list of options for each specific unit; Specify and add accordingly.
	Artisan	ⓐ Wood Finish See Artisan Wood Finish Options	ⓑ Chassis Grain Direction For Artisan Only: Vertical Horizontal		

Description	D	W	H	CTN WT	CU FT	① Model	HPL Laminate	Essentials Veneer	Artisan Veneer
Split Top Box/File Kneespace Credenza - Flush Legs	22	84	29	247	38	FLT2284-29L5K5ST	\$3,585		
	22	84	29	247	38	FLV2284-29L5K5ST		\$4,570	\$5,026
	22	78	29	240	35	FLT2278-29L5K5ST	\$3,490		
	22	78	29	240	35	FLV2278-29L5K5ST		\$4,442	\$4,889
	22	72	29	233	32	FLT2272-29L5K5ST	\$3,397		
	22	72	29	233	32	FLV2272-29L5K5ST		\$4,321	\$4,754
	22	66	29	219	30	FLT2266-29L5K5ST	\$3,318		
	22	66	29	219	30	FLV2266-29L5K5ST		\$4,224	\$4,645
	22	60	29	212	27	FLT2260-29L5K5ST	\$3,243		
	22	60	29	212	27	FLV2260-29L5K5ST		\$4,123	\$4,538

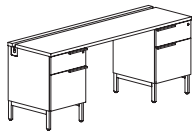

modesty panel options:

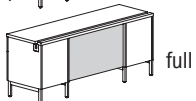
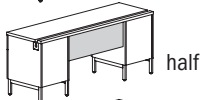

Features:

- eased edge profile user side
- built in horizontal wire channel
- 5”h back apron rail standard in kneespace
- pedestal front locking

Options:

- must specify chassis grain direction on artisan veneer, see pages 13-15 for details
- fixed half or full modesty panel available, specify style; add \$170 list for laminate panel or \$212 list for veneer panel, see page 25 for details
- veneer drawer fronts in paint available, specify paint color and add \$354 list; see page 16 for details
- on laminate units, contrasting worksurface tops and drawer fronts available, no upcharge; specify color, see page 16 for details
- ledge pulls standard; prism pulls available, specify and see page 9

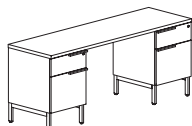
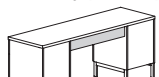
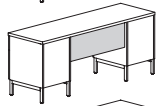
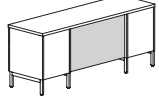
Description	D	W	H	CTN WT	CU FT	① Model	HPL Laminate	Essentials Veneer	Artisan Veneer
 modesty panel options:  apron  half  full	22	84	29	252	38	FLT2284-29L5K5	\$3,295		
	22	84	29	252	38	FLV2284-29L5K5		\$4,279	\$4,708
	22	78	29	245	35	FLT2278-29L5K5	\$3,201		
	22	78	29	245	35	FLV2278-29L5K5		\$4,155	\$4,571
	22	72	29	237	32	FLT2272-29L5K5	\$3,106		
	22	72	29	237	32	FLV2272-29L5K5		\$4,034	\$4,437
	22	66	29	222	30	FLT2266-29L5K5	\$3,029		
	22	66	29	222	30	FLV2266-29L5K5		\$3,934	\$4,326
	22	60	29	215	27	FLT2260-29L5K5	\$2,954		
	22	60	29	215	27	FLV2260-29L5K5		\$3,835	\$4,221

Features:

- eased edge profile user side
- 5”h back apron rail standard in kneespace
- pedestal front locking

Options:

- must specify chassis grain direction on artisan veneer, see pages 13-15 for details
- fixed half or full modesty panel available, specify style; add \$170 list for laminate panel or \$212 list for veneer panel, see page 25 for details
- veneer drawer fronts in paint available, specify paint color and add \$354 list; see page 16 for details
- on laminate units, contrasting worksurface tops and drawer fronts available, no upcharge; specify color, see page 16 for details
- ledge pulls standard; prism pulls available, specify and see page 9
- interior horizontal wire manager with end grommets available, specify and add \$189 list; see page 40 for details
- top grommet available, specify location; add \$135 list each; see page 45 for details
- worksurface power available, specify “to accommodate EC26” on your purchase order; EC26 unit must be ordered separately, see page 45

To Order, Specify:

① Laminate Model #	② Laminate Type	③ Laminate Selection	④ Metal Color	⑤ Other Product Options		
Laminate (FLT)	HPL	See Laminate Selection	See Metal Finish Color Options	See list of options for each specific unit; Specify and add accordingly.		
① Veneer Model #	② Wood Collection	③ Wood Finish	④ Metal Color	⑤ Other Product Options		
Veneer (FLV)	Essentials	See Essentials Wood Finish Options	See Metal Finish Color Options	See list of options for each specific unit; Specify and add accordingly.		
	Artisan	<table border="1"> <thead> <tr> <th>ⓐ Wood Finish</th> <th>ⓑ Chassis Grain Direction</th> </tr> </thead> <tbody> <tr> <td>See Artisan Wood Finish Options</td> <td>For Artisan Only: Vertical Horizontal</td> </tr> </tbody> </table>	ⓐ Wood Finish		ⓑ Chassis Grain Direction	See Artisan Wood Finish Options
ⓐ Wood Finish	ⓑ Chassis Grain Direction					
See Artisan Wood Finish Options	For Artisan Only: Vertical Horizontal					

Description	D	W	H	CTN WT	CU FT	① Model	HPL Laminate	Essentials Veneer	Artisan Veneer
Split Top Open Corner Lateral Credenza - Flush Legs	22	96	29	251	43	FLT2296-29LK6ST	\$3,155		
	22	96	29	251	43	FLV2296-29LK6ST		\$4,006	\$4,406
	22	96	29	251	43	FLT2296-29L6KST	\$3,155		
	22	96	29	251	43	FLV2296-29L6KST		\$4,006	\$4,406
	22	90	29	244	40	FLT2290-29LK6ST	\$3,083		
	22	90	29	244	40	FLV2290-29LK6ST		\$3,915	\$4,308
	22	90	29	256	40	FLT2290-29L6KST	\$3,083		
	22	90	29	256	40	FLV2290-29L6KST		\$3,915	\$4,308

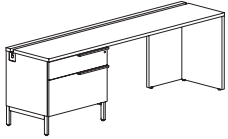

*6KST shown

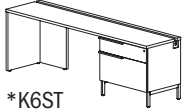

*K6ST

Features:

- eased edge profile user side
- built in horizontal wire channel
- 5”h back apron rail standard in kneespace
- pedestal front locking

Options:

- must specify chassis grain direction on artisan veneer, see pages 13-15 for details
- concealed box drawer available, specify; add \$246 list for each laminate drawer or \$375 for each veneer drawer, see page 25 for details
- fixed half or full modesty panel available, specify style; add \$170 list for laminate panel or \$212 list for veneer panel, see page 25 for details
- veneer drawer fronts in paint available, specify paint color and add \$354 list; see page 16 for details
- on laminate units, contrasting worksurface tops and drawer fronts available, no upcharge; specify color, see page 16 for details
- ledge pulls standard; prism pulls available, specify and see page 9
- knee clearance end panel available 13” depth, specify; no upcharge

modesty panel options:

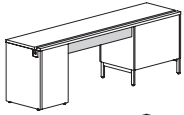

apron

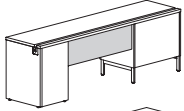

half

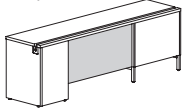

full

FLUX

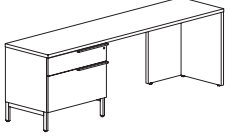
Description	D	W	H	CTN WT	CU FT	① Model	HPL Laminate	Essentials Veneer	Artisan Veneer
Open Corner Lateral Credenza - Flush Legs  *6K shown	22	96	29	256	43	FLT2296-29LK6	\$2,864		
	22	96	29	256	43	FLV2296-29LK6		\$3,717	\$4,088
	22	96	29	256	43	FLT2296-29L6K	\$2,864		
	22	96	29	256	43	FLV2296-29L6K		\$3,717	\$4,088
	22	90	29	249	40	FLT2290-29LK6	\$2,791		
	22	90	29	249	40	FLV2290-29LK6		\$3,627	\$3,990
	22	90	29	249	40	FLT2290-29L6K	\$2,791		
	22	90	29	249	40	FLV2290-29L6K		\$3,627	\$3,990

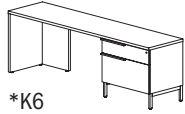

Features:

- eased edge profile user side
- 5" h back apron rail standard in kneespace
- pedestal front locking

Options:

- must specify chassis grain direction on artisan veneer, see pages 13-15 for details
- concealed box drawer available, specify; add \$246 list for each laminate drawer or \$375 for each veneer drawer, see page 25 for details
- fixed half or full modesty panel available, specify style; add \$170 list for laminate panel or \$212 list for veneer panel, see page 25 for details
- veneer drawer fronts in paint available, specify paint color and add \$354 list; see page 16 for details
- on laminate units, contrasting worksurface tops and drawer fronts available, no upcharge; specify color, see page 16 for details
- ledge pulls standard; prism pulls available, specify and see page 9
- interior horizontal wire manager with end grommets available, specify and add \$189 list; see page 40 for details
- top grommet available, specify location; add \$135 list each; see page 45 for details
- worksurface power available, specify "to accommodate EC26" on your purchase order; EC26 unit must be ordered separately, see page 45
- knee clearance end panel available 13" depth, specify; no upcharge

modesty panel options:

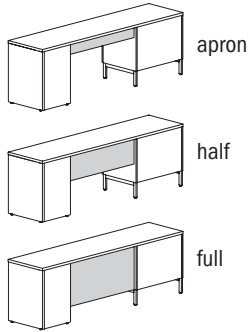

To Order, Specify:

① Laminate Model #	② Laminate Type	③ Laminate Selection	④ Metal Color	⑤ Other Product Options		
Laminate (FLT)	HPL	See Laminate Selection	See Metal Finish Color Options	See list of options for each specific unit; Specify and add accordingly.		
① Veneer Model #	② Wood Collection	③ Wood Finish	④ Metal Color	⑤ Other Product Options		
Veneer (FLV)	Essentials	See Essentials Wood Finish Options	See Metal Finish Color Options	See list of options for each specific unit; Specify and add accordingly.		
	Artisan	<table border="1"> <thead> <tr> <th>ⓐ Wood Finish</th> <th>ⓑ Chassis Grain Direction</th> </tr> </thead> <tbody> <tr> <td>See Artisan Wood Finish Options</td> <td>For Artisan Only: Vertical Horizontal</td> </tr> </tbody> </table>	ⓐ Wood Finish		ⓑ Chassis Grain Direction	See Artisan Wood Finish Options
ⓐ Wood Finish	ⓑ Chassis Grain Direction					
See Artisan Wood Finish Options	For Artisan Only: Vertical Horizontal					

Description	D	W	H	CTN WT	CU FT	① Model	HPL Laminate	Essentials Veneer	Artisan Veneer
Split Top Open Corner Credenza - Flush Legs	22	84	29	211	38	FLT2284-29LK5ST	\$3,068		
	22	84	29	211	38	FLV2284-29LK5ST		\$3,849	\$4,234
	22	84	29	211	38	FLT2284-29L5KST	\$3,068		
	22	84	29	211	38	FLV2284-29L5KST		\$3,849	\$4,234
	22	78	29	218	35	FLT2278-29LK5ST	\$3,012		
	22	78	29	218	35	FLV2278-29LK5ST		\$3,778	\$4,157
	22	78	29	218	35	FLT2278-29L5KST	\$3,012		
	22	78	29	218	35	FLV2278-29L5KST		\$3,778	\$4,157
	22	72	29	177	32	FLT2272-29LK5ST	\$2,959		
	22	72	29	177	32	FLV2272-29LK5ST		\$3,709	\$4,080
	22	72	29	177	32	FLT2272-29L5KST	\$2,959		
	22	72	29	177	32	FLV2272-29L5KST		\$3,709	\$4,080

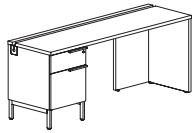

*5KST shown



*K5ST

modesty panel options:

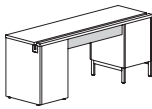

apron

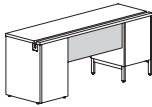

half

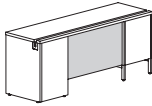

full

Features:

- eased edge profile user side
- built in horizontal wire channel
- 5”h back apron rail standard in kneespace
- pedestal front locking

Options:

- must specify chassis grain direction on artisan veneer, see pages 13-15 for details
- fixed half or full modesty panel available, specify style; add \$170 list for laminate panel or \$212 list for veneer panel, see page 25 for details
- veneer drawer fronts in paint available, specify paint color and add \$354 list; see page 16 for details
- ledge pulls standard; prism pulls available, specify and see page 9
- knee clearance end panel available 13” depth, specify; no upcharge

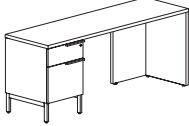
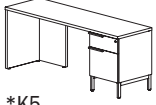
Description	D	W	H	CTN WT	CU FT	① Model	HPL Laminate	Essentials Veneer	Artisan Veneer
 <p>*5K shown</p>  <p>*K5</p>	22	84	29	216	38	FLT2284-29LK5	\$2,779		
	22	84	29	216	38	FLV2284-29LK5		\$3,560	\$3,916
	22	84	29	216	38	FLT2284-29L5K	\$2,779		
	22	84	29	216	38	FLV2284-29L5K		\$3,560	\$3,916
	22	78	29	208	35	FLT2278-29LK5	\$2,722		
	22	78	29	208	35	FLV2278-29LK5		\$3,491	\$3,840
	22	78	29	208	35	FLT2278-29L5K	\$2,722		
	22	78	29	208	35	FLV2278-29L5K		\$3,491	\$3,840
	22	72	29	201	32	FLT2272-29LK5	\$2,669		
	22	72	29	201	32	FLV2272-29LK5		\$3,420	\$3,764
	22	72	29	201	32	FLT2272-29L5K	\$2,669		
	22	72	29	201	32	FLV2272-29L5K		\$3,420	\$3,764

Features:

- eased edge profile user side
- 5”h back apron rail standard in kneespace
- pedestal front locking

Options:

- must specify chassis grain direction on artisan veneer, see pages 13-15 for details
- fixed half or full modesty panel available, specify style; add \$170 list for laminate panel or \$212 list for veneer panel, see page 25 for details
- veneer drawer fronts in paint available, specify paint color and add \$354 list; see page 16 for details
- on laminate units, contrasting worksurface tops and drawer fronts available, no upcharge; specify color, see page 16 for details
- ledge pulls standard; prism pulls available, specify and see page 9
- interior horizontal wire manager with end grommets available, specify and add \$189 list; see page 40 for details
- top grommet available, specify location; add \$135 list each; see page 45 for details
- worksurface power available, specify “to accommodate EC26” on your purchase order; EC26 unit must be ordered separately, see page 45
- knee clearance end panel available 13” depth, specify; no upcharge

modesty panel options:

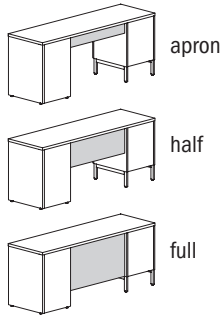

To Order, Specify:

① Laminate Model #	② Laminate Type	③ Laminate Selection	④ Metal Color	⑤ Other Product Options		
Laminate (FLT)	HPL	See Laminate Selection	See Metal Finish Color Options	See list of options for each specific unit; Specify and add accordingly.		
① Veneer Model #	② Wood Collection	③ Wood Finish	④ Metal Color	⑤ Other Product Options		
Veneer (FLV)	Essentials	See Essentials Wood Finish Options	See Metal Finish Color Options	See list of options for each specific unit; Specify and add accordingly.		
	Artisan	<table border="1"> <thead> <tr> <th>ⓐ Wood Finish</th> <th>ⓑ Chassis Grain Direction</th> </tr> </thead> <tbody> <tr> <td>See Artisan Wood Finish Options</td> <td>For Artisan Only: Vertical Horizontal</td> </tr> </tbody> </table>	ⓐ Wood Finish		ⓑ Chassis Grain Direction	See Artisan Wood Finish Options
ⓐ Wood Finish	ⓑ Chassis Grain Direction					
See Artisan Wood Finish Options	For Artisan Only: Vertical Horizontal					

Description	D	W	H	CTN WT	CU FT	① Model	HPL Laminate	Essentials Veneer	Artisan Veneer
Split Top Open Corner Credenza - Flush Legs	22	66	29	184	30	FLT2266-29LK5ST	\$2,319		
	22	66	29	184	30	FLV2266-29LK5ST		\$2,893	\$3,179
	22	66	29	184	30	FLT2266-29L5KST	\$2,319		
	22	66	29	184	30	FLV2266-29L5KST		\$2,893	\$3,179
	22	60	29	177	27	FLT2260-29LK5ST	\$2,279		
	22	60	29	177	27	FLV2260-29LK5ST		\$2,840	\$3,124
	22	60	29	177	27	FLT2260-29L5KST	\$2,279		
	22	60	29	177	27	FLV2260-29L5KST		\$2,840	\$3,124

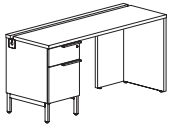

*5KST shown



*K5ST

Features:

- eased edge profile user side
- built in horizontal wire channel
- 5”h back apron rail standard in kneespace
- pedestal front locking

Options:

- must specify chassis grain direction on artisan veneer, see pages 13-15 for details
- fixed half or full modesty panel available, specify style; add \$170 list for laminate panel or \$212 list for veneer panel, see page 25 for details
- veneer drawer fronts in paint available, specify paint color and add \$354 list; see page 16 for details
- on laminate units, contrasting worksurface tops and drawer fronts available, no upcharge; specify color, see page 16 for details
- ledge pulls standard; prism pulls available, specify and see page 9
- knee clearance end panel available 13” depth, specify; no upcharge

modesty panel options:



apron

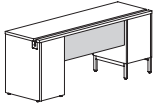

half

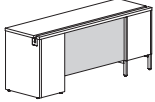

full

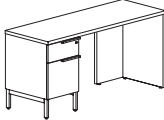
Description	D	W	H	CTN WT	CU FT	① Model	HPL Laminate	Essentials Veneer	Artisan Veneer
 <p>*5K shown</p>	22	66	29	187	30	FLT2266-29LK5	\$2,030		
	22	66	29	187	30	FLV2266-29LK5		\$2,603	\$2,863
	22	66	29	187	30	FLT2266-29L5K	\$2,030		
	22	66	29	187	30	FLV2266-29L5K		\$2,603	\$2,863
	22	60	29	180	27	FLT2260-29LK5	\$1,990		
	22	60	29	180	27	FLV2260-29LK5		\$2,551	\$2,808
	22	60	29	180	27	FLT2260-29L5K	\$1,990		
	22	60	29	180	27	FLV2260-29L5K		\$2,551	\$2,808



Features:

- eased edge profile user side
- 5”h back apron rail standard in kneespace
- pedestal front locking

Options:



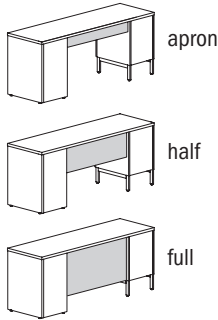

- must specify chassis grain direction on artisan veneer, see pages 13-15 for details
- fixed half or full modesty panel available, specify style; add \$170 list for laminate panel or \$212 list for veneer panel, see page 25 for details
- veneer drawer fronts in paint available, specify paint color and add \$354 list; see page 16 for details
- on laminate units, contrasting worksurface tops and drawer fronts available, no upcharge; specify color, see page 16 for details
- ledge pulls standard; prism pulls available, specify and see page 9
- interior horizontal wire manager with end grommets available, specify and add \$189 list; see page 40 for details
- top grommet available, specify location; add \$135 list each; see page 45 for details
- worksurface power available, specify “to accommodate EC26” on your purchase order; EC26 unit must be ordered separately, see page 45
- knee clearance end panel available 13” depth, specify; no upcharge

modesty panel options:

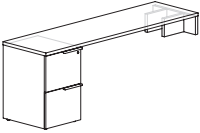

To Order, Specify:

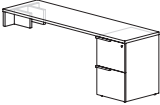
① Laminate Model #	② Laminate Type	③ Laminate Selection	④ Metal Color	⑤ Other Product Options		
Laminate (FLT)	HPL	See Laminate Selection	See Metal Finish Color Options	See list of options for each specific unit; Specify and add accordingly.		
① Veneer Model #	② Wood Collection	③ Wood Finish	④ Metal Color	⑤ Other Product Options		
Veneer (FLV)	Essentials	See Essentials Wood Finish Options	See Metal Finish Color Options	See list of options for each specific unit; Specify and add accordingly.		
	Artisan	<table border="1"> <thead> <tr> <th>ⓐ Wood Finish</th> <th>ⓑ Chassis Grain Direction</th> </tr> </thead> <tbody> <tr> <td>See Artisan Wood Finish Options</td> <td>For Artisan Only: Vertical Horizontal</td> </tr> </tbody> </table>	ⓐ Wood Finish		ⓑ Chassis Grain Direction	See Artisan Wood Finish Options
ⓐ Wood Finish	ⓑ Chassis Grain Direction					
See Artisan Wood Finish Options	For Artisan Only: Vertical Horizontal					







Description	D	W	H	CTN WT	CU FT	① Model	HPL Laminate	Essentials Veneer	Artisan Veneer
File/File Peninsula Credenza	22	96	29	172	43	FLT2296-29FPCK2	\$2,382		
	22	96	29	172	43	FLV2296-29FPCK2		\$3,323	\$3,656
	22	96	29	172	43	FLT2296-29FPC2K	\$2,382		
	22	96	29	172	43	FLV2296-29FPC2K		\$3,323	\$3,656
	22	90	29	171	40	FLT2290-29FPCK2	\$2,323		
	22	90	29	171	40	FLV2290-29FPCK2		\$3,244	\$3,568
*2K shown	22	90	29	171	40	FLT2290-29FPC2K	\$2,323		
	22	90	29	171	40	FLV2290-29FPC2K		\$3,244	\$3,568
	22	84	29	166	38	FLT2284-29FPCK2	\$2,267		
	22	84	29	166	38	FLV2284-29FPCK2		\$3,164	\$3,480
	22	84	29	166	38	FLT2284-29FPC2K	\$2,267		
	22	84	29	166	38	FLV2284-29FPC2K		\$3,164	\$3,480
*K2	22	78	29	161	35	FLT2278-29FPCK2	\$2,213		
	22	78	29	161	35	FLV2278-29FPCK2		\$3,087	\$3,397
	22	78	29	161	35	FLT2278-29FPC2K	\$2,213		
	22	78	29	161	35	FLV2278-29FPC2K		\$3,087	\$3,397
	22	72	29	156	32	FLT2272-29FPCK2	\$2,159		
	22	72	29	156	32	FLV2272-29FPCK2		\$3,012	\$3,312
	22	72	29	156	32	FLT2272-29FPC2K	\$2,159		
	22	72	29	156	32	FLV2272-29FPC2K		\$3,012	\$3,312

Features:

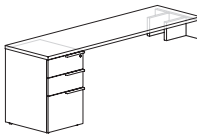
- intended to be used with secondary height credenzas; specify mounting location when ordering credenzas, see page 17
- eased edge profile user side
- pedestal front locking

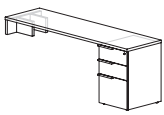
Options:

- must specify chassis grain direction on artisan veneer, see pages 13-15 for details
- veneer drawer fronts in paint available, specify paint color and add \$354 list; see page 16 for details
- on laminate units, contrasting fronts available, no upcharge; specify color, see page 16 for details
- ledge pulls standard; prism pulls available, specify and see page 9
- top grommet available, specify location and add \$135 list each; see page 46 for details
- worksurface power available, specify "to accommodate EC26" on your purchase order; EC26 unit must be ordered separately, see page 46

Description	D	W	H	CTN WT	CU FT	① Model	HPL Laminate	Essentials Veneer	Artisan Veneer
Box/Box/File Peninsula Credenza	22	96	29	174	43	FLT2296-29FPCK1	\$2,388		
	22	96	29	174	43	FLV2296-29FPCK1		\$3,333	\$3,667
	22	96	29	174	43	FLT2296-29FPC1K	\$2,388		
	22	96	29	174	43	FLV2296-29FPC1K		\$3,333	\$3,667
	22	90	29	173	40	FLT2290-29FPCK1	\$2,331		
	22	90	29	173	40	FLV2290-29FPCK1		\$3,251	\$3,579
*1K shown	22	90	29	173	40	FLT2290-29FPC1K	\$2,331		
	22	90	29	173	40	FLV2290-29FPC1K		\$3,251	\$3,579
	22	84	29	168	38	FLT2284-29FPCK1	\$2,274		
	22	84	29	168	38	FLV2284-29FPCK1		\$3,171	\$3,491
	22	84	29	168	38	FLT2284-29FPC1K	\$2,274		
	22	84	29	168	38	FLV2284-29FPC1K		\$3,171	\$3,491
*K1	22	78	29	165	35	FLT2278-29FPCK1	\$2,218		
	22	78	29	165	35	FLV2278-29FPCK1		\$3,094	\$3,406
	22	78	29	165	35	FLT2278-29FPC1K	\$2,218		
	22	78	29	165	35	FLV2278-29FPC1K		\$3,094	\$3,406
*K1	22	72	29	158	32	FLT2272-29FPCK1	\$2,166		
	22	72	29	158	32	FLV2272-29FPCK1		\$3,019	\$3,322
	22	72	29	158	32	FLT2272-29FPC1K	\$2,166		
	22	72	29	158	32	FLV2272-29FPC1K		\$3,019	\$3,322

Features:





- intended to be used with secondary height credenzas; specify mounting location when ordering credenzas, see page 17
- eased edge profile user side
- pedestal front locking

Options:

- must specify chassis grain direction on artisan veneer, see pages 13-15 for details
- veneer drawer fronts in paint available, specify paint color and add \$354 list; see page 16 for details
- on laminate units, contrasting fronts available, no upcharge; specify color, see page 16 for details
- ledge pulls standard; prism pulls available, specify and see page 9
- top grommet available, specify location and add \$135 list each; see page 46 for details
- worksurface power available, specify "to accommodate EC26" on your purchase order; EC26 unit must be ordered separately, see page 46

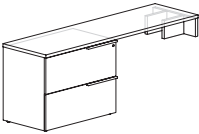
To Order, Specify:

① Laminate Model #	② Laminate Type	③ Laminate Selection	④ Metal Color	⑤ Other Product Options		
Laminate (FLT)	HPL	See Laminate Selection	See Metal Finish Color Options	See list of options for each specific unit; Specify and add accordingly.		
① Veneer Model #	② Wood Collection	③ Wood Finish	④ Metal Color	⑤ Other Product Options		
Veneer (FLV)	Essentials	See Essentials Wood Finish Options	See Metal Finish Color Options	See list of options for each specific unit; Specify and add accordingly.		
	Artisan	<table border="1"> <tr> <th>ⓐ Wood Finish</th> <th>ⓑ Chassis Grain Direction</th> </tr> <tr> <td>See Artisan Wood Finish Options</td> <td>For Artisan Only: Vertical Horizontal</td> </tr> </table>	ⓐ Wood Finish		ⓑ Chassis Grain Direction	See Artisan Wood Finish Options
ⓐ Wood Finish	ⓑ Chassis Grain Direction					
See Artisan Wood Finish Options	For Artisan Only: Vertical Horizontal					



Description	D	W	H	CTN WT	CU FT	① Model	HPL Laminate	Essentials Veneer	Artisan Veneer
Lateral File Peninsula Credenza   *4K shown   *K4	22	96	29	224	43	FLT2296-29FPCK4	\$2,622		
	22	96	29	224	43	FLV2296-29FPCK4		\$3,658	\$4,025
	22	96	29	224	43	FLT2296-29FPC4K	\$2,622		
	22	96	29	224	43	FLV2296-29FPC4K		\$3,658	\$4,025
	22	90	29	219	40	FLT2290-29FPCK4	\$2,557		
	22	90	29	219	40	FLV2290-29FPCK4		\$3,570	\$3,930
	22	90	29	219	40	FLT2290-29FPC4K	\$2,557		
	22	90	29	219	40	FLV2290-29FPC4K		\$3,570	\$3,930
	22	84	29	214	38	FLT2284-29FPCK4	\$2,495		
	22	84	29	214	38	FLV2284-29FPCK4		\$3,482	\$3,831
	22	84	29	214	38	FLT2284-29FPC4K	\$2,495		
	22	84	29	214	38	FLV2284-29FPC4K		\$3,482	\$3,831
	22	78	29	209	35	FLT2278-29FPCK4	\$2,435		
	22	78	29	209	35	FLV2278-29FPCK4		\$3,399	\$3,741
	22	78	29	209	35	FLT2278-29FPC4K	\$2,435		
	22	78	29	209	35	FLV2278-29FPC4K		\$3,399	\$3,741
	22	72	29	205	32	FLT2272-29FPCK4	\$2,376		
	22	72	29	205	32	FLV2272-29FPCK4		\$3,315	\$3,647
22	72	29	205	32	FLT2272-29FPC4K	\$2,376			
22	72	29	205	32	FLV2272-29FPC4K		\$3,315	\$3,647	

Features:

- intended to be used with secondary height credenzas; specify mounting location when ordering credenzas, see page 17
- eased edge profile user side
- pedestal front locking

Options:

- must specify chassis grain direction on artisan veneer, see pages 13-15 for details
- veneer drawer fronts in paint available, specify paint color and add \$354 list; see page 16 for details
- on laminate units, contrasting fronts available, no upcharge; specify color, see page 16 for details
- ledge pulls standard; prism pulls available, specify and see page 9
- top grommet available, specify location and add \$135 list each; see page 46 for details
- worksurface power available, specify "to accommodate EC26" on your purchase order; EC26 unit must be ordered separately, see page 46

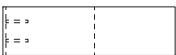
Box/Box/File Lateral Peninsula Credenza   *3K shown   *K3	22	96	29	224	43	FLT2296-29FPCK3	\$2,632		
	22	96	29	224	43	FLV2296-29FPCK3		\$3,674	\$4,040
	22	96	29	224	43	FLT2296-29FPC3K	\$2,632		
	22	96	29	224	43	FLV2296-29FPC3K		\$3,674	\$4,040
	22	90	29	220	40	FLT2290-29FPCK3	\$2,567		
	22	90	29	220	40	FLV2290-29FPCK3		\$3,584	\$3,942
	22	90	29	220	40	FLT2290-29FPC3K	\$2,567		
	22	90	29	220	40	FLV2290-29FPC3K		\$3,584	\$3,942
	22	84	29	215	38	FLT2284-29FPCK3	\$2,506		
	22	84	29	215	38	FLV2284-29FPCK3		\$3,497	\$3,846
	22	84	29	215	38	FLT2284-29FPC3K	\$2,506		
	22	84	29	215	38	FLV2284-29FPC3K		\$3,497	\$3,846
	22	78	29	211	35	FLT2278-29FPCK3	\$2,444		
	22	78	29	211	35	FLV2278-29FPCK3		\$3,411	\$3,753
	22	78	29	211	35	FLT2278-29FPC3K	\$2,444		
	22	78	29	211	35	FLV2278-29FPC3K		\$3,411	\$3,753
	22	72	29	206	32	FLT2272-29FPCK3	\$2,384		
	22	72	29	206	32	FLV2272-29FPCK3		\$3,329	\$3,663
22	72	29	206	32	FLT2272-29FPC3K	\$2,384			
22	72	29	206	32	FLV2272-29FPC3K		\$3,329	\$3,663	

Features:

- intended to be used with secondary height credenzas; specify mounting location when ordering credenzas, see page 17
- eased edge profile user side
- pedestal front locking

Options:

- must specify chassis grain direction on artisan veneer, see pages 13-15 for details
- veneer drawer fronts in paint available, specify paint color and add \$354 list; see page 16 for details
- on laminate units, contrasting fronts available, no upcharge; specify color, see page 16 for details
- ledge pulls standard; prism pulls available, specify and see page 9
- top grommet available, specify location and add \$135 list each; see page 46 for details
- worksurface power available, specify "to accommodate EC26" on your purchase order; EC26 unit must be ordered separately, see page 46

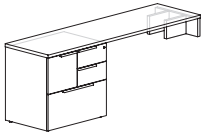
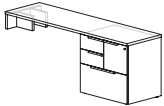
Description	D	W	H	CTN WT	CU FT	① Model	HPL Laminate	Essentials Veneer	Artisan Veneer
 left shown  right	22	96	29	225	43	FLT2296-29FPMRR	\$2,767		
	22	96	29	225	43	FLV2296-29FPMRR		\$3,862	\$4,247
	22	96	29	225	43	FLT2296-29FPMLR	\$2,767		
	22	96	29	225	43	FLV2296-29FPMLR		\$3,862	\$4,247
	22	90	29	220	40	FLT2290-29FPMRR	\$2,699		
	22	90	29	220	40	FLV2290-29FPMRR		\$3,768	\$4,146
	22	90	29	220	40	FLT2290-29FPMLR	\$2,699		
	22	90	29	220	40	FLV2290-29FPMLR		\$3,768	\$4,146
	22	84	29	214	38	FLT2284-29FPMRR	\$2,633		
	22	84	29	214	38	FLV2284-29FPMRR		\$3,677	\$4,043
	22	84	29	214	38	FLT2284-29FPMLR	\$2,633		
	22	84	29	214	38	FLV2284-29FPMLR		\$3,677	\$4,043
	22	78	29	209	35	FLT2278-29FPMRR	\$2,570		
	22	78	29	209	35	FLV2278-29FPMRR		\$3,587	\$3,946
	22	78	29	209	35	FLT2278-29FPMLR	\$2,570		
	22	78	29	209	35	FLV2278-29FPMLR		\$3,587	\$3,946
	22	72	29	204	32	FLT2272-29FPMRR	\$2,507		
	22	72	29	204	32	FLV2272-29FPMRR		\$3,498	\$3,848
	22	72	29	204	32	FLT2272-29FPMLR	\$2,507		
	22	72	29	204	32	FLV2272-29FPMLR		\$3,498	\$3,848

Features:

- intended to be used with secondary height credenzas; specify mounting location when ordering credenzas, see page 17
- eased edge profile user side
- pedestal front locking

Options:

- must specify chassis grain direction on artisan veneer, see pages 13-15 for details
- veneer drawer fronts in paint available, specify paint color and add \$354 list; see page 16 for details
- on laminate units, contrasting fronts available, no upcharge; specify color, see page 16 for details
- ledge pulls standard; prism pulls available, specify and see page 9
- top grommet available, specify location and add \$135 list each; see page 46 for details
- worksurface power available, specify "to accommodate EC26" on your purchase order; EC26 unit must be ordered separately, see page 46

To Order, Specify:

① Laminate Model #	② Laminate Type	③ Laminate Selection	④ Metal Color	⑤ Other Product Options
Laminate (FLT)	HPL	See Laminate Selection	See Metal Finish Color Options	See list of options for each specific unit; Specify and add accordingly.
① Veneer Model #	② Wood Collection	③ Wood Finish	④ Metal Color	⑤ Other Product Options
Veneer (FLV)	Essentials	See Essentials Wood Finish Options	See Metal Finish Color Options	See list of options for each specific unit; Specify and add accordingly.
	Artisan	ⓐ Wood Finish See Artisan Wood Finish Options	ⓑ Chassis Grain Direction For Artisan Only: Vertical Horizontal	

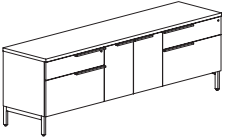
Description	D	W	H	CTN WT	CU FT	① Model	HPL Laminate	Essentials Veneer	Artisan Veneer
	22	96	29	377	43	FLT2296-29L676	\$4,437		
	22	96	29	377	43	FLV2296-29L676		\$5,761	\$6,338
	22	90	29	359	40	FLT2290-29L676	\$4,305		
	22	90	29	359	40	FLV2290-29L676		\$5,591	\$6,151
	22	84	29	340	38	FLT2284-29L676	\$4,179		
	22	84	29	340	38	FLV2284-29L676		\$5,427	\$5,970

Features:

- eased edge profile user side
- pedestal front locking
- hinged door compartment has one adjustable shelf

Options:

- must specify chassis grain direction on artisan veneer, see pages 13-15 for details
- locking door available, specify and add \$147 list
- concealed box drawer(s) available, specify location in unit; add \$246 list for each laminate drawer or \$375 for each veneer drawer, see page 25 for details
- veneer door and drawer fronts in paint available, specify paint color and add \$354; see page 16 for details
- on laminate units, contrasting worksurface tops and door fronts available, no upcharge; specify laminate color, see page 16 for details
- ledge pulls standard; prism pulls available, specify and see page 9
- oval grommets in back panel can be eliminated upon request, no upcharge
- interior horizontal wire manager with end grommets available, specify and add \$189 list; see page 40 for details
- top grommet available, specify location; add \$135 list each; see page 46 for details
- worksurface power available, specify "to accommodate EC26" on your purchase order; EC26 unit must be ordered separately, see page 46

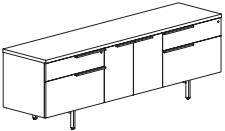
	22	90	29	369	40	FLT2290-29S676	\$4,305		
	22	90	29	369	40	FLV2290-29S676		\$5,591	\$6,151

Features:

- eased edge profile user side
- pedestal front locking
- hinged door compartment has one adjustable shelf

Options:

- must specify chassis grain direction on artisan veneer, see pages 13-15 for details
- locking door available, specify and add \$147 list
- concealed box drawer(s) available, specify location in unit; add \$246 list for each laminate drawer or \$375 for each veneer drawer, see page 25 for details
- veneer door and drawer fronts in paint available, specify paint color and add \$354; see page 16 for details
- on laminate units, contrasting worksurface tops and door fronts available, no upcharge; specify laminate color, see page 16 for details
- ledge pulls standard; prism pulls available, specify and see page 9
- oval grommets in back panel can be eliminated upon request, no upcharge
- interior horizontal wire manager with end grommets available, specify and add \$189 list; see page 40 for details
- top grommet available, specify location; add \$135 list each; see page 46 for details
- worksurface power available, specify "to accommodate EC26" on your purchase order; EC26 unit must be ordered separately, see page 46

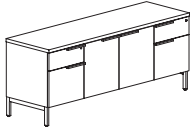
Description	D	W	H	CTN WT	CU FT	① Model	HPL Laminate	Essentials Veneer	Artisan Veneer
 Storage Credenza - Flush Legs	22	78	29	311	35	FLT2278-29L575	\$3,914		
	22	78	29	311	35	FLV2278-29L575		\$5,080	\$5,589
	22	72	29	292	32	FLT2272-29L575	\$3,804		
	22	72	29	292	32	FLV2272-29L575		\$4,937	\$5,430
	22	66	29	273	30	FLT2266-29L575	\$3,741		
	22	66	29	273	30	FLV2266-29L575		\$4,854	\$5,341
	22	60	29	255	27	FLT2260-29L575	\$3,673		
	22	60	29	255	27	FLV2260-29L575		\$4,766	\$5,243

Features:

- eased edge profile user side
- pedestal front locking
- hinged door compartment has one adjustable shelf

Options:

- must specify chassis grain direction on artisan veneer, see pages 13-15 for details
- locking door available, specify and add \$147 list
- concealed box drawer(s) available, specify location in unit; add \$246 list for each laminate drawer or \$375 for each veneer drawer, see page 25 for details
- veneer door and drawer fronts in paint available, specify paint color and add \$354; see page 16 for details
- on laminate units, contrasting worksurface tops and door fronts available, no upcharge; specify laminate color, see page 16 for details
- ledge pulls standard; prism pulls available, specify and see page 9
- oval grommets in back panel can be eliminated upon request, no upcharge
- interior horizontal wire manager with end grommets available, specify and add \$189 list; see page 40 for details
- top grommet available, specify location; add \$135 list each; see page 46 for details
- worksurface power available, specify "to accommodate EC26" on your purchase order; EC26 unit must be ordered separately, see page 46

 Storage Credenza - Inset Legs	22	72	29	298	32	FLT2272-29S575	\$3,804		
	22	72	29	298	32	FLV2272-29S575		\$4,937	\$5,430
	22	60	29	254	27	FLT2260-29S575	\$3,673		
	22	60	29	254	27	FLV2260-29S575		\$4,766	\$5,243

Features:

- eased edge profile user side
- pedestal front locking
- hinged door compartment has one adjustable shelf

Options:

- must specify chassis grain direction on artisan veneer, see pages 13-15 for details
- locking door available, specify and add \$147 list
- concealed box drawer(s) available, specify location in unit; add \$246 list for each laminate drawer or \$375 for each veneer drawer, see page 25 for details
- veneer door and drawer fronts in paint available, specify paint color and add \$354; see page 16 for details
- on laminate units, contrasting worksurface tops and door fronts available, no upcharge; specify laminate color, see page 16 for details
- ledge pulls standard; prism pulls available, specify and see page 9
- oval grommets in back panel can be eliminated upon request, no upcharge
- interior horizontal wire manager with end grommets available, specify and add \$189 list; see page 40 for details
- top grommet available, specify location; add \$135 list each; see page 46 for details
- worksurface power available, specify "to accommodate EC26" on your purchase order; EC26 unit must be ordered separately, see page 46

To Order, Specify:

① Laminate Model #	② Laminate Type	③ Laminate Selection	④ Metal Color	⑤ Other Product Options		
Laminate (FLT)	HPL	See Laminate Selection	See Metal Finish Color Options	See list of options for each specific unit; Specify and add accordingly.		
① Veneer Model #	② Wood Collection	③ Wood Finish	④ Metal Color	⑤ Other Product Options		
Veneer (FLV)	Essentials	See Essentials Wood Finish Options	See Metal Finish Color Options	See list of options for each specific unit; Specify and add accordingly.		
	Artisan	<table border="1"> <thead> <tr> <th>ⓐ Wood Finish</th> <th>ⓑ Chassis Grain Direction</th> </tr> </thead> <tbody> <tr> <td>See Artisan Wood Finish Options</td> <td>For Artisan Only: Vertical Horizontal</td> </tr> </tbody> </table>	ⓐ Wood Finish		ⓑ Chassis Grain Direction	See Artisan Wood Finish Options
ⓐ Wood Finish	ⓑ Chassis Grain Direction					
See Artisan Wood Finish Options	For Artisan Only: Vertical Horizontal					

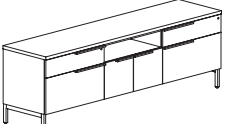
Description	D	W	H	CTN WT	CU FT	① Model	HPL Laminate	Essentials Veneer	Artisan Veneer
Box/Lateral Storage Credenza with Open Center - Flush Legs 	22	96	29	365	43	FLT2296-29L686	\$4,481		
	22	96	29	365	43	FLV2296-29L686		\$5,817	\$6,400
	22	90	29	355	40	FLT2290-29L686	\$4,352		
	22	90	29	355	40	FLV2290-29L686		\$5,648	\$6,215
	22	84	29	332	38	FLT2284-29L686	\$4,225		
	22	84	29	332	38	FLV2284-29L686		\$5,487	\$6,035

Features:

- eased edge profile user side
- pedestal front locking
- hinged door compartment has one adjustable shelf

Options:

- must specify chassis grain direction on artisan veneer, see pages 13-15 for details
- locking door available, specify and add \$147 list
- concealed box drawer(s) available, specify location in unit; add \$246 list for each laminate drawer or \$375 for each veneer drawer, see page 25 for details
- veneer door and drawer fronts in paint available, specify paint color and add \$354; see page 16 for details
- on laminate units, contrasting worksurface tops and door fronts available, no upcharge; specify laminate color, see page 16 for details
- ledge pulls standard; prism pulls available, specify and see page 9
- oval grommets in back panel can be eliminated upon request, no upcharge
- interior horizontal wire manager with end grommets available, specify and add \$189 list; see page 40 for details
- top grommet available, specify location; add \$135 list each; see page 46 for details
- worksurface power available, specify "to accommodate EC26" on your purchase order; EC26 unit must be ordered separately, see page 46

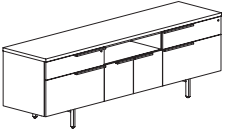
Box/Lateral Storage Credenza with Open Center - Inset Legs 	22	90	29	390	40	FLT2290-29S686	\$4,352		
	22	90	29	390	40	FLV2290-29S686		\$5,648	\$6,215

Features:

- eased edge profile user side
- pedestal front locking
- hinged door compartment has one adjustable shelf

Options:

- must specify chassis grain direction on artisan veneer, see pages 13-15 for details
- locking door available, specify and add \$147 list
- concealed box drawer(s) available, specify location in unit; add \$246 list for each laminate drawer or \$375 for each veneer drawer, see page 25 for details
- veneer door and drawer fronts in paint available, specify paint color and add \$354; see page 16 for details
- on laminate units, contrasting worksurface tops and door fronts available, no upcharge; specify laminate color, see page 16 for details
- ledge pulls standard; prism pulls available, specify and see page 9
- oval grommets in back panel can be eliminated upon request, no upcharge
- interior horizontal wire manager with end grommets available, specify and add \$189 list; see page 40 for details
- top grommet available, specify location; add \$135 list each; see page 46 for details
- worksurface power available, specify "to accommodate EC26" on your purchase order; EC26 unit must be ordered separately, see page 46

FLUX

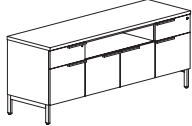
Description	D	W	H	CTN WT	CU FT	① Model	HPL Laminate	Essentials Veneer	Artisan Veneer
 Box/Lateral Storage Credenza with Open Center - Flush Legs	22	78	29	300	35	FLT2278-29L585	\$3,958		
	22	78	29	300	35	FLV2278-29L585		\$5,138	\$5,653
	22	72	29	288	32	FLT2272-29L585	\$3,846		
	22	72	29	288	32	FLV2272-29L585		\$4,993	\$5,493
	22	66	29	269	30	FLT2266-29L585	\$3,783		
	22	66	29	269	30	FLV2266-29L585		\$4,913	\$5,404
	22	60	29	252	27	FLT2260-29L585	\$3,715		
	22	60	29	252	27	FLV2260-29L585		\$4,825	\$5,307

Features:

- eased edge profile user side
- pedestal front locking
- hinged door compartment has one adjustable shelf

Options:

- must specify chassis grain direction on artisan veneer, see pages 13-15 for details
- locking doors available, specify and add \$147 list
- veneer door and drawer fronts in paint available, specify paint color and add \$354; see page 16 for details
- on laminate units, contrasting worksurface tops and door fronts available, no upcharge; specify laminate color, see page 16 for details
- ledge pulls standard; prism pulls available, specify and see page 9
- oval grommets in back panel can be eliminated upon request, no upcharge
- interior horizontal wire manager with end grommets available, specify and add \$189 list; see page 40 for details
- top grommet available, specify location; add \$135 list each; see page 46 for details
- worksurface power available, specify "to accommodate EC26" on your purchase order; EC26 unit must be ordered separately, see page 46

 Box/Lateral Storage Credenza with Open Center - Inset Legs	22	72	29	295	32	FLT2272-29S585	\$3,846		
	22	72	29	295	32	FLV2272-29S585		\$4,993	\$5,493
	22	60	29	250	27	FLT2260-29S585	\$3,715		
	22	60	29	250	27	FLV2260-29S585		\$4,825	\$5,307

Features:

- eased edge profile user side
- pedestal front locking
- hinged door compartment has one adjustable shelf

Options:

- must specify chassis grain direction on artisan veneer, see pages 13-15 for details
- locking doors available, specify and add \$147 list
- veneer door and drawer fronts in paint available, specify paint color and add \$354; see page 16 for details
- on laminate units, contrasting worksurface tops and door fronts available, no upcharge; specify laminate color, see page 16 for details
- ledge pulls standard; prism pulls available, specify and see page 9
- oval grommets in back panel can be eliminated upon request, no upcharge
- interior horizontal wire manager with end grommets available, specify and add \$189 list; see page 40 for details
- top grommet available, specify location; add \$135 list each; see page 46 for details
- worksurface power available, specify "to accommodate EC26" on your purchase order; EC26 unit must be ordered separately, see page 46

To Order, Specify:

① Laminate Model #	② Laminate Type	③ Laminate Selection	④ Metal Color	⑤ Other Product Options
Laminate (FLT)	HPL	See Laminate Selection	See Metal Finish Color Options	See list of options for each specific unit; Specify and add accordingly.
① Veneer Model #	② Wood Collection	③ Wood Finish	④ Metal Color	⑤ Other Product Options
Veneer (FLV)	Essentials	See Essentials Wood Finish Options	See Metal Finish Color Options	See list of options for each specific unit; Specify and add accordingly.
	Artisan	Ⓐ Wood Finish See Artisan Wood Finish Options	Ⓑ Chassis Grain Direction For Artisan Only: Vertical Horizontal	

Description	D	W	H	CTN WT	CU FT	① Model	HPL Laminate	Essentials Veneer	Artisan Veneer
Box/Lateral File Credenza - Flush Legs	22	90	29	392	40	FLT2290-29L666	\$4,246		
	22	90	29	392	40	FLV2290-29L666		\$5,514	\$6,066

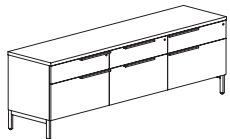

Features:

- eased edge profile user side
- pedestal front locking

Options:

- must specify chassis grain direction on artisan veneer, see pages 13-15 for details
- concealed box drawer(s) available, specify location in unit; add \$246 list for each laminate drawer or \$375 for each veneer drawer, see page 25 for details
- veneer drawer fronts in paint available, specify paint color and add \$354 list; see page 16 for details
- on laminate units, contrasting worksurface tops and drawer fronts available, no upcharge; specify color, see page 16 for details
- ledge pulls standard; prism pulls available, specify and see page 9
- oval grommets in back panel can be eliminated upon request, no upcharge
- interior horizontal wire manager with end grommets available, specify and add \$189 list; see page 40 for details
- top grommet available, specify location; add \$135 list each; see page 46 for details

FLUX

Box/Lateral File Credenza - Inset Legs	22	90	29	301	32	FLT2290-29S666	\$4,246		
	22	90	29	301	32	FLV2290-29S666		\$5,514	\$6,066

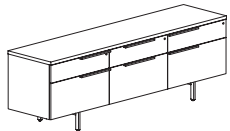

Features:

- eased edge profile user side
- pedestal front locking

Options:

- must specify chassis grain direction on artisan veneer, see pages 13-15 for details
- concealed box drawer(s) available, specify location in unit; add \$246 list for each laminate drawer or \$375 for each veneer drawer, see page 25 for details
- veneer drawer fronts in paint available, specify paint color and add \$354 list; see page 16 for details
- on laminate units, contrasting worksurface tops and drawer fronts available, no upcharge; specify color, see page 16 for details
- ledge pulls standard; prism pulls available, specify and see page 9
- oval grommets in back panel can be eliminated upon request, no upcharge
- interior horizontal wire manager with end grommets available, specify and add \$189 list; see page 40 for details
- top grommet available, specify location; add \$135 list each; see page 46 for details

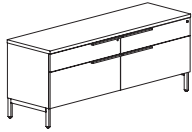
Description	D	W	H	CTN WT	CU FT	① Model	HPL Laminate	Essentials Veneer	Artisan Veneer
 Box/Lateral File Credenza - Flush Legs	22	72	29	303	32	FLT2272-29L66	\$3,331		
	22	72	29	303	32	FLV2272-29L66		\$4,321	\$4,754
	22	60	29	268	27	FLT2260-29L66	\$3,225		
	22	60	29	268	27	FLV2260-29L66		\$4,189	\$4,611

Features:

- eased edge profile user side
- pedestal front locking

Options:

- must specify chassis grain direction on artisan veneer, see pages 13-15 for details
- concealed box drawer(s) available, specify location in unit; add \$246 list for each laminate drawer or \$375 for each veneer drawer, see page 25 for details
- veneer drawer fronts in paint available, specify paint color and add \$354 list; see page 16 for details
- on laminate units, contrasting worksurface tops and drawer fronts available, no upcharge; specify color, see page 16 for details
- ledge pulls standard; prism pulls available, specify and see page 9
- oval grommets in back panel can be eliminated upon request, no upcharge
- interior horizontal wire manager with end grommets available, specify and add \$189 list; see page 40 for details
- top grommet available, specify location; add \$135 list each; see page 46 for details

Description	D	W	H	CTN WT	CU FT	① Model	HPL Laminate	Essentials Veneer	Artisan Veneer
 Box/Lateral File Credenza - Inset Legs	22	72	29	266	27	FLT2272-29S66	\$3,331		
	22	72	29	266	27	FLV2272-29S66		\$4,321	\$4,754
	22	60	29	323	40	FLT2260-29S66	\$3,225		
	22	60	29	323	40	FLV2260-29S66		\$4,189	\$4,611

Features:

- eased edge profile user side
- pedestal front locking

Options:

- must specify chassis grain direction on artisan veneer, see pages 13-15 for details
- concealed box drawer(s) available, specify location in unit; add \$246 list for each laminate drawer or \$375 for each veneer drawer, see page 25 for details
- veneer drawer fronts in paint available, specify paint color and add \$354 list; see page 16 for details
- on laminate units, contrasting worksurface tops and drawer fronts available, no upcharge; specify color, see page 16 for details
- ledge pulls standard; prism pulls available, specify and see page 9
- oval grommets in back panel can be eliminated upon request, no upcharge
- interior horizontal wire manager with end grommets available, specify and add \$189 list; see page 40 for details
- top grommet available, specify location; add \$135 list each; see page 46 for details

To Order, Specify:

① Laminate Model #	② Laminate Type	③ Laminate Selection	④ Metal Color	⑤ Other Product Options
Laminate (FLT)	HPL	See Laminate Selection	See Metal Finish Color Options	See list of options for each specific unit; Specify and add accordingly.
① Veneer Model #	② Wood Collection	③ Wood Finish	④ Metal Color	⑤ Other Product Options
Veneer (FLV)	Essentials	See Essentials Wood Finish Options	See Metal Finish Color Options	See list of options for each specific unit; Specify and add accordingly.
	Artisan	ⓐ Wood Finish See Artisan Wood Finish Options	ⓑ Chassis Grain Direction For Artisan Only: Vertical Horizontal	

FLUX

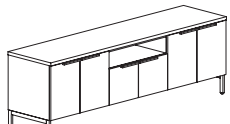
Description	D	W	H	CTN WT	CU FT	① Model	HPL Laminate	Essentials Veneer	Artisan Veneer
Six Door Credenza Open Center - Flush Legs 	22	96	29	332	43	FLT2296-29L787	\$4,073		
	22	96	29	332	43	FLV2296-29L787		\$5,287	\$5,817
	22	90	29	321	40	FLT2290-29L787	\$3,975		
	22	90	29	321	40	FLV2290-29L787		\$5,162	\$5,678
	22	84	29	296	38	FLT2284-29L787	\$3,871		
	22	84	29	296	38	FLV2284-29L787		\$5,026	\$5,529

Features:

- eased edge profile user side
- each end compartment has one adjustable shelf

Options:

- must specify chassis grain direction on artisan veneer, see pages 13-15 for details
- locking doors available, specify and add \$441 list
- veneer door fronts in paint available, specify paint color and add \$354 list; see page 16 for details
- on laminate units, contrasting worksurface tops and door fronts available, no upcharge; specify laminate color, see page 16 for details
- ledge pulls standard; prism pulls available, specify and see page 9
- oval grommets in back panel can be eliminated upon request, no upcharge
- interior horizontal wire manager with end grommets available, specify and add \$189 list; see page 40 for details
- top grommet available, specify location; add \$135 list each; see page 46 for details
- worksurface power available, specify "to accommodate EC26" on your purchase order; EC26 unit must be ordered separately, see page 46

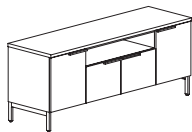
Four Door Credenza Open Center - Flush Legs 	22	78	29	279	35	FLT2278-29L787	\$3,754		
	22	78	29	279	35	FLV2278-29L787		\$4,875	\$5,361
	22	72	29	265	32	FLT2272-29L787	\$3,635		
	22	72	29	265	32	FLV2272-29L787		\$4,718	\$5,191
	22	66	29	247	30	FLT2266-29L787	\$3,547		
	22	66	29	247	30	FLV2266-29L787		\$4,605	\$5,066
	22	60	29	229	27	FLT2260-29L787	\$3,454		
	22	60	29	229	27	FLV2260-29L787		\$4,484	\$4,934

Features:

- eased edge profile user side
- each end compartment has one adjustable shelf

Options:

- must specify chassis grain direction on artisan veneer, see pages 13-15 for details
- locking doors available, specify and add \$441 list
- veneer door fronts in paint available, specify paint color and add \$354 list; see page 16 for details
- on laminate units, contrasting worksurface tops and door fronts available, no upcharge; specify laminate color, see page 16 for details
- ledge pulls standard; prism pulls available, specify and see page 9
- oval grommets in back panel can be eliminated upon request, no upcharge
- interior horizontal wire manager with end grommets available, specify and add \$189 list; see page 40 for details
- top grommet available, specify location; add \$135 list each; see page 46 for details
- worksurface power available, specify "to accommodate EC26" on your purchase order; EC26 unit must be ordered separately, see page 46

Description	D	W	H	CTN WT	CU FT	① Model	HPL Laminate	Essentials Veneer	Artisan Veneer
Six Door Storage with Open Center - Inset Legs	22	90	29	318	40	FLT2290-29S787	\$3,975		
	22	90	29	318	40	FLV2290-29S787		\$5,162	\$5,678

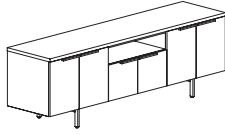

Features:

- eased edge profile user side
- each end compartment has one adjustable shelf

Options:

- must specify chassis grain direction on artisan veneer, see pages 13-15 for details
- locking doors available, specify and add \$441 list
- veneer door fronts in paint available, specify paint color and add \$354 list; see page 16 for details
- on laminate units, contrasting worksurface tops and door fronts available, no upcharge; specify color, see page 16 for details
- ledge pulls standard; prism pulls available, specify and see page 9
- oval grommets in back panel can be eliminated upon request, no upcharge
- interior horizontal wire manager with end grommets available, specify and add \$189 list; see page 40 for details
- top grommet available, specify location; add \$135 list each; see page 46 for details
- worksurface power available, specify "to accommodate EC26" on your purchase order; EC26 unit must be ordered separately, see page 46

Hinge Door Storage with Open Center - Inset Legs	22	72	29	270	32	FLT2272-29S787	\$3,635		
	22	72	29	270	32	FLV2272-29S787		\$4,718	\$5,191
	22	60	29	234	27	FLT2260-29S787	\$3,454		
	22	60	29	234	27	FLV2260-29S787		\$4,484	\$4,934

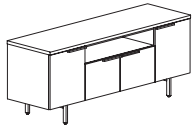

Features:

- eased edge profile user side
- each end compartment has one adjustable shelf

Options:

- must specify chassis grain direction on artisan veneer, see pages 13-15 for details
- locking doors available, specify and add \$441 list
- veneer door fronts in paint available, specify paint color and add \$354 list; see page 16 for details
- on laminate units, contrasting worksurface tops and door fronts available, no upcharge; specify color, see page 16 for details
- ledge pulls standard; prism pulls available, specify and see page 9
- oval grommets in back panel can be eliminated upon request, no upcharge
- interior horizontal wire manager with end grommets available, specify and add \$189 list; see page 40 for details
- top grommet available, specify location; add \$135 list each; see page 46 for details
- worksurface power available, specify "to accommodate EC26" on your purchase order; EC26 unit must be ordered separately, see page 46

To Order, Specify:

① Laminate Model #	② Laminate Type	③ Laminate Selection	④ Metal Color	⑤ Other Product Options		
Laminate (FLT)	HPL	See Laminate Selection	See Metal Finish Color Options	See list of options for each specific unit; Specify and add accordingly.		
① Veneer Model #	② Wood Collection	③ Wood Finish	④ Metal Color	⑤ Other Product Options		
Veneer (FLV)	Essentials	See Essentials Wood Finish Options	See Metal Finish Color Options	See list of options for each specific unit; Specify and add accordingly.		
	Artisan	<table border="1"> <thead> <tr> <th>ⓐ Wood Finish</th> <th>ⓑ Chassis Grain Direction</th> </tr> </thead> <tbody> <tr> <td>See Artisan Wood Finish Options</td> <td>For Artisan Only: Vertical Horizontal</td> </tr> </tbody> </table>	ⓐ Wood Finish		ⓑ Chassis Grain Direction	See Artisan Wood Finish Options
ⓐ Wood Finish	ⓑ Chassis Grain Direction					
See Artisan Wood Finish Options	For Artisan Only: Vertical Horizontal					

FLUX

Description	D	W	H	CTN WT	CU FT	① Model	HPL Laminate	Essentials Veneer	Artisan Veneer
Six Door Storage Credenza - Flush Legs	22	96	29	336	43	FLT2296-29L777	\$4,110		
	22	96	29	336	43	FLV2296-29L777		\$5,336	\$5,871
	22	90	29	326	40	FLT2290-29L777	\$4,010		
	22	90	29	326	40	FLV2290-29L777		\$5,206	\$5,728
	22	84	29	302	38	FLT2284-29L777	\$3,917		
	22	84	29	302	38	FLV2284-29L777		\$5,088	\$5,597

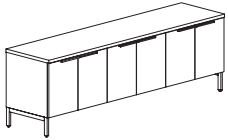

Features:

- eased edge profile user side
- each hinged door compartment has one adjustable shelf

Options:

- must specify chassis grain direction on artisan veneer, see pages 13-15 for details
- locking doors available, specify and add \$441 list
- veneer door fronts in paint available, specify paint color and add \$354 list; see page 16 for details
- on laminate units, contrasting worksurface tops and door fronts available, no upcharge; specify color, see page 16 for details
- ledge pulls standard; prism pulls available, specify and see page 9
- oval grommets in back panel can be eliminated upon request, no upcharge
- interior horizontal wire manager with end grommets available, specify and add \$189 list; see page 40 for details
- top grommet available, specify location; add \$135 list each; see page 46 for details
- worksurface power available, specify "to accommodate EC26" on your purchase order; EC26 unit must be ordered separately, see page 46

Six Door Storage Credenza - Inset Legs	22	90	29	320	40	FLT2290-29S777	\$4,010		
	22	90	29	320	40	FLV2290-29S777		\$5,206	\$5,728

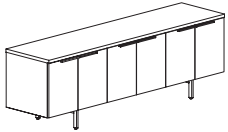

Features:

- eased edge profile user side
- each hinged door compartment has one adjustable shelf

Options:

- must specify chassis grain direction on artisan veneer, see pages 13-15 for details
- locking doors available, specify and add \$441 list
- veneer door fronts in paint available, specify paint color and add \$354 list; see page 16 for details
- on laminate units, contrasting worksurface tops and door fronts available, no upcharge; specify color, see page 16 for details
- ledge pulls standard; prism pulls available, specify and see page 9
- oval grommets in back panel can be eliminated upon request, no upcharge
- interior horizontal wire manager with end grommets available, specify and add \$189 list; see page 40 for details
- top grommet available, specify location; add \$135 list each; see page 46 for details
- worksurface power available, specify "to accommodate EC26" on your purchase order; EC26 unit must be ordered separately, see page 46

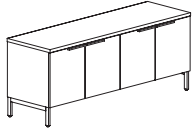
Description	D	W	H	CTN WT	CU FT	① Model	HPL Laminate	Essentials Veneer	Artisan Veneer
Four Door Storage Credenza - Flush Legs 	22	78	29	277	35	FLT2278-29L77	\$3,649		
	22	78	29	277	35	FLV2278-29L77		\$4,740	\$5,214
	22	72	29	263	32	FLT2272-29L77	\$3,548		
	22	72	29	263	32	FLV2272-29L77		\$4,607	\$5,068
	22	66	29	239	30	FLT2266-29L77	\$3,434		
	22	66	29	239	30	FLV2266-29L77		\$4,459	\$4,902
	22	60	29	226	27	FLT2260-29L77	\$3,317		
	22	60	29	226	27	FLV2260-29L77		\$4,308	\$4,739

Features:

- eased edge profile user side
- each hinged door compartment has one adjustable shelf

Options:

- must specify chassis grain direction on artisan veneer, see pages 13-15 for details
- locking doors available, specify and add \$294 list
- veneer door fronts in paint available, specify paint color and add \$354 list; see page 16 for details
- on laminate units, contrasting worksurface tops and door fronts available, no upcharge; specify color, see page 16 for details
- ledge pulls standard; prism pulls available, specify and see page 9
- oval grommets in back panel can be eliminated upon request, no upcharge
- interior horizontal wire manager with end grommets available, specify and add \$189 list; see page 40 for details
- top grommet available, specify location; add \$135 list each; see page 46 for details
- worksurface power available, specify "to accommodate EC26" on your purchase order; EC26 unit must be ordered separately, see page 46

Four Door Storage Credenza - Inset Legs 	22	72	29	258	32	FLT2272-29S77	\$3,548		
	22	72	29	258	32	FLV2272-29S77		\$4,607	\$5,068
	22	60	29	224	27	FLT2260-29S77	\$3,317		
	22	60	29	224	27	FLV2260-29S77		\$4,308	\$4,739

Features:

- eased edge profile user side
- each hinged door compartment has one adjustable shelf

Options:

- must specify chassis grain direction on artisan veneer, see pages 13-15 for details
- locking doors available, specify and add \$294 list
- veneer door fronts in paint available, specify paint color and add \$354 list; see page 16 for details
- on laminate units, contrasting worksurface tops and door fronts available, no upcharge; specify color, see page 16 for details
- ledge pulls standard; prism pulls available, specify and see page 9
- oval grommets in back panel can be eliminated upon request, no upcharge
- interior horizontal wire manager with end grommets available, specify and add \$189 list; see page 40 for details
- top grommet available, specify location; add \$135 list each; see page 46 for details
- worksurface power available, specify "to accommodate EC26" on your purchase order; EC26 unit must be ordered separately, see page 46

To Order, Specify:

① Laminate Model #	② Laminate Type	③ Laminate Selection	④ Metal Color	⑤ Other Product Options
Laminate (FLT)	HPL	See Laminate Selection	See Metal Finish Color Options	See list of options for each specific unit; Specify and add accordingly.
① Veneer Model #	② Wood Collection	③ Wood Finish	④ Metal Color	⑤ Other Product Options
Veneer (FLV)	Essentials	See Essentials Wood Finish Options	See Metal Finish Color Options	See list of options for each specific unit; Specify and add accordingly.
	Artisan	ⓐ Wood Finish See Artisan Wood Finish Options	ⓑ Chassis Grain Direction For Artisan Only: Vertical Horizontal	

Description	D	W	H	CTN WT	CU FT	① Model	HPL Laminate	Essentials Veneer	Artisan Veneer
Three Door Storage Credenza - Flush Legs	22	54	29	207	25	FLT2254-29L77R	\$3,068		
	22	54	29	207	25	FLV2254-29L77R		\$3,982	\$4,382
	22	54	29	207	25	FLT2254-29L77L	\$3,068		
	22	54	29	207	25	FLV2254-29L77L		\$3,982	\$4,382
	22	42	29	171	19	FLT2242-29L77R	\$2,938		
	22	42	29	171	19	FLV2242-29L77R		\$3,814	\$4,195
	22	42	29	171	19	FLT2242-29L77L	\$2,938		
	22	42	29	171	19	FLV2242-29L77L		\$3,814	\$4,195

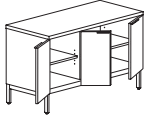

left shown

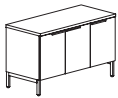

right

Features:

- eased edge profile user side
- each hinged door compartment has one adjustable shelf

Options:

- must specify chassis grain direction on artisan veneer, see pages 13-15 for details
- locking doors available, specify and add \$294 list
- veneer door fronts in paint available, specify paint color and add \$354 list; see page 16 for details
- on laminate units, contrasting worksurface tops and door fronts available, no upcharge; specify color, see page 16 for details
- ledge pulls standard; prism pulls available, specify and see page 9
- oval grommet in back panel can be eliminated upon request, no upcharge
- interior horizontal wire manager with end grommets available, specify and add \$189 list; see page 40 for details
- top grommet available, specify location; add \$135 list each; see page 46 for details
- worksurface power available, specify "to accommodate EC26" on your purchase order; EC26 unit must be ordered separately, see page 46

Description	D	W	H	CTN WT	CU FT	① Model	HPL Laminate	Essentials Veneer	Artisan Veneer
Two Door Storage - Flush Legs	22	36	29	144	17	FLT2236-29L7	\$2,823		
	22	36	29	144	17	FLV2236-29L7		\$3,665	\$4,029
	22	30	29	126	14	FLT2230-29L7	\$2,767		
	22	30	29	126	14	FLV2230-29L7		\$3,590	\$3,950



Features:

- eased edge profile user side
- hinged door compartment has one adjustable shelf

Options:

- must specify chassis grain direction on artisan veneer, see pages 13-15 for details
- locking doors available, specify and add \$147 list
- veneer door fronts in paint available, specify paint color and add \$354 list; see page 16 for details
- on laminate units, contrasting worksurface tops and door fronts available, no upcharge; specify color, see page 16 for details
- ledge pulls standard; prism pulls available, specify and see page 9
- oval grommet in back panel can be eliminated upon request, no upcharge
- interior horizontal wire manager with end grommets available, specify and add \$189 list; see page 40 for details
- top grommet available, specify location; add \$135 list each; see page 46 for details
- worksurface power available, specify "to accommodate EC26" on your purchase order; EC26 unit must be ordered separately, see page 46

FLUX

To Order, Specify:

① Laminate Model #	② Laminate Type	③ Laminate Selection		④ Metal Color	⑤ Other Product Options
Laminate (FLT)	HPL	See Laminate Selection		See Metal Finish Color Options	See list of options for each specific unit; Specify and add accordingly.
① Veneer Model #	② Wood Collection	③ Wood Finish		④ Metal Color	⑤ Other Product Options
Veneer (FLV)	Essentials	See Essentials Wood Finish Options		See Metal Finish Color Options	See list of options for each specific unit; Specify and add accordingly.
	Artisan	ⓐ Wood Finish See Artisan Wood Finish Options	ⓑ Chassis Grain Direction For Artisan Only: Vertical Horizontal		

Description	D	W	H	CTN WT	CU FT	① Model	HPL Laminate	Essentials Veneer	Artisan Veneer
Box/Lateral with Open Storage Credenza - Flush Legs	22	96	29	352	43	FLT2296-29L606	\$4,165		
	22	96	29	352	43	FLV2296-29L606		\$5,408	\$5,950
	22	90	29	345	40	FLT2290-29L606	\$4,065		
	22	90	29	345	40	FLV2290-29L606		\$5,277	\$5,805

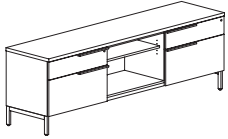

Features:

- eased edge profile user side
- pedestal front locking
- open compartment with adjustable shelf
- shelf 12 1/2"d

Options:

- must specify chassis grain direction on artisan veneer, see pages 13-15 for details
- concealed box drawer(s) available, specify location in unit; add \$246 list for each laminate drawer or \$375 for each veneer drawer, see page 25 for details
- veneer drawer fronts in paint available, specify paint color and add \$354 list; see page 16 for details
- on laminate units, contrasting worksurface tops and drawer fronts available, no upcharge; specify color, see page 16 for details
- ledge pulls standard; prism pulls available, specify and see page 9
- oval grommets in back panel can be eliminated upon request, no upcharge
- interior horizontal wire manager with end grommets available, specify and add \$189 list; see page 40 for details
- top grommet available, specify location; add \$135 list each; see page 46 for details
- worksurface power available, specify "to accommodate EC26" on your purchase order; EC26 unit must be ordered separately, see page 46

Box/Lateral File with Open Storage Credenza - Inset Legs	22	90	29	367	40	FLT2290-29S606	\$4,065		
	22	90	29	367	40	FLV2290-29S606		\$5,277	\$5,805

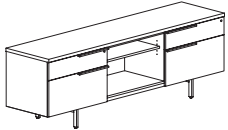

Features:

- eased edge profile user side
- pedestal front locking
- open compartment with adjustable shelf
- shelf 12 1/2"d

Options:

- must specify chassis grain direction on artisan veneer, see pages 13-15 for details
- concealed box drawer(s) available, specify location in unit; add \$246 list for each laminate drawer or \$375 for each veneer drawer, see page 25 for details
- veneer drawer fronts in paint available, specify paint color and add \$354 list; see page 16 for details
- on laminate units, contrasting worksurface tops and drawer fronts available, no upcharge; specify color, see page 16 for details
- ledge pulls standard; prism pulls available, specify and see page 9
- oval grommets in back panel can be eliminated upon request, no upcharge
- interior horizontal wire manager with end grommets available, specify and add \$189 list; see page 40 for details
- top grommet available, specify location; add \$135 list each; see page 46 for details
- worksurface power available, specify "to accommodate EC26" on your purchase order; EC26 unit must be ordered separately, see page 46

Description	D	W	H	CTN WT	CU FT	① Model	HPL Laminate	Essentials Veneer	Artisan Veneer
Box/Lateral with Open Storage Credenza - Flush Legs	22	96	29	320	43	FLT2296-29L060	\$3,914		
	22	96	29	320	43	FLV2296-29L060		\$5,082	\$5,591
	22	90	29	312	40	FLT2290-29L060	\$3,819		
	22	90	29	312	40	FLV2290-29L060		\$4,960	\$5,455

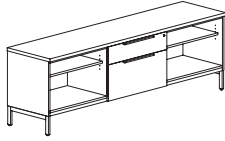

Features:

- eased edge profile user side
- pedestal front locking
- each open compartment has one adjustable shelf
- shelves 12 1/2"d

Options:

- must specify chassis grain direction on artisan veneer, see pages 13-15 for details
- concealed box drawer available, specify; add \$246 list for each laminate drawer or \$375 for each veneer drawer, see page 25 for details
- veneer drawer fronts in paint available, specify paint color and add \$354 list; see page 16 for details
- on laminate units, contrasting worksurface tops and drawer fronts available, no upcharge; specify color, see page 16 for details
- ledge pulls standard; prism pulls available, specify and see page 9
- oval grommets in back panel can be eliminated upon request, no upcharge
- interior horizontal wire manager with end grommets available, specify and add \$189 list; see page 40 for details
- top grommet available, specify location; add \$135 list each; see page 46 for details
- worksurface power available, specify "to accommodate EC26" on your purchase order; EC26 unit must be ordered separately, see page 46

Box/File with Open Storage Credenza - Inset Legs	22	90	29	330	40	FLT2290-29S060	\$3,819		
	22	90	29	330	40	FLV2290-29S060		\$4,960	\$5,455

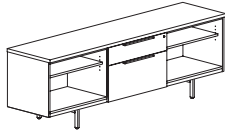

Features:

- eased edge profile user side
- pedestal front locking
- each open compartment has one adjustable shelf
- shelves 12 1/2"d

Options:

- must specify chassis grain direction on artisan veneer, see pages 13-15 for details
- concealed box drawer available, specify; add \$246 list for each laminate drawer or \$375 for each veneer drawer, see page 25 for details
- veneer drawer fronts in paint available, specify paint color and add \$354 list; see page 16 for details
- on laminate units, contrasting worksurface tops and drawer fronts available, no upcharge; specify color, see page 16 for details
- ledge pulls standard; prism pulls available, specify and see page 9
- oval grommets in back panel can be eliminated upon request, no upcharge
- interior horizontal wire manager with end grommets available, specify and add \$189 list; see page 40 for details
- top grommet available, specify location; add \$135 list each; see page 46 for details
- worksurface power available, specify "to accommodate EC26" on your purchase order; EC26 unit must be ordered separately, see page 46

To Order, Specify:

① Laminate Model #	② Laminate Type	③ Laminate Selection	④ Metal Color	⑤ Other Product Options		
Laminate (FLT)	HPL	See Laminate Selection	See Metal Finish Color Options	See list of options for each specific unit; Specify and add accordingly.		
① Veneer Model #	② Wood Collection	③ Wood Finish	④ Metal Color	⑤ Other Product Options		
Veneer (FLV)	Essentials	See Essentials Wood Finish Options	See Metal Finish Color Options	See list of options for each specific unit; Specify and add accordingly.		
	Artisan	<table border="1"> <thead> <tr> <th>ⓐ Wood Finish</th> <th>ⓑ Chassis Grain Direction</th> </tr> </thead> <tbody> <tr> <td>See Artisan Wood Finish Options</td> <td>For Artisan Only: Vertical Horizontal</td> </tr> </tbody> </table>	ⓐ Wood Finish		ⓑ Chassis Grain Direction	See Artisan Wood Finish Options
ⓐ Wood Finish	ⓑ Chassis Grain Direction					
See Artisan Wood Finish Options	For Artisan Only: Vertical Horizontal					

Description	D	W	H	CTN WT	CU FT	① Model	HPL Laminate	Essentials Veneer	Artisan Veneer
Box/Lateral File with Open Storage Credenza - Flush Legs	22	96	29	360	43	FLT2296-29L066	\$4,165		
	22	96	29	360	43	FLV2296-29L066		\$5,408	\$5,950
	22	96	29	360	43	FLT2296-29L660	\$4,165		
	22	96	29	360	43	FLV2296-29L660		\$5,408	\$5,950
	22	90	29	353	40	FLT2290-29L066	\$4,065		
	22	90	29	353	40	FLV2290-29L066		\$5,277	\$5,805
	22	90	29	353	40	FLT2290-29L660	\$4,065		
	22	90	29	353	40	FLV2290-29L660		\$5,277	\$5,805

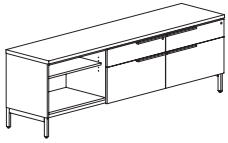

*066 shown

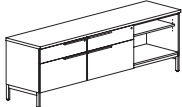

*660

Features:

- eased edge profile user side
- pedestal front locking
- open compartment with adjustable shelf
- shelf 12 1/2"d

Options:

- must specify chassis grain direction on artisan veneer, see pages 13-15 for details
- concealed box drawer(s) available, specify location in unit; add \$246 list for each laminate drawer or \$375 for each veneer drawer, see page 25 for details
- veneer drawer fronts in paint available, specify paint color and add \$354 list; see page 16 for details
- on laminate units, contrasting worksurface tops and drawer fronts available, no upcharge; specify color, see page 16 for details
- ledge pulls standard; prism pulls available, specify and see page 9
- oval grommets in back panel can be eliminated upon request, no upcharge
- interior horizontal wire manager with end grommets available, specify and add \$189 list; see page 40 for details
- top grommet available, specify location; add \$135 list each; see page 47 for details
- worksurface power available, specify "to accommodate EC26" on your purchase order; EC26 unit must be ordered separately, see page 47

Description	D	W	H	CTN WT	CU FT	① Model	HPL Laminate	Essentials Veneer	Artisan Veneer
Box/Lateral File with Open Storage Credenza - Inset Legs	22	90	29	350	40	FLT2290-29S066	\$4,065		
	22	90	29	350	40	FLV2290-29S066		\$5,277	\$5,805
	22	90	29	350	40	FLT2290-29S660	\$4,065		
	22	90	29	350	40	FLV2290-29S660		\$5,277	\$5,805

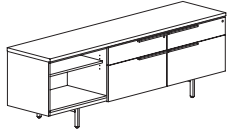

*066 shown

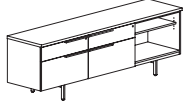

*660

Features:

- eased edge profile user side
- pedestal front locking
- open compartment with adjustable shelf
- shelf 12 1/2" d

Options:

- must specify chassis grain direction on artisan veneer, see pages 13-15 for details
- concealed box drawer(s) available, specify location in unit; add \$246 list for each laminate drawer or \$375 for each veneer drawer, see page 25 for details
- veneer drawer fronts in paint available, specify paint color and add \$354 list; see page 16 for details
- on laminate units, contrasting worksurface tops and drawer fronts available, no upcharge; specify color, see page 16 for details
- ledge pulls standard; prism pulls available, specify and see page 9
- oval grommets in back panel can be eliminated upon request, no upcharge
- interior horizontal wire manager with end grommets available, specify and add \$189 list; see page 40 for details
- top grommet available, specify location; add \$135 list each; see page 47 for details
- worksurface power available, specify "to accommodate EC26" on your purchase order; EC26 unit must be ordered separately, see page 47

FLUX

To Order, Specify:

① Laminate Model #	② Laminate Type	③ Laminate Selection	④ Metal Color	⑤ Other Product Options		
Laminate (FLT)	HPL	See Laminate Selection	See Metal Finish Color Options	See list of options for each specific unit; Specify and add accordingly.		
① Veneer Model #	② Wood Collection	③ Wood Finish	④ Metal Color	⑤ Other Product Options		
Veneer (FLV)	Essentials	See Essentials Wood Finish Options	See Metal Finish Color Options	See list of options for each specific unit; Specify and add accordingly.		
	Artisan	<table border="1"> <tr> <th>ⓐ Wood Finish</th> <th>ⓑ Chassis Grain Direction</th> </tr> <tr> <td>See Artisan Wood Finish Options</td> <td>For Artisan Only: Vertical Horizontal</td> </tr> </table>	ⓐ Wood Finish		ⓑ Chassis Grain Direction	See Artisan Wood Finish Options
ⓐ Wood Finish	ⓑ Chassis Grain Direction					
See Artisan Wood Finish Options	For Artisan Only: Vertical Horizontal					

Description	D	W	H	CTN WT	CU FT	① Model	HPL Laminate	Essentials Veneer	Artisan Veneer
Box/Lateral File with Open Storage Credenza - Flush Legs	22	72	29	265	32	FLT2272-29L06	\$3,349		
	22	72	29	265	32	FLV2272-29L06		\$4,346	\$4,779
	22	72	29	265	32	FLT2272-29L60	\$3,349		
	22	72	29	265	32	FLV2272-29L60		\$4,346	\$4,779
	22	66	29	238	30	FLT2266-29L06	\$3,213		
	22	66	29	238	30	FLV2266-29L06		\$4,172	\$4,589
	22	66	29	238	30	FLT2266-29L60	\$3,213		
	22	66	29	238	30	FLV2266-29L60		\$4,172	\$4,589
	22	60	29	238	27	FLT2260-29L06	\$3,082		
	22	60	29	238	27	FLV2260-29L06		\$4,001	\$4,401
	22	60	29	228	27	FLT2260-29L60	\$3,082		
	22	60	29	228	27	FLV2260-29L60		\$4,001	\$4,401

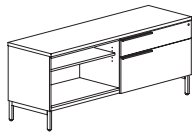

*06 shown

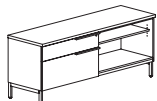

*60

Features:

- eased edge profile user side
- pedestal front locking
- open compartment with adjustable shelf
- shelf 12 1/2"d

Options:

- must specify chassis grain direction on artisan veneer, see pages 13-15 for details
- concealed box drawer available, specify; add \$246 list for each laminate drawer or \$375 for each veneer drawer, see page 25 for details
- veneer drawer fronts in paint available, specify paint color and add \$354 list; see page 16 for details
- on laminate units, contrasting worksurface tops and drawer fronts available, no upcharge; specify color, see page 16 for details
- ledge pulls standard; prism pulls available, specify and see page 9
- oval grommets in back panel can be eliminated upon request, no upcharge
- interior horizontal wire manager with end grommets available, specify and add \$189 list; see page 40 for details
- top grommet available, specify location; add \$135 list each; see page 47 for details
- worksurface power available, specify "to accommodate EC26" on your purchase order; EC26 unit must be ordered separately, see page 47

Description	D	W	H	CTN WT	CU FT	① Model	HPL Laminate	Essentials Veneer	Artisan Veneer
Box/Lateral File with Open Storage Credenza - Inset Legs	22	72	29	265	32	FLT2272-29S06	\$3,349		
	22	72	29	265	32	FLV2272-29S06		\$4,346	\$4,779
	22	72	29	265	32	FLT2272-29S60	\$3,349		
	22	72	29	265	32	FLV2272-29S60		\$4,346	\$4,779
	22	60	29	226	27	FLT2260-29S06	\$3,082		
	22	60	29	226	27	FLV2260-29S06		\$4,001	\$4,401
	22	60	29	226	27	FLT2260-29S60	\$3,082		
	22	60	29	226	27	FLV2260-29S60		\$4,001	\$4,401

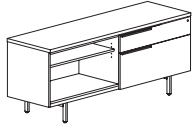

*06 shown

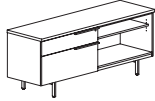

*60

Features:

- eased edge profile user side
- pedestal front locking
- open compartment with adjustable shelf
- shelf 12 1/2" d

Options:

- must specify chassis grain direction on artisan veneer, see pages 13-15 for details
- concealed box drawer available, specify; add \$246 list for each laminate drawer or \$375 for each veneer drawer, see page 25 for details
- veneer drawer fronts in paint available, specify paint color and add \$354 list; see page 16 for details
- on laminate units, contrasting worksurface tops and drawer fronts available, no upcharge; specify color, see page 16 for details
- ledge pulls standard; prism pulls available, specify and see page 9
- oval grommets in back panel can be eliminated upon request, no upcharge
- interior horizontal wire manager with end grommets available, specify and add \$189 list; see page 40 for details
- top grommet available, specify location; add \$135 list each; see page 47 for details
- worksurface power available, specify "to accommodate EC26" on your purchase order; EC26 unit must be ordered separately, see page 47

To Order, Specify:

① Laminate Model #	② Laminate Type	③ Laminate Selection	④ Metal Color	⑤ Other Product Options	
Laminate (FLT)	HPL	See Laminate Selection	See Metal Finish Color Options	See list of options for each specific unit; Specify and add accordingly.	
① Veneer Model #	② Wood Collection	③ Wood Finish	④ Metal Color	⑤ Other Product Options	
Veneer (FLV)	Essentials	See Essentials Wood Finish Options	See Metal Finish Color Options	See list of options for each specific unit; Specify and add accordingly.	
	Artisan	<table border="1"> <thead> <tr> <th>③a Wood Finish</th> <th>③b Chassis Grain Direction</th> </tr> </thead> <tbody> <tr> <td>See Artisan Wood Finish Options</td> <td>For Artisan Only: Vertical Horizontal</td> </tr> </tbody> </table>			③a Wood Finish
③a Wood Finish	③b Chassis Grain Direction				
See Artisan Wood Finish Options	For Artisan Only: Vertical Horizontal				

Description	D	W	H	CTN WT	CU FT	① Model	HPL Laminate	Essentials Veneer	Artisan Veneer
Double Sliding Door Credenza - Flush Legs	22	90	29	336	40	FLT2290-29L909	\$3,632		
	22	90	29	336	40	FLV2290-29L909		\$4,713	\$5,186

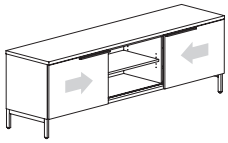

Features:

- eased edge profile user side
- locking doors not available
- open compartment with adjustable shelf
- shelves 12 1/2" d

Options:

- must specify chassis grain direction on artisan veneer, see pages 13-15 for details
- veneer door fronts in paint available, specify paint color and add \$354 list; see page 16 for details
- on laminate units, contrasting worksurface tops and door fronts available, no upcharge; specify color, see page 16 for details
- ledge pulls standard; prism pulls available, specify and see page 9
- oval grommets in back panel can be eliminated upon request, no upcharge
- interior horizontal wire manager with end grommets available, specify and add \$189 list; see page 40 for details
- top grommet available, specify location; add \$135 list each; see page 47 for details
- worksurface power available, specify "to accommodate EC26" on your purchase order; EC26 unit must be ordered separately, see page 47

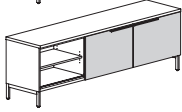
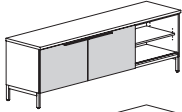

Double Sliding Door Credenza - Inset Legs	22	90	29	333	40	FLT2290-29S909	\$3,632		
	22	90	29	333	40	FLV2290-29S909		\$4,713	\$5,186

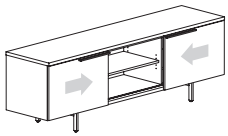

Features:

- eased edge profile user side
- locking doors not available
- open compartment with adjustable shelf
- shelves 12 1/2" d

Options:

- must specify chassis grain direction on artisan veneer, see pages 13-15 for details
- veneer door fronts in paint available, specify paint color and add \$354 list; see page 16 for details
- on laminate units, contrasting worksurface tops and door fronts available, no upcharge; specify color, see page 16 for details
- ledge pulls standard; prism pulls available, specify and see page 9
- oval grommets in back panel can be eliminated upon request, no upcharge
- interior horizontal wire manager with end grommets available, specify and add \$189 list; see page 40 for details
- top grommet available, specify location; add \$135 list each; see page 47 for details
- worksurface power available, specify "to accommodate EC26" on your purchase order; EC26 unit must be ordered separately, see page 47

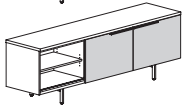
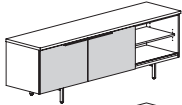

FLUX

Description	D	W	H	CTN WT	CU FT	① Model	HPL Laminate	Essentials Veneer	Artisan Veneer
Sliding Door Credenza - Flush Legs	22	90	29	319	40	FLT2290-29L090	\$3,483		
	22	90	29	319	40	FLV2290-29L090		\$4,523	\$4,976

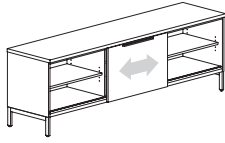

Features:

- eased edge profile user side
- locking door not available
- open compartment with adjustable shelf
- shelves 12 1/2"d

Options:

- must specify chassis grain direction on artisan veneer, see pages 13-15 for details
- veneer door fronts in paint available, specify paint color and add \$354 list; see page 16 for details
- on laminate units, contrasting worksurface tops and door fronts available, no upcharge; specify color, see page 16 for details
- ledge pulls standard; prism pulls available, specify and see page 9
- oval grommets in back panel can be eliminated upon request, no upcharge
- interior horizontal wire manager with end grommets available, specify and add \$189 list; see page 40 for details
- top grommet available, specify location; add \$135 list each; see page 47 for details
- worksurface power available, specify "to accommodate EC26" on your purchase order; EC26 unit must be ordered separately, see page 47

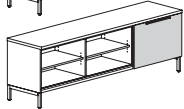
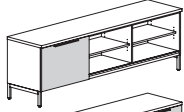

Sliding Door Credenza - Flush Legs	22	90	29	316	40	FLT2290-29S090	\$3,483		
	22	90	29	316	40	FLV2290-29S090		\$4,523	\$4,976

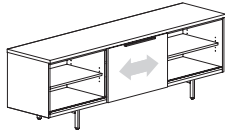

Features:

- eased edge profile user side
- locking door not available
- open compartment with adjustable shelf
- shelves 12 1/2"d

Options:

- must specify chassis grain direction on artisan veneer, see pages 13-15 for details
- veneer door fronts in paint available, specify paint color and add \$354 list; see page 16 for details
- on laminate units, contrasting worksurface tops and door fronts available, no upcharge; specify color, see page 16 for details
- ledge pulls standard; prism pulls available, specify and see page 9
- oval grommets in back panel can be eliminated upon request, no upcharge
- interior horizontal wire manager with end grommets available, specify and add \$189 list; see page 40 for details
- top grommet available, specify location; add \$135 list each; see page 47 for details
- worksurface power available, specify "to accommodate EC26" on your purchase order; EC26 unit must be ordered separately, see page 47

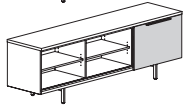
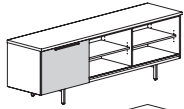

To Order, Specify:

① Laminate Model #	② Laminate Type	③ Laminate Selection	④ Metal Color	⑤ Other Product Options		
Laminate (FLT)	HPL	See Laminate Selection	See Metal Finish Color Options	See list of options for each specific unit; Specify and add accordingly.		
① Veneer Model #	② Wood Collection	③ Wood Finish	④ Metal Color	⑤ Other Product Options		
Veneer (FLV)	Essentials	See Essentials Wood Finish Options	See Metal Finish Color Options	See list of options for each specific unit; Specify and add accordingly.		
	Artisan	<table border="1"> <thead> <tr> <th>③a Wood Finish</th> <th>③b Chassis Grain Direction</th> </tr> </thead> <tbody> <tr> <td>See Artisan Wood Finish Options</td> <td>For Artisan Only: Vertical Horizontal</td> </tr> </tbody> </table>	③a Wood Finish		③b Chassis Grain Direction	See Artisan Wood Finish Options
③a Wood Finish	③b Chassis Grain Direction					
See Artisan Wood Finish Options	For Artisan Only: Vertical Horizontal					

Description	D	W	H	CTN WT	CU FT	① Model	HPL Laminate	Essentials Veneer	Artisan Veneer
Sliding Door Credenza - Flush Legs	22	72	29	250	32	FLT2272-29L09	\$3,124		
	22	72	29	250	32	FLV2272-29L09		\$4,057	\$4,463
	22	60	29	215	27	FLT2260-29L09	\$2,980		
	22	60	29	215	27	FLV2260-29L09		\$3,870	\$4,255

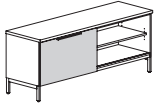
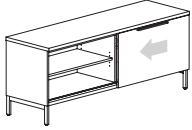

Features:

- eased edge profile user side
- locking door not available
- each compartment has one adjustable shelf
- shelves 12 1/2"d

Options:

- must specify chassis grain direction on artisan veneer, see pages 13-15 for details
- veneer door fronts in paint available, specify paint color and add \$354 list; see page 16 for details
- on laminate units, contrasting worksurface tops and door fronts available, no upcharge; specify color, see page 16 for details
- ledge pulls standard; prism pulls available, specify and see page 9
- oval grommets in back panel can be eliminated upon request, no upcharge
- interior horizontal wire manager with end grommets available, specify and add \$189 list; see page 40 for details
- top grommet available, specify location; add \$135 list each; see page 47 for details
- worksurface power available, specify "to accommodate EC26" on your purchase order; EC26 unit must be ordered separately, see page 47

Sliding Door Credenza - Inset Legs	22	72	29	244	32	FLT2272-29S09	\$3,124		
	22	72	29	244	32	FLV2272-29S09		\$4,057	\$4,463
	22	60	29	210	27	FLT2260-29S09	\$2,980		
	22	60	29	210	27	FLV2260-29S09		\$3,870	\$4,255

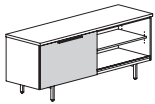
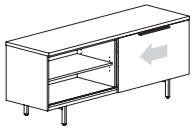

Features:

- eased edge profile user side
- locking door not available
- each compartment has one adjustable shelf
- shelves 12 1/2"d

Options:

- must specify chassis grain direction on artisan veneer, see pages 13-15 for details
- veneer door fronts in paint available, specify paint color and add \$354 list; see page 16 for details
- on laminate units, contrasting worksurface tops and door fronts available, no upcharge; specify color, see page 16 for details
- ledge pulls standard; prism pulls available, specify and see page 9
- oval grommets in back panel can be eliminated upon request, no upcharge
- interior horizontal wire manager with end grommets available, specify and add \$189 list; see page 40 for details
- top grommet available, specify location; add \$135 list each; see page 47 for details
- worksurface power available, specify "to accommodate EC26" on your purchase order; EC26 unit must be ordered separately, see page 47

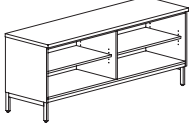
Description	D	W	H	CTN WT	CU FT	① Model	HPL Laminate	Essentials Veneer	Artisan Veneer
Open Compartment Credenza - Flush Legs 	22	72	29	230	32	FLT2272-29L00	\$2,980		
	22	72	29	230	32	FLV2272-29L00		\$3,870	\$4,255
	22	60	29	199	27	FLT2260-29L00	\$2,846		
	22	60	29	199	27	FLV2260-29L00		\$3,692	\$4,063

Features:

- eased edge profile user side
- each open compartment has one adjustable shelf
- shelves 12 1/2"d

Options:

- must specify chassis grain direction on artisan veneer, see pages 13-15 for details
- contrasting laminate worksurface tops, no upcharge; specify laminate color, see page 16 for details
- oval grommets in back panel can be eliminated upon request, no upcharge
- interior horizontal wire manager with end grommets available, specify and add \$189 list; see page 40 for details
- top grommet available, specify location and add \$135 list each; see page 47 for details

Description	D	W	H	CTN WT	CU FT	① Model	HPL Laminate	Essentials Veneer	Artisan Veneer
Open Compartment - Flush Legs 	22	36	29	136	17	FLT2236-29L0	\$2,145		
	22	36	29	136	17	FLV2236-29L0		\$2,783	\$3,060
	22	30	29	111	14	FLT2230-29L0	\$2,083		
	22	30	29	111	14	FLV2230-29L0		\$2,702	\$2,974

Features:

- eased edge profile user side
- open compartment with adjustable shelf
- shelves 12 1/2"d

Options:

- must specify chassis grain direction on artisan veneer, see pages 13-15 for details
- contrasting laminate worksurface tops, no upcharge; specify laminate color, see page 16 for details
- oval grommets in back panel can be eliminated upon request, no upcharge
- interior horizontal wire manager with end grommets available, specify and add \$189 list; see page 40 for details
- top grommet available, specify location and add \$135 list each; see page 47 for details

To Order, Specify:

① Laminate Model #	② Laminate Type	③ Laminate Selection	④ Metal Color	⑤ Other Product Options
Laminate (FLT)	HPL	See Laminate Selection	See Metal Finish Color Options	See list of options for each specific unit; Specify and add accordingly.
① Veneer Model #	② Wood Collection	③ Wood Finish	④ Metal Color	⑤ Other Product Options
Veneer (FLV)	Essentials	See Essentials Wood Finish Options	See Metal Finish Color Options	See list of options for each specific unit; Specify and add accordingly.
	Artisan	Ⓐ Wood Finish See Artisan Wood Finish Options	Ⓑ Chassis Grain Direction For Artisan Only: Vertical Horizontal	

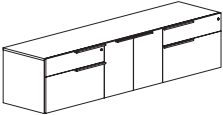
Description	D	W	H	CTN WT	CU FT	① Model	HPL Laminate	Essentials Veneer	Artisan Veneer
Storage Credenza 	22	96	21	350	32	FLT2296-21F676	\$2,831		
	22	96	21	350	32	FLV2296-21F676		\$3,954	\$4,351
	22	90	21	335	30	FLT2290-21F676	\$2,765		
	22	90	21	335	30	FLV2290-21F676		\$3,858	\$4,244
	22	84	21	311	28	FLT2284-21F676	\$2,697		
	22	84	21	311	28	FLV2284-21F676		\$3,765	\$4,142

Features:

- pedestal front locking
- hinged door compartment has one adjustable shelf

Options:

- must specify chassis grain direction on artisan veneer, see pages 13-15 for details
- concealed box drawer(s) available, specify location in unit; add \$246 list for each laminate drawer or \$375 for each veneer drawer, see page 25 for details
- locking doors available, specify and add \$147 list
- veneer door and drawer fronts in paint available, specify paint color and add \$354; see page 16 for details
- on laminate units, contrasting door and drawer fronts available, no upcharge; specify color, see page 16 for details
- ledge pulls standard; prism pulls available, specify and see page 9
- oval grommets in back panel can be eliminated upon request, no upcharge
- oval or rectangular seat cushion available, see page 25 for more details and page 212 for pricing
- interior horizontal wire manager with end grommets available, specify and add \$189 list; see page 40 for details
- top grommet available, specify location; add \$135 list each; see page 46 for details
- worksurface power available, specify "to accommodate EC26" on your purchase order; EC26 unit must be ordered separately, see page 46

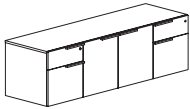
Description	D	W	H	CTN WT	CU FT	① Model	HPL Laminate	Essentials Veneer	Artisan Veneer
	22	78	21	310	26	FLT2278-21F575	\$2,277		
	22	78	21	310	26	FLV2278-21F575		\$3,177	\$3,496
	22	72	21	288	24	FLT2272-21F575	\$2,220		
	22	72	21	288	24	FLV2272-21F575		\$3,099	\$3,409
	22	66	21	273	22	FLT2266-21F575	\$2,176		
	22	66	21	273	22	FLV2266-21F575		\$3,038	\$3,342
	22	60	21	257	20	FLT2260-21F575	\$2,135		
	22	60	21	257	20	FLV2260-21F575		\$2,976	\$3,276

Features:

- pedestal front locking
- hinged door compartment has one adjustable shelf

Options:

- must specify chassis grain direction on artisan veneer, see pages 13-15 for details
- locking doors available, specify and add \$147 list
- veneer door and drawer fronts in paint available, specify paint color and add \$354; see page 16 for details
- on laminate units, contrasting door and drawer fronts available, no upcharge; specify color, see page 16 for details
- ledge pulls standard; prism pulls available, specify and see page 9
- oval grommets in back panels can be eliminated upon request, no upcharge
- oval or rectangular seat cushion available, see page 25 for more details and page 212 for pricing
- interior horizontal wire manager with end grommets available, specify and add \$189 list; see page 40 for details
- top grommet available, specify location; add \$135 list each; see page 46 for details
- worksurface power available, specify "to accommodate EC26" on your purchase order; EC26 unit must be ordered separately, see page 46

FLUX

To Order, Specify:

① Laminate Model #	② Laminate Type	③ Laminate Selection	④ Metal Color	⑤ Other Product Options
Laminate (FLT)	HPL	See Laminate Selection	See Metal Finish Color Options	See list of options for each specific unit; Specify and add accordingly.

① Veneer Model #	② Wood Collection	③ Wood Finish	④ Metal Color	⑤ Other Product Options
Veneer (FLV)	Essentials	See Essentials Wood Finish Options	See Metal Finish Color Options	See list of options for each specific unit; Specify and add accordingly.
		<table border="1"> <thead> <tr> <th>ⓐ Wood Finish</th> <th>ⓑ Chassis Grain Direction</th> </tr> </thead> <tbody> <tr> <td>See Artisan Wood Finish Options</td> <td>For Artisan Only: Vertical Horizontal</td> </tr> </tbody> </table>		
ⓐ Wood Finish	ⓑ Chassis Grain Direction			
See Artisan Wood Finish Options	For Artisan Only: Vertical Horizontal			

Description	D	W	H	CTN WT	CU FT	① Model	HPL Laminate	Essentials Veneer	Artisan Veneer
Box/Lateral File Credenza	22	90	21	371	30	FLT2290-21F666	\$3,208		
	22	90	21	371	30	FLV2290-21F666		\$4,480	\$4,928

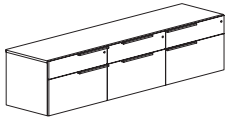

Features:

- pedestal front locking

Options:

- must specify chassis grain direction on artisan veneer, see pages 13-15 for details
- concealed box drawer(s) available, specify location in unit; add \$246 list for each laminate drawer or \$375 for each veneer drawer, see page 25 for details
- veneer drawer fronts in paint available, specify paint color and add \$354 list; see page 16 for details
- on laminate units, contrasting fronts available, no upcharge; specify color, see page 16 for details
- ledge pulls standard; prism pulls available, specify and see page 9
- oval grommets in back panel can be eliminated upon request, no upcharge
- oval or rectangular seat cushion available, see page 25 for more details and page 212 for pricing
- interior horizontal wire manager with end grommets available, specify and add \$189 list; see page 40 for details
- top grommet available, specify location; add \$135 list each; see page 46 for details

Box/Lateral File Credenza	22	72	21	289	24	FLT2272-21F66	\$2,388		
	22	72	21	289	24	FLV2272-21F66		\$3,333	\$3,667
	22	60	21	251	20	FLT2260-21F66	\$2,293		
	22	60	21	251	20	FLV2260-21F66		\$3,202	\$3,521

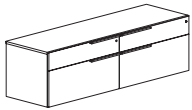

Features:

- pedestal front locking

Options:

- must specify chassis grain direction on artisan veneer, see pages 13-15 for details
- concealed box drawer(s) available, specify location in unit; add \$246 list for each laminate drawer or \$375 for each veneer drawer, see page 25 for details
- veneer drawer fronts in paint available, specify paint color and add \$354 list; see page 16 for details
- on laminate units, contrasting fronts available, no upcharge; specify color, see page 16 for details
- ledge pulls standard; prism pulls available, specify and see page 9
- oval grommets in back panel can be eliminated upon request, no upcharge
- oval or rectangular seat cushion available, see page 25 for more details and page 212 for pricing
- interior horizontal wire manager with end grommets available, specify and add \$189 list; see page 40 for details
- top grommet available, specify location; add \$135 list each; see page 46 for details

FLUX

Description	D	W	H	CTN WT	CU FT	① Model	HPL Laminate	Essentials Veneer	Artisan Veneer
 Box/Lateral File Pedestal	22	36	21	146	13	FLT2236-21F6	\$1,389		
	22	36	21	146	13	FLV2236-21F6		\$1,938	\$2,132
	22	30	21	126	11	FLT2230-21F6	\$1,356		
	22	30	21	126	11	FLV2230-21F6		\$1,889	\$2,081

Features:

- pedestal front locking

Options:

- must specify chassis grain direction on artisan veneer, see pages 13-15 for details
- concealed box drawer available, specify; add \$246 list for each laminate drawer or \$375 for each veneer drawer, see page 25 for details
- veneer drawer fronts in paint available, specify paint color and add \$354 list; see page 16 for details
- on laminate units, contrasting fronts available, no upcharge; specify color, see page 16 for details
- ledge pulls standard; prism pulls available, specify and see page 9
- oval grommet in back panel can be eliminated upon request, no upcharge
- oval or rectangular seat cushion available, see page 25 for more details and page 212 for pricing
- interior horizontal wire manager with end grommets available, specify and add \$189 list; see page 40 for details
- top grommet available, specify location; add \$135 list each; see page 46 for details

FLUX

To Order, Specify:

① Laminate Model #	② Laminate Type	③ Laminate Selection	④ Metal Color	⑤ Other Product Options
Laminate (FLT)	HPL	See Laminate Selection	See Metal Finish Color Options	See list of options for each specific unit; Specify and add accordingly.
① Veneer Model #	② Wood Collection	③ Wood Finish	④ Metal Color	⑤ Other Product Options
Veneer (FLV)	Essentials	See Essentials Wood Finish Options	See Metal Finish Color Options	See list of options for each specific unit; Specify and add accordingly.
	Artisan	ⓐ Wood Finish See Artisan Wood Finish Options	ⓑ Chassis Grain Direction For Artisan Only: Vertical Horizontal	

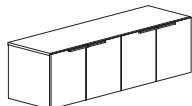

Description	D	W	H	CTN WT	CU FT	① Model	HPL Laminate	Essentials Veneer	Artisan Veneer
	22	78	21	254	26	FLT2278-21F77	\$1,968		
	22	78	21	254	26	FLV2278-21F77		\$2,893	\$3,179
	22	72	21	238	24	FLT2272-21F77	\$1,920		
	22	72	21	238	24	FLV2272-21F77		\$2,822	\$3,103
	22	66	21	220	22	FLT2266-21F77	\$1,843		
	22	66	21	220	22	FLV2266-21F77		\$2,708	\$2,979
	22	60	21	205	20	FLT2260-21F77	\$1,771		
	22	60	21	205	20	FLV2260-21F77		\$2,601	\$2,860

Features:

- each hinged door compartment has one adjustable shelf

Options:

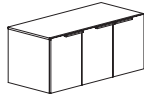
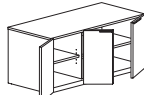
- must specify chassis grain direction on artisan veneer, see pages 13-15 for details
- locking doors available, specify and add \$294 list
- veneer door fronts in paint available, specify paint color and add \$354 list; see page 16 for details
- on laminate units, contrasting laminate door fronts available, no upcharge; specify laminate color, see page 16 for details
- ledge pulls standard; prism pulls available, specify and see page 9
- oval grommets in back panel can be eliminated upon request, no upcharge
- oval or rectangular seat cushion available, see page 25 for more details and page 212 for pricing
- interior horizontal wire manager with end grommets available, specify and add \$189 list; see page 40 for details
- top grommet available, specify location; add \$135 list each; see page 45 for details
- worksurface power available, specify “to accommodate EC26” on your purchase order; EC26 unit must be ordered separately, see page 46

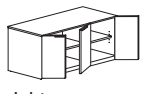
Description	D	W	H	CTN WT	CU FT	① Model	HPL Laminate	Essentials Veneer	Artisan Veneer
  left shown   right	22	54	21	188	18	FLT2254-21F77R	\$1,611		
	22	54	21	188	18	FLV2254-21F77R		\$2,367	\$2,604
	22	54	21	185	18	FLT2254-21F77L	\$1,611		
	22	54	21	185	18	FLV2254-21F77L		\$2,367	\$2,604
	22	48	21	169	16	FLT2248-21F77R	\$1,529		
	22	48	21	169	16	FLV2248-21F77R		\$2,251	\$2,474
	22	48	21	163	16	FLT2248-21F77L	\$1,529		
	22	48	21	163	16	FLV2248-21F77L		\$2,251	\$2,474
	22	42	21	153	15	FLT2242-21F77R	\$1,453		
	22	42	21	153	15	FLV2242-21F77R		\$2,137	\$2,350
	22	42	21	150	15	FLT2242-21F77L	\$1,453		
	22	42	21	150	15	FLV2242-21F77L		\$2,137	\$2,350

Features:

- each hinged door compartment has one adjustable shelf

Options:

- must specify chassis grain direction on artisan veneer, see pages 13-15 for details
- locking doors available, specify and add \$294 list
- veneer door fronts in paint available, specify paint color and add \$354 list; see page 16 for details
- on laminate units, contrasting laminate door fronts available, no upcharge; specify laminate color, see page 16 for details
- ledge pulls standard; prism pulls available, specify and see page 9
- oval grommet in back panel can be eliminated upon request, no upcharge
- oval or rectangular seat cushion available, see page 25 for more details and page 212 for pricing
- interior horizontal wire manager with end grommets available, specify and add \$189 list; see page 40 for details
- top grommet available, specify location; add \$135 list each; see page 45 for details
- worksurface power available, specify “to accommodate EC26” on your purchase order; EC26 unit must be ordered separately, see page 46

Description	D	W	H	CTN WT	CU FT	① Model	HPL Laminate	Essentials Veneer	Artisan Veneer
Two Door Storage	22	36	21	127	13	FLT2236-21F7	\$1,036		
	22	36	21	127	13	FLV2236-21F7		\$1,519	\$1,671
	22	30	21	109	11	FLT2230-21F7	\$994		
	22	30	21	109	11	FLV2230-21F7		\$1,456	\$1,604

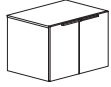

Features:

- compartment has one adjustable shelf

Options:

- must specify chassis grain direction on artisan veneer, see pages 13-15 for details
- locking doors available, specify and add \$147 list
- veneer door fronts in paint available, specify paint color and add \$354 list; see page 16 for details
- on laminate units, contrasting laminate door fronts available, no upcharge; specify laminate color, see page 16 for details
- ledge pulls standard; prism pulls available, specify and see page 9
- oval grommets in back panel can be eliminated upon request, no upcharge
- oval or rectangular seat cushion available, see page 25 for more details and page 212 for pricing
- interior horizontal wire manager with end grommets available, specify and add \$189 list; see page 40 for details
- top grommet available, specify location; add \$135 list each; see page 45 for details
- worksurface power available, specify "to accommodate EC26" on your purchase order; EC26 unit must be ordered separately, see page 46

FLUX

To Order, Specify:

① Laminate Model #	② Laminate Type	③ Laminate Selection	④ Metal Color	⑤ Other Product Options		
Laminate (FLT)	HPL	See Laminate Selection	See Metal Finish Color Options	See list of options for each specific unit; Specify and add accordingly.		
① Veneer Model #	② Wood Collection	③ Wood Finish	④ Metal Color	⑤ Other Product Options		
Veneer (FLV)	Essentials	See Essentials Wood Finish Options	See Metal Finish Color Options	See list of options for each specific unit; Specify and add accordingly.		
	Artisan	<table border="1"> <thead> <tr> <th>ⓐ Wood Finish</th> <th>ⓑ Chassis Grain Direction</th> </tr> </thead> <tbody> <tr> <td>See Artisan Wood Finish Options</td> <td>For Artisan Only: Vertical Horizontal</td> </tr> </tbody> </table>	ⓐ Wood Finish		ⓑ Chassis Grain Direction	See Artisan Wood Finish Options
ⓐ Wood Finish	ⓑ Chassis Grain Direction					
See Artisan Wood Finish Options	For Artisan Only: Vertical Horizontal					

Description	D	W	H	CTN WT	CU FT	① Model	HPL Laminate	Essentials Veneer	Artisan Veneer
Box/Lateral File with Open Storage Credenza	22	96	21	327	32	FLT2296-21F606	\$2,978		
	22	96	21	327	32	FLV2296-21F606		\$4,157	\$4,573
	22	90	21	323	30	FLT2290-21F606	\$2,893		
	22	90	21	323	30	FLV2290-21F606		\$4,037	\$4,440

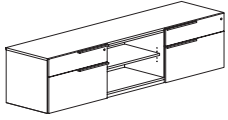

Features:

- pedestal front locking
- compartment has one adjustable shelf
- shelves 12 1/2" d

Options:

- must specify chassis grain direction on artisan veneer, see pages 13-15 for details
- peninsula desk mounting must be specified when ordering secondary credenza; see page 17 for details
- concealed box drawer(s) available, specify location in unit; add \$246 list for each laminate drawer or \$375 for each veneer drawer, see page 25 for details
- veneer drawer fronts in paint available, specify paint color and add \$354 list; see page 16 for details
- on laminate units, contrasting fronts available, no upcharge; specify color, see page 16 for details
- ledge pulls standard; prism pulls available, specify and see page 9
- oval grommets in back panel can be eliminated upon request, no upcharge
- oval or rectangular seat cushion available, see page 25 for more details and page 212 for pricing
- interior horizontal wire manager with end grommets available, specify and add \$189 list; see page 40 for details
- top grommet available, specify location; add \$135 list each; see page 46 for details
- worksurface power available, specify "to accommodate EC26" on your purchase order; EC26 unit must be ordered separately, see page 46

Description	D	W	H	CTN WT	CU FT	① Model	HPL Laminate	Essentials Veneer	Artisan Veneer
Box/Lateral File with Open Storage Credenza	22	96	21	291	32	FLT2296-21F060	\$2,766		
	22	96	21	291	32	FLV2296-21F060		\$3,861	\$4,246
	22	90	21	288	30	FLT2290-21F060	\$2,687		
	22	90	21	288	30	FLV2290-21F060		\$3,748	\$4,122

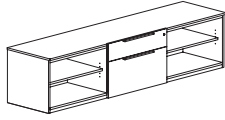

Features:

- pedestal front locking
- each open compartment has one adjustable shelf
- shelves 12 1/2" d

Options:

- must specify chassis grain direction on artisan veneer, see pages 13-15 for details
- peninsula desk mounting must be specified when ordering secondary credenza; see page 17 for details
- concealed box drawer available, specify; add \$246 list for each laminate drawer or \$375 for each veneer drawer, see page 25 for details
- veneer drawer fronts in paint available, specify paint color and add \$354 list; see page 16 for details
- on laminate units, contrasting fronts available, no upcharge; specify color, see page 16 for details
- ledge pulls standard; prism pulls available, specify and see page 9
- oval grommets in back panel can be eliminated upon request, no upcharge
- oval or rectangular seat cushion available, see page 25 for more details and page 212 for pricing
- interior horizontal wire manager with end grommets available, specify and add \$189 list; see page 40 for details
- top grommet available, specify location; add \$135 list each; see page 46 for details
- worksurface power available, specify "to accommodate EC26" on your purchase order; EC26 unit must be ordered separately, see page 46

FLUX

To Order, Specify:

① Laminate Model #	② Laminate Type	③ Laminate Selection	④ Metal Color	⑤ Other Product Options		
Laminate (FLT)	HPL	See Laminate Selection	See Metal Finish Color Options	See list of options for each specific unit; Specify and add accordingly.		
① Veneer Model #	② Wood Collection	③ Wood Finish	④ Metal Color	⑤ Other Product Options		
Veneer (FLV)	Essentials	See Essentials Wood Finish Options	See Metal Finish Color Options	See list of options for each specific unit; Specify and add accordingly.		
	Artisan	<table border="1"> <tr> <th>ⓐ Wood Finish</th> <th>ⓑ Chassis Grain Direction</th> </tr> <tr> <td>See Artisan Wood Finish Options</td> <td>For Artisan Only: Vertical Horizontal</td> </tr> </table>	ⓐ Wood Finish		ⓑ Chassis Grain Direction	See Artisan Wood Finish Options
ⓐ Wood Finish	ⓑ Chassis Grain Direction					
See Artisan Wood Finish Options	For Artisan Only: Vertical Horizontal					

Description	D	W	H	CTN WT	CU FT	① Model	HPL Laminate	Essentials Veneer	Artisan Veneer
Box/Lateral File with Open Storage Credenza	22	96	21	364	32	FLT2296-21F066	\$2,978		
	22	96	21	364	32	FLV2296-21F066		\$4,157	\$4,573
	22	96	21	332	32	FLT2296-21F660	\$2,978		
	22	96	21	332	32	FLV2296-21F660		\$4,157	\$4,573
	22	90	21	320	30	FLT2290-21F066	\$2,893		
	22	90	21	320	30	FLV2290-21F066		\$4,037	\$4,440
	22	90	21	320	30	FLT2290-21F660	\$2,893		
	22	90	21	320	30	FLV2290-21F660		\$4,037	\$4,440

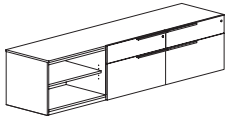

*066 shown



*660

Features:

- pedestal front locking
- compartment has one adjustable shelf
- shelf 12 1/2"d

Options:

- must specify chassis grain direction on artisan veneer, see pages 13-15 for details
- peninsula desk mounting must be specified when ordering secondary credenza; see page 17 for details
- concealed box drawer(s) available, specify location in unit; add \$246 list for each laminate drawer or \$375 for each veneer drawer, see page 25 for details
- veneer drawer fronts in paint available, specify paint color and add \$354 list; see page 16 for details
- on laminate units, contrasting fronts available, no upcharge; specify color, see page 16 for details
- ledge pulls standard; prism pulls available, specify and see page 9
- oval grommets in back panel can be eliminated upon request, no upcharge
- oval or rectangular seat cushion available, see page 25 for more details and page 212 for pricing
- interior horizontal wire manager with end grommets available, specify and add \$189 list; see page 40 for details
- top grommet available, specify location; add \$135 list each; see page 47 for details
- worksurface power available, specify "to accommodate EC26" on your purchase order; EC26 unit must be ordered separately, see page 47

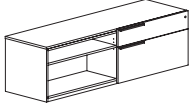
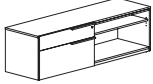
Description	D	W	H	CTN WT	CU FT	① Model	HPL Laminate	Essentials Veneer	Artisan Veneer
Box/Lateral File with Open Storage Credenza  *06 shown  *60	22	72	21	232	24	FLT2272-21F06	\$2,366		
	22	72	21	232	24	FLV2272-21F06		\$3,170	\$3,490
	22	72	21	232	24	FLT2272-21F60	\$2,366		
	22	72	21	232	24	FLV2272-21F60		\$3,170	\$3,490
	22	66	21	214	22	FLT2266-21F06	\$2,298		
	22	66	21	214	22	FLV2266-21F06		\$3,080	\$3,387
	22	66	21	214	22	FLT2266-21F60	\$2,298		
	22	66	21	214	22	FLV2266-21F60		\$3,080	\$3,387
	22	60	21	203	20	FLT2260-21F06	\$2,232		
	22	60	21	203	20	FLV2260-21F06		\$2,987	\$3,287
	22	60	21	203	20	FLT2260-21F60	\$2,232		
	22	60	21	203	20	FLV2260-21F60		\$2,987	\$3,287

Features:

- pedestal front locking
- compartment has one adjustable shelf
- shelf 12 1/2" d

Options:

- must specify chassis grain direction on artisan veneer, see pages 13-15 for details
- peninsula desk mounting must be specified when ordering secondary credenza; see page 17 for details
- concealed box drawer available, specify; add \$246 list for each laminate drawer or \$375 for each veneer drawer, see page 25 for details
- veneer drawer fronts in paint available, specify paint color and add \$354 list; see page 16 for details
- on laminate units, contrasting fronts available, no upcharge; specify color, see page 16 for details
- ledge pulls standard; prism pulls available, specify and see page 9
- oval grommets in back panel can be eliminated upon request, no upcharge
- oval or rectangular seat cushion available, see page 25 for more details and page 212 for pricing
- interior horizontal wire manager with end grommets available, specify and add \$189 list; see page 40 for details
- top grommet available, specify location; add \$135 list each; see page 47 for details
- worksurface power available, specify "to accommodate EC26" on your purchase order; EC26 unit must be ordered separately, see page 47

To Order, Specify:

① Laminate Model #	② Laminate Type	③ Laminate Selection	④ Metal Color	⑤ Other Product Options		
Laminate (FLT)	HPL	See Laminate Selection	See Metal Finish Color Options	See list of options for each specific unit; Specify and add accordingly.		
① Veneer Model #	② Wood Collection	③ Wood Finish	④ Metal Color	⑤ Other Product Options		
Veneer (FLV)	Essentials	See Essentials Wood Finish Options	See Metal Finish Color Options	See list of options for each specific unit; Specify and add accordingly.		
	Artisan	<table border="1"> <thead> <tr> <th>ⓐ Wood Finish</th> <th>ⓑ Chassis Grain Direction</th> </tr> </thead> <tbody> <tr> <td>See Artisan Wood Finish Options</td> <td>For Artisan Only: Vertical Horizontal</td> </tr> </tbody> </table>	ⓐ Wood Finish		ⓑ Chassis Grain Direction	See Artisan Wood Finish Options
ⓐ Wood Finish	ⓑ Chassis Grain Direction					
See Artisan Wood Finish Options	For Artisan Only: Vertical Horizontal					

Description	D	W	H	CTN WT	CU FT	① Model	HPL Laminate	Essentials Veneer	Artisan Veneer
Double Sliding Door Credenza	22	90	21	291	30	FLT2290-21F909	\$2,481		
	22	90	21	291	30	FLV2290-21F909		\$3,461	\$3,809

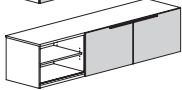
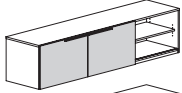
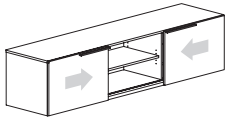

Features:

- locking doors not available
- each compartment has one adjustable shelf
- shelves 12 1/2"d

Options:

- must specify chassis grain direction on artisan veneer, see pages 13-15 for details
- peninsula desk mounting must be specified when ordering secondary credenza; see page 17 for details
- veneer door fronts in paint available, specify paint color and add \$354 list; see page 16 for details
- on laminate units, contrasting laminate door fronts available, no upcharge; specify laminate color, see page 16 for details
- ledge pulls standard; prism pulls available, specify and see page 9
- oval grommets in back panel can be eliminated upon request, no upcharge
- oval or rectangular seat cushion available, see page 25 for more details and page 212 for pricing
- interior horizontal wire manager with end grommets available, specify and add \$189 list; see page 40 for details
- top grommet available, specify location; add \$135 list each; see page 47 for details
- worksurface power available, specify "to accommodate EC26" on your purchase order; EC26 unit must be ordered separately, see page 47

Sliding Door Credenza	22	90	21	274	30	FLT2290-21F090	\$2,361		
	22	90	21	274	30	FLV2290-21F090		\$3,296	\$3,628

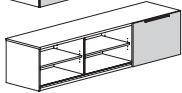
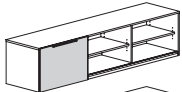
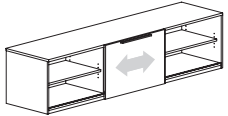

Features:

- locking doors not available
- each compartment has one adjustable shelf
- shelves 12 1/2"d

Options:

- must specify chassis grain direction on artisan veneer, see pages 13-15 for details
- peninsula desk mounting must be specified when ordering secondary credenza; see page 17 for details
- veneer door fronts in paint available, specify paint color and add \$354 list; see page 16 for details
- on laminate units, contrasting laminate door fronts available, no upcharge; specify laminate color, see page 16 for details
- ledge pulls standard; prism pulls available, specify and see page 9
- oval grommets in back panel can be eliminated upon request, no upcharge
- oval or rectangular seat cushion available, see page 25 for more details and page 212 for pricing
- interior horizontal wire manager with end grommets available, specify and add \$189 list; see page 40 for details
- top grommet available, specify location; add \$135 list each; see page 47 for details
- worksurface power available, specify "to accommodate EC26" on your purchase order; EC26 unit must be ordered separately, see page 47

Description	D	W	H	CTN WT	CU FT	① Model	HPL Laminate	Essentials Veneer	Artisan Veneer
Sliding Door Credenza	22	72	21	211	24	FLT2272-21F09	\$2,153		
	22	72	21	211	24	FLV2272-21F09		\$3,007	\$3,308
	22	60	21	185	20	FLT2260-21F09	\$2,031		
	22	60	21	185	20	FLV2260-21F09		\$2,834	\$3,120

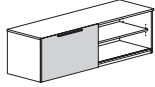
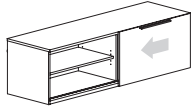

Features:

- locking doors not available
- each compartment has one adjustable shelf
- shelves 12 1/2"d

Options:

- must specify chassis grain direction on artisan veneer, see pages 13-15 for details
- peninsula desk mounting must be specified when ordering secondary credenza; see page 17 for details
- veneer door fronts in paint available, specify paint color and add \$354 list; see page 16 for details
- on laminate units, contrasting laminate door fronts available, no upcharge; specify laminate color, see page 16 for details
- ledge pulls standard; prism pulls available, specify and see page 9
- oval grommets in back panel can be eliminated upon request, no upcharge
- oval or rectangular seat cushion available, see page 25 for more details and page 212 for pricing
- interior horizontal wire manager with end grommets available, specify and add \$189 list; see page 40 for details
- top grommet available, specify location; add \$135 list each; see page 47 for details
- worksurface power available, specify "to accommodate EC26" on your purchase order; EC26 unit must be ordered separately, see page 47

To Order, Specify:

① Laminate Model #	② Laminate Type	③ Laminate Selection	④ Metal Color	⑤ Other Product Options		
Laminate (FLT)	HPL	See Laminate Selection	See Metal Finish Color Options	See list of options for each specific unit; Specify and add accordingly.		
① Veneer Model #	② Wood Collection	③ Wood Finish	④ Metal Color	⑤ Other Product Options		
Veneer (FLV)	Essentials	See Essentials Wood Finish Options	See Metal Finish Color Options	See list of options for each specific unit; Specify and add accordingly.		
	Artisan	<table border="1"> <thead> <tr> <th>ⓐ Wood Finish</th> <th>ⓑ Chassis Grain Direction</th> </tr> </thead> <tbody> <tr> <td>See Artisan Wood Finish Options</td> <td>For Artisan Only: Vertical Horizontal</td> </tr> </tbody> </table>	ⓐ Wood Finish		ⓑ Chassis Grain Direction	See Artisan Wood Finish Options
ⓐ Wood Finish	ⓑ Chassis Grain Direction					
See Artisan Wood Finish Options	For Artisan Only: Vertical Horizontal					

Description	D	W	H	CTN WT	CU FT	① Model	HPL Laminate	Essentials Veneer	Artisan Veneer
Open Compartment Storage Credenza	22	90	21	246	30	FLT2290-21F000	\$2,050		
	22	90	21	246	30	FLV2290-21F000		\$2,860	\$3,147

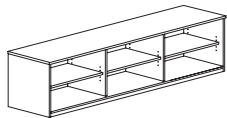

Features:

- square edge on top
- each open compartment has one adjustable shelf
- shelves 12 1/2"d

Options:

- must specify chassis grain direction on artisan veneer, see pages 13-15 for details
- peninsula desk mounting must be specified when ordering secondary credenza; see page 17 for details
- oval or rectangular seat cushion available, see page 25 for more details and page 212 for pricing
- oval grommets in back panel can be eliminated upon request, no upcharge
- interior horizontal wire manager with end grommets available, specify and add \$189 list; see page 40 for details
- top grommet available, specify location and add \$135 list each; see page 46 for details
- worksurface power available, specify "to accommodate EC26" on your purchase order; EC26 unit must be ordered separately, see page 46

Open Compartment Storage Credenza	22	72	21	193	24	FLT2272-21F00	\$1,868		
	22	72	21	193	24	FLV2272-21F00		\$2,609	\$2,870
	22	60	21	169	20	FLT2260-21F00	\$1,749		
	22	60	21	169	20	FLV2260-21F00		\$2,461	\$2,704

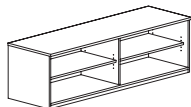

Features:

- square edge on top
- each open compartment has one adjustable shelf
- shelves 12 1/2"d

Options:

- must specify chassis grain direction on artisan veneer, see pages 13-15 for details
- peninsula desk mounting must be specified when ordering secondary credenza; see page 17 for details
- oval or rectangular seat cushion available, see page 25 for more details and page 212 for pricing
- oval grommets in back panel can be eliminated upon request, no upcharge
- interior horizontal wire manager with end grommets available, specify and add \$189 list; see page 40 for details
- top grommet available, specify location and add \$135 list each; see page 46 for details
- worksurface power available, specify "to accommodate EC26" on your purchase order; EC26 unit must be ordered separately, see page 46

Description	D	W	H	CTN WT	CU FT	① Model	HPL Laminate	Essentials Veneer	Artisan Veneer
Open Storage with Side Power Access	22	36	21	118	13	FLT2236-21FE0	\$1,682		
	22	36	21	118	13	FLV2236-21FE0		\$2,181	\$2,400
	22	36	21	124	13	FLT2236-21FOE	\$1,682		
	22	36	21	124	13	FLV2236-21FOE		\$2,181	\$2,400
	22	30	21	101	11	FLT2230-21FE0	\$1,632		
	22	30	21	101	11	FLV2230-21FE0		\$2,117	\$2,329
	22	30	21	107	11	FLT2230-21FOE	\$1,632		
	22	30	21	107	11	FLV2230-21FOE		\$2,117	\$2,329



*OE shown

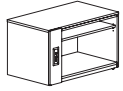

*EO

Features:

- square edge on top
- electrical power unit - EC26 included, specify color
- open compartment with adjustable shelf
- shelf 12 1/2" d

Options:

- must specify chassis grain direction on artisan veneer, see pages 13-15 for details
- oval or rectangular seat cushion available, see page 25 for more details and page 212 for pricing
- oval grommet in back panel can be eliminated upon request, no upcharge

FLUX

To Order, Specify:

① Laminate Model #	② Laminate Type	③ Laminate Selection	④ Metal Color	⑤ Other Product Options	
Laminate (FLT)	HPL	See Laminate Selection	See Metal Finish Color Options	See list of options for each specific unit; Specify and add accordingly.	
① Veneer Model #	② Wood Collection	③ Wood Finish	④ Metal Color	⑤ Other Product Options	
Veneer (FLV)	Essentials	See Essentials Wood Finish Options	See Metal Finish Color Options	See list of options for each specific unit; Specify and add accordingly.	
	Artisan	<table border="1"> <tr> <th>ⓐ Wood Finish</th> <th>ⓑ Chassis Grain Direction</th> </tr> <tr> <td>See Artisan Wood Finish Options</td> <td>For Artisan Only: Vertical Horizontal</td> </tr> </table>			ⓐ Wood Finish
ⓐ Wood Finish	ⓑ Chassis Grain Direction				
See Artisan Wood Finish Options	For Artisan Only: Vertical Horizontal				

Description	D	W	H	CTN WT	CU FT	① Model	HPL Laminate	Essentials Veneer	Artisan Veneer
Lateral File Pedestal Credenza - Flush Legs	22	90	21	285	30	FLT2290-21L666	\$3,960		
	22	90	21	285	30	FLV2290-21L666		\$5,143	\$5,657

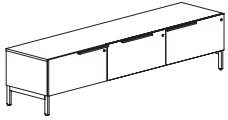

Features:

- pedestal front locking

Options:

- must specify chassis grain direction on artisan veneer, see pages 13-15 for details
- veneer drawer fronts in paint available, specify paint color and add \$354 list; see page 16 for details
- on laminate units, contrasting fronts available, no upcharge; specify color, see page 16 for details
- ledge pulls standard; prism pulls available, specify and see page 9
- oval or rectangular seat cushion available, see page 25 for more details and page 212 for pricing
- oval grommets in back panel can be eliminated upon request, no upcharge
- interior horizontal wire manager with end grommets available, specify and add \$189 list; see page 40 for details
- top grommet available, specify location and add \$135 list each; see page 46 for details

Lateral Credenza - Inset Legs	22	90	21	280	30	FLT2290-21S666	\$3,960		
	22	90	21	280	30	FLV2290-21S666		\$5,143	\$5,657

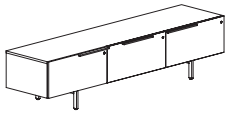

Features:

- pedestal front locking

Options:

- must specify chassis grain direction on artisan veneer, see pages 13-15 for details
- veneer drawer fronts in paint available, specify paint color and add \$354 list; see page 16 for details
- on laminate units, contrasting fronts available, no upcharge; specify color, see page 16 for details
- ledge pulls standard; prism pulls available, specify and see page 9
- oval or rectangular seat cushion available, see page 25 for more details and page 212 for pricing
- oval grommets in back panel can be eliminated upon request, no upcharge
- interior horizontal wire manager with end grommets available, specify and add \$189 list; see page 40 for details
- top grommet available, specify location and add \$135 list each; see page 46 for details

Lateral File Pedestal Credenza - Flush Legs	22	72	21	225	24	FLT2272-21L66	\$3,128		
	22	72	21	225	24	FLV2272-21L66		\$4,063	\$4,468
	22	60	21	198	20	FLT2260-21L66	\$2,952		
	22	60	21	198	20	FLV2260-21L66		\$3,832	\$4,216

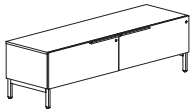

Features:

- pedestal front locking

Options:

- must specify chassis grain direction on artisan veneer, see pages 13-15 for details
- veneer drawer fronts in paint available, specify paint color and add \$354 list; see page 16 for details
- on laminate units, contrasting fronts available, no upcharge; specify color, see page 16 for details
- ledge pulls standard; prism pulls available, specify and see page 9
- oval or rectangular seat cushion available, see page 25 for more details and page 212 for pricing
- oval grommets in back panel can be eliminated upon request, no upcharge
- interior horizontal wire manager with end grommets available, specify and add \$189 list; see page 40 for details
- top grommet available, specify location and add \$135 list each; see page 46 for details

FLUX

Description	D	W	H	CTN WT	CU FT	① Model	HPL Laminate	Essentials Veneer	Artisan Veneer
Lateral Credenza - Inset Legs	22	72	21	220	24	FLT2272-21S66	\$3,128		
	22	72	21	220	24	FLV2272-21S66		\$4,063	\$4,468

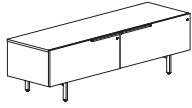

Features:

- pedestal front locking

Options:

- must specify chassis grain direction on artisan veneer, see pages 13-15 for details
- veneer drawer fronts in paint available, specify paint color and add \$354 list; see page 16 for details
- on laminate units, contrasting fronts available, no upcharge; specify color, see page 16 for details
- ledge pulls standard; prism pulls available, specify and see page 9
- oval or rectangular seat cushion available, see page 25 for more details and page 212 for pricing
- oval grommets in back panel can be eliminated upon request, no upcharge
- interior horizontal wire manager with end grommets available, specify and add \$189 list; see page 40 for details
- top grommet available, specify location and add \$135 list each; see page 46 for details

Lateral File Pedestal Credenza - Flush Legs	22	36	21	127	13	FLT2236-21L6	\$2,266		
	22	36	21	127	13	FLV2236-21L6		\$2,943	\$3,238
	22	30	21	104	11	FLT2230-21L6	\$2,201		
	22	30	21	104	11	FLV2230-21L6		\$2,855	\$3,142

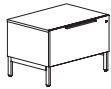

Features:

- pedestal front locking

Options:

- must specify chassis grain direction on artisan veneer, see pages 13-15 for details
- veneer drawer fronts in paint available, specify paint color and add \$354 list; see page 16 for details
- on laminate units, contrasting fronts available, no upcharge; specify color, see page 16 for details
- ledge pulls standard; prism pulls available, specify and see page 9
- oval or rectangular seat cushion available, see page 25 for more details and page 212 for pricing
- oval grommets in back panel can be eliminated upon request, no upcharge
- interior horizontal wire manager with end grommets available, specify and add \$189 list; see page 40 for details
- top grommet available, specify location and add \$135 list each; see page 46 for details

To Order, Specify:

① Laminate Model #	② Laminate Type	③ Laminate Selection	④ Metal Color	⑤ Other Product Options
Laminate (FLT)	HPL	See Laminate Selection	See Metal Finish Color Options	See list of options for each specific unit; Specify and add accordingly.

① Veneer Model #	② Wood Collection	③ Wood Finish	④ Metal Color	⑤ Other Product Options		
Veneer (FLV)	Essentials	See Essentials Wood Finish Options	See Metal Finish Color Options	See list of options for each specific unit; Specify and add accordingly.		
	Artisan	<table border="1"> <thead> <tr> <th>ⓐ Wood Finish</th> <th>ⓑ Chassis Grain Direction</th> </tr> </thead> <tbody> <tr> <td>See Artisan Wood Finish Options</td> <td>For Artisan Only: Vertical Horizontal</td> </tr> </tbody> </table>	ⓐ Wood Finish		ⓑ Chassis Grain Direction	See Artisan Wood Finish Options
ⓐ Wood Finish	ⓑ Chassis Grain Direction					
See Artisan Wood Finish Options	For Artisan Only: Vertical Horizontal					

Description	D	W	H	CTN WT	CU FT	① Model	HPL Laminate	Essentials Veneer	Artisan Veneer
Lateral File and Open Storage Credenza - Flush Legs	22	96	21	250	32	FLT2296-21L606	\$3,700		
	22	96	21	250	32	FLV2296-21L606		\$4,804	\$5,283
	22	90	21	258	30	FLT2290-21L606	\$3,590		
	22	90	21	258	30	FLV2290-21L606		\$4,664	\$5,130

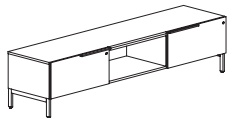

Features:

- pedestal front locking

Options:

- must specify chassis grain direction on artisan veneer, see pages 13-15 for details
- peninsula desk mounting must be specified when ordering secondary credenza; see page 17 for details
- veneer drawer fronts in paint available, specify paint color and add \$354 list; see page 16 for details
- on laminate units, contrasting fronts available, no upcharge; specify color, see page 16 for details
- ledge pulls standard; prism pulls available, specify and see page 9
- oval or rectangular seat cushion available, see page 25 for more details and page 212 for pricing
- oval grommets in back panel can be eliminated upon request, no upcharge
- interior horizontal wire manager with end grommets available, specify and add \$189 list; see page 40 for details
- top grommet available, specify location; add \$135 list each; see page 46 for details
- worksurface power available, specify "to accommodate EC26" on your purchase order; EC26 unit must be ordered separately, see page 46

FLUX

Lateral File and Open Storage Credenza - Inset Legs	22	90	21	247	30	FLT2290-21S606	\$3,700		
	22	90	21	247	30	FLV2290-21S606		\$4,804	\$5,283

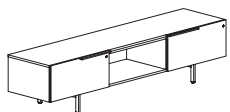

Features:

- pedestal front locking

Options:

- must specify chassis grain direction on artisan veneer, see pages 13-15 for details
- peninsula desk mounting must be specified when ordering secondary credenza; see page 17 for details
- veneer drawer fronts in paint available, specify paint color and add \$354 list; see page 16 for details
- on laminate units, contrasting fronts available, no upcharge; specify color, see page 16 for details
- ledge pulls standard; prism pulls available, specify and see page 9
- oval or rectangular seat cushion available, see page 25 for more details and page 212 for pricing
- oval grommets in back panel can be eliminated upon request, no upcharge
- interior horizontal wire manager with end grommets available, specify and add \$189 list; see page 40 for details
- top grommet available, specify location; add \$135 list each; see page 46 for details
- worksurface power available, specify "to accommodate EC26" on your purchase order; EC26 unit must be ordered separately, see page 46

Description	D	W	H	CTN WT	CU FT	① Model	HPL Laminate	Essentials Veneer	Artisan Veneer
Lateral File and Open Storage Credenza - Flush Legs	22	96	21	232	32	FLT2296-21L060	\$3,465		
	22	96	21	232	32	FLV2296-21L060		\$4,499	\$4,946
	22	90	21	252	30	FLT2290-21L060	\$3,364		
	22	90	21	252	30	FLV2290-21L060		\$4,365	\$4,805

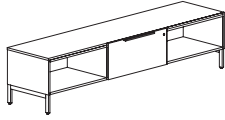

Features:

- pedestal front locking

Options:

- must specify chassis grain direction on artisan veneer, see pages 13-15 for details
- peninsula desk mounting must be specified when ordering secondary credenza; see page 17 for details
- veneer drawer fronts in paint available, specify paint color and add \$354 list; see page 16 for details
- on laminate units, contrasting fronts available, no upcharge; specify color, see page 16 for details
- ledge pulls standard; prism pulls available, specify and see page 9
- oval or rectangular seat cushion available, see page 25 for more details and page 212 for pricing
- oval grommets in back panel can be eliminated upon request, no upcharge
- interior horizontal wire manager with end grommets available, specify and add \$189 list; see page 40 for details
- top grommet available, specify location; add \$135 list each; see page 46 for details
- worksurface power available, specify "to accommodate EC26" on your purchase order; EC26 unit must be ordered separately, see page 46

Lateral File and Open Storage Credenza with Inset Legs	22	90	21	251	30	FLT2290-21S060	\$3,465		
	22	90	21	251	30	FLV2290-21S060		\$4,499	\$4,946

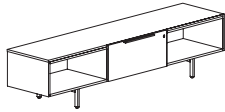

Features:

- pedestal front locking

Options:

- must specify chassis grain direction on artisan veneer, see pages 13-15 for details
- peninsula desk mounting must be specified when ordering secondary credenza; see page 17 for details
- veneer drawer fronts in paint available, specify paint color and add \$354 list; see page 16 for details
- on laminate units, contrasting fronts available, no upcharge; specify color, see page 16 for details
- ledge pulls standard; prism pulls available, specify and see page 9
- oval or rectangular seat cushion available, see page 25 for more details and page 212 for pricing
- oval grommets in back panel can be eliminated upon request, no upcharge
- interior horizontal wire manager with end grommets available, specify and add \$189 list; see page 40 for details
- top grommet available, specify location; add \$135 list each; see page 46 for details
- worksurface power available, specify "to accommodate EC26" on your purchase order; EC26 unit must be ordered separately, see page 46

To Order, Specify:

① Laminate Model #	② Laminate Type	③ Laminate Selection	④ Metal Color	⑤ Other Product Options		
Laminate (FLT)	HPL	See Laminate Selection	See Metal Finish Color Options	See list of options for each specific unit; Specify and add accordingly.		
① Veneer Model #	② Wood Collection	③ Wood Finish	④ Metal Color	⑤ Other Product Options		
Veneer (FLV)	Essentials	See Essentials Wood Finish Options	See Metal Finish Color Options	See list of options for each specific unit; Specify and add accordingly.		
	Artisan	<table border="1"> <thead> <tr> <th>ⓐ Wood Finish</th> <th>ⓑ Chassis Grain Direction</th> </tr> </thead> <tbody> <tr> <td>See Artisan Wood Finish Options</td> <td>For Artisan Only: Vertical Horizontal</td> </tr> </tbody> </table>	ⓐ Wood Finish		ⓑ Chassis Grain Direction	See Artisan Wood Finish Options
ⓐ Wood Finish	ⓑ Chassis Grain Direction					
See Artisan Wood Finish Options	For Artisan Only: Vertical Horizontal					

Description	D	W	H	CTN WT	CU FT	① Model	HPL Laminate	Essentials Veneer	Artisan Veneer
Lateral File and Open Storage Credenza - Flush Legs	22	96	21	256	32	FLT2296-21L066	\$3,700		
	22	96	21	256	32	FLV2296-21L066		\$4,804	\$5,283
	22	96	21	256	32	FLT2296-21L660	\$3,700		
	22	96	21	256	32	FLV2296-21L660		\$4,804	\$5,283
	22	90	21	256	30	FLT2290-21L066	\$3,590		
	22	90	21	256	30	FLV2290-21L066		\$4,664	\$5,130
	22	90	21	256	30	FLT2290-21L660	\$3,590		
	22	90	21	256	30	FLV2290-21L660		\$4,664	\$5,130

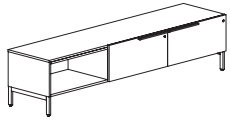

*066 shown

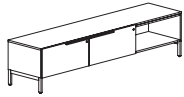

*660

Features:

- pedestal front locking

Options:

- must specify chassis grain direction on artisan veneer, see pages 13-15 for details
- peninsula desk mounting must be specified when ordering secondary credenza; see page 17 for details
- veneer drawer fronts in paint available, specify paint color and add \$354 list; see page 16 for details
- on laminate units, contrasting fronts available, no upcharge; specify color, see page 16 for details
- ledge pulls standard; prism pulls available, specify and see page 9
- oval or rectangular seat cushion available, see page 25 for more details and page 212 for pricing
- oval grommets in back panel can be eliminated upon request, no upcharge
- interior horizontal wire manager with end grommets available, specify and add \$189 list; see page 40 for details
- top grommet available, specify location; add \$135 list each; see page 47 for details
- worksurface power available, specify "to accommodate EC26" on your purchase order; EC26 unit must be ordered separately, see page 47

Description	D	W	H	CTN WT	CU FT	① Model	HPL Laminate	Essentials Veneer	Artisan Veneer
Lateral File and Open Storage	22	90	21	251	30	FLT2290-21S066	\$3,700		
Credenza with Inset Legs -	22	90	21	251	30	FLV2290-21S066		\$4,804	\$5,283
Secondary Height	22	90	21	251	30	FLT2290-21S660	\$3,700		
	22	90	21	251	30	FLV2290-21S660		\$4,804	\$5,283

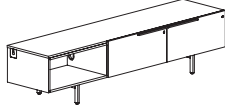

*066 shown

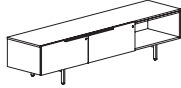

*660

Features:

- pedestal front locking

Options:

- must specify chassis grain direction on artisan veneer, see pages 13-15 for details
- peninsula desk mounting must be specified when ordering secondary credenza; see page 17 for details
- veneer drawer fronts in paint available, specify paint color and add \$354 list; see page 16 for details
- on laminate units, contrasting fronts available, no upcharge; specify color, see page 16 for details
- ledge pulls standard; prism pulls available, specify and see page 9
- oval or rectangular seat cushion available, see page 25 for more details and page 212 for pricing
- oval grommets in back panel can be eliminated upon request, no upcharge
- interior horizontal wire manager with end grommets available, specify and add \$189 list; see page 40 for details
- top grommet available, specify location; add \$135 list each; see page 47 for details
- worksurface power available, specify "to accommodate EC26" on your purchase order; EC26 unit must be ordered separately, see page 47

FLUX

To Order, Specify:

① Laminate Model #	② Laminate Type	③ Laminate Selection	④ Metal Color	⑤ Other Product Options		
Laminate (FLT)	HPL	See Laminate Selection	See Metal Finish Color Options	See list of options for each specific unit; Specify and add accordingly.		
① Veneer Model #	② Wood Collection	③ Wood Finish	④ Metal Color	⑤ Other Product Options		
Veneer (FLV)	Essentials	See Essentials Wood Finish Options	See Metal Finish Color Options	See list of options for each specific unit; Specify and add accordingly.		
	Artisan	<table border="1"> <thead> <tr> <th>ⓐ Wood Finish</th> <th>ⓑ Chassis Grain Direction</th> </tr> </thead> <tbody> <tr> <td>See Artisan Wood Finish Options</td> <td>For Artisan Only: Vertical Horizontal</td> </tr> </tbody> </table>	ⓐ Wood Finish		ⓑ Chassis Grain Direction	See Artisan Wood Finish Options
ⓐ Wood Finish	ⓑ Chassis Grain Direction					
See Artisan Wood Finish Options	For Artisan Only: Vertical Horizontal					

Description	D	W	H	CTN WT	CU FT	① Model	HPL Laminate	Essentials Veneer	Artisan Veneer
Lateral File and Open Storage Credenza - Flush Legs	22	72	21	210	24	FLT2272-21L06	\$2,887		
	22	72	21	210	24	FLV2272-21L06		\$3,748	\$4,122
	22	72	21	210	24	FLT2272-21L60	\$2,887		
	22	72	21	210	24	FLV2272-21L60		\$3,748	\$4,122
	22	66	21	186	22	FLT2266-21L06	\$2,803		
	22	66	21	186	22	FLV2266-21L06		\$3,636	\$4,000
	22	66	21	177	22	FLT2266-21L60	\$2,803		
	22	66	21	177	22	FLV2266-21L60		\$3,636	\$4,000
	22	60	21	169	20	FLT2260-21L06	\$2,718		
	22	60	21	169	20	FLV2260-21L06		\$3,524	\$3,880
	22	60	21	169	20	FLT2260-21L60	\$2,718		
	22	60	21	169	20	FLV2260-21L60		\$3,524	\$3,880



*06 shown



*60 shown

Features:

- pedestal front locking

Options:

- must specify chassis grain direction on artisan veneer, see pages 13-15 for details
- peninsula desk mounting must be specified when ordering secondary credenza; see page 17 for details
- veneer drawer fronts in paint available, specify paint color and add \$354 list; see page 16 for details
- on laminate units, contrasting fronts available, no upcharge; specify color, see page 16 for details
- ledge pulls standard; prism pulls available, specify and see page 9
- oval or rectangular seat cushion available, see page 25 for more details and page 212 for pricing
- oval grommets in back panel can be eliminated upon request, no upcharge
- interior horizontal wire manager with end grommets available, specify and add \$189 list; see page 40 for details
- top grommet available, specify location; add \$135 list each; see page 47 for details
- worksurface power available, specify "to accommodate EC26" on your purchase order; EC26 unit must be ordered separately, see page 47

Lateral File and Open Storage Credenza - Inset Legs	22	72	21	205	24	FLT2272-21S06	\$2,887		
	22	72	21	205	24	FLV2272-21S06		\$3,748	\$4,121
	22	72	21	205	24	FLT2272-21S60	\$2,887		
	22	72	21	205	24	FLV2272-21S60		\$3,748	\$4,121
	22	60	21	161	20	FLT2260-21S06	\$2,718		
	22	60	21	161	20	FLV2260-21S06		\$3,524	\$3,880
	22	60	21	161	20	FLT2260-21S60	\$2,718		
	22	60	21	161	20	FLV2260-21S60		\$3,524	\$3,880

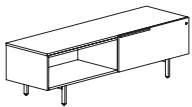

*06 shown

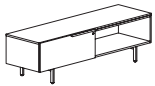

*60

Features:

- pedestal front locking

Options:

- must specify chassis grain direction on artisan veneer, see pages 13-15 for details
- peninsula desk mounting must be specified when ordering secondary credenza; see page 17 for details
- veneer drawer fronts in paint available, specify paint color and add \$354 list; see page 16 for details
- on laminate units, contrasting fronts available, no upcharge; specify color, see page 16 for details
- ledge pulls standard; prism pulls available, specify and see page 9
- oval or rectangular seat cushion available, see page 25 for more details and page 212 for pricing
- oval grommets in back panel can be eliminated upon request, no upcharge
- interior horizontal wire manager with end grommets available, specify and add \$189 list; see page 40 for details
- top grommet available, specify location; add \$135 list each; see page 47 for details
- worksurface power available, specify "to accommodate EC26" on your purchase order; EC26 unit must be ordered separately, see page 47

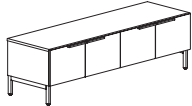
Description	D	W	H	CTN WT	CU FT	① Model	HPL Laminate	Essentials Veneer	Artisan Veneer
 Four Door Storage - Flush Legs	22	72	21	189	24	FLT2272-21L77	\$2,440		
	22	72	21	189	24	FLV2272-21L77		\$3,167	\$3,482
	22	60	21	160	20	FLT2260-21L77	\$2,293		
	22	60	21	160	20	FLV2260-21L77		\$2,976	\$3,276

Options:

- must specify chassis grain direction on artisan veneer, see pages 13-15 for details
- locking doors available, specify and add \$294 list
- veneer door fronts in paint available, specify paint color and add \$354 list; see page 16 for details
- on laminate units, contrasting laminate door fronts available, no upcharge; specify laminate color, see page 16 for details
- ledge pulls standard; prism pulls available, specify and see page 9
- oval or rectangular seat cushion available, see page 25 for more details and page 212 for pricing
- on laminate units, contrasting laminate door fronts available, no upcharge; specify laminate color, see page 16 for details
- oval grommets in back panel can be eliminated upon request, no upcharge
- interior horizontal wire manager with end grommets available, specify and add \$189 list; see page 40 for details
- top grommet available, specify location; add \$135 list each; see page 46 for details
- worksurface power available, specify "to accommodate EC26" on your purchase order; EC26 unit must be ordered separately, see page 46

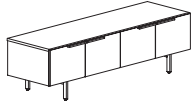
Description	D	W	H	CTN WT	CU FT	① Model	HPL Laminate	Essentials Veneer	Artisan Veneer
 Four Door Storage Credenza - Inset Legs	22	72	21	196	20	FLT2272-21S77	\$2,440		
	22	72	21	196	20	FLV2272-21S77		\$3,167	\$3,482
	22	60	21	152	20	FLT2260-21S77	\$2,293		
	22	60	21	152	20	FLV2260-21S77		\$2,976	\$3,275

Options:

- must specify chassis grain direction on artisan veneer, see pages 13-15 for details
- locking doors available, specify and add \$294 list
- veneer door fronts in paint available, specify paint color and add \$354 list; see page 16 for details
- on laminate units, contrasting laminate door fronts available, no upcharge; specify laminate color, see page 16 for details
- ledge pulls standard; prism pulls available, specify and see page 9
- oval or rectangular seat cushion available, see page 25 for more details and page 212 for pricing
- oval grommets in back panel can be eliminated upon request, no upcharge
- interior horizontal wire manager with end grommets available, specify and add \$189 list; see page 40 for details
- top grommet available, specify location; add \$135 list each; see page 46 for details
- worksurface power available, specify "to accommodate EC26" on your purchase order; EC26 unit must be ordered separately, see page 46

To Order, Specify:

① Laminate Model #	② Laminate Type	③ Laminate Selection	④ Metal Color	⑤ Other Product Options
Laminate (FLT)	HPL	See Laminate Selection	See Metal Finish Color Options	See list of options for each specific unit; Specify and add accordingly.
① Veneer Model #	② Wood Collection	③ Wood Finish	④ Metal Color	⑤ Other Product Options
Veneer (FLV)	Essentials	See Essentials Wood Finish Options	See Metal Finish Color Options	See list of options for each specific unit; Specify and add accordingly.
	Artisan	ⓐ Wood Finish See Artisan Wood Finish Options	ⓑ Chassis Grain Direction For Artisan Only: Vertical Horizontal	

Description	D	W	H	CTN WT	CU FT	① Model	HPL Laminate	Essentials Veneer	Artisan Veneer
Open Compartment Storage Credenza - Flush Legs	22	90	21	193	30	FLT2290-21L000	\$2,742		
	22	90	21	193	30	FLV2290-21L000		\$3,560	\$3,916

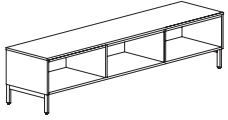

Options:

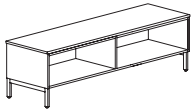

- must specify chassis grain direction on artisan veneer, see pages 13-15 for details
- peninsula desk mounting must be specified when ordering secondary credenza; see page 17 for details
- oval or rectangular seat cushion available, see page 25 for more details and page 212 for pricing
- oval grommets in back panel can be eliminated upon request, no upcharge
- top grommet available, specify location; add \$135 list each; see page 45 for details
- worksurface power available, specify "to accommodate EC26" on your purchase order; EC26 unit must be ordered separately, see page 47

Open Compartment Storage Credenza - Flush Legs	22	72	21	136	24	FLT2272-21L00	\$2,194		
	22	72	21	136	24	FLV2272-21L00		\$2,850	\$3,134
	22	60	21	136	20	FLT2260-21L00	\$2,067		
	22	60	21	136	20	FLV2260-21L00		\$2,681	\$2,949



Options:

- must specify chassis grain direction on artisan veneer, see pages 13-15 for details
- peninsula desk mounting must be specified when ordering secondary credenza; see page 17 for details
- oval or rectangular seat cushion available, see page 25 for more details and page 212 for pricing
- oval grommets in back panel can be eliminated upon request, no upcharge
- top grommet available, specify location; add \$135 list each; see page 45 for details
- worksurface power available, specify "to accommodate EC26" on your purchase order; EC26 unit must be ordered separately, see page 47

Description	D	W	H	CTN WT	CU FT	① Model	HPL Laminate	Essentials Veneer	Artisan Veneer
 *OE shown  *EO	22	36	21	100	13	FLT2236-21LE0	\$2,253		
	22	36	21	100	13	FLV2236-21LE0		\$2,922	\$3,215
	22	36	21	96	13	FLT2236-21LOE	\$2,253		
	22	36	21	96	13	FLV2236-21LOE		\$2,922	\$3,215
	22	30	21	84	11	FLT2230-21LE0	\$2,209		
	22	30	21	84	11	FLV2230-21LE0		\$2,864	\$3,153
	22	30	21	84	11	FLT2230-21LOE	\$2,209		
	22	30	21	84	11	FLV2230-21LOE		\$2,864	\$3,153

Features:

- square edge on top
- electrical power unit - EC26 included, specify color

Options:

- must specify chassis grain direction on artisan veneer, see pages 13-15 for details
- oval or rectangular seat cushion available, see page 25 for more details and page 212 for pricing
- oval grommet in back panel can be eliminated upon request, no upcharge

To Order, Specify:

① Laminate Model #	② Laminate Type	③ Laminate Selection	④ Metal Color	⑤ Other Product Options		
Laminate (FLT)	HPL	See Laminate Selection	See Metal Finish Color Options	See list of options for each specific unit; Specify and add accordingly.		
① Veneer Model #	② Wood Collection	③ Wood Finish	④ Metal Color	⑤ Other Product Options		
Veneer (FLV)	Essentials	See Essentials Wood Finish Options	See Metal Finish Color Options	See list of options for each specific unit; Specify and add accordingly.		
	Artisan	<table border="1"> <thead> <tr> <th>ⓐ Wood Finish</th> <th>ⓑ Chassis Grain Direction</th> </tr> </thead> <tbody> <tr> <td>See Artisan Wood Finish Options</td> <td>For Artisan Only: Vertical Horizontal</td> </tr> </tbody> </table>	ⓐ Wood Finish		ⓑ Chassis Grain Direction	See Artisan Wood Finish Options
ⓐ Wood Finish	ⓑ Chassis Grain Direction					
See Artisan Wood Finish Options	For Artisan Only: Vertical Horizontal					

Description	D	W	H	CTN WT	CU FT	① Model	List Price Per Grade	
Oval Cushion  <ul style="list-style-type: none"> · use with secondary height units 30" - 36" wide · com ydg: 1 ¼ 	20	29	1 ¾	10	2	FLB2029VCUSH	COM \$301	
								A \$355
								B \$366
								COL/C \$398
								D \$443
								E \$485
								F \$531
								G \$586
								H \$667
								I \$692
								J \$761
								L1 \$661
								L2 \$685

Rectangular Cushion  <ul style="list-style-type: none"> · use with secondary height units 30" - 36" wide · com ydg: 1 ¼ 	20	29	1 ¾	11	2	FLB2029RECUSH	COM \$301	
								A \$355
								B \$366
								COL/C \$398
								D \$443
								E \$485
								F \$531
								G \$586
								H \$667
								I \$692
								J \$761
								L1 \$661
								L2 \$685

FLUX

Description	D	W	H	CTN WT	CU FT	① Model	List Price Per Grade
Round Cushion	15 ¼	15 ¼	1 ¾	5	1	FLB1515RDCUSH	COM \$243
	<ul style="list-style-type: none"> · use with secondary height units · com ydg: ¾ 						A \$276
							B \$282
							COL/C \$301
							D \$329
							E \$353
							F \$381
							G \$414
							H \$464
							I \$479
							J \$521
							L1 \$459
							L2 \$474

Square Cushion	15 ¼	15 ¼	1 ¾	5	1	FLB1515SQCUSH	COM \$243
	<ul style="list-style-type: none"> · use with secondary height units · com ydg: ¾ 						A \$276
							B \$282
							COL/C \$301
							D \$329
							E \$353
							F \$381
							G \$414
							H \$464
							I \$479
							J \$521
							L1 \$459
							L2 \$474

FLUX

To Order, Specify:

① Model Number	② Fabric Selection	
(FLB)	Vendor Pattern Color	Visit www.jsifurniture.com/finishes-and-materials/textiles for our textiles program. See selection of standard and graded in manufacturers and patterns.

Description	D	W	H	CTN WT	CU FT	① Model	HPL Laminate	Essentials Veneer	Artisan Veneer
Adjustable Height Rectangular Table Desk	36	72	Adj.	340	51	FLT3672AHT	\$6,392		
	36	72	Adj.	340	51	FLV3672AHT		\$6,961	\$7,657
	32	66	Adj.	323	42	FLT3266AHT	\$6,336		
	32	66	Adj.	323	42	FLV3266AHT		\$6,900	\$7,589
	32	60	Adj.	314	39	FLT3260AHT	\$6,312		
	32	60	Adj.	314	39	FLV3260AHT		\$6,871	\$7,557

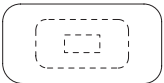
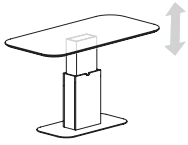

center mount

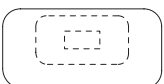
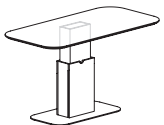

offset mount

Features:

- eased edge profile all sides
- top may be installed offset for a desk or centered for a meeting table, see page 47 for details
- removable panel provides access to power column and wiring
- powder coat steel base plate with neoprene leveling pads
- 27¾" to 45¾" height adjustment with digital controller, wire guide and 10' power cord
- maximum weight rating 140 lbs. (evenly distributed load)

Options:

- reverse bevel edge available on top perimeter, specify; add \$451 list for laminate or \$177 list for veneer; see page 8 for details
- top grommet available, specify location; add \$135 list each; see page 49 for details

Adjustable Height Square Table Desk	60	60	Adj.	377	70	FLT6060SAHT	\$6,821		
	60	60	Adj.	404	70	FLV6060SAHT		\$7,430	\$8,175
	54	54	Adj.	359	57	FLT5454SAHT	\$6,624		
	54	54	Adj.	381	57	FLV5454SAHT		\$7,221	\$7,944
	48	48	Adj.	77	14	FLT4848SAHT	\$6,555		
	48	48	Adj.	314	46	FLV4848SAHT		\$7,146	\$7,859

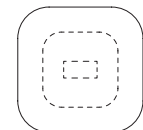
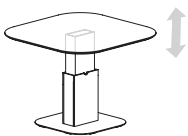
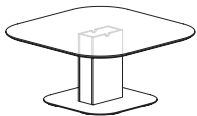

Features:

- eased edge profile all sides
- removable panel provides access to power column and wiring
- powder coat steel base plate with neoprene leveling pads
- 27¾" to 45¾" height adjustment with digital controller, wire guide and 10' power cord
- maximum weight rating 140 lbs. (evenly distributed load)

Options:

- reverse bevel edge available on top perimeter, specify; add \$451 list for laminate or \$177 list for veneer; see page 8 for details
- top grommet available, specify location; add \$135 list each; see page 49 for details

Description	D	W	H	CTN WT	CU FT	① Model	HPL Laminate	Essentials Veneer	Artisan Veneer
Adjustable Height Round Table Desk	60	60	Adj.	404	70	FLT6060RAHT	\$6,821		
	60	60	Adj.	377	70	FLV6060RAHT		\$7,430	\$8,175
	54	54	Adj.	381	57	FLT5454RAHT	\$6,624		
	54	54	Adj.	359	57	FLV5454RAHT		\$7,221	\$7,944
	48	48	Adj.	314	46	FLT4848RAHT	\$6,555		
	48	48	Adj.	301	46	FLV4848RAHT		\$7,146	\$7,859

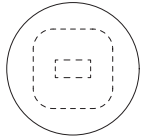
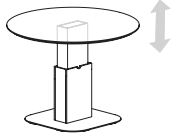
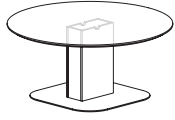

Features:

- eased edge profile all sides
- removable panel provides access to power column and wiring
- powder coat steel base plate with neoprene leveling pads
- 27¾" to 45¾" height adjustment with digital controller, wire guide and 10' power cord
- maximum weight rating 140 lbs. (evenly distributed load)

Options:

- reverse bevel edge available on top perimeter, specify; add \$451 list for laminate or \$177 list for veneer; see page 8 for details
- top grommet available, specify location; add \$135 list each; see page 49 for details

Adjustable Height Table - 120°	D	W	H	CTN WT	CU FT	Model	HPL Laminate	Essentials Veneer	Artisan Veneer
Adjustable Height Table - 120°	30	84	Adj.	233	23	FLT3084-29AH120T	\$3,901		
	30	84	Adj.	233	23	FLV3084-29AH120T		\$4,836	\$5,174
	24	84	Adj.	218	21	FLT2484-29AH120T	\$3,821		
	24	84	Adj.	218	21	FLV2484-29AH120T		\$4,739	\$5,070

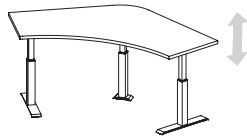
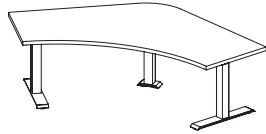

Features:

- eased edge profile on approach and user sides
- 22 ½" to 48 ½" height adjustment
- maximum weight rating 140 lbs. (evenly distributed load)
- key pad features height display with three memory settings; key pad mounts left or right
- 120" power cord

Options:

- specify Matte Black (MBK) or Arctic Silver (ASL) base finish
- top grommet available in center location, specify location; add \$135 list each
- optional EC33 unit must be ordered separately, see page 457
- undermount power available, specify and add \$994 list

To Order, Specify:

① Laminate Model #	② Laminate Type	③ Laminate Selection	④ Metal Color	⑤ Other Product Options		
Laminate (FLT)	HPL	See Laminate Selection	See Metal Finish Color Options	See list of options for each specific unit; Specify and add accordingly.		
① Veneer Model #	② Wood Collection	③ Wood Finish	④ Metal Color	⑤ Other Product Options		
Veneer (FLV)	Essentials	See Essentials Wood Finish Options	See Metal Finish Color Options	See list of options for each specific unit; Specify and add accordingly.		
	Artisan	<table border="1"> <thead> <tr> <th>ⓐ Wood Finish</th> <th>ⓑ Chassis Grain Direction</th> </tr> </thead> <tbody> <tr> <td>See Artisan Wood Finish Options</td> <td>For Artisan Only: Vertical Horizontal</td> </tr> </tbody> </table>	ⓐ Wood Finish		ⓑ Chassis Grain Direction	See Artisan Wood Finish Options
ⓐ Wood Finish	ⓑ Chassis Grain Direction					
See Artisan Wood Finish Options	For Artisan Only: Vertical Horizontal					

FLUX

Description	D	W	H	CTN WT	CU FT	① Model	HPL Laminate	Essentials Veneer	Artisan Veneer
Electric Adjustable Height Table Desk 	36	72	Adj.	194	18	FLT3672AHTD-EL	\$2,568		
	36	72	Adj.	194	18	FLV3672AHTD-EL		\$3,200	\$3,383
	30	72	Adj.	175	16	FLT3072AHTD-EL	\$2,478		
	30	72	Adj.	175	16	FLV3072AHTD-EL		\$3,078	\$3,250
	30	66	Adj.	168	15	FLT3066AHTD-EL	\$2,445		
	30	66	Adj.	168	15	FLV3066AHTD-EL		\$3,043	\$3,212
	30	60	Adj.	160	14	FLT3060AHTD-EL	\$2,412		
	30	60	Adj.	160	14	FLV3060AHTD-EL		\$3,006	\$3,173
	24	72	Adj.	151	12	FLT2472AHTD-EL	\$2,390		
	24	72	Adj.	151	12	FLV2472AHTD-EL		\$2,954	\$3,120
	24	66	Adj.	146	11	FLT2466AHTD-EL	\$2,357		
	24	66	Adj.	146	11	FLV2466AHTD-EL		\$2,925	\$3,089
	24	60	Adj.	140	10	FLT2460AHTD-EL	\$2,327		
	24	60	Adj.	140	10	FLV2460AHTD-EL		\$2,897	\$3,058

Features:

- eased edge profile on approach and user sides
- 22½" to 49" height adjustment
- maximum weight rating 140 lbs. (evenly distributed load)
- key pad features height display with three memory settings; key pad mounts left or right
- display will reference position to the nearest ½"
- 120" power cord

Options:

- specify Matte Black (MBK) or Arctic Silver (ASL) base finish
- reverse bevel edge available on desk approach side only, specify; add \$451 list for laminate or \$177 list for veneer; see page 8 for details
- top grommet available, specify location and add \$135 list each; see page 49 for details
- undermount power available, specify and add \$994 list; power infeed sold separately, see page 224

Description	D	W	H	CTN WT	CU FT	① Model	HPL Laminate	Essentials Veneer	Artisan Veneer
Pneumatic Adjustable Height Table Desk 	36	72	Adj.	194	18	FLT3672AHTD-PN	\$4,406		
	36	72	Adj.	194	18	FLV3672AHTD-PN		\$5,213	\$5,732
	30	72	Adj.	175	16	FLT3072AHTD-PN	\$4,315		
	30	72	Adj.	175	16	FLV3072AHTD-PN		\$4,988	\$5,487
	30	66	Adj.	168	15	FLT3066AHTD-PN	\$4,225		
	30	66	Adj.	168	15	FLV3066AHTD-PN		\$4,842	\$5,327
	30	60	Adj.	160	14	FLT3060AHTD-PN	\$4,127		
	30	60	Adj.	160	14	FLV3060AHTD-PN		\$4,688	\$5,155
	24	72	Adj.	151	12	FLT2472AHTD-PN	\$4,132		
	24	72	Adj.	151	12	FLV2472AHTD-PN		\$4,669	\$5,136
	24	66	Adj.	146	11	FLT2466AHTD-PN	\$4,095		
	24	66	Adj.	146	11	FLV2466AHTD-PN		\$4,588	\$5,047
	24	60	Adj.	140	10	FLT2460AHTD-PN	\$4,040		
	24	60	Adj.	140	10	FLV2460AHTD-PN		\$4,487	\$4,937

Features:

- eased edge profile on approach and user sides
- 27½" to 44½" height adjustment
- 20 lbs. lift force, maximum weight rating 140 lbs. (evenly distributed load)
- release lever mounts under edge of top

Options:

- specify Matte Black (MBK) or Alloy (ALY) base finish
- reverse bevel edge available on desk approach side only, specify; add \$451 list for laminate or \$177 list for veneer; see page 8 for details
- top grommet available, specify location; add \$135 list each; see page 49 for details

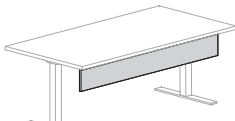
Description	D	W	H	CTN WT	CU FT	① Model	HPL Laminate	Essentials Veneer	Artisan Veneer
Modesty Panels for Adjustable Height Tables 	¾	64	9	18	3	FLT0964TDM	\$459		
	¾	64	9	18	3	FLV0964TDM		\$765	\$842
	¾	58	9	16	2	FLT0958TDM	\$448		
	¾	58	9	16	2	FLV0958TDM		\$742	\$814
	¾	52	9	14	2	FLT0952TDM	\$433		
	¾	52	9	14	2	FLV0952TDM		\$717	\$788

Features:

- FLV0964TDM or FLT0964TDM use with 72" wide adjustable height table desk
- FLV0958TDM or FLT0958TDM use with 66" wide adjustable height table desk
- FLV0952TDM or FLT0952TDM use with 60" wide adjustable height table desk

Options:

- specify modesty panel bracket finish; Black Sandtex (BSX) or Stardust Silver (STS)

FLUX

To Order, Specify:

① Laminate Model #	② Laminate Type	③ Laminate Selection		④ Metal Color	⑤ Other Product Options
Laminate (FLT)	HPL	See Laminate Selection		See Metal Finish Color Options	See list of options for each specific unit; Specify and add accordingly.
① Veneer Model #	② Wood Collection	③ Wood Finish		④ Metal Color	⑤ Other Product Options
Veneer (FLV)	Essentials	See Essentials Wood Finish Options		See Metal Finish Color Options	See list of options for each specific unit; Specify and add accordingly.
		③a Wood Finish	③b Chassis Grain Direction		
	Artisan	See Artisan Wood Finish Options	For Artisan Only: Vertical Horizontal		

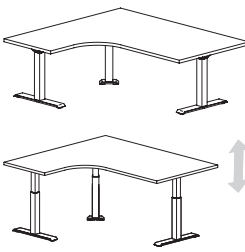
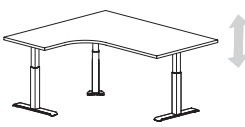
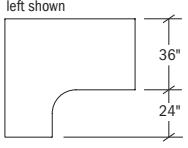
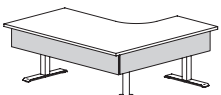
Description	D	W	H	CTN WT	CU FT	① Model	HPL Laminate	Essentials Veneer	Artisan Veneer
Adjustable Height Corner Table - 90° One Piece Top   left shown   optional modesty panels	60	72	Adj.	259	33	FLT3672CT24AHR	\$4,119		
	60	72	Adj.	259	33	FLV3672CT24AHR		\$5,106	\$5,464
	60	72	Adj.	259	33	FLT3672CT24AHL	\$4,119		
	60	72	Adj.	259	33	FLV3672CT24AHL		\$5,106	\$5,464
	60	66	Adj.	240	31	FLT3666CT24AHR	\$4,040		
	60	66	Adj.	240	31	FLV3666CT24AHR		\$5,008	\$5,360
	60	66	Adj.	240	31	FLT3666CT24AHL	\$4,040		
	60	66	Adj.	240	31	FLV3666CT24AHL		\$5,008	\$5,360
	60	60	Adj.	231	28	FLT3660CT24AHR	\$3,962		
	60	60	Adj.	231	28	FLV3660CT24AHR		\$4,912	\$5,256
	60	60	Adj.	231	28	FLT3660CT24AHL	\$3,962		
	60	60	Adj.	231	28	FLV3660CT24AHL		\$4,912	\$5,256

Features:

- eased edge profile on approach and user sides
- 22½" to 49" height adjustment
- maximum weight rating 140 lbs. (evenly distributed load)
- key pad features height display with three memory settings; key pad mounts left or right
- display will reference position to the nearest ½"
- 120" power cord

Options:

- specify Matte Black (MBK) or Arctic Silver (ASL) base finish
- reverse bevel edge available on desk approach side only, specify; add \$451 list for laminate or \$177 list for veneer; see page 8 for details
- top grommet available, specify location and add \$135 list each; see page 49 for details
- modesty panel available (2-sides) moves with worksurface, specify \$934 list for laminate or \$1,502 list for veneer; see page 21 for details
- undermount power available, specify and add \$994 list; power infeed sold separately, see page 224

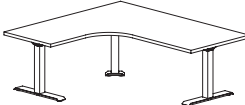
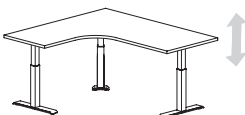
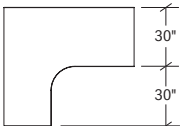
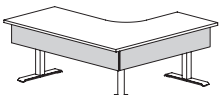
Adjustable Height Corner Table - 90° One Piece Top   left shown   optional modesty panels	60	72	Adj.	234	33	FLT3072CT30AHR	\$4,119		
	60	72	Adj.	234	33	FLV3072CT30AHR		\$5,106	\$5,464
	60	72	Adj.	234	33	FLT3072CT30AHL	\$4,119		
	60	72	Adj.	234	33	FLV3072CT30AHL		\$5,106	\$5,464
	60	66	Adj.	230	31	FLT3066CT30AHR	\$4,040		
	60	66	Adj.	230	31	FLV3066CT30AHR		\$5,008	\$5,360
	60	66	Adj.	230	31	FLT3066CT30AHL	\$4,040		
	60	66	Adj.	230	31	FLV3066CT30AHL		\$5,008	\$5,360
	60	60	Adj.	222	28	FLT3060CT30AHR	\$3,962		
	60	60	Adj.	222	28	FLV3060CT30AHR		\$4,912	\$5,256
	60	60	Adj.	222	28	FLT3060CT30AHL	\$3,962		
	60	60	Adj.	222	28	FLV3060CT30AHL		\$4,912	\$5,256

Features:

- eased edge profile on approach and user sides
- 22½" to 49" height adjustment
- maximum weight rating 140 lbs. (evenly distributed load)
- key pad features height display with three memory settings; key pad mounts left or right
- display will reference position to the nearest ½"
- 120" power cord

Options:

- specify Matte Black (MBK) or Arctic Silver (ASL) base finish
- reverse bevel edge available on desk approach side only, specify; add \$451 list for laminate or \$177 list for veneer; see page 8 for details
- top grommet available, specify location and add \$135 list each; see page 49 for details
- modesty panel available (2-sides) moves with worksurface, specify \$934 list for laminate or \$1,502 list for veneer; see page 21 for details
- undermount power available, specify and add \$994 list; power infeed sold separately, see page 224

Description	D	W	H	CTN WT	CU FT	① Model	HPL Laminate	Essentials Veneer	Artisan Veneer
Adjustable Height Corner Table - 90° One Piece Top	60	72	Adj.	225	33	FLT2472CT36AHR	\$4,119		
	60	72	Adj.	225	33	FLV2472CT36AHR		\$5,106	\$5,464
	60	72	Adj.	225	33	FLT2472CT36AHL	\$4,119		
	60	72	Adj.	225	33	FLV2472CT36AHL		\$5,106	\$5,464
	60	66	Adj.	220	31	FLT2466CT36AHR	\$4,040		
	60	66	Adj.	220	31	FLV2466CT36AHR		\$5,008	\$5,360
	60	66	Adj.	220	31	FLT2466CT36AHL	\$4,040		
	60	66	Adj.	220	31	FLV2466CT36AHL		\$5,008	\$5,360
	60	60	Adj.	214	28	FLT2460CT36AHR	\$3,962		
	60	60	Adj.	214	28	FLV2460CT36AHR		\$4,912	\$5,256
	60	60	Adj.	214	28	FLT2460CT36AHL	\$3,962		
	60	60	Adj.	214	28	FLV2460CT36AHL		\$4,912	\$5,256

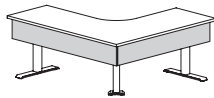
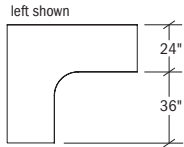
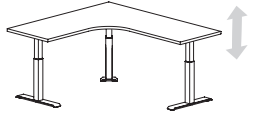
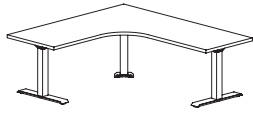

optional modesty panels

Features:

- eased edge profile on approach and user sides
- 22½" to 49" height adjustment
- maximum weight rating 140 lbs. (evenly distributed load)
- key pad features height display with three memory settings; key pad mounts left or right
- display will reference position to the nearest ½"
- 120" power cord

Options:

- specify Matte Black (MBK) or Arctic Silver (ASL) base finish
- reverse bevel edge available on desk approach side only, specify; add \$451 list for laminate or \$177 list for veneer; see page 8 for details
- top grommet available, specify location and add \$135 list each; see page 49 for details
- modesty panel available (2-sides) moves with worksurface, specify \$934 list for laminate or \$1,502 list for veneer; see page 21 for details
- undermount power available, specify and add \$946 list; power infeed sold separately, see page 224

To Order, Specify:

① Laminate Model #	② Laminate Type	③ Laminate Selection	④ Metal Color	⑤ Other Product Options		
Laminate (FLT)	HPL	See Laminate Selection	See Metal Finish Color Options	See list of options for each specific unit; Specify and add accordingly.		
① Veneer Model #	② Wood Collection	③ Wood Finish	④ Metal Color	⑤ Other Product Options		
Veneer (FLV)	Essentials	See Essentials Wood Finish Options	See Metal Finish Color Options	See list of options for each specific unit; Specify and add accordingly.		
	Artisan	<table border="1"> <thead> <tr> <th>ⓐ Wood Finish</th> <th>ⓑ Chassis Grain Direction</th> </tr> </thead> <tbody> <tr> <td>See Artisan Wood Finish Options</td> <td>For Artisan Only: Vertical Horizontal</td> </tr> </tbody> </table>	ⓐ Wood Finish		ⓑ Chassis Grain Direction	See Artisan Wood Finish Options
ⓐ Wood Finish	ⓑ Chassis Grain Direction					
See Artisan Wood Finish Options	For Artisan Only: Vertical Horizontal					

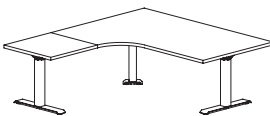
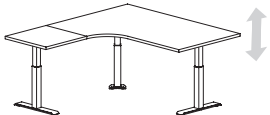
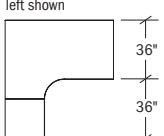
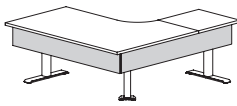
Description	D	W	H	CTN WT	CU FT	① Model	HPL Laminate	Essentials Veneer	Artisan Veneer
Adjustable Height Corner Table - 90° Two Piece Top   left shown   optional modesty panels	72	72	Adj.	255	27	FLT3672CDT36R	\$4,216		
	72	72	Adj.	255	27	FLV3672CDT36R		\$5,227	\$5,594
	72	72	Adj.	255	27	FLT3672CDT36L	\$4,216		
	72	72	Adj.	255	27	FLV3672CDT36L		\$5,227	\$5,594
	72	66	Adj.	247	25	FLT3666CDT36R	\$4,174		
	72	66	Adj.	247	25	FLV3666CDT36R		\$5,176	\$5,538
	72	66	Adj.	247	25	FLT3666CDT36L	\$4,174		
	72	66	Adj.	247	25	FLV3666CDT36L		\$5,176	\$5,538
	72	60	Adj.	237	23	FLT3660CDT36R	\$4,131		
	72	60	Adj.	237	23	FLV3660CDT36R		\$5,122	\$5,480
	72	60	Adj.	237	23	FLT3660CDT36L	\$4,131		
	72	60	Adj.	237	23	FLV3660CDT36L		\$5,122	\$5,480

Features:

- eased edge profile on approach and user sides
- 22½" to 49" height adjustment
- maximum weight rating 140 lbs. (evenly distributed load)
- key pad features height display with three memory settings; key pad mounts left or right
- display will reference position to the nearest ½"
- 120" power cord

Options:

- specify Matte Black (MBK) or Arctic Silver (ASL) base finish
- reverse bevel edge available on desk approach side only, specify; add \$451 list for laminate or \$177 list for veneer; see page 8 for details
- top grommet available, specify location and add \$135 list each; see page 49 for details
- modesty panel available (2-sides) moves with worksurface, specify \$934 list for laminate or \$1,502 list for veneer; see page 21 for details
- undermount power available, specify and add \$994 list; power infeed sold separately, see page 224

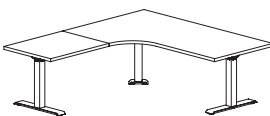
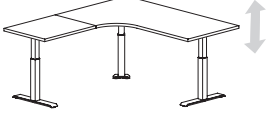
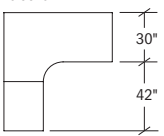
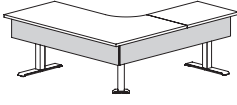
Adjustable Height Corner Table - 90° Two Piece Top   left shown   optional modesty panels	72	72	Adj.	223	24	FLT3072CDT42R	\$4,216		
	72	72	Adj.	223	24	FLV3072CDT42R		\$5,227	\$5,594
	72	72	Adj.	223	24	FLT3072CDT42L	\$4,216		
	72	72	Adj.	223	24	FLV3072CDT42L		\$5,227	\$5,594
	72	66	Adj.	213	22	FLT3066CDT42R	\$4,174		
	72	66	Adj.	213	22	FLV3066CDT42R		\$5,176	\$5,538
	72	66	Adj.	213	22	FLT3066CDT42L	\$4,174		
	72	66	Adj.	213	22	FLV3066CDT42L		\$5,176	\$5,538
	72	60	Adj.	203	21	FLT3060CDT42R	\$4,131		
	72	60	Adj.	203	21	FLV3060CDT42R		\$5,122	\$5,480
	72	60	Adj.	203	21	FLT3060CDT42L	\$4,131		
	72	60	Adj.	203	21	FLV3060CDT42L		\$5,122	\$5,480

Features:

- eased edge profile on approach and user sides
- 22½" to 49" height adjustment
- maximum weight rating 140 lbs. (evenly distributed load)
- key pad features height display with three memory settings; key pad mounts left or right
- display will reference position to the nearest ½"
- 120" power cord

Options:

- specify Matte Black (MBK) or Arctic Silver (ASL) base finish
- reverse bevel edge available on desk approach side only, specify; add \$451 list for laminate or \$177 list for veneer; see page 8 for details
- top grommet available, specify location and add \$135 list each; see page 49 for details
- modesty panel available (2-sides) moves with worksurface, specify \$934 list for laminate or \$1,502 list for veneer; see page 21 for details
- undermount power available, specify and add \$994 list; power infeed sold separately, see page 224

Description	D	W	H	CTN WT	CU FT	① Model	HPL Laminate	Essentials Veneer	Artisan Veneer
Adjustable Height Corner Table - 90° Two Piece Top	72	72	Adj.	232	21	FLT2472CDT48R	\$4,216		
	72	72	Adj.	232	21	FLV2472CDT48R		\$5,227	\$5,594
	72	72	Adj.	232	21	FLT2472CDT48L	\$4,216		
	72	72	Adj.	232	21	FLV2472CDT48L		\$5,227	\$5,594
	72	66	Adj.	225	20	FLT2466CDT48R	\$4,174		
	72	66	Adj.	225	20	FLV2466CDT48R		\$5,176	\$5,538
	72	66	Adj.	225	20	FLT2466CDT48L	\$4,174		
	72	66	Adj.	225	20	FLV2466CDT48L		\$5,176	\$5,538
	72	60	Adj.	219	18	FLT2460CDT48R	\$4,131		
	72	60	Adj.	219	18	FLV2460CDT48R		\$5,122	\$5,480
	72	60	Adj.	219	18	FLT2460CDT48L	\$4,131		
	72	60	Adj.	219	18	FLV2460CDT48L		\$5,122	\$5,480

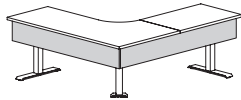
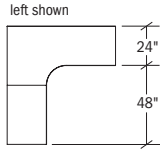
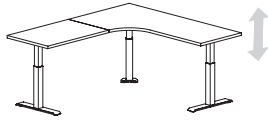

optional modesty panels

Features:

- eased edge profile on approach and user sides
- 22½" to 49" height adjustment
- maximum weight rating 140 lbs. (evenly distributed load)
- key pad features height display with three memory settings; key pad mounts left or right
- display will reference position to the nearest ½"
- 120" power cord

Options:

- specify Matte Black (MBK) or Arctic Silver (ASL) base finish
- reverse bevel edge available on desk approach side only, specify; add \$451 list for laminate or \$177 list for veneer; see page 8 for details
- top grommet available, specify location and add \$135 list each; see page 49 for details
- modesty panel available (2-sides) moves with worksurface, specify \$934 list for laminate or \$1,502 list for veneer; see page 21 for details
- undermount power available, specify and add \$994 list; power infeed sold separately, see page 224

To Order, Specify:

① Laminate Model #	② Laminate Type	③ Laminate Selection	④ Metal Color	⑤ Other Product Options
Laminate (FLT)	HPL	See Laminate Selection	See Metal Finish Color Options	See list of options for each specific unit; Specify and add accordingly.

① Veneer Model #	② Wood Collection	③ Wood Finish	④ Metal Color	⑤ Other Product Options		
Veneer (FLV)	Essentials	See Essentials Wood Finish Options	See Metal Finish Color Options	See list of options for each specific unit; Specify and add accordingly.		
	Artisan	<table border="1"> <thead> <tr> <th>ⓐ Wood Finish</th> <th>ⓑ Chassis Grain Direction</th> </tr> </thead> <tbody> <tr> <td>See Artisan Wood Finish Options</td> <td>For Artisan Only: Vertical Horizontal</td> </tr> </tbody> </table>	ⓐ Wood Finish		ⓑ Chassis Grain Direction	See Artisan Wood Finish Options
ⓐ Wood Finish	ⓑ Chassis Grain Direction					
See Artisan Wood Finish Options	For Artisan Only: Vertical Horizontal					

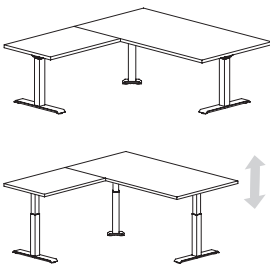
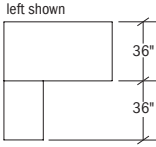
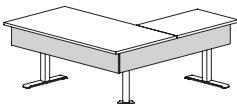
Description	D	W	H	CTN WT	CU FT	① Model	HPL Laminate	Essentials Veneer	Artisan Veneer
Adjustable Height Table & Return - 90° Two Piece Top   left shown  optional modesty panels	72	72	Adj.	253	20	FLT3672RTAH36R	\$3,396		
	72	72	Adj.	253	20	FLV3672RTAH36R		\$4,212	\$4,506
	72	72	Adj.	253	20	FLT3672RTAH36L	\$3,396		
	72	72	Adj.	253	20	FLV3672RTAH36L		\$4,212	\$4,506
	72	66	Adj.	248	19	FLT3666RTAH36R	\$3,357		
	72	66	Adj.	248	19	FLV3666RTAH36R		\$4,162	\$4,449
	72	66	Adj.	248	19	FLT3666RTAH36L	\$3,357		
	72	66	Adj.	248	19	FLV3666RTAH36L		\$4,162	\$4,449
	72	60	Adj.	239	17	FLT3660RTAH36R	\$3,318		
	72	60	Adj.	239	17	FLV3660RTAH36R		\$4,113	\$4,401
	72	60	Adj.	239	17	FLT3660RTAH36L	\$3,318		
	72	60	Adj.	239	17	FLV3660RTAH36L		\$4,113	\$4,401

Features:

- eased edge profile on approach and user sides
- 22½" to 49" height adjustment
- maximum weight rating 140 lbs. (evenly distributed load)
- key pad features height display with three memory settings; key pad mounts left or right
- display will reference position to the nearest ½"
- 120" power cord

Options:

- specify Matte Black (MBK) or Arctic Silver (ASL) base finish
- reverse bevel edge available on desk approach side only, specify; add \$451 list for laminate or \$177 list for veneer; see page 8 for details
- top grommet available, specify location and add \$135 list each; see page 49 for details
- modesty panel available (2-sides) moves with worksurface, specify \$934 list for laminate or \$1,502 list for veneer; see page 21 for details
- undermount power available, specify and add \$994 list; power infeed sold separately, see page 224

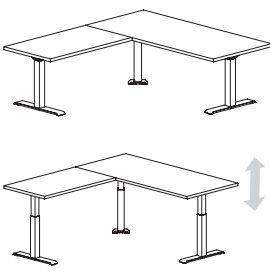
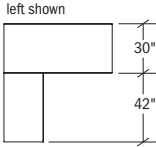
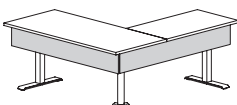
Adjustable Height Table & Return - 90° Two Piece Top   left shown  optional modesty panels	72	72	Adj.	242	18	FLT3072RTAH42R	\$3,327		
	72	72	Adj.	242	18	FLV3072RTAH42R		\$4,127	\$4,416
	72	72	Adj.	242	18	FLT3072RTAH42L	\$3,327		
	72	72	Adj.	242	18	FLV3072RTAH42L		\$4,127	\$4,416
	72	66	Adj.	233	17	FLT3066RTAH42R	\$3,290		
	72	66	Adj.	233	17	FLV3066RTAH42R		\$4,079	\$4,364
	72	66	Adj.	233	17	FLT3066RTAH42L	\$3,290		
	72	66	Adj.	233	17	FLV3066RTAH42L		\$4,079	\$4,364
	72	60	Adj.	224	16	FLT3060RTAH42R	\$3,250		
	72	60	Adj.	224	16	FLV3060RTAH42R		\$4,031	\$4,312
	72	60	Adj.	224	16	FLT3060RTAH42L	\$3,250		
	72	60	Adj.	224	16	FLV3060RTAH42L		\$4,031	\$4,309

Features:

- eased edge profile on approach and user sides
- 22½" to 49" height adjustment
- maximum weight rating 140 lbs. (evenly distributed load)
- key pad features height display with three memory settings; key pad mounts left or right
- display will reference position to the nearest ½"
- 120" power cord

Options:

- specify Matte Black (MBK) or Arctic Silver (ASL) base finish
- reverse bevel edge available on desk approach side only, specify; add \$451 list for laminate or \$177 list for veneer; see page 8 for details
- top grommet available, specify location and add \$135 list each; see page 49 for details
- modesty panel available (2-sides) moves with worksurface, specify \$934 list for laminate or \$1,502 list for veneer; see page 21 for details
- undermount power available, specify and add \$994 list; power infeed sold separately, see page 224

Description	D	W	H	CTN WT	CU FT	① Model	HPL Laminate	Essentials Veneer	Artisan Veneer
Adjustable Height Table & Return - 90° Two Piece Top	72	72	Adj.	231	15	FLT2472RTAH48R	\$3,262		
	72	72	Adj.	231	15	FLV2472RTAH48R		\$4,044	\$4,328
	72	72	Adj.	231	15	FLT2472RTAH48L	\$3,262		
	72	72	Adj.	231	15	FLV2472RTAH48L		\$4,044	\$4,328
	72	66	Adj.	225	14	FLT2466RTAH48R	\$3,225		
	72	66	Adj.	225	14	FLV2466RTAH48R		\$3,997	\$4,277
	72	66	Adj.	225	14	FLT2466RTAH48L	\$3,225		
	72	66	Adj.	225	14	FLV2466RTAH48L		\$3,997	\$4,277
	72	60	Adj.	219	13	FLT2460RTAH48R	\$3,185		
	72	60	Adj.	219	13	FLV2460RTAH48R		\$3,948	\$4,224
	72	60	Adj.	219	13	FLT2460RTAH48L	\$3,185		
	72	60	Adj.	219	13	FLV2460RTAH48L		\$3,948	\$4,224

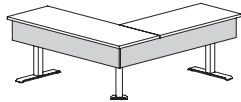
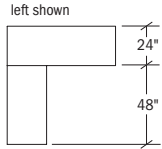
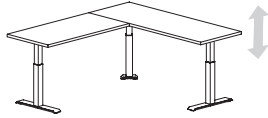
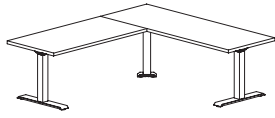

optional modesty panels

Features:

- eased edge profile on approach and user sides
- 22½” to 49” height adjustment
- maximum weight rating 140 lbs. (evenly distributed load)
- key pad features height display with three memory settings; key pad mounts left or right
- display will reference position to the nearest ½”
- 120” power cord

Options:

- specify Matte Black (MBK) or Arctic Silver (ASL) base finish
- reverse bevel edge available on desk approach side only, specify; add \$451 list for laminate or \$177 list for veneer; see page 8 for details
- top grommet available, specify location and add \$135 list each; see page 49 for details
- modesty panel available (2-sides) moves with worksurface, specify \$934 list for laminate or \$1,502 list for veneer; see page 21 for details
- undermount power available, specify and add \$994 list; power infeed sold separately, see page 224

To Order, Specify:

① Laminate Model #	② Laminate Type	③ Laminate Selection	④ Metal Color	⑤ Other Product Options		
Laminate (FLT)	HPL	See Laminate Selection	See Metal Finish Color Options	See list of options for each specific unit; Specify and add accordingly.		
① Veneer Model #	② Wood Collection	③ Wood Finish	④ Metal Color	⑤ Other Product Options		
Veneer (FLV)	Essentials	See Essentials Wood Finish Options	See Metal Finish Color Options	See list of options for each specific unit; Specify and add accordingly.		
	Artisan	<table border="1"> <tr> <th>ⓐ Wood Finish</th> <th>ⓑ Chassis Grain Direction</th> </tr> <tr> <td>See Artisan Wood Finish Options</td> <td>For Artisan Only: Vertical Horizontal</td> </tr> </table>	ⓐ Wood Finish		ⓑ Chassis Grain Direction	See Artisan Wood Finish Options
ⓐ Wood Finish	ⓑ Chassis Grain Direction					
See Artisan Wood Finish Options	For Artisan Only: Vertical Horizontal					

Description	D	W	H	CTN WT	CU FT	① Model	List Price
3 Prong Plug - 110 Power Infeed for Link System		72		1	1	EC-PI-L-72-A	\$280

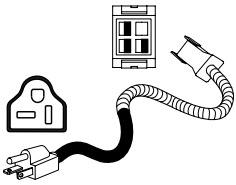

Features:

- 72" plug power infeed
- 20 amps/110 volts max
- 3 prong plug - 15 amp adapter plug
- single circuit use only
- use in conjunction with other link electrical items

plug included:
15 amp adapter

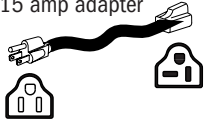

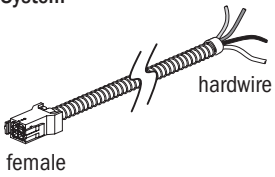

Hardwire Power Infeed for Link System		72		1	1	EC-PI-L-72-H	\$182
---------------------------------------	--	----	--	---	---	--------------	-------

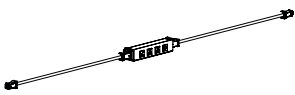
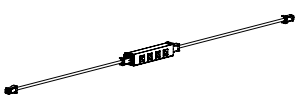
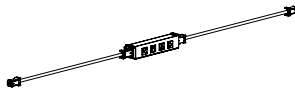
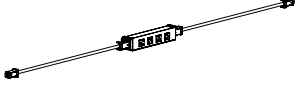

Features:

- 72" hardwire power infeed
- 20 amps/120 volts max
- single or two circuit
- electrical contractor responsible for connection to building power source
- use in conjunction with other link electrical items

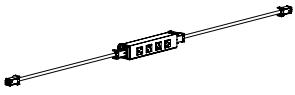
Description	D	W	H	CTN WT	CU FT	① Model	List Price
72" Power Link Kits - Circuit 1  <ul style="list-style-type: none"> · use with 72" tables · 72" plug power infeed required, sold separately · 20 amps/110 volts max · Circuit 1 · kit includes, undermount power with 4 outlets, jumpers, mounting brackets with screws, clamps & loop cable with black mesh 						ECAH-72UP-1	\$949
72" Power Link Kits - Circuit 2  <ul style="list-style-type: none"> · use with 72" tables · 72" plug power infeed required, sold separately · 20 amps/110 volts max · Circuit 2 · kit includes, undermount power with 4 outlets, jumpers, mounting brackets with screws, clamps & loop cable with black mesh 						ECAH-72UP-2	\$949
66" Power Link Kits - Circuit 1  <ul style="list-style-type: none"> · use with 66" tables · 72" plug power infeed required, sold separately · 20 amps/110 volts max · Circuit 1 · kit includes, undermount power with 4 outlets, jumpers, mounting brackets with screws, clamps & loop cable with black mesh 						ECAH-66UP-1	\$932
66" Power Link Kits - Circuit 2  <ul style="list-style-type: none"> · use with 66" tables · 72" plug power infeed required, sold separately · 20 amps/110 volts max · Circuit 2 · kit includes, undermount power with 4 outlets, jumpers, mounting brackets with screws, clamps & loop cable with black mesh 						ECAH-66UP-2	\$932
60" Power Link Kits - Circuit 1  <ul style="list-style-type: none"> · use with 60" tables · 72" plug power infeed · 20 amps/110 volts max · Circuit 1 						ECAH-60UP-1	\$913
60" Power Link Kits - Circuit 2  <ul style="list-style-type: none"> · use with 60" tables · 72" plug power infeed required, sold separately · 20 amps/110 volts max · Circuit 2 · kit includes, undermount power with 4 outlets, jumpers, mounting brackets with screws, clamps & loop cable with black mesh 						ECAH-60UP-2	\$913

FLUX

To Order, Specify:

① Model Number	
-----------------------	--

Description	D	W	H	CTN WT	CU FT	① Model	HPL Laminate	Essentials Veneer	Artisan Veneer
Adjustable Height Freestanding Desk Shell with Flush Modesty Panel	36	72	Adj.	305	51	FLT3672AHFDS	\$5,863		
	36	72	Adj.	305	51	FLV3672AHFDS		\$7,589	\$8,349
	36	66	Adj.	292	47	FLT3666AHFDS	\$5,826		
	36	66	Adj.	292	47	FLV3666AHFDS		\$7,539	\$8,292
	36	60	Adj.	279	43	FLT3660AHFDS	\$5,793		
	36	60	Adj.	279	43	FLV3660AHFDS		\$7,489	\$8,238

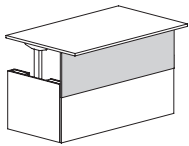
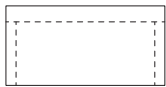
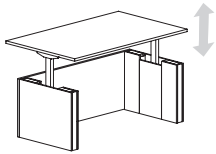
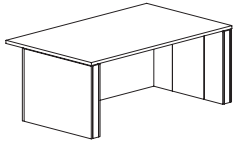

optional 20" modesty

Features:

- eased edge profile on approach and user sides
- 29" to 47" height adjustment with digital controller, wire guide and 10' power cord
- maximum weight rating 140 lbs. (evenly distributed load)

Options:

- must specify chassis grain direction on artisan veneer, see pages 13-15 for details
- reverse bevel edge available on desk approach side only, specify; add \$451 list for laminate or \$177 list for veneer; see page 8 for details
- 20"h modesty panel available, moves with worksurface, specify \$449 list for laminate or \$624 list for veneer; see page 17 for details
- top grommet available, specify location; add \$135 list each; see page 49 for details

Adjustable Height Freestanding Desk Shell with Flush Modesty Panel	30	72	Adj.	283	43	FLT3072AHFDS	\$5,693		
	30	72	Adj.	283	43	FLV3072AHFDS		\$7,362	\$8,100
	30	66	Adj.	271	40	FLT3066AHFDS	\$5,662		
	30	66	Adj.	271	40	FLV3066AHFDS		\$7,317	\$8,049
	30	60	Adj.	259	36	FLT3060AHFDS	\$5,631		
	30	60	Adj.	259	36	FLV3060AHFDS		\$7,274	\$7,999

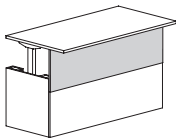
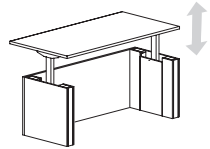
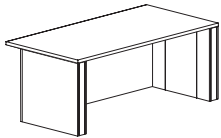

optional 20" modesty

Features:

- eased edge profile on approach and user sides
- 29" to 47" height adjustment with digital controller, wire guide and 10' power cord
- maximum weight rating 140 lbs. (evenly distributed load)

Options:

- must specify chassis grain direction on artisan veneer, see pages 13-15 for details
- reverse bevel edge available on desk approach side only, specify; add \$451 list for laminate or \$177 list for veneer; see page 8 for details
- 20"h modesty panel available, moves with worksurface, specify \$449 list for laminate or \$624 list for veneer; see page 17 for details
- top grommet available, specify location; add \$135 list each; see page 47 for details

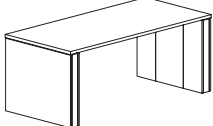
Description	D	W	H	CTN WT	CU FT	① Model	HPL Laminate	Essentials Veneer	Artisan Veneer
Adjustable Height Freestanding Table 	33 1/2	72	Adj.	261	48	FLT3472AHFT	\$5,869		
	33 1/2	72	Adj.	261	48	FLV3472AHFT		\$7,604	\$8,362
	33 1/2	66	Adj.	253	44	FLT3466AHFT	\$5,834		
	33 1/2	66	Adj.	253	44	FLV3466AHFT		\$7,550	\$8,307
	33 1/2	60	Adj.	245	40	FLT3460AHFT	\$5,806		
	33 1/2	60	Adj.	245	40	FLV3460AHFT		\$7,501	\$8,252

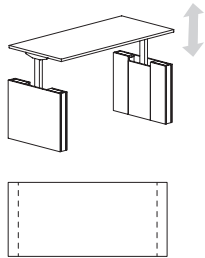

Features:

- eased edge profile on approach and user sides
- 29" to 47" height adjustment with digital controller, wire guide and 10' power cord
- maximum weight rating 140 lbs. (evenly distributed load)

Options:

- must specify chassis grain direction on artisan veneer, see pages 13-15 for details
- reverse bevel edge available on desk approach side only, specify; add \$451 list for laminate or \$177 list for veneer; see page 8 for details
- 13 1/2" h modesty panel available, moves with worksurface, specify \$449 list for laminate or \$624 list for veneer; see page 17 for details
- top grommet available, specify location; add \$135 list each; see page 47 for details

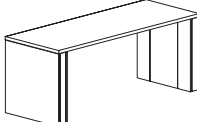
Adjustable Height Freestanding Table 	27 1/2	72	Adj.	227	40	FLT2872AHFT	\$5,698		
	27 1/2	72	Adj.	227	40	FLV2872AHFT		\$7,374	\$8,112
	27 1/2	66	Adj.	220	37	FLT2866AHFT	\$5,667		
	27 1/2	66	Adj.	220	37	FLV2866AHFT		\$7,326	\$8,061
	27 1/2	60	Adj.	213	34	FLT2860AHFT	\$5,637		
	27 1/2	60	Adj.	213	34	FLV2860AHFT		\$7,283	\$8,013

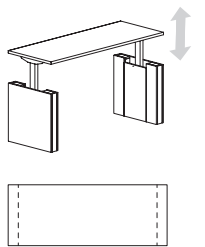

Features:

- eased edge profile on approach and user sides
- 29" to 47" height adjustment with digital controller, wire guide and 10' power cord
- maximum weight rating 140 lbs. (evenly distributed load)

Options:

- must specify chassis grain direction on artisan veneer, see pages 13-15 for details
- reverse bevel edge available on desk approach side only, specify; add \$451 list for laminate or \$177 list for veneer; see page 8 for details
- 13 1/2" h modesty panel available, moves with worksurface, specify \$449 list for laminate or \$624 list for veneer; see page 17 for details
- top grommet available, specify location; add \$135 list each; see page 47 for details

To Order, Specify:

① Laminate Model #	② Laminate Type	③ Laminate Selection	④ Metal Color	⑤ Other Product Options		
Laminate (FLT)	HPL	See Laminate Selection	See Metal Finish Color Options	See list of options for each specific unit; Specify and add accordingly.		
① Veneer Model #	② Wood Collection	③ Wood Finish	④ Metal Color	⑤ Other Product Options		
Veneer (FLV)	Essentials	See Essentials Wood Finish Options	See Metal Finish Color Options	See list of options for each specific unit; Specify and add accordingly.		
	Artisan	<table border="1"> <tr> <th>ⓐ Wood Finish</th> <th>ⓑ Chassis Grain Direction</th> </tr> <tr> <td>See Artisan Wood Finish Options</td> <td>For Artisan Only: Vertical Horizontal</td> </tr> </table>	ⓐ Wood Finish		ⓑ Chassis Grain Direction	See Artisan Wood Finish Options
ⓐ Wood Finish	ⓑ Chassis Grain Direction					
See Artisan Wood Finish Options	For Artisan Only: Vertical Horizontal					

Description	D	W	H	CTN WT	CU FT	① Model	HPL Laminate	Essentials Veneer	Artisan Veneer
	22	72	Adj.	251	32	FLT2272-29FAHC	\$5,693		
	22	72	Adj.	251	32	FLV2272-29FAHC		\$7,362	\$8,100
	22	66	Adj.	243	30	FLT2266-29FAHC	\$5,662		
	22	66	Adj.	243	30	FLV2266-29FAHC		\$7,317	\$8,049
	22	60	Adj.	233	27	FLT2260-29FAHC	\$5,631		
	22	60	Adj.	233	27	FLV2260-29FAHC		\$7,274	\$7,999
	22	54	Adj.	222	25	FLT2254-29FAHC	\$5,603		
	22	54	Adj.	222	25	FLV2254-29FAHC		\$7,231	\$7,953
	22	48	Adj.	205	22	FLT2248-29FAHC	\$5,577		
22	48	Adj.	205	22	FLV2248-29FAHC		\$7,189	\$7,908	

Features:

- use to expand work station
- eased edge profile user side
- 29" to 47" height adjustment with digital controller, wire guide and 10' power cord

Options:

- must specify chassis grain direction on artisan veneer, see pages 13-15 for details
- top grommet available, specify location; add \$135 list each; see page 48 for details

FLUX

Description	D	W	H	CTN WT	CU FT	① Model	HPL Laminate	Essentials Veneer	Artisan Veneer
	22	72	Adj.	261	32	FLT2272-29FAHCE	\$4,809		
	22	72	Adj.	261	32	FLV2272-29FAHCE		\$5,995	\$6,593
	22	66	Adj.	249	30	FLT2266-29FAHCE	\$4,778		
	22	66	Adj.	249	30	FLV2266-29FAHCE		\$5,953	\$6,547
	22	60	Adj.	242	27	FLT2260-29FAHCE	\$4,751		
	22	60	Adj.	242	27	FLV2260-29FAHCE		\$5,914	\$6,503
	22	54	Adj.	232	25	FLT2254-29FAHCE	\$4,723		
	22	54	Adj.	232	25	FLV2254-29FAHCE		\$5,872	\$6,459
	22	48	Adj.	226	22	FLT2248-29FAHCE	\$4,696		
	22	48	Adj.	226	22	FLV2248-29FAHCE		\$5,832	\$6,416

Features:

- use to expand work station
- eased edge profile user side
- 29" to 47" height adjustment with digital controller, wire guide and 10' power cord

Options:

- must specify chassis grain direction on artisan veneer, see pages 13-15 for details
- top grommet available, specify location; add \$135 list each; see page 48 for details
- wall access cutouts available, specify and add \$243 list

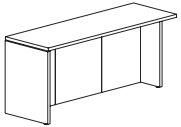
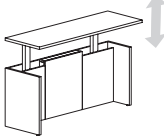
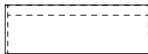
Description	D	W	H	CTN WT	CU FT	① Model	HPL Laminate	Essentials Veneer	Artisan Veneer
Adjustable Height Return Shell  left shown  	22	72	Adj.	220	33	FLT2272-29FAHRR	\$4,809		
	22	72	Adj.	220	33	FLV2272-29FAHRR		\$5,995	\$6,593
	22	72	Adj.	220	33	FLT2272-29FAHRL	\$4,809		
	22	72	Adj.	220	33	FLV2272-29FAHRL		\$5,995	\$6,593
	22	66	Adj.	208	30	FLT2266-29FAHRR	\$4,778		
	22	66	Adj.	208	30	FLV2266-29FAHRR		\$5,953	\$6,547
	22	66	Adj.	208	30	FLT2266-29FAHRL	\$4,778		
	22	66	Adj.	208	30	FLV2266-29FAHRL		\$5,953	\$6,547
	22	60	Adj.	196	27	FLT2260-29FAHRR	\$4,751		
	22	60	Adj.	196	27	FLV2260-29FAHRR		\$5,914	\$6,503
	22	60	Adj.	196	27	FLT2260-29FAHRL	\$4,751		
	22	60	Adj.	196	27	FLV2260-29FAHRL		\$5,914	\$6,503
	22	54	Adj.	184	25	FLT2254-29FAHRR	\$4,723		
	22	54	Adj.	184	25	FLV2254-29FAHRR		\$5,872	\$6,459
	22	54	Adj.	184	25	FLT2254-29FAHRL	\$4,723		
	22	54	Adj.	184	25	FLV2254-29FAHRL		\$5,872	\$6,459
	22	48	Adj.	172	22	FLT2248-29FAHRR	\$4,696		
	22	48	Adj.	172	22	FLV2248-29FAHRR		\$5,832	\$6,416
	22	48	Adj.	172	22	FLT2248-29FAHRL	\$4,696		
	22	48	Adj.	172	22	FLV2248-29FAHRL		\$5,832	\$6,416

Features:

- must be used with desk
- laminate tops wider than 60" are long grain
- 29" to 47" height adjustment with digital controller, wire guide and 10' power cord
- maximum weight rating 100 lbs. (evenly distributed load)

Options:

- must specify chassis grain direction on artisan veneer, see pages 13-15 for details
- top grommet available, specify location; add \$135 list each; see page 48 for details
- wall access cutouts available, specify and add \$243 list

To Order, Specify:

① Laminate Model #	② Laminate Type	③ Laminate Selection	④ Metal Color	⑤ Other Product Options		
Laminate (FLT)	HPL	See Laminate Selection	See Metal Finish Color Options	See list of options for each specific unit; Specify and add accordingly.		
① Veneer Model #	② Wood Collection	③ Wood Finish	④ Metal Color	⑤ Other Product Options		
Veneer (FLV)	Essentials	See Essentials Wood Finish Options	See Metal Finish Color Options	See list of options for each specific unit; Specify and add accordingly.		
	Artisan	<table border="1"> <thead> <tr> <th>ⓐ Wood Finish</th> <th>ⓑ Chassis Grain Direction</th> </tr> </thead> <tbody> <tr> <td>See Artisan Wood Finish Options</td> <td>For Artisan Only: Vertical Horizontal</td> </tr> </tbody> </table>	ⓐ Wood Finish		ⓑ Chassis Grain Direction	See Artisan Wood Finish Options
ⓐ Wood Finish	ⓑ Chassis Grain Direction					
See Artisan Wood Finish Options	For Artisan Only: Vertical Horizontal					

Description	D	W	H	CTN WT	CU FT	① Model	HPL Laminate	Essentials Veneer	Artisan Veneer
Adjustable Height U-Configuration Desk and Bridge	80	72	Adj.	470	110	FLT3672-U44AHR	\$8,534		
	80	72	Adj.	470	110	FLV3672-U44AHR		\$10,874	\$11,960
	80	72	Adj.	470	110	FLT3672-U44AHL	\$8,534		
	80	72	Adj.	470	110	FLV3672-U44AHL		\$10,874	\$11,960
	80	66	Adj.	433	101	FLT3666-U44AHR	\$8,431		
	80	66	Adj.	433	101	FLV3666-U44AHR		\$10,726	\$11,798
	80	66	Adj.	433	101	FLT3666-U44AHL	\$8,431		
	80	66	Adj.	433	101	FLV3666-U44AHL		\$10,726	\$11,798
	80	60	Adj.	419	92	FLT3660-U44AHR	\$8,331		
	80	60	Adj.	419	92	FLV3660-U44AHR		\$10,581	\$11,641
	80	60	Adj.	419	92	FLT3660-U44AHL	\$8,331		
	80	60	Adj.	419	92	FLV3660-U44AHL		\$10,581	\$11,641

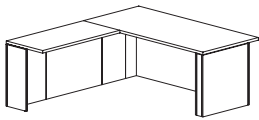

left shown

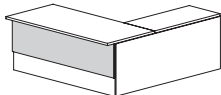
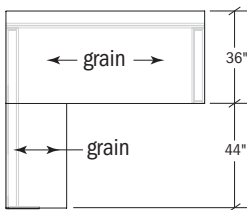
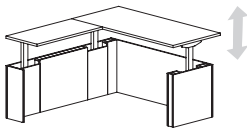

20" h optional modesty

Features:

- must attach to open corner credenza
- eased edge profile on approach and user sides
- 29" to 47" height adjustment with digital controller, wire guide and 10' power cord
- maximum weight rating 210 lbs. (evenly distributed load)

Options:

- must specify chassis grain direction on artisan veneer, see pages 13-15 for details
- reverse bevel edge available on desk approach side only, specify; add \$451 list for laminate or \$177 list for veneer; see page 8 for details
- 20" h modesty panel available, moves with worksurface, specify \$449 list for laminate or \$624 list for veneer; see page 17 for details
- top grommet available, specify location; add \$135 list each; see page 49 for details
- wall access cutouts available, specify and add \$243 list

FLUX

Description	D	W	H	CTN WT	CU FT	① Model	HPL Laminate	Essentials Veneer	Artisan Veneer
Adjustable Height U-Configuration Desk and Bridge	74	72	Adj.	452	102	FLT3672-U38AHR	\$8,503		
	74	72	Adj.	452	102	FLV3672-U38AHR		\$10,827	\$11,910
	74	72	Adj.	452	102	FLT3672-U38AHL	\$8,503		
	74	72	Adj.	452	102	FLV3672-U38AHL		\$10,827	\$11,910
	74	66	Adj.	415	94	FLT3666-U38AHR	\$8,399		
	74	66	Adj.	415	94	FLV3666-U38AHR		\$10,679	\$11,749
	74	66	Adj.	415	94	FLT3666-U38AHL	\$8,399		
	74	66	Adj.	415	94	FLV3666-U38AHL		\$10,679	\$11,749
	74	60	Adj.	401	86	FLT3660-U38AHR	\$8,297		
	74	60	Adj.	401	86	FLV3660-U38AHR		\$10,535	\$11,588
	74	60	Adj.	401	86	FLT3660-U38AHL	\$8,297		
	74	60	Adj.	401	86	FLV3660-U38AHL		\$10,535	\$11,588

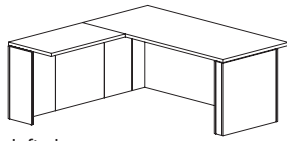

left shown

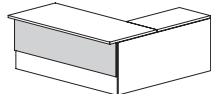
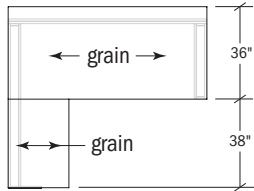
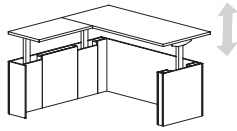

20" h optional modesty

Features:

- must attach to open corner credenza
- eased edge profile on approach and user sides
- 29" to 47" height adjustment with digital controller, wire guide and 10' power cord
- maximum weight rating 210 lbs. (evenly distributed load)

Options:

- must specify chassis grain direction on artisan veneer, see pages 13-15 for details
- reverse bevel edge available on desk approach side only, specify; add \$451 list for laminate or \$177 list for veneer; see page 8 for details
- 20" h modesty panel available, moves with worksurface, specify \$449 list for laminate or \$624 list for veneer; see page 17 for details
- top grommet available, specify location; add \$135 list each; see page 49 for details
- wall access cutouts available, specify and add \$243 list

FLUX

To Order, Specify:

① Laminate Model #	② Laminate Type	③ Laminate Selection	④ Metal Color	⑤ Other Product Options		
Laminate (FLT)	HPL	See Laminate Selection	See Metal Finish Color Options	See list of options for each specific unit; Specify and add accordingly.		
① Veneer Model #	② Wood Collection	③ Wood Finish	④ Metal Color	⑤ Other Product Options		
Veneer (FLV)	Essentials	See Essentials Wood Finish Options	See Metal Finish Color Options	See list of options for each specific unit; Specify and add accordingly.		
	Artisan	<table border="1"> <tr> <th>ⓐ Wood Finish</th> <th>ⓑ Chassis Grain Direction</th> </tr> <tr> <td>See Artisan Wood Finish Options</td> <td>For Artisan Only: Vertical Horizontal</td> </tr> </table>	ⓐ Wood Finish		ⓑ Chassis Grain Direction	See Artisan Wood Finish Options
ⓐ Wood Finish	ⓑ Chassis Grain Direction					
See Artisan Wood Finish Options	For Artisan Only: Vertical Horizontal					

Description	D	W	H	CTN WT	CU FT	① Model	HPL Laminate	Essentials Veneer	Artisan Veneer
Adjustable Height U-Configuration Desk and Bridge	74	72	Adj.	433	102	FLT3072-U44AHR	\$8,290		
	74	72	Adj.	433	102	FLV3072-U44AHR		\$10,593	\$11,651
	74	72	Adj.	433	102	FLT3072-U44AHL	\$8,290		
	74	72	Adj.	433	102	FLV3072-U44AHL		\$10,593	\$11,651
	74	66	Adj.	396	94	FLT3066-U44AHR	\$8,188		
	74	66	Adj.	396	94	FLV3066-U44AHR		\$10,446	\$11,490
	74	66	Adj.	396	94	FLT3066-U44AHL	\$8,188		
	74	66	Adj.	396	94	FLV3066-U44AHL		\$10,446	\$11,490
	74	60	Adj.	382	86	FLT3060-U44AHR	\$8,088		
	74	60	Adj.	382	86	FLV3060-U44AHR		\$10,299	\$11,330
	74	60	Adj.	382	86	FLT3060-U44AHL	\$8,088		
	74	60	Adj.	382	86	FLV3060-U44AHL		\$10,299	\$11,330

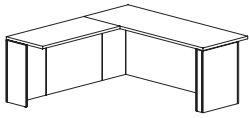

left shown

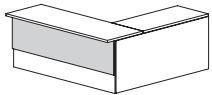
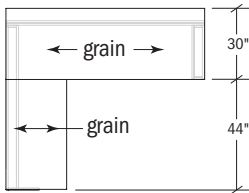
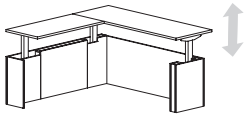

20" h optional modesty

Features:

- must attach to open corner credenza
- eased edge profile on approach and user sides
- 29" to 47" height adjustment with digital controller, wire guide and 10' power cord
- maximum weight rating 210 lbs. (evenly distributed load)

Options:

- must specify chassis grain direction on artisan veneer, see pages 13-15 for details
- reverse bevel edge available on desk approach side only, specify; add \$451 list for laminate or \$177 list for veneer; see page 8 for details
- 20" h modesty panel available, moves with worksurface, specify \$449 list for laminate or \$624 list for veneer; see page 17 for details
- top grommet available, specify location; add \$135 list each; see page 49 for details
- wall access cutouts available, specify and add \$243 list

FLUX

Description	D	W	H	CTN WT	CU FT	① Model	HPL Laminate	Essentials Veneer	Artisan Veneer
Adjustable Height U-Configuration Desk and Bridge	68	72	Adj.	415	94	FLT3072-U38AHR	\$8,260		
	68	72	Adj.	415	94	FLV3072-U38AHR		\$10,545	\$11,600
	68	72	Adj.	415	94	FLT3072-U38AHL	\$8,260		
	68	72	Adj.	415	94	FLV3072-U38AHL		\$10,545	\$11,600
	68	66	Adj.	378	87	FLT3066-U38AHR	\$8,157		
	68	66	Adj.	378	87	FLV3066-U38AHR		\$10,400	\$11,438
	68	66	Adj.	378	87	FLT3066-U38AHL	\$8,157		
	68	66	Adj.	378	87	FLV3066-U38AHL		\$10,400	\$11,438
	68	60	Adj.	364	79	FLT3060-U38AHR	\$8,055		
	68	60	Adj.	364	79	FLV3060-U38AHR		\$10,254	\$11,277
	68	60	Adj.	364	79	FLT3060-U38AHL	\$8,055		
	68	60	Adj.	364	79	FLV3060-U38AHL		\$10,254	\$11,277

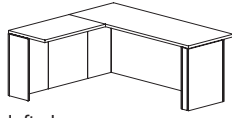

left shown

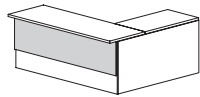
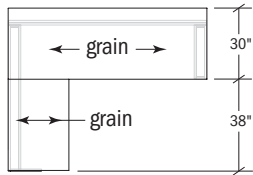
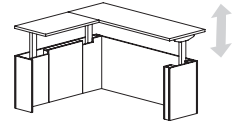

20" h optional modesty

Features:

- must attach to open corner credenza
- eased edge profile on approach and user sides
- 29" to 47" height adjustment with digital controller, wire guide and 10' power cord
- maximum weight rating 210 lbs. (evenly distributed load)

Options:

- must specify chassis grain direction on artisan veneer, see pages 13-15 for details
- reverse bevel edge available on desk approach side only, specify; add \$451 list for laminate or \$177 list for veneer; see page 8 for details
- 20" h modesty panel available, moves with worksurface, specify \$449 list for laminate or \$624 list for veneer; see page 17 for details
- top grommet available, specify location; add \$135 list each; see page 49 for details
- wall access cutouts available, specify and add \$243 list

To Order, Specify:

① Laminate Model #	② Laminate Type	③ Laminate Selection	④ Metal Color	⑤ Other Product Options		
Laminate (FLT)	HPL	See Laminate Selection	See Metal Finish Color Options	See list of options for each specific unit; Specify and add accordingly.		
① Veneer Model #	② Wood Collection	③ Wood Finish	④ Metal Color	⑤ Other Product Options		
Veneer (FLV)	Essentials	See Essentials Wood Finish Options	See Metal Finish Color Options	See list of options for each specific unit; Specify and add accordingly.		
	Artisan	<table border="1"> <tr> <th>ⓐ Wood Finish</th> <th>ⓑ Chassis Grain Direction</th> </tr> <tr> <td>See Artisan Wood Finish Options</td> <td>For Artisan Only: Vertical Horizontal</td> </tr> </table>	ⓐ Wood Finish		ⓑ Chassis Grain Direction	See Artisan Wood Finish Options
ⓐ Wood Finish	ⓑ Chassis Grain Direction					
See Artisan Wood Finish Options	For Artisan Only: Vertical Horizontal					

Description	D	W	H	CTN WT	CU FT	① Model	HPL Laminate	Essentials Veneer	Artisan Veneer
Adjustable Height L-Configuration Desk and Return	80	72	Adj.	481	110	FLT3672-L44AHR	\$8,534		
	80	72	Adj.	481	110	FLV3672-L44AHR		\$10,874	\$11,960
	80	72	Adj.	481	110	FLT3672-L44AHL	\$8,534		
	80	72	Adj.	481	110	FLV3672-L44AHL		\$10,874	\$11,960
	80	66	Adj.	444	101	FLT3666-L44AHR	\$8,431		
	80	66	Adj.	444	101	FLV3666-L44AHR		\$10,726	\$11,798
	80	66	Adj.	444	101	FLT3666-L44AHL	\$8,431		
	80	66	Adj.	444	101	FLV3666-L44AHL		\$10,726	\$11,798
	80	60	Adj.	430	92	FLT3660-L44AHR	\$8,331		
	80	60	Adj.	430	92	FLV3660-L44AHR		\$10,581	\$11,641
	80	60	Adj.	430	92	FLT3660-L44AHL	\$8,331		
	80	60	Adj.	430	92	FLV3660-L44AHL		\$10,581	\$11,641

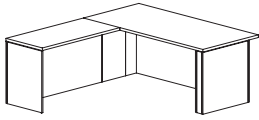

left shown

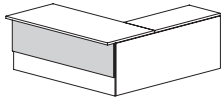
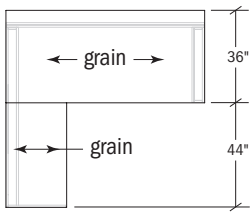
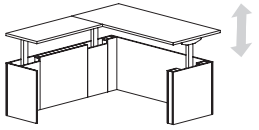

20"h optional modesty

Features:

- eased edge profile on approach and user sides
- 29" to 47" height adjustment with digital controller, wire guide and 10' power cord
- maximum weight rating 210 lbs. (evenly distributed load)

Options:

- must specify chassis grain direction on artisan veneer, see pages 13-15 for details
- reverse bevel edge available on desk approach side only, specify; add \$451 list for laminate or \$177 list for veneer; see page 8 for details
- 20"h modesty panel available, moves with worksurface, specify \$449 list for laminate or \$624 list for veneer; see page 17 for details
- top grommet available, specify location; add \$135 list each; see page 49 for details
- wall access cutouts available, specify and add \$243 list

Description	D	W	H	CTN WT	CU FT	① Model	HPL Laminate	Essentials Veneer	Artisan Veneer
Adjustable Height L-Configuration Desk and Return left shown 20"h optional modesty	74	72	Adj.	463	102	FLT3672-L38AHR	\$8,503		
	74	72	Adj.	463	102	FLV3672-L38AHR		\$10,827	\$11,910
	74	72	Adj.	463	102	FLT3672-L38AHL	\$8,503		
	74	72	Adj.	463	102	FLV3672-L38AHL		\$10,827	\$11,910
	74	66	Adj.	426	94	FLT3666-L38AHR	\$8,399		
	74	66	Adj.	426	94	FLV3666-L38AHR		\$10,679	\$11,749
	74	66	Adj.	426	94	FLT3666-L38AHL	\$8,399		
	74	66	Adj.	426	94	FLV3666-L38AHL		\$10,679	\$11,749
	74	60	Adj.	412	86	FLT3660-L38AHR	\$8,297		
	74	60	Adj.	412	86	FLV3660-L38AHR		\$10,535	\$11,588
	74	60	Adj.	412	86	FLT3660-L38AHL	\$8,297		
	74	60	Adj.	412	86	FLV3660-L38AHL		\$10,535	\$11,588

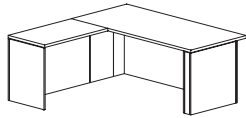

left shown

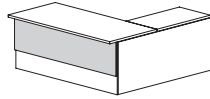
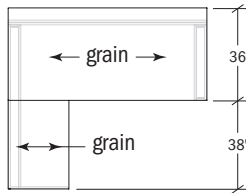
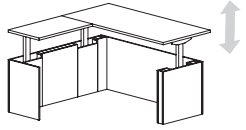

20"h optional modesty

Features:

- eased edge profile on approach and user sides
- 29" to 47" height adjustment with digital controller, wire guide and 10' power cord
- maximum weight rating 210 lbs. (evenly distributed load)

Options:

- must specify chassis grain direction on artisan veneer, see pages 13-15 for details
- reverse bevel edge available on desk approach side only, specify; add \$451 list for laminate or \$177 list for veneer; see page 8 for details
- 20" h modesty panel available, moves with worksurface, specify \$449 list for laminate or \$624 list for veneer; see page 17 for details
- top grommet available, specify location; add \$135 list each; see page 49 for details
- wall access cutouts available, specify and add \$243 list

FLUX

To Order, Specify:

① Laminate Model #	② Laminate Type	③ Laminate Selection	④ Metal Color	⑤ Other Product Options
Laminate (FLT)	HPL	See Laminate Selection	See Metal Finish Color Options	See list of options for each specific unit; Specify and add accordingly.

① Veneer Model #	② Wood Collection	③ Wood Finish	④ Metal Color	⑤ Other Product Options		
Veneer (FLV)	Essentials	See Essentials Wood Finish Options	See Metal Finish Color Options	See list of options for each specific unit; Specify and add accordingly.		
	Artisan	<table border="1"> <thead> <tr> <th>ⓐ Wood Finish</th> <th>ⓑ Chassis Grain Direction</th> </tr> </thead> <tbody> <tr> <td>See Artisan Wood Finish Options</td> <td>For Artisan Only: Vertical Horizontal</td> </tr> </tbody> </table>	ⓐ Wood Finish		ⓑ Chassis Grain Direction	See Artisan Wood Finish Options
ⓐ Wood Finish	ⓑ Chassis Grain Direction					
See Artisan Wood Finish Options	For Artisan Only: Vertical Horizontal					

Description	D	W	H	CTN WT	CU FT	① Model	HPL Laminate	Essentials Veneer	Artisan Veneer
Adjustable Height L-Configuration Desk and Return	74	72	Adj.	444	102	FLT3072-L44AHR	\$8,290		
	74	72	Adj.	444	102	FLV3072-L44AHR		\$10,593	\$11,651
	74	72	Adj.	444	102	FLT3072-L44AHL	\$8,290		
	74	72	Adj.	444	102	FLV3072-L44AHL		\$10,593	\$11,651
	74	66	Adj.	407	94	FLT3066-L44AHR	\$8,188		
	74	66	Adj.	407	94	FLV3066-L44AHR		\$10,446	\$11,490
	74	66	Adj.	407	94	FLT3066-L44AHL	\$8,188		
	74	66	Adj.	407	94	FLV3066-L44AHL		\$10,446	\$11,490
	74	60	Adj.	393	86	FLT3060-L44AHR	\$8,088		
	74	60	Adj.	393	86	FLV3060-L44AHR		\$10,299	\$11,330
	74	60	Adj.	393	86	FLT3060-L44AHL	\$8,088		
	74	60	Adj.	393	86	FLV3060-L44AHL		\$10,299	\$11,330

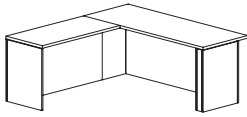

left shown

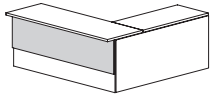
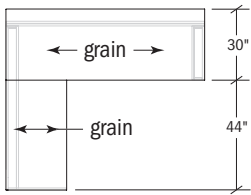
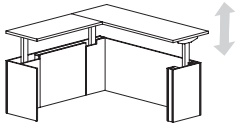

20" h optional modesty

Features:

- eased edge profile on approach and user sides
- 29" to 47" height adjustment with digital controller, wire guide and 10' power cord
- maximum weight rating 210 lbs. (evenly distributed load)

Options:

- must specify chassis grain direction on artisan veneer, see pages 13-15 for details
- reverse bevel edge available on desk approach side only, specify; add \$451 list for laminate or \$177 list for veneer; see page 8 for details
- 20" h modesty panel available, moves with worksurface, specify \$449 list for laminate or \$624 list for veneer; see page 17 for details
- top grommet available, specify location; add \$135 list each; see page 49 for details
- wall access cutouts available, specify and add \$243 list

Description	D	W	H	CTN WT	CU FT	① Model	HPL Laminate	Essentials Veneer	Artisan Veneer
Adjustable Height L-Configuration Desk and Return	68	72	Adj.	426	94	FLT3072-L38AHR	\$8,260		
	68	72	Adj.	426	94	FLV3072-L38AHR		\$10,545	\$11,600
	68	72	Adj.	426	94	FLT3072-L38AHL	\$8,260		
	68	72	Adj.	426	94	FLV3072-L38AHL		\$10,545	\$11,600
	68	66	Adj.	389	87	FLT3066-L38AHR	\$8,157		
	68	66	Adj.	389	87	FLV3066-L38AHR		\$10,400	\$11,438
	68	66	Adj.	389	87	FLT3066-L38AHL	\$8,157		
	68	66	Adj.	389	87	FLV3066-L38AHL		\$10,400	\$11,438
	68	60	Adj.	375	79	FLT3060-L38AHR	\$8,055		
	68	60	Adj.	375	79	FLV3060-L38AHR		\$10,254	\$11,277
	68	60	Adj.	375	79	FLT3060-L38AHL	\$8,055		
	68	60	Adj.	375	79	FLV3060-L38AHL		\$10,254	\$11,277

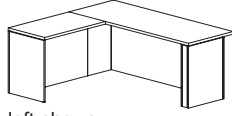

left shown

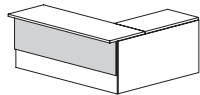
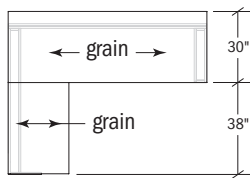
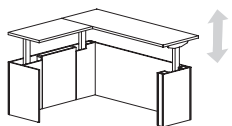

20"h optional modesty

Features:

- eased edge profile on approach and user sides
- 29" to 47" height adjustment with digital controller, wire guide and 10' power cord
- maximum weight rating 210 lbs. (evenly distributed load)

Options:

- must specify chassis grain direction on artisan veneer, see pages 13-15 for details
- reverse bevel edge available on desk approach side only, specify; add \$451 list for laminate or \$177 list for veneer; see page 8 for details
- 20"h modesty panel available, moves with worksurface, specify \$449 list for laminate or \$624 list for veneer; see page 17 for details
- top grommet available, specify location; add \$135 list each; see page 49 for details
- wall access cutouts available, specify and add \$243 list

FLUX

To Order, Specify:

① Laminate Model #	② Laminate Type	③ Laminate Selection	④ Metal Color	⑤ Other Product Options
Laminate (FLT)	HPL	See Laminate Selection	See Metal Finish Color Options	See list of options for each specific unit; Specify and add accordingly.

① Veneer Model #	② Wood Collection	③ Wood Finish	④ Metal Color	⑤ Other Product Options		
Veneer (FLV)	Essentials	See Essentials Wood Finish Options	See Metal Finish Color Options	See list of options for each specific unit; Specify and add accordingly.		
	Artisan	<table border="1"> <thead> <tr> <th>ⓐ Wood Finish</th> <th>ⓑ Chassis Grain Direction</th> </tr> </thead> <tbody> <tr> <td>See Artisan Wood Finish Options</td> <td>For Artisan Only: Vertical Horizontal</td> </tr> </tbody> </table>	ⓐ Wood Finish		ⓑ Chassis Grain Direction	See Artisan Wood Finish Options
ⓐ Wood Finish	ⓑ Chassis Grain Direction					
See Artisan Wood Finish Options	For Artisan Only: Vertical Horizontal					

Description	D	W	H	CTN WT	CU FT	① Model	HPL Laminate	Essentials Veneer	Artisan Veneer
Adjustable Height L-Configuration Desk and Return with One Piece Top	60	72	Adj.	449	83	FLT3672-C24AHR	\$8,480		
	60	72	Adj.	449	83	FLV3672-C24AHR		\$10,796	\$11,877
	60	72	Adj.	449	83	FLT3672-C24AHL	\$8,480		
	60	72	Adj.	449	83	FLV3672-C24AHL		\$10,796	\$11,877
	60	66	Adj.	412	77	FLT3666-C24AHR	\$8,377		
	60	66	Adj.	412	77	FLV3666-C24AHR		\$10,649	\$11,714
	60	66	Adj.	412	77	FLT3666-C24AHL	\$8,377		
	60	66	Adj.	412	77	FLV3666-C24AHL		\$10,649	\$11,714
	60	60	Adj.	398	70	FLT3660-C24AHR	\$8,278		
	60	60	Adj.	398	70	FLV3660-C24AHR		\$10,503	\$11,555
	60	60	Adj.	398	70	FLT3660-C24AHL	\$8,278		
	60	60	Adj.	398	70	FLV3660-C24AHL		\$10,503	\$11,555

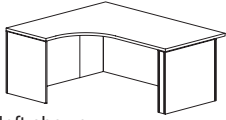

left shown

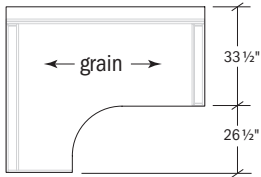
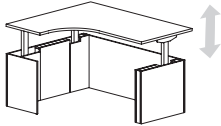

Features:

- eased edge profile on approach and user sides
- 29" to 47" height adjustment with digital controller, wire guide and 10' power cord
- maximum weight rating 210 lbs. (evenly distributed load)

Options:

- must specify chassis grain direction on artisan veneer, see pages 13-15 for details
- reverse bevel edge available on desk approach side only, specify; add \$451 list for laminate or \$177 list for veneer; see page 8 for details
- 20"h modesty panel available, moves with worksurface, specify \$449 list for laminate or \$624 list for veneer; see page 17 for details
- top grommet available, specify location; add \$135 list each; see page 49 for details
- wall access cutouts available, specify and add \$243 list

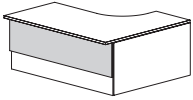

20"h optional modesty

FLUX

Description	D	W	H	CTN WT	CU FT	① Model	HPL Laminate	Essentials Veneer	Artisan Veneer
Adjustable Height L-Configuration Desk and Return with One Piece Top	60	72	Adj.	412	83	FLT3072-C30AHR	\$8,268		
	60	72	Adj.	412	83	FLV3072-C30AHR		\$10,561	\$11,618
	60	72	Adj.	412	83	FLT3072-C30AHL	\$8,268		
	60	72	Adj.	412	83	FLV3072-C30AHL		\$10,561	\$11,618
	60	66	Adj.	375	77	FLT3066-C30AHR	\$8,165		
	60	66	Adj.	375	77	FLV3066-C30AHR		\$10,413	\$11,456
	60	66	Adj.	375	77	FLT3066-C30AHL	\$8,165		
	60	66	Adj.	375	77	FLV3066-C30AHL		\$10,413	\$11,456
	60	60	Adj.	361	70	FLT3060-C30AHR	\$8,066		
	60	60	Adj.	361	70	FLV3060-C30AHR		\$10,269	\$11,297
	60	60	Adj.	361	70	FLT3060-C30AHL	\$8,066		
	60	60	Adj.	361	70	FLV3060-C30AHL		\$10,269	\$11,297

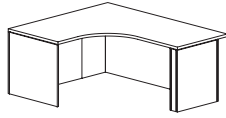

left shown

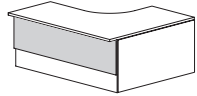
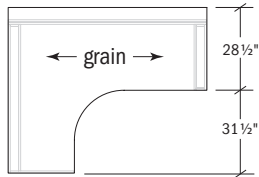
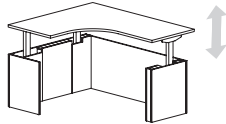

20"h optional modesty

Features:

- eased edge profile on approach and user sides
- 29" to 47" height adjustment with digital controller, wire guide and 10' power cord
- maximum weight rating 210 lbs. (evenly distributed load)

Options:

- must specify chassis grain direction on artisan veneer, see pages 13-15 for details
- reverse bevel edge available on desk approach side only, specify; add \$451 list for laminate or \$177 list for veneer; see page 8 for details
- 20" h modesty panel available, moves with worksurface, specify \$449 list for laminate or \$624 list for veneer; see page 17 for details
- top grommet available, specify location; add \$135 list each; see page 49 for details
- wall access cutouts available, specify and add \$243 list

To Order, Specify:

① Laminate Model #	② Laminate Type	③ Laminate Selection	④ Metal Color	⑤ Other Product Options		
Laminate (FLT)	HPL	See Laminate Selection	See Metal Finish Color Options	See list of options for each specific unit; Specify and add accordingly.		
① Veneer Model #	② Wood Collection	③ Wood Finish	④ Metal Color	⑤ Other Product Options		
Veneer (FLV)	Essentials	See Essentials Wood Finish Options	See Metal Finish Color Options	See list of options for each specific unit; Specify and add accordingly.		
	Artisan	<table border="1"> <tr> <th>ⓐ Wood Finish</th> <th>ⓑ Chassis Grain Direction</th> </tr> <tr> <td>See Artisan Wood Finish Options</td> <td>For Artisan Only: Vertical Horizontal</td> </tr> </table>	ⓐ Wood Finish		ⓑ Chassis Grain Direction	See Artisan Wood Finish Options
ⓐ Wood Finish	ⓑ Chassis Grain Direction					
See Artisan Wood Finish Options	For Artisan Only: Vertical Horizontal					

Description	D	W	H	CTN WT	CU FT	① Model	HPL Laminate	Essentials Veneer	Artisan Veneer
33" Adjustable Height Modular Peninsula Desk	33½	72	Adj.	205	26	FLT3472PAHD	\$4,732		
	33½	72	Adj.	205	26	FLV3472PAHD		\$5,916	\$6,505
	33½	66	Adj.	198	25	FLT3466PAHD	\$4,707		
	33½	66	Adj.	198	25	FLV3466PAHD		\$5,877	\$6,465
	33½	60	Adj.	191	24	FLT3460PAHD	\$4,683		
	33½	60	Adj.	191	24	FLV3460PAHD		\$5,843	\$6,425

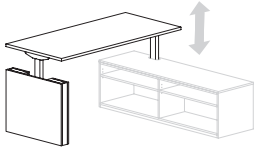
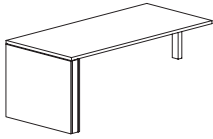

in application

Features:

- must be used with 96", 72" and 36" wide secondary height peninsula mount credenzas
- 29" to 47" height adjustment with digital controller, wire guide and 10' power cord
- maximum weight rating 140 lbs. (evenly distributed load)

Options:

- must specify chassis grain direction on artisan veneer, see pages 13-15 for details
- reverse bevel edge available on approach and user sides, specify; add \$451 list for laminate or \$177 list for veneer; see page 8 for details
- 13½" h modesty panel available, specify; add \$449 list for laminate or \$624 list for veneer; see page 21 for details
- top grommet available, specify location; add \$135 list each; see page 49 for details
- worksurface power available, specify "to accommodate EC26" on your purchase order; EC26 unit must be ordered separately, see page 49

Box/Lateral File Storage Credenza with Peninsula Desk Mount	22	96	21	306	32	FLT2296-21FM60	\$3,066		
	22	96	21	306	32	FLV2296-21FM60		\$4,109	\$4,518
	22	96	21	306	32	FLT2296-21F06M	\$3,066		
	22	96	21	306	32	FLV2296-21F06M		\$4,109	\$4,518

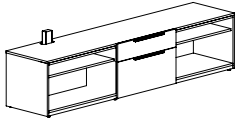

*M60 shown

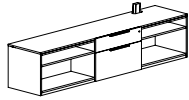

*O6M

Features:

- must be used with 33" deep adjustable height modular peninsula desk
- desk lift column can only be mounted in sections with an open compartment, see page 39 for details
- open compartments with adjustable shelves

Options:

- must specify chassis grain direction on artisan veneer, see pages 13-15 for details
- veneer drawer fronts in paint available, specify paint color; add \$354 list; see page 16 for details
- on laminate units, contrasting worksurface tops and drawer fronts available, no upcharge; specify laminate color, see page 16 for details
- ledge pulls standard; prism pulls available, specify and see page 9
- oval grommets in back panels can be eliminated upon request, no upcharge
- concealed box drawer(s) available, specify location in unit; add \$246 list for each laminate drawer or \$375 list for each veneer drawer, see page 25 for details
- seat cushion available, see page 25 for more details and page 212 for pricing
- top grommet available, specify location; add \$135 list each; see page 46 for details
- interior wire manager from side to side in upper back, specify and add \$120 list; see page 17 for details

Box/Lateral File Storage Credenza with Peninsula Desk Mount	22	96	21	341	32	FLT2296-21FM66	\$3,288		
	22	96	21	341	32	FLV2296-21FM66		\$4,406	\$4,847
	22	96	21	341	32	FLT2296-21F66M	\$3,288		
	22	96	21	341	32	FLV2296-21F66M		\$4,406	\$4,847

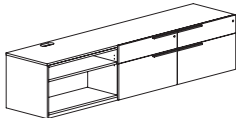

*M66 shown



*66M

Features:

- must be used with 33" deep adjustable height modular peninsula desk
- desk lift column can only be mounted in sections with an open compartment, see page 39 for details
- open compartment with adjustable shelf

Options:

- must specify chassis grain direction on artisan veneer, see pages 13-15 for details
- veneer drawer fronts in paint available, specify paint color; add \$354 list; see page 16 for details
- on laminate units, contrasting worksurface tops and drawer fronts available, no upcharge; specify laminate color, see page 16 for details
- ledge pulls standard; prism pulls available, specify and see page 9
- oval grommets in back panels can be eliminated upon request, no upcharge
- concealed box drawer(s) available, specify location in unit; add \$246 list for each laminate drawer or \$375 list for each veneer drawer, see page 25 for details
- seat cushion available, see page 25 for more details and page 212 for pricing
- top grommet available, specify location; add \$135 list each; see page 47 for details
- interior wire manager from side to side in upper back, specify and add \$120 list; see page 17 for details

Description	D	W	H	CTN WT	CU FT	① Model	HPL Laminate	Essentials Veneer	Artisan Veneer
Box/Lateral File Storage	22	72	21	267	24	FLT2272-21FM6	\$2,736		
Credenza with Peninsula Desk Mount	22	72	21	267	24	FLV2272-21FM6		\$3,665	\$4,029
	22	72	21	267	24	FLT2272-21F6M	\$2,736		
	22	72	21	267	24	FLV2272-21F6M		\$3,665	\$4,029

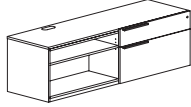

*M6 shown

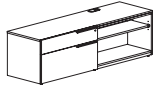

*6M

Features:

- must be used with 33" deep adjustable height modular peninsula desk
- desk lift column can only be mounted in sections with an open compartment, see page 39 for details
- open compartment with adjustable shelf

Options:

- must specify chassis grain direction on artisan veneer, see pages 13-15 for details
- veneer drawer fronts in paint available, specify paint color; add \$354 list; see page 16 for details
- on laminate units, contrasting worksurface tops and drawer fronts available, no upcharge; specify laminate color, see page 16 for details
- ledge pulls standard; prism pulls available, specify and see page 9
- oval grommets in back panels can be eliminated upon request, no upcharge
- concealed box drawer(s) available, specify location in unit; add \$246 list for each laminate drawer or \$375 list for each open compartment, see page 25 for details
- seat cushion available, see page 25 for more details and page 212 for pricing
- top grommet available, specify location; add \$135 list each; see page 47 for details
- interior wire manager from side to side in upper back, specify and add \$120 list; see page 17 for details

Sliding Door Credenza with Peninsula Desk Mount	22	72	21	225	24	FLT2272-21FM9	\$3,020		
	22	72	21	225	24	FLV2272-21FM9		\$4,047	\$4,454
	22	72	21	225	24	FLT2272-21F9M	\$3,020		
	22	72	21	225	24	FLV2272-21F9M		\$4,047	\$4,454

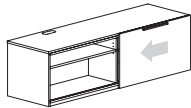

*M9 shown

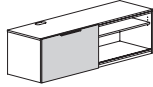

*9M

Features:

- must be used with 33" deep adjustable height modular peninsula desk
- desk lift column can only be mounted in sections with an open compartment, see page 39 for details
- each compartment has one adjustable shelf

Options:

- must specify chassis grain direction on artisan veneer, see pages 13-15 for details
- veneer door fronts in paint available, specify paint color; add \$354 list; see page 16 for details
- on laminate units, contrasting worksurface tops and drawer fronts available, no upcharge; specify laminate color, see page 16 for details
- ledge pulls standard; prism pulls available, specify and see page 9
- oval grommets in back panels can be eliminated upon request, no upcharge
- seat cushion available, see page 25 for more details and page 212 for pricing
- top grommet available, specify location; add \$135 list each; see page 47 for details
- interior wire manager from side to side in upper back, specify and add \$120 list; see page 17 for details

To Order, Specify:

① Laminate Model #	② Laminate Type	③ Laminate Selection	④ Metal Color	⑤ Other Product Options		
Laminate (FLT)	HPL	See Laminate Selection	See Metal Finish Color Options	See list of options for each specific unit; Specify and add accordingly.		
① Veneer Model #	② Wood Collection	③ Wood Finish	④ Metal Color	⑤ Other Product Options		
Veneer (FLV)	Essentials	See Essentials Wood Finish Options	See Metal Finish Color Options	See list of options for each specific unit; Specify and add accordingly.		
	Artisan	<table border="1"> <tr> <th>ⓐ Wood Finish</th> <th>ⓑ Chassis Grain Direction</th> </tr> <tr> <td>See Artisan Wood Finish Options</td> <td>For Artisan Only: Vertical Horizontal</td> </tr> </table>	ⓐ Wood Finish		ⓑ Chassis Grain Direction	See Artisan Wood Finish Options
ⓐ Wood Finish	ⓑ Chassis Grain Direction					
See Artisan Wood Finish Options	For Artisan Only: Vertical Horizontal					

Description	D	W	H	CTN WT	CU FT	① Model	HPL Laminate	Essentials Veneer	Artisan Veneer
Open Compartment Storage	22	96	21	266	32	FLT2296-21FM00	\$2,688		
Credenza with Peninsula	22	96	21	266	32	FLV2296-21FM00		\$3,783	\$4,162
Desk Mount	22	96	21	266	32	FLT2296-21F00M	\$2,688		
	22	96	21	266	32	FLV2296-21F00M		\$3,783	\$4,162

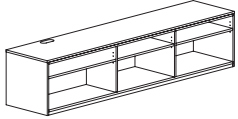

*M00 shown

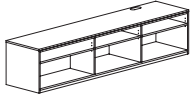

*O0M

Features:

- must be used with 33" deep adjustable height modular peninsula desk
- square edge on top
- each compartment has one adjustable shelf

Options:

- must specify chassis grain direction on artisan veneer, see pages 13-15 for details
- oval grommets in back panels can be eliminated upon request, no upcharge
- seat cushion available, see page 25 for more details and page 212 for pricing
- top grommet available, specify location; add \$135 list each; see page 47 for details
- interior wire manager from side to side in upper back, specify and add \$120 list; see page 17 for details

Open Compartment Storage	22	72	21	204	24	FLT2272-21FM0	\$2,378		
Credenza with Peninsula Desk	22	72	21	204	24	FLV2272-21FM0		\$3,350	\$3,685
Mount	22	72	21	204	24	FLT2272-21F0M	\$2,378		
	22	72	21	204	24	FLV2272-21F0M		\$3,350	\$3,685

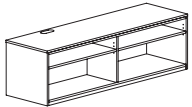

*M0 shown

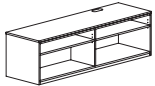

*OM

Features:

- must be used with 33" deep adjustable height modular peninsula desk
- square edge on top
- each compartment has one adjustable shelf

Options:

- must specify chassis grain direction on artisan veneer, see pages 13-15 for details
- oval grommets in back panels can be eliminated upon request, no upcharge
- seat cushion available, see page 25 for more details and page 212 for pricing
- top grommet available, specify location; add \$135 list each; see page 47 for details
- interior wire manager from side to side in upper back, specify and add \$120 list; see page 17 for details

FLUX

Description	D	W	H	CTN WT	CU FT	① Model	HPL Laminate	Essentials Veneer	Artisan Veneer
Open Compartment Storage Pedestal with Peninsula Desk Mount	22	36	21	111	13	FLT2236-21FMR	\$1,815		
	22	36	21	111	13	FLV2236-21FMR		\$2,552	\$2,809
	22	36	21	111	13	FLT2236-21FML	\$1,815		
	22	36	21	111	13	FLV2236-21FML		\$2,552	\$2,809



*MR shown



*ML

Features:

- must be used with 33" deep adjustable height modular peninsula desk
- square edge on top
- open compartment with adjustable shelf

Options:

- must specify chassis grain direction on artisan veneer, see pages 13-15 for details
- oval grommets in back panels can be eliminated upon request, no upcharge
- seat cushion available, see page 25 for more details and page 212 for pricing
- interior wire manager from side to side in upper back, specify and add \$120 list; see page 17 for details

FLUX

To Order, Specify:

① Laminate Model #	② Laminate Type	③ Laminate Selection	④ Metal Color	⑤ Other Product Options	
Laminate (FLT)	HPL	See Laminate Selection	See Metal Finish Color Options	See list of options for each specific unit; Specify and add accordingly.	
① Veneer Model #	② Wood Collection	③ Wood Finish	④ Metal Color	⑤ Other Product Options	
Veneer (FLV)	Essentials	See Essentials Wood Finish Options	See Metal Finish Color Options	See list of options for each specific unit; Specify and add accordingly.	
	Artisan	<table border="1"> <thead> <tr> <th>③a Wood Finish</th> <th>③b Chassis Grain Direction</th> </tr> </thead> <tbody> <tr> <td>See Artisan Wood Finish Options</td> <td>For Artisan Only: Vertical Horizontal</td> </tr> </tbody> </table>			③a Wood Finish
③a Wood Finish	③b Chassis Grain Direction				
See Artisan Wood Finish Options	For Artisan Only: Vertical Horizontal				

Description	D	W	H	CTN WT	CU FT	① Model	HPL Laminate	Essentials Veneer	Artisan Veneer
27" Adjustable Height Modular Peninsula Desk	27½	72	Adj.	182	21	FLT2872PAHD	\$4,502		
	27½	72	Adj.	182	21	FLV2872PAHD		\$5,697	\$6,268
	27½	66	Adj.	176	19	FLT2866PAHD	\$4,476		
	27½	66	Adj.	176	19	FLV2866PAHD		\$5,661	\$6,226
	27½	60	Adj.	170	19	FLT2860PAHD	\$4,449		
	27½	60	Adj.	170	19	FLV2860PAHD		\$5,623	\$6,186

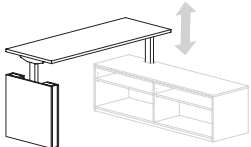
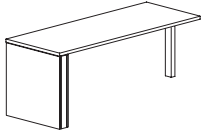

in application

Features:

- must be used with 90", 60" and 30" wide secondary height peninsula mount credenzas
- 29" to 47" height adjustment with digital controller, wire guide and 10' power cord
- maximum weight rating 140 lbs. (evenly distributed load)

Options:

- must specify support panels grain direction on artisan veneer, see pages 13-15 for details
- reverse bevel edge available on approach and user sides, specify; add \$451 list for laminate or \$177 list for veneer; see page 8 for details
- 13½" h modesty panel available, specify; add \$449 list for laminate or \$624 list for veneer; see page 21 for details
- top grommet available, specify location; add \$135 list each; see page 49 for details
- worksurface power available, specify "to accommodate EC26" on your purchase order; EC26 unit must be ordered separately, see page 49

Box/Lateral File Storage Credenza with Peninsula Desk Mount	22	90	21	278	30	FLT2290-21FM60	\$2,976		
	22	90	21	278	30	FLV2290-21FM60		\$3,986	\$4,386
	22	90	21	278	30	FLT2290-21F06M	\$2,976		
	22	90	21	278	30	FLV2290-21F06M		\$3,986	\$4,386

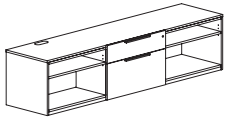

*M60 shown

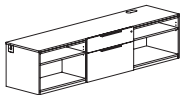

*06M

Features:

- must be used with 27" deep adjustable height modular peninsula desk
- desk lift column can only be mounted in sections with an open compartment, see page 39 for details
- open compartment with adjustable shelf

Options:

- must specify chassis grain direction on artisan veneer, see pages 13-15 for details
- veneer drawer fronts in paint available, specify paint color; add \$354 list; see page 16 for details
- on laminate units, contrasting worksurface tops and drawer fronts available, no upcharge; specify laminate color, see page 16 for details
- ledge pulls standard; prism pulls available, specify and see page 9
- oval grommets in back panels can be eliminated upon request, no upcharge
- concealed box drawer(s) available, specify location in unit; add \$246 list for each laminate drawer or \$375 list for each veneer drawer, see page 25 for details
- seat cushion available, see page 25 for more details and page 212 for pricing
- top grommet available, specify location; add \$135 list each; see page 47 for details
- interior wire manager from side to side in upper back, specify and add \$120 list; see page 17 for details

Description	D	W	H	CTN WT	CU FT	① Model	HPL Laminate	Essentials Veneer	Artisan Veneer
Box/Lateral File Storage	22	90	21	313	30	FLT2290-21FM66	\$3,147		
Credenza with Peninsula Desk Mount	22	90	21	313	30	FLV2290-21FM66		\$4,277	\$4,706
	22	90	21	313	30	FLT2290-21F66M	\$3,147		
	22	90	21	313	30	FLV2290-21F66M		\$4,277	\$4,706

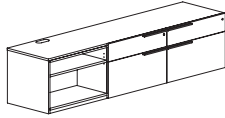

*M66 shown

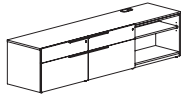

*66M

Features:

- must be used with 27" deep adjustable height modular peninsula desk
- desk lift column can only be mounted in sections with an open compartment, see page 39 for details
- open compartment with adjustable shelf

Options:

- must specify chassis grain direction on artisan veneer, see pages 13-15 for details
- veneer drawer fronts in paint available, specify paint color; add \$354 list; see page 16 for details
- on laminate units, contrasting worksurface tops and drawer fronts available, no upcharge; specify laminate color, see page 16 for details
- ledge pulls standard; prism pulls available, specify and see page 9
- oval grommets in back panels can be eliminated upon request, no upcharge
- concealed box drawer(s) available, specify location in unit; add \$246 list for each laminate drawer or \$375 list for each veneer drawer, see page 25 for details
- seat cushion available, see page 25 for more details and page 212 for pricing
- top grommet available, specify location; add \$135 list each; see page 47 for details
- interior wire manager from side to side in upper back, specify and add \$120 list; see page 17 for details

Box/Lateral File Storage	22	60	21	239	21	FLT2260-21FM6	\$2,579		
Credenza with Peninsula Desk Mount	22	60	21	239	21	FLV2260-21FM6		\$3,456	\$3,801
	22	60	21	239	21	FLT2260-21F6M	\$2,579		
	22	60	21	239	21	FLV2260-21F6M		\$3,456	\$3,801

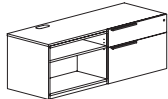

*M6 shown

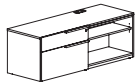

*6M

Features:

- must be used with 27" deep adjustable height modular peninsula desk
- desk lift column can only be mounted in sections with an open compartment, see page 39 for details
- open compartment with adjustable shelf

Options:

- must specify chassis grain direction on artisan veneer, see pages 13-15 for details
- veneer drawer fronts in paint available, specify paint color; add \$354 list; see page 16 for details
- on laminate units, contrasting worksurface tops and drawer fronts available, no upcharge; specify laminate color, see page 16 for details
- ledge pulls standard; prism pulls available, specify and see page 9
- oval grommets in back panels can be eliminated upon request, no upcharge
- concealed box drawer(s) available, specify location in unit; add \$246 list for each laminate drawer or \$375 list for each veneer drawer, see page 25 for details
- seat cushion available, see page 25 for more details and page 212 for pricing
- top grommet available, specify location; add \$135 list each; see page 47 for details
- interior wire manager from side to side in upper back, specify and add \$120 list; see page 17 for details

To Order, Specify:

① Laminate Model #	② Laminate Type	③ Laminate Selection	④ Metal Color	⑤ Other Product Options		
Laminate (FLT)	HPL	See Laminate Selection	See Metal Finish Color Options	See list of options for each specific unit; Specify and add accordingly.		
① Veneer Model #	② Wood Collection	③ Wood Finish	④ Metal Color	⑤ Other Product Options		
Veneer (FLV)	Essentials	See Essentials Wood Finish Options	See Metal Finish Color Options	See list of options for each specific unit; Specify and add accordingly.		
	Artisan	<table border="1"> <thead> <tr> <th>ⓐ Wood Finish</th> <th>ⓑ Chassis Grain Direction</th> </tr> </thead> <tbody> <tr> <td>See Artisan Wood Finish Options</td> <td>For Artisan Only: Vertical Horizontal</td> </tr> </tbody> </table>	ⓐ Wood Finish		ⓑ Chassis Grain Direction	See Artisan Wood Finish Options
ⓐ Wood Finish	ⓑ Chassis Grain Direction					
See Artisan Wood Finish Options	For Artisan Only: Vertical Horizontal					

Description	D	W	H	CTN WT	CU FT	① Model	HPL Laminate	Essentials Veneer	Artisan Veneer
Sliding Door Credenza with Peninsula Desk Mount	22	90	21	276	31	FLT2290-21FM99	\$2,851		
	22	90	21	276	31	FLV2290-21FM99		\$3,819	\$4,202
	22	90	21	276	31	FLT2290-21F99M	\$2,851		
	22	90	21	276	31	FLV2290-21F99M		\$3,819	\$4,202

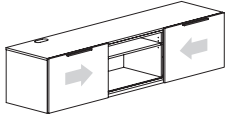

*M99 shown

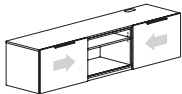
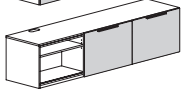
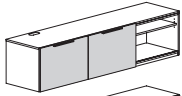

*99M

Features:

- must be used with 27" deep adjustable height modular peninsula desk
- desk lift column can only be mounted in sections with an open compartment, see page 39 for details
- each compartment has one adjustable shelf

Options:

- must specify chassis grain direction on artisan veneer, see pages 13-15 for details
- veneer door fronts in paint available, specify paint color; add \$354 list; see page 16 for details
- on laminate units, contrasting worksurface tops and drawer fronts available, no upcharge; specify laminate color, see page 16 for details
- ledge pulls standard; prism pulls available, specify and see page 9
- oval grommets in back panels can be eliminated upon request, no upcharge
- seat cushion available, see page 25 for more details and page 212 for pricing
- top grommet available, specify location; add \$135 list each; see page 47 for details
- interior wire manager from side to side in upper back, specify and add \$120 list; see page 17 for details

Description	D	W	H	CTN WT	CU FT	① Model	HPL Laminate	Essentials Veneer	Artisan Veneer
Sliding Door Credenza with Peninsula Desk Mount	22	90	21	259	31	FLT2290-21FM90	\$2,742		
	22	90	21	259	31	FLV2290-21FM90		\$3,674	\$4,040
	22	90	21	259	31	FLT2290-21F09M	\$2,742		
	22	90	21	259	31	FLV2290-21F09M		\$3,674	\$4,040

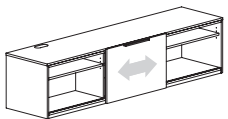

*M90 shown

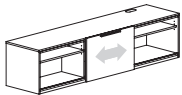
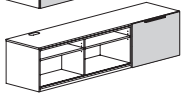
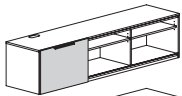

*09M

Features:

- must be used with 27" deep adjustable height modular peninsula desk
- desk lift column can only be mounted in sections with an open compartment, see page 39 for details
- each compartment has one adjustable shelf

Options:

- must specify chassis grain direction on artisan veneer, see pages 13-15 for details
- veneer door fronts in paint available, specify paint color; add \$354 list; see page 16 for details
- on laminate units, contrasting worksurface tops and drawer fronts available, no upcharge; specify laminate color, see page 16 for details
- ledge pulls standard; prism pulls available, specify and see page 9
- oval grommets in back panels can be eliminated upon request, no upcharge
- seat cushion available, see page 25 for more details and page 212 for pricing
- top grommet available, specify location; add \$135 list each; see page 47 for details
- interior wire manager from side to side in upper back, specify and add \$120 list; see page 17 for details

FLUX

Description	D	W	H	CTN WT	CU FT	① Model	HPL Laminate	Essentials Veneer	Artisan Veneer
Sliding Door Credenza with Peninsula Desk Mount	22	60	21	185	21	FLT2260-21FM9	\$2,357		
	22	60	21	185	21	FLV2260-21FM9		\$3,159	\$3,475
	22	60	21	185	21	FLT2260-21F9M	\$2,357		
	22	60	21	185	21	FLV2260-21F9M		\$3,159	\$3,475

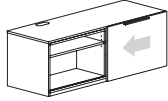

*M9 shown

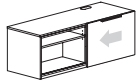
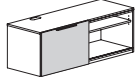

*9M

Features:

- must be used with 27" deep adjustable height modular peninsula desk
- desk lift column can only be mounted in sections with an open compartment, see page 39 for details
- each compartment has one adjustable shelf

Options:

- must specify chassis grain direction on artisan veneer, see pages 13-15 for details
- veneer door fronts in paint available, specify paint color; add \$354 list; see page 16 for details
- on laminate units, contrasting worksurface tops and drawer fronts available, no upcharge; specify laminate color, see page 16 for details
- ledge pulls standard; prism pulls available, specify and see page 9
- oval grommets in back panels can be eliminated upon request, no upcharge
- seat cushion available, see page 25 for more details and page 212 for pricing
- top grommet available, specify location; add \$135 list each; see page 47 for details
- interior wire manager from side to side in upper back, specify and add \$120 list; see page 17 for details

FLUX

To Order, Specify:

① Laminate Model #	② Laminate Type	③ Laminate Selection	④ Metal Color	⑤ Other Product Options		
Laminate (FLT)	HPL	See Laminate Selection	See Metal Finish Color Options	See list of options for each specific unit; Specify and add accordingly.		
① Veneer Model #	② Wood Collection	③ Wood Finish	④ Metal Color	⑤ Other Product Options		
Veneer (FLV)	Essentials	See Essentials Wood Finish Options	See Metal Finish Color Options	See list of options for each specific unit; Specify and add accordingly.		
	Artisan	<table border="1"> <thead> <tr> <th>③a Wood Finish</th> <th>③b Chassis Grain Direction</th> </tr> </thead> <tbody> <tr> <td>See Artisan Wood Finish Options</td> <td>For Artisan Only: Vertical Horizontal</td> </tr> </tbody> </table>	③a Wood Finish		③b Chassis Grain Direction	See Artisan Wood Finish Options
③a Wood Finish	③b Chassis Grain Direction					
See Artisan Wood Finish Options	For Artisan Only: Vertical Horizontal					

Description	D	W	H	CTN WT	CU FT	① Model	HPL Laminate	Essentials Veneer	Artisan Veneer
Open Compartment Storage	22	90	21	238	30	FLT2290-21FM00	\$2,299		
Credenza with Peninsula	22	90	21	238	30	FLV2290-21FM00		\$3,237	\$3,559
Desk Mount	22	90	21	238	30	FLT2290-21F00M	\$2,299		
	22	90	21	238	30	FLV2290-21F00M		\$3,237	\$3,559

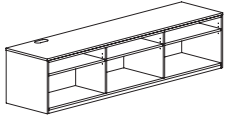

*M00 shown

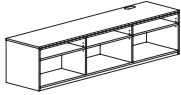

*00M

Features:

- must be used with 27" deep adjustable height modular peninsula desk
- square edge on top
- each compartment has one adjustable shelf

Options:

- must specify chassis grain direction on artisan veneer, see pages 13-15 for details
- oval grommets in back panels can be eliminated upon request, no upcharge
- seat cushion available, see page 25 for more details and page 212 for pricing
- top grommet available, specify location; add \$135 list each; see page 47 for details
- interior wire manager from side to side in upper back, specify and add \$120 list; see page 17 for details

Open Compartment Storage	22	60	21	176	21	FLT2260-21FM0	\$1,979		
Credenza with Peninsula	22	60	21	176	21	FLV2260-21FM0		\$2,783	\$3,060
Desk Mount	22	60	21	176	21	FLT2260-21F0M	\$1,979		
	22	60	21	176	21	FLV2260-21F0M		\$2,783	\$3,060

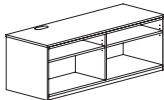

*M0



*0M

Features:

- must be used with 27" deep adjustable height modular peninsula desk
- square edge on top
- each compartment has one adjustable shelf

Options:

- must specify chassis grain direction on artisan veneer, see pages 13-15 for details
- oval grommets in back panels can be eliminated upon request, no upcharge
- seat cushion available, see page 25 for more details and page 212 for pricing
- top grommet available, specify location; add \$135 list each; see page 47 for details
- interior wire manager from side to side in upper back, specify and add \$120 list; see page 17 for details

FLUX

Description	D	W	H	CTN WT	CU FT	① Model	HPL Laminate	Essentials Veneer	Artisan Veneer
Open Compartment Storage	22	30	21	83	11	FLT2230-21FMR	\$1,745		
Pedestal with Peninsula Desk	22	30	21	83	11	FLV2230-21FMR		\$2,451	\$2,698
Mount	22	30	21	83	11	FLT2230-21FML	\$1,745		
	22	30	21	83	11	FLV2230-21FML		\$2,451	\$2,698



*MR shown



*ML

Features:

- must be used with 27" deep adjustable height modular peninsula desk
- square edge on top
- open compartment with adjustable shelf

Options:

- must specify chassis grain direction on artisan veneer, see pages 13-15 for details
- oval grommets in back panels can be eliminated upon request, no upcharge
- interior wire manager from side to side in upper back, specify and add \$120 list; see page 17 for details

FLUX

To Order, Specify:

① Laminate Model #	② Laminate Type	③ Laminate Selection		④ Metal Color	⑤ Other Product Options
Laminate (FLT)	HPL	See Laminate Selection		See Metal Finish Color Options	See list of options for each specific unit; Specify and add accordingly.
① Veneer Model #	② Wood Collection	③ Wood Finish		④ Metal Color	⑤ Other Product Options
Veneer (FLV)	Essentials	See Essentials Wood Finish Options		See Metal Finish Color Options	See list of options for each specific unit; Specify and add accordingly.
		③a Wood Finish	③b Chassis Grain Direction		
	Artisan	See Artisan Wood Finish Options	For Artisan Only: Vertical Horizontal		

Description	D	W	H	CTN WT	CU FT	① Model	HPL Laminate	Essentials Veneer	Artisan Veneer
Square Pneumatic Adjustable Height Table	30	30	Adj.	42	19	FLT3030SAT4B	\$1,983		
	30	30	Adj.	42	19	FLV3030SAT4B		\$2,447	\$2,692
	24	24	Adj.	34	13	FLT2424SAT4B	\$1,943		
	24	24	Adj.	34	13	FLV2424SAT4B		\$2,397	\$2,638



Features:

- ¾" top with flat edge
- 4-star cast aluminum base
- 26" to 38" height adjustment, casters increase heights by 2"
- release lever mounts under edge of top
- 15 lbs. lift force, maximum weight rating 75 lbs. (evenly distributed load)

Options:

- casters available, four locking, specify and add \$103 list

Round Pneumatic Adjustable Height Table	36	36	Adj.	46	27	FLT3636RAT4B	\$2,021		
	36	36	Adj.	46	27	FLV3636RAT4B		\$2,497	\$2,747
	30	30	Adj.	39	19	FLT3030RAT4B	\$1,983		
	30	30	Adj.	39	19	FLV3030RAT4B		\$2,447	\$2,692

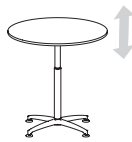

Features:

- ¾" top with flat edge
- 4-star cast aluminum base
- 26" to 38" height adjustment, casters increase heights by 2"
- release lever mounts under edge of top
- 15 lbs. lift force, maximum weight rating 75 lbs. (evenly distributed load)

Options:

- casters available, four locking, specify and add \$103 list

FLUX

Description	D	W	H	CTN WT	CU FT	① Model	HPL Laminate	Essentials Veneer	Artisan Veneer
Oval Pneumatic Adjustable	26	36	Adj.	42	20	FLT26360AT4B	\$2,062		
Height Table	26	36	Adj.	42	20	FLV26360AT4B		\$2,548	\$2,803



Features:

- ¾" top with flat edge
- 4-star cast aluminum base
- 26" to 38" height adjustment, casters increase heights by 2"
- release lever mounts under edge of top
- 15 lbs. lift force, maximum weight rating 75 lbs. (evenly distributed load)



Options:

- casters available, four locking, specify and add \$103 list

FLUX



To Order, Specify:

① Laminate Model #	② Laminate Type	③ Laminate Selection		④ Metal Color	⑤ Other Product Options
Laminate (FLT)	HPL	See Laminate Selection		See Metal Finish Color Options	See list of options for each specific unit; Specify and add accordingly.
① Veneer Model #	② Wood Collection	③ Wood Finish		④ Metal Color	⑤ Other Product Options
Veneer (FLV)	Essentials	See Essentials Wood Finish Options		See Metal Finish Color Options	See list of options for each specific unit; Specify and add accordingly.
	Artisan	<table border="1"> <thead> <tr> <th>③a Wood Finish</th> <th>③b Chassis Grain Direction</th> </tr> </thead> <tbody> <tr> <td>See Artisan Wood Finish Options</td> <td>For Artisan Only: Vertical Horizontal</td> </tr> </tbody> </table>	③a Wood Finish		
③a Wood Finish	③b Chassis Grain Direction				
See Artisan Wood Finish Options	For Artisan Only: Vertical Horizontal				

Description	D	W	H	CTN WT	CU FT	① Model	HPL Laminate	Essentials Veneer	Artisan Veneer
Modular Bow Front Desk Top  	36	84	1 3/16	103	7	FLT3684BMCT	\$1,607		
	36	84	1 3/16	103	7	FLV3684BMCT		\$2,485	\$2,735
	36	78	1 3/16	96	6	FLT3678BMCT	\$1,549		
	36	78	1 3/16	96	6	FLV3678BMCT		\$2,387	\$2,625
	36	72	1 3/16	89	6	FLT3672BMCT	\$1,490		
	36	72	1 3/16	89	6	FLV3672BMCT		\$2,292	\$2,520
	36	66	1 3/16	82	5	FLT3666BMCT	\$1,472		
	36	66	1 3/16	82	5	FLV3666BMCT		\$2,258	\$2,485
	36	60	1 3/16	75	5	FLT3660BMCT	\$1,447		
	36	60	1 3/16	75	5	FLV3660BMCT		\$2,223	\$2,447

Features:

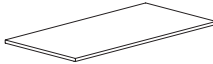
- eased edge profile on approach and user sides

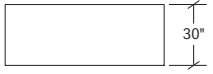
Description	D	W	H	CTN WT	CU FT	① Model	HPL Laminate	Essentials Veneer	Artisan Veneer
Modular Rectangular Desk Top    	36	84	1 3/16	101	7	FLT3684MCT	\$1,188		
	36	84	1 3/16	101	7	FLV3684MCT		\$1,878	\$2,069
	36	78	1 3/16	94	6	FLT3678MCT	\$1,104		
	36	78	1 3/16	94	6	FLV3678MCT		\$1,747	\$1,920
	36	72	1 3/16	87	6	FLT3672MCT	\$1,019		
	36	72	1 3/16	87	6	FLV3672MCT		\$1,612	\$1,775
	36	66	1 3/16	80	5	FLT3666MCT	\$936		
	36	66	1 3/16	80	5	FLV3666MCT		\$1,478	\$1,626
	36	60	1 3/16	73	5	FLT3660MCT	\$851		
	36	60	1 3/16	73	5	FLV3660MCT		\$1,346	\$1,480
	30	84	1 3/16	85	6	FLT3084MCT	\$993		
	30	84	1 3/16	85	6	FLV3084MCT		\$1,567	\$1,722
	30	78	1 3/16	79	5	FLT3078MCT	\$921		
	30	78	1 3/16	79	5	FLV3078MCT		\$1,454	\$1,602
	30	72	1 3/16	73	5	FLT3072MCT	\$851		
	30	72	1 3/16	73	5	FLV3072MCT		\$1,346	\$1,480
	30	66	1 3/16	68	5	FLT3066MCT	\$780		
	30	66	1 3/16	68	5	FLV3066MCT		\$1,233	\$1,357
	30	60	1 3/16	62	4	FLT3060MCT	\$709		
	30	60	1 3/16	62	4	FLV3060MCT		\$1,122	\$1,234

· eased edge profile on approach and user sides

FLUX

To Order, Specify:

① Laminate Model #	② Laminate Type	③ Laminate Selection	④ Metal Color	⑤ Other Product Options	
Laminate (FLT)	HPL	See Laminate Selection	See Metal Finish Color Options	See list of options for each specific unit; Specify and add accordingly.	
① Veneer Model #	② Wood Collection	③ Wood Finish	④ Metal Color	⑤ Other Product Options	
Veneer (FLV)	Essentials	See Essentials Wood Finish Options	See Metal Finish Color Options	See list of options for each specific unit; Specify and add accordingly.	
	Artisan	<table border="1"> <thead> <tr> <th>③a Wood Finish</th> <th>③b Chassis Grain Direction</th> </tr> </thead> <tbody> <tr> <td>See Artisan Wood Finish Options</td> <td>For Artisan Only: Vertical Horizontal</td> </tr> </tbody> </table>			③a Wood Finish
③a Wood Finish	③b Chassis Grain Direction				
See Artisan Wood Finish Options	For Artisan Only: Vertical Horizontal				

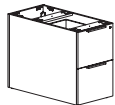
Description	D	W	H	CTN WT	CU FT	① Model	HPL Laminate	Essentials Veneer	Artisan Veneer
	36	18	28	110	14	FLT3618-29FM2	\$1,247		
	36	18	28	110	14	FLV3618-29FM2		\$1,874	\$2,060
	36	15%	28	100	12	FLT3616-29FM2	\$1,228		
	36	15%	28	100	12	FLV3616-29FM2		\$1,845	\$2,030
	30	18	28	97	12	FLT3018-29FM2	\$1,212		
	30	18	28	97	12	FLV3018-29FM2		\$1,820	\$2,002
	30	15%	28	90	10	FLT3016-29FM2	\$1,192		
	30	15%	28	90	10	FLV3016-29FM2		\$1,792	\$1,971

Features:

- use with other modular components, requires a modular top, see page 39
- pedestal front locking

Options:

- must specify chassis grain direction on artisan veneer, see pages 13-15 for details
- veneer drawer fronts in paint available, specify paint color and add \$354 list; see page 16 for details
- on laminate units, contrasting fronts available, no upcharge; specify color, see page 16 for details
- ledge pulls standard; prism pulls available, specify and see page 9

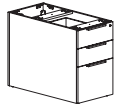
Description	D	W	H	CTN WT	CU FT	① Model	HPL Laminate	Essentials Veneer	Artisan Veneer
	36	18	28	114	14	FLT3618-29FM1	\$1,253		
	36	18	28	114	14	FLV3618-29FM1		\$1,883	\$2,071
	36	15%	28	104	12	FLT3616-29FM1	\$1,235		
	36	15%	28	104	12	FLV3616-29FM1		\$1,855	\$2,040
	30	18	28	102	12	FLT3018-29FM1	\$1,217		
	30	18	28	102	12	FLV3018-29FM1		\$1,827	\$2,011
	30	15%	28	95	10	FLT3016-29FM1	\$1,199		
	30	15%	28	95	10	FLV3016-29FM1		\$1,800	\$1,981

Features:

- use with other modular components, requires a modular top, see page 39
- pedestal front locking

Options:

- must specify chassis grain direction on artisan veneer, see pages 13-15 for details
- veneer drawer fronts in paint available, specify paint color and add \$354 list; see page 16 for details
- on laminate units, contrasting fronts available, no upcharge; specify color, see page 16 for details
- ledge pulls standard; prism pulls available, specify and see page 9

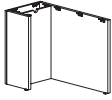

Description	D	W	H	CTN WT	CU FT	① Model	HPL Laminate	Essentials Veneer	Artisan Veneer
 left shown  right	36	18	28	74	14	FLT3618WEAR	\$915		
	36	18	28	74	14	FLV3618WEAR		\$1,372	\$1,510
	36	18	28	74	14	FLT3618WEAL	\$915		
	36	18	28	74	14	FLV3618WEAL		\$1,372	\$1,510
	36	15 3/8	28	71	12	FLT3616WEAR	\$900		
	36	15 3/8	28	71	12	FLV3616WEAR		\$1,355	\$1,488
	36	15 3/8	28	71	12	FLT3616WEAL	\$900		
	36	15 3/8	28	71	12	FLV3616WEAL		\$1,355	\$1,488

Features:

- use with other modular components, requires a modular top, see page 39

Options:

- must specify chassis grain direction on artisan veneer, see pages 13-15 for details

Description	D	W	H	CTN WT	CU FT	① Model	HPL Laminate	Essentials Veneer	Artisan Veneer
 left shown  right	30	18	28	68	12	FLT3018WEAR	\$897		
	30	18	28	68	12	FLV3018WEAR		\$1,348	\$1,482
	30	18	28	68	12	FLT3018WEAL	\$897		
	30	18	28	68	12	FLV3018WEAL		\$1,348	\$1,482
	30	15 3/8	28	65	10	FLT3016WEAR	\$884		
	30	15 3/8	28	65	10	FLV3016WEAR		\$1,325	\$1,460
	30	15 3/8	28	65	10	FLT3016WEAL	\$884		
	30	15 3/8	28	65	10	FLV3016WEAL		\$1,325	\$1,460

Features:

- use with other modular components, requires a modular top, see page 39

Options:

- must specify chassis grain direction on artisan veneer, see pages 13-15 for details

To Order, Specify:

① Laminate Model #	② Laminate Type	③ Laminate Selection	④ Metal Color	⑤ Other Product Options
Laminate (FLT)	HPL	See Laminate Selection	See Metal Finish Color Options	See list of options for each specific unit; Specify and add accordingly.
① Veneer Model #	② Wood Collection	③ Wood Finish	④ Metal Color	⑤ Other Product Options
Veneer (FLV)	Essentials	See Essentials Wood Finish Options	See Metal Finish Color Options	See list of options for each specific unit; Specify and add accordingly.
	Artisan	ⓐ Wood Finish See Artisan Wood Finish Options	ⓑ Chassis Grain Direction For Artisan Only: Vertical Horizontal	

Description	D	W	H	CTN WT	CU FT	① Model	HPL Laminate	Essentials Veneer	Artisan Veneer
	7/8	48	28	34	3	FLT2848MDA	\$426		
	7/8	48	28	34	3	FLV2848MDA		\$636	\$700
	7/8	42	28	31	3	FLT2842MDA	\$369		
	7/8	42	28	31	3	FLV2842MDA		\$551	\$607
	7/8	36	28	27	2	FLT2836MDA	\$342		
	7/8	36	28	27	2	FLV2836MDA		\$511	\$563
	7/8	40 3/4	28	30	3	FLT2841MDA	\$364		
	7/8	40 3/4	28	30	3	FLV2841MDA		\$542	\$596
	7/8	34 3/4	28	27	2	FLT2835MDA	\$332		
	7/8	34 3/4	28	27	2	FLV2835MDA		\$496	\$546
	7/8	27 3/4	28	23	2	FLT2829MDA	\$331		
	7/8	27 3/4	28	23	2	FLV2829MDA		\$485	\$531

Features:

- use with other modular components, requires a modular top, see page 39

Options:

- must specify chassis grain direction on artisan veneer, see pages 13-15 for details

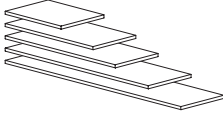
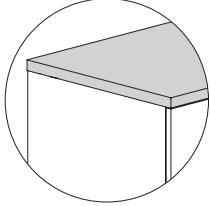
Description	D	W	H	CTN WT	CU FT	① Model	HPL Laminate	Essentials Veneer	Artisan Veneer
Modular Credenza Top for Primary Height  	22	108	1 3/16	80	5	FLT22108MCT	\$936		
	22	108	1 3/16	80	5	FLV22108MCT		\$1,478	\$1,626
	22	102	1 3/16	76	5	FLT22102MCT	\$884		
	22	102	1 3/16	76	5	FLV22102MCT		\$1,396	\$1,537
	22	96	1 3/16	72	5	FLT2296MCT	\$833		
	22	96	1 3/16	72	5	FLV2296MCT		\$1,314	\$1,444
	22	90	1 3/16	68	5	FLT2290MCT	\$780		
	22	90	1 3/16	68	5	FLV2290MCT		\$1,233	\$1,357
	22	84	1 3/16	64	4	FLT2284MCT	\$727		
	22	84	1 3/16	64	4	FLV2284MCT		\$1,150	\$1,266
	22	78	1 3/16	59	4	FLT2278MCT	\$678		
	22	78	1 3/16	59	4	FLV2278MCT		\$1,069	\$1,176
	22	72	1 3/16	55	4	FLT2272MCT	\$625		
	22	72	1 3/16	55	4	FLV2272MCT		\$984	\$1,086
	22	66	1 3/16	51	4	FLT2266MCT	\$573		
	22	66	1 3/16	51	4	FLV2266MCT		\$905	\$996
	22	60	1 3/16	47	3	FLT2260MCT	\$521		
	22	60	1 3/16	47	3	FLV2260MCT		\$823	\$905
	22	54	1 3/16	43	3	FLT2254MCT	\$471		
	22	54	1 3/16	43	3	FLV2254MCT		\$743	\$816
	22	48	1 3/16	39	3	FLT2248MCT	\$418		
	22	48	1 3/16	39	3	FLV2248MCT		\$659	\$724
	22	42	1 3/16	35	2	FLT2242MCT	\$367		
	22	42	1 3/16	35	2	FLV2242MCT		\$578	\$636
	22	36	1 3/16	30	2	FLT2236MCT	\$314		
	22	36	1 3/16	30	2	FLV2236MCT		\$495	\$545
	22	30	1 3/16	26	2	FLT2230MCT	\$262		
	22	30	1 3/16	26	2	FLV2230MCT		\$413	\$454
	22	18	1 3/16	15	1	FLT2218MCT	\$235		
	22	18	1 3/16	15	1	FLV2218MCT		\$340	\$374

Features:

- use with primary height modular components
- eased edge profile user side

To Order, Specify:

① Laminate Model #	② Laminate Type	③ Laminate Selection	④ Metal Color	⑤ Other Product Options		
Laminate (FLT)	HPL	See Laminate Selection	See Metal Finish Color Options	See list of options for each specific unit; Specify and add accordingly.		
① Veneer Model #	② Wood Collection	③ Wood Finish	④ Metal Color	⑤ Other Product Options		
Veneer (FLV)	Essentials	See Essentials Wood Finish Options	See Metal Finish Color Options	See list of options for each specific unit; Specify and add accordingly.		
	Artisan	<table border="1"> <thead> <tr> <th>ⓐ Wood Finish</th> <th>ⓑ Chassis Grain Direction</th> </tr> </thead> <tbody> <tr> <td>See Artisan Wood Finish Options</td> <td>For Artisan Only: Vertical Horizontal</td> </tr> </tbody> </table>	ⓐ Wood Finish		ⓑ Chassis Grain Direction	See Artisan Wood Finish Options
ⓐ Wood Finish	ⓑ Chassis Grain Direction					
See Artisan Wood Finish Options	For Artisan Only: Vertical Horizontal					

Description	D	W	H	CTN WT	CU FT	① Model	HPL Laminate	Essentials Veneer	Artisan Veneer
Modular Return Top for Primary Height (short grain)	22	60	1 3/16	47	3	FLT6022MRT	\$543		
	22	60	1 3/16	47	3	FLV6022MRT		\$844	\$928
	22	54	1 3/16	43	3	FLT5422MRT	\$493		
	22	54	1 3/16	43	3	FLV5422MRT		\$764	\$837
	22	48	1 3/16	39	3	FLT4822MRT	\$441		
	22	48	1 3/16	39	3	FLV4822MRT		\$681	\$747
	22	42	1 3/16	32	4	FLT4222MRT	\$395		
	22	42	1 3/16	32	4	FLV4222MRT		\$608	\$670
	22	36	1 3/16	29	4	FLT3622MRT	\$356		
	22	36	1 3/16	29	4	FLV3622MRT		\$551	\$603

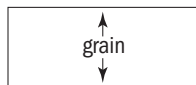
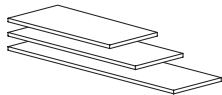

Features:

- use with primary height modular components
- eased edge profile user side
- grain patterns runs short
- mounting brackets included

Modular File/File Credenza Pedestal	22	18	28	87	9	FLT2218-29FM2	\$1,173		
	22	18	28	87	9	FLV2218-29FM2		\$1,759	\$1,938
	22	15 1/2	28	80	8	FLT2216-29FM2	\$1,160		
	22	15 1/2	28	80	8	FLV2216-29FM2		\$1,741	\$1,915



Features:

- use with other modular components, requires a modular top, see page 39
- pedestal front locking

Options:

- must specify chassis grain direction on artisan veneer, see pages 13-15 for details
- veneer drawer fronts in paint available, specify paint color and add \$354 list; see page 16 for details
- on laminate units, contrasting fronts available, no upcharge; specify color, see page 16 for details
- ledge pulls standard; prism pulls available, specify and see page 9

Modular Box/Box/File Credenza Pedestal	22	18	28	89	9	FLT2218-29FM1	\$1,179		
	22	18	28	89	9	FLV2218-29FM1		\$1,770	\$1,947
	22	15 1/2	28	82	8	FLT2216-29FM1	\$1,165		
	22	15 1/2	28	82	8	FLV2216-29FM1		\$1,749	\$1,922



Features:

- use with other modular components, requires a modular top, see page 39
- pedestal front locking

Options:

- must specify chassis grain direction on artisan veneer, see pages 13-15 for details
- veneer drawer fronts in paint available, specify paint color and add \$354 list; see page 16 for details
- on laminate units, contrasting fronts available, no upcharge; specify color, see page 16 for details
- ledge pulls standard; prism pulls available, specify and see page 9

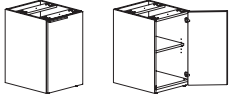
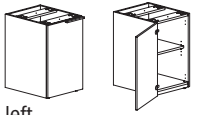
Description	D	W	H	CTN WT	CU FT	① Model	HPL Laminate	Essentials Veneer	Artisan Veneer
Modular Hinge Door Storage Pedestal  right shown  left	22	18	28	74	9	FLT2218-29FM7R	\$725		
	22	18	28	74	9	FLV2218-29FM7R		\$1,090	\$1,199
	22	18	28	74	9	FLT2218-29FM7L	\$725		
	22	18	28	74	9	FLV2218-29FM7L		\$1,090	\$1,199
	22	15 3/8	28	68	8	FLT2216-29FM7R	\$713		
	22	15 3/8	28	68	8	FLV2216-29FM7R		\$1,069	\$1,176
	22	15 3/8	28	68	8	FLT2216-29FM7L	\$713		
	22	15 3/8	28	68	8	FLV2216-29FM7L		\$1,069	\$1,176

Features:

- use with other modular components, requires a modular top, see page 39
- hinged door compartment has one adjustable shelf

Options:

- must specify chassis grain direction on artisan veneer, see pages 13-15 for details
- locking doors available, specify and add \$147 list
- veneer door fronts in paint available, specify paint color and add \$354 list; see page 16 for details
- on laminate units, contrasting fronts available, no upcharge; specify color, see page 16 for details
- ledge pulls standard; prism pulls available, specify and see page 9
- pull out trash can available, specify, add \$479 list; see page 38 for details

Modular Open Compartment	22	18	28	66	13	FLT2218-29FM0	\$661		
	22	18	28	66	13	FLV2218-29FM0		\$993	\$1,092



Features:

- use with other modular components, requires a modular top, see page 39
- compartment has one adjustable shelf

Options:

- must specify chassis grain direction on artisan veneer, see pages 13-15 for details

To Order, Specify:

① Laminate Model #	② Laminate Type	③ Laminate Selection	④ Metal Color	⑤ Other Product Options		
Laminate (FLT)	HPL	See Laminate Selection	See Metal Finish Color Options	See list of options for each specific unit; Specify and add accordingly.		
① Veneer Model #	② Wood Collection	③ Wood Finish	④ Metal Color	⑤ Other Product Options		
Veneer (FLV)	Essentials	See Essentials Wood Finish Options	See Metal Finish Color Options	See list of options for each specific unit; Specify and add accordingly.		
	Artisan	<table border="1"> <thead> <tr> <th>ⓐ Wood Finish</th> <th>ⓑ Chassis Grain Direction</th> </tr> </thead> <tbody> <tr> <td>See Artisan Wood Finish Options</td> <td>For Artisan Only: Vertical Horizontal</td> </tr> </tbody> </table>	ⓐ Wood Finish		ⓑ Chassis Grain Direction	See Artisan Wood Finish Options
ⓐ Wood Finish	ⓑ Chassis Grain Direction					
See Artisan Wood Finish Options	For Artisan Only: Vertical Horizontal					

Description	D	W	H	CTN WT	CU FT	① Model	HPL Laminate	Essentials Veneer	Artisan Veneer
Modular Lateral Credenza Pedestal	22	36	28	141	16	FLT2236-29FM4	\$1,426		
	22	36	28	141	16	FLV2236-29FM4		\$2,138	\$2,352
	22	30	28	128	14	FLT2230-29FM4	\$1,390		
	22	30	28	128	14	FLV2230-29FM4		\$2,085	\$2,296

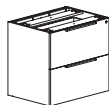

Features:

- use with other modular components, requires a modular top, see page 39
- pedestal front locking

Options:

- must specify chassis grain direction on artisan veneer, see pages 13-15 for details
- veneer drawer fronts in paint available, specify paint color and add \$354 list; see page 16 for details
- on laminate units, contrasting fronts available, no upcharge; specify color, see page 16 for details
- ledge pulls standard; prism pulls available, specify and see page 9

Modular Lateral Credenza Pedestal	22	36	28	141	16	FLT2236-29FM3	\$1,433		
	22	36	28	141	16	FLV2236-29FM3		\$2,150	\$2,365
	22	30	28	129	14	FLT2230-29FM3	\$1,396		
	22	30	28	129	14	FLV2230-29FM3		\$2,096	\$2,307

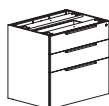

Features:

- use with other modular components, requires a modular top, see page 39
- pedestal front locking

Options:

- must specify chassis grain direction on artisan veneer, see pages 13-15 for details
- veneer drawer fronts in paint available, specify paint color and add \$354 list; see page 16 for details
- on laminate units, contrasting fronts available, no upcharge; specify color, see page 16 for details
- ledge pulls standard; prism pulls available, specify and see page 9

Modular Credenza Multi-File Pedestal	22	30	28	138	14	FLT2230-29FMRM	\$1,510		
	22	30	28	138	14	FLV2230-29FMRM		\$2,268	\$2,495
	22	30	28	138	14	FLT2230-29FMLM	\$1,510		
	22	30	28	138	14	FLV2230-29FMLM		\$2,268	\$2,495



right shown

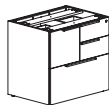

left

Features:

- use with other modular components, requires a modular top, see page 39
- pedestal front locking

Options:

- must specify chassis grain direction on artisan veneer, see pages 13-15 for details
- veneer drawer fronts in paint available, specify paint color and add \$354 list; see page 16 for details
- on laminate units, contrasting fronts available, no upcharge; specify color, see page 16 for details
- ledge pulls standard; prism pulls available, specify and see page 9

Modular Hinge Door Credenza Pedestal	22	36	28	122	16	FLT2236-29FM7	\$1,209		
	22	36	28	122	16	FLV2236-29FM7		\$1,815	\$1,993
	22	30	28	108	14	FLT2230-29FM7	\$1,160		
	22	30	28	108	14	FLV2230-29FM7		\$1,742	\$1,916

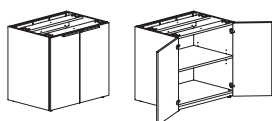

Features:

- use with other modular components, requires a modular top, see page 39
- hinged door compartment has one adjustable shelf

Options:

- must specify chassis grain direction on artisan veneer, see pages 13-15 for details
- locking doors available, specify and add \$147 list
- veneer door fronts in paint available, specify paint color and add \$354 list; see page 16 for details
- on laminate units, contrasting laminate door fronts available, no upcharge; specify laminate color, see page 16 for details
- ledge pulls standard; prism pulls available, specify and see page 9

Description	D	W	H	CTN WT	CU FT	① Model	HPL Laminate	Essentials Veneer	Artisan Veneer
Modular Hinge Door with Open Shelf Credenza Pedestal	22	36	28	132	16	FLT2236-29FM8	\$1,227		
	22	36	28	132	16	FLV2236-29FM8		\$1,841	\$2,027
	22	30	28	116	14	FLT2230-29FM8	\$1,180		
	22	30	28	116	14	FLV2230-29FM8		\$1,773	\$1,949

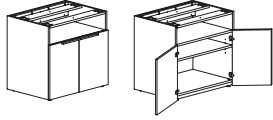

Features:

- use with other modular components, requires a modular top, see page 39
- hinged door compartment has one adjustable shelf

Options:

- must specify chassis grain direction on artisan veneer, see pages 13-15 for details
- locking doors available, specify and add \$147 list
- veneer door fronts in paint available, specify paint color and add \$354 list; see page 16 for details
- on laminate units, contrasting laminate door fronts available, no upcharge; specify laminate color, see page 16 for details
- ledge pulls standard; prism pulls available, specify and see page 9

Modular Open Compartment	D	W	H	CTN WT	CU FT	Model	HPL Laminate	Essentials Veneer	Artisan Veneer
Modular Open Compartment	22	36	28	101	16	FLT2236-29FM0	\$1,070		
	22	36	28	101	16	FLV2236-29FM0		\$1,607	\$1,769
	22	30	28	91	14	FLT2230-29FM0	\$1,045		
	22	30	28	91	14	FLV2230-29FM0		\$1,568	\$1,725



Features:

- use with other modular components, requires a modular top, see page 39
- compartment has one adjustable shelf

Options:

- must specify chassis grain direction on artisan veneer, see pages 13-15 for details

To Order, Specify:

① Laminate Model #	② Laminate Type	③ Laminate Selection	④ Metal Color	⑤ Other Product Options		
Laminate (FLT)	HPL	See Laminate Selection	See Metal Finish Color Options	See list of options for each specific unit; Specify and add accordingly.		
① Veneer Model #	② Wood Collection	③ Wood Finish	④ Metal Color	⑤ Other Product Options		
Veneer (FLV)	Essentials	See Essentials Wood Finish Options	See Metal Finish Color Options	See list of options for each specific unit; Specify and add accordingly.		
	Artisan	<table border="1"> <thead> <tr> <th>ⓐ Wood Finish</th> <th>ⓑ Chassis Grain Direction</th> </tr> </thead> <tbody> <tr> <td>See Artisan Wood Finish Options</td> <td>For Artisan Only: Vertical Horizontal</td> </tr> </tbody> </table>	ⓐ Wood Finish		ⓑ Chassis Grain Direction	See Artisan Wood Finish Options
ⓐ Wood Finish	ⓑ Chassis Grain Direction					
See Artisan Wood Finish Options	For Artisan Only: Vertical Horizontal					

Description	D	W	H	CTN WT	CU FT	① Model	HPL Laminate	Essentials Veneer	Artisan Veneer
Modular Box/File Pedestal - Primary Height	22	18	28	85	9	FLT2218-29LM5	\$1,843		
	22	18	28	85	9	FLV2218-29LM5		\$2,392	\$2,632



Features:

- must be connected to another unit with a common top, this unit is not freestanding
- pedestal front locking

Options:

- must specify chassis grain direction on artisan veneer, see pages 13-15 for details
- veneer drawer fronts in paint available, specify paint color and add \$354 list; see page 16 for details
- on laminate units, contrasting fronts available, no upcharge; specify color, see page 16 for details
- ledge pulls standard; prism pulls available, specify and see page 9

Modular Single Door Storage Pedestal - Primary Height	22	18	28	72	9	FLT2218-29LM7R	\$1,654		
	22	18	28	72	9	FLV2218-29LM7R		\$2,146	\$2,360
	22	18	28	72	9	FLT2218-29LM7L	\$1,654		
	22	18	28	72	9	FLV2218-29LM7L		\$2,146	\$2,360



right shown

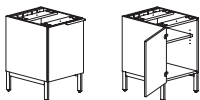

left

Features:

- must be connected to another unit with a common top, this unit is not freestanding

Options:

- must specify chassis grain direction on artisan veneer, see pages 13-15 for details
- locking door available, specify and add \$147 list
- veneer door fronts in paint available, specify paint color and add \$354 list; see page 16 for details
- on laminate units, contrasting laminate door fronts available, no upcharge; specify laminate color, see page 16 for details
- ledge pulls standard; prism pulls available, specify and see page 9

Modular Open Compartment - Primary Height	22	18	28	66	13	FLT2218-29LM0	\$1,589		
	22	18	28	66	13	FLV2218-29LM0		\$2,048	\$2,253



Features:

- use with other modular components, requires a modular top, see page 39
- open compartment with adjustable shelf

Options:

- must specify chassis grain direction on artisan veneer, see pages 13-15 for details

Modular Box/Lateral File - Primary Height	22	36	28	129	16	FLT2236-29LM6	\$2,146		
	22	36	28	129	16	FLV2236-29LM6		\$2,784	\$3,063
	22	30	28	125	14	FLT2230-29LM6	\$2,083		
	22	30	28	125	14	FLV2230-29LM6		\$2,702	\$2,974



Features:

- must be connected to another unit with a common top, this unit is not freestanding
- pedestal front locking

Options:

- must specify chassis grain direction on artisan veneer, see pages 13-15 for details
- veneer drawer fronts in paint available, specify paint color and add \$354 list; see page 16 for details
- on laminate units, contrasting fronts available, no upcharge; specify color, see page 16 for details
- ledge pulls standard; prism pulls available, specify and see page 9

Modular Hidden Drawer Pedestal - Primary Height	22	36	28	131	16	FLT2236-29LMB	\$2,394		
	22	36	28	131	16	FLV2236-29LMB		\$3,106	\$3,419
	22	30	28	121	14	FLT2230-29LMB	\$2,333		
	22	30	28	121	14	FLV2230-29LMB		\$3,026	\$3,330



Features:

- must be connected to another unit with a common top, this unit is not freestanding
- pedestal front locking
- concealed box drawer

Options:

- must specify chassis grain direction on artisan veneer, see pages 13-15 for details
- veneer drawer fronts in paint available, specify paint color and add \$354 list; see page 16 for details
- on laminate units, contrasting fronts available, no upcharge; specify color, see page 16 for details
- ledge pulls standard; prism pulls available, specify and see page 9

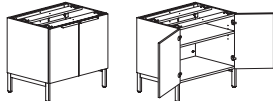
Description	D	W	H	CTN WT	CU FT	① Model	HPL Laminate	Essentials Veneer	Artisan Veneer
	22	36	28	114	16	FLT2236-29LM7	\$1,863		
	22	36	28	114	16	FLV2236-29LM7		\$2,419	\$2,658
	22	30	28	103	14	FLT2230-29LM7	\$1,819		
	22	30	28	103	14	FLV2230-29LM7		\$2,357	\$2,594

Features:

- use with other modular components, requires a modular top, see page 39
- hinged door compartment has one adjustable shelf

Options:

- must specify chassis grain direction on artisan veneer, see pages 13-15 for details
- locking doors available, specify and add \$147 list
- veneer door fronts in paint available, specify paint color and add \$354 list; see page 16 for details
- on laminate units, contrasting laminate door fronts available, no upcharge; specify laminate color, see page 16 for details
- ledge pulls standard; prism pulls available, specify and see page 9

	22	36	28	109	16	FLT2236-29LM8	\$1,886		
	22	36	28	109	16	FLV2236-29LM8		\$2,448	\$2,694
	22	30	28	99	14	FLT2230-29LM8	\$1,840		
	22	30	28	99	14	FLV2230-29LM8		\$2,388	\$2,627

Features:

- must be connected to another unit with a common top, this unit is not freestanding
- hinged door compartment has one adjustable shelf

Options:

- must specify chassis grain direction on artisan veneer, see pages 13-15 for details
- locking doors available, specify and add \$147 list
- veneer door fronts in paint available, specify paint color and add \$354 list; see page 16 for details
- on laminate units, contrasting laminate door fronts available, no upcharge; specify laminate color, see page 16 for details
- ledge pulls standard; prism pulls available, specify and see page 9

	22	36	28	99	16	FLT2236-29LM0	\$1,713		
	22	36	28	99	16	FLV2236-29LM0		\$2,223	\$2,447
	22	30	28	91	14	FLT2230-29LM0	\$1,672		
	22	30	28	91	14	FLV2230-29LM0		\$2,171	\$2,388

Features:

- use with other modular components, requires a modular top, see page 39
- open compartment with adjustable shelf

Options:

- must specify chassis grain direction on artisan veneer, see pages 13-15 for details

To Order, Specify:

① Laminate Model #	② Laminate Type	③ Laminate Selection	④ Metal Color	⑤ Other Product Options
Laminate (FLT)	HPL	See Laminate Selection	See Metal Finish Color Options	See list of options for each specific unit; Specify and add accordingly.
① Veneer Model #	② Wood Collection	③ Wood Finish	④ Metal Color	⑤ Other Product Options
Veneer (FLV)	Essentials	See Essentials Wood Finish Options	See Metal Finish Color Options	See list of options for each specific unit; Specify and add accordingly.
	Artisan	ⓐ Wood Finish See Artisan Wood Finish Options	ⓑ Chassis Grain Direction For Artisan Only: Vertical Horizontal	

Description	D	W	H	CTN WT	CU FT	① Model	HPL Laminate	Essentials Veneer	Artisan Veneer
Modular Credenza Wing End Support for Primary Height Units	22	18	28	43	9	FLT2218WEAR	\$625		
	22	18	28	43	9	FLV2218WEAR		\$936	\$1,028
	22	18	28	43	9	FLT2218WEAL	\$625		
	22	18	28	43	9	FLV2218WEAL		\$936	\$1,028
	22	15 $\frac{5}{8}$	28	40	8	FLT2216WEAR	\$615		
	22	15 $\frac{5}{8}$	28	40	8	FLV2216WEAR		\$923	\$1,016
	22	15 $\frac{5}{8}$	28	40	8	FLT2216WEAL	\$615		
	22	15 $\frac{5}{8}$	28	40	8	FLV2216WEAL		\$923	\$1,016



right shown



left

Features:

- use with other modular components, requires a modular top, see page 39

Options:

- must specify chassis grain direction on artisan veneer, see pages 13-15 for details

Description	D	W	H	CTN WT	CU FT	① Model	HPL Laminate	Essentials Veneer	Artisan Veneer
Modular Desk T-Support for Primary Height Units	33 $\frac{1}{4}$	11 $\frac{3}{16}$	28	48	9	FLT3428-MDTS	\$814		
	33 $\frac{1}{4}$	11 $\frac{3}{16}$	28	48	9	FLV3428-MDTS		\$1,058	\$1,161
	27 $\frac{1}{4}$	11 $\frac{3}{16}$	28	41	7	FLT2828-MDTS	\$706		
	27 $\frac{1}{4}$	11 $\frac{3}{16}$	28	41	7	FLV2828-MDTS		\$917	\$1,007
	21 $\frac{3}{4}$	11 $\frac{3}{16}$	28	31	6	FLT2228-MDTS	\$679		
	21 $\frac{3}{4}$	11 $\frac{3}{16}$	28	31	6	FLV2228-MDTS		\$880	\$971

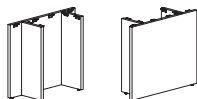

Features:

- use with other modular components, requires a modular top, see page 39

Options:

- must specify chassis grain direction on artisan veneer, see pages 13-15 for details

Description	D	W	H	CTN WT	CU FT	① Model	HPL Laminate	Essentials Veneer	Artisan Veneer
Modular Desk T-Support for Secondary Height Units	33 $\frac{1}{4}$	11 $\frac{3}{16}$	6 $\frac{3}{16}$	19	3	FLT3407-MDTS	\$590		
	33 $\frac{1}{4}$	11 $\frac{3}{16}$	6 $\frac{3}{16}$	19	3	FLV3407-MDTS		\$764	\$840
	27 $\frac{1}{4}$	11 $\frac{3}{16}$	6 $\frac{3}{16}$	16	2	FLT2807-MDTS	\$565		
	27 $\frac{1}{4}$	11 $\frac{3}{16}$	6 $\frac{3}{16}$	16	2	FLV2807-MDTS		\$737	\$809
	21 $\frac{3}{4}$	11 $\frac{3}{16}$	6 $\frac{3}{16}$	12	2	FLT2207-MDTS	\$545		
	21 $\frac{3}{4}$	11 $\frac{3}{16}$	6 $\frac{3}{16}$	12	2	FLV2207-MDTS		\$708	\$779



Features:

- use with other modular components, requires a modular top, see page 39

Options:

- must specify chassis grain direction on artisan veneer, see pages 13-15 for details

Description	D	W	H	CTN WT	CU FT	① Model	HPL Laminate	Essentials Veneer	Artisan Veneer
Modular Credenza Full Modesty Panel for Primary Height Modular Units	¾	47 7/8	28	35	3	FLT2848MCFA	\$426		
	¾	47 7/8	28	35	3	FLV2848MCFA		\$636	\$700
	¾	41 7/8	28	32	3	FLT2842MCFA	\$369		
	¾	41 7/8	28	32	3	FLV2842MCFA		\$551	\$607
	¾	35 7/8	28	28	2	FLT2836MCFA	\$342		
	¾	35 7/8	28	28	2	FLV2836MCFA		\$511	\$563
	¾	29 7/8	28	24	2	FLT2830MCFA	\$315		
	¾	29 7/8	28	24	2	FLV2830MCFA		\$472	\$519
	¾	23 7/8	28	20	2	FLT2824MCFA	\$308		
	¾	23 7/8	28	20	2	FLV2824MCFA		\$458	\$506
	¾	17 7/8	28	18	2	FLT2818MCFA	\$305		
	¾	17 7/8	28	18	2	FLV2818MCFA		\$454	\$499

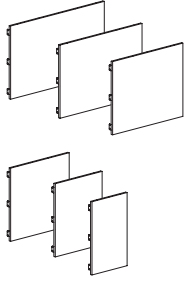

Features:

- use with other modular components, requires a modular top, see page 39

Options:

- must specify chassis grain direction on artisan veneer, see pages 13-15 for details

Description	D	W	H	CTN WT	CU FT	① Model	HPL Laminate	Essentials Veneer	Artisan Veneer
Modular Credenza Partial Modesty Panel for Primary Height Modular Units	¾	47 7/8	12	21	2	FLT2848MCPA	\$426		
	¾	47 7/8	12	21	2	FLV2848MCPA		\$636	\$700
	¾	41 7/8	12	19	2	FLT2842MCPA	\$369		
	¾	41 7/8	12	19	2	FLV2842MCPA		\$551	\$607
	¾	35 7/8	12	17	1	FLT2836MCPA	\$342		
	¾	35 7/8	12	17	1	FLV2836MCPA		\$511	\$563
	¾	29 7/8	12	15	1	FLT2830MCPA	\$315		
	¾	29 7/8	12	15	1	FLV2830MCPA		\$472	\$519
	¾	23 7/8	12	13	1	FLT2824MCPA	\$308		
	¾	23 7/8	12	13	1	FLV2824MCPA		\$458	\$506
	¾	17 7/8	12	11	1	FLT2818MCPA	\$305		
	¾	17 7/8	12	11	1	FLV2818MCPA		\$454	\$499

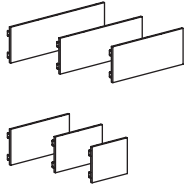

Features:

- use with other modular components, requires a modular top, see page 39

Options:

- must specify chassis grain direction on artisan veneer, see pages 13-15 for details

To Order, Specify:

① Laminate Model #	② Laminate Type	③ Laminate Selection	④ Metal Color	⑤ Other Product Options		
Laminate (FLT)	HPL	See Laminate Selection	See Metal Finish Color Options	See list of options for each specific unit; Specify and add accordingly.		
① Veneer Model #	② Wood Collection	③ Wood Finish	④ Metal Color	⑤ Other Product Options		
Veneer (FLV)	Essentials	See Essentials Wood Finish Options	See Metal Finish Color Options	See list of options for each specific unit; Specify and add accordingly.		
	Artisan	<table border="1"> <tr> <th>ⓐ Wood Finish</th> <th>ⓑ Chassis Grain Direction</th> </tr> <tr> <td>See Artisan Wood Finish Options</td> <td>For Artisan Only: Vertical Horizontal</td> </tr> </table>	ⓐ Wood Finish		ⓑ Chassis Grain Direction	See Artisan Wood Finish Options
ⓐ Wood Finish	ⓑ Chassis Grain Direction					
See Artisan Wood Finish Options	For Artisan Only: Vertical Horizontal					

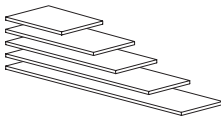
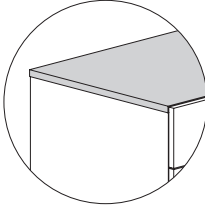
Description	D	W	H	CTN WT	CU FT	① Model	HPL Laminate	Essentials Veneer	Artisan Veneer
Modular Credenza Top for Secondary Height  	21 1/8	108	3/4	57	5	FLT21108MCT	\$681		
	21 1/8	108	3/4	57	5	FLV21108MCT		\$879	\$968
	21 1/8	102	3/4	54	4	FLT21102MCT	\$641		
	21 1/8	102	3/4	54	4	FLV21102MCT		\$832	\$915
	21 1/8	96	3/4	51	4	FLT2196MCT	\$606		
	21 1/8	96	3/4	51	4	FLV2196MCT		\$781	\$858
	21 1/8	90	3/4	48	4	FLT2190MCT	\$569		
	21 1/8	90	3/4	48	4	FLV2190MCT		\$732	\$807
	21 1/8	84	3/4	45	4	FLT2184MCT	\$531		
	21 1/8	84	3/4	45	4	FLV2184MCT		\$684	\$754
	21 1/8	78	3/4	43	3	FLT2178MCT	\$493		
	21 1/8	78	3/4	43	3	FLV2178MCT		\$636	\$700
	21 1/8	72	3/4	40	3	FLT2172MCT	\$454		
	21 1/8	72	3/4	40	3	FLV2172MCT		\$586	\$646
	21 1/8	66	3/4	37	3	FLT2166MCT	\$418		
	21 1/8	66	3/4	37	3	FLV2166MCT		\$540	\$592
	21 1/8	60	3/4	34	3	FLT2160MCT	\$378		
	21 1/8	60	3/4	34	3	FLV2160MCT		\$490	\$540
	21 1/8	54	3/4	31	3	FLT2154MCT	\$342		
	21 1/8	54	3/4	31	3	FLV2154MCT		\$443	\$487
	21 1/8	48	3/4	28	2	FLT2148MCT	\$305		
	21 1/8	48	3/4	28	2	FLV2148MCT		\$394	\$433
	21 1/8	42	3/4	25	2	FLT2142MCT	\$267		
	21 1/8	42	3/4	25	2	FLV2142MCT		\$344	\$378
	21 1/8	36	3/4	23	2	FLT2136MCT	\$228		
	21 1/8	36	3/4	23	2	FLV2136MCT		\$296	\$326
	21 1/8	30	3/4	20	2	FLT2130MCT	\$222		
	21 1/8	30	3/4	20	2	FLV2130MCT		\$286	\$313
	21 1/8	18	3/4	14	1	FLT2118MCT	\$214		
	21 1/8	18	3/4	14	1	FLV2118MCT		\$275	\$301

Features:

- use with secondary height modular components; designed to fit behind drawer fronts and door fronts
- eased edge profile user side

Description	D	W	H	CTN WT	CU FT	① Model	HPL Laminate	Essentials Veneer	Artisan Veneer
Modular Box/File Pedestal - Secondary Height	22	18	21	69	7	FLT2218-21FM5	\$867		
	22	18	21	69	7	FLV2218-21FM5		\$1,210	\$1,329



Options:

- must specify chassis grain direction on artisan veneer, see pages 13-15 for details
- veneer drawer fronts in paint available, specify paint color and add \$354 list; see page 16 for details
- on laminate units, contrasting fronts available, no upcharge; specify color, see page 16 for details
- ledge pulls standard; prism pulls available, specify and see page 9

Modular Single Door Storage Pedestal - Secondary Height	D	W	H	CTN WT	CU FT	Model	HPL Laminate	Essentials Veneer	Artisan Veneer
	22	18	21	59	7	FLT2218-21FM7R	\$665		
	22	18	21	59	7	FLV2218-21FM7R		\$928	\$1,020
	22	18	21	59	7	FLT2218-21FM7L	\$665		
	22	18	21	59	7	FLV2218-21FM7L		\$928	\$1,020

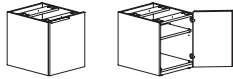

right shown

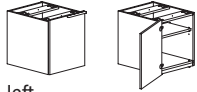

left

Features:

- use with other modular components, requires a modular top, see page 39
- hinged door compartment has one adjustable shelf

Options:

- must specify chassis grain direction on artisan veneer, see pages 13-15 for details
- locking door available, specify and add \$147 list
- veneer door fronts in paint available, specify paint color and add \$354 list; see page 16 for details
- on laminate units, contrasting laminate door fronts available, no upcharge; specify laminate color, see page 16 for details
- ledge pulls standard; prism pulls available, specify and see page 9

Modular Open Compartment	D	W	H	CTN WT	CU FT	Model	HPL Laminate	Essentials Veneer	Artisan Veneer
	22	18	21	54	10	FLT2218-21FM0	\$594		
	22	18	21	54	10	FLV2218-21FM0		\$829	\$910



Features:

- use with other modular components, requires a modular top, see page 39
- open compartment with adjustable shelf

Options:

- must specify chassis grain direction on artisan veneer, see pages 13-15 for details

To Order, Specify:

① Laminate Model #	② Laminate Type	③ Laminate Selection	④ Metal Color	⑤ Other Product Options		
Laminate (FLT)	HPL	See Laminate Selection	See Metal Finish Color Options	See list of options for each specific unit; Specify and add accordingly.		
① Veneer Model #	② Wood Collection	③ Wood Finish	④ Metal Color	⑤ Other Product Options		
Veneer (FLV)	Essentials	See Essentials Wood Finish Options	See Metal Finish Color Options	See list of options for each specific unit; Specify and add accordingly.		
	Artisan	<table border="1"> <thead> <tr> <th>ⓐ Wood Finish</th> <th>ⓑ Chassis Grain Direction</th> </tr> </thead> <tbody> <tr> <td>See Artisan Wood Finish Options</td> <td>For Artisan Only: Vertical Horizontal</td> </tr> </tbody> </table>	ⓐ Wood Finish		ⓑ Chassis Grain Direction	See Artisan Wood Finish Options
ⓐ Wood Finish	ⓑ Chassis Grain Direction					
See Artisan Wood Finish Options	For Artisan Only: Vertical Horizontal					

Description	D	W	H	CTN WT	CU FT	① Model	HPL Laminate	Essentials Veneer	Artisan Veneer
Modular Box/Lateral File - Secondary Height	22	36	21	131	13	FLT2236-21FM6	\$1,122		
	22	36	21	131	13	FLV2236-21FM6		\$1,564	\$1,719
	22	30	21	116	11	FLT2230-21FM6	\$1,094		
	22	30	21	116	11	FLV2230-21FM6		\$1,525	\$1,678



Features:

- use with other modular components, requires a modular top, see page 39
- pedestal front locking

Options:

- must specify chassis grain direction on artisan veneer, see pages 13-15 for details
- veneer drawer fronts in paint available, specify paint color and add \$354 list; see page 16 for details
- on laminate units, contrasting fronts available, no upcharge; specify color, see page 16 for details
- ledge pulls standard; prism pulls available, specify and see page 9

Modular Hidden Drawer Pedestal - Secondary Height	22	36	21	134	13	FLT2236-21FMB	\$1,360		
	22	36	21	134	13	FLV2236-21FMB		\$1,897	\$2,085
	22	30	21	118	11	FLT2230-21FMB	\$1,325		
	22	30	21	118	11	FLV2230-21FMB		\$1,848	\$2,035



Features:

- use with other modular components, requires a modular top, see page 39
- pedestal front locking

Options:

- must specify chassis grain direction on artisan veneer, see pages 13-15 for details
- veneer drawer fronts in paint available, specify paint color and add \$354 list; see page 16 for details
- on laminate units, contrasting fronts available, no upcharge; specify color, see page 16 for details
- ledge pulls standard; prism pulls available, specify and see page 9

Modular Two Door Pedestal - Secondary Height	22	36	21	116	13	FLT2236-21FM7	\$1,139		
	22	36	21	116	13	FLV2236-21FM7		\$1,589	\$1,749
	22	30	21	105	11	FLT2230-21FM7	\$1,117		
	22	30	21	105	11	FLV2230-21FM7		\$1,558	\$1,712

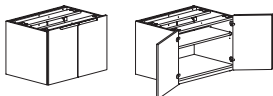

Features:

- use with other modular components, requires a modular top, see page 39
- hinged door compartment has one adjustable shelf

Options:

- must specify chassis grain direction on artisan veneer, see pages 13-15 for details
- locking doors available, specify and add \$147 list
- veneer door fronts in paint available, specify paint color and add \$354 list; see page 16 for details
- on laminate units, contrasting fronts available, no upcharge; specify color, see page 16 for details
- ledge pulls standard; prism pulls available, specify and see page 9

Modular Storage Pedestal with Open Center Shelf - Secondary Height	22	36	21	116	13	FLT2236-21FM8	\$1,167		
	22	36	21	116	13	FLV2236-21FM8		\$1,627	\$1,789
	22	30	21	105	11	FLT2230-21FM8	\$1,139		
	22	30	21	105	11	FLV2230-21FM8		\$1,588	\$1,748

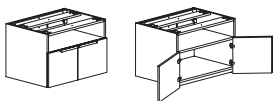

Features:

- use with other modular components, requires a modular top, see page 39

Options:

- must specify chassis grain direction on artisan veneer, see pages 13-15 for details
- locking doors available, specify and add \$147 list
- veneer door fronts in paint available, specify paint color and add \$354 list; see page 16 for details
- on laminate units, contrasting laminate door fronts available, no upcharge; specify laminate color, see page 16 for details
- ledge pulls standard; prism pulls available, specify and see page 9



Description	D	W	H	CTN WT	CU FT	① Model	HPL Laminate	Essentials Veneer	Artisan Veneer
	22	36	21	99	13	FLT2236-21FMO	\$1,029		
	22	36	21	99	13	FLV2236-21FMO		\$1,438	\$1,582
	22	30	21	90	11	FLT2230-21FMO	\$1,006		
	22	30	21	90	11	FLV2230-21FMO		\$1,404	\$1,545

Features:

- use with other modular components, requires a modular top, see page 39
- open compartment with adjustable shelf

Options:

- must specify chassis grain direction on artisan veneer, see pages 13-15 for details

Description	D	W	H	CTN WT	CU FT	① Model	HPL Laminate	Essentials Veneer	Artisan Veneer
 <p>*OE shown</p>  <p>*EO</p>	22	36	21	106	13	FLT2236-21FME0	\$1,448		
	22	36	21	106	13	FLV2236-21FME0		\$2,023	\$2,223
	22	36	21	106	13	FLT2236-21FMOE	\$1,448		
	22	36	21	106	13	FLV2236-21FMOE		\$2,023	\$2,223
	22	30	21	94	11	FLT2230-21FME0	\$1,414		
	22	30	21	94	11	FLV2230-21FME0		\$1,973	\$2,171
	22	30	21	94	11	FLT2230-21FMOE	\$1,414		
	22	30	21	94	11	FLV2230-21FMOE		\$1,973	\$2,171

Features:

- square edge on top
- electrical power unit - EC26 included, specify color
- open compartment with adjustable shelf
- shelf 12 1/2"d

Options:

- must specify chassis grain direction on artisan veneer, see pages 13-15 for details
- oval grommet in back panel can be eliminated upon request, no upcharge

Description	D	W	H	CTN WT	CU FT	① Model	List Price
	2	67	3/4	5	1	GP0267SB	\$116
	2	61	3/4	5	1	GP0261SB	\$103
	2	55	3/4	4	1	GP0255SB	\$97
	2	49	3/4	4	1	GP0249SB	\$88
	2	43	3/4	3	1	GP0243SB	\$83

- black metal
- includes screws for attachment to worksurfaces 1" thick and greater
- required when worksurfaces unsupported span is greater than 48"
- GP0267SB used when unsupported width span is 67" to 74"
- GP0261SB used when unsupported width span is 63" to 68"
- GP0255SB used when unsupported width span is 57" to 62"
- GP0249SB used when unsupported width span is 51" to 56"
- GP0243SB used when unsupported width span is 48" to 50"
- 30"d tops with unsupported span 63"-74" require 2 rails; 36"d & 42"d tops require 2 rails

To Order, Specify:

① Laminate Model #	② Laminate Type	③ Laminate Selection	④ Metal Color	⑤ Other Product Options
Laminate (FLT)	HPL	See Laminate Selection	See Metal Finish Color Options	See list of options for each specific unit; Specify and add accordingly.
① Veneer Model #	② Wood Collection	③ Wood Finish	④ Metal Color	⑤ Other Product Options
Veneer (FLV)	Essentials	See Essentials Wood Finish Options	See Metal Finish Color Options	See list of options for each specific unit; Specify and add accordingly.
	Artisan	ⓐ Wood Finish See Artisan Wood Finish Options	ⓑ Chassis Grain Direction For Artisan Only: Vertical Horizontal	

Description	D	W	H	CTN WT	CU FT	① Model	Laminate	Essentials Veneer	Artisan Veneer
Double Height Overhead Cabinet with Six Doors	15 $\frac{7}{8}$ "	95 $\frac{7}{8}$ "	52"	323	55	FLT1696-52S0	\$2,946		
	15 $\frac{7}{8}$ "	95 $\frac{7}{8}$ "	52"	323	55	FLV1696-52S0		\$4,987	\$5,488
	15 $\frac{7}{8}$ "	89 $\frac{7}{8}$ "	52"	306	52	FLT1690-52S0	\$2,767		
	15 $\frac{7}{8}$ "	89 $\frac{7}{8}$ "	52"	306	52	FLV1690-52S0		\$4,686	\$5,154
	15 $\frac{7}{8}$ "	83 $\frac{7}{8}$ "	52"	289	48	FLT1684-52S0	\$2,583		
	15 $\frac{7}{8}$ "	83 $\frac{7}{8}$ "	52"	289	48	FLV1684-52S0		\$4,376	\$4,814

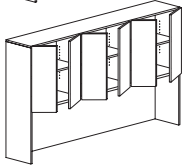
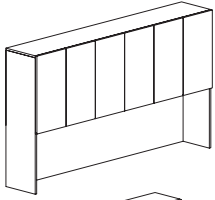

Features:

- use with primary height units, fastening hardware included
- backside of unit intended to go against wall, cabinet should be secured to wall as a safety precaution
- laminate grain direction runs horizontal on back panel of overhead cabinets
- ¼" overhang at the bottom of the door allows access
- 22¾" vertical clearance between worksurface and bottom of door, excluding task light
- two ⅝" dia. holes in upper corners of back panel for task light wiring access
- exterior back panel unfinished
- adjustable shelves

Options:

- must specify chassis grain direction on artisan veneer, see pages 13-15 for details
- veneer door fronts in paint available, specify paint color and add \$354 list; see page 16 for details
- on laminate units, contrasting laminate door fronts available, no upcharge; specify laminate color, see page 16 for details
- white glass doors with aluminum trim available, specify and add \$4,713 list for 96"w, \$4,514 list for 90"w, \$4,344 list for 84"w; see page 33 for details
- markerboard laminate doors available, specify and add \$1,202 list; see page 33 for details
- locking doors available, specify and add \$441 list (not available on glass doors)
- tackboard or markerboard available, see pages 292-295
- tasklights available, see page 455

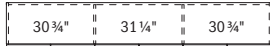

96" wide



90" wide

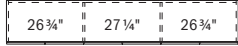

84" wide

FLUX

Description	D	W	H	CTN WT	CU FT	① Model	Laminate	Essentials Veneer	Artisan Veneer
Double Height Overhead Cabinet with Four Doors	15 7/8	77 7/8	52	264	45	FLT1678-52S0	\$2,409		
	15 7/8	77 7/8	52	264	45	FLV1678-52S0		\$3,946	\$4,341
	15 7/8	71 7/8	52	247	42	FLT1672-52S0	\$2,270		
	15 7/8	71 7/8	52	247	42	FLV1672-52S0		\$3,717	\$4,088
	15 7/8	65 7/8	52	235	38	FLT1666-52S0	\$2,145		
	15 7/8	65 7/8	52	235	38	FLV1666-52S0		\$3,513	\$3,863
	15 7/8	59 7/8	52	218	35	FLT1660-52S0	\$2,051		
	15 7/8	59 7/8	52	218	35	FLV1660-52S0		\$3,358	\$3,694

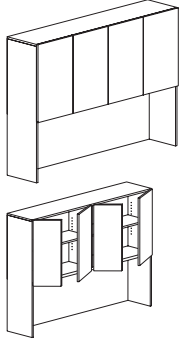

78" wide



72" wide



66" wide

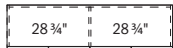

60" wide

Features:

- use with primary height units, fastening hardware included
- backside of unit intended to go against wall, cabinet should be secured to wall as a safety precaution
- laminate grain direction runs horizontal on back panel of overhead cabinets
- 1/4" overhang at the bottom of the door allows access
- 22 3/4" vertical clearance between worksurface and bottom of door, excluding task light
- two 5/8" dia. holes in upper corners of back panel for task light wiring access
- exterior back panel unfinished
- adjustable shelves

Options:

- must specify chassis grain direction on artisan veneer, see pages 13-15 for details
- veneer door fronts in paint available, specify paint color and add \$354 list; see page 16 for details
- on laminate units, contrasting laminate door fronts available, no upcharge; specify laminate color, see page 16 for details
- white glass doors with aluminum trim available, specify and add \$3,609 list for 78"w, \$3,410 list for 72"w, \$3,211 list for 66"w, \$3,013 list for 60"w; see page 33 for details
- markerboard laminate doors available, specify and add \$802 list; see page 33 for details
- locking doors available, specify and add \$294 list (not available on glass doors)
- tackboard or markerboard available, see pages 292-295
- tasklights available, see page 455

To Order, Specify:

① Laminate Model #	② Laminate Selection	③ Metal Color	④ Other Product Options
Laminate (FLT)	See Laminate Selection	See Metal Finish Color Options	See list of options for each specific unit; Specify and add accordingly.

① Veneer Model #	② Wood Collection	③ Wood Finish	④ Metal Color	⑤ Other Product Options		
Veneer (FLV)	Essentials	See Essentials Wood Finish Options	See Metal Finish Color Options	See list of options for each specific unit; Specify and add accordingly.		
	Artisan	<table border="1"> <thead> <tr> <th>③a Wood Finish</th> <th>③b Chassis Grain Direction</th> </tr> </thead> <tbody> <tr> <td>See Artisan Wood Finish Options</td> <td>For Artisan Only: Vertical Horizontal</td> </tr> </tbody> </table>	③a Wood Finish		③b Chassis Grain Direction	See Artisan Wood Finish Options
③a Wood Finish	③b Chassis Grain Direction					
See Artisan Wood Finish Options	For Artisan Only: Vertical Horizontal					

Description	D	W	H	CTN WT	CU FT	① Model	Laminate	Essentials Veneer	Artisan Veneer
Double Height Overhead Cabinet with Three Doors	15 $\frac{7}{8}$ "	53 $\frac{7}{8}$ "	52	200	32	FLT1654-52SOR	\$2,006		
	15 $\frac{7}{8}$ "	53 $\frac{7}{8}$ "	52	200	32	FLV1654-52SOR		\$3,231	\$3,554
	15 $\frac{7}{8}$ "	53 $\frac{7}{8}$ "	52	200	32	FLT1654-52SOL	\$2,006		
	15 $\frac{7}{8}$ "	53 $\frac{7}{8}$ "	52	200	32	FLV1654-52SOL		\$3,231	\$3,554
	15 $\frac{7}{8}$ "	47 $\frac{7}{8}$ "	52	183	28	FLT1648-52SOR	\$1,938		
	15 $\frac{7}{8}$ "	47 $\frac{7}{8}$ "	52	183	28	FLV1648-52SOR		\$3,121	\$3,432
	15 $\frac{7}{8}$ "	47 $\frac{7}{8}$ "	52	183	28	FLT1648-52SOL	\$1,938		
	15 $\frac{7}{8}$ "	47 $\frac{7}{8}$ "	52	183	28	FLV1648-52SOL		\$3,121	\$3,432
	15 $\frac{7}{8}$ "	41 $\frac{7}{8}$ "	52	165	25	FLT1642-52SOR	\$1,875		
	15 $\frac{7}{8}$ "	41 $\frac{7}{8}$ "	52	165	25	FLV1642-52SOR		\$3,019	\$3,322
	15 $\frac{7}{8}$ "	41 $\frac{7}{8}$ "	52	165	25	FLT1642-52SOL	\$1,875		
	15 $\frac{7}{8}$ "	41 $\frac{7}{8}$ "	52	165	25	FLV1642-52SOL		\$3,019	\$3,322

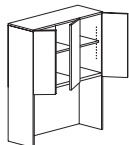
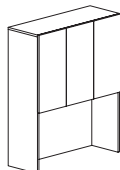

right shown



54" wide

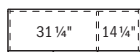

48" wide

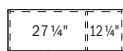

42" wide

Features:

- use with primary height units, fastening hardware included
- backside of unit intended to go against wall, cabinet should be secured to wall as a safety precaution
- laminate grain direction runs horizontal on back panel of overhead cabinets
- 1/4" overhang at the bottom of the door allows access
- 22 3/4" vertical clearance between worksurface and bottom of door, excluding task light
- two 5/8" dia. holes in upper corners of back panel for task light wiring access
- exterior back panel unfinished
- adjustable shelves

Options:

- must specify chassis grain direction on artisan veneer, see pages 13-15 for details
- veneer door fronts in paint available, specify paint color and add \$354 list; see page 16 for details
- on laminate units, contrasting laminate door fronts available, no upcharge; specify laminate color, see page 16 for details
- white glass doors with aluminum trim available, specify and add \$2,558 list for 54"w, \$2,359 list for 48"w, \$2,161 list for 42"w; see page 33 for details
- markerboard laminate doors available, specify and add \$603 list; see page 33 for details
- locking doors available, specify and add \$294 list (not available on glass doors)
- tackboard or markerboard available, see pages 292-295
- tasklights available, see page 455

Description	D	W	H	CTN WT	CU FT	① Model	Laminate	Essentials Veneer	Artisan Veneer
Double Height Overhead Cabinet with Two Doors	15 7/8	35 7/8	52	137	22	FLT1636-52S0	\$1,779		
	15 7/8	35 7/8	52	137	22	FLV1636-52S0		\$2,863	\$3,150
	15 7/8	29 7/8	52	120	18	FLT1630-52S0	\$1,704		
	15 7/8	29 7/8	52	120	18	FLV1630-52S0		\$2,743	\$3,018

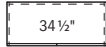
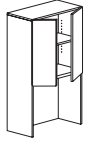
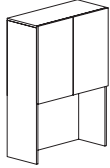

36" wide



30" wide

Features:

- use with primary height units, fastening hardware included
- backside of unit intended to go against wall, cabinet should be secured to wall as a safety precaution
- laminate grain direction runs horizontal on back panel of overhead cabinets
- 1/4" overhang at the bottom of the door allows access
- 22 3/4" vertical clearance between worksurface and bottom of door, excluding task light
- two 5/8" dia. holes in upper corners of back panel for task light wiring access
- exterior back panel unfinished
- adjustable shelf

Options:

- must specify chassis grain direction on artisan veneer, see pages 13-15 for details
- veneer door fronts in paint available, specify paint color and add \$354 list; see page 16 for details
- on laminate units, contrasting laminate door fronts available, no upcharge; specify laminate color, see page 16 for details
- white glass doors with aluminum trim available, specify and add \$1,708 list for 36"w, \$1,509 list for 30"w; see page 33 for details
- markerboard laminate doors available, specify and add \$405 list; see page 33 for details
- locking doors available, specify and add \$147 list (not available on glass doors)
- tackboard or markerboard available, see pages 292-295
- tasklights available, see page 455

To Order, Specify:

① Laminate Model #	② Laminate Selection	③ Metal Color	④ Other Product Options
Laminate (FLT)	See Laminate Selection	See Metal Finish Color Options	See list of options for each specific unit; Specify and add accordingly.

① Veneer Model #	② Wood Collection	③ Wood Finish	④ Metal Color	⑤ Other Product Options		
Veneer (FLV)	Essentials	See Essentials Wood Finish Options	See Metal Finish Color Options	See list of options for each specific unit; Specify and add accordingly.		
	Artisan	<table border="1"> <thead> <tr> <th>③a Wood Finish</th> <th>③b Chassis Grain Direction</th> </tr> </thead> <tbody> <tr> <td>See Artisan Wood Finish Options</td> <td>For Artisan Only: Vertical Horizontal</td> </tr> </tbody> </table>	③a Wood Finish		③b Chassis Grain Direction	See Artisan Wood Finish Options
③a Wood Finish	③b Chassis Grain Direction					
See Artisan Wood Finish Options	For Artisan Only: Vertical Horizontal					

Description	D	W	H	CTN WT	CU FT	Model	Laminate	Essentials Veneer	Artisan Veneer
Double Height Overhead Cabinet with Four Doors and Open Center	15 7/8"	95 7/8"	52"	303	55	FLT1696-52SMO	\$2,799		
	15 7/8"	95 7/8"	52"	303	55	FLV1696-52SMO		\$4,740	\$5,214
	15 7/8"	89 7/8"	52"	287	52	FLT1690-52SMO	\$2,629		
	15 7/8"	89 7/8"	52"	287	52	FLV1690-52SMO		\$4,452	\$4,897
	15 7/8"	83 7/8"	52"	271	48	FLT1684-52SMO	\$2,459		
	15 7/8"	83 7/8"	52"	271	48	FLV1684-52SMO		\$4,158	\$4,575

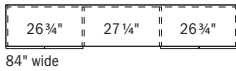
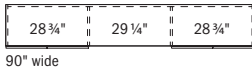
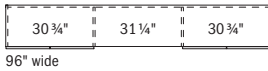
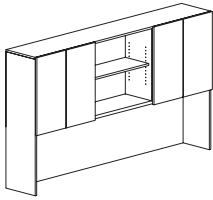

Features:

- use with primary height units, fastening hardware included
- backside of unit intended to go against wall, cabinet should be secured to wall as a safety precaution
- laminate grain direction runs horizontal on back panel of overhead cabinets
- 1/4" overhang at the bottom of the door allows access
- 22 3/4" vertical clearance between worksurface and bottom of door, excluding task light
- two 5/8" dia. holes in upper corners of back panel for task light wiring access
- exterior back panel unfinished
- adjustable shelves

Options:

- must specify chassis grain direction on artisan veneer, see pages 13-15 for details
- veneer door fronts in paint available, specify paint color and add \$354 list; see page 16 for details
- on laminate units, contrasting laminate door fronts available, no upcharge; specify laminate color, see page 16 for details
- white glass doors with aluminum trim available, specify and add \$3,145 list for 96"w, \$3,013 list for 90"w, \$2,881 list for 84"w; see page 33 for details
- markerboard laminate doors available, specify and add \$802 list; see page 33 for details
- locking doors available, specify and add \$294 list (not available on glass doors)
- tackboard or markerboard available, see pages 292-295
- tasklights available, see page 455

Double Height Overhead Cabinet with Two Doors and Open Compartment	15 7/8"	77 7/8"	52"	239	45	FLT1678-52SMOR	\$2,289		
	15 7/8"	77 7/8"	52"	239	45	FLV1678-52SMOR		\$3,750	\$4,123
	15 7/8"	77 7/8"	52"	239	45	FLT1678-52SMOL	\$2,289		
	15 7/8"	77 7/8"	52"	239	45	FLV1678-52SMOL		\$3,750	\$4,123
	15 7/8"	71 7/8"	52"	224	42	FLT1672-52SMOR	\$2,158		
	15 7/8"	71 7/8"	52"	224	42	FLV1672-52SMOR		\$3,535	\$3,887
	15 7/8"	71 7/8"	52"	224	42	FLT1672-52SMOL	\$2,158		
	15 7/8"	71 7/8"	52"	224	42	FLV1672-52SMOL		\$3,535	\$3,887
	15 7/8"	65 7/8"	52"	215	38	FLT1666-52SMOR	\$2,037		
	15 7/8"	65 7/8"	52"	215	38	FLV1666-52SMOR		\$3,338	\$3,673
	15 7/8"	65 7/8"	52"	215	38	FLT1666-52SMOL	\$2,037		
	15 7/8"	65 7/8"	52"	215	38	FLV1666-52SMOL		\$3,338	\$3,673
	15 7/8"	59 7/8"	52"	199	35	FLT1660-52SMOR	\$1,948		
	15 7/8"	59 7/8"	52"	199	35	FLV1660-52SMOR		\$3,191	\$3,511
	15 7/8"	59 7/8"	52"	199	35	FLT1660-52SMOL	\$1,948		
15 7/8"	59 7/8"	52"	199	35	FLV1660-52SMOL		\$3,191	\$3,511	

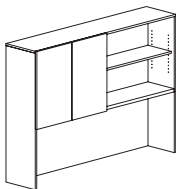

left shown

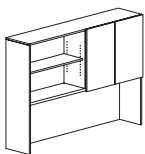

right

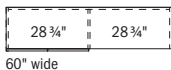
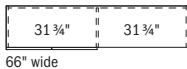
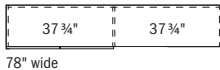

Features:

- use with primary height units, fastening hardware included
- backside of unit intended to go against wall, cabinet should be secured to wall as a safety precaution
- laminate grain direction runs horizontal on back panel of overhead cabinets
- 1/4" overhang at the bottom of the door allows access
- 22 3/4" vertical clearance between worksurface and bottom of door, excluding task light
- two 5/8" dia. holes in upper corners of back panel for task light wiring access
- exterior back panel unfinished
- adjustable shelves

Options:

- must specify chassis grain direction on artisan veneer, see pages 13-15 for details
- veneer door fronts in paint available, specify paint color and add \$354 list; see page 16 for details
- on laminate units, contrasting laminate door fronts available, no upcharge; specify laminate color, see page 16 for details
- white glass doors with aluminum trim available, specify and add \$1,806 list for 78"w, \$1,708 list for 72"w, \$1,608 list for 66"w, \$1,509 list for 60"w; see page 33 for details
- markerboard laminate doors available, specify and add \$405 list; see page 33 for details
- locking doors available, specify and add \$147 list (not available on glass doors)
- tackboard or markerboard available, see pages 292-295
- tasklights available, see page 455

Description	D	W	H	CTN WT	CU FT	① Model	Laminate	Essentials Veneer	Artisan Veneer
Double Height Overhead Cabinet with Two Doors and Open Center	15 7/8"	53 7/8"	52"	197	32	FLT1654-52SMO	\$1,906		
	15 7/8"	53 7/8"	52"	197	32	FLV1654-52SMO		\$3,072	\$3,377
	15 7/8"	47 7/8"	52"	181	28	FLT1648-52SMO	\$1,839		
	15 7/8"	47 7/8"	52"	181	28	FLV1648-52SMO		\$2,965	\$3,263
	15 7/8"	41 7/8"	52"	165	25	FLT1642-52SMO	\$1,783		
	15 7/8"	41 7/8"	52"	165	25	FLV1642-52SMO		\$2,870	\$3,158

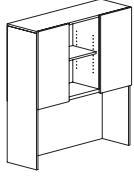

54" wide



48" wide



42" wide

Features:

- use with primary height units, fastening hardware included
- backside of unit intended to go against wall, cabinet should be secured to wall as a safety precaution
- laminate grain direction runs horizontal on back panel of overhead cabinets
- 1/4" overhang at the bottom of the door allows access
- 22 3/4" vertical clearance between worksurface and bottom of door, excluding task light
- two 5/8" dia. holes in upper corners of back panel for task light wiring access
- exterior back panel unfinished
- adjustable shelves

Options:

- must specify chassis grain direction on artisan veneer, see pages 13-15 for details
- veneer door fronts in paint available, specify paint color and add \$354 list; see page 16 for details
- on laminate units, contrasting laminate door fronts available, no upcharge; specify laminate color, see page 16 for details
- white glass doors with aluminum trim available, specify and add \$1,708 list for 54"w, \$1,574 list for 48"w, \$1,441 list for 42"w; see page 33 for details
- markerboard laminate doors available, specify and add \$405 list; see page 33 for details
- locking doors available, specify and add \$294 list (not available on glass doors)
- tackboard or markerboard available, see pages 292-295
- tasklights available, see page 455

To Order, Specify:

① Laminate Model #	② Laminate Selection	③ Metal Color	④ Other Product Options
Laminate (FLT)	See Laminate Selection	See Metal Finish Color Options	See list of options for each specific unit; Specify and add accordingly.

① Veneer Model #	② Wood Collection	③ Wood Finish	④ Metal Color	⑤ Other Product Options		
Veneer (FLV)	Essentials	See Essentials Wood Finish Options	See Metal Finish Color Options	See list of options for each specific unit; Specify and add accordingly.		
	Artisan	<table border="1"> <thead> <tr> <th>③a Wood Finish</th> <th>③b Chassis Grain Direction</th> </tr> </thead> <tbody> <tr> <td>See Artisan Wood Finish Options</td> <td>For Artisan Only: Vertical Horizontal</td> </tr> </tbody> </table>	③a Wood Finish		③b Chassis Grain Direction	See Artisan Wood Finish Options
③a Wood Finish	③b Chassis Grain Direction					
See Artisan Wood Finish Options	For Artisan Only: Vertical Horizontal					

Description	D	W	H	CTN WT	CU FT	① Model	Laminate	Essentials Veneer	Artisan Veneer
Double Height Storage Overhead Cabinet with Four Doors, Open Center and Cubbies	15 7/8"	95 7/8"	52"	313	55	FLT1696-52SMOCC	\$2,927		
	15 7/8"	95 7/8"	52"	313	55	FLV1696-52SMOCC		\$4,926	\$5,417
	15 7/8"	89 7/8"	52"	297	52	FLT1690-52SMOCC	\$2,759		
	15 7/8"	89 7/8"	52"	297	52	FLV1690-52SMOCC		\$4,636	\$5,101
	15 7/8"	83 7/8"	52"	280	48	FLT1684-52SMOCC	\$2,583		
	15 7/8"	83 7/8"	52"	280	48	FLV1684-52SMOCC		\$4,346	\$4,779

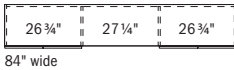
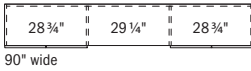
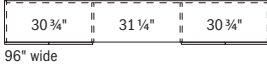
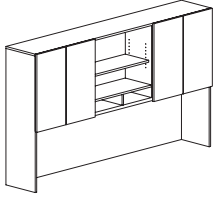

Features:

- use with primary height units, fastening hardware included
- backside of unit intended to go against wall, cabinet should be secured to wall as a safety precaution
- laminate grain direction runs horizontal on back panel of overhead cabinets
- 1/4" overhang at the bottom of the door allows access
- 22 3/4" vertical clearance between worksurface and bottom of door, excluding task light
- two 5/8" dia. holes in upper corners of back panel for task light wiring access
- exterior back panel unfinished
- adjustable shelves

Options:

- must specify chassis grain direction on artisan veneer, see pages 13-15 for details
- veneer door fronts in paint available, specify paint color and add \$354 list; see page 16 for details
- on laminate units, contrasting laminate door fronts available, no upcharge; specify laminate color, see page 16 for details
- white glass doors with aluminum trim available, specify and add \$3,145 list for 96"w, \$3,013 list for 90"w, \$2,881 list for 84"w; see page 33 for details
- markerboard laminate doors available, specify and add \$802 list; see page 33 for details
- locking doors available, specify and add \$294 list (not available on glass doors)
- tackboard or markerboard available, see pages 292-295
- tasklights available, see page 455

Double Height Storage Overhead Cabinet with Two Doors, Open Center and Cubbies	15 7/8"	77 7/8"	52"	260	45	FLT1678-52SMOCC	\$2,420		
	15 7/8"	77 7/8"	52"	260	45	FLV1678-52SMOCC		\$3,935	\$4,329
	15 7/8"	71 7/8"	52"	245	42	FLT1672-52SMOCC	\$2,287		
	15 7/8"	71 7/8"	52"	245	42	FLV1672-52SMOCC		\$3,719	\$4,089
	15 7/8"	65 7/8"	52"	233	38	FLT1666-52SMOCC	\$2,168		
	15 7/8"	65 7/8"	52"	233	38	FLV1666-52SMOCC		\$3,522	\$3,877
	15 7/8"	59 7/8"	52"	221	35	FLT1660-52SMOCC	\$2,078		
	15 7/8"	59 7/8"	52"	221	35	FLV1660-52SMOCC		\$3,377	\$3,715

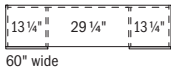
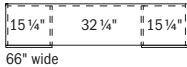
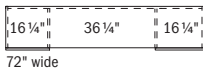
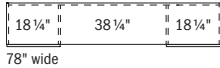
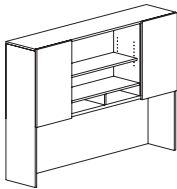

Features:

- use with primary height units, fastening hardware included
- backside of unit intended to go against wall, cabinet should be secured to wall as a safety precaution
- laminate grain direction runs horizontal on back panel of overhead cabinets
- 1/4" overhang at the bottom of the door allows access
- 22 3/4" vertical clearance between worksurface and bottom of door, excluding task light
- two 5/8" dia. holes in upper corners of back panel for task light wiring access
- exterior back panel unfinished
- adjustable shelves

Options:

- must specify chassis grain direction on artisan veneer, see pages 13-15 for details
- veneer door fronts in paint available, specify paint color and add \$354 list; see page 16 for details
- on laminate units, contrasting laminate door fronts available, no upcharge; specify laminate color, see page 16 for details
- white glass doors with aluminum trim available, specify and add \$1,806 list for 78"w, \$1,708 list for 72"w, \$1,608 list for 66"w, \$1,509 list for 60"w; see page 33 for details
- markerboard laminate doors available, specify and add \$405 list; see page 33 for details
- locking doors available, specify and add \$294 list (not available on glass doors)
- tackboard or markerboard available, see pages 292-295
- tasklights available, see page 455

Description	D	W	H	CTN WT	CU FT	① Model	Laminate	Essentials Veneer	Artisan Veneer
Double Height Overhead Cabinet with Two Doors, Open Center and Cubby	15 7/8	53 7/8	52	202	32	FLT1654-52SMOCC	\$2,035		
	15 7/8	53 7/8	52	202	32	FLV1654-52SMOCC		\$3,254	\$3,583
	15 7/8	47 7/8	52	186	28	FLT1648-52SMOCC	\$1,968		
	15 7/8	47 7/8	52	186	28	FLV1648-52SMOCC		\$3,153	\$3,468
	15 7/8	41 7/8	52	169	25	FLT1642-52SMOCC	\$1,911		
	15 7/8	41 7/8	52	169	25	FLV1642-52SMOCC		\$3,056	\$3,363

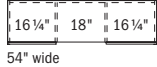
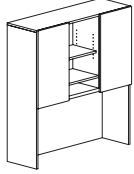

54" wide

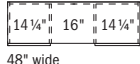

48" wide

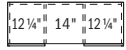

42" wide

Features:

- use with primary height units, fastening hardware included
- backside of unit intended to go against wall, cabinet should be secured to wall as a safety precaution
- laminate grain direction runs horizontal on back panel of overhead cabinets
- 1/4" overhang at the bottom of the door allows access
- 22 3/4" vertical clearance between worksurface and bottom of door, excluding task light
- two 5/8" dia. holes in upper corners of back panel for task light wiring access
- exterior back panel unfinished
- adjustable shelves

Options:

- must specify chassis grain direction on artisan veneer, see pages 13-15 for details
- veneer door fronts in paint available, specify paint color and add \$354 list; see page 16 for details
- on laminate units, contrasting laminate door fronts available, no upcharge; specify laminate color, see page 16 for details
- white glass doors with aluminum trim available, specify and add \$1,708 list for 54"w, \$1,574 list for 48"w, \$1,441 list for 42"w; see page 33 for details
- markerboard laminate doors available, specify and add \$405 list; see page 33 for details
- locking doors available, specify and add \$294 list (not available on glass doors)
- tackboard or markerboard available, see pages 292-295
- tasklights available, see page 455

To Order, Specify:

① Laminate Model #	② Laminate Selection	③ Metal Color	④ Other Product Options
Laminate (FLT)	See Laminate Selection	See Metal Finish Color Options	See list of options for each specific unit; Specify and add accordingly.

① Veneer Model #	② Wood Collection	③ Wood Finish	④ Metal Color	⑤ Other Product Options		
Veneer (FLV)	Essentials	See Essentials Wood Finish Options	See Metal Finish Color Options	See list of options for each specific unit; Specify and add accordingly.		
	Artisan	<table border="1"> <thead> <tr> <th>③a Wood Finish</th> <th>③b Chassis Grain Direction</th> </tr> </thead> <tbody> <tr> <td>See Artisan Wood Finish Options</td> <td>For Artisan Only: Vertical Horizontal</td> </tr> </tbody> </table>	③a Wood Finish		③b Chassis Grain Direction	See Artisan Wood Finish Options
③a Wood Finish	③b Chassis Grain Direction					
See Artisan Wood Finish Options	For Artisan Only: Vertical Horizontal					

Description	D	W	H	CTN WT	CU FT	① Model	Laminate	Essentials Veneer	Artisan Veneer
Double Height Storage Overhead Cabinet with Sliding Doors	15 15/16	95 7/8	52	311	55	FLT1696-52SD	\$3,309		
	15 15/16	95 7/8	52	311	55	FLV1696-52SD		\$5,422	\$5,964
	15 15/16	89 13/16	52	295	52	FLT1690-52SD	\$3,066		
	15 15/16	89 13/16	52	295	52	FLV1690-52SD		\$5,025	\$5,528
	15 15/16	83 7/8	52	279	49	FLT1684-52SD	\$2,823		
	15 15/16	83 7/8	52	279	49	FLV1684-52SD		\$4,625	\$5,088

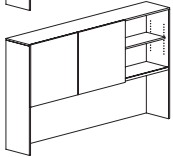
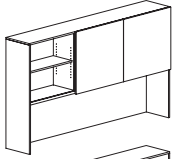
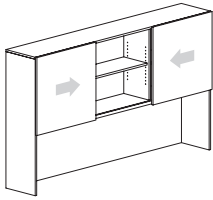

Features:

- use with primary height units, fastening hardware included
- backside of unit intended to go against wall, cabinet should be secured to wall as a safety precaution
- laminate grain direction runs horizontal on back panel of overhead cabinets
- 22 3/4" vertical clearance between worksurface and bottom of door, excluding task light
- two 5/8" dia. holes in upper corners of back panel for task light wiring access
- exterior back panel unfinished
- locking not available
- adjustable shelves

Options:

- must specify chassis grain direction on artisan veneer, see pages 13-15 for details
- veneer door fronts in paint available, specify paint color and add \$354 list; see page 16 for details
- on laminate units, contrasting laminate door fronts available, no upcharge; specify laminate color, see page 16 for details
- white glass doors with aluminum trim available, specify and add \$2,758 list for 96"w, \$2,623 list for 90"w, \$2,491 list for 84"w; see page 33 for details
- markerboard laminate doors available, specify and add \$598 list; see page 33 for details
- tackboard or markerboard available, see pages 292-295
- tasklights available, see page 455

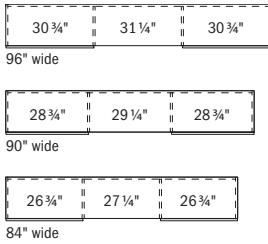

Double Height Storage Overhead Cabinet with Sliding Door	15 15/16	77 7/8	52	245	45	FLT1678-52SD	\$2,721		
	15 15/16	77 7/8	52	245	45	FLV1678-52SD		\$4,313	\$4,744
	15 15/16	71 7/8	52	224	42	FLT1672-52SD	\$2,567		
	15 15/16	71 7/8	52	224	42	FLV1672-52SD		\$4,070	\$4,477
	15 15/16	65 7/8	52	214	39	FLT1666-52SD	\$2,428		
	15 15/16	65 7/8	52	214	39	FLV1666-52SD		\$3,850	\$4,235
	15 15/16	59 7/8	52	193	35	FLT1660-52SD	\$2,323		
	15 15/16	59 7/8	52	193	35	FLV1660-52SD		\$3,686	\$4,055

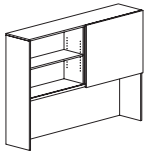
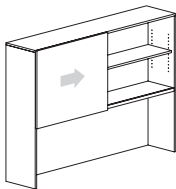

Features:

- use with primary height units, fastening hardware included
- backside of unit intended to go against wall, cabinet should be secured to wall as a safety precaution
- laminate grain direction runs horizontal on back panel of overhead cabinets
- 22 3/4" vertical clearance between worksurface and bottom of door, excluding task light
- two 5/8" dia. holes in upper corners of back panel for task light wiring access
- exterior back panel unfinished
- locking not available
- adjustable shelves

Options:

- must specify chassis grain direction on artisan veneer, see pages 13-15 for details
- veneer door fronts in paint available, specify paint color and add \$354 list; see page 16 for details
- on laminate units, contrasting laminate door fronts available, no upcharge; specify laminate color, see page 16 for details
- white glass doors with aluminum trim available, specify and add \$1,612 list for 78"w, \$1,514 list for 72"w, \$1,414 list for 66"w, \$1,314 list for 60"w; see page 33 for details
- markerboard laminate doors available, specify and add \$301 list; see page 33 for details
- tackboard or markerboard available, see pages 292-295
- tasklights available, see page 455

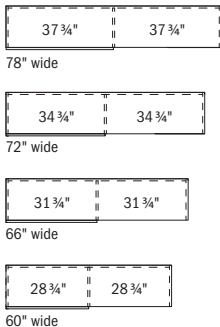

Description	D	W	H	CTN WT	CU FT	① Model	Laminate	Essentials Veneer	Artisan Veneer
Double Height Storage Overhead Cabinet with Sliding Door	15 15/16	53 7/8	52	183	32	FLT1654-52SD	\$2,274		
	15 15/16	53 7/8	52	183	32	FLV1654-52SD		\$3,547	\$3,902
	15 15/16	47 7/8	52	167	28	FLT1648-52SD	\$2,199		
	15 15/16	47 7/8	52	167	28	FLV1648-52SD		\$3,430	\$3,772
	15 15/16	41 7/8	52	152	25	FLT1642-52SD	\$2,132		
	15 15/16	41 7/8	52	152	25	FLV1642-52SD		\$3,324	\$3,657

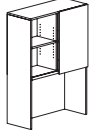
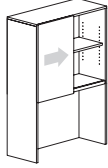

54" wide

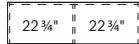

48" wide

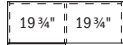

42" wide

Features:

- use with primary height units, fastening hardware included
- backside of unit intended to go against wall, cabinet should be secured to wall as a safety precaution
- laminate grain direction runs horizontal on back panel of overhead cabinets
- 22 3/4" vertical clearance between worksurface and bottom of door, excluding task light
- two 5/8" dia. holes in upper corners of back panel for task light wiring access
- exterior back panel unfinished
- locking not available
- adjustable shelves

Options:

- must specify chassis grain direction on artisan veneer, see pages 13-15 for details
- veneer door fronts in paint available, specify paint color and add \$354 list; see page 16 for details
- on laminate units, contrasting laminate door fronts available, no upcharge; specify laminate color, see page 16 for details
- white glass doors with aluminum trim available, specify and add \$1,214 list for 54"w, \$1,116 list for 48"w, \$1,017 list for 42"w; see page 33 for details
- markerboard laminate doors available, specify and add \$301 list; see page 33 for details
- tackboard or markerboard available, see pages 292-295
- tasklights available, see page 455

Double Height Storage Overhead Cabinet with Sliding Door	15 15/16	35 7/8	52	136	22	FLT1636-52SD	\$2,022		
	15 15/16	35 7/8	52	136	22	FLV1636-52SD		\$3,155	\$3,470
	15 15/16	29 7/8	52	121	18	FLT1630-52SD	\$1,941		
	15 15/16	29 7/8	52	121	18	FLV1630-52SD		\$3,027	\$3,331

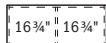
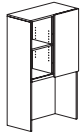
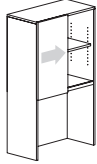

36" wide



30" wide

Features:

- use with primary height units, fastening hardware included
- backside of unit intended to go against wall, cabinet should be secured to wall as a safety precaution
- laminate grain direction runs horizontal on back panel of overhead cabinets
- 22 3/4" vertical clearance between worksurface and bottom of door, excluding task light
- two 5/8" dia. holes in upper corners of back panel for task light wiring access
- exterior back panel unfinished
- locking not available
- adjustable shelves

Options:

- must specify chassis grain direction on artisan veneer, see pages 13-15 for details
- veneer door fronts in paint available, specify paint color and add \$354 list; see page 16 for details
- on laminate units, contrasting laminate door fronts available, no upcharge; specify laminate color, see page 16 for details
- white glass doors with aluminum trim available, specify and add \$916 list for 36"w, \$817 list for 30"w; see page 33 for details
- markerboard laminate doors available, specify and add \$301 list; see page 33 for details
- tackboard or markerboard available, see pages 292-295
- tasklights available, see page 455

To Order, Specify:

① Laminate Model #	② Laminate Selection	③ Metal Color	④ Other Product Options
Laminate (FLT)	See Laminate Selection	See Metal Finish Color Options	See list of options for each specific unit; Specify and add accordingly.

① Veneer Model #	② Wood Collection	③ Wood Finish	④ Metal Color	⑤ Other Product Options		
Veneer (FLV)	Essentials	See Essentials Wood Finish Options	See Metal Finish Color Options	See list of options for each specific unit; Specify and add accordingly.		
	Artisan	<table border="1"> <thead> <tr> <th>ⓐ Wood Finish</th> <th>ⓑ Chassis Grain Direction</th> </tr> </thead> <tbody> <tr> <td>See Artisan Wood Finish Options</td> <td>For Artisan Only: Vertical Horizontal</td> </tr> </tbody> </table>	ⓐ Wood Finish		ⓑ Chassis Grain Direction	See Artisan Wood Finish Options
ⓐ Wood Finish	ⓑ Chassis Grain Direction					
See Artisan Wood Finish Options	For Artisan Only: Vertical Horizontal					

Description	D	W	H	CTN WT	CU FT	Model	Laminate	Essentials Veneer	Artisan Veneer
Double Height Open Storage Overhead Cabinet	15	95 $\frac{7}{8}$ "	52	257	52	FLT1596-5200	\$2,562		
	15	95 $\frac{7}{8}$ "	52	257	52	FLV1596-5200		\$4,341	\$4,775
	15	89 $\frac{13}{16}$ "	52	244	49	FLT1590-5200	\$2,407		
	15	89 $\frac{13}{16}$ "	52	244	49	FLV1590-5200		\$4,078	\$4,486
	15	83 $\frac{7}{8}$ "	52	231	46	FLT1584-5200	\$2,252		
	15	83 $\frac{7}{8}$ "	52	231	46	FLV1584-5200		\$3,809	\$4,189

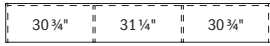
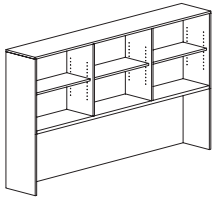

96" wide



90" wide

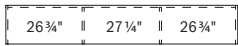

84" wide

Features:

- use with primary height units, fastening hardware included
- laminate grain direction runs horizontal on back panel of overhead cabinets
- backside of unit intended to go against wall, cabinet should be secured to wall as a safety precaution
- 23" vertical clearance between worksurface and bottom of cabinet, excluding task light
- two $\frac{5}{8}$ " dia. holes in upper corners of back panel for task light wiring access
- exterior back panel unfinished
- adjustable shelves

Options:

- must specify chassis grain direction on artisan veneer, see pages 13-15 for details
- tackboard or markerboard available, see pages 292-295
- tasklights available, see page 455

Double Height Open Storage Overhead Cabinet	15	77 $\frac{7}{8}$ "	52	210	43	FLT1578-5200	\$2,098		
	15	77 $\frac{7}{8}$ "	52	210	43	FLV1578-5200		\$3,434	\$3,777
	15	71 $\frac{7}{8}$ "	52	197	40	FLT1572-5200	\$1,977		
	15	71 $\frac{7}{8}$ "	52	197	40	FLV1572-5200		\$3,237	\$3,559
	15	65 $\frac{7}{8}$ "	52	189	37	FLT1566-5200	\$1,868		
	15	65 $\frac{7}{8}$ "	52	189	37	FLV1566-5200		\$3,056	\$3,363
	15	59 $\frac{7}{8}$ "	52	175	33	FLT1560-5200	\$1,785		
	15	59 $\frac{7}{8}$ "	52	175	33	FLV1560-5200		\$2,924	\$3,217

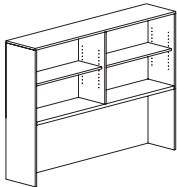

78" wide



72" wide

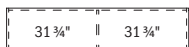

66" wide

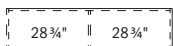

60" wide

Features:

- use with primary height units, fastening hardware included
- laminate grain direction runs horizontal on back panel of overhead cabinets
- backside of unit intended to go against wall, cabinet should be secured to wall as a safety precaution
- 23" vertical clearance between worksurface and bottom of cabinet, excluding task light
- two $\frac{5}{8}$ " dia. holes in upper corners of back panel for task light wiring access
- exterior back panel unfinished
- adjustable shelves

Options:

- must specify chassis grain direction on artisan veneer, see pages 13-15 for details
- tackboard or markerboard available, see pages 292-295
- tasklights available, see page 455

FLUX

Description	D	W	H	CTN WT	CU FT	① Model	Laminate	Essentials Veneer	Artisan Veneer
Double Height Open Storage Overhead Cabinet	15	53 7/8	52	162	30	FLT1554-5200	\$1,747		
	15	53 7/8	52	162	30	FLV1554-5200		\$2,812	\$3,093
	15	47 7/8	52	148	27	FLT1548-5200	\$1,685		
	15	47 7/8	52	148	27	FLV1548-5200		\$2,715	\$2,987
	15	41 7/8	52	134	24	FLT1542-5200	\$1,633		
	15	41 7/8	52	134	24	FLV1542-5200		\$2,627	\$2,892

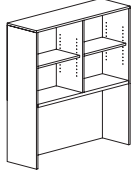

54" wide

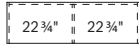

48" wide

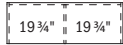

42" wide

Features:

- use with primary height units, fastening hardware included
- laminate grain direction runs horizontal on back panel of overhead cabinets
- backside of unit intended to go against wall, cabinet should be secured to wall as a safety precaution
- 23" vertical clearance between worksurface and bottom of cabinet, excluding task light
- two 5/8" dia. holes in upper corners of back panel for task light wiring access
- exterior back panel unfinished
- adjustable shelves

Options:

- must specify chassis grain direction on artisan veneer, see pages 13-15 for details
- tackboard or markerboard available, see pages 292-295
- tasklights available, see page 455

Double Height Open Storage Overhead Cabinet	15	35 7/8	52	110	21	FLT1536-5200	\$1,548		
	15	35 7/8	52	110	21	FLV1536-5200		\$2,491	\$2,741
	15	29 7/8	52	97	17	FLT1530-5200	\$1,483		
	15	29 7/8	52	97	17	FLV1530-5200		\$2,387	\$2,625

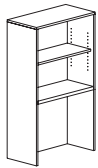

36" wide



30" wide

Features:

- use with primary height units, fastening hardware included
- laminate grain direction runs horizontal on back panel of overhead cabinets
- backside of unit intended to go against wall, cabinet should be secured to wall as a safety precaution
- 23" vertical clearance between worksurface and bottom of cabinet, excluding task light
- two 5/8" dia. holes in upper corners of back panel for task light wiring access
- exterior back panel unfinished
- adjustable shelves

Options:

- must specify chassis grain direction on artisan veneer, see pages 13-15 for details
- tackboard or markerboard available, see pages 292-295
- tasklights available, see page 455

To Order, Specify:

① Laminate Model #	② Laminate Selection	③ Metal Color	④ Other Product Options
Laminate (FLT)	See Laminate Selection	See Metal Finish Color Options	See list of options for each specific unit; Specify and add accordingly.

① Veneer Model #	② Wood Collection	③ Wood Finish	④ Metal Color	⑤ Other Product Options		
Veneer (FLV)	Essentials	See Essentials Wood Finish Options	See Metal Finish Color Options	See list of options for each specific unit; Specify and add accordingly.		
	Artisan	<table border="1"> <thead> <tr> <th>ⓐ Wood Finish</th> <th>ⓑ Chassis Grain Direction</th> </tr> </thead> <tbody> <tr> <td>See Artisan Wood Finish Options</td> <td>For Artisan Only: Vertical Horizontal</td> </tr> </tbody> </table>	ⓐ Wood Finish		ⓑ Chassis Grain Direction	See Artisan Wood Finish Options
ⓐ Wood Finish	ⓑ Chassis Grain Direction					
See Artisan Wood Finish Options	For Artisan Only: Vertical Horizontal					

Description	D	W	H	CTN WT	CU FT	① Model	Laminate	Essentials Veneer	Artisan Veneer
Storage Overhead Cabinet with Six Doors	15 $\frac{7}{8}$ "	95 $\frac{7}{8}$ "	40"	232	43	FLT1696-40SO	\$2,356		
	15 $\frac{7}{8}$ "	95 $\frac{7}{8}$ "	40"	232	43	FLV1696-40SO		\$3,992	\$4,389
	15 $\frac{7}{8}$ "	89 $\frac{7}{8}$ "	40"	220	40	FLT1690-40SO	\$2,214		
	15 $\frac{7}{8}$ "	89 $\frac{7}{8}$ "	40"	220	40	FLV1690-40SO		\$3,750	\$4,123
	15 $\frac{7}{8}$ "	83 $\frac{7}{8}$ "	40"	208	38	FLT1684-40SO	\$2,070		
	15 $\frac{7}{8}$ "	83 $\frac{7}{8}$ "	40"	208	38	FLV1684-40SO		\$3,501	\$3,851

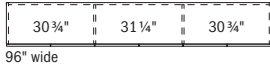
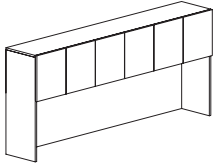

96" wide



90" wide

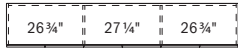

84" wide

Features:

- use with primary height units, fastening hardware included
- laminate grain direction runs horizontal on back panel of overhead cabinets
- 1/4" overhang at the bottom of the door allows access
- 22 3/4" vertical clearance between worksurface and bottom of door, excluding task light
- two 5/8" dia. holes in upper corners of back panel for task light wiring access
- exterior back panel unfinished

Options:

- must specify chassis grain direction on artisan veneer, see pages 13-15 for details
- veneer door fronts in paint available, specify paint color and add \$354 list; see page 16 for details
- on laminate units, contrasting laminate door fronts available, no upcharge; specify laminate color, see page 16 for details
- white glass doors with aluminum trim available, specify and add \$3,516 list; see page 33 for details
- markerboard laminate doors available, specify and add \$1,202 list; see page 33 for details
- locking doors available, specify and add \$441 list (not available on glass doors)
- tackboard or markerboard available, see pages 292-295
- tasklights available, see page 455

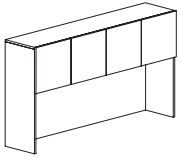
Description	D	W	H	CTN WT	CU FT	① Model	Laminate	Essentials Veneer	Artisan Veneer
Storage Overhead Cabinet with Four Doors 	15 7/8	77 7/8	40	192	35	FLT1678-40SO	\$1,926		
	15 7/8	77 7/8	40	192	35	FLV1678-40SO		\$3,158	\$3,474
	15 7/8	71 7/8	40	178	33	FLT1672-40SO	\$1,819		
	15 7/8	71 7/8	40	178	33	FLV1672-40SO		\$2,974	\$3,272
	15 7/8	65 7/8	40	172	30	FLT1666-40SO	\$1,715		
	15 7/8	65 7/8	40	172	30	FLV1666-40SO		\$2,811	\$3,091
	15 7/8	59 7/8	40	160	27	FLT1660-40SO	\$1,641		
	15 7/8	59 7/8	40	160	27	FLV1660-40SO		\$2,688	\$2,956

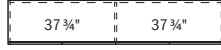

78" wide

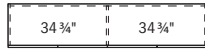

72" wide



66" wide



60" wide

Features:

- use with primary height units, fastening hardware included
- laminate grain direction runs horizontal on back panel of overhead cabinets
- 1/4" overhang at the bottom of the door allows access
- 22 3/4" vertical clearance between worksurface and bottom of door, excluding task light
- two 5/8" dia. holes in upper corners of back panel for task light wiring access
- exterior back panel unfinished

Options:

- must specify chassis grain direction on artisan veneer, see pages 13-15 for details
- veneer door fronts in paint available, specify paint color and add \$354 list; see page 16 for details
- on laminate units, contrasting laminate door fronts available, no upcharge; specify laminate color, see page 16 for details
- white glass doors with aluminum trim available, specify and add \$2,555 list for 78"w, \$2,438 list for 72"w, \$2,346 list for 66"w or 60"w; see page 33 for details
- markerboard laminate doors available, specify and add \$802 list; see page 33 for details
- locking doors available, specify and add \$294 list (not available on glass doors)
- tackboard or markerboard available, see pages 292-295
- tasklights available, see page 455

To Order, Specify:

① Laminate Model #	② Laminate Selection	③ Metal Color	④ Other Product Options
Laminate (FLT)	See Laminate Selection	See Metal Finish Color Options	See list of options for each specific unit; Specify and add accordingly.

① Veneer Model #	② Wood Collection	③ Wood Finish	④ Metal Color	⑤ Other Product Options		
Veneer (FLV)	Essentials	See Essentials Wood Finish Options	See Metal Finish Color Options	See list of options for each specific unit; Specify and add accordingly.		
	Artisan	<table border="1"> <thead> <tr> <th>③a Wood Finish</th> <th>③b Chassis Grain Direction</th> </tr> </thead> <tbody> <tr> <td>See Artisan Wood Finish Options</td> <td>For Artisan Only: Vertical Horizontal</td> </tr> </tbody> </table>	③a Wood Finish		③b Chassis Grain Direction	See Artisan Wood Finish Options
③a Wood Finish	③b Chassis Grain Direction					
See Artisan Wood Finish Options	For Artisan Only: Vertical Horizontal					

Description	D	W	H	CTN WT	CU FT	① Model	Laminate	Essentials Veneer	Artisan Veneer
Storage Overhead Cabinet with Three Doors	15 $\frac{7}{8}$ "	53 $\frac{7}{8}$ "	40"	147	25	FLT1654-40SOR	\$1,605		
	15 $\frac{7}{8}$ "	53 $\frac{7}{8}$ "	40"	147	25	FLV1654-40SOR		\$2,582	\$2,842
	15 $\frac{7}{8}$ "	53 $\frac{7}{8}$ "	40"	147	25	FLT1654-40SOL	\$1,605		
	15 $\frac{7}{8}$ "	53 $\frac{7}{8}$ "	40"	147	25	FLV1654-40SOL		\$2,582	\$2,842
	15 $\frac{7}{8}$ "	47 $\frac{7}{8}$ "	40"	134	22	FLT1648-40SOR	\$1,550		
	15 $\frac{7}{8}$ "	47 $\frac{7}{8}$ "	40"	134	22	FLV1648-40SOR		\$2,495	\$2,745
	15 $\frac{7}{8}$ "	47 $\frac{7}{8}$ "	40"	134	22	FLT1648-40SOL	\$1,550		
	15 $\frac{7}{8}$ "	47 $\frac{7}{8}$ "	40"	134	22	FLV1648-40SOL		\$2,495	\$2,745
	15 $\frac{7}{8}$ "	41 $\frac{7}{8}$ "	40"	122	20	FLT1642-40SOR	\$1,502		
	15 $\frac{7}{8}$ "	41 $\frac{7}{8}$ "	40"	122	20	FLV1642-40SOR		\$2,419	\$2,658
	15 $\frac{7}{8}$ "	41 $\frac{7}{8}$ "	40"	122	20	FLT1642-40SOL	\$1,502		
	15 $\frac{7}{8}$ "	41 $\frac{7}{8}$ "	40"	122	20	FLV1642-40SOL		\$2,419	\$2,658

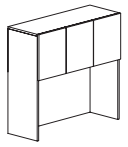

right shown

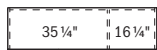

54" wide

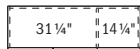

48" wide

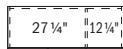

42" wide

Features:

- use with primary height units, fastening hardware included
- laminate grain direction runs horizontal on back panel of overhead cabinets
- 1/4" overhang at the bottom of the door allows access
- 22 3/4" vertical clearance between worksurface and bottom of door, excluding task light
- two 5/8" dia. holes in upper corners of back panel for task light wiring access
- exterior back panel unfinished

Options:

- must specify chassis grain direction on artisan veneer, see pages 13-15 for details
- veneer door fronts in paint available, specify paint color and add \$354 list; see page 16 for details
- on laminate units, contrasting laminate door fronts available, no upcharge; specify laminate color, see page 16 for details
- white glass doors with aluminum trim available, specify and add \$1,830 list for 54"w, \$1,759 list for 48"w or 42"w; see page 33 for details
- markerboard laminate doors available, specify and add \$603 list; see page 33 for details
- locking doors available, specify and add \$294 list (not available on glass doors)
- tackboard or markerboard available, see pages 292-295
- tasklights available, see page 455

Description	D	W	H	CTN WT	CU FT	① Model	Laminate	Essentials Veneer	Artisan Veneer
Storage Overhead Cabinet with Two Doors	15 7/8	35 7/8	40	102	17	FLT1636-40SO	\$1,425		
	15 7/8	35 7/8	40	102	17	FLV1636-40SO		\$2,291	\$2,519
	15 7/8	29 7/8	40	90	14	FLT1630-40SO	\$1,364		
	15 7/8	29 7/8	40	90	14	FLV1630-40SO		\$2,194	\$2,417

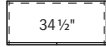
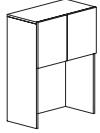

36" wide



30" wide

Features:

- use with primary height units, fastening hardware included
- laminate grain direction runs horizontal on back panel of overhead cabinets
- 1/4" overhang at the bottom of the door allows access
- 22 3/4" vertical clearance between worksurface and bottom of door, excluding task light
- two 5/8" dia. holes in upper corners of back panel for task light wiring access
- exterior back panel unfinished

Options:

- must specify chassis grain direction on artisan veneer, see pages 13-15 for details
- veneer door fronts in paint available, specify paint color and add \$354 list; see page 16 for details
- on laminate units, contrasting laminate door fronts available, no upcharge; specify laminate color, see page 16 for details
- white glass doors with aluminum trim available, specify and add \$1,222 list for 36"w, \$1,175 list for 30"w; see page 33 for details
- markerboard laminate doors available, specify and add \$405 list; see page 33 for details
- locking doors available, specify and add \$147 list (not available on glass doors)
- tackboard or markerboard available, see pages 292-295
- tasklights available, see page 455

To Order, Specify:

① Laminate Model #	② Laminate Selection	③ Metal Color	④ Other Product Options
Laminate (FLT)	See Laminate Selection	See Metal Finish Color Options	See list of options for each specific unit; Specify and add accordingly.

① Veneer Model #	② Wood Collection	③ Wood Finish	④ Metal Color	⑤ Other Product Options		
Veneer (FLV)	Essentials	See Essentials Wood Finish Options	See Metal Finish Color Options	See list of options for each specific unit; Specify and add accordingly.		
	Artisan	<table border="1"> <thead> <tr> <th>③a Wood Finish</th> <th>③b Chassis Grain Direction</th> </tr> </thead> <tbody> <tr> <td>See Artisan Wood Finish Options</td> <td>For Artisan Only: Vertical Horizontal</td> </tr> </tbody> </table>	③a Wood Finish		③b Chassis Grain Direction	See Artisan Wood Finish Options
③a Wood Finish	③b Chassis Grain Direction					
See Artisan Wood Finish Options	For Artisan Only: Vertical Horizontal					

Description	D	W	H	CTN WT	CU FT	Model	Laminate	Essentials Veneer	Artisan Veneer
Storage Overhead Cabinet with Four Doors and Open Center	15 7/8"	95 7/8"	40"	221	43	FLT1696-40SMO	\$2,237		
	15 7/8"	95 7/8"	40"	221	43	FLV1696-40SMO		\$3,787	\$4,165
	15 7/8"	89 7/8"	40"	209	40	FLT1690-40SMO	\$2,071		
	15 7/8"	89 7/8"	40"	209	40	FLV1690-40SMO		\$3,504	\$3,854
	15 7/8"	83 7/8"	40"	198	38	FLT1684-40SMO	\$1,903		
	15 7/8"	83 7/8"	40"	198	38	FLV1684-40SMO		\$3,219	\$3,541

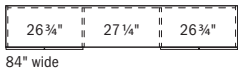
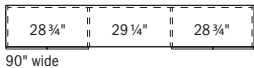
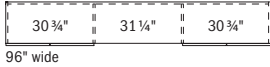
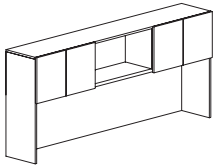

Features:

- use with primary height units, fastening hardware included
- laminate grain direction runs horizontal on back panel of overhead cabinets
- 1/4" overhang at the bottom of the door allows access
- 22 3/4" vertical clearance between worksurface and bottom of door, excluding task light
- two 5/8" dia. holes in upper corners of back panel for task light wiring access
- exterior back panel unfinished

Options:

- must specify chassis grain direction on artisan veneer, see pages 13-15 for details
- veneer door fronts in paint available, specify paint color and add \$354 list; see page 16 for details
- on laminate units, contrasting laminate door fronts available, no upcharge; specify laminate color, see page 16 for details
- white glass doors with aluminum trim available, specify and add \$2,346 list; see page 33 for details
- markerboard laminate doors available, specify and add \$802 list; see page 33 for details
- locking doors available, specify and add \$294 list (not available on glass doors)
- tackboard or markerboard available, see pages 292-295
- tasklights available, see page 455

Storage Overhead Cabinet with Two Doors and Open Compartment	15 7/8"	77 7/8"	40"	180	35	FLT1678-40SMOR	\$1,832		
	15 7/8"	77 7/8"	40"	180	35	FLV1678-40SMOR		\$3,000	\$3,297
	15 7/8"	77 7/8"	40"	180	35	FLT1678-40SMOL	\$1,832		
	15 7/8"	77 7/8"	40"	180	35	FLV1678-40SMOL		\$3,000	\$3,297
	15 7/8"	71 7/8"	40"	169	33	FLT1672-40SMOR	\$1,726		
	15 7/8"	71 7/8"	40"	169	33	FLV1672-40SMOR		\$2,826	\$3,110
	15 7/8"	71 7/8"	40"	169	33	FLT1672-40SMOL	\$1,726		
	15 7/8"	71 7/8"	40"	169	33	FLV1672-40SMOL		\$2,826	\$3,110
	15 7/8"	65 7/8"	40"	163	30	FLT1666-40SMOR	\$1,633		
	15 7/8"	65 7/8"	40"	163	30	FLV1666-40SMOR		\$2,672	\$2,939
	15 7/8"	65 7/8"	40"	163	30	FLT1666-40SMOL	\$1,633		
	15 7/8"	65 7/8"	40"	163	30	FLV1666-40SMOL		\$2,672	\$2,939
	15 7/8"	59 7/8"	40"	152	27	FLT1660-40SMOR	\$1,560		
	15 7/8"	59 7/8"	40"	152	27	FLV1660-40SMOR		\$2,553	\$2,810
	15 7/8"	59 7/8"	40"	152	27	FLT1660-40SMOL	\$1,560		
	15 7/8"	59 7/8"	40"	152	27	FLV1660-40SMOL		\$2,553	\$2,810

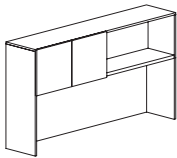

left shown

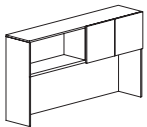

right

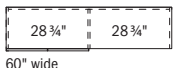
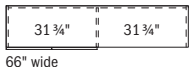
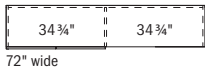
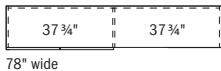

Features:

- use with primary height units, fastening hardware included
- laminate grain direction runs horizontal on back panel of overhead cabinets
- 1/4" overhang at the bottom of the door allows access
- 22 3/4" vertical clearance between worksurface and bottom of door, excluding task light
- two 5/8" dia. holes in upper corners of back panel for task light wiring access
- exterior back panel unfinished

Options:

- must specify chassis grain direction on artisan veneer, see pages 13-15 for details
- veneer door fronts in paint available, specify paint color and add \$354 list; see page 16 for details
- on laminate units, contrasting laminate door fronts available, no upcharge; specify laminate color, see page 16 for details
- white glass doors with aluminum trim available, specify and add \$1,279 list for 78"w, \$1,222 list for 72"w, \$1,175 list for 66"w or 60"w; see page 33 for details
- markerboard laminate doors available, specify and add \$405 list; see page 33 for details
- locking doors available, specify and add \$147 list (not available on glass doors)
- tackboard or markerboard available, see pages 292-295
- tasklights available, see page 455

Description	D	W	H	CTN WT	CU FT	① Model	Laminate	Essentials Veneer	Artisan Veneer
Storage Overhead Cabinet with Two Doors with Open Center	15 7/8	53 7/8	40	145	25	FLT1654-40SMO	\$1,525		
	15 7/8	53 7/8	40	145	25	FLV1654-40SMO		\$2,459	\$2,702
	15 7/8	47 7/8	40	133	22	FLT1648-40SMO	\$1,476		
	15 7/8	47 7/8	40	133	22	FLV1648-40SMO		\$2,373	\$2,612
	15 7/8	41 7/8	40	121	20	FLT1642-40SMO	\$1,427		
	15 7/8	41 7/8	40	121	20	FLV1642-40SMO		\$2,297	\$2,526

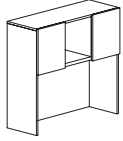

54" wide



48" wide



42" wide

Features:

- use with primary height units, fastening hardware included
- laminate grain direction runs horizontal on back panel of overhead cabinets
- 1/4" overhang at the bottom of the door allows access
- 22 3/4" vertical clearance between worksurface and bottom of door, excluding task light
- two 5/8" dia. holes in upper corners of back panel for task light wiring access
- exterior back panel unfinished

Options:

- must specify chassis grain direction on artisan veneer, see pages 13-15 for details
- veneer door fronts in paint available, specify paint color and add \$354 list; see page 16 for details
- on laminate units, contrasting laminate door fronts available, no upcharge; specify laminate color, see page 16 for details
- white glass doors with aluminum trim available, specify and add \$1,222 list for 54"w, \$1,175 list for 48"w or 42"w; see page 33 for details
- markerboard laminate doors available, specify and add \$405 list; see page 33 for details
- locking doors available, specify and add \$294 list (not available on glass doors)
- tackboard or markerboard available, see pages 292-295
- tasklights available, see page 455

To Order, Specify:

① Laminate Model #	② Laminate Selection	③ Metal Color	④ Other Product Options
Laminate (FLT)	See Laminate Selection	See Metal Finish Color Options	See list of options for each specific unit; Specify and add accordingly.

① Veneer Model #	② Wood Collection	③ Wood Finish	④ Metal Color	⑤ Other Product Options		
Veneer (FLV)	Essentials	See Essentials Wood Finish Options	See Metal Finish Color Options	See list of options for each specific unit; Specify and add accordingly.		
	Artisan	<table border="1"> <thead> <tr> <th>③a Wood Finish</th> <th>③b Chassis Grain Direction</th> </tr> </thead> <tbody> <tr> <td>See Artisan Wood Finish Options</td> <td>For Artisan Only: Vertical Horizontal</td> </tr> </tbody> </table>	③a Wood Finish		③b Chassis Grain Direction	See Artisan Wood Finish Options
③a Wood Finish	③b Chassis Grain Direction					
See Artisan Wood Finish Options	For Artisan Only: Vertical Horizontal					

Description	D	W	H	CTN WT	CU FT	① Model	Laminate	Essentials Veneer	Artisan Veneer
Storage Overhead Cabinet with Sliding Doors	15 15/16	95 7/8	40	232	43	FLT1696-40SD	\$2,649		
	15 15/16	95 7/8	40	232	43	FLV1696-40SD		\$4,340	\$4,774
	15 15/16	89 7/8	40	220	41	FLT1690-40SD	\$2,452		
	15 15/16	89 7/8	40	220	41	FLV1690-40SD		\$4,021	\$4,421
	15 15/16	83 7/8	40	209	38	FLT1684-40SD	\$2,259		
	15 15/16	83 7/8	40	209	38	FLV1684-40SD		\$3,700	\$4,070

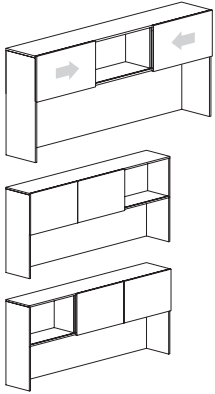

Features:

- use with primary height units, fastening hardware included
- laminate grain direction runs horizontal on back panel of overhead cabinets
- 22 3/4" vertical clearance between worksurface and bottom of door, excluding task light
- two 5/8" dia. holes in upper corners of back panel for task light wiring access
- exterior back panel unfinished
- locking not available

Options:

- must specify chassis grain direction on artisan veneer, see pages 13-15 for details
- veneer door fronts in paint available, specify paint color and add \$354 list; see page 16 for details
- on laminate units, contrasting laminate door fronts available, no upcharge; specify laminate color, see page 16 for details
- white glass doors with aluminum trim available, specify and add \$1,877 list for 96"w, \$1,800 list for 90"w, \$1,721 list for 84"w; see page 33 for details
- markerboard laminate doors available, specify and add \$598 list; see page 33 for details
- tackboard or markerboard available, see pages 292-295
- tasklights available, see page 455

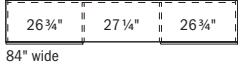
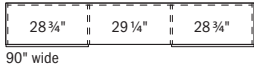
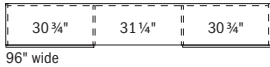

Storage Overhead Cabinet with Sliding Door	15 15/16	77 7/8	40	187	35	FLT1678-40SD	\$2,177		
	15 15/16	77 7/8	40	187	35	FLV1678-40SD		\$3,451	\$3,798
	15 15/16	71 7/8	40	175	33	FLT1672-40SD	\$2,053		
	15 15/16	71 7/8	40	175	33	FLV1672-40SD		\$3,254	\$3,583
	15 15/16	65 7/8	40	164	30	FLT1666-40SD	\$1,944		
	15 15/16	65 7/8	40	164	30	FLV1666-40SD		\$3,082	\$3,389
	15 15/16	59 7/8	40	153	27	FLT1660-40SD	\$1,861		
	15 15/16	59 7/8	40	153	27	FLV1660-40SD		\$2,948	\$3,243

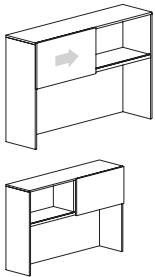

Features:

- use with primary height units, fastening hardware included
- laminate grain direction runs horizontal on back panel of overhead cabinets
- 22 3/4" vertical clearance between worksurface and bottom of door, excluding task light
- two 5/8" dia. holes in upper corners of back panel for task light wiring access
- exterior back panel unfinished
- locking not available

Options:

- must specify chassis grain direction on artisan veneer, see pages 13-15 for details
- veneer door fronts in paint available, specify paint color and add \$354 list; see page 16 for details
- on laminate units, contrasting laminate door fronts available, no upcharge; specify laminate color, see page 16 for details
- white glass doors with aluminum trim available, specify and add \$1,081 list for 78"w, \$1,020 list for 72"w, \$962 list for 66"w \$901 list for 60"w; see page 33 for details
- markerboard laminate doors available, specify and add \$301 list; see page 33 for details
- tackboard or markerboard available, see pages 292-295
- tasklights available, see page 455

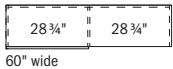
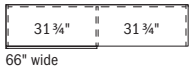
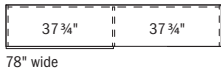

Description	D	W	H	CTN WT	CU FT	① Model	Laminate	Essentials Veneer	Artisan Veneer
Storage Overhead Cabinet with Sliding Door	15 15/16	53 7/8	40	141	25	FLT1654-40SD	\$1,820		
	15 15/16	53 7/8	40	141	25	FLV1654-40SD		\$2,838	\$3,122
	15 15/16	47 7/8	40	130	22	FLT1648-40SD	\$1,758		
	15 15/16	47 7/8	40	130	22	FLV1648-40SD		\$2,744	\$3,019
	15 15/16	41 7/8	40	119	20	FLT1642-40SD	\$1,705		
	15 15/16	41 7/8	40	119	20	FLV1642-40SD		\$2,659	\$2,927

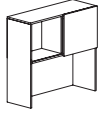
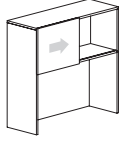

54" wide

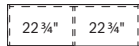

48" wide

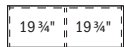

42" wide

Features:

- use with primary height units, fastening hardware included
- laminate grain direction runs horizontal on back panel of overhead cabinets
- 22 3/4" vertical clearance between worksurface and bottom of door, excluding task light
- two 5/8" dia. holes in upper corners of back panel for task light wiring access
- exterior back panel unfinished
- locking not available

Options:

- must specify chassis grain direction on artisan veneer, see pages 13-15 for details
- veneer door fronts in paint available, specify paint color and add \$354 list; see page 16 for details
- on laminate units, contrasting laminate door fronts available, no upcharge; specify laminate color, see page 16 for details
- white glass doors with aluminum trim available, specify and add \$844 list for 54"w, \$817 list for 48"w, \$786 list for 42"w; see page 33 for details
- markerboard laminate doors available, specify and add \$301 list; see page 33 for details
- tackboard or markerboard available, see pages 292-295
- tasklights available, see page 455

Storage Overhead Cabinet with Sliding Door	15 15/16	35 7/8	40	107	17	FLT1636-40SD	\$1,619		
	15 15/16	35 7/8	40	107	17	FLV1636-40SD		\$2,525	\$2,778
	15 15/16	29 7/8	40	96	14	FLT1630-40SD	\$1,553		
	15 15/16	29 7/8	40	96	14	FLV1630-40SD		\$2,423	\$2,665

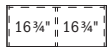
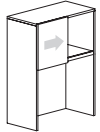

36" wide



30" wide

Features:

- use with primary height units, fastening hardware included
- laminate grain direction runs horizontal on back panel of overhead cabinets
- 22 3/4" vertical clearance between worksurface and bottom of door, excluding task light
- two 5/8" dia. holes in upper corners of back panel for task light wiring access
- exterior back panel unfinished
- locking not available

Options:

- must specify chassis grain direction on artisan veneer, see pages 13-15 for details
- veneer door fronts in paint available, specify paint color and add \$354 list; see page 16 for details
- on laminate units, contrasting laminate door fronts available, no upcharge; specify laminate color, see page 16 for details
- white glass doors with aluminum trim available, specify and add \$668 list for 36"w, \$638 list for 30"w; see page 33 for details
- markerboard laminate doors available, specify and add \$301 list; see page 33 for details
- tackboard or markerboard available, see pages 292-295
- tasklights available, see page 455

To Order, Specify:

① Laminate Model #	② Laminate Selection	③ Metal Color	④ Other Product Options
Laminate (FLT)	See Laminate Selection	See Metal Finish Color Options	See list of options for each specific unit; Specify and add accordingly.

① Veneer Model #	② Wood Collection	③ Wood Finish	④ Metal Color	⑤ Other Product Options		
Veneer (FLV)	Essentials	See Essentials Wood Finish Options	See Metal Finish Color Options	See list of options for each specific unit; Specify and add accordingly.		
	Artisan	<table border="1"> <thead> <tr> <th>ⓐ Wood Finish</th> <th>ⓑ Chassis Grain Direction</th> </tr> </thead> <tbody> <tr> <td>See Artisan Wood Finish Options</td> <td>For Artisan Only: Vertical Horizontal</td> </tr> </tbody> </table>	ⓐ Wood Finish		ⓑ Chassis Grain Direction	See Artisan Wood Finish Options
ⓐ Wood Finish	ⓑ Chassis Grain Direction					
See Artisan Wood Finish Options	For Artisan Only: Vertical Horizontal					

Description	D	W	H	CTN WT	CU FT	① Model	Laminate	Essentials Veneer	Artisan Veneer
Open Storage Overhead Cabinet	15	95%	40	199	41	FLT1596-4000	\$2,051		
	15	95%	40	199	41	FLV1596-4000		\$3,474	\$3,821
	15	89%	40	189	38	FLT1590-4000	\$1,926		
	15	89%	40	189	38	FLV1590-4000		\$3,263	\$3,588
	15	83%	40	179	36	FLT1584-4000	\$1,801		
	15	83%	40	179	36	FLV1584-4000		\$3,048	\$3,354

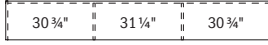
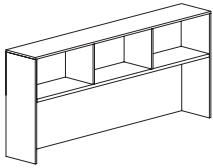

96" wide

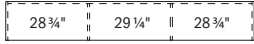

90" wide

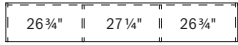

84" wide

Features:

- use with primary height units, fastening hardware included
- laminate grain direction runs horizontal on back panel of overhead cabinets
- 23" vertical clearance between worksurface and bottom of cabinet, excluding task light
- two 5/8" dia. holes in upper corners of back panel for task light wiring access
- exterior back panel unfinished

Options:

- must specify chassis grain direction on artisan veneer, see pages 13-15 for details
- tackboard or markerboard available, see pages 292-295
- tasklights available, see page 455

Open Storage Overhead Cabinet	15	77%	40	164	34	FLT1578-4000	\$1,678		
	15	77%	40	164	34	FLV1578-4000		\$2,746	\$3,022
	15	71%	40	154	31	FLT1572-4000	\$1,584		
	15	71%	40	154	31	FLV1572-4000		\$2,590	\$2,850
	15	65%	40	150	29	FLT1566-4000	\$1,495		
	15	65%	40	150	29	FLV1566-4000		\$2,446	\$2,692
	15	59%	40	139	26	FLT1560-4000	\$1,432		
	15	59%	40	139	26	FLV1560-4000		\$2,339	\$2,573

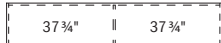
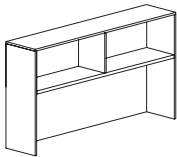

78" wide



72" wide



66" wide

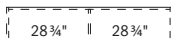

60" wide

Features:

- use with primary height units, fastening hardware included
- laminate grain direction runs horizontal on back panel of overhead cabinets
- 23" vertical clearance between worksurface and bottom of cabinet, excluding task light
- two 5/8" dia. holes in upper corners of back panel for task light wiring access
- exterior back panel unfinished

Options:

- must specify chassis grain direction on artisan veneer, see pages 13-15 for details
- tackboard or markerboard available, see pages 292-295
- tasklights available, see page 455

Description	D	W	H	CTN WT	CU FT	① Model	Laminate	Essentials Veneer	Artisan Veneer
Open Storage Overhead Cabinet	15	53 7/8	40	129	24	FLT1554-4000	\$1,397		
	15	53 7/8	40	129	24	FLV1554-4000		\$2,251	\$2,474
	15	47 7/8	40	118	21	FLT1548-4000	\$1,352		
	15	47 7/8	40	118	21	FLV1548-4000		\$2,173	\$2,390
	15	41 7/8	40	108	19	FLT1542-4000	\$1,308		
	15	41 7/8	40	108	19	FLV1542-4000		\$2,103	\$2,313

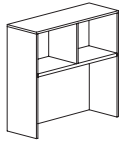

54" wide

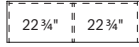

48" wide

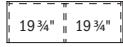

42" wide

Features:

- use with primary height units, fastening hardware included
- laminate grain direction runs horizontal on back panel of overhead cabinets
- 23" vertical clearance between worksurface and bottom of cabinet, excluding task light
- two 5/8" dia. holes in upper corners of back panel for task light wiring access
- exterior back panel unfinished

Options:

- must specify chassis grain direction on artisan veneer, see pages 13-15 for details
- tackboard or markerboard available, see pages 292-295
- tasklights available, see page 455

Open Storage Overhead Cabinet	15	35 7/8	40	90	16	FLT1536-4000	\$1,241		
	15	35 7/8	40	90	16	FLV1536-4000		\$1,992	\$2,192
	15	29 7/8	40	80	14	FLT1530-4000	\$1,188		
	15	29 7/8	40	80	14	FLV1530-4000		\$1,911	\$2,103

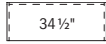
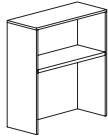

36" wide



30" wide

Features:

- use with primary height units, fastening hardware included
- laminate grain direction runs horizontal on back panel of overhead cabinets
- 23" vertical clearance between worksurface and bottom of cabinet, excluding task light
- two 5/8" dia. holes in upper corners of back panel for task light wiring access
- exterior back panel unfinished

Options:

- must specify chassis grain direction on artisan veneer, see pages 13-15 for details
- tackboard or markerboard available, see pages 292-295
- tasklights available, see page 455

To Order, Specify:

① Laminate Model #	② Laminate Selection	③ Metal Color	④ Other Product Options
Laminate (FLT)	See Laminate Selection	See Metal Finish Color Options	See list of options for each specific unit; Specify and add accordingly.

① Veneer Model #	② Wood Collection	③ Wood Finish	④ Metal Color	⑤ Other Product Options		
Veneer (FLV)	Essentials	See Essentials Wood Finish Options	See Metal Finish Color Options	See list of options for each specific unit; Specify and add accordingly.		
	Artisan	<table border="1"> <thead> <tr> <th>ⓐ Wood Finish</th> <th>ⓑ Chassis Grain Direction</th> </tr> </thead> <tbody> <tr> <td>See Artisan Wood Finish Options</td> <td>For Artisan Only: Vertical Horizontal</td> </tr> </tbody> </table>	ⓐ Wood Finish		ⓑ Chassis Grain Direction	See Artisan Wood Finish Options
ⓐ Wood Finish	ⓑ Chassis Grain Direction					
See Artisan Wood Finish Options	For Artisan Only: Vertical Horizontal					

Description	D	W	H	CTN WT	CU FT	① Model	List Price
Overhead Cabinet Markerboard Panel 	¹³ / ₁₆	94 ¼	22	57	5	FLB9523CMB	\$1,377
	¹³ / ₁₆	88 ¼	22	53	4	FLB8923CMB	\$1,291
	¹³ / ₁₆	82 ¼	22	69	6	FLB8323CMB	\$1,204
	¹³ / ₁₆	76 ¼	22	46	4	FLB7723CMB	\$1,116
	¹³ / ₁₆	70 ¼	22	42	4	FLB7123CMB	\$1,028
	¹³ / ₁₆	64 ¼	22	54	4	FLB6523CMB	\$940
	¹³ / ₁₆	58 ¼	22	35	3	FLB5923CMB	\$854
	¹³ / ₁₆	52 ¼	22	32	3	FLB5323CMB	\$766
	¹³ / ₁₆	46 ¼	22	28	3	FLB4723CMB	\$680
	¹³ / ₁₆	40 ¼	22	25	2	FLB4123CMB	\$591
	¹³ / ₁₆	34 ¼	22	21	2	FLB3523CMB	\$503
	¹³ / ₁₆	28 ¼	22	18	2	FLB2923CMB	\$417

Features:

- use with 40”h and 52”h overhead cabinets
- standard markerboard laminate with aluminum pvc edge
- attaches to cabinet interior, mounting hardware included

FLUX

Description	D	W	H	CTN WT	CU FT	① Model	List Price Per Grade	
96”w Tackboard for Overhead Cabinet 	¹³ / ₁₆	94 ¼	22	25	4	FLB9522TK	COM \$783	
								A \$913
								B \$939
								C \$1,016
								D \$1,125
								E \$1,224
								F \$1,335
								G \$1,468
								H \$1,663
								I \$1,723
								J \$1,890

Features:

- for use with 96” wide storage overhead cabinet
- use with 40”h and 52”h overhead cabinets
- attaches to cabinet interior, mounting hardware included
- com ydg: 3

90”w Tackboard for Overhead Cabinet 	¹³ / ₁₆	88 ¼	22	23	4	FLB8922TK	COM \$749	
								A \$868
								B \$893
								C \$963
								D \$1,062
								E \$1,153
								F \$1,256
								G \$1,378
								H \$1,557
								I \$1,611
								J \$1,765

Features:

- for use with 90”w storage overhead cabinet
- use with 40”h and 52”h overhead cabinets
- attaches to cabinet interior, mounting hardware included
- com ydg: 2 ¾

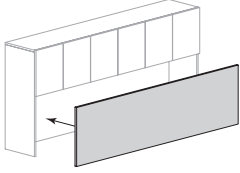
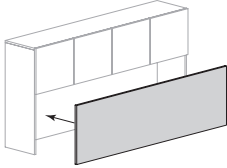
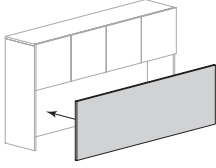
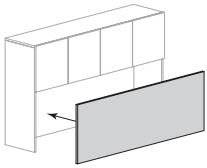
Description	D	W	H	CTN WT	CU FT	① Model	List Price Per Grade
84" w Tackboard for Overhead Cabinet 	13 1/16	82 1/4	22	22	4	FLB8322TK	COM \$716
							A \$824
78" w Tackboard for Overhead Cabinet 	13 1/16	76 1/4	22	20	4	FLB7722TK	COM \$681
							A \$789
72" w Tackboard for Overhead Cabinet 	13 1/16	70 1/4	22	19	3	FLB7122TK	COM \$648
							A \$746
66" w Tackboard for Overhead Cabinet 	13 1/16	64 1/4	22	17	3	FLB6522TK	COM \$614
							A \$700

Features:

- for use with 84" w storage overhead cabinet
- use with 40" h and 52" h overhead cabinets
- attaches to cabinet interior, mounting hardware included
- com ydg: 2 1/2

Features:

- for use with 78" w storage overhead cabinet
- use with 40" h and 52" h overhead cabinets
- attaches to cabinet interior, mounting hardware included
- com ydg: 2 1/2

Features:

- for use with 72" w storage overhead cabinet
- use with 40" h and 52" h overhead cabinets
- attaches to cabinet interior, mounting hardware included
- com ydg: 2 1/4

Features:

- for use with 66" w storage overhead cabinet
- use with 40" h and 52" h overhead cabinets
- attaches to cabinet interior, mounting hardware included
- com ydg: 2

To Order, Specify:

- ① Model Number
- ② Fabric Selection - vendor, pattern and color

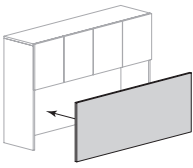
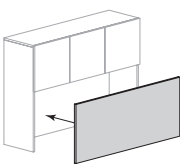
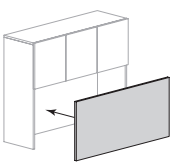
Description	D	W	H	CTN WT	CU FT	① Model	List Price Per Grade
60" w Tackboard for Overhead Cabinet 	13/16	58 1/4	22	15	3	FLB5922TK	COM \$580
							A \$667
							B \$685
							C \$736
							D \$808
							E \$874
							F \$949
							G \$1,037
							H \$1,168
							I \$1,208
J \$1,320							
54" w Tackboard for Overhead Cabinet 	13/16	52 1/4	22	14	3	FLB5322TK	COM \$546
							A \$622
							B \$638
							C \$683
							D \$746
							E \$804
							F \$869
							G \$946
							H \$1,061
							I \$1,096
J \$1,195							
48" w Tackboard for Overhead Cabinet 	13/16	46 1/4	22	12	2	FLB4722TK	COM \$511
							A \$576
							B \$589
							C \$628
							D \$682
							E \$731
							F \$787
							G \$854
							H \$952
							I \$983
J \$1,067							

Features:

- for use with 60" w storage overhead cabinet
- use with 40" h and 52" h overhead cabinets
- attaches to cabinet interior, mounting hardware included
- com ydg: 2

Features:

- for use with 54" w storage overhead cabinet
- use with 40" h and 52" h overhead cabinets
- attaches to cabinet interior, mounting hardware included
- com ydg: 1 3/4

Features:

- for use with 48" w storage overhead cabinet
- use with 40" h and 52" h overhead cabinets
- attaches to cabinet interior, mounting hardware included
- com ydg: 1 1/2

FLUX

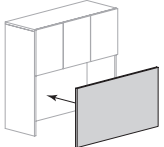
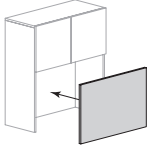
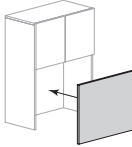
Description	D	W	H	CTN WT	CU FT	① Model	List Price Per Grade	
42" w Tackboard for Overhead Cabinet 	13 1/16	40 1/4	22	11	2	FLB4122TK	COM \$479	
	Features:							A \$544
	· for use with 42" w storage overhead cabinet							B \$558
	· use with 40" h and 52" h overhead cabinets							C \$596
	· attaches to cabinet interior, mounting hardware included							D \$650
	· com ydg: 1 1/2							E \$700
								F \$756
								G \$822
								H \$920
								I \$951
								J \$1,035
	36" w Tackboard for Overhead Cabinet 	13 1/16	34 1/4	22	9	2	FLB3522TK	COM \$445
		Features:						
· for use with 36" w storage overhead cabinet							B \$510	
· use with 40" h and 52" h overhead cabinets							C \$542	
· attaches to cabinet interior, mounting hardware included							D \$587	
· com ydg: 1 1/4							E \$628	
							F \$675	
							G \$730	
							H \$813	
							I \$838	
							J \$909	
30" w Tackboard Overhead Cabinet 		13 1/16	28 1/4	22	8	2	FLB2922TK	COM \$410
		Features:						
	· for use with 30" w storage overhead cabinet							B \$462
	· use with 40" h and 52" h overhead cabinets							C \$488
	· attaches to cabinet interior, mounting hardware included							D \$524
	· com ydg: 1							E \$557
								F \$594
								G \$639
								H \$705
								I \$726
								J \$783

FLUX

To Order, Specify:

- ① Model Number
- ② Fabric Selection - vendor, pattern and color

Description	D	W	H	CTN WT	CU FT	① Model	Laminate	Essentials Veneer	Artisan Veneer
Storage Overhead Cabinet with Four Doors	15 $\frac{7}{8}$ "	95 $\frac{7}{8}$ "	48	254	51	FLT1696-48SO	\$2,439		
	15 $\frac{7}{8}$ "	95 $\frac{7}{8}$ "	48	254	51	FLV1696-48SO		\$4,130	\$4,544
	15 $\frac{7}{8}$ "	89 $\frac{7}{8}$ "	48	241	48	FLT1690-48SO	\$2,292		
	15 $\frac{7}{8}$ "	89 $\frac{7}{8}$ "	48	241	48	FLV1690-48SO		\$3,881	\$4,269
	15 $\frac{7}{8}$ "	83 $\frac{7}{8}$ "	48	228	45	FLT1684-48SO	\$2,141		
	15 $\frac{7}{8}$ "	83 $\frac{7}{8}$ "	48	228	45	FLV1684-48SO		\$3,625	\$3,985

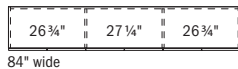
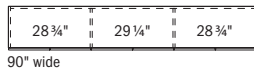
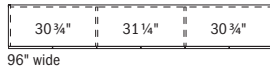
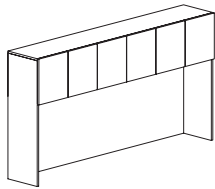

Features:

- use with secondary height units, fastening hardware included
- laminate grain direction runs horizontal on back panel of overhead cabinets
- 1/4" overhang at the bottom of the door allows access
- 30 $\frac{3}{4}$ " vertical clearance between worksurface and bottom of door, excluding task light
- two 5/8" dia. holes in upper corners of back panel for task light wiring access
- exterior back panel unfinished

Options:

- must specify chassis grain direction on artisan veneer, see pages 13-15 for details
- veneer door fronts in paint available, specify paint color and add \$354 list; see page 16 for details
- on laminate units, contrasting laminate door fronts available, no upcharge; specify laminate color, see page 16 for details
- white glass doors with aluminum trim available, specify and add \$3,516 list; see page 33 for details
- markerboard laminate doors available, specify and add \$1,202 list; see page 33 for details
- locking doors available, specify and add \$441 list (not available on glass doors)
- tackboard or markerboard available, see pages 306-309
- tasklights available, see page 455

Description	D	W	H	CTN WT	CU FT	① Model	Laminate	Essentials Veneer	Artisan Veneer
Storage Overhead Cabinet with Four Doors	15 7/8	77 7/8	48	220	42	FLT1678-48SO	\$1,993		
	15 7/8	77 7/8	48	220	42	FLV1678-48SO		\$3,268	\$3,595
	15 7/8	71 7/8	48	197	39	FLT1672-48SO	\$1,879		
	15 7/8	71 7/8	48	197	39	FLV1672-48SO		\$3,080	\$3,387
	15 7/8	65 7/8	48	189	36	FLT1666-48SO	\$1,777		
	15 7/8	65 7/8	48	189	36	FLV1666-48SO		\$2,907	\$3,201
	15 7/8	59 7/8	48	175	33	FLT1660-48SO	\$1,700		
	15 7/8	59 7/8	48	175	33	FLV1660-48SO		\$2,780	\$3,057

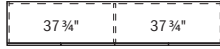
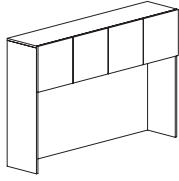

78" wide

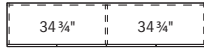

72" wide



66" wide



60" wide

Features:

- use with secondary height units, fastening hardware included
- laminate grain direction runs horizontal on back panel of overhead cabinets
- 1/4" overhang at the bottom of the door allows access
- 30 3/4" vertical clearance between worksurface and bottom of door, excluding task light
- two 5/8" dia. holes in upper corners of back panel for task light wiring access
- exterior back panel unfinished

Options:

- must specify chassis grain direction on artisan veneer, see pages 13-15 for details
- veneer door fronts in paint available, specify paint color and add \$354 list; see page 16 for details
- on laminate units, contrasting laminate door fronts available, no upcharge; specify laminate color, see page 16 for details
- white glass doors with aluminum trim available, specify and add \$2,555 list for 78"w, \$2,438 list for 72"w, \$2,346 list for 66"w or 60"w; see page 33 for details
- markerboard laminate doors available, specify and add \$802 list; see page 33 for details
- locking doors available, specify and add \$294 list (not available on glass doors)
- tackboard or markerboard available, see pages 306-309
- tasklights available, see page 455

To Order, Specify:

① Laminate Model #	② Laminate Selection	③ Metal Color	④ Other Product Options
Laminate (FLT)	See Laminate Selection	See Metal Finish Color Options	See list of options for each specific unit; Specify and add accordingly.

① Veneer Model #	② Wood Collection	③ Wood Finish	④ Metal Color	⑤ Other Product Options		
Veneer (FLV)	Essentials	See Essentials Wood Finish Options	See Metal Finish Color Options	See list of options for each specific unit; Specify and add accordingly.		
	Artisan	<table border="1"> <thead> <tr> <th>③a Wood Finish</th> <th>③b Chassis Grain Direction</th> </tr> </thead> <tbody> <tr> <td>See Artisan Wood Finish Options</td> <td>For Artisan Only: Vertical Horizontal</td> </tr> </tbody> </table>	③a Wood Finish		③b Chassis Grain Direction	See Artisan Wood Finish Options
③a Wood Finish	③b Chassis Grain Direction					
See Artisan Wood Finish Options	For Artisan Only: Vertical Horizontal					

Description	D	W	H	CTN WT	CU FT	① Model	Laminate	Essentials Veneer	Artisan Veneer
Storage Overhead Cabinet with Three Doors	15 $\frac{7}{8}$ "	53 $\frac{7}{8}$ "	48	162	29	FLT1654-48SOR	\$1,661		
	15 $\frac{7}{8}$ "	53 $\frac{7}{8}$ "	48	162	29	FLV1654-48SOR		\$2,676	\$2,944
	15 $\frac{7}{8}$ "	53 $\frac{7}{8}$ "	48	162	29	FLT1654-48SOL	\$1,661		
	15 $\frac{7}{8}$ "	53 $\frac{7}{8}$ "	48	162	29	FLV1654-48SOL		\$2,676	\$2,944
	15 $\frac{7}{8}$ "	47 $\frac{7}{8}$ "	48	148	26	FLT1648-48SOR	\$1,605		
	15 $\frac{7}{8}$ "	47 $\frac{7}{8}$ "	48	148	26	FLV1648-48SOR		\$2,582	\$2,842
	15 $\frac{7}{8}$ "	47 $\frac{7}{8}$ "	48	148	26	FLT1648-48SOL	\$1,605		
	15 $\frac{7}{8}$ "	47 $\frac{7}{8}$ "	48	148	26	FLV1648-48SOL		\$2,582	\$2,842
	15 $\frac{7}{8}$ "	41 $\frac{7}{8}$ "	48	134	23	FLT1642-48SOR	\$1,553		
	15 $\frac{7}{8}$ "	41 $\frac{7}{8}$ "	48	134	23	FLV1642-48SOR		\$2,504	\$2,753
	15 $\frac{7}{8}$ "	41 $\frac{7}{8}$ "	48	134	23	FLT1642-48SOL	\$1,553		
	15 $\frac{7}{8}$ "	41 $\frac{7}{8}$ "	48	134	23	FLV1642-48SOL		\$2,504	\$2,753

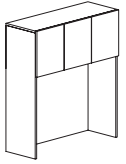

right shown

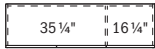

54" wide

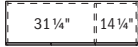

48" wide

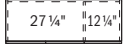

42" wide

Features:

- use with secondary height units, fastening hardware included
- laminate grain direction runs horizontal on back panel of overhead cabinets
- 1/4" overhang at the bottom of the door allows access
- 30 3/4" vertical clearance between worksurface and bottom of door, excluding task light
- two 5/8" dia. holes in upper corners of back panel for task light wiring access
- exterior back panel unfinished

Options:

- must specify chassis grain direction on artisan veneer, see pages 13-15 for details
- veneer door fronts in paint available, specify paint color and add \$354 list; see page 16 for details
- on laminate units, contrasting laminate door fronts available, no upcharge; specify laminate color, see page 16 for details
- white glass doors with aluminum trim available, specify and add \$1,830 list for 54"w, \$1,759 list for 48"w or 42"w; see page 33 for details
- markerboard laminate doors available, specify and add \$603 list; see page 33 for details
- locking doors available, specify and add \$294 list (not available on glass doors)
- tackboard or markerboard available, see pages 306-309
- tasklights available, see page 455

Description	D	W	H	CTN WT	CU FT	① Model	Laminate	Essentials Veneer	Artisan Veneer
Storage Overhead Cabinet with Two Doors	15 7/8	35 7/8	48	113	20	FLT1636-48SO	\$1,475		
	15 7/8	35 7/8	48	113	20	FLV1636-48SO		\$2,372	\$2,611
	15 7/8	29 7/8	48	100	17	FLT1630-48SO	\$1,412		
	15 7/8	29 7/8	48	100	17	FLV1630-48SO		\$2,273	\$2,497

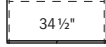
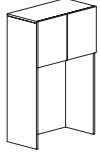

36" wide



30" wide

Features:

- use with secondary height units, fastening hardware included
- laminate grain direction runs horizontal on back panel of overhead cabinets
- 1/4" overhang at the bottom of the door allows access
- 30 3/4" vertical clearance between worksurface and bottom of door, excluding task light
- two 5/8" dia. holes in upper corners of back panel for task lighting wiring access
- exterior back panel unfinished

Options:

- must specify chassis grain direction on artisan veneer, see pages 13-15 for details
- veneer door fronts in paint available, specify paint color and add \$354 list; see page 16 for details
- on laminate units, contrasting laminate door fronts available, no upcharge; specify laminate color, see page 16 for details
- white glass doors with aluminum trim available, specify and add \$1,222 list for 36"w, \$1,175 list for 30"w; see page 33 for details
- markerboard laminate doors available, specify and add \$405 list; see page 33 for details
- locking doors available, specify and add \$147 list (not available on glass doors)
- tackboard or markerboard available, see pages 306-309
- tasklights available, see page 455

FLUX

To Order, Specify:

① Laminate Model #	② Laminate Selection	③ Metal Color	④ Other Product Options
Laminate (FLT)	See Laminate Selection	See Metal Finish Color Options	See list of options for each specific unit; Specify and add accordingly.

① Veneer Model #	② Wood Collection	③ Wood Finish	④ Metal Color	⑤ Other Product Options		
Veneer (FLV)	Essentials	See Essentials Wood Finish Options	See Metal Finish Color Options	See list of options for each specific unit; Specify and add accordingly.		
	Artisan	<table border="1"> <thead> <tr> <th>③a Wood Finish</th> <th>③b Chassis Grain Direction</th> </tr> </thead> <tbody> <tr> <td>See Artisan Wood Finish Options</td> <td>For Artisan Only: Vertical Horizontal</td> </tr> </tbody> </table>	③a Wood Finish		③b Chassis Grain Direction	See Artisan Wood Finish Options
③a Wood Finish	③b Chassis Grain Direction					
See Artisan Wood Finish Options	For Artisan Only: Vertical Horizontal					

Description	D	W	H	CTN WT	CU FT	Model	Laminate	Essentials Veneer	Artisan Veneer
Storage Overhead Cabinet with Four Doors with Open Center	15 7/8"	95 7/8"	48"	242	51	FLT1696-48SMO	\$2,319		
	15 7/8"	95 7/8"	48"	242	51	FLV1696-48SMO		\$3,929	\$4,320
	15 7/8"	89 7/8"	48"	230	48	FLT1690-48SMO	\$2,147		
	15 7/8"	89 7/8"	48"	230	48	FLV1690-48SMO		\$3,635	\$3,999
	15 7/8"	83 7/8"	48"	217	45	FLT1684-48SMO	\$1,976		
	15 7/8"	83 7/8"	48"	217	45	FLV1684-48SMO		\$3,342	\$3,677

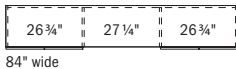
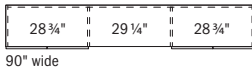
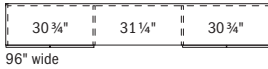
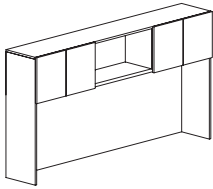

Features:

- use with secondary height units, fastening hardware included
- laminate grain direction runs horizontal on back panel of overhead cabinets
- 1/4" overhang at the bottom of the door allows access
- 30 3/4" vertical clearance between worksurface and bottom of door, excluding task light
- two 5/8" dia. holes in upper corners of back panel for task light wiring access
- exterior back panel unfinished

Options:

- must specify chassis grain direction on artisan veneer, see pages 13-15 for details
- veneer door fronts in paint available, specify paint color and add \$354 list; see page 16 for details
- on laminate units, contrasting laminate door fronts available, no upcharge; specify laminate color, see page 16 for details
- white glass doors with aluminum trim available, specify and add \$2,346 list; see page 33 for details
- markerboard laminate doors available, specify and add \$802 list; see page 33 for details
- locking doors available, specify and add \$294 list (not available on glass doors)
- tackboard or markerboard available, see pages 306-309
- tasklights available, see page 455

Storage Overhead Cabinet with Two Doors with Open Compartment	15 7/8"	77 7/8"	48"	196	42	FLT1678-48SMOR	\$1,900		
	15 7/8"	77 7/8"	48"	196	42	FLV1678-48SMOR		\$3,110	\$3,420
	15 7/8"	77 7/8"	48"	196	42	FLT1678-48SMOL	\$1,900		
	15 7/8"	77 7/8"	48"	196	42	FLV1678-48SMOL		\$3,110	\$3,420
	15 7/8"	71 7/8"	48"	184	39	FLT1672-48SMOR	\$1,789		
	15 7/8"	71 7/8"	48"	184	39	FLV1672-48SMOR		\$2,931	\$3,223
	15 7/8"	71 7/8"	48"	184	39	FLT1672-48SMOL	\$1,789		
	15 7/8"	71 7/8"	48"	184	39	FLV1672-48SMOL		\$2,931	\$3,223
	15 7/8"	65 7/8"	48"	177	36	FLT1666-48SMOR	\$1,693		
	15 7/8"	65 7/8"	48"	177	36	FLV1666-48SMOR		\$2,770	\$3,048
	15 7/8"	65 7/8"	48"	177	36	FLT1666-48SMOL	\$1,693		
	15 7/8"	65 7/8"	48"	177	36	FLV1666-48SMOL		\$2,770	\$3,048
	15 7/8"	59 7/8"	48"	164	33	FLT1660-48SMOR	\$1,617		
	15 7/8"	59 7/8"	48"	164	33	FLV1660-48SMOR		\$2,646	\$2,910
	15 7/8"	59 7/8"	48"	164	33	FLT1660-48SMOL	\$1,617		
	15 7/8"	59 7/8"	48"	164	33	FLV1660-48SMOL		\$2,646	\$2,910

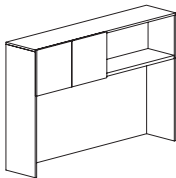

left shown

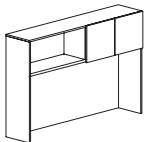

right

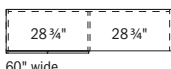
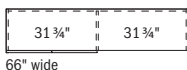
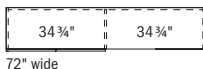
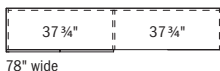

Features:

- use with secondary height units, fastening hardware included
- laminate grain direction runs horizontal on back panel of overhead cabinets
- 1/4" overhang at the bottom of the door allows access
- 30 3/4" vertical clearance between worksurface and bottom of door, excluding task light
- two 5/8" dia. holes in upper corners of back panel for task light wiring access
- exterior back panel unfinished

Options:

- must specify chassis grain direction on artisan veneer, see pages 13-15 for details
- veneer door fronts in paint available, specify paint color and add \$354 list; see page 16 for details
- on laminate units, contrasting laminate door fronts available, no upcharge; specify laminate color, see page 16 for details
- white glass doors with aluminum trim available, specify and add \$1,279 list for 78"w, \$1,222 list for 72"w, \$1,175 list for 66"w or 60"w; see page 33 for details
- markerboard laminate doors available, specify and add \$405 list; see page 33 for details
- locking doors available, specify and add \$147 list (not available on glass doors)
- tackboard or markerboard available, see pages 306-309
- tasklights available, see page 455

Description	D	W	H	CTN WT	CU FT	① Model	Laminate	Essentials Veneer	Artisan Veneer
Storage Overhead Cabinet with Two Doors with Open Center	15 7/8	53 7/8	48	159	29	FLT1654-48SMO	\$1,910		
	15 7/8	53 7/8	48	159	29	FLV1654-48SMO		\$2,893	\$3,179
	15 7/8	47 7/8	48	146	26	FLT1648-48SMO	\$1,846		
	15 7/8	47 7/8	48	146	26	FLV1648-48SMO		\$2,797	\$3,078
	15 7/8	41 7/8	48	133	23	FLT1642-48SMO	\$1,789		
	15 7/8	41 7/8	48	133	23	FLV1642-48SMO		\$2,709	\$2,980

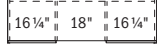
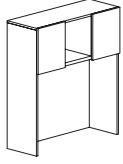

54" wide



48" wide



42" wide

Features:

- use with secondary height units, fastening hardware included
- laminate grain direction runs horizontal on back panel of overhead cabinets
- 1/4" overhang at the bottom of the door allows access
- 30 3/4" vertical clearance between worksurface and bottom of door, excluding task light
- two 5/8" dia. holes in upper corners of back panel for task light wiring access
- exterior back panel unfinished

Options:

- must specify chassis grain direction on artisan veneer, see pages 13-15 for details
- veneer door fronts in paint available, specify paint color and add \$354 list; see page 16 for details
- on laminate units, contrasting laminate door fronts available, no upcharge; specify laminate color, see page 16 for details
- white glass doors with aluminum trim available, specify and add \$1,222 list for 54"w, \$1,175 list for 48"w or 42"w; see page 33 for details
- markerboard laminate doors available, specify and add \$405 list; see page 33 for details
- locking doors available, specify and add \$294 list (not available on glass doors)
- tackboard or markerboard available, see pages 306-309
- tasklights available, see page 455

To Order, Specify:

① Laminate Model #	② Laminate Selection	③ Metal Color	④ Other Product Options
Laminate (FLT)	See Laminate Selection	See Metal Finish Color Options	See list of options for each specific unit; Specify and add accordingly.

① Veneer Model #	② Wood Collection	③ Wood Finish	④ Metal Color	⑤ Other Product Options		
Veneer (FLV)	Essentials	See Essentials Wood Finish Options	See Metal Finish Color Options	See list of options for each specific unit; Specify and add accordingly.		
	Artisan	<table border="1"> <thead> <tr> <th>③a Wood Finish</th> <th>③b Chassis Grain Direction</th> </tr> </thead> <tbody> <tr> <td>See Artisan Wood Finish Options</td> <td>For Artisan Only: Vertical Horizontal</td> </tr> </tbody> </table>	③a Wood Finish		③b Chassis Grain Direction	See Artisan Wood Finish Options
③a Wood Finish	③b Chassis Grain Direction					
See Artisan Wood Finish Options	For Artisan Only: Vertical Horizontal					

Description	D	W	H	CTN WT	CU FT	Model	Laminate	Essentials Veneer	Artisan Veneer
Storage Overhead Cabinet with Sliding Door	15 15/16	95 7/8	48	251	51	FLT1696-48SD	\$2,733		
	15 15/16	95 7/8	48	251	51	FLV1696-48SD		\$4,478	\$4,927
	15 15/16	89 7/8	48	239	48	FLT1690-48SD	\$2,534		
	15 15/16	89 7/8	48	239	48	FLV1690-48SD		\$4,152	\$4,568
	15 15/16	83 7/8	48	226	45	FLT1684-48SD	\$2,333		
	15 15/16	83 7/8	48	226	45	FLV1684-48SD		\$3,821	\$4,204

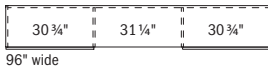
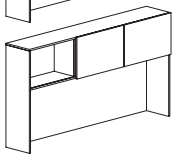
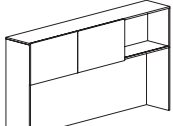
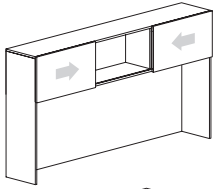

96" wide

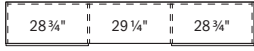

90" wide

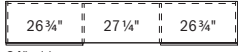

84" wide

Features:

- use with secondary height units, fastening hardware included
- laminate grain direction runs horizontal on back panel of overhead cabinets
- 30 3/4" vertical clearance between worksurface and bottom of door, excluding task light
- two 5/8" dia. holes in upper corners of back panel for task light wiring access
- exterior back panel unfinished
- locking not available

Options:

- must specify chassis grain direction on artisan veneer, see pages 13-15 for details
- veneer door fronts in paint available, specify paint color and add \$354 list; see page 16 for details
- on laminate units, contrasting laminate door fronts available, no upcharge; specify laminate color, see page 16 for details
- white glass doors with aluminum trim available, specify and add \$1,877 list for 96"w, \$1,800 list for 90"w, \$1,721 list for 84"w; see page 33 for details
- markerboard laminate doors available, specify and add \$598 list; see page 33 for details
- tackboard or markerboard available, see pages 306-309
- tasklights available, see page 455

Storage Overhead Cabinet with Sliding Door	15 15/16	77 7/8	48	203	42	FLT1678-48SD	\$2,245		
	15 15/16	77 7/8	48	203	42	FLV1678-48SD		\$3,561	\$3,917
	15 15/16	71 7/8	48	190	39	FLT1672-48SD	\$2,117		
	15 15/16	71 7/8	48	190	39	FLV1672-48SD		\$3,362	\$3,696
	15 15/16	65 7/8	48	178	36	FLT1666-48SD	\$2,005		
	15 15/16	65 7/8	48	178	36	FLV1666-48SD		\$3,179	\$3,498
Storage Overhead Cabinet with Sliding Door	15 15/16	59 7/8	48	166	33	FLT1660-48SD	\$1,917		
	15 15/16	59 7/8	48	166	33	FLV1660-48SD		\$3,041	\$3,346

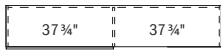
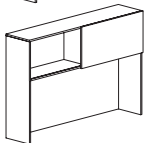
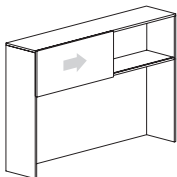

78" wide

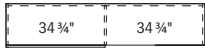

72" wide

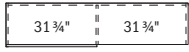

66" wide

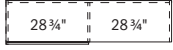

60" wide

Features:

- use with secondary height units, fastening hardware included
- laminate grain direction runs horizontal on back panel of overhead cabinets
- 30 3/4" vertical clearance between worksurface and bottom of door, excluding task light
- two 5/8" dia. holes in upper corners of back panel for task light wiring access
- exterior back panel unfinished
- locking not available

Options:

- must specify chassis grain direction on artisan veneer, see pages 13-15 for details
- veneer door fronts in paint available, specify paint color and add \$354 list; see page 16 for details
- on laminate units, contrasting laminate door fronts available, no upcharge; specify laminate color, see page 16 for details
- white glass doors with aluminum trim available, specify and add \$1,081 list for 78"w, \$1,020 list for 72"w, \$962 list for 66"w \$901 list for 60"w; see page 33 for details
- markerboard laminate doors available, specify and add \$301 list; see page 33 for details
- tackboard or markerboard available, see pages 306-309
- tasklights available, see page 455

Description	D	W	H	CTN WT	CU FT	① Model	Laminate	Essentials Veneer	Artisan Veneer
Storage Overhead Cabinet with Sliding Door	15 15/16	53 7/8	48	153	30	FLT1654-48SD	\$1,875		
	15 15/16	53 7/8	48	153	30	FLV1654-48SD		\$2,930	\$3,221
	15 15/16	47 7/8	48	141	26	FLT1648-48SD	\$1,815		
	15 15/16	47 7/8	48	141	26	FLV1648-48SD		\$2,831	\$3,116
	15 15/16	41 7/8	48	128	23	FLT1642-48SD	\$1,757		
	15 15/16	41 7/8	48	128	23	FLV1642-48SD		\$2,745	\$3,020

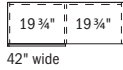
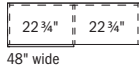
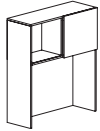
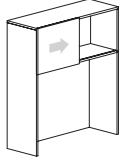

Features:

- use with secondary height units, fastening hardware included
- laminate grain direction runs horizontal on back panel of overhead cabinets
- 30 3/4" vertical clearance between worksurface and bottom of door, excluding task light
- two 5/8" dia. holes in upper corners of back panel for task light wiring access
- exterior back panel unfinished
- locking not available

Options:

- must specify chassis grain direction on artisan veneer, see pages 13-15 for details
- veneer door fronts in paint available, specify paint color and add \$354 list; see page 16 for details
- on laminate units, contrasting laminate door fronts available, no upcharge; specify laminate color, see page 16 for details
- white glass doors with aluminum trim available, specify and add \$844 list for 54"w, \$786 list for 48"w, \$817 list for 42"w; see page 33 for details
- markerboard laminate doors available, specify and add \$301 list; see page 33 for details
- tackboard or markerboard available, see pages 306-309
- tasklights available, see page 455

Storage Overhead Cabinet with Sliding Door	15 15/16	35 7/8	48	116	20	FLT1636-48SD	\$1,669		
	15 15/16	35 7/8	48	116	20	FLV1636-48SD		\$2,604	\$2,864
	15 15/16	29 7/8	48	104	17	FLT1630-48SD	\$1,602		
	15 15/16	29 7/8	48	104	17	FLV1630-48SD		\$2,497	\$2,747

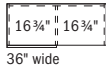
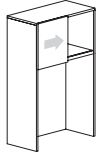

Features:

- use with secondary height units, fastening hardware included
- laminate grain direction runs horizontal on back panel of overhead cabinets
- 30 3/4" vertical clearance between worksurface and bottom of door, excluding task light
- two 5/8" dia. holes in upper corners of back panel for task light wiring access
- exterior back panel unfinished
- locking not available

Options:

- must specify chassis grain direction on artisan veneer, see pages 13-15 for details
- veneer door fronts in paint available, specify paint color and add \$354 list; see page 16 for details
- on laminate units, contrasting laminate door fronts available, no upcharge; specify laminate color, see page 16 for details
- white glass doors with aluminum trim available, specify and add \$668 list for 36"w, \$638 list for 30"w; see page 33 for details
- markerboard laminate doors available, specify and add \$301 list; see page 33 for details
- tackboard or markerboard available, see pages 306-309
- tasklights available, see page 455

To Order, Specify:

① Laminate Model #	② Laminate Selection	③ Metal Color	④ Other Product Options
Laminate (FLT)	See Laminate Selection	See Metal Finish Color Options	See list of options for each specific unit; Specify and add accordingly.

① Veneer Model #	② Wood Collection	③ Wood Finish	④ Metal Color	⑤ Other Product Options		
Veneer (FLV)	Essentials	See Essentials Wood Finish Options	See Metal Finish Color Options	See list of options for each specific unit; Specify and add accordingly.		
	Artisan	<table border="1"> <thead> <tr> <th>③a Wood Finish</th> <th>③b Chassis Grain Direction</th> </tr> </thead> <tbody> <tr> <td>See Artisan Wood Finish Options</td> <td>For Artisan Only: Vertical Horizontal</td> </tr> </tbody> </table>	③a Wood Finish		③b Chassis Grain Direction	See Artisan Wood Finish Options
③a Wood Finish	③b Chassis Grain Direction					
See Artisan Wood Finish Options	For Artisan Only: Vertical Horizontal					

Description	D	W	H	CTN WT	CU FT	① Model	Laminate	Essentials Veneer	Artisan Veneer
Open Storage Overhead Cabinet	15	95%	48	218	49	FLT1596-4800	\$2,135		
	15	95%	48	218	49	FLV1596-4800		\$3,612	\$3,975
	15	89%	48	207	46	FLT1590-4800	\$2,006		
	15	89%	48	207	46	FLV1590-4800		\$3,392	\$3,732
	15	83%	48	196	43	FLT1584-4800	\$1,874		
	15	83%	48	196	43	FLV1584-4800		\$3,169	\$3,486

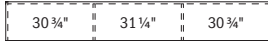
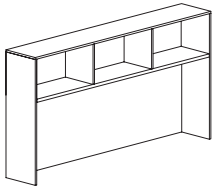

96" wide

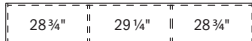

90" wide

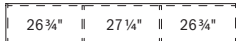

84" wide

Features:

- use with secondary height units, fastening hardware included
- laminate grain direction runs horizontal on back panel of overhead cabinets
- 31" vertical clearance between worksurface and bottom of cabinet, excluding task light
- two 5/8" dia. holes in upper corners of back panel for task light wiring access
- exterior back panel unfinished

Options:

- must specify chassis grain direction on artisan veneer, see pages 13-15 for details
- tackboard or markerboard available, see pages 306-309
- tasklights available, see page 455

Description	D	W	H	CTN WT	CU FT	① Model	Laminate	Essentials Veneer	Artisan Veneer
Open Storage Overhead Cabinet	15	77%	48	180	40	FLT1578-4800	\$1,747		
	15	77%	48	180	40	FLV1578-4800		\$2,856	\$3,143
	15	71%	48	169	37	FLT1572-4800	\$1,645		
	15	71%	48	169	37	FLV1572-4800		\$2,694	\$2,964
	15	65%	48	163	34	FLT1566-4800	\$1,554		
	15	65%	48	163	34	FLV1566-4800		\$2,546	\$2,801
	15	59%	48	152	31	FLT1560-4800	\$1,486		
	15	59%	48	152	31	FLV1560-4800		\$2,432	\$2,676

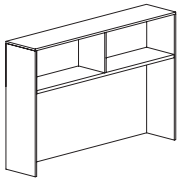

78" wide



72" wide



66" wide



60" wide

Features:

- use with secondary height units, fastening hardware included
- laminate grain direction runs horizontal on back panel of overhead cabinets
- 31" vertical clearance between worksurface and bottom of cabinet, excluding task light
- two 5/8" dia. holes in upper corners of back panel for task light wiring access
- exterior back panel unfinished

Options:

- must specify chassis grain direction on artisan veneer, see pages 13-15 for details
- tackboard or markerboard available, see pages 306-309
- tasklights available, see page 455

FLUX

Description	D	W	H	CTN WT	CU FT	① Model	Laminate	Essentials Veneer	Artisan Veneer
Open Storage Overhead Cabinet	15	53 7/8	48	140	28	FLT1554-4800	\$1,453		
	15	53 7/8	48	140	28	FLV1554-4800		\$2,341	\$2,574
	15	47 7/8	48	129	25	FLT1548-4800	\$1,405		
	15	47 7/8	48	129	25	FLV1548-4800		\$2,261	\$2,489
	15	41 7/8	48	117	22	FLT1542-4800	\$1,360		
	15	41 7/8	48	117	22	FLV1542-4800		\$2,189	\$2,407

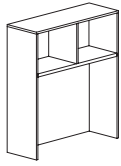

54" wide

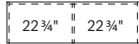

48" wide

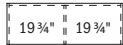

42" wide

Features:

- use with secondary height units, fastening hardware included
- laminate grain direction runs horizontal on back panel of overhead cabinets
- 31" vertical clearance between worksurface and bottom of cabinet, excluding task light
- two 5/8" dia. holes in upper corners of back panel for task light wiring access
- exterior back panel unfinished

Options:

- must specify chassis grain direction on artisan veneer, see pages 13-15 for details
- tackboard or markerboard available, see pages 306-309
- tasklights available, see page 455

Open Storage Overhead Cabinet	15	35 7/8	48	99	19	FLT1536-4800	\$1,289		
	15	35 7/8	48	99	19	FLV1536-4800		\$2,075	\$2,281
	15	29 7/8	48	88	16	FLT1530-4800	\$1,236		
	15	29 7/8	48	88	16	FLV1530-4800		\$1,987	\$2,187

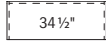
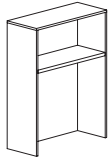

36" wide



30" wide

Features:

- use with secondary height units, fastening hardware included
- laminate grain direction runs horizontal on back panel of overhead cabinets
- 31" vertical clearance between worksurface and bottom of cabinet, excluding task light
- two 5/8" dia. holes in upper corners of back panel for task light wiring access
- exterior back panel unfinished

Options:

- must specify chassis grain direction on artisan veneer, see pages 13-15 for details
- tackboard or markerboard available, see pages 306-309
- tasklights available, see page 455

To Order, Specify:

① Laminate Model #	② Laminate Selection	③ Metal Color	④ Other Product Options
Laminate (FLT)	See Laminate Selection	See Metal Finish Color Options	See list of options for each specific unit; Specify and add accordingly.

① Veneer Model #	② Wood Collection	③ Wood Finish	④ Metal Color	⑤ Other Product Options		
Veneer (FLV)	Essentials	See Essentials Wood Finish Options	See Metal Finish Color Options	See list of options for each specific unit; Specify and add accordingly.		
	Artisan	<table border="1"> <thead> <tr> <th>③a Wood Finish</th> <th>③b Chassis Grain Direction</th> </tr> </thead> <tbody> <tr> <td>See Artisan Wood Finish Options</td> <td>For Artisan Only: Vertical Horizontal</td> </tr> </tbody> </table>	③a Wood Finish		③b Chassis Grain Direction	See Artisan Wood Finish Options
③a Wood Finish	③b Chassis Grain Direction					
See Artisan Wood Finish Options	For Artisan Only: Vertical Horizontal					

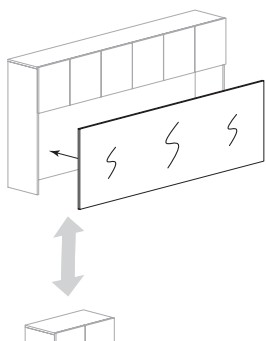
Description	D	W	H	CTN WT	CU FT	① Model	List Price
Overhead Cabinet Markerboard Panel 	13/16	94 1/4	30	76	6	FLB9531CMB	\$1,877
	13/16	88 1/4	30	71	6	FLB8931CMB	\$1,758
	13/16	82 1/4	30	67	5	FLB8331CMB	\$1,640
	13/16	76 1/4	30	62	5	FLB7731CMB	\$1,520
	13/16	70 1/4	30	57	5	FLB7131CMB	\$1,403
	13/16	64 1/4	30	52	4	FLB6531CMB	\$1,281
	13/16	58 1/4	30	47	4	FLB5931CMB	\$1,162
	13/16	52 1/4	30	43	4	FLB5331CMB	\$1,045
	13/16	46 1/4	30	38	3	FLB4731CMB	\$926
	13/16	40 1/4	30	33	3	FLB4131CMB	\$806
	13/16	34 1/4	30	28	3	FLB3531CMB	\$684
	13/16	28 1/4	30	24	2	FLB2931CMB	\$567

- Features:**
- use with 48”h overhead cabinets
 - standard markerboard laminate with aluminum pvc edge
 - attaches to cabinet interior, mounting hardware included

FLUX

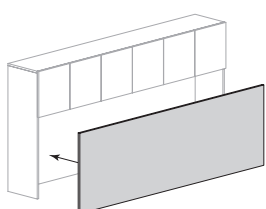
Description	D	W	H	CTN WT	CU FT	① Model	List Price Per Grade
96”w Tackboard for Overhead Cabinet 	13/16	94 1/4	30	33	6	FLB9530TK	COM \$976
							A \$1,106
							B \$1,133
							C \$1,210
							D \$1,318
							E \$1,417
							F \$1,529
							G \$1,662
							H \$1,858
							I \$1,919
							J \$2,088

- Features:**
- for use with 96” wide storage overhead cabinet
 - use with 48”h overhead cabinets
 - attaches to cabinet interior, mounting hardware included
 - com ydg: 3

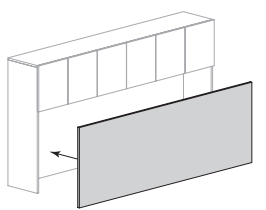
96”w Tackboard for Overhead Cabinet 	13/16	88 1/4	30	31	5	FLB8930TK	COM \$931
							A \$1,050
							B \$1,074
							C \$1,145
							D \$1,244
							E \$1,335
							F \$1,437
							G \$1,559
							H \$1,740
							I \$1,796
							J \$1,951

- Features:**
- for use with 90”w storage overhead cabinet
 - use with 48”h overhead cabinets
 - attaches to cabinet interior, mounting hardware included
 - com ydg: 2 3/4

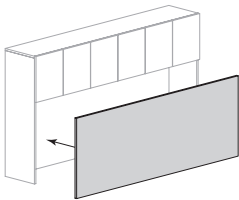
Description	D	W	H	CTN WT	CU FT	① Model	List Price Per Grade	
84" w Tackboard for Overhead Cabinet 	13 1/16	82 1/4	30	29	5	FLB8330TK	COM \$886	
							A \$994	
Features: <ul style="list-style-type: none"> · for use with 84" w storage overhead cabinet · use with 48" h overhead cabinets · attaches to cabinet interior, mounting hardware included · com ydg: 2 1/2 	<td>B \$1,016</td>							B \$1,016
	<td>C \$1,080</td>							C \$1,080
	<td>D \$1,171</td>							D \$1,171
	<td>E \$1,253</td>							E \$1,253
	<td>F \$1,346</td>							F \$1,346
	<td>G \$1,457</td>							G \$1,457
	<td>H \$1,622</td>							H \$1,622
	<td>I \$1,673</td>							I \$1,673
	<td>J \$1,814</td>							J \$1,814

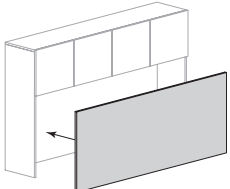
78" w Tackboard for Overhead Cabinet 	13 1/16	76 1/4	30	27	5	FLB7730TK	COM \$837	
							A \$946	
Features: <ul style="list-style-type: none"> · for use with 78" w storage overhead cabinet · use with 48" h overhead cabinets · attaches to cabinet interior, mounting hardware included · com ydg: 2 1/2 	<td>B \$968</td>							B \$968
	<td>C \$1,032</td>							C \$1,032
	<td>D \$1,122</td>							D \$1,122
	<td>E \$1,205</td>							E \$1,205
	<td>F \$1,298</td>							F \$1,298
	<td>G \$1,409</td>							G \$1,409
	<td>H \$1,573</td>							H \$1,573
	<td>I \$1,624</td>							I \$1,624
	<td>J \$1,765</td>							J \$1,765

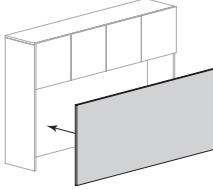
72" w Tackboard for Overhead Cabinet 	13 1/16	70 1/4	30	25	4	FLB7130TK	COM \$792	
							A \$890	
Features: <ul style="list-style-type: none"> · for use with 72" w storage overhead cabinet · use with 48" h overhead cabinets · attaches to cabinet interior, mounting hardware included · com ydg: 2 1/4 	<td>B \$910</td>							B \$910
	<td>C \$967</td>							C \$967
	<td>D \$1,049</td>							D \$1,049
	<td>E \$1,123</td>							E \$1,123
	<td>F \$1,207</td>							F \$1,207
	<td>G \$1,306</td>							G \$1,306
	<td>H \$1,454</td>							H \$1,454
	<td>I \$1,501</td>							I \$1,501
	<td>J \$1,628</td>							J \$1,628

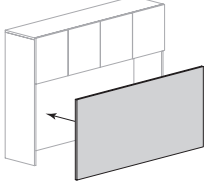
66" w Tackboard for Overhead Cabinet 	13 1/16	64 1/4	30	23	4	FLB6530TK	COM \$746	
							A \$833	
Features: <ul style="list-style-type: none"> · for use with 66" w storage overhead cabinet · use with 48" h overhead cabinets · attaches to cabinet interior, mounting hardware included · com ydg: 2 	<td>B \$850</td>							B \$850
	<td>C \$902</td>							C \$902
	<td>D \$974</td>							D \$974
	<td>E \$1,040</td>							E \$1,040
	<td>F \$1,114</td>							F \$1,114
	<td>G \$1,203</td>							G \$1,203
	<td>H \$1,335</td>							H \$1,335
	<td>I \$1,376</td>							I \$1,376
	<td>J \$1,490</td>							J \$1,490

To Order, Specify:

- ① Model Number
- ② Fabric Selection - vendor, pattern and color

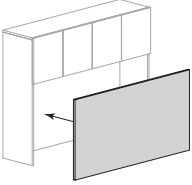
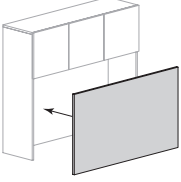
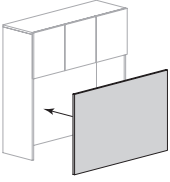
Description	D	W	H	CTN WT	CU FT	① Model	List Price Per Grade
60" w Tackboard for Overhead Cabinet 	$1\frac{3}{16}$	58 $\frac{1}{4}$	30	21	4	FLB5930TK	COM \$701
	Features: <ul style="list-style-type: none"> · for use with 60" w storage overhead cabinet · use with 48" h overhead cabinets · attaches to cabinet interior, mounting hardware included · com ydg: 2 						
54" w Tackboard for Overhead Cabinet 	$1\frac{3}{16}$	52 $\frac{1}{4}$	30	19	3	FLB5330TK	COM \$653
	Features: <ul style="list-style-type: none"> · for use with 54" w storage overhead cabinet · use with 48" h overhead cabinets · attaches to cabinet interior, mounting hardware included · com ydg: 1 $\frac{3}{4}$ 						
48" w Tackboard for Overhead Cabinet 	$1\frac{3}{16}$	46 $\frac{1}{4}$	30	17	3	FLB4730TK	COM \$607
	Features: <ul style="list-style-type: none"> · for use with 48" w storage overhead cabinet · use with 48" h overhead cabinets · attaches to cabinet interior, mounting hardware included · com ydg: 1 $\frac{1}{2}$ 						

FLUX

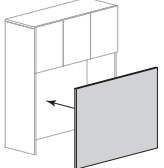
Description	D	W	H	CTN WT	CU FT	① Model	List Price Per Grade
42" w Tackboard for Overhead Cabinet  <p>Features:</p> <ul style="list-style-type: none"> · for use with 42" w storage overhead cabinet · use with 48" h overhead cabinets · attaches to cabinet interior, mounting hardware included · com ydg: 1 ½ 	13/16	40 ¼	30	15	3	FLB4130TK	COM \$562 A \$627 B \$641 C \$679 D \$733 E \$783 F \$839 G \$905 H \$1,004 I \$1,035 J \$1,120

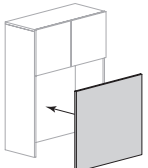
36" w Tackboard for Overhead Cabinet  <p>Features:</p> <ul style="list-style-type: none"> · for use with 36" w storage overhead cabinet · use with 48" h overhead cabinets · attaches to cabinet interior, mounting hardware included · com ydg: 1 ¼ 	13/16	34 ¼	30	12	2	FLB3530TK	COM \$514 A \$568 B \$579 C \$611 D \$656 E \$698 F \$744 G \$800 H \$883 I \$909 J \$980
--	-------	------	----	----	---	-----------	--

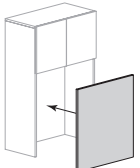
30" w Tackboard for Overhead Cabinet  <p>Features:</p> <ul style="list-style-type: none"> · for use with 30" w storage overhead cabinet · use with 48" h overhead cabinets · attaches to cabinet interior, mounting hardware included · com ydg: 1 	13/16	28 ¼	30	10	2	FLB2930TK	COM \$467 A \$510 B \$519 C \$545 D \$581 E \$614 F \$651 G \$695 H \$762 I \$784 J \$841
--	-------	------	----	----	---	-----------	--

To Order, Specify:

- ① Model Number
- ② Fabric Selection - vendor, pattern and color

FLUX

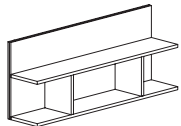
Description	D	W	H	CTN WT	CU FT	① Model	Laminate	Essentials Veneer	Artisan Veneer
	15	96	29	174	30	FLT1596-29WMS	\$1,584		
	15	96	29	174	30	FLV1596-29WMS		\$2,432	\$2,676
	15	90	29	164	29	FLT1590-29WMS	\$1,507		
	15	90	29	164	29	FLV1590-29WMS		\$2,316	\$2,550
	15	84	29	154	27	FLT1584-29WMS	\$1,447		
	15	84	29	154	27	FLV1584-29WMS		\$2,223	\$2,447
	15	78	29	144	25	FLT1578-29WMS	\$1,390		
	15	78	29	144	25	FLV1578-29WMS		\$2,136	\$2,349
	15	72	29	135	23	FLT1572-29WMS	\$1,139		
	15	72	29	135	23	FLV1572-29WMS		\$1,751	\$1,923
	15	66	29	125	21	FLT1566-29WMS	\$1,094		
	15	66	29	125	21	FLV1566-29WMS		\$1,679	\$1,846
	15	60	29	115	19	FLT1560-29WMS	\$1,049		
	15	60	29	115	19	FLV1560-29WMS		\$1,612	\$1,775
	15	54	29	105	18	FLT1554-29WMS	\$1,008		
	15	54	29	105	18	FLV1554-29WMS		\$1,549	\$1,705
	15	48	29	95	16	FLT1548-29WMS	\$970		
	15	48	29	95	16	FLV1548-29WMS		\$1,486	\$1,635
	15	42	29	85	14	FLT1542-29WMS	\$930		
	15	42	29	85	14	FLV1542-29WMS		\$1,430	\$1,570

Features:

- supported by wall cleat - hardware provided by installer
- laminate grain direction runs horizontal on back panel of shelf

Options:

- must specify chassis grain direction on artisan veneer, see pages 13-15 for details

Description	D	W	H	CTN WT	CU FT	① Model	Laminate	Essentials Veneer	Artisan Veneer
Double Height Wall Mount Overhead Shelf	15	36	29	70	12	FLT1536-29WMS	\$830		
	15	36	29	70	12	FLV1536-29WMS		\$1,274	\$1,401
	15	30	29	60	10	FLT1530-29WMS	\$796		
	15	30	29	60	10	FLV1530-29WMS		\$1,224	\$1,347

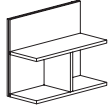

Features:

- supported by wall cleat - hardware provided by installer
- laminate grain direction runs horizontal on back panel of shelf

Options:

- must specify chassis grain direction on artisan veneer, see pages 13-15 for details

FLUX

To Order, Specify:

① Laminate Model #	② Laminate Selection	③ Metal Color	④ Other Product Options
Laminate (FLT)	See Laminate Selection	See Metal Finish Color Options	See list of options for each specific unit; Specify and add accordingly.

① Veneer Model #	② Wood Collection	③ Wood Finish	④ Metal Color	⑤ Other Product Options	
Veneer (FLV)	Essentials	See Essentials Wood Finish Options	See Metal Finish Color Options	See list of options for each specific unit; Specify and add accordingly.	
	Artisan	<table border="1"> <thead> <tr> <th>③a Wood Finish</th> <th>③b Chassis Grain Direction</th> </tr> </thead> <tbody> <tr> <td>See Artisan Wood Finish Options</td> <td>For Artisan Only: Vertical Horizontal</td> </tr> </tbody> </table>			③a Wood Finish
③a Wood Finish	③b Chassis Grain Direction				
See Artisan Wood Finish Options	For Artisan Only: Vertical Horizontal				

Description	D	W	H	CTN WT	CU FT	Model	Laminate	Essentials Veneer	Artisan Veneer
Wall Mount Double Height Overhead with Six Doors	15 7/8	96	29 1/4	284	32	FLT1696-29WSO	\$2,512		
	15 7/8	96	29 1/4	284	32	FLV1696-29WSO		\$4,721	\$5,195
	15 7/8	90	29 1/4	269	30	FLT1690-29WSO	\$2,378		
	15 7/8	90	29 1/4	269	30	FLV1690-29WSO		\$4,428	\$4,872
	15 7/8	84	29 1/4	253	28	FLT1684-29WSO	\$2,252		
	15 7/8	84	29 1/4	253	28	FLV1684-29WSO		\$4,131	\$4,545

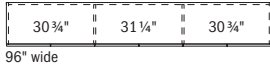
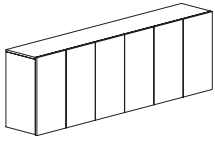

96" wide



90" wide

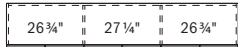

84" wide

Features:

- supported by wall cleat - hardware provided by installer
- secure wall attachment required; pilot holes provided in back panel
- laminate grain direction runs horizontal on back panel of overhead cabinets
- 1/4" overhang at the bottom of the door allows access
- adjustable shelves

Options:

- must specify chassis grain direction on artisan veneer, see pages 13-15 for details
- veneer door fronts in paint available, specify paint color and add \$354 list; see page 16 for details
- on laminate units, contrasting laminate door fronts available, no upcharge; specify laminate color, see page 16 for details
- white glass doors with aluminum trim available, specify and add \$4,713 list for 96"w, \$4,514 list for 90"w, \$4,344 list for 84"w; see page 33 for details
- markerboard laminate doors available, specify and add \$1,202 list; see page 33 for details
- locking doors available, specify and add \$441 list (not available on glass doors)

Wall Mount Double Height Overhead with Four Doors	15 7/8	78	29 1/4	230	26	FLT1678-29WSO	\$2,203		
	15 7/8	78	29 1/4	230	26	FLV1678-29WSO		\$3,839	\$4,224
	15 7/8	72	29 1/4	215	24	FLT1672-29WSO	\$2,085		
	15 7/8	72	29 1/4	215	24	FLV1672-29WSO		\$3,544	\$3,898
	15 7/8	66	29 1/4	199	22	FLT1666-29WSO	\$1,973		
	15 7/8	66	29 1/4	199	22	FLV1666-29WSO		\$3,388	\$3,728
	15 7/8	60	29 1/4	190	21	FLT1660-29WSO	\$1,883		
	15 7/8	60	29 1/4	190	21	FLV1660-29WSO		\$3,223	\$3,546

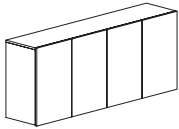

78" wide



72" wide

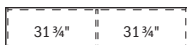

66" wide

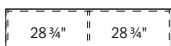



60" wide

Features:

- supported by wall cleat - hardware provided by installer
- secure wall attachment required; pilot holes provided in back panel
- laminate grain direction runs horizontal on back panel of overhead cabinets
- 1/4" overhang at the bottom of the door allows access
- adjustable shelves

Options:

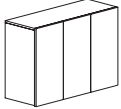
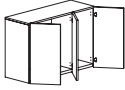
- must specify chassis grain direction on artisan veneer, see pages 13-15 for details
- veneer door fronts in paint available, specify paint color and add \$354 list; see page 16 for details
- on laminate units, contrasting laminate door fronts available, no upcharge; specify laminate color, see page 16 for details
- white glass doors with aluminum trim available, specify and add \$3,609 list for 78"w, \$3,410 list for 72"w, \$3,211 list for 66"w, \$3,013 list for 60"w; see page 33 for details
- markerboard laminate doors available, specify and add \$802 list; see page 33 for details
- locking doors available, specify and add \$294 list (not available on glass doors)

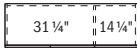
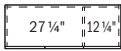

Description	D	W	H	CTN WT	CU FT	① Model	Laminate	Essentials Veneer	Artisan Veneer
Wall Mount Double Height Overhead with Three Doors   right shown  54" wide  48" wide  42" wide	15 7/8	54	29 1/4	173	19	FLT1654-29WSOR	\$1,770		
	15 7/8	54	29 1/4	173	19	FLV1654-29WSOR		\$2,906	\$3,199
	15 7/8	54	29 1/4	173	19	FLT1654-29WSOL	\$1,770		
	15 7/8	54	29 1/4	173	19	FLV1654-29WSOL		\$2,906	\$3,199
	15 7/8	48	29 1/4	157	17	FLT1648-29WSOR	\$1,518		
	15 7/8	48	29 1/4	157	17	FLV1648-29WSOR		\$2,546	\$2,801
	15 7/8	48	29 1/4	157	17	FLT1648-29WSOL	\$1,518		
	15 7/8	48	29 1/4	157	17	FLV1648-29WSOL		\$2,546	\$2,801
	15 7/8	42	29 1/4	141	15	FLT1642-29WSOR	\$1,441		
	15 7/8	42	29 1/4	141	15	FLV1642-29WSOR		\$2,336	\$2,570
	15 7/8	42	29 1/4	141	15	FLT1642-29WSOL	\$1,441		
	15 7/8	42	29 1/4	141	15	FLV1642-29WSOL		\$2,336	\$2,570

Features:

- supported by wall cleat - hardware provided by installer
- secure wall attachment required; pilot holes provided in back panel
- laminate grain direction runs horizontal on back panel of overhead cabinets
- 1/4" overhang at the bottom of the door allows access
- adjustable shelves

Options:

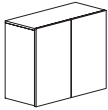
- must specify chassis grain direction on artisan veneer, see pages 13-15 for details
- veneer door fronts in paint available, specify paint color and add \$354 list; see page 16 for details
- on laminate units, contrasting laminate door fronts available, no upcharge; specify laminate color, see page 16 for details
- white glass doors with aluminum trim available, specify and add \$2,558 list for 54"w, \$2,359 list for 48"w, \$2,161 list for 42"w; see page 33 for details
- markerboard laminate doors available, specify and add \$603 list; see page 33 for details
- locking doors available, specify and add \$294 list (not available on glass doors)

Wall Mount Double Height Overhead with Two Doors   36" wide  30" wide	15 7/8	36	29 1/4	114	13	FLT1636-29WSO	\$1,254		
	15 7/8	36	29 1/4	114	13	FLV1636-29WSO		\$2,190	\$2,409
	15 7/8	30	29 1/4	99	11	FLT1630-29WSO	\$1,194		
	15 7/8	30	29 1/4	99	11	FLV1630-29WSO		\$2,086	\$2,297

Features:

- supported by wall cleat - hardware provided by installer
- secure wall attachment required; pilot holes provided in back panel
- laminate grain direction runs horizontal on back panel of overhead cabinets
- 1/4" overhang at the bottom of the door allows access
- adjustable shelves

Options:

- must specify chassis grain direction on artisan veneer, see pages 13-15 for details
- veneer door fronts in paint available, specify paint color and add \$354 list; see page 16 for details
- on laminate units, contrasting laminate door fronts available, no upcharge; specify laminate color, see page 16 for details
- white glass doors with aluminum trim available, specify and add \$1,708 list for 36"w, \$1,509 list for 30"w; see page 33 for details
- markerboard laminate doors available, specify and add \$405 list; see page 33 for details
- locking doors available, specify and add \$147 list (not available on glass doors)

To Order, Specify:

① Laminate Model #	② Laminate Selection	③ Metal Color	④ Other Product Options
Laminate (FLT)	See Laminate Selection	See Metal Finish Color Options	See list of options for each specific unit; Specify and add accordingly.

① Veneer Model #	② Wood Collection	③ Wood Finish	④ Metal Color	⑤ Other Product Options		
Veneer (FLV)	Essentials	See Essentials Wood Finish Options	See Metal Finish Color Options	See list of options for each specific unit; Specify and add accordingly.		
	Artisan	<table border="1"> <thead> <tr> <th>ⓐ Wood Finish</th> <th>ⓑ Chassis Grain Direction</th> </tr> </thead> <tbody> <tr> <td>See Artisan Wood Finish Options</td> <td>For Artisan Only: Vertical Horizontal</td> </tr> </tbody> </table>	ⓐ Wood Finish		ⓑ Chassis Grain Direction	See Artisan Wood Finish Options
ⓐ Wood Finish	ⓑ Chassis Grain Direction					
See Artisan Wood Finish Options	For Artisan Only: Vertical Horizontal					

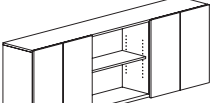
Description	D	W	H	CTN WT	CU FT	Model	Laminate	Essentials Veneer	Artisan Veneer
Wall Mount Double Height Overhead with Four Doors and Open Center 	15 7/8	96	29 1/4	264	32	FLT1696-29WSMO	\$2,490		
	15 7/8	96	29 1/4	264	32	FLV1696-29WSMO		\$4,077	\$4,483
	15 7/8	90	29 1/4	250	30	FLT1690-29WSMO	\$2,343		
	15 7/8	90	29 1/4	250	30	FLV1690-29WSMO		\$3,832	\$4,216
	15 7/8	84	29 1/4	236	28	FLT1684-29WSMO	\$2,190		
	15 7/8	84	29 1/4	236	28	FLV1684-29WSMO		\$3,587	\$3,946

Features:

- supported by wall cleat - hardware provided by installer
- secure wall attachment required; pilot holes provided in back panel
- laminate grain direction runs horizontal on back panel of overhead cabinets
- 1/4" overhang at the bottom of the door allows access
- adjustable shelves

Options:

- must specify chassis grain direction on artisan veneer, see pages 13-15 for details
- veneer door fronts in paint available, specify paint color and add \$354 list; see page 16 for details
- on laminate units, contrasting laminate door fronts available, no upcharge; specify laminate color, see page 16 for details
- white glass doors with aluminum trim available, specify and add \$3,145 list for 96"w, \$3,013 list for 90"w, \$2,881 list for 84"w; see page 33 for details
- markerboard laminate doors available, specify and add \$802 list; see page 33 for details
- locking doors available, specify and add \$294 list (not available on glass doors)

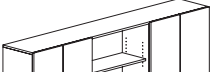
Wall Mount Double Height Overhead Cabinet with Four Doors, Open Center and Cubbies 	15 7/8	96	29 1/4	275	32	FLT1696-29WSMOCC	\$2,620		
	15 7/8	96	29 1/4	275	32	FLV1696-29WSMOCC		\$4,262	\$4,689
	15 7/8	90	29 1/4	260	30	FLT1690-29WSMOCC	\$2,471		
	15 7/8	90	29 1/4	260	30	FLV1690-29WSMOCC		\$4,021	\$4,421
	15 7/8	84	29 1/4	245	28	FLT1684-29WSMOCC	\$2,319		
	15 7/8	84	29 1/4	245	28	FLV1684-29WSMOCC		\$3,773	\$4,152

Features:

- supported by wall cleat - hardware provided by installer
- secure wall attachment required; pilot holes provided in back panel
- laminate grain direction runs horizontal on back panel of overhead cabinets
- 1/4" overhang at the bottom of the door allows access
- adjustable shelves

Options:

- must specify chassis grain direction on artisan veneer, see pages 13-15 for details
- veneer door fronts in paint available, specify paint color and add \$354 list; see page 16 for details
- on laminate units, contrasting laminate door fronts available, no upcharge; specify laminate color, see page 16 for details
- white glass doors with aluminum trim available, specify and add \$3,145 list for 96"w, \$3,013 list for 90"w, \$2,881 list for 84"w; see page 33 for details
- markerboard laminate doors available, specify and add \$802 list; see page 33 for details
- locking doors available, specify and add \$294 list (not available on glass doors)

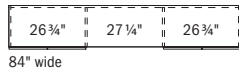
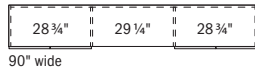
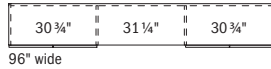

Description	D	W	H	CTN WT	CU FT	① Model	Laminate	Essentials Veneer	Artisan Veneer
Wall Mount Double Height Overhead Cabinet with Two Doors, Open Center and Cubbies	15 7/8	78	29 1/4	226	26	FLT1678-29WSMOCC	\$2,175		
	15 7/8	78	29 1/4	226	26	FLV1678-29WSMOCC		\$3,429	\$3,771
	15 7/8	72	29 1/4	211	24	FLT1672-29WSMOCC	\$2,057		
	15 7/8	72	29 1/4	211	24	FLV1672-29WSMOCC		\$3,245	\$3,569
	15 7/8	66	29 1/4	197	22	FLT1666-29WSMOCC	\$1,956		
	15 7/8	66	29 1/4	197	22	FLV1666-29WSMOCC		\$3,082	\$3,389
	15 7/8	60	29 1/4	187	21	FLT1660-29WSMOCC	\$1,878		
	15 7/8	60	29 1/4	187	21	FLV1660-29WSMOCC		\$2,961	\$3,254

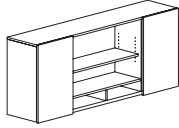

Features:

- supported by wall cleat - hardware provided by installer
- secure wall attachment required; pilot holes provided in back panel
- laminate grain direction runs horizontal on back panel of overhead cabinets
- 1/4" overhang at the bottom of the door allows access
- adjustable shelves

Options:

- must specify chassis grain direction on artisan veneer, see pages 13-15 for details
- veneer door fronts in paint available, specify paint color and add \$354 list; see page 16 for details
- on laminate units, contrasting laminate door fronts available, no upcharge; specify laminate color, see page 16 for details
- white glass doors with aluminum trim available, specify and add \$1,806 list for 78" w, \$1,708 list for 72" w, \$1,608 list for 66" w, \$1,509 list for 60" w; see page 33 for details
- markerboard laminate doors available, specify and add \$405 list; see page 33 for details
- locking doors available, specify and add \$294 list (not available on glass doors)

Wall Mount Double Height Overhead Cabinet with 2 Doors, Open Center and Cubbies	15 7/8	54	29 1/4	174	19	FLT1654-29WSMOCC	\$1,839		
	15 7/8	54	29 1/4	174	19	FLV1654-29WSMOCC		\$2,854	\$3,139
	15 7/8	48	29 1/4	159	17	FLT1648-29WSMOCC	\$1,784		
	15 7/8	48	29 1/4	159	17	FLV1648-29WSMOCC		\$2,768	\$3,044
	15 7/8	42	29 1/4	143	15	FLT1642-29WSMOCC	\$1,731		
	15 7/8	42	29 1/4	143	15	FLV1642-29WSMOCC		\$2,688	\$2,956

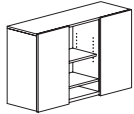

54" wide

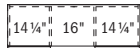

48" wide



42" wide

Features:

- supported by wall cleat - hardware provided by installer
- secure wall attachment required; pilot holes provided in back panel
- laminate grain direction runs horizontal on back panel of overhead cabinets
- 1/4" overhang at the bottom of the door allows access
- adjustable shelves

Options:

- must specify chassis grain direction on artisan veneer, see pages 13-15 for details
- veneer door fronts in paint available, specify paint color and add \$354 list; see page 16 for details
- on laminate units, contrasting laminate door fronts available, no upcharge; specify laminate color, see page 16 for details
- white glass doors with aluminum trim available, specify and add \$1,708 list for 54" w, \$1,574 list for 48" w, \$1,441 list for 42" w; see page 33 for details
- markerboard laminate doors available, specify and add \$405 list; see page 33 for details
- locking doors available, specify and add \$294 list (not available on glass doors)

To Order, Specify:

① Laminate Model #	② Laminate Selection	③ Metal Color	④ Other Product Options
Laminate (FLT)	See Laminate Selection	See Metal Finish Color Options	See list of options for each specific unit; Specify and add accordingly.

① Veneer Model #	② Wood Collection	③ Wood Finish	④ Metal Color	⑤ Other Product Options		
Veneer (FLV)	Essentials	See Essentials Wood Finish Options	See Metal Finish Color Options	See list of options for each specific unit; Specify and add accordingly.		
	Artisan	<table border="1"> <thead> <tr> <th>ⓐ Wood Finish</th> <th>ⓑ Chassis Grain Direction</th> </tr> </thead> <tbody> <tr> <td>See Artisan Wood Finish Options</td> <td>For Artisan Only: Vertical Horizontal</td> </tr> </tbody> </table>	ⓐ Wood Finish		ⓑ Chassis Grain Direction	See Artisan Wood Finish Options
ⓐ Wood Finish	ⓑ Chassis Grain Direction					
See Artisan Wood Finish Options	For Artisan Only: Vertical Horizontal					

Description	D	W	H	CTN WT	CU FT	① Model	Laminate	Essentials Veneer	Artisan Veneer
Wall Mount Double Height Overhead with Two Doors and Open Compartment	15 7/8	78	29 1/4	206	26	FLT1678-29WSMOR	\$2,046		
	15 7/8	78	29 1/4	206	26	FLV1678-29WSMOR		\$3,242	\$3,565
	15 7/8	78	29 1/4	206	26	FLT1678-29WSMOL	\$2,046		
	15 7/8	78	29 1/4	206	26	FLV1678-29WSMOL		\$3,242	\$3,565
	15 7/8	72	29 1/4	192	24	FLT1672-29WSMOR	\$1,928		
	15 7/8	72	29 1/4	192	24	FLV1672-29WSMOR		\$3,057	\$3,364
	15 7/8	72	29 1/4	192	24	FLT1672-29WSMOL	\$1,928		
	15 7/8	72	29 1/4	192	24	FLV1672-29WSMOL		\$3,057	\$3,364
	15 7/8	66	29 1/4	179	22	FLT1666-29WSMOR	\$1,827		
	15 7/8	66	29 1/4	179	22	FLV1666-29WSMOR		\$2,896	\$3,185
	15 7/8	66	29 1/4	179	22	FLT1666-29WSMOL	\$1,827		
	15 7/8	66	29 1/4	179	22	FLV1666-29WSMOL		\$2,896	\$3,185
	15 7/8	60	29 1/4	170	21	FLT1660-29WSMOR	\$1,751		
	15 7/8	60	29 1/4	170	21	FLV1660-29WSMOR		\$2,774	\$3,051
	15 7/8	60	29 1/4	170	21	FLT1660-29WSMOL	\$1,751		
	15 7/8	60	29 1/4	170	21	FLV1660-29WSMOL		\$2,774	\$3,051

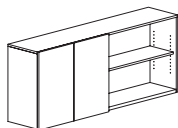

left shown

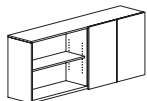

right

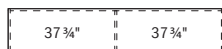

78" wide

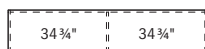

72" wide

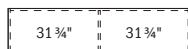

66" wide

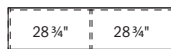

60" wide

Features:

- supported by wall cleat - hardware provided by installer
- secure wall attachment required; pilot holes provided in back panel
- laminate grain direction runs horizontal on back panel of overhead cabinets
- 1/4" overhang at the bottom of the door allows access
- adjustable shelves

Options:

- must specify chassis grain direction on artisan veneer, see pages 13-15 for details
- veneer door fronts in paint available, specify paint color and add \$354 list; see page 16 for details
- on laminate units, contrasting laminate door fronts available, no upcharge; specify laminate color, see page 16 for details
- white glass doors with aluminum trim available, specify and add \$1,806 list for 78"w, \$1,708 list for 72"w, \$1,608 list for 66"w, \$1,509 list for 60"w; see page 33 for details
- markerboard laminate doors available, specify and add \$405 list; see page 33 for details
- locking doors available, specify and add \$147 list (not available on glass doors)

Description	D	W	H	CTN WT	CU FT	① Model	Laminate	Essentials Veneer	Artisan Veneer
Wall Mount Double Height Overhead with Two Doors and Open Center	15 7/8	54	29 1/4	169	19	FLT1654-29WSMO	\$1,710		
	15 7/8	54	29 1/4	169	19	FLV1654-29WSMO		\$2,667	\$2,935
	15 7/8	48	29 1/4	154	17	FLT1648-29WSMO	\$1,655		
	15 7/8	48	29 1/4	154	17	FLV1648-29WSMO		\$2,580	\$2,840
	15 7/8	42	29 1/4	139	15	FLT1642-29WSMO	\$1,602		
	15 7/8	42	29 1/4	139	15	FLV1642-29WSMO		\$2,503	\$2,750

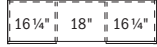
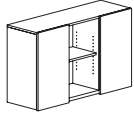

54" wide

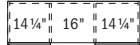

48" wide



42" wide

Features:

- supported by wall cleat - hardware provided by installer
- secure wall attachment required; pilot holes provided in back panel
- laminate grain direction runs horizontal on back panel of overhead cabinets
- 1/4" overhang at the bottom of the door allows access
- adjustable shelves

Options:

- must specify chassis grain direction on artisan veneer, see pages 13-15 for details
- veneer door fronts in paint available, specify paint color and add \$354 list; see page 16 for details
- on laminate units, contrasting laminate door fronts available, no upcharge; specify laminate color, see page 16 for details
- white glass doors with aluminum trim available, specify and add \$2,558 list for 54"w, \$2,359 list for 48"w, \$2,161 list for 42"w; see page 33 for details
- markerboard laminate doors available, specify and add \$405 list; see page 33 for details
- locking doors available, specify and add \$294 list (not available on glass doors)

To Order, Specify:

① Laminate Model #	② Laminate Selection	③ Metal Color	④ Other Product Options
Laminate (FLT)	See Laminate Selection	See Metal Finish Color Options	See list of options for each specific unit; Specify and add accordingly.

① Veneer Model #	② Wood Collection	③ Wood Finish	④ Metal Color	⑤ Other Product Options		
Veneer (FLV)	Essentials	See Essentials Wood Finish Options	See Metal Finish Color Options	See list of options for each specific unit; Specify and add accordingly.		
	Artisan	<table border="1"> <thead> <tr> <th>③a Wood Finish</th> <th>③b Chassis Grain Direction</th> </tr> </thead> <tbody> <tr> <td>See Artisan Wood Finish Options</td> <td>For Artisan Only: Vertical Horizontal</td> </tr> </tbody> </table>	③a Wood Finish		③b Chassis Grain Direction	See Artisan Wood Finish Options
③a Wood Finish	③b Chassis Grain Direction					
See Artisan Wood Finish Options	For Artisan Only: Vertical Horizontal					

Description	D	W	H	CTN WT	CU FT	Model	Laminate	Essentials Veneer	Artisan Veneer
Wall Mount Double Height Overhead Cabinet Sliding Door	15 15/16	96	29 1/4	276	32	FLT1696-29WSD	\$2,860		
	15 15/16	96	29 1/4	276	32	FLV1696-29WSD		\$4,685	\$5,152
	15 15/16	90	29 1/4	261	30	FLT1690-29WSD	\$2,691		
	15 15/16	90	29 1/4	261	30	FLV1690-29WSD		\$4,405	\$4,846
	15 15/16	84	29 1/4	246	28	FLT1684-29WSD	\$2,515		
	15 15/16	84	29 1/4	246	28	FLV1684-29WSD		\$4,121	\$4,535

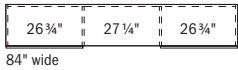
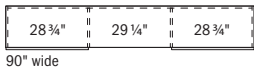
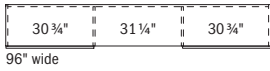
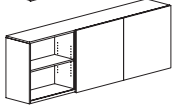
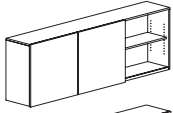
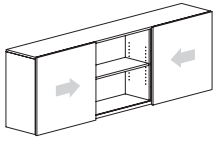

Features:

- supported by wall cleat - hardware provided by installer
- secure wall attachment required; pilot holes provided in back panel
- laminate grain direction runs horizontal on back panel of overhead cabinets
- locking not available
- adjustable shelves

Options:

- must specify chassis grain direction on artisan veneer, see pages 13-15 for details
- veneer door fronts in paint available, specify paint color and add \$354 list; see page 16 for details
- on laminate units, contrasting laminate door fronts available, no upcharge; specify laminate color, see page 16 for details
- white glass doors with aluminum trim available, specify and add \$2,758 list for 96" w, \$2,623 list for 90" w, \$2,491 list for 84" w; see page 33 for details
- markerboard laminate doors available, specify and add \$598 list; see page 33 for details

Wall Mount Double Height Overhead Cabinet Sliding Door	15 15/16	78	29 1/4	214	26	FLT1678-29WSD	\$2,350		
	15 15/16	78	29 1/4	214	26	FLV1678-29WSD		\$3,724	\$4,098
	15 15/16	72	29 1/4	200	25	FLT1672-29WSD	\$2,216		
	15 15/16	72	29 1/4	200	25	FLV1672-29WSD		\$3,514	\$3,866
	15 15/16	66	29 1/4	185	23	FLT1666-29WSD	\$2,098		
	15 15/16	66	29 1/4	185	23	FLV1666-29WSD		\$3,327	\$3,658
	15 15/16	60	29 1/4	178	21	FLT1660-29WSD	\$2,011		
	15 15/16	60	29 1/4	178	21	FLV1660-29WSD		\$3,185	\$3,505

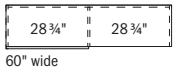
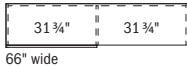
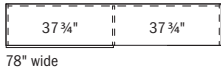
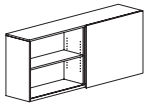
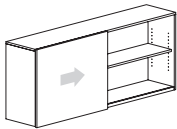

Features:

- supported by wall cleat - hardware provided by installer
- secure wall attachment required; pilot holes provided in back panel
- laminate grain direction runs horizontal on back panel of overhead cabinets
- locking not available
- adjustable shelves

Options:

- must specify chassis grain direction on artisan veneer, see pages 13-15 for details
- veneer door fronts in paint available, specify paint color and add \$354 list; see page 16 for details
- on laminate units, contrasting laminate door fronts available, no upcharge; specify laminate color, see page 16 for details
- white glass doors w/ith aluminum trim available, specify and add \$1,612 list for 78" w, \$1,514 list for 72" w, \$1,414 list for 66" w, \$1,277 list for 60" w; see page 33 for details
- markerboard laminate doors available, specify and add \$301 list; see page 33 for details

Description	D	W	H	CTN WT	CU FT	① Model	Laminate	Essentials Veneer	Artisan Veneer
Wall Mount Double Height Overhead Cabinet Sliding Door	15 15/16	54	29 1/4	157	19	FLT1654-29WSD	\$1,964		
	15 15/16	54	29 1/4	157	19	FLV1654-29WSD		\$3,065	\$3,372
	15 15/16	48	29 1/4	143	17	FLT1648-29WSD	\$1,900		
	15 15/16	48	29 1/4	143	17	FLV1648-29WSD		\$2,967	\$3,264
	15 15/16	42	29 1/4	129	15	FLT1642-29WSD	\$1,839		
	15 15/16	42	29 1/4	129	15	FLV1642-29WSD		\$2,872	\$3,160

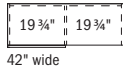
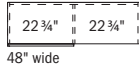
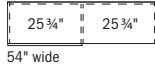
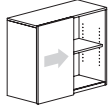

Features:

- supported by wall cleat - hardware provided by installer
- secure wall attachment required; pilot holes provided in back panel
- laminate grain direction runs horizontal on back panel of overhead cabinets
- locking not available
- adjustable shelves

Options:

- must specify chassis grain direction on artisan veneer, see pages 13-15 for details
- veneer door fronts in paint available, specify paint color and add \$354 list; see page 16 for details
- on laminate units, contrasting laminate door fronts available, no upcharge; specify laminate color, see page 16 for details
- white glass doors with aluminum trim available, specify and add \$1,214 list for 54" w, \$1,116 list for 48" w, \$1,017 list for 42" w; see page 33 for details
- markerboard laminate doors available, specify and add \$301 list; see page 33 for details

Wall Mount Double Height Overhead Cabinet Sliding Door	15 15/16	36	29 1/4	115	13	FLT1636-29WSD	\$1,749		
	15 15/16	36	29 1/4	115	13	FLV1636-29WSD		\$2,728	\$3,001
	15 15/16	30	29 1/4	101	11	FLT1630-29WSD	\$1,678		
	15 15/16	30	29 1/4	101	11	FLV1630-29WSD		\$2,619	\$2,881

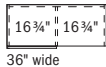
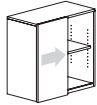

Features:

- supported by wall cleat - hardware provided by installer
- secure wall attachment required; pilot holes provided in back panel
- laminate grain direction runs horizontal on back panel of overhead cabinets
- locking not available
- adjustable shelves

Options:

- must specify chassis grain direction on artisan veneer, see pages 13-15 for details
- veneer door fronts in paint available, specify paint color and add \$354 list; see page 16 for details
- on laminate units, contrasting laminate door fronts available, no upcharge; specify laminate color, see page 16 for details
- white glass doors with aluminum trim available, specify and add \$668 list for 36" w, \$638 list for 30" w; see page 33 for details
- markerboard laminate doors available, specify and add \$301 list; see page 33 for details

To Order, Specify:

① Laminate Model #	② Laminate Selection	③ Metal Color	④ Other Product Options
Laminate (FLT)	See Laminate Selection	See Metal Finish Color Options	See list of options for each specific unit; Specify and add accordingly.

① Veneer Model #	② Wood Collection	③ Wood Finish	④ Metal Color	⑤ Other Product Options		
Veneer (FLV)	Essentials	See Essentials Wood Finish Options	See Metal Finish Color Options	See list of options for each specific unit; Specify and add accordingly.		
	Artisan	<table border="1"> <thead> <tr> <th>③a Wood Finish</th> <th>③b Chassis Grain Direction</th> </tr> </thead> <tbody> <tr> <td>See Artisan Wood Finish Options</td> <td>For Artisan Only: Vertical Horizontal</td> </tr> </tbody> </table>	③a Wood Finish		③b Chassis Grain Direction	See Artisan Wood Finish Options
③a Wood Finish	③b Chassis Grain Direction					
See Artisan Wood Finish Options	For Artisan Only: Vertical Horizontal					

Description	D	W	H	CTN WT	CU FT	Model	Laminate	Essentials Veneer	Artisan Veneer
Wall Mount Double Height Open Overhead 	15	96	29	222	30	FLT1596-29W00	\$2,186		
	15	96	29	222	30	FLV1596-29W00		\$4,110	\$4,520
	15	90	29	210	29	FLT1590-29W00	\$2,071		
	15	90	29	210	29	FLV1590-29W00		\$3,853	\$4,238
	15	84	29	198	27	FLT1584-29W00	\$1,961		
	15	84	29	198	27	FLV1584-29W00		\$3,596	\$3,957

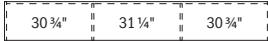

96" wide



90" wide

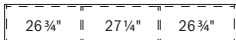

84" wide

Features:

- supported by wall cleat - hardware provided by installer
- secure wall attachment required; pilot holes provided in back panel
- laminate grain direction runs horizontal on back panel of overhead cabinets
- adjustable shelves

Options:

- must specify chassis grain direction on artisan veneer, see pages 13-15 for details

Wall Mount Double Height Open Overhead 	15	78	29	179	25	FLT1578-29W00	\$1,917		
	15	78	29	179	25	FLV1578-29W00		\$3,341	\$3,675
	15	72	29	167	23	FLT1572-29W00	\$1,817		
	15	72	29	167	23	FLV1572-29W00		\$3,083	\$3,391
	15	66	29	155	21	FLT1566-29W00	\$1,716		
	15	66	29	155	21	FLV1566-29W00		\$2,949	\$3,245
	15	60	29	148	19	FLT1560-29W00	\$1,638		
	15	60	29	148	19	FLV1560-29W00		\$2,807	\$3,086



78" wide



72" wide



66" wide

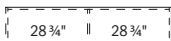

60" wide

Features:

- supported by wall cleat - hardware provided by installer
- secure wall attachment required; pilot holes provided in back panel
- laminate grain direction runs horizontal on back panel of overhead cabinets
- adjustable shelves

Options:

- must specify chassis grain direction on artisan veneer, see pages 13-15 for details

Wall Mount Double Height Open Overhead 	15	54	29	136	18	FLT1554-29W00	\$1,542		
	15	54	29	136	18	FLV1554-29W00		\$2,530	\$2,783
	15	48	29	124	16	FLT1548-29W00	\$1,321		
	15	48	29	124	16	FLV1548-29W00		\$2,216	\$2,438
	15	42	29	112	14	FLT1542-29W00	\$1,255		
	15	42	29	112	14	FLV1542-29W00		\$2,032	\$2,236



54" wide



48" wide

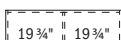

42" wide

Features:

- supported by wall cleat - hardware provided by installer
- secure wall attachment required; pilot holes provided in back panel
- laminate grain direction runs horizontal on back panel of overhead cabinets
- adjustable shelves

Options:

- must specify chassis grain direction on artisan veneer, see pages 13-15 for details

Description	D	W	H	CTN WT	CU FT	① Model	Laminate	Essentials Veneer	Artisan Veneer
Wall Mount Double Height Open Overhead 	15	36	29	89	12	FLT1536-29W00	\$1,092		
	15	36	29	89	12	FLV1536-29W00		\$1,907	\$2,098
	15	30	29	77	10	FLT1530-29W00	\$1,041		
	15	30	29	77	10	FLV1530-29W00		\$1,818	\$1,998

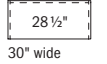
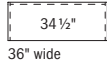

Features:

- supported by wall cleat - hardware provided by installer
- secure wall attachment required; pilot holes provided in back panel
- laminate grain direction runs horizontal on back panel of overhead cabinets
- adjustable shelf

Options:

- must specify chassis grain direction on artisan veneer, see pages 13-15 for details

Overhead Wall Mount Shelf	D	W	H	CTN WT	CU FT	① Model	Laminate	Essentials Veneer	Artisan Veneer
		15	96	17	92	19	FLT1596-17WMS	\$1,132	
15		96	17	92	19	FLV1596-17WMS		\$1,740	\$1,913
15		90	17	86	18	FLT1590-17WMS	\$1,081		
15		90	17	86	18	FLV1590-17WMS		\$1,657	\$1,823
15		84	17	81	17	FLT1584-17WMS	\$1,037		
15		84	17	81	17	FLV1584-17WMS		\$1,590	\$1,751
15		78	17	75	15	FLT1578-17WMS	\$995		
15		78	17	75	15	FLV1578-17WMS		\$1,526	\$1,679
15		72	17	69	14	FLT1572-17WMS	\$816		
15		72	17	69	14	FLV1572-17WMS		\$1,249	\$1,374
15		66	17	64	13	FLT1566-17WMS	\$783		
15		66	17	64	13	FLV1566-17WMS		\$1,202	\$1,320
15		60	17	58	12	FLT1560-17WMS	\$752		
15		60	17	58	12	FLV1560-17WMS		\$1,154	\$1,270
15		54	17	52	11	FLT1554-17WMS	\$722		
15		54	17	52	11	FLV1554-17WMS		\$1,107	\$1,220
15		48	17	47	10	FLT1548-17WMS	\$695		
15		48	17	47	10	FLV1548-17WMS		\$1,062	\$1,169
15		42	17	41	9	FLT1542-17WMS	\$665		
15		42	17	41	9	FLV1542-17WMS		\$1,020	\$1,123
15	36	17	36	8	FLT1536-17WMS	\$639			
15	36	17	36	8	FLV1536-17WMS		\$980	\$1,081	
15	30	17	31	6	FLT1530-17WMS	\$614			
15	30	17	31	6	FLV1530-17WMS		\$940	\$1,037	

Features:

- supported by wall cleat - hardware provided by installer
- laminate grain direction runs horizontal on back panel of shelf

Options:

- must specify chassis grain direction on artisan veneer, see pages 13-15 for details

To Order, Specify:

① Laminate Model #	② Laminate Selection	③ Metal Color	④ Other Product Options
Laminate (FLT)	See Laminate Selection	See Metal Finish Color Options	See list of options for each specific unit; Specify and add accordingly.

① Veneer Model #	② Wood Collection	③ Wood Finish	④ Metal Color	⑤ Other Product Options		
Veneer (FLV)	Essentials	See Essentials Wood Finish Options	See Metal Finish Color Options	See list of options for each specific unit; Specify and add accordingly.		
	Artisan	<table border="1"> <thead> <tr> <th>③a Wood Finish</th> <th>③b Chassis Grain Direction</th> </tr> </thead> <tbody> <tr> <td>See Artisan Wood Finish Options</td> <td>For Artisan Only: Vertical Horizontal</td> </tr> </tbody> </table>	③a Wood Finish		③b Chassis Grain Direction	See Artisan Wood Finish Options
③a Wood Finish	③b Chassis Grain Direction					
See Artisan Wood Finish Options	For Artisan Only: Vertical Horizontal					

Description	D	W	H	CTN WT	CU FT	Model	Laminate	Essentials Veneer	Artisan Veneer
Wall Mount Overhead Cabinet with Six Doors	15 7/8	96	17 1/4	184	20	FLT1696-17WSO	\$2,028		
	15 7/8	96	17 1/4	184	20	FLV1696-17WSO		\$3,432	\$3,775
	15 7/8	90	17 1/4	173	19	FLT1690-17WSO	\$1,904		
	15 7/8	90	17 1/4	173	19	FLV1690-17WSO		\$3,224	\$3,548
	15 7/8	84	17 1/4	163	18	FLT1684-17WSO	\$1,780		
	15 7/8	84	17 1/4	163	18	FLV1684-17WSO		\$3,013	\$3,314

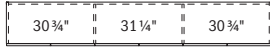
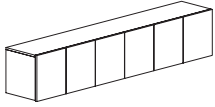

96" wide



90" wide

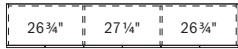

84" wide

Features:

- supported by wall cleat - hardware provided by installer
- secure wall attachment required; pilot holes provided in back panel
- laminate grain direction runs horizontal on back panel of overhead cabinets
- 1/4" overhang at the bottom of the door allows access

Options:

- must specify chassis grain direction on artisan veneer, see pages 13-15 for details
- veneer door fronts in paint available, specify paint color and add \$354 list; see page 16 for details
- on laminate units, contrasting laminate door fronts available, no upcharge; specify laminate color, see page 16 for details
- white glass doors with aluminum trim available, specify and add \$3,516 list; see page 33 for details
- markerboard laminate doors available, specify and add \$1,202 list; see page 33 for details
- locking doors available, specify and add \$441 list (not available on glass doors)

Wall Mount Overhead Cabinet with Four Doors	15 7/8	78	17 1/4	149	16	FLT1678-17WSO	\$1,659		
	15 7/8	78	17 1/4	149	16	FLV1678-17WSO		\$2,715	\$2,987
	15 7/8	72	17 1/4	139	15	FLT1672-17WSO	\$1,564		
	15 7/8	72	17 1/4	139	15	FLV1672-17WSO		\$2,558	\$2,816
	15 7/8	66	17 1/4	129	14	FLT1666-17WSO	\$1,478		
	15 7/8	66	17 1/4	129	14	FLV1666-17WSO		\$2,420	\$2,659
	15 7/8	60	17 1/4	124	13	FLT1660-17WSO	\$1,412		
	15 7/8	60	17 1/4	124	13	FLV1660-17WSO		\$2,312	\$2,545

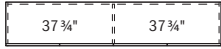
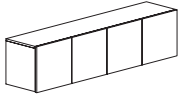

78" wide



72" wide

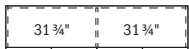

66" wide

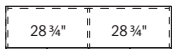

60" wide

Features:

- supported by wall cleat - hardware provided by installer
- secure wall attachment required; pilot holes provided in back panel
- laminate grain direction runs horizontal on back panel of overhead cabinets
- 1/4" overhang at the bottom of the door allows access

Options:

- must specify chassis grain direction on artisan veneer, see pages 13-15 for details
- veneer door fronts in paint available, specify paint color and add \$354 list; see page 16 for details
- on laminate units, contrasting laminate door fronts available, no upcharge; specify laminate color, see page 16 for details
- white glass doors with aluminum trim available, specify and add \$2,555 list for 78"w, \$2,438 list for 72"w, \$2,346 list for 66"w or 60"w; see page 33 for details
- markerboard laminate doors available, specify and add \$802 list; see page 33 for details
- locking doors available, specify and add \$294 list (not available on glass doors)

FLUX

Description	D	W	H	CTN WT	CU FT	① Model	Laminate	Essentials Veneer	Artisan Veneer
Wall Mount Overhead Cabinet with Three Doors	15 7/8	54	17 1/4	115	12	FLT1654-17WSOR	\$1,382		
	15 7/8	54	17 1/4	115	12	FLV1654-17WSOR		\$2,223	\$2,447
	15 7/8	54	17 1/4	115	12	FLT1654-17WSOL	\$1,382		
	15 7/8	54	17 1/4	115	12	FLV1654-17WSOL		\$2,223	\$2,447
	15 7/8	48	17 1/4	103	10	FLT1648-17WSOR	\$1,334		
	15 7/8	48	17 1/4	103	10	FLV1648-17WSOR		\$2,147	\$2,361
	15 7/8	48	17 1/4	103	10	FLT1648-17WSOL	\$1,334		
	15 7/8	48	17 1/4	103	10	FLV1648-17WSOL		\$2,147	\$2,361
	15 7/8	42	17 1/4	93	9	FLT1642-17WSOR	\$1,291		
	15 7/8	42	17 1/4	93	9	FLV1642-17WSOR		\$2,079	\$2,287
	15 7/8	42	17 1/4	93	9	FLT1642-17WSOL	\$1,291		
	15 7/8	42	17 1/4	93	9	FLV1642-17WSOL		\$2,079	\$2,287

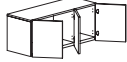
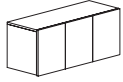

right shown

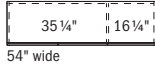

54" wide

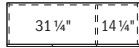

48" wide

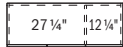

42" wide

Features:

- supported by wall cleat - hardware provided by installer
- secure wall attachment required; pilot holes provided in back panel
- laminate grain direction runs horizontal on back panel of overhead cabinets
- 1/4" overhang at the bottom of the door allows access

Options:

- must specify chassis grain direction on artisan veneer, see pages 13-15 for details
- veneer door fronts in paint available, specify paint color and add \$354 list; see page 16 for details
- on laminate units, contrasting laminate door fronts available, no upcharge; specify laminate color, see page 16 for details
- white glass doors with aluminum trim available, specify and add \$1,830 list for 54"w, \$1,759 list for 48"w or 42"w; see page 33 for details
- markerboard laminate doors available, specify and add \$603 list; see page 33 for details
- locking doors available, specify and add \$294 list (not available on glass doors)

Wall Mount Overhead Cabinet with Two Doors	15 7/8	36	17 1/4	75	8	FLT1636-17WSO	\$1,225		
	15 7/8	36	17 1/4	75	8	FLV1636-17WSO		\$1,971	\$2,169
	15 7/8	30	17 1/4	65	7	FLT1630-17WSO	\$1,175		
	15 7/8	30	17 1/4	65	7	FLV1630-17WSO		\$1,889	\$2,081

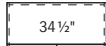
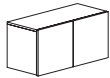

36" wide



30" wide

Features:

- supported by wall cleat - hardware provided by installer
- secure wall attachment required; pilot holes provided in back panel
- laminate grain direction runs horizontal on back panel of overhead cabinets
- 1/4" overhang at the bottom of the door allows access

Options:

- must specify chassis grain direction on artisan veneer, see pages 13-15 for details
- veneer door fronts in paint available, specify paint color and add \$354 list; see page 16 for details
- on laminate units, contrasting laminate door fronts available, no upcharge; specify laminate color, see page 16 for details
- white glass doors with aluminum trim available, specify and add \$1,222 list for 36"w, \$1,175 list for 30"w; see page 33 for details
- locking doors available, specify and add \$147 list (not available on glass doors)

To Order, Specify:

① Laminate Model #	② Laminate Selection	③ Metal Color	④ Other Product Options
Laminate (FLT)	See Laminate Selection	See Metal Finish Color Options	See list of options for each specific unit; Specify and add accordingly.

① Veneer Model #	② Wood Collection	③ Wood Finish	④ Metal Color	⑤ Other Product Options
Veneer (FLV)	Essentials	See Essentials Wood Finish Options	See Metal Finish Color Options	See list of options for each specific unit; Specify and add accordingly.
		<table border="1"> <thead> <tr> <th>ⓐ Wood Finish</th> <th>ⓑ Chassis Grain Direction</th> </tr> </thead> <tbody> <tr> <td>See Artisan Wood Finish Options</td> <td>For Artisan Only: Vertical Horizontal</td> </tr> </tbody> </table>		
ⓐ Wood Finish	ⓑ Chassis Grain Direction			
See Artisan Wood Finish Options	For Artisan Only: Vertical Horizontal			

Description	D	W	H	CTN WT	CU FT	Model	Laminate	Essentials Veneer	Artisan Veneer
Wall Mount Overhead Cabinet with Four Doors and Open Center	15 7/8	96	17 1/4	172	20	FLT1696-17WSMO	\$1,966		
	15 7/8	96	17 1/4	172	20	FLV1696-17WSMO		\$3,330	\$3,664
	15 7/8	90	17 1/4	162	19	FLT1690-17WSMO	\$1,848		
	15 7/8	90	17 1/4	162	19	FLV1690-17WSMO		\$3,128	\$3,441
	15 7/8	84	17 1/4	153	18	FLT1684-17WSMO	\$1,726		
	15 7/8	84	17 1/4	153	18	FLV1684-17WSMO		\$2,924	\$3,217

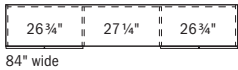
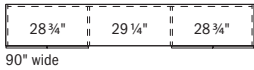
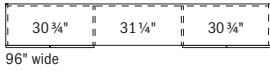
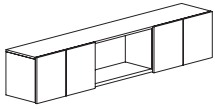

Features:

- supported by wall cleat - hardware provided by installer
- secure wall attachment required; pilot holes provided in back panel
- laminate grain direction runs horizontal on back panel of overhead cabinets
- 1/4" overhang at the bottom of the door allows access

Options:

- must specify chassis grain direction on artisan veneer, see pages 13-15 for details
- veneer door fronts in paint available, specify paint color and add \$354 list; see page 16 for details
- on laminate units, contrasting laminate door fronts available, no upcharge; specify laminate color, see page 16 for details
- white glass doors with aluminum trim available, specify and add \$2,346 list; see page 33 for details
- markerboard laminate doors available, specify and add \$802 list; see page 33 for details
- locking doors available, specify and add \$294 list (not available on glass doors)

Description	D	W	H	CTN WT	CU FT	Model	Laminate	Essentials Veneer	Artisan Veneer
Wall Mount Overhead Cabinet with Two Doors and Open Compartment	15 7/8	78	17 1/4	135	16	FLT1678-17WSMOR	\$1,611		
	15 7/8	78	17 1/4	135	16	FLV1678-17WSMOR		\$2,635	\$2,900
	15 7/8	78	17 1/4	135	16	FLT1678-17WSMOL	\$1,611		
	15 7/8	78	17 1/4	135	16	FLV1678-17WSMOL		\$2,635	\$2,900
	15 7/8	72	17 1/4	126	15	FLT1672-17WSMOR	\$1,518		
	15 7/8	72	17 1/4	126	15	FLV1672-17WSMOR		\$2,484	\$2,734
	15 7/8	72	17 1/4	126	15	FLT1672-17WSMOL	\$1,518		
	15 7/8	72	17 1/4	126	15	FLV1672-17WSMOL		\$2,484	\$2,734
	15 7/8	66	17 1/4	117	14	FLT1666-17WSMOR	\$1,434		
	15 7/8	66	17 1/4	117	14	FLV1666-17WSMOR		\$2,346	\$2,580
	15 7/8	66	17 1/4	117	14	FLT1666-17WSMOL	\$1,434		
	15 7/8	66	17 1/4	117	14	FLV1666-17WSMOL		\$2,346	\$2,580
	15 7/8	60	17 1/4	113	13	FLT1660-17WSMOR	\$1,371		
	15 7/8	60	17 1/4	113	13	FLV1660-17WSMOR		\$2,243	\$2,469
	15 7/8	60	17 1/4	113	13	FLT1660-17WSMOL	\$1,371		
	15 7/8	60	17 1/4	113	13	FLV1660-17WSMOL		\$2,243	\$2,469

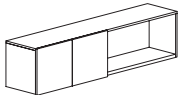

left shown

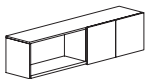

right

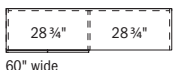
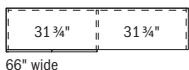
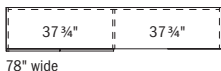

Features:

- supported by wall cleat - hardware provided by installer
- secure wall attachment required; pilot holes provided in back panel
- laminate grain direction runs horizontal on back panel of overhead cabinets
- 1/4" overhang at the bottom of the door allows access

Options:

- must specify chassis grain direction on artisan veneer, see pages 13-15 for details
- veneer door fronts in paint available, specify paint color and add \$354 list; see page 16 for details
- on laminate units, contrasting laminate door fronts available, no upcharge; specify laminate color, see page 16 for details
- white glass doors with aluminum trim available, specify and add \$1,279 list for 78"w, \$1,222 list for 72"w, \$1,175 list for 66"w or 60"w; see page 33 for details
- markerboard laminate doors available, specify and add \$405 list; see page 33 for details
- locking doors available, specify and add \$147 list (not available on glass doors)

Description	D	W	H	CTN WT	CU FT	① Model	Laminate	Essentials Veneer	Artisan Veneer
Wall Mount Overhead Cabinet with Two Doors and Open Center	15 7/8	54	17 1/4	111	12	FLT1654-17WSMO	\$1,342		
	15 7/8	54	17 1/4	111	12	FLV1654-17WSMO		\$2,159	\$2,375
	15 7/8	48	17 1/4	102	10	FLT1648-17WSMO	\$1,295		
	15 7/8	48	17 1/4	102	10	FLV1648-17WSMO		\$2,085	\$2,296
	15 7/8	42	17 1/4	92	9	FLT1642-17WSMO	\$1,254		
	15 7/8	42	17 1/4	92	9	FLV1642-17WSMO		\$2,016	\$2,219

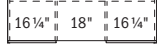
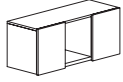

54" wide

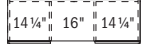

48" wide



42" wide

Features:

- supported by wall cleat - hardware provided by installer
- secure wall attachment required; pilot holes provided in back panel
- laminate grain direction runs horizontal on back panel of overhead cabinets
- 1/4" overhang at the bottom of the door allows access

Options:

- must specify chassis grain direction on artisan veneer, see pages 13-15 for details
- veneer door fronts in paint available, specify paint color and add \$354 list; see page 16 for details
- on laminate units, contrasting laminate door fronts available, no upcharge; specify laminate color, see page 16 for details
- white glass doors with aluminum trim available, specify and add \$1,222 list for 54"w, \$1,175 list for 48"w or 42"w; see page 33 for details
- markerboard laminate doors available, specify and add \$405 list; see page 33 for details
- locking doors available, specify and add \$294 list (not available on glass doors)

To Order, Specify:

① Laminate Model #	② Laminate Selection	③ Metal Color	④ Other Product Options
Laminate (FLT)	See Laminate Selection	See Metal Finish Color Options	See list of options for each specific unit; Specify and add accordingly.

① Veneer Model #	② Wood Collection	③ Wood Finish	④ Metal Color	⑤ Other Product Options		
Veneer (FLV)	Essentials	See Essentials Wood Finish Options	See Metal Finish Color Options	See list of options for each specific unit; Specify and add accordingly.		
	Artisan	<table border="1"> <thead> <tr> <th>③a Wood Finish</th> <th>③b Chassis Grain Direction</th> </tr> </thead> <tbody> <tr> <td>See Artisan Wood Finish Options</td> <td>For Artisan Only: Vertical Horizontal</td> </tr> </tbody> </table>	③a Wood Finish		③b Chassis Grain Direction	See Artisan Wood Finish Options
③a Wood Finish	③b Chassis Grain Direction					
See Artisan Wood Finish Options	For Artisan Only: Vertical Horizontal					

Description	D	W	H	CTN WT	CU FT	Model	Laminate	Essentials Veneer	Artisan Veneer
Wall Mount Overhead Cabinet with Sliding Doors	15 ¹⁵ / ₁₆	96	17 ¹ / ₄	177	20	FLT1696-17WSD	\$2,288		
	15 ¹⁵ / ₁₆	96	17 ¹ / ₄	177	20	FLV1696-17WSD		\$3,746	\$4,120
	15 ¹⁵ / ₁₆	90	17 ¹ / ₄	167	19	FLT1690-17WSD	\$2,153		
	15 ¹⁵ / ₁₆	90	17 ¹ / ₄	167	19	FLV1690-17WSD		\$3,522	\$3,877
	15 ¹⁵ / ₁₆	84	17 ¹ / ₄	158	18	FLT1684-17WSD	\$2,014		
	15 ¹⁵ / ₁₆	84	17 ¹ / ₄	158	18	FLV1684-17WSD		\$3,296	\$3,628

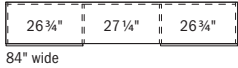
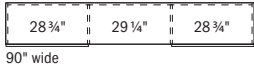
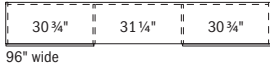
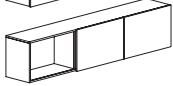
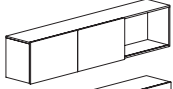
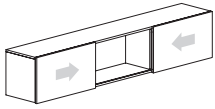

Features:

- supported by wall cleat - hardware provided by installer
- secure wall attachment required; pilot holes provided in back panel
- laminate grain direction runs horizontal on back panel of overhead cabinets
- locking not available

Options:

- must specify chassis grain direction on artisan veneer, see pages 13-15 for details
- veneer door fronts in paint available, specify paint color and add \$354 list; see page 16 for details
- on laminate units, contrasting laminate door fronts available, no upcharge; specify laminate color, see page 16 for details
- white glass doors with aluminum trim available, specify and add \$1,877 list for 96"w, \$1,800 list for 90"w, \$1,721 list for 84"w; see page 33 for details
- markerboard laminate doors available, specify and add \$598 list; see page 33 for details

Wall Mount Overhead Cabinet with Sliding Door	15 ¹⁵ / ₁₆	78	17 ¹ / ₄	138	16	FLT1678-17WSD	\$1,879		
	15 ¹⁵ / ₁₆	78	17 ¹ / ₄	138	16	FLV1678-17WSD		\$2,979	\$3,279
	15 ¹⁵ / ₁₆	72	17 ¹ / ₄	129	15	FLT1672-17WSD	\$1,775		
	15 ¹⁵ / ₁₆	72	17 ¹ / ₄	129	15	FLV1672-17WSD		\$2,812	\$3,093
	15 ¹⁵ / ₁₆	66	17 ¹ / ₄	120	14	FLT1666-17WSD	\$1,679		
	15 ¹⁵ / ₁₆	66	17 ¹ / ₄	120	14	FLV1666-17WSD		\$2,661	\$2,930
	15 ¹⁵ / ₁₆	60	17 ¹ / ₄	111	13	FLT1660-17WSD	\$1,608		
	15 ¹⁵ / ₁₆	60	17 ¹ / ₄	111	13	FLV1660-17WSD		\$2,550	\$2,806

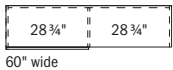
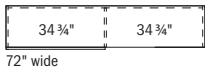
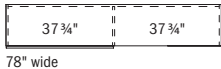
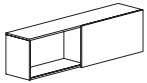
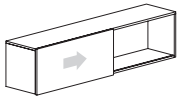

Features:

- supported by wall cleat - hardware provided by installer
- secure wall attachment required; pilot holes provided in back panel
- laminate grain direction runs horizontal on back panel of overhead cabinets
- locking not available

Options:

- must specify chassis grain direction on artisan veneer, see pages 13-15 for details
- veneer door fronts in paint available, specify paint color and add \$354 list; see page 16 for details
- on laminate units, contrasting laminate door fronts available, no upcharge; specify laminate color, see page 16 for details
- white glass doors with aluminum trim available, specify and add \$1,081 list for 78"w, \$1,020 list for 72"w, \$962 list for 66"w \$901 list for 60"w; see page 33 for details
- markerboard laminate doors available, specify and add \$301 list; see page 33 for details

FLUX

Description	D	W	H	CTN WT	CU FT	① Model	Laminate	Essentials Veneer	Artisan Veneer
Wall Mount Overhead Cabinet with Sliding Door	15 15/16	54	17 1/4	102	12	FLT1654-17WSD	\$1,571		
	15 15/16	54	17 1/4	102	12	FLV1654-17WSD		\$2,451	\$2,698
	15 15/16	48	17 1/4	92	10	FLT1648-17WSD	\$1,521		
	15 15/16	48	17 1/4	92	10	FLV1648-17WSD		\$2,373	\$2,612
	15 15/16	42	17 1/4	83	9	FLT1642-17WSD	\$1,475		
	15 15/16	42	17 1/4	83	9	FLV1642-17WSD		\$2,298	\$2,527

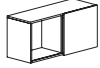
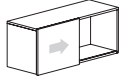

54" wide

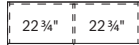

48" wide

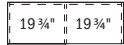

42" wide

Features:

- supported by wall cleat - hardware provided by installer
- secure wall attachment required; pilot holes provided in back panel
- laminate grain direction runs horizontal on back panel of overhead cabinets
- locking not available

Options:

- must specify chassis grain direction on artisan veneer, see pages 13-15 for details
- veneer door fronts in paint available, specify paint color and add \$354 list; see page 16 for details
- on laminate units, contrasting laminate door fronts available, no upcharge; specify laminate color, see page 16 for details
- white glass doors with aluminum trim available, specify and add \$844 list for 54"w, \$817 list for 48"w, \$786 list for 42"w; see page 33 for details
- markerboard laminate doors available, specify and add \$301 list; see page 33 for details

Wall Mount Overhead Cabinet with Sliding Door	15 15/16	36	17 1/4	74	8	FLT1636-17WSD	\$1,398		
	15 15/16	36	17 1/4	74	8	FLV1636-17WSD		\$2,182	\$2,403
	15 15/16	30	17 1/4	65	7	FLT1630-17WSD	\$1,346		
	15 15/16	30	17 1/4	65	7	FLV1630-17WSD		\$2,095	\$2,305

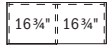

36" wide



30" wide

Features:

- supported by wall cleat - hardware provided by installer
- secure wall attachment required; pilot holes provided in back panel
- laminate grain direction runs horizontal on back panel of overhead cabinets
- locking not available

Options:

- must specify chassis grain direction on artisan veneer, see pages 13-15 for details
- veneer door fronts in paint available, specify paint color and add \$354 list; see page 16 for details
- on laminate units, contrasting laminate door fronts available, no upcharge; specify laminate color, see page 16 for details
- white glass doors with aluminum trim available, specify and add \$668 list for 36"w, \$638 list for 30"w; see page 33 for details
- markerboard laminate doors available, specify and add \$301 list; see page 33 for details

To Order, Specify:

① Laminate Model #	② Laminate Selection	③ Metal Color	④ Other Product Options
Laminate (FLT)	See Laminate Selection	See Metal Finish Color Options	See list of options for each specific unit; Specify and add accordingly.

① Veneer Model #	② Wood Collection	③ Wood Finish	④ Metal Color	⑤ Other Product Options		
Veneer (FLV)	Essentials	See Essentials Wood Finish Options	See Metal Finish Color Options	See list of options for each specific unit; Specify and add accordingly.		
	Artisan	<table border="1"> <thead> <tr> <th>ⓐ Wood Finish</th> <th>ⓑ Chassis Grain Direction</th> </tr> </thead> <tbody> <tr> <td>See Artisan Wood Finish Options</td> <td>For Artisan Only: Vertical Horizontal</td> </tr> </tbody> </table>	ⓐ Wood Finish		ⓑ Chassis Grain Direction	See Artisan Wood Finish Options
ⓐ Wood Finish	ⓑ Chassis Grain Direction					
See Artisan Wood Finish Options	For Artisan Only: Vertical Horizontal					

Description	D	W	H	CTN WT	CU FT	① Model	Laminate	Essentials Veneer	Artisan Veneer
Wall Mount Open Overhead	15	96	17	145	19	FLT1596-17W00	\$1,763		
	15	96	17	145	19	FLV1596-17W00		\$2,987	\$3,287
	15	90	17	137	18	FLT1590-17W00	\$1,658		
	15	90	17	137	18	FLV1590-17W00		\$2,807	\$3,086
	15	84	17	130	17	FLT1584-17W00	\$1,549		
	15	84	17	130	17	FLV1584-17W00		\$2,622	\$2,885

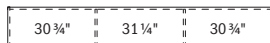
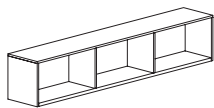

96" wide

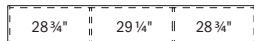

90" wide



84" wide

Features:

- supported by wall cleat - hardware provided by installer
- secure wall attachment required; pilot holes provided in back panel
- laminate grain direction runs horizontal on back panel of overhead cabinets

Options:

- must specify chassis grain direction on artisan veneer, see pages 13-15 for details

Wall Mount Open Overhead	15	78	17	117	15	FLT1578-17W00	\$1,443		
	15	78	17	117	15	FLV1578-17W00		\$2,364	\$2,601
	15	72	17	109	14	FLT1572-17W00	\$1,361		
	15	72	17	109	14	FLV1572-17W00		\$2,229	\$2,449
	15	66	17	101	13	FLT1566-17W00	\$1,287		
	15	66	17	101	13	FLV1566-17W00		\$2,104	\$2,314
Wall Mount Open Overhead	15	60	17	98	12	FLT1560-17W00	\$1,232		
	15	60	17	98	12	FLV1560-17W00		\$2,013	\$2,214

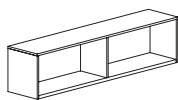

78" wide



72" wide



66" wide

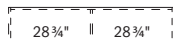

60" wide



Features:

- supported by wall cleat - hardware provided by installer
- secure wall attachment required; pilot holes provided in back panel
- laminate grain direction runs horizontal on back panel of overhead cabinets

Options:

- must specify chassis grain direction on artisan veneer, see pages 13-15 for details

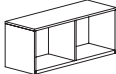
FLUX

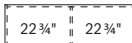
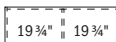

Description	D	W	H	CTN WT	CU FT	① Model	Laminate	Essentials Veneer	Artisan Veneer
Wall Mount Open Overhead   54" wide  48" wide  42" wide	15	54	17	90	11	FLT1554-17W00	\$1,204		
	15	54	17	90	11	FLV1554-17W00		\$1,938	\$2,132
	15	48	17	82	10	FLT1548-17W00	\$1,162		
	15	48	17	82	10	FLV1548-17W00		\$1,872	\$2,057
	15	42	17	74	9	FLT1542-17W00	\$1,126		
	15	42	17	74	9	FLV1542-17W00		\$1,811	\$1,991

Features:

- supported by wall cleat - hardware provided by installer
- secure wall attachment required; pilot holes provided in back panel
- laminate grain direction runs horizontal on back panel of overhead cabinets

Options:

- must specify chassis grain direction on artisan veneer, see pages 13-15 for details

Wall Mount Open Overhead   36" wide  30" wide	15	36	17	57	8	FLT1536-17W00	\$1,066		
	15	36	17	57	8	FLV1536-17W00		\$1,715	\$1,888
	15	30	17	49	6	FLT1530-17W00	\$1,023		
	15	30	17	49	6	FLV1530-17W00		\$1,645	\$1,811

Features:

- supported by wall cleat - hardware provided by installer
- secure wall attachment required; pilot holes provided in back panel
- laminate grain direction runs horizontal on back panel of overhead cabinets

Options:

- must specify chassis grain direction on artisan veneer, see pages 13-15 for details

To Order, Specify:

① Laminate Model #	② Laminate Selection	③ Metal Color	④ Other Product Options
Laminate (FLT)	See Laminate Selection	See Metal Finish Color Options	See list of options for each specific unit; Specify and add accordingly.

① Veneer Model #	② Wood Collection	③ Wood Finish	④ Metal Color	⑤ Other Product Options		
Veneer (FLV)	Essentials	See Essentials Wood Finish Options	See Metal Finish Color Options	See list of options for each specific unit; Specify and add accordingly.		
	Artisan	<table border="1"> <thead> <tr> <th>③a Wood Finish</th> <th>③b Chassis Grain Direction</th> </tr> </thead> <tbody> <tr> <td>See Artisan Wood Finish Options</td> <td>For Artisan Only: Vertical Horizontal</td> </tr> </tbody> </table>	③a Wood Finish		③b Chassis Grain Direction	See Artisan Wood Finish Options
③a Wood Finish	③b Chassis Grain Direction					
See Artisan Wood Finish Options	For Artisan Only: Vertical Horizontal					

Description	D	W	H	CTN WT	CU FT	① Model	Laminate	Essentials Veneer	Artisan Veneer
Wall Mount Cubby with Open Vertical Storage Compartment	15	96	17	100	19	FLT1596WCUOR	\$2,077		
	15	96	17	100	19	FLV1596WCUOR		\$3,198	\$3,515
	15	96	17	100	19	FLT1596WCUOL	\$2,077		
	15	96	17	100	19	FLV1596WCUOL		\$3,198	\$3,515
	15	90	17	96	18	FLT1590WCUOR	\$1,955		
	15	90	17	96	18	FLV1590WCUOR		\$2,906	\$3,199
	15	90	17	96	18	FLT1590WCUOL	\$1,955		
	15	90	17	96	18	FLV1590WCUOL		\$2,906	\$3,199
	15	84	17	91	17	FLT1584WCUOR	\$1,920		
	15	84	17	91	17	FLV1584WCUOR		\$2,699	\$2,969
	15	84	17	91	17	FLT1584WCUOL	\$1,920		
	15	84	17	91	17	FLV1584WCUOL		\$2,699	\$2,969

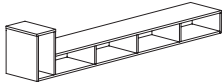

left shown

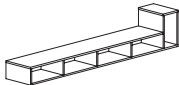

right

Features:

- supported by wall cleat - hardware provided by installer
- laminate grain direction runs horizontal on back panel of cubbies

Options:

- must specify chassis grain direction on artisan veneer, see pages 13-15 for details

FLUX

Wall Mount Cubby with Open Vertical Storage Compartment	15	78	17	85	15	FLT1578WCUOR	\$1,708		
	15	78	17	85	15	FLV1578WCUOR		\$2,612	\$2,872
	15	78	17	85	15	FLT1578WCUOL	\$1,708		
	15	78	17	85	15	FLV1578WCUOL		\$2,612	\$2,872
	15	72	17	80	14	FLT1572WCUOR	\$1,603		
	15	72	17	80	14	FLV1572WCUOR		\$2,444	\$2,691
	15	72	17	80	14	FLT1572WCUOL	\$1,603		
	15	72	17	80	14	FLV1572WCUOL		\$2,444	\$2,691
	15	66	17	75	13	FLT1566WCUOR	\$1,499		
	15	66	17	75	13	FLV1566WCUOR		\$2,277	\$2,506
	15	66	17	75	13	FLT1566WCUOL	\$1,499		
	15	66	17	75	13	FLV1566WCUOL		\$2,277	\$2,506
	15	60	17	70	12	FLT1560WCUOR	\$1,405		
	15	60	17	70	12	FLV1560WCUOR		\$2,128	\$2,343
	15	60	17	70	12	FLT1560WCUOL	\$1,405		
	15	60	17	70	12	FLV1560WCUOL		\$2,128	\$2,343

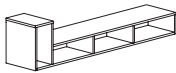

left shown

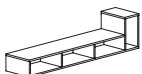

right

Features:

- supported by wall cleat - hardware provided by installer
- laminate grain direction runs horizontal on back panel of cubbies

Options:

- must specify chassis grain direction on artisan veneer, see pages 13-15 for details

Description	D	W	H	CTN WT	CU FT	① Model	Laminate	Essentials Veneer	Artisan Veneer
Wall Mount Cubby with Open Vertical Storage Compartment	15	54	17	64	11	FLT1554WCUOR	\$1,319		
	15	54	17	64	11	FLV1554WCUOR		\$1,994	\$2,194
	15	54	17	64	11	FLT1554WCUOL	\$1,319		
	15	54	17	64	11	FLV1554WCUOL		\$1,994	\$2,194
	15	48	17	59	10	FLT1548WCUOR	\$1,244		
	15	48	17	59	10	FLV1548WCUOR		\$1,875	\$2,061
	15	48	17	59	10	FLT1548WCUOL	\$1,244		
	15	48	17	59	10	FLV1548WCUOL		\$1,875	\$2,061
	15	42	17	54	9	FLT1542WCUOR	\$1,167		
	15	42	17	54	9	FLV1542WCUOR		\$1,754	\$1,929
	15	42	17	54	9	FLT1542WCUOL	\$1,167		
	15	42	17	54	9	FLV1542WCUOL		\$1,754	\$1,929

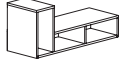

left shown

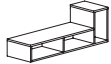

right

Features:

- supported by wall cleat - hardware provided by installer
- laminate grain direction runs horizontal on back panel of cubbies

Options:

- must specify chassis grain direction on artisan veneer, see pages 13-15 for details

Wall Mount Cubby with Open Vertical Storage Compartment	15	36	17	49	8	FLT1536WCUOR	\$1,098		
	15	36	17	49	8	FLV1536WCUOR		\$1,644	\$1,809
	15	36	17	49	8	FLT1536WCUOL	\$1,098		
	15	36	17	49	8	FLV1536WCUOL		\$1,644	\$1,809
	15	30	17	44	6	FLT1530WCUOR	\$1,038		
	15	30	17	44	6	FLV1530WCUOR		\$1,548	\$1,704
	15	30	17	44	6	FLT1530WCUOL	\$1,038		
	15	30	17	44	6	FLV1530WCUOL		\$1,548	\$1,704

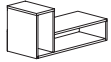

left shown



right

Features:

- supported by wall cleat - hardware provided by installer
- laminate grain direction runs horizontal on back panel of cubbies



Options:

- must specify chassis grain direction on artisan veneer, see pages 13-15 for details

To Order, Specify:

① Laminate Model #	② Laminate Selection	③ Metal Color	④ Other Product Options
Laminate (FLT)	See Laminate Selection	See Metal Finish Color Options	See list of options for each specific unit; Specify and add accordingly.

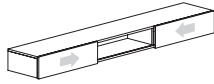
① Veneer Model #	② Wood Collection	③ Wood Finish	④ Metal Color	⑤ Other Product Options		
Veneer (FLV)	Essentials	See Essentials Wood Finish Options	See Metal Finish Color Options	See list of options for each specific unit; Specify and add accordingly.		
	Artisan	<table border="1"> <thead> <tr> <th>ⓐ Wood Finish</th> <th>ⓑ Chassis Grain Direction</th> </tr> </thead> <tbody> <tr> <td>See Artisan Wood Finish Options</td> <td>For Artisan Only: Vertical Horizontal</td> </tr> </tbody> </table>	ⓐ Wood Finish		ⓑ Chassis Grain Direction	See Artisan Wood Finish Options
ⓐ Wood Finish	ⓑ Chassis Grain Direction					
See Artisan Wood Finish Options	For Artisan Only: Vertical Horizontal					

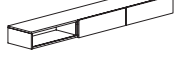
Description	D	W	H	CTN WT	CU FT	① Model	Laminate	Essentials Veneer	Artisan Veneer
Wall Mount Cubby with Sliding Doors   	15 15/16	96	8 1/4	111	11	FLT1696WSDCU	\$2,104		
	15 15/16	96	8 1/4	111	11	FLV1696WSDCU		\$3,448	\$3,794
	15 15/16	90	8 1/4	100	11	FLT1690WSDCU	\$1,981		
	15 15/16	90	8 1/4	100	11	FLV1690WSDCU		\$3,243	\$3,566
	15 15/16	84	8 1/4	89	10	FLT1684WSDCU	\$1,854		
	15 15/16	84	8 1/4	89	10	FLV1684WSDCU		\$3,035	\$3,338

Features:

- supported by wall cleat - hardware provided by installer
- laminate grain direction runs horizontal on back panel of cubbies
- locking not available

Options:

- must specify chassis grain direction on artisan veneer, see pages 13-15 for details
- veneer door fronts in paint available, specify paint color and add \$354 list; see page 16 for details
- on laminate units, contrasting laminate door fronts available, no upcharge; specify laminate color, see page 16 for details
- white glass doors with aluminum trim available, specify and add \$1,721 list for 96" w, \$1,647 list for 90" w, \$1,615 list for 84" w; see page 33 for details
- markerboard laminate doors available, specify and add \$598 list; see page 33 for details

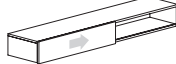
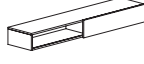
Wall Mount Cubby with Sliding Door  	15 15/16	78	8 1/4	79	9	FLT1678WSDCU	\$1,731		
	15 15/16	78	8 1/4	79	9	FLV1678WSDCU		\$2,742	\$3,016
	15 15/16	72	8 1/4	74	9	FLT1672WSDCU	\$1,632		
	15 15/16	72	8 1/4	74	9	FLV1672WSDCU		\$2,588	\$2,848
	15 15/16	66	8 1/4	69	8	FLT1666WSDCU	\$1,547		
	15 15/16	66	8 1/4	69	8	FLV1666WSDCU		\$2,448	\$2,694
	15 15/16	60	8 1/4	63	7	FLT1660WSDCU	\$1,481		
	15 15/16	60	8 1/4	63	7	FLV1660WSDCU		\$2,346	\$2,580

Features:

- supported by wall cleat - hardware provided by installer
- laminate grain direction runs horizontal on back panel of cubbies
- locking not available

Options:

- must specify chassis grain direction on artisan veneer, see pages 13-15 for details
- veneer door fronts in paint available, specify paint color and add \$354 list; see page 16 for details
- on laminate units, contrasting laminate door fronts available, no upcharge; specify laminate color, see page 16 for details
- white glass doors with aluminum trim available, specify and add \$864 list for 78" w, \$826 list for 72" w, \$811 list for 66" w or 60" w; see page 33 for details
- markerboard laminate doors available, specify and add \$301 list; see page 33 for details

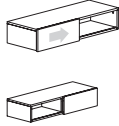
Description	D	W	H	CTN WT	CU FT	① Model	Laminate	Essentials Veneer	Artisan Veneer
Wall Mount Cubby with Sliding Door 	15 15/16	54	8 1/4	58	7	FLT1654WSDCU	\$1,447		
	15 15/16	54	8 1/4	58	7	FLV1654WSDCU		\$2,257	\$2,484
	15 15/16	48	8 1/4	53	6	FLT1648WSDCU	\$1,401		
	15 15/16	48	8 1/4	53	6	FLV1648WSDCU		\$2,182	\$2,403
	15 15/16	42	8 1/4	48	5	FLT1642WSDCU	\$1,356		
	15 15/16	42	8 1/4	48	5	FLV1642WSDCU		\$2,115	\$2,327
	15 15/16	36	8 1/4	43	5	FLT1636WSDCU	\$1,288		
	15 15/16	36	8 1/4	43	5	FLV1636WSDCU		\$2,008	\$2,211
	15 15/16	30	8 1/4	38	4	FLT1630WSDCU	\$1,236		
	15 15/16	30	8 1/4	38	4	FLV1630WSDCU		\$1,926	\$2,120

Features:

- supported by wall cleat - hardware provided by installer
- laminate grain direction runs horizontal on back panel of cubbies
- locking not available

Options:

- must specify chassis grain direction on artisan veneer, see pages 13-15 for details
- veneer door fronts in paint available, specify paint color and add \$354 list; see page 16 for details
- on laminate units, contrasting laminate door fronts available, no upcharge; specify laminate color, see page 16 for details
- white glass doors with aluminum trim available, specify and add \$811 list; see page 33 for details
- markerboard laminate doors available, specify and add \$301 list; see page 33 for details

FLUX

To Order, Specify:

① Laminate Model #	② Laminate Selection	③ Metal Color	④ Other Product Options
Laminate (FLT)	See Laminate Selection	See Metal Finish Color Options	See list of options for each specific unit; Specify and add accordingly.

① Veneer Model #	② Wood Collection	③ Wood Finish	④ Metal Color	⑤ Other Product Options	
Veneer (FLV)	Essentials	See Essentials Wood Finish Options	See Metal Finish Color Options	See list of options for each specific unit; Specify and add accordingly.	
	Artisan	<table border="1"> <thead> <tr> <th>③a Wood Finish</th> <th>③b Chassis Grain Direction</th> </tr> </thead> <tbody> <tr> <td>See Artisan Wood Finish Options</td> <td>For Artisan Only: Vertical Horizontal</td> </tr> </tbody> </table>			③a Wood Finish
③a Wood Finish	③b Chassis Grain Direction				
See Artisan Wood Finish Options	For Artisan Only: Vertical Horizontal				

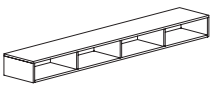
Description	D	W	H	CTN WT	CU FT	① Model	Laminate	Essentials Veneer	Artisan Veneer
15"d Wall Mount Cubby 	15	96	8	90	11	FLT1596WCU	\$1,777		
	15	96	8	90	11	FLV1596WCU		\$2,734	\$3,007
	15	90	8	86	10	FLT1590WCU	\$1,671		
	15	90	8	86	10	FLV1590WCU		\$2,486	\$2,736
	15	84	8	81	9	FLT1584WCU	\$1,643		
	15	84	8	81	9	FLV1584WCU		\$2,308	\$2,539

Features:

- supported by wall cleat - hardware provided by installer
- laminate grain direction runs horizontal on back panel of cubbies

Options:

- must specify chassis grain direction on artisan veneer, see pages 13-15 for details

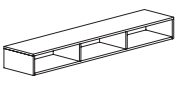
15"d Wall Mount Cubby 	15	78	8	75	9	FLT1578WCU	\$1,460		
	15	78	8	75	9	FLV1578WCU		\$2,233	\$2,454
	15	72	8	70	8	FLT1572WCU	\$1,371		
	15	72	8	70	8	FLV1572WCU		\$2,091	\$2,299
	15	66	8	65	8	FLT1566WCU	\$1,280		
	15	66	8	65	8	FLV1566WCU		\$1,947	\$2,142
	15	60	8	60	7	FLT1560WCU	\$1,203		
	15	60	8	60	7	FLV1560WCU		\$1,821	\$2,003

Features:

- supported by wall cleat - hardware provided by installer
- laminate grain direction runs horizontal on back panel of cubbies

Options:

- must specify chassis grain direction on artisan veneer, see pages 13-15 for details

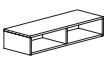
15"d Wall Mount Cubby 	15	54	8	54	6	FLT1554WCU	\$1,128		
	15	54	8	54	6	FLV1554WCU		\$1,706	\$1,876
	15	48	8	49	6	FLT1548WCU	\$1,062		
	15	48	8	49	6	FLV1548WCU		\$1,603	\$1,762
	15	42	8	44	5	FLT1542WCU	\$997		
	15	42	8	44	5	FLV1542WCU		\$1,501	\$1,648
	15	36	8	39	4	FLT1536WCU	\$940		
	15	36	8	39	4	FLV1536WCU		\$1,406	\$1,547
	15	30	8	34	4	FLT1530WCU	\$888		
	15	30	8	34	4	FLV1530WCU		\$1,322	\$1,454

Features:

- supported by wall cleat - hardware provided by installer
- laminate grain direction runs horizontal on back panel of cubbies

Options:

- must specify chassis grain direction on artisan veneer, see pages 13-15 for details

Description	D	W	H	CTN WT	CU FT	① Model	Laminate	Essentials Veneer	Artisan Veneer
	9	96	8	68	7	FLT0996WCU	\$1,586		
	9	96	8	68	7	FLV0996WCU		\$2,440	\$2,687
	9	90	8	64	7	FLT0990WCU	\$1,494		
	9	90	8	64	7	FLV0990WCU		\$2,220	\$2,443
	9	84	8	60	6	FLT0984WCU	\$1,467		
	9	84	8	60	6	FLV0984WCU		\$2,060	\$2,267

Features:

- supported by wall cleat - hardware provided by installer
- laminate grain direction runs horizontal on back panel of cubbies

Options:

- must specify chassis grain direction on artisan veneer, see pages 13-15 for details

	9	78	8	55	6	FLT0978WCU	\$1,304		
	9	78	8	55	6	FLV0978WCU		\$1,992	\$2,192
	9	72	8	51	5	FLT0972WCU	\$1,225		
	9	72	8	51	5	FLV0972WCU		\$1,867	\$2,053
	9	66	8	49	5	FLT0966WCU	\$1,145		
	9	66	8	49	5	FLV0966WCU		\$1,740	\$1,913
	9	60	8	43	5	FLT0960WCU	\$1,073		
	9	60	8	43	5	FLV0960WCU		\$1,626	\$1,788

Features:

- supported by wall cleat - hardware provided by installer
- laminate grain direction runs horizontal on back panel of cubbies

Options:

- must specify chassis grain direction on artisan veneer, see pages 13-15 for details

	9	54	8	39	4	FLT0954WCU	\$1,007		
	9	54	8	39	4	FLV0954WCU		\$1,524	\$1,677
	9	48	8	35	4	FLT0948WCU	\$952		
	9	48	8	35	4	FLV0948WCU		\$1,433	\$1,574
	9	42	8	31	3	FLT0942WCU	\$891		
	9	42	8	31	3	FLV0942WCU		\$1,339	\$1,474
	9	36	8	27	3	FLT0936WCU	\$840		
	9	36	8	27	3	FLV0936WCU		\$1,255	\$1,382
	9	30	8	23	3	FLT0930WCU	\$793		
9	30	8	23	3	FLV0930WCU		\$1,181	\$1,299	

Features:

- supported by wall cleat - hardware provided by installer
- laminate grain direction runs horizontal on back panel of cubbies

Options:

- must specify chassis grain direction on artisan veneer, see pages 13-15 for details

To Order, Specify:

① Laminate Model #	② Laminate Selection	③ Metal Color	④ Other Product Options
Laminate (FLT)	See Laminate Selection	See Metal Finish Color Options	See list of options for each specific unit; Specify and add accordingly.

① Veneer Model #	② Wood Collection	③ Wood Finish	④ Metal Color	⑤ Other Product Options		
Veneer (FLV)	Essentials	See Essentials Wood Finish Options	See Metal Finish Color Options	See list of options for each specific unit; Specify and add accordingly.		
	Artisan	<table border="1"> <thead> <tr> <th>ⓐ Wood Finish</th> <th>ⓑ Chassis Grain Direction</th> </tr> </thead> <tbody> <tr> <td>See Artisan Wood Finish Options</td> <td>For Artisan Only: Vertical Horizontal</td> </tr> </tbody> </table>	ⓐ Wood Finish		ⓑ Chassis Grain Direction	See Artisan Wood Finish Options
ⓐ Wood Finish	ⓑ Chassis Grain Direction					
See Artisan Wood Finish Options	For Artisan Only: Vertical Horizontal					

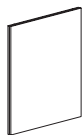
Description	D	W	H	CTN WT	CU FT	① Model	Laminate	Essentials Veneer	Artisan Veneer
Wall Mount Panel 	1 1/16	48	40 13/16	53	5	FLT4841WMP	\$1,159		
	1 1/16	48	40 13/16	53	5	FLV4841WMP		\$1,823	\$2,006
	1 1/16	42	40 13/16	48	4	FLT4241WMP	\$1,137		
	1 1/16	42	40 13/16	48	4	FLV4241WMP		\$1,787	\$1,965
	1 1/16	39	40 13/16	45	4	FLT3941WMP	\$1,108		
	1 1/16	39	40 13/16	45	4	FLV3941WMP		\$1,748	\$1,921
	1 1/16	36	40 13/16	42	4	FLT3641WMP	\$1,084		
	1 1/16	36	40 13/16	42	4	FLV3641WMP		\$1,708	\$1,877
	1 1/16	33	40 13/16	38	4	FLT3341WMP	\$1,056		
	1 1/16	33	40 13/16	38	4	FLV3341WMP		\$1,669	\$1,834
	1 1/16	30	40 13/16	36	3	FLT3041WMP	\$1,029		
	1 1/16	30	40 13/16	36	3	FLV3041WMP		\$1,632	\$1,795
	1 1/16	24	40 13/16	29	3	FLT2441WMP	\$1,010		
	1 1/16	24	40 13/16	29	3	FLV2441WMP		\$1,598	\$1,757
	1 1/16	18	40 13/16	23	2	FLT1841WMP	\$989		
1 1/16	18	40 13/16	23	2	FLV1841WMP		\$1,564	\$1,719	

Features:

- pair with primary height units to achieve 69" overall height
- supported by wall cleat - hardware provided by installer
- grain direction runs vertical on essentials veneer, horizontal on laminate
- spacing of attachment cleats allows wire management

Options:

- must specify chassis grain direction on artisan veneer, see pages 13-15 for details

Description	D	W	H	CTN WT	CU FT	① Model	List Price
Wall Mount Markerboard 	1 1/16	48	40 13/16	53	5	FLB4841WMMB	\$1,365
	1 1/16	42	40 13/16	48	4	FLB4241WMMB	\$1,340
	1 1/16	39	40 13/16	45	4	FLB3941WMMB	\$1,310
	1 1/16	36	40 13/16	42	4	FLB3641WMMB	\$1,277
	1 1/16	33	40 13/16	38	4	FLB3341WMMB	\$1,245
	1 1/16	30	40 13/16	36	3	FLB3041WMMB	\$1,214
	1 1/16	24	40 13/16	29	3	FLB2441WMMB	\$1,189
	1 1/16	18	40 13/16	23	2	FLB1841WMMB	\$1,167

Features:

- pair with primary height units to achieve 69" overall height
- supported by wall cleat - hardware provided by installer
- standard markerboard laminate with aluminum pvc edge
- spacing of attachment cleats allows wire management

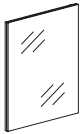
Description	D	W	H	CTN WT	CU FT	① Model	List Price
 Wall Mount Glass Markerboard	1 9/16	48	40 13/16	75	4	FLB4841WMMBG	\$3,536
	1 9/16	42	40 13/16	65	4	FLB4241WMMBG	\$3,020
	1 9/16	39	40 13/16	61	4	FLB3941WMMBG	\$2,872
	1 9/16	36	40 13/16	56	3	FLB3641WMMBG	\$2,726
	1 9/16	33	40 13/16	51	3	FLB3341WMMBG	\$2,577
	1 9/16	30	40 13/16	47	3	FLB3041WMMBG	\$2,428
	1 9/16	24	40 13/16	38	2	FLB2441WMMBG	\$2,134
	1 9/16	18	40 13/16	28	2	FLB1841WMMBG	\$1,839

Features:



- pair with primary height units to achieve 69" overall height
- supported by wall cleat - hardware provided by installer
- white back painted glass with an aluminum profile frame
- spacing of attachment cleats allows wire management

FLUX



To Order, Specify:

① Laminate Model #	② Laminate Selection	③ Metal Color	④ Other Product Options
Laminate (FLT)	See Laminate Selection	See Metal Finish Color Options	See list of options for each specific unit; Specify and add accordingly.

① Veneer Model #	② Wood Collection	③ Wood Finish	④ Metal Color	⑤ Other Product Options	
Veneer (FLV)	Essentials	See Essentials Wood Finish Options	See Metal Finish Color Options	See list of options for each specific unit; Specify and add accordingly.	
	Artisan	<table border="1"> <thead> <tr> <th>③a Wood Finish</th> <th>③b Chassis Grain Direction</th> </tr> </thead> <tbody> <tr> <td>See Artisan Wood Finish Options</td> <td>For Artisan Only: Vertical Horizontal</td> </tr> </tbody> </table>			③a Wood Finish
③a Wood Finish	③b Chassis Grain Direction				
See Artisan Wood Finish Options	For Artisan Only: Vertical Horizontal				

Description	D	W	H	CTN WT	CU FT	① Model	List Price Per Grade	
 <p>48\"w Wall Mount Tack Panel</p> <p>Features:</p> <ul style="list-style-type: none"> · pair with primary height units to achieve 69\"overall height · supported by wall cleat - hardware provided by installer · com ydg: 1 ½ 	1 ⅞	48	40 ¾	34	5	FLB4841WT	COM \$973	
	A	\$1,038						
	B	\$1,051						
	C	\$1,090						
	D	\$1,144						
	E	\$1,193						
	F	\$1,249						
	G	\$1,316						
	H	\$1,418						
	I	\$1,453						
	J	\$1,541						
	 <p>42\"w Wall Mount Tack Panel</p> <p>Features:</p> <ul style="list-style-type: none"> · pair with primary height units to achieve 69\"overall height · supported by wall cleat - hardware provided by installer · com ydg: 1 ½ 	1 ⅞	42	40 ¾	32	4	FLB4241WT	COM \$911
		A	\$976					
B		\$989						
C		\$1,028						
D		\$1,082						
E		\$1,131						
F		\$1,187						
G		\$1,254						
H		\$1,356						
I		\$1,390						
J		\$1,478						
 <p>39\"w Wall Mount Tack Panel</p> <p>Features:</p> <ul style="list-style-type: none"> · pair with primary height units to achieve 69\"overall height · supported by wall cleat - hardware provided by installer · com ydg: 1 ¼ 		1 ⅞	39	40 ¾	31	4	FLB3941WT	COM \$879
		A	\$933					
	B	\$945						
	C	\$977						
	D	\$1,022						
	E	\$1,063						
	F	\$1,110						
	G	\$1,165						
	H	\$1,251						
	I	\$1,280						
	J	\$1,355						
	 <p>36\"w Wall Mount Tack Panel</p> <p>Features:</p> <ul style="list-style-type: none"> · pair with primary height units to achieve 69\"overall height · supported by wall cleat - hardware provided by installer · com ydg: 1 ¼ 	1 ⅞	36	40 ¾	30	4	FLB3641WT	COM \$847
		A	\$901					
B		\$912						
C		\$944						
D		\$989						
E		\$1,031						
F		\$1,077						
G		\$1,132						
H		\$1,218						
I		\$1,247						
J		\$1,321						

FLUX

Description	D	W	H	CTN WT	CU FT	① Model	List Price Per Grade
33" w Wall Mount Tack Panel	1 1/16	33	40 3/4	29	4	FLB3341WT	COM \$816 A \$870 B \$882 C \$914 D \$959 E \$1,000 F \$1,047 G \$1,102 H \$1,188 I \$1,216 J \$1,290
	Features: <ul style="list-style-type: none"> · pair with primary height units to achieve 69" overall height · supported by wall cleat - hardware provided by installer · com ydg: 1 1/4 						
30" w Wall Mount Tack Panel	1 1/16	30	40 3/4	28	3	FLB3041WT	COM \$785 A \$828 B \$837 C \$863 D \$899 E \$932 F \$969 G \$1,013 H \$1,083 I \$1,107 J \$1,167
	Features: <ul style="list-style-type: none"> · pair with primary height units to achieve 69" overall height · supported by wall cleat - hardware provided by installer · com ydg: 1 						
24" w Wall Mount Tack Panel	1 1/16	24	40 3/4	23	3	FLB2441WT	COM \$722 A \$765 B \$774 C \$800 D \$836 E \$869 F \$906 G \$950 H \$1,019 I \$1,043 J \$1,103
	Features: <ul style="list-style-type: none"> · pair with primary height units to achieve 69" overall height · supported by wall cleat - hardware provided by installer · com ydg: 1 						
18" w Wall Mount Tack Panel	1 1/16	18	40 3/4	18	2	FLB1841WT	COM \$659 A \$702 B \$711 C \$737 D \$773 E \$806 F \$843 G \$887 H \$956 I \$979 J \$1,038
	Features: <ul style="list-style-type: none"> · pair with primary height units to achieve 69" overall height · supported by wall cleat - hardware provided by installer · com ydg: 1 						

To Order, Specify:

- ① Model Number
- ② Fabric Selection - vendor, pattern and color

Description	D	W	H	CTN WT	CU FT	① Model	Laminate	Essentials Veneer	Artisan Veneer
Wall Mount Panel 	1 1/16	48	23 1/2	33	3	FLT4824WMP	\$960		
	1 1/16	48	23 1/2	33	3	FLV4824WMP		\$1,510	\$1,662
	1 1/16	42	23 1/2	30	3	FLT4224WMP	\$942		
	1 1/16	42	23 1/2	30	3	FLV4224WMP		\$1,482	\$1,631
	1 1/16	39	23 1/2	28	3	FLT3924WMP	\$918		
	1 1/16	39	23 1/2	28	3	FLV3924WMP		\$1,447	\$1,591
	1 1/16	36	23 1/2	26	3	FLT3624WMP	\$897		
	1 1/16	36	23 1/2	26	3	FLV3624WMP		\$1,415	\$1,558
	1 1/16	33	23 1/2	24	2	FLT3324WMP	\$876		
	1 1/16	33	23 1/2	24	2	FLV3324WMP		\$1,385	\$1,523
	1 1/16	30	23 1/2	22	2	FLT3024WMP	\$854		
	1 1/16	30	23 1/2	22	2	FLV3024WMP		\$1,353	\$1,486
	1 1/16	24	23 1/2	18	2	FLT2424WMP	\$837		
	1 1/16	24	23 1/2	18	2	FLV2424WMP		\$1,323	\$1,455
	1 1/16	18	23 1/2	14	2	FLT1824WMP	\$821		
1 1/16	18	23 1/2	14	2	FLV1824WMP		\$1,296	\$1,427	

Features:

- pair with primary height units and overhead cabinets or shelves to achieve 69" overall height
- supported by wall cleat - hardware provided by installer
- grain direction runs vertical on essentials veneer, horizontal on laminate
- spacing of attachment cleats allows wire management

Options:

- must specify chassis grain direction on artisan veneer, see pages 13-15 for details

Description	D	W	H	CTN WT	CU FT	① Model	List Price
Wall Mount Markerboard 	1 1/16	48	23 1/2	36	3	FLB4824WMMB	\$1,132
	1 1/16	42	23 1/2	30	3	FLB4224WMMB	\$1,110
	1 1/16	39	23 1/2	28	3	FLB3924WMMB	\$1,085
	1 1/16	36	23 1/2	26	3	FLB3624WMMB	\$1,058
	1 1/16	33	23 1/2	24	2	FLB3324WMMB	\$1,031
	1 1/16	30	23 1/2	21	2	FLB3024WMMB	\$1,007
	1 1/16	24	23 1/2	18	2	FLB2424WMMB	\$984
	1 1/16	18	23 1/2	14	2	FLB1824WMMB	\$968

Features:

- pair with primary height units and overhead cabinets or shelves to achieve 69" overall height
- supported by wall cleat - hardware provided by installer
- standard markerboard laminate with aluminum pvc edge
- spacing of attachment cleats allows wire management

Description	D	W	H	CTN WT	CU FT	① Model	List Price
 Wall Mount Glass Markerboard	1 1/8	48	23 1/2	43	3	FLB4824WMMBG	\$2,314
	1 1/8	42	23 1/2	38	2	FLB4224WMMBG	\$2,145
	1 1/8	39	23 1/2	35	2	FLB3924WMMBG	\$2,058
	1 1/8	36	23 1/2	33	2	FLB3624WMMBG	\$1,977
	1 1/8	33	23 1/2	30	2	FLB3324WMMBG	\$1,893
	1 1/8	30	23 1/2	27	2	FLB3024WMMBG	\$1,806
	1 1/8	24	23 1/2	22	2	FLB2424WMMBG	\$1,635
	1 1/8	18	23 1/2	17	1	FLB1824WMMBG	\$1,467

Features:





- pair with primary height units and overhead cabinets or shelves to achieve 69" overall height
- supported by wall cleat - hardware provided by installer
- white back painted glass with an aluminum profile frame
- spacing of attachment cleats allows wire management

FLUX

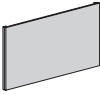

To Order, Specify:

① Laminate Model #	② Laminate Selection	③ Metal Color	④ Other Product Options
Laminate (FLT)	See Laminate Selection	See Metal Finish Color Options	See list of options for each specific unit; Specify and add accordingly.

① Veneer Model #	② Wood Collection	③ Wood Finish	④ Metal Color	⑤ Other Product Options	
Veneer (FLV)	Essentials	See Essentials Wood Finish Options	See Metal Finish Color Options	See list of options for each specific unit; Specify and add accordingly.	
	Artisan	<table border="1"> <thead> <tr> <th>③a Wood Finish</th> <th>③b Chassis Grain Direction</th> </tr> </thead> <tbody> <tr> <td>See Artisan Wood Finish Options</td> <td>For Artisan Only: Vertical Horizontal</td> </tr> </tbody> </table>			③a Wood Finish
③a Wood Finish	③b Chassis Grain Direction				
See Artisan Wood Finish Options	For Artisan Only: Vertical Horizontal				

Description	D	W	H	CTN WT	CU FT	① Model	List Price Per Grade
48" w Wall Mount Tack Panel 	1 9/16	48	23 1/2	20	3	FLB4824WT	COM \$761 A \$826 B \$839 C \$877 D \$932 E \$981 F \$1,037 G \$1,103 H \$1,204 I \$1,237 J \$1,324
	Features: · pair with primary height units and overhead cabinets or shelves to achieve 69" overall height · supported by wall cleat - hardware provided by installer · com ydg: 1 1/2						
42" w Wall Mount Tack Panel 	1 9/16	42	23 1/2	18	3	FLB4224WT	COM \$723 A \$788 B \$801 C \$840 D \$894 E \$943 F \$999 G \$1,066 H \$1,166 I \$1,199 J \$1,285
	Features: · pair with primary height units and overhead cabinets or shelves to achieve 69" overall height · supported by wall cleat - hardware provided by installer · com ydg: 1 1/2						
39" w Wall Mount Tack Panel 	1 9/16	39	23 1/2	18	3	FLB3924WT	COM \$705 A \$759 B \$770 C \$802 D \$847 E \$889 F \$935 G \$991 H \$1,075 I \$1,103 J \$1,176
	Features: · pair with primary height units and overhead cabinets or shelves to achieve 69" overall height · supported by wall cleat - hardware provided by installer · com ydg: 1 1/4						
36" w Wall Mount Tack Panel 	1 9/16	36	23 1/2	17	2	FLB3624WT	COM \$687 A \$741 B \$752 C \$785 D \$830 E \$871 F \$917 G \$973 H \$1,057 I \$1,085 J \$1,158
	Features: · pair with primary height units and overhead cabinets or shelves to achieve 69" overall height · supported by wall cleat - hardware provided by installer · com ydg: 1 1/4						

FLUX

Description	D	W	H	CTN WT	CU FT	① Model	List Price Per Grade
 33" w Wall Mount Tack Panel	1 9/16	33	23 1/2	17	2	FLB3324WT	COM \$670 A \$725 B \$736 C \$768 D \$813 E \$854 F \$901 G \$956 H \$1,040 I \$1,068 J \$1,140
Features: <ul style="list-style-type: none"> · pair with primary height units and overhead cabinets or shelves to achieve 69" overall height · supported by wall cleat - hardware provided by installer · com ydg: 1 1/4 							
 30" w Wall Mount Tack Panel	1 9/16	30	23 1/2	16	2	FLB3024WT	COM \$650 A \$694 B \$703 C \$728 D \$764 E \$797 F \$835 G \$879 H \$947 I \$970 J \$1,029
Features: <ul style="list-style-type: none"> · pair with primary height units and overhead cabinets or shelves to achieve 69" overall height · supported by wall cleat - hardware provided by installer · com ydg: 1 							
 24" w Wall Mount Tack Panel	1 9/16	24	23 1/2	14	2	FLB2424WT	COM \$615 A \$658 B \$667 C \$693 D \$729 E \$762 F \$799 G \$843 H \$911 I \$934 J \$993
Features: <ul style="list-style-type: none"> · pair with primary height units and overhead cabinets or shelves to achieve 69" overall height · supported by wall cleat - hardware provided by installer · com ydg: 1 							
 18" w Wall Mount Tack Panel	1 9/16	18	23 1/2	11	2	FLB1824WT	COM \$580 A \$623 B \$632 C \$658 D \$694 E \$727 F \$764 G \$809 H \$876 I \$899 J \$957
Features: <ul style="list-style-type: none"> · pair with primary height units and overhead cabinets or shelves to achieve 69" overall height · supported by wall cleat - hardware provided by installer · com ydg: 1 							

To Order, Specify:

- ① Model Number
- ② Fabric Selection - vendor, pattern and color

Description	D	W	H	CTN WT	CU FT	① Model	Laminate	Essentials Veneer	Artisan Veneer
Wall Mount Panel 	1 1/16	48	31 1/2	42	4	FLT4832WMP	\$1,026		
	1 1/16	48	31 1/2	42	4	FLV4832WMP		\$1,614	\$1,776
	1 1/16	42	31 1/2	38	4	FLT4232WMP	\$1,006		
	1 1/16	42	31 1/2	38	4	FLV4232WMP		\$1,582	\$1,741
	1 1/16	39	31 1/2	36	3	FLT3932WMP	\$981		
	1 1/16	39	31 1/2	36	3	FLV3932WMP		\$1,547	\$1,703
	1 1/16	36	31 1/2	33	3	FLT3632WMP	\$959		
	1 1/16	36	31 1/2	33	3	FLV3632WMP		\$1,512	\$1,664
	1 1/16	33	31 1/2	31	3	FLT3332WMP	\$936		
	1 1/16	33	31 1/2	31	3	FLV3332WMP		\$1,478	\$1,626
	1 1/16	30	31 1/2	28	3	FLT3032WMP	\$912		
	1 1/16	30	31 1/2	28	3	FLV3032WMP		\$1,443	\$1,589
	1 1/16	24	31 1/2	23	2	FLT2432WMP	\$894		
	1 1/16	24	31 1/2	23	2	FLV2432WMP		\$1,415	\$1,558
	1 1/16	18	31 1/2	18	2	FLT1832WMP	\$877		
	1 1/16	18	31 1/2	18	2	FLV1832WMP		\$1,385	\$1,523

Features:

- pair with secondary height units and overhead cabinets or shelves to achieve 69" overall height
- supported by wall cleat - hardware provided by installer
- grain direction runs vertical on essentials veneer, horizontal on laminate
- spacing of attachment cleats allows wire management

Options:

- must specify chassis grain direction on artisan veneer, see pages 13-15 for details

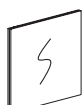
Description	D	W	H	CTN WT	CU FT	① Model	List Price
Wall Mount Markerboard 	1 1/16	48	31 1/2	42	4	FLB4832WMMB	\$1,169
	1 1/16	42	31 1/2	38	4	FLB4232WMMB	\$1,145
	1 1/16	39	31 1/2	36	3	FLB3932WMMB	\$1,118
	1 1/16	36	31 1/2	33	3	FLB3632WMMB	\$1,091
	1 1/16	33	31 1/2	31	3	FLB3332WMMB	\$1,063
	1 1/16	30	31 1/2	28	3	FLB3032WMMB	\$1,040
	1 1/16	24	31 1/2	23	2	FLB2432WMMB	\$1,018
	1 1/16	18	31 1/2	18	2	FLB1832WMMB	\$997

Features:

- pair with secondary height units and overhead cabinets or shelves to achieve 69" overall height
- supported by wall cleat - hardware provided by installer
- standard markerboard laminate with aluminum pvc edge
- spacing of attachment cleats allows wire management

Description	D	W	H	CTN WT	CU FT	① Model	List Price
 Wall Mount Glass Markerboard	1 9/16	48	31 1/2	58	3	FLB4832WMMBG	\$2,949
	1 9/16	42	31 1/2	51	3	FLB4232WMMBG	\$2,551
	1 9/16	39	31 1/2	47	3	FLB3932WMMBG	\$2,436
	1 9/16	36	31 1/2	43	3	FLB3632WMMBG	\$2,321
	1 9/16	33	31 1/2	40	3	FLB3332WMMBG	\$2,210
	1 9/16	30	31 1/2	36	2	FLB3032WMMBG	\$2,095
	1 9/16	24	31 1/2	29	2	FLB2432WMMBG	\$1,868
	1 9/16	18	31 1/2	22	2	FLB1832WMMBG	\$1,640

Features:

- pair with secondary height units and overhead cabinets or shelves to achieve 69" overall height
- supported by wall cleat - hardware provided by installer
- white back painted glass with an aluminum profile frame
- spacing of attachment cleats allows wire management

FLUX

To Order, Specify:

① Laminate Model #	② Laminate Selection	③ Metal Color	④ Other Product Options
Laminate (FLT)	See Laminate Selection	See Metal Finish Color Options	See list of options for each specific unit; Specify and add accordingly.

① Veneer Model #	② Wood Collection	③ Wood Finish	④ Metal Color	⑤ Other Product Options	
Veneer (FLV)	Essentials	See Essentials Wood Finish Options	See Metal Finish Color Options	See list of options for each specific unit; Specify and add accordingly.	
	Artisan	<table border="1"> <thead> <tr> <th>③a Wood Finish</th> <th>③b Chassis Grain Direction</th> </tr> </thead> <tbody> <tr> <td>See Artisan Wood Finish Options</td> <td>For Artisan Only: Vertical Horizontal</td> </tr> </tbody> </table>			③a Wood Finish
③a Wood Finish	③b Chassis Grain Direction				
See Artisan Wood Finish Options	For Artisan Only: Vertical Horizontal				

Description	D	W	H	CTN WT	CU FT	① Model	List Price Per Grade
	48" w Wall Mount Tack Panel	1 5/16	48	31 1/2	27	4	FLB4832WT
	COM						\$857
	A						\$922
	B						\$936
	C						\$974
	D						\$1,028
	E						\$1,078
	F						\$1,134
	G						\$1,200
	H						\$1,302
I						\$1,335	
J						\$1,423	
	42" w Wall Mount Tack Panel	1 5/16	42	31 1/2	25	3	FLB4232WT
	COM						\$811
	A						\$876
	B						\$889
	C						\$928
	D						\$982
	E						\$1,032
	F						\$1,087
	G						\$1,154
	H						\$1,255
I						\$1,288	
J						\$1,375	
	39" w Wall Mount Tack Panel	1 5/16	39	31 1/2	24	3	FLB3932WT
	COM						\$786
	A						\$840
	B						\$851
	C						\$883
	D						\$928
	E						\$970
	F						\$1,016
	G						\$1,072
	H						\$1,157
I						\$1,185	
J						\$1,259	
	36" w Wall Mount Tack Panel	1 5/16	36	31 1/2	23	3	FLB3632WT
	COM						\$763
	A						\$817
	B						\$828
	C						\$860
	D						\$905
	E						\$947
	F						\$993
	G						\$1,048
	H						\$1,134
I						\$1,162	
J						\$1,235	

Features:

- pair with secondary height units and overhead cabinets or shelves to achieve 69" overall height
- supported by wall cleat - hardware provided by installer
- com ydg: 1 1/2

Features:

- pair with secondary height units and overhead cabinets or shelves to achieve 69" overall height
- supported by wall cleat - hardware provided by installer
- com ydg: 1 1/2





Features:

- pair with secondary height units and overhead cabinets or shelves to achieve 69" overall height
- supported by wall cleat - hardware provided by installer
- com ydg: 1 1/4

Features:

- pair with secondary height units and overhead cabinets or shelves to achieve 69" overall height
- supported by wall cleat - hardware provided by installer
- com ydg: 1 1/4

FLUX

Description	D	W	H	CTN WT	CU FT	① Model	List Price Per Grade
33" w Wall Mount Tack Panel	1 9/16	33	31 1/2	22	3	FLB3332WT	COM \$739 A \$793 B \$804 C \$836 D \$881 E \$922 F \$969 G \$1,024 H \$1,109 I \$1,137 J \$1,210
	Features: <ul style="list-style-type: none"> · pair with secondary height units and overhead cabinets or shelves to achieve 69" overall height · supported by wall cleat - hardware provided by installer · com ydg: 1 1/4 						
30" w Wall Mount Tack Panel	1 9/16	30	31 1/2	21	3	FLB3032WT	COM \$713 A \$757 B \$766 C \$791 D \$827 E \$860 F \$898 G \$942 H \$1,011 I \$1,034 J \$1,094
	Features: <ul style="list-style-type: none"> · pair with secondary height units and overhead cabinets or shelves to achieve 69" overall height · supported by wall cleat - hardware provided by installer · com ydg: 1 						
24" w Wall Mount Tack Panel	1 9/16	24	31 1/2	18	2	FLB2432WT	COM \$663 A \$706 B \$715 C \$741 D \$777 E \$810 F \$847 G \$892 H \$960 I \$983 J \$1,042
	Features: <ul style="list-style-type: none"> · pair with secondary height units and overhead cabinets or shelves to achieve 69" overall height · supported by wall cleat - hardware provided by installer · com ydg: 1 						
18" w Wall Mount Tack Panel	1 9/16	18	31 1/2	14	2	FLB1832WT	COM \$617 A \$660 B \$669 C \$695 D \$731 E \$764 F \$801 G \$845 H \$914 I \$936 J \$995
	Features: <ul style="list-style-type: none"> · pair with secondary height units and overhead cabinets or shelves to achieve 69" overall height · supported by wall cleat - hardware provided by installer · com ydg: 1 						

To Order, Specify:

- ① Model Number
- ② Fabric Selection - vendor, pattern and color

Description	D	W	H	CTN WT	CU FT	① Model	Laminate	Essentials Veneer	Artisan Veneer
Wall Mount Panel 	1 1/16	48	48 13/16	63	6	FLT4849WMP	\$1,263		
	1 1/16	48	48 13/16	63	6	FLV4849WMP		\$1,986	\$2,192
	1 1/16	42	48 13/16	56	5	FLT4249WMP	\$1,237		
	1 1/16	42	48 13/16	56	5	FLV4249WMP		\$1,947	\$2,142
	1 1/16	39	48 13/16	53	5	FLT3949WMP	\$1,209		
	1 1/16	39	48 13/16	53	5	FLV3949WMP		\$1,904	\$2,095
	1 1/16	36	48 13/16	49	4	FLT3649WMP	\$1,179		
	1 1/16	36	48 13/16	49	4	FLV3649WMP		\$1,862	\$2,047
	1 1/16	33	48 13/16	45	4	FLT3349WMP	\$1,150		
	1 1/16	33	48 13/16	45	4	FLV3349WMP		\$1,820	\$2,002
	1 1/16	30	48 13/16	42	4	FLT3049WMP	\$1,123		
	1 1/16	30	48 13/16	42	4	FLV3049WMP		\$1,778	\$1,955
	1 1/16	24	48 13/16	35	3	FLT2449WMP	\$1,100		
	1 1/16	24	48 13/16	35	3	FLV2449WMP		\$1,742	\$1,916
	1 1/16	18	48 13/16	27	3	FLT1849WMP	\$1,081		
1 1/16	18	48 13/16	27	3	FLV1849WMP		\$1,705	\$1,875	

Features:

- pair with secondary height units to achieve 69" overall height
- supported by wall cleat - hardware provided by installer
- grain direction runs vertical on essentials veneer, horizontal on laminate
- spacing of attachment cleats allows wire management

Options:

- must specify chassis grain direction on artisan veneer, see pages 13-15 for details

Description	D	W	H	CTN WT	CU FT	① Model	List Price
Wall Mount Markerboard 	1 1/16	48	48 13/16	63	6	FLB4849WMMB	\$1,488
	1 1/16	42	48 13/16	56	5	FLB4249WMMB	\$1,460
	1 1/16	39	48 13/16	53	5	FLB3949WMMB	\$1,427
	1 1/16	36	48 13/16	49	4	FLB3649WMMB	\$1,391
	1 1/16	33	48 13/16	45	4	FLB3349WMMB	\$1,357
	1 1/16	30	48 13/16	42	4	FLB3049WMMB	\$1,322
	1 1/16	24	48 13/16	35	3	FLB2449WMMB	\$1,297
	1 1/16	18	48 13/16	27	3	FLB1849WMMB	\$1,273

Features:

- pair with secondary height units to achieve 69" overall height
- supported by wall cleat - hardware provided by installer
- standard markerboard laminate with aluminum pvc edge
- spacing of attachment cleats allows wire management

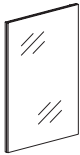
Description	D	W	H	CTN WT	CU FT	① Model	List Price
 Wall Mount Glass Markerboard	1 9/16	48	48 13/16	89	5	FLB4849WMMBG	\$4,037
	1 9/16	42	48 13/16	78	4	FLB4249WMMBG	\$3,651
	1 9/16	39	48 13/16	73	4	FLB3949WMMBG	\$3,458
	1 9/16	36	48 13/16	67	4	FLB3649WMMBG	\$3,268
	1 9/16	33	48 13/16	61	4	FLB3349WMMBG	\$3,077
	1 9/16	30	48 13/16	56	3	FLB3049WMMBG	\$2,882
	1 9/16	24	48 13/16	45	3	FLB2449WMMBG	\$2,495
	1 9/16	18	48 13/16	34	2	FLB1849WMMBG	\$2,013

Features:





- pair with secondary height units to achieve 69" overall height
- supported by wall cleat - hardware provided by installer
- white back painted glass with an aluminum profile frame
- spacing of attachment cleats allows wire management

FLUX



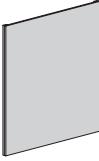

To Order, Specify:

① Laminate Model #	② Laminate Selection	③ Metal Color	④ Other Product Options
Laminate (FLT)	See Laminate Selection	See Metal Finish Color Options	See list of options for each specific unit; Specify and add accordingly.

① Veneer Model #	② Wood Collection	③ Wood Finish	④ Metal Color	⑤ Other Product Options	
Veneer (FLV)	Essentials	See Essentials Wood Finish Options	See Metal Finish Color Options	See list of options for each specific unit; Specify and add accordingly.	
	Artisan	<table border="1"> <thead> <tr> <th>③a Wood Finish</th> <th>③b Chassis Grain Direction</th> </tr> </thead> <tbody> <tr> <td>See Artisan Wood Finish Options</td> <td>For Artisan Only: Vertical Horizontal</td> </tr> </tbody> </table>			③a Wood Finish
③a Wood Finish	③b Chassis Grain Direction				
See Artisan Wood Finish Options	For Artisan Only: Vertical Horizontal				

Description	D	W	H	CTN WT	CU FT	① Model	List Price Per Grade			
 <p>48\"w Wall Mount Tack Panel</p> <p>Features:</p> <ul style="list-style-type: none"> · pair with secondary height units to achieve 69\" overall height · supported by wall cleat - hardware provided by installer · com ydg: 1 ½ 	1 ⅞	48	48 ¾	41	6	FLB4849WT	COM \$1,071 A \$1,136 B \$1,150 C \$1,188 D \$1,242 E \$1,292 F \$1,348 G \$1,414 H \$1,518 I \$1,553 J \$1,642			
	 <p>42\"w Wall Mount Tack Panel</p> <p>Features:</p> <ul style="list-style-type: none"> · pair with secondary height units to achieve 69\" overall height · supported by wall cleat - hardware provided by installer · com ydg: 1 ½ 	1 ⅞	42	48 ¾	38	5	FLB4249WT	COM \$996 A \$1,061 B \$1,074 C \$1,113 D \$1,167 E \$1,216 F \$1,272 G \$1,339 H \$1,442 I \$1,476 J \$1,565		
		 <p>39\"w Wall Mount Tack Panel</p> <p>Features:</p> <ul style="list-style-type: none"> · pair with secondary height units to achieve 69\" overall height · supported by wall cleat - hardware provided by installer · com ydg: 1 ¼ 	1 ⅞	39	48 ¾	37	5	FLB3949WT	COM \$959 A \$1,013 B \$1,024 C \$1,056 D \$1,102 E \$1,143 F \$1,189 G \$1,245 H \$1,332 I \$1,362 J \$1,436	
			 <p>36\"w Wall Mount Tack Panel</p> <p>Features:</p> <ul style="list-style-type: none"> · pair with secondary height units to achieve 69\" overall height · supported by wall cleat - hardware provided by installer · com ydg: 1 ¼ 	1 ⅞	36	48 ¾	36	4	FLB3649WT	COM \$921 A \$975 B \$987 C \$1,019 D \$1,064 E \$1,105 F \$1,152 G \$1,207 H \$1,294 I \$1,323 J \$1,398

FLUX

Description	D	W	H	CTN WT	CU FT	① Model	List Price Per Grade
33" w Wall Mount Tack Panel	1 9/16	33	48 3/4	34	4	FLB3349WT	COM \$884
 <p>Features:</p> <ul style="list-style-type: none"> · pair with secondary height units to achieve 69" overall height · supported by wall cleat - hardware provided by installer · com ydg: 1 1/4 	A						\$938
	B						\$949
	C						\$981
	D						\$1,026
	E						\$1,067
	F						\$1,114
	G						\$1,169
	H						\$1,255
	I						\$1,285
	J						\$1,359
30" w Wall Mount Tack Panel	1 9/16	30	48 3/4	33	4	FLB3049WT	COM \$845
 <p>Features:</p> <ul style="list-style-type: none"> · pair with secondary height units to achieve 69" overall height · supported by wall cleat - hardware provided by installer · com ydg: 1 	A						\$888
	B						\$897
	C						\$923
	D						\$959
	E						\$992
	F						\$1,029
	G						\$1,073
	H						\$1,143
	I						\$1,168
	J						\$1,229
24" w Wall Mount Tack Panel	1 9/16	24	48 3/4	28	3	FLB2449WT	COM \$770
 <p>Features:</p> <ul style="list-style-type: none"> · pair with secondary height units to achieve 69" overall height · supported by wall cleat - hardware provided by installer · com ydg: 1 	A						\$813
	B						\$822
	C						\$848
	D						\$884
	E						\$917
	F						\$954
	G						\$999
	H						\$1,068
	I						\$1,092
	J						\$1,152
18" w Wall Mount Tack Panel	1 9/16	18	48 3/4	22	3	FLB1849WT	COM \$698
 <p>Features:</p> <ul style="list-style-type: none"> · pair with secondary height units to achieve 69" overall height · supported by wall cleat - hardware provided by installer · com ydg: 1 	A						\$741
	B						\$750
	C						\$776
	D						\$812
	E						\$845
	F						\$882
	G						\$926
	H						\$995
	I						\$1,018
	J						\$1,078

To Order, Specify:

- ① Model Number
- ② Fabric Selection - vendor, pattern and color

Description	D	W	H	CTN WT	CU FT	① Model	Laminate	Essentials Veneer	Artisan Veneer
 Workwall Panel with Mini Shelf	8 1/2	48	23 1/2	50	13	FLT4824WPMS	\$1,165		
	8 1/2	48	23 1/2	50	13	FLV4824WPMS		\$1,823	\$2,006
	8 1/2	42	23 1/2	36	8	FLT4224WPMS	\$993		
	8 1/2	42	23 1/2	36	8	FLV4224WPMS		\$1,559	\$1,713
	8 1/2	39	23 1/2	34	7	FLT3924WPMS	\$968		
	8 1/2	39	23 1/2	34	7	FLV3924WPMS		\$1,524	\$1,677
	8 1/2	36	23 1/2	31	7	FLT3624WPMS	\$943		
	8 1/2	36	23 1/2	31	7	FLV3624WPMS		\$1,488	\$1,638
	8 1/2	33	23 1/2	28	6	FLT3324WPMS	\$921		
	8 1/2	33	23 1/2	28	6	FLV3324WPMS		\$1,454	\$1,602
	8 1/2	30	23 1/2	26	6	FLT3024WPMS	\$898		
	8 1/2	30	23 1/2	26	6	FLV3024WPMS		\$1,425	\$1,565
	8 1/2	24	23 1/2	29	7	FLT2424WPMS	\$998		
8 1/2	24	23 1/2	29	7	FLV2424WPMS		\$1,586	\$1,747	

Features:

- pair with primary height units and overhead cabinets or shelves to achieve 69" overall height
- supported by wall cleat - hardware provided by installer
- grain direction runs vertical on essentials veneer, horizontal on laminate
- spacing of attachment cleats allows wire management

Options:

- must specify chassis grain direction on artisan veneer, see pages 13-15 for details
- tackboard or markerboard available for above the shelf, see pages 360-361

 Workwall Panel with File Shelf	8 1/2	48	23 1/2	38	13	FLT4824WPFF	\$1,248		
	8 1/2	48	23 1/2	38	13	FLV4824WPFF		\$1,829	\$2,012
	8 1/2	42	23 1/2	36	8	FLT4224WPFF	\$1,221		
	8 1/2	42	23 1/2	36	8	FLV4224WPFF		\$1,787	\$1,965
	8 1/2	39	23 1/2	34	7	FLT3924WPFF	\$1,197		
	8 1/2	39	23 1/2	34	7	FLV3924WPFF		\$1,753	\$1,928
	8 1/2	36	23 1/2	31	7	FLT3624WPFF	\$1,173		
	8 1/2	36	23 1/2	31	7	FLV3624WPFF		\$1,716	\$1,889
	8 1/2	33	23 1/2	28	6	FLT3324WPFF	\$1,150		
	8 1/2	33	23 1/2	28	6	FLV3324WPFF		\$1,685	\$1,855
	8 1/2	30	23 1/2	26	6	FLT3024WPFF	\$1,128		
	8 1/2	30	23 1/2	26	6	FLV3024WPFF		\$1,651	\$1,819

Features:

- pair with primary height units and overhead cabinets or shelves to achieve 69" overall height
- supported by wall cleat - hardware provided by installer
- grain direction runs vertical on essentials veneer, horizontal on laminate
- file brackets for letter hanging file folders
- spacing of attachment cleats allows wire management

Options:

- must specify chassis grain direction on artisan veneer, see pages 13-15 for details
- tackboard or markerboard available for above the shelf, see pages 360-361

 Workwall Panel with File Shelf	8 1/2	24	23 1/2	26	7	FLT2424WPF	\$1,105		
	8 1/2	24	23 1/2	26	7	FLV2424WPF		\$1,621	\$1,781

Features:

- pair with primary height units and overhead cabinets or shelves to achieve 69" overall height
- supported by wall cleat - hardware provided by installer
- grain direction runs vertical on essentials veneer, horizontal on laminate
- file brackets for letter hanging file folders
- spacing of attachment cleats allows wire management

Options:

- must specify chassis grain direction on artisan veneer, see pages 13-15 for details
- tackboard or markerboard available for above the shelf, see pages 360-361

Description	D	W	H	CTN WT	CU FT	① Model	Laminate	Essentials Veneer	Artisan Veneer
 Workwall Panel with Accessory File Shelf	8 1/2	48	23 1/2	45	13	FLT4824WPCDF	\$1,248		
	8 1/2	48	23 1/2	45	13	FLV4824WPCDF		\$1,829	\$2,012
	8 1/2	42	23 1/2	37	8	FLT4224WPCDF	\$1,221		
	8 1/2	42	23 1/2	37	8	FLV4224WPCDF		\$1,787	\$1,965
	8 1/2	39	23 1/2	35	7	FLT3924WPCDF	\$1,197		
	8 1/2	39	23 1/2	35	7	FLV3924WPCDF		\$1,753	\$1,928
	8 1/2	36	23 1/2	33	7	FLT3624WPCDF	\$1,173		
	8 1/2	36	23 1/2	33	7	FLV3624WPCDF		\$1,716	\$1,889
	8 1/2	33	23 1/2	30	6	FLT3324WPCDF	\$1,150		
	8 1/2	33	23 1/2	30	6	FLV3324WPCDF		\$1,685	\$1,855
	8 1/2	30	23 1/2	27	6	FLT3024WPCDF	\$1,128		
	8 1/2	30	23 1/2	27	6	FLV3024WPCDF		\$1,651	\$1,819

Features:

- pair with primary height units and overhead cabinets or shelves to achieve 69" overall height
- supported by wall cleat - hardware provided by installer
- grain direction runs vertical on essentials veneer, horizontal on laminate
- file brackets for letter hanging file folders
- includes plastic tool accessories; pencil cup and paper clip dish
- spacing of attachment cleats allows wire management

Options:

- must specify grain direction on artisan veneer, see pages 13-15 for details
- tackboard or markerboard available for above the shelf, see pages 360-361

Description	D	W	H	CTN WT	CU FT	① Model	Laminate	Essentials Veneer	Artisan Veneer
 Workwall Panel with Accessory File Shelf	8 1/2	48	23 1/2	48	13	FLT4824WPFCD	\$1,248		
	8 1/2	48	23 1/2	48	13	FLV4824WPFCD		\$1,829	\$2,012
	8 1/2	42	23 1/2	38	8	FLT4224WPFCD	\$1,221		
	8 1/2	42	23 1/2	38	8	FLV4224WPFCD		\$1,787	\$1,965
	8 1/2	39	23 1/2	36	7	FLT3924WPFCD	\$1,197		
	8 1/2	39	23 1/2	36	7	FLV3924WPFCD		\$1,753	\$1,928
	8 1/2	36	23 1/2	34	7	FLT3624WPFCD	\$1,173		
	8 1/2	36	23 1/2	34	7	FLV3624WPFCD		\$1,716	\$1,889
	8 1/2	33	23 1/2	30	6	FLT3324WPFCD	\$1,150		
	8 1/2	33	23 1/2	30	6	FLV3324WPFCD		\$1,685	\$1,855
	8 1/2	30	23 1/2	28	6	FLT3024WPFCD	\$1,128		
	8 1/2	30	23 1/2	28	6	FLV3024WPFCD		\$1,651	\$1,819

Features:

- pair with primary height units and overhead cabinets or shelves to achieve 69" overall height
- supported by wall cleat - hardware provided by installer
- grain direction runs vertical on essentials veneer, horizontal on laminate
- file brackets for letter hanging file folders
- includes plastic tool accessories; pencil cup and paper clip dish
- spacing of attachment cleats allows wire management

Options:

- must specify grain direction on artisan veneer, see pages 13-15 for details
- tackboard or markerboard available for above the shelf, see pages 360-361

To Order, Specify:

① Laminate Model #	② Laminate Selection	③ Metal Color	④ Other Product Options
Laminate (FLT)	See Laminate Selection	See Metal Finish Color Options	See list of options for each specific unit; Specify and add accordingly.

① Veneer Model #	② Wood Collection	③ Wood Finish	④ Metal Color	⑤ Other Product Options		
Veneer (FLV)	Essentials	See Essentials Wood Finish Options	See Metal Finish Color Options	See list of options for each specific unit; Specify and add accordingly.		
	Artisan	<table border="1"> <thead> <tr> <th>ⓐ Wood Finish</th> <th>ⓑ Chassis Grain Direction</th> </tr> </thead> <tbody> <tr> <td>See Artisan Wood Finish Options</td> <td>For Artisan Only: Vertical Horizontal</td> </tr> </tbody> </table>	ⓐ Wood Finish		ⓑ Chassis Grain Direction	See Artisan Wood Finish Options
ⓐ Wood Finish	ⓑ Chassis Grain Direction					
See Artisan Wood Finish Options	For Artisan Only: Vertical Horizontal					

Description	D	W	H	CTN WT	CU FT	① Model	Laminate	Essentials Veneer	Artisan Veneer
Workwall Panel with Accessory Shelf 	8 1/2	48	23 1/2	47	13	FLT4824WPCDT	\$1,248		
	8 1/2	48	23 1/2	47	13	FLV4824WPCDT		\$1,829	\$2,012
	8 1/2	42	23 1/2	38	8	FLT4224WPCDT	\$1,221		
	8 1/2	42	23 1/2	38	8	FLV4224WPCDT		\$1,787	\$1,965
	8 1/2	39	23 1/2	36	7	FLT3924WPCDT	\$1,197		
	8 1/2	39	23 1/2	36	7	FLV3924WPCDT		\$1,753	\$1,928
	8 1/2	36	23 1/2	34	7	FLT3624WPCDT	\$1,173		
	8 1/2	36	23 1/2	34	7	FLV3624WPCDT		\$1,716	\$1,889
	8 1/2	33	23 1/2	30	6	FLT3324WPCDT	\$1,150		
	8 1/2	33	23 1/2	30	6	FLV3324WPCDT		\$1,685	\$1,855
	8 1/2	30	23 1/2	28	6	FLT3024WPCDT	\$1,128		
	8 1/2	30	23 1/2	28	6	FLV3024WPCDT		\$1,651	\$1,819
	8 1/2	24	23 1/2	27	7	FLT2424WPCDT	\$1,108		
	8 1/2	24	23 1/2	27	7	FLV2424WPCDT		\$1,621	\$1,781

Features:

- pair with primary height units and overhead cabinets or shelves to achieve 69" overall height
- supported by wall cleat - hardware provided by installer
- grain direction runs vertical on essentials veneer, horizontal on laminate
- file brackets for letter hanging file folders
- includes plastic tool accessories; pencil cup, paper clip dish and utility tray

Options:

- spacing of attachment cleats allows wire management
- must specify grain direction on artisan veneer, see pages 13-15 for details

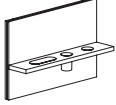
Description	D	W	H	CTN WT	CU FT	① Model	Laminate	Essentials Veneer	Artisan Veneer
Workwall Panel with Accessory Shelf 	8 1/2	48	23 1/2	50	13	FLT4824WPTCD	\$1,248		
	8 1/2	48	23 1/2	50	13	FLV4824WPTCD		\$1,829	\$2,012
	8 1/2	42	23 1/2	38	8	FLT4224WPTCD	\$1,221		
	8 1/2	42	23 1/2	38	8	FLV4224WPTCD		\$1,787	\$1,965
	8 1/2	39	23 1/2	36	7	FLT3924WPTCD	\$1,197		
	8 1/2	39	23 1/2	36	7	FLV3924WPTCD		\$1,753	\$1,928
	8 1/2	36	23 1/2	34	7	FLT3624WPTCD	\$1,173		
	8 1/2	36	23 1/2	34	7	FLV3624WPTCD		\$1,716	\$1,889
	8 1/2	33	23 1/2	30	6	FLT3324WPTCD	\$1,150		
	8 1/2	33	23 1/2	30	6	FLV3324WPTCD		\$1,685	\$1,855
	8 1/2	30	23 1/2	28	6	FLT3024WPTCD	\$1,128		
	8 1/2	30	23 1/2	28	6	FLV3024WPTCD		\$1,651	\$1,819
	8 1/2	24	23 1/2	27	7	FLT2424WPTCD	\$1,108		
	8 1/2	24	23 1/2	27	7	FLV2424WPTCD		\$1,621	\$1,781

Features:

- pair with primary height units and overhead cabinets or shelves to achieve 69" overall height
- supported by wall cleat - hardware provided by installer
- grain direction runs vertical on essentials veneer, horizontal on laminate
- includes black plastic tool accessories; pencil cup, paper clip dish and utility tray
- spacing of attachment cleats allows wire management

Options:

- must specify grain direction on artisan veneer, see pages 13-15 for details
- tackboard or markerboard available for above the shelf, see pages 360-361

To Order, Specify:

① Laminate Model #	② Laminate Selection	③ Metal Color	④ Other Product Options
Laminate (FLT)	See Laminate Selection	See Metal Finish Color Options	See list of options for each specific unit; Specify and add accordingly.

① Veneer Model #	② Wood Collection	③ Wood Finish	④ Metal Color	⑤ Other Product Options		
Veneer (FLV)	Essentials	See Essentials Wood Finish Options	See Metal Finish Color Options	See list of options for each specific unit; Specify and add accordingly.		
	Artisan	<table border="1"> <thead> <tr> <th>③a Wood Finish</th> <th>③b Chassis Grain Direction</th> </tr> </thead> <tbody> <tr> <td>See Artisan Wood Finish Options</td> <td>For Artisan Only: Vertical Horizontal</td> </tr> </tbody> </table>	③a Wood Finish		③b Chassis Grain Direction	See Artisan Wood Finish Options
③a Wood Finish	③b Chassis Grain Direction					
See Artisan Wood Finish Options	For Artisan Only: Vertical Horizontal					

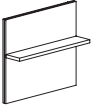
Description	D	W	H	CTN WT	CU FT	① Model	Laminate	Essentials Veneer	Artisan Veneer
 Workwall Panel with Mini Shelf	8 1/2	48	31 1/2	58	17	FLT4832WPMS	\$1,158		
	8 1/2	48	31 1/2	58	17	FLV4832WPMS		\$1,820	\$2,003
	8 1/2	42	31 1/2	44	10	FLT4232WPMS	\$1,129		
	8 1/2	42	31 1/2	44	10	FLV4232WPMS		\$1,777	\$1,953
	8 1/2	39	31 1/2	41	9	FLT3932WPMS	\$1,101		
	8 1/2	39	31 1/2	41	9	FLV3932WPMS		\$1,737	\$1,909
	8 1/2	36	31 1/2	38	9	FLT3632WPMS	\$1,076		
	8 1/2	36	31 1/2	38	9	FLV3632WPMS		\$1,699	\$1,868
	8 1/2	33	31 1/2	35	8	FLT3332WPMS	\$1,049		
	8 1/2	33	31 1/2	35	8	FLV3332WPMS		\$1,659	\$1,825
	8 1/2	30	31 1/2	32	7	FLT3032WPMS	\$1,023		
	8 1/2	30	31 1/2	32	7	FLV3032WPMS		\$1,623	\$1,784
	8 1/2	24	31 1/2	34	9	FLT2432WPMS	\$983		
8 1/2	24	31 1/2	34	9	FLV2432WPMS		\$1,586	\$1,747	

Features:

- pair with secondary height units and overhead cabinets or shelves to achieve 69" overall height
- supported by wall cleat - hardware provided by installer
- grain direction runs vertical on essentials veneer, horizontal on laminate
- spacing of attachment cleats allows wire management

Options:

- must specify grain direction on artisan veneer, see pages 13-15 for details
- tackboard or markerboard available for above the shelf, see pages 360-361

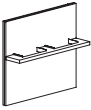
 Workwall Panel with File Shelf	8 1/2	48	31 1/2	51	17	FLT4832WPFF	\$1,389		
	8 1/2	48	31 1/2	51	17	FLV4832WPFF		\$2,047	\$2,252
	8 1/2	42	31 1/2	44	10	FLT4232WPFF	\$1,360		
	8 1/2	42	31 1/2	44	10	FLV4232WPFF		\$2,006	\$2,209
	8 1/2	39	31 1/2	41	9	FLT3932WPFF	\$1,330		
	8 1/2	39	31 1/2	41	9	FLV3932WPFF		\$1,965	\$2,162
	8 1/2	36	31 1/2	38	9	FLT3632WPFF	\$1,304		
	8 1/2	36	31 1/2	38	9	FLV3632WPFF		\$1,925	\$2,118
	8 1/2	33	31 1/2	35	8	FLT3332WPFF	\$1,278		
	8 1/2	33	31 1/2	35	8	FLV3332WPFF		\$1,887	\$2,077
	8 1/2	30	31 1/2	32	7	FLT3032WPFF	\$1,253		
	8 1/2	30	31 1/2	32	7	FLV3032WPFF		\$1,850	\$2,036

Features:

- pair with secondary height units and overhead cabinets or shelves to achieve 69" overall height
- supported by wall cleat - hardware provided by installer
- grain direction runs vertical on essentials veneer, horizontal on laminate
- file brackets for letter hanging file folders

Options:

- must specify grain direction on artisan veneer, see pages 13-15 for details
- tackboard or markerboard available for above the shelf, see pages 360-361

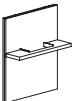
 Workwall Panel with File Shelf	8 1/2	24	31 1/2	31	9	FLT2432WPF	\$1,227		
	8 1/2	24	31 1/2	31	9	FLV2432WPF		\$2,011	\$2,212

Features:

- pair with secondary height units and overhead cabinets or shelves to achieve 69" overall height
- supported by wall cleat - hardware provided by installer
- grain direction runs vertical on essentials veneer, horizontal on laminate
- file brackets for letter hanging file folders

Options:

- must specify grain direction on artisan veneer, see pages 13-15 for details
- tackboard or markerboard available for above the shelf, see pages 360-361

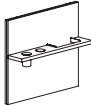
Description	D	W	H	CTN WT	CU FT	① Model	Laminate	Essentials Veneer	Artisan Veneer
Workwall Panel with Accessory File Shelf 	8 1/2	48	31 1/2	55	17	FLT4832WPCDF	\$1,389		
	8 1/2	48	31 1/2	55	17	FLV4832WPCDF		\$2,047	\$2,252
	8 1/2	42	31 1/2	46	10	FLT4232WPCDF	\$1,360		
	8 1/2	42	31 1/2	46	10	FLV4232WPCDF		\$2,006	\$2,209
	8 1/2	39	31 1/2	43	9	FLT3932WPCDF	\$1,330		
	8 1/2	39	31 1/2	43	9	FLV3932WPCDF		\$1,965	\$2,162
	8 1/2	36	31 1/2	40	9	FLT3632WPCDF	\$1,304		
	8 1/2	36	31 1/2	40	9	FLV3632WPCDF		\$1,925	\$2,118
	8 1/2	33	31 1/2	36	8	FLT3332WPCDF	\$1,278		
	8 1/2	33	31 1/2	36	8	FLV3332WPCDF		\$1,887	\$2,077
	8 1/2	30	31 1/2	33	7	FLT3032WPCDF	\$1,253		
	8 1/2	30	31 1/2	33	7	FLV3032WPCDF		\$1,850	\$2,036

Features:

- pair with secondary height units and overhead cabinets or shelves to achieve 69" overall height
- supported by wall cleat - hardware provided by installer
- grain direction runs vertical on essentials veneer, horizontal on laminate
- file brackets for letter hanging file folders
- includes plastic tool accessories; pencil cup and paper clip dish
- spacing of attachment cleats allows wire management

Options:

- must specify grain direction on artisan veneer, see pages 13-15 for details
- tackboard or markerboard available for above the shelf, see pages 360-361

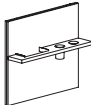
Description	D	W	H	CTN WT	CU FT	① Model	Laminate	Essentials Veneer	Artisan Veneer
Workwall Panel with Accessory File Shelf 	8 1/2	48	31 1/2	58	17	FLT4832WPFCD	\$1,389		
	8 1/2	48	31 1/2	58	17	FLV4832WPFCD		\$2,047	\$2,252
	8 1/2	42	31 1/2	46	10	FLT4232WPFCD	\$1,360		
	8 1/2	42	31 1/2	46	10	FLV4232WPFCD		\$2,006	\$2,209
	8 1/2	39	31 1/2	43	9	FLT3932WPFCD	\$1,330		
	8 1/2	39	31 1/2	43	9	FLV3932WPFCD		\$1,965	\$2,162
	8 1/2	36	31 1/2	40	9	FLT3632WPFCD	\$1,304		
	8 1/2	36	31 1/2	40	9	FLV3632WPFCD		\$1,925	\$2,118
	8 1/2	33	31 1/2	36	8	FLT3332WPFCD	\$1,278		
	8 1/2	33	31 1/2	36	8	FLV3332WPFCD		\$1,887	\$2,077
	8 1/2	33	31 1/2	33	7	FLT3032WPFCD	\$1,253		
	8 1/2	33	31 1/2	33	7	FLV3032WPFCD		\$1,850	\$2,036

Features:

- pair with secondary height units and overhead cabinets or shelves to achieve 69" overall height
- supported by wall cleat - hardware provided by installer
- grain direction runs vertical on essentials veneer, horizontal on laminate
- file brackets for letter hanging file folders
- includes plastic tool accessories; pencil cup and paper clip dish
- spacing of attachment cleats allows wire management

Options:

- must specify chassis grain direction on artisan veneer, see pages 13-15 for details

To Order, Specify:

① Laminate Model #	② Laminate Selection	③ Metal Color	④ Other Product Options
Laminate (FLT)	See Laminate Selection	See Metal Finish Color Options	See list of options for each specific unit; Specify and add accordingly.

① Veneer Model #	② Wood Collection	③ Wood Finish	④ Metal Color	⑤ Other Product Options
Veneer (FLV)	Essentials	See Essentials Wood Finish Options	See Metal Finish Color Options	See list of options for each specific unit; Specify and add accordingly.
		<table border="1"> <thead> <tr> <th>③a Wood Finish</th> <th>③b Chassis Grain Direction</th> </tr> </thead> <tbody> <tr> <td>See Artisan Wood Finish Options</td> <td>For Artisan Only: Vertical Horizontal</td> </tr> </tbody> </table>		
③a Wood Finish	③b Chassis Grain Direction			
See Artisan Wood Finish Options	For Artisan Only: Vertical Horizontal			

FLUX

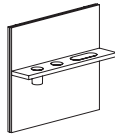
Description	D	W	H	CTN WT	CU FT	① Model	Laminate	Essentials Veneer	Artisan Veneer
Workwall Panel with Accessory Shelf 	8 ½	48	31 ½	56	17	FLT4832WPCDT	\$1,389		
	8 ½	48	31 ½	56	17	FLV4832WPCDT		\$2,047	\$2,252
	8 ½	42	31 ½	47	10	FLT4232WPCDT	\$1,360		
	8 ½	42	31 ½	47	10	FLV4232WPCDT		\$2,006	\$2,209
	8 ½	39	31 ½	44	9	FLT3932WPCDT	\$1,330		
	8 ½	39	31 ½	44	9	FLV3932WPCDT		\$1,965	\$2,162
	8 ½	36	31 ½	41	9	FLT3632WPCDT	\$1,304		
	8 ½	36	31 ½	41	9	FLV3632WPCDT		\$1,925	\$2,118
	8 ½	33	31 ½	37	8	FLT3332WPCDT	\$1,278		
	8 ½	33	31 ½	37	8	FLV3332WPCDT		\$1,887	\$2,077
	8 ½	30	31 ½	34	7	FLT3032WPCDT	\$1,253		
	8 ½	30	31 ½	34	7	FLV3032WPCDT		\$1,850	\$2,036
	8 ½	24	31 ½	31	9	FLT2432WPCDT	\$1,227		
	8 ½	24	31 ½	31	9	FLV2432WPCDT		\$2,011	\$2,212

Features:

- pair with secondary height units and overhead cabinets or shelves to achieve 69" overall height
- supported by wall cleat - hardware provided by installer
- grain direction runs vertical on essentials veneer, horizontal on laminate
- includes plastic tool accessories; pencil cup, paper clip dish and utility tray
- spacing of attachment cleats allows wire management

Options:

- must specify grain direction on artisan veneer, see pages 13-15 for details
- tackboard or markerboard available for above the shelf, see pages 360-361

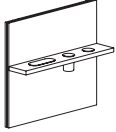
Description	D	W	H	CTN WT	CU FT	① Model	Laminate	Essentials Veneer	Artisan Veneer
Workwall Panel with Accessory Shelf 	8 1/2	48	31 1/2	59	17	FLT4832WPTCD	\$1,389		
	8 1/2	48	31 1/2	59	17	FLV4832WPTCD		\$2,047	\$2,252
	8 1/2	42	31 1/2	47	10	FLT4232WPTCD	\$1,360		
	8 1/2	42	31 1/2	47	10	FLV4232WPTCD		\$2,006	\$2,209
	8 1/2	39	31 1/2	44	9	FLT3932WPTCD	\$1,330		
	8 1/2	39	31 1/2	44	9	FLV3932WPTCD		\$1,965	\$2,162
	8 1/2	36	31 1/2	41	9	FLT3632WPTCD	\$1,304		
	8 1/2	36	31 1/2	41	9	FLV3632WPTCD		\$1,925	\$2,118
	8 1/2	33	31 1/2	37	8	FLT3332WPTCD	\$1,278		
	8 1/2	33	31 1/2	37	8	FLV3332WPTCD		\$1,887	\$2,077
	8 1/2	30	31 1/2	34	7	FLT3032WPTCD	\$1,253		
	8 1/2	30	31 1/2	34	7	FLV3032WPTCD		\$1,850	\$2,036
	8 1/2	24	31 1/2	34	9	FLT2432WPTCD	\$1,227		
	8 1/2	24	31 1/2	34	9	FLV2432WPTCD		\$2,011	\$2,212

Features:

- pair with secondary height units and overhead cabinets or shelves to achieve 69" overall height
- supported by wall cleat - hardware provided by installer
- grain direction runs vertical on essentials veneer, horizontal on laminate
- includes black plastic tool accessories; pencil cup, paper clip dish and utility tray
- spacing of attachment cleats allows wire management

Options:

- must specify grain direction on artisan veneer, see pages 13-15 for details
- tackboard or markerboard available for above the shelf, see pages 360-361

Description	D	W	H	CTN WT	CU FT	① Model	List Price
Work Tool Set	3	2	6	2	1	FLBWTOOLS	\$72

Features:

- work tool accessory set - utility cup, dish, and tray
- black plastic

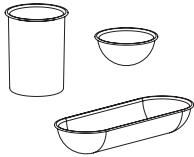

To Order, Specify:

① Laminate Model #	② Laminate Selection	③ Metal Color	④ Other Product Options
Laminate (FLT)	See Laminate Selection	See Metal Finish Color Options	See list of options for each specific unit; Specify and add accordingly.

① Veneer Model #	② Wood Collection	③ Wood Finish	④ Metal Color	⑤ Other Product Options		
Veneer (FLV)	Essentials	See Essentials Wood Finish Options	See Metal Finish Color Options	See list of options for each specific unit; Specify and add accordingly.		
	Artisan	<table border="1"> <thead> <tr> <th>③a Wood Finish</th> <th>③b Chassis Grain Direction</th> </tr> </thead> <tbody> <tr> <td>See Artisan Wood Finish Options</td> <td>For Artisan Only: Vertical Horizontal</td> </tr> </tbody> </table>	③a Wood Finish		③b Chassis Grain Direction	See Artisan Wood Finish Options
③a Wood Finish	③b Chassis Grain Direction					
See Artisan Wood Finish Options	For Artisan Only: Vertical Horizontal					

Description	D	W	H	CTN WT	CU FT	① Model	List Price
Workwall Panels	¾	48	12 ½			FLB4813MBA	\$359
Markerboard Add	1 ⅙	42	12 ⅙	15	2	FLB4213MBA	\$328
	1 ⅙	39	12 ⅙	14	2	FLB3913MBA	\$298
	1 ⅙	36	12 ⅙	13	1	FLB3613MBA	\$272
	1 ⅙	33	12 ⅙	12	1	FLB3313MBA	\$247
	1 ⅙	30	12 ⅙	11	1	FLB3013MBA	\$225
	¾	24	12 ½			FLB2413MBA	\$204

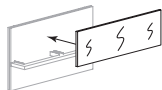

Features:

- mounts with magnets above the shelf - template included
- standard markerboard laminate with aluminum pvc edge

Description	D	W	H	CTN WT	CU FT	① Model	List Price Per Grade
48" w Insert Tackboard	¾	48	12 ½	5	2	FLB4813WTK	COM \$388

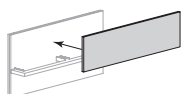

Features:

- attaches to cabinet interior, mounting hardware included
- com ydg: 1 ¾

- A \$464
- B \$479
- C \$524
- D \$587
- E \$645
- F \$710
- G \$788
- H \$901
- I \$935
- J \$1,032

42" w Insert Tackboard	1 ⅙	42	12 ⅙	4	2	FLB4213WTK	COM \$387
------------------------	-----	----	------	---	---	------------	-----------

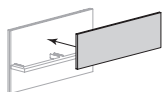

Features:

- attaches to cabinet interior, mounting hardware included
- com ydg: 1 ½

- A \$441
- B \$452
- C \$484
- D \$529
- E \$571
- F \$617
- G \$673
- H \$754
- I \$780
- J \$850

39" w Insert Tackboard	1 ⅙	39	12 ⅙	4	2	FLB3913WTK	COM \$376
------------------------	-----	----	------	---	---	------------	-----------

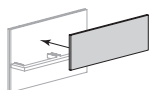

Features:

- attaches to cabinet interior, mounting hardware included
- com ydg: 1 ¼

- A \$431
- B \$442
- C \$474
- D \$519
- E \$560
- F \$607
- G \$662
- H \$744
- I \$769
- J \$839

FLUX

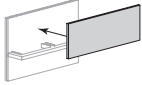
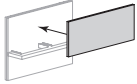
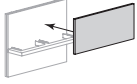
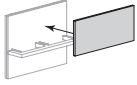
Description	D	W	H	CTN WT	CU FT	① Model	List Price Per Grade			
36" w Insert Tackboard  <p>Features:</p> <ul style="list-style-type: none"> attaches to cabinet interior, mounting hardware included com ydg: 1 ¼ 	1 9/16	36	12 11/16	4	2	FLB3613WTK	COM \$367 A \$421 B \$432 C \$464 D \$509 E \$551 F \$597 G \$653 H \$734 I \$759 J \$829			
	33" w Insert Tackboard  <p>Features:</p> <ul style="list-style-type: none"> attaches to cabinet interior, mounting hardware included com ydg: 1 ¼ 	1 9/16	33	12 11/16	3	2	FLB3313WTK	COM \$357 A \$412 B \$423 C \$455 D \$500 E \$541 F \$588 G \$643 H \$725 I \$750 J \$820		
		30" w Insert Tackboard  <p>Features:</p> <ul style="list-style-type: none"> attaches to cabinet interior, mounting hardware included com ydg: 1 	1 9/16	30	12 11/16	3	2	FLB3013WTK	COM \$350 A \$393 B \$402 C \$428 D \$464 E \$497 F \$534 G \$579 H \$644 I \$665 J \$721	
			24" w Insert Tackboard  <p>Features:</p> <ul style="list-style-type: none"> attaches to cabinet interior, mounting hardware included com ydg: 1 	¾	24	12 ½	2	2	FLB2413WTK	COM \$326 A \$369 B \$378 C \$404 D \$440 E \$473 F \$510 G \$555 H \$620 I \$640 J \$697

To Order, Specify:

- ① Model Number
- ② Fabric Selection - vendor, pattern and color

Description	D	W	H	CTN WT	CU FT	Model	Laminate	Essentials Veneer	Artisan Veneer
52" h Two Door Storage Tower	15 $\frac{1}{8}$ "	35 $\frac{1}{8}$ "	52	183	22	FLT1636-52STD	\$2,036		
	15 $\frac{1}{8}$ "	35 $\frac{1}{8}$ "	52	183	22	FLV1636-52STD		\$3,131	\$3,442
	15 $\frac{1}{8}$ "	29 $\frac{1}{8}$ "	52	169	19	FLT1630-52STD	\$1,685		
	15 $\frac{1}{8}$ "	29 $\frac{1}{8}$ "	52	169	19	FLV1630-52STD		\$2,590	\$2,850

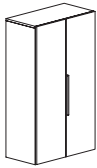

Features:

- use with primary height units, fastening hardware included
- laminate grain direction runs vertical on back panel of storage towers
- four adjustable shelves

Options:

- must specify chassis grain direction on artisan veneer, see pages 13-15 for details
- veneer door fronts in paint available, specify paint color and add \$354 list; see page 16 for details
- on laminate units, contrasting laminate door fronts available, no upcharge; specify laminate color, see page 16 for details
- white glass doors with aluminum trim available, specify and add \$2,676 list for 36" w, \$2,323 list for 30" w; see page 33 for details
- markerboard laminate doors available, specify and add \$465 list; see page 33 for details
- ledge pull standard on the right hinge door, prism pull available, specify and see page 9
- locking doors available, specify and add \$147 list (not available on glass doors)

52" h Sliding Door Storage Tower	15 $\frac{1}{8}$ "	35 $\frac{1}{8}$ "	52	182	22	FLT1636-52STSD	\$2,280		
	15 $\frac{1}{8}$ "	35 $\frac{1}{8}$ "	52	182	22	FLV1636-52STSD		\$3,505	\$3,855
	15 $\frac{1}{8}$ "	29 $\frac{1}{8}$ "	52	167	18	FLT1630-52STSD	\$1,887		
	15 $\frac{1}{8}$ "	29 $\frac{1}{8}$ "	52	167	18	FLV1630-52STSD		\$2,900	\$3,191

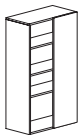
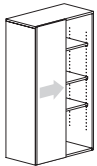

Features:

- use with primary height units, fastening hardware included
- laminate grain direction runs vertical on back panel of storage towers
- four adjustable shelves
- locking not available

Options:

- must specify chassis grain direction on artisan veneer, see pages 13-15 for details
- veneer door fronts in paint available, specify paint color and add \$354 list; see page 16 for details
- on laminate units, contrasting laminate door fronts available, no upcharge; specify laminate color, see page 16 for details
- white glass doors with aluminum trim available, specify and add \$1,384 list for 36" w, \$1,206 list for 30" w; see page 33 for details
- markerboard laminate doors available, specify and add \$301 list; see page 33 for details

52" h Open Storage Tower	15	35 $\frac{1}{8}$ "	52	136	21	FLT1536-52STO	\$1,386		
	15	35 $\frac{1}{8}$ "	52	136	21	FLV1536-52STO		\$2,128	\$2,343
	15	29 $\frac{1}{8}$ "	52	123	18	FLT1530-52STO	\$1,263		
	15	29 $\frac{1}{8}$ "	52	123	18	FLV1530-52STO		\$1,942	\$2,136

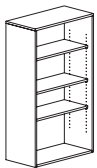

Features:

- use with primary height units, fastening hardware included
- laminate grain direction runs vertical on back panel of storage towers
- four adjustable shelves

Options:

- must specify chassis grain direction on artisan veneer, see pages 13-15 for details

52" h Side Wardrobe with Open Shelf	15 $\frac{1}{8}$ "	35 $\frac{1}{8}$ "	52	138	22	FLT1636-52STSWR	\$1,572		
	15 $\frac{1}{8}$ "	35 $\frac{1}{8}$ "	52	138	22	FLV1636-52STSWR		\$2,420	\$2,659
	15 $\frac{1}{8}$ "	35 $\frac{1}{8}$ "	52	137	22	FLT1636-52STSWL	\$1,572		
	15 $\frac{1}{8}$ "	35 $\frac{1}{8}$ "	52	137	22	FLV1636-52STSWL		\$2,420	\$2,659
	15 $\frac{1}{8}$ "	29 $\frac{1}{8}$ "	52	130	18	FLT1630-52STSWR	\$1,506		
	15 $\frac{1}{8}$ "	29 $\frac{1}{8}$ "	52	130	18	FLV1630-52STSWR		\$2,314	\$2,548
	15 $\frac{1}{8}$ "	29 $\frac{1}{8}$ "	52	129	18	FLT1630-52STSWL	\$1,506		
	15 $\frac{1}{8}$ "	29 $\frac{1}{8}$ "	52	129	18	FLV1630-52STSWL		\$2,314	\$2,548

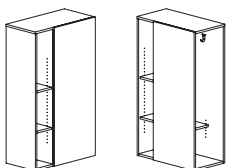

right shown

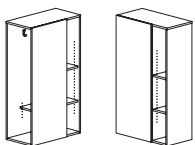

left

Features:

- use with primary height units, fastening hardware included
- side entry wardrobe with two coat hooks
- 8 $\frac{1}{4}$ " w open compartment with three adjustable shelves

Options:

- must specify chassis grain direction on artisan veneer, see pages 13-15 for details

Description	D	W	H	CTN WT	CU FT	① Model	Laminate	Essentials Veneer	Artisan Veneer
52" h Storage Tower	15 $\frac{7}{8}$	17 $\frac{7}{8}$	52	126	12	FLT1618-52STDR	\$1,328		
	15 $\frac{7}{8}$	17 $\frac{7}{8}$	52	126	12	FLV1618-52STDR		\$2,041	\$2,246
	15 $\frac{7}{8}$	17 $\frac{7}{8}$	52	126	12	FLT1618-52STDL	\$1,328		
	15 $\frac{7}{8}$	17 $\frac{7}{8}$	52	126	12	FLV1618-52STDL		\$2,041	\$2,246

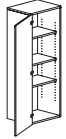

left shown

Features:

- use with primary height units, fastening hardware included
- laminate grain direction runs vertical on back panel of storage towers
- four adjustable shelves

Options:

- must specify chassis grain direction on artisan veneer, see pages 13-15 for details
- veneer door fronts in paint available, specify paint color and add \$354 list; see page 16 for details
- on laminate units, contrasting laminate door fronts available, no upcharge; specify laminate color, see page 16 for details
- white glass doors with aluminum trim available, specify and add \$1,340 list; see page 33 for details
- markerboard laminate doors available, specify and add \$301 list; see page 33 for details
- ledge pulls standard; prism pulls available, specify and see page 9
- locking door available, specify and add \$147 list (not available on glass door)

52" h Open Storage Tower	15	17 $\frac{7}{8}$	52	108	11	FLT1518-52STO	\$1,263		
	15	17 $\frac{7}{8}$	52	108	11	FLV1518-52STO		\$1,942	\$2,136

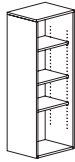

Features:

- use with primary height units, fastening hardware included
- laminate grain direction runs vertical on back panel of storage towers
- three adjustable shelves

Options:

- must specify chassis grain direction on artisan veneer, see pages 13-15 for details

To Order, Specify:

① Laminate Model #	② Laminate Selection	③ Metal Color	④ Other Product Options
Laminate (FLT)	See Laminate Selection	See Metal Finish Color Options	See list of options for each specific unit; Specify and add accordingly.

① Veneer Model #	② Wood Collection	③ Wood Finish	④ Metal Color	⑤ Other Product Options		
Veneer (FLV)	Essentials	See Essentials Wood Finish Options	See Metal Finish Color Options	See list of options for each specific unit; Specify and add accordingly.		
	Artisan	<table border="1"> <thead> <tr> <th>③a Wood Finish</th> <th>③b Chassis Grain Direction</th> </tr> </thead> <tbody> <tr> <td>See Artisan Wood Finish Options</td> <td>For Artisan Only: Vertical Horizontal</td> </tr> </tbody> </table>	③a Wood Finish		③b Chassis Grain Direction	See Artisan Wood Finish Options
③a Wood Finish	③b Chassis Grain Direction					
See Artisan Wood Finish Options	For Artisan Only: Vertical Horizontal					

Description	D	W	H	CTN WT	CU FT	① Model	Laminate	Essentials Veneer	Artisan Veneer
40" h Two Door Storage Tower	15 $\frac{7}{8}$ "	35 $\frac{7}{8}$ "	40	130	17	FLT1636-40STD	\$1,644		
	15 $\frac{7}{8}$ "	35 $\frac{7}{8}$ "	40	130	17	FLV1636-40STD		\$2,527	\$2,780
	15 $\frac{7}{8}$ "	29 $\frac{7}{8}$ "	40	115	14	FLT1630-40STD	\$1,361		
	15 $\frac{7}{8}$ "	29 $\frac{7}{8}$ "	40	115	14	FLV1630-40STD		\$2,092	\$2,300

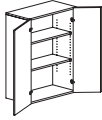
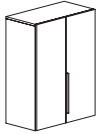

Features:

- use with primary height units, fastening hardware included
- laminate grain direction runs vertical on back panel of storage towers
- two adjustable shelves

Options:

- must specify chassis grain direction on artisan veneer, see pages 13-15 for details
- veneer door fronts in paint available, specify paint color and add \$354 list; see page 16 for details
- on laminate units, contrasting laminate door fronts available, no upcharge; specify laminate color, see page 16 for details
- white glass doors with aluminum trim available, specify and add \$2,136 list for 36" w, \$1,864 list for 30" w; see page 33 for details
- markerboard laminate doors available, specify and add \$465 list; see page 33 for details
- ledge pull standard on the right hinge door, prism pull available, specify and see page 9
- locking doors available, specify and add \$147 list (not available on glass doors)

40" h Sliding Door Storage Tower	15 $\frac{15}{16}$ "	35 $\frac{7}{8}$ "	40	129	17	FLT1636-40STSD	\$1,840		
	15 $\frac{15}{16}$ "	35 $\frac{7}{8}$ "	40	129	17	FLV1636-40STSD		\$2,829	\$3,114
	15 $\frac{15}{16}$ "	29 $\frac{7}{8}$ "	40	115	14	FLT1630-40STSD	\$1,524		
	15 $\frac{15}{16}$ "	29 $\frac{7}{8}$ "	40	115	14	FLV1630-40STSD		\$2,343	\$2,576

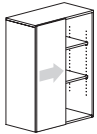

Features:

- use with primary height units, fastening hardware included
- laminate grain direction runs vertical on back panel of storage towers
- two adjustable shelves
- locking not available

Options:

- must specify chassis grain direction on artisan veneer, see pages 13-15 for details
- veneer door fronts in paint available, specify paint color and add \$354 list; see page 16 for details
- on laminate units, contrasting laminate door fronts available, no upcharge; specify laminate color, see page 16 for details
- white glass doors with aluminum trim available, specify and add \$1,136 list for 36" w, \$1,015 list for 30" w; see page 33 for details
- markerboard laminate doors available, specify and add \$301 list; see page 33 for details

40" h Open Storage Tower	15	35 $\frac{7}{8}$ "	40	103	16	FLT1536-40STO	\$1,118		
	15	35 $\frac{7}{8}$ "	40	103	16	FLV1536-40STO		\$1,718	\$1,893
	15	29 $\frac{7}{8}$ "	40	95	14	FLT1530-40STO	\$1,020		
	15	29 $\frac{7}{8}$ "	40	95	14	FLV1530-40STO		\$1,568	\$1,725

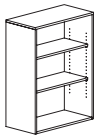

Features:

- use with primary height units, fastening hardware included
- laminate grain direction runs vertical on back panel of storage towers
- two adjustable shelves

Options:

- must specify chassis grain direction on artisan veneer, see pages 13-15 for details

40" h Side Wardrobe with Open Shelf	15 $\frac{15}{16}$ "	35 $\frac{7}{8}$ "	40	115	17	FLT1636-40STSWR	\$1,512		
	15 $\frac{15}{16}$ "	35 $\frac{7}{8}$ "	40	115	17	FLV1636-40STSWR		\$2,323	\$2,556
	15 $\frac{15}{16}$ "	35 $\frac{7}{8}$ "	40	115	17	FLT1636-40STSWL	\$1,512		
	15 $\frac{15}{16}$ "	35 $\frac{7}{8}$ "	40	115	17	FLV1636-40STSWL		\$2,323	\$2,556
	15 $\frac{15}{16}$ "	29 $\frac{7}{8}$ "	40	109	14	FLT1630-40STSWR	\$1,447		
	15 $\frac{15}{16}$ "	29 $\frac{7}{8}$ "	40	109	14	FLV1630-40STSWR		\$2,222	\$2,446
	15 $\frac{15}{16}$ "	29 $\frac{7}{8}$ "	40	109	14	FLT1630-40STSWL	\$1,447		
	15 $\frac{15}{16}$ "	29 $\frac{7}{8}$ "	40	109	14	FLV1630-40STSWL		\$2,222	\$2,446

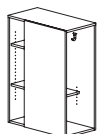
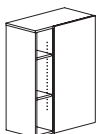

right shown

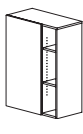
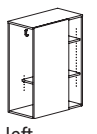

left

Features:

- use with primary height units, fastening hardware included
- side entry wardrobe with two coat hooks
- 8 $\frac{1}{4}$ " w open compartment with two adjustable shelves

Options:

- must specify chassis grain direction on artisan veneer, see pages 13-15 for details

Description	D	W	H	CTN WT	CU FT	① Model	Laminate	Essentials Veneer	Artisan Veneer
40" h Storage Tower	15 $\frac{7}{8}$	17 $\frac{7}{8}$	40	91	9	FLT1618-40STDR	\$1,073		
	15 $\frac{7}{8}$	17 $\frac{7}{8}$	40	91	9	FLV1618-40STDR		\$1,648	\$1,817
	15 $\frac{7}{8}$	17 $\frac{7}{8}$	40	91	10	FLT1618-40STD L	\$1,073		
	15 $\frac{7}{8}$	17 $\frac{7}{8}$	40	91	10	FLV1618-40STD L		\$1,648	\$1,817

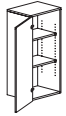

left shown

Features:

- use with primary height units, fastening hardware included
- laminate grain direction runs vertical on back panel of storage towers
- two adjustable shelves

Options:

- must specify chassis grain direction on artisan veneer, see pages 13-15 for details
- veneer door fronts in paint available, specify paint color and add \$354 list; see page 16 for details
- on laminate units, contrasting laminate door fronts available, no upcharge; specify laminate color, see page 16 for details
- white glass doors with aluminum trim available, specify and add \$1,070 list; see page 33 for details
- markerboard laminate doors available, specify and add \$301 list; see page 33 for details
- ledge pulls standard; prism pulls available, specify and see page 9
- locking door available, specify and add \$147 list (not available on glass door)

40" h Open Storage Tower	15	17 $\frac{7}{8}$	40	83	9	FLT1518-40STO	\$1,020		
	15	17 $\frac{7}{8}$	40	83	9	FLV1518-40STO		\$1,568	\$1,725

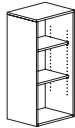

Features:

- use with primary height units, fastening hardware included
- laminate grain direction runs vertical on back panel of storage towers
- two adjustable shelves

Options:

- must specify chassis grain direction on artisan veneer, see pages 13-15 for details

To Order, Specify:

① Laminate Model #	② Laminate Selection	③ Metal Color	④ Other Product Options
Laminate (FLT)	See Laminate Selection	See Metal Finish Color Options	See list of options for each specific unit; Specify and add accordingly.

① Veneer Model #	② Wood Collection	③ Wood Finish	④ Metal Color	⑤ Other Product Options		
Veneer (FLV)	Essentials	See Essentials Wood Finish Options	See Metal Finish Color Options	See list of options for each specific unit; Specify and add accordingly.		
	Artisan	<table border="1"> <thead> <tr> <th>③a Wood Finish</th> <th>③b Chassis Grain Direction</th> </tr> </thead> <tbody> <tr> <td>See Artisan Wood Finish Options</td> <td>For Artisan Only: Vertical Horizontal</td> </tr> </tbody> </table>	③a Wood Finish		③b Chassis Grain Direction	See Artisan Wood Finish Options
③a Wood Finish	③b Chassis Grain Direction					
See Artisan Wood Finish Options	For Artisan Only: Vertical Horizontal					

Description	D	W	H	CTN WT	CU FT	① Model	Laminate	Essentials Veneer	Artisan Veneer
48" h Two Door Storage Tower	15 $\frac{1}{8}$ "	35 $\frac{7}{8}$ "	48	151	20	FLT1636-48STD	\$1,941		
	15 $\frac{1}{8}$ "	35 $\frac{7}{8}$ "	48	151	20	FLV1636-48STD		\$2,980	\$3,281
	15 $\frac{1}{8}$ "	29 $\frac{7}{8}$ "	48	137	17	FLT1630-48STD	\$1,605		
	15 $\frac{1}{8}$ "	29 $\frac{7}{8}$ "	48	137	17	FLV1630-48STD		\$2,468	\$2,712

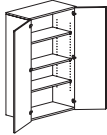
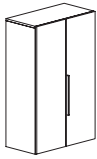

Features:

- use with secondary height units, fastening hardware included
- laminate grain direction runs vertical on back panel of storage towers
- three adjustable shelves

Options:

- must specify chassis grain direction on artisan veneer, see pages 13-15 for details
- veneer door fronts in paint available, specify paint color and add \$354 list; see page 16 for details
- on laminate units, contrasting laminate door fronts available, no upcharge; specify laminate color, see page 16 for details
- white glass doors with aluminum trim available, specify and add \$2,515 list for 36" w, \$2,191 list for 30" w; see page 33 for details
- markerboard laminate doors available, specify and add \$465 list; see page 33 for details
- ledge pull standard on the right hinge door, prism pull available, specify and see page 9
- locking doors available, specify and add \$147 list (not available on glass doors)

48" h Sliding Door Storage Tower	15 $\frac{1}{8}$ "	35 $\frac{7}{8}$ "	48	150	20	FLT1636-48STSD	\$2,172		
	15 $\frac{1}{8}$ "	35 $\frac{7}{8}$ "	48	150	20	FLV1636-48STSD		\$3,339	\$3,674
	15 $\frac{1}{8}$ "	29 $\frac{7}{8}$ "	48	136	17	FLT1630-48STSD	\$1,797		
	15 $\frac{1}{8}$ "	29 $\frac{7}{8}$ "	48	136	17	FLV1630-48STSD		\$2,764	\$3,039

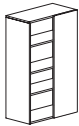
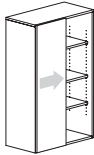

Features:

- use with secondary height units, fastening hardware included
- laminate grain direction runs vertical on back panel of storage towers
- three adjustable shelves
- locking not available

Options:

- must specify chassis grain direction on artisan veneer, see pages 13-15 for details
- veneer door fronts in paint available, specify paint color and add \$354 list; see page 16 for details
- on laminate units, contrasting laminate door fronts available, no upcharge; specify laminate color, see page 16 for details
- white glass doors with aluminum trim available, specify and add \$1,301 list for 36" w, \$1,139 list for 30" w; see page 33 for details
- markerboard laminate doors available, specify and add \$301 list; see page 33 for details

48" h Open Storage Tower	15	35 $\frac{7}{8}$ "	48	114	19	FLT1536-48STO	\$1,319		
	15	35 $\frac{7}{8}$ "	48	114	19	FLV1536-48STO		\$2,028	\$2,232
	15	29 $\frac{7}{8}$ "	48	104	16	FLT1530-48STO	\$1,204		
	15	29 $\frac{7}{8}$ "	48	104	16	FLV1530-48STO		\$1,848	\$2,035

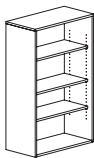

Features:

- use with secondary height units, fastening hardware included
- laminate grain direction runs vertical on back panel of storage towers
- three adjustable shelves

Options:

- must specify chassis grain direction on artisan veneer, see pages 13-15 for details

48" h Side Wardrobe with Open Shelf	15 $\frac{1}{8}$ "	35 $\frac{7}{8}$ "	48	121	20	FLT1636-48STSWR	\$1,544		
	15 $\frac{1}{8}$ "	35 $\frac{7}{8}$ "	48	121	20	FLV1636-48STSWR		\$2,371	\$2,607
	15 $\frac{1}{8}$ "	35 $\frac{7}{8}$ "	48	121	20	FLT1636-48STSWL	\$1,544		
	15 $\frac{1}{8}$ "	35 $\frac{7}{8}$ "	48	121	20	FLV1636-48STSWL		\$2,371	\$2,607
	15 $\frac{1}{8}$ "	29 $\frac{7}{8}$ "	48	114	17	FLT1630-48STSWR	\$1,477		
	15 $\frac{1}{8}$ "	29 $\frac{7}{8}$ "	48	114	17	FLV1630-48STSWR		\$2,268	\$2,495
	15 $\frac{1}{8}$ "	29 $\frac{7}{8}$ "	48	114	17	FLT1630-48STSWL	\$1,477		
	15 $\frac{1}{8}$ "	29 $\frac{7}{8}$ "	48	114	17	FLV1630-48STSWL		\$2,268	\$2,495

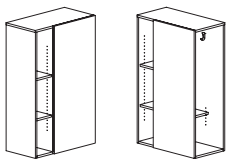

right shown

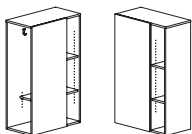

left

Features:

- use with secondary height units, fastening hardware included
- side entry wardrobe with two coat hooks
- 8 $\frac{1}{4}$ " w open compartment with three adjustable shelves

Options:

- must specify chassis grain direction on artisan veneer, see pages 13-15 for details

Description	D	W	H	CTN WT	CU FT	① Model	Laminate	Essentials Veneer	Artisan Veneer
48" h Storage Tower	15 $\frac{7}{8}$	17 $\frac{7}{8}$	48	105	11	FLT1618-48STDR	\$1,266		
	15 $\frac{7}{8}$	17 $\frac{7}{8}$	48	105	11	FLV1618-48STDR		\$1,945	\$2,141
	15 $\frac{7}{8}$	17 $\frac{7}{8}$	48	105	11	FLT1618-48STD	\$1,266		
	15 $\frac{7}{8}$	17 $\frac{7}{8}$	48	105	11	FLV1618-48STD		\$1,945	\$2,141

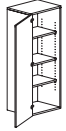
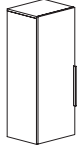

left shown

Features:

- use with secondary height units, fastening hardware included
- laminate grain direction runs vertical on back panel of storage towers
- three adjustable shelves

Options:

- must specify chassis grain direction on artisan veneer, see pages 13-15 for details
- veneer door fronts in paint available, specify paint color and add \$354 list; see page 16 for details
- on laminate units, contrasting laminate door fronts available, no upcharge; specify laminate color, see page 16 for details
- white glass doors with aluminum trim available, specify and add \$1,258 list; see page 33 for details
- markerboard laminate doors available, specify and add \$301 list; see page 33 for details
- ledge pulls standard; prism pulls available, specify and see page 9
- locking door available, specify and add \$147 list (not available on glass door)

48" h Open Storage Tower	15	17 $\frac{7}{8}$	48	92	10	FLT1518-48STO	\$1,204		
	15	17 $\frac{7}{8}$	48	92	10	FLV1518-48STO		\$1,848	\$2,035

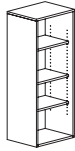

Features:

- use with secondary height units, fastening hardware included
- laminate grain direction runs vertical on back panel of storage towers
- three adjustable shelves

Options:

- must specify chassis grain direction on artisan veneer, see pages 13-15 for details

To Order, Specify:

① Laminate Model #	② Laminate Selection	③ Metal Color	④ Other Product Options
Laminate (FLT)	See Laminate Selection	See Metal Finish Color Options	See list of options for each specific unit; Specify and add accordingly.

① Veneer Model #	② Wood Collection	③ Wood Finish	④ Metal Color	⑤ Other Product Options		
Veneer (FLV)	Essentials	See Essentials Wood Finish Options	See Metal Finish Color Options	See list of options for each specific unit; Specify and add accordingly.		
	Artisan	<table border="1"> <thead> <tr> <th>③a Wood Finish</th> <th>③b Chassis Grain Direction</th> </tr> </thead> <tbody> <tr> <td>See Artisan Wood Finish Options</td> <td>For Artisan Only: Vertical Horizontal</td> </tr> </tbody> </table>	③a Wood Finish		③b Chassis Grain Direction	See Artisan Wood Finish Options
③a Wood Finish	③b Chassis Grain Direction					
See Artisan Wood Finish Options	For Artisan Only: Vertical Horizontal					

Description	D	W	H	CTN WT	CU FT	① Model	Laminate	Essentials Veneer	Artisan Veneer
Monitor Cabinet with Dual Shelf Storage	15 ¹⁵ / ₁₆	95 ⁷ / ₈	40	255	43	FLT1696-40STVS	\$3,811		
	15 ¹⁵ / ₁₆	95 ⁷ / ₈	40	255	43	FLV1696-40STVS		\$6,242	\$6,869
	15 ¹⁵ / ₁₆	89 ⁷ / ₈	40	243	41	FLT1690-40STVS	\$3,700		
	15 ¹⁵ / ₁₆	89 ⁷ / ₈	40	243	41	FLV1690-40STVS		\$6,063	\$6,667
	15 ¹⁵ / ₁₆	83 ⁷ / ₈	40	231	38	FLT1684-40STVS	\$3,591		
	15 ¹⁵ / ₁₆	83 ⁷ / ₈	40	231	38	FLV1684-40STVS		\$5,885	\$6,474

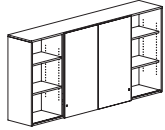
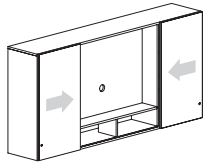

Features:

- use with primary height credenzas
- two adjustable shelves in storage section
- flat screen monitor may be mounted in media section
- divided shelf with oval grommet in back panel
- lock is standard on storage section only
- extreme back panel allows for monitor bracket mounting and wire pass through
- 95⁷/₈"w cabinet = 48" media section; monitor not to exceed 45" w x 29" h
- 89⁷/₈"w cabinet = 45" media section; monitor not to exceed 42" w x 29" h
- 83⁷/₈"w cabinet = 42" media section; monitor not to exceed 39" w x 29" h

Options:

- must specify chassis grain direction on artisan veneer, see pages 13-15 for details
- veneer door fronts in paint available, specify paint color and add \$354 list; see page 16 for details
- on laminate units, contrasting laminate door fronts available, no upcharge; specify laminate color, see page 16 for details
- white glass doors with aluminum trim available, specify and add \$2,808 list for 96" w, \$2,672 list for 90" w, \$2,536 list for 84" w; see page 33 for details
- markerboard laminate doors available, specify and add \$598 list; see page 33 for details

Description	Model	List Price Per Tackboard Fabric Grade											
		COM	A	B	C	D	E	F	G	H	I	J	
Monitor Cabinet with Dual Work-in-Process Storage	FLT1696-40PTVP	Laminate	\$4,581	\$4,723	\$4,752	\$4,837	\$4,955	\$5,064	\$5,186	\$5,332	\$5,579	\$5,674	\$5,888
	FLV1696-40PTVP	Essentials	\$7,070	\$7,212	\$7,241	\$7,325	\$7,444	\$7,552	\$7,675	\$7,820	\$8,089	\$8,205	\$8,440
		Artisan	\$7,650	\$7,792	\$7,821	\$7,905	\$8,024	\$8,132	\$8,255	\$8,400	\$8,669	\$8,785	\$9,020
	D - 15 1/8" W - 95 7/8" H - 40" CTN WT - 265 CU FT - 43												
	FLT1690-40PTVP	Laminate	\$4,459	\$4,601	\$4,631	\$4,715	\$4,833	\$4,942	\$5,064	\$5,210	\$5,456	\$5,550	\$5,763
	FLV1690-40PTVP	Essentials	\$6,872	\$7,014	\$7,043	\$7,128	\$7,246	\$7,355	\$7,477	\$7,623	\$7,890	\$8,004	\$8,237
		Artisan	\$7,437	\$7,579	\$7,608	\$7,693	\$7,811	\$7,920	\$8,042	\$8,188	\$8,455	\$8,569	\$8,802
	D - 15 1/8" W - 89 7/8" H - 40" CTN WT - 252 CU FT - 41												
	FLT1684-40PTVP	Laminate	\$4,338	\$4,481	\$4,510	\$4,594	\$4,713	\$4,821	\$4,944	\$5,089	\$5,334	\$5,427	\$5,639
	FLV1684-40PTVP	Essentials	\$6,684	\$6,827	\$6,856	\$6,940	\$7,059	\$7,167	\$7,290	\$7,435	\$7,701	\$7,814	\$8,045
		Artisan	\$7,234	\$7,377	\$7,406	\$7,490	\$7,609	\$7,717	\$7,840	\$7,985	\$8,251	\$8,364	\$8,595
	D - 15 1/8" W - 83 7/8" H - 40" CTN WT - 239 CU FT - 38												

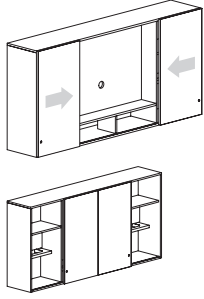

Features:

- use with primary height credenzas
- sliding doors
- locking is standard on sliding doors in closed storage position
- work sections contain lower letter size file opening shelf, tackboard, and fixed upper shelf
- flat screen monitor may be mounted in center section
- divided shelf with oval grommet in back panel
- extreme back panel allows for monitor bracket mounting and wire pass through
- 95 7/8" w cabinet = 48" w media section; monitor not to exceed 45" w x 29" h
- 89 7/8" w cabinet = 45" w media section; monitor not to exceed 42" w x 29" h
- 83 7/8" w cabinet = 42" w media section; monitor not to exceed 39" w x 29" h

Options:

- must specify chassis grain direction on artisan veneer, see pages 13-15 for details
- veneer door fronts in paint available, specify paint color and add \$354 list; see page 16 for details
- on laminate units, contrasting door fronts available, no upcharge; specify color, see page 16 for details
- white glass doors with aluminum trim available, specify and add \$2,808 list for 96" w, \$2,672 list for 90" w, \$2,536 list for 84" w; see page 33 for details
- markerboard laminate doors available, specify and add \$598 list; see page 33 for details
- tackboard included in work-in-process section
- com ydg: 95 7/8" w cabinet = 3; 89 7/8" w cabinet = 3; 83 7/8" w cabinet = 3

To Order, Specify:

1 Model Number	2 Fabric Selection
	Vendor Pattern Color Visit www.jsifurniture.com/finishes-and-materials/textiles for our textiles program. See selection of standard and graded in manufacturers and patterns.

To Order, Specify:

1 Laminate Model #	2 Laminate Selection	3 Metal Color	4 Other Product Options
Laminate (FLT)	See Laminate Selection	See Metal Finish Color Options	See list of options for each specific unit; Specify and add accordingly.

1 Veneer Model #	2 Wood Collection	3 Wood Finish	4 Metal Color	5 Other Product Options
Veneer (FLV)	Essentials	See Essentials Wood Finish Options	See Metal Finish Color Options	See list of options for each specific unit; Specify and add accordingly.
	Artisan	See Artisan Wood Finish Options	4b Chassis Grain Direction For Artisan Only: Vertical Horizontal	

Description	Model	List Price Per Tackboard Fabric Grade											
		COM	A	B	C	D	E	F	G	H	I	J	
Center Monitor Cabinet with Side Storage and Side Work-in-Process Storage	FLT1696-40STVP	Laminate	\$4,237	\$4,379	\$4,409	\$4,493	\$4,611	\$4,720	\$4,842	\$4,988	\$5,232	\$5,324	\$5,535
	FLV1696-40STVP	Essentials	\$6,726	\$6,868	\$6,897	\$6,982	\$7,100	\$7,209	\$7,331	\$7,477	\$7,742	\$7,856	\$8,087
		Artisan	\$7,309	\$7,451	\$7,480	\$7,565	\$7,683	\$7,792	\$7,914	\$8,060	\$8,325	\$8,439	\$8,670
	FLT1696-40PTVS	Laminate	\$4,237	\$4,379	\$4,409	\$4,493	\$4,611	\$4,720	\$4,842	\$4,988	\$5,232	\$5,324	\$5,535
	FLV1696-40PTVS	Essentials	\$6,726	\$6,868	\$6,897	\$6,982	\$7,100	\$7,209	\$7,331	\$7,477	\$7,742	\$7,856	\$8,087
		Artisan	\$7,309	\$7,451	\$7,480	\$7,565	\$7,683	\$7,792	\$7,914	\$8,060	\$8,325	\$8,439	\$8,670
D - 15 1/16 W - 95 7/8 H - 40 CTN WT - 260 CU FT - 43													

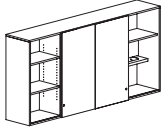
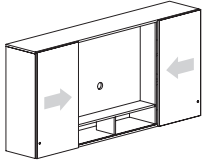

*STVP shown

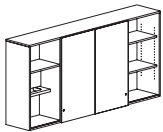

*PTVS

			COM	A	B	C	D	E	F	G	H	I	J
FLT1690-40STVP	Laminate		\$4,121	\$4,263	\$4,292	\$4,377	\$4,495	\$4,604	\$4,726	\$4,872	\$5,114	\$5,206	\$5,416
FLV1690-40STVP	Essentials		\$6,534	\$6,676	\$6,705	\$6,789	\$6,908	\$7,017	\$7,139	\$7,285	\$7,549	\$7,660	\$7,890
	Artisan		\$7,099	\$7,241	\$7,270	\$7,354	\$7,473	\$7,582	\$7,704	\$7,850	\$8,114	\$8,225	\$8,455
FLT1690-40PTVS	Laminate		\$4,121	\$4,263	\$4,292	\$4,377	\$4,495	\$4,604	\$4,726	\$4,872	\$5,114	\$5,206	\$5,416
FLV1690-40PTVS	Essentials		\$6,534	\$6,676	\$6,705	\$6,789	\$6,908	\$7,017	\$7,139	\$7,285	\$7,549	\$7,660	\$7,890
	Artisan		\$7,099	\$7,241	\$7,270	\$7,354	\$7,473	\$7,582	\$7,704	\$7,850	\$8,114	\$8,225	\$8,455
D - 15 1/16 W - 89 7/8 H - 40 CTN WT - 247 CU FT - 41													

Features:

- use with primary height credenzas
- sliding doors
- locking is standard on sliding doors in closed storage position
- one side, shelf section - two adjustable shelves
- flat screen monitor may be mounted in center section
- divided shelf with oval grommet in back panel
- extreme back panel allows for monitor bracket mounting and wire pass through
- 95 7/8" w cabinet = 48" w media section; monitor not to exceed 45" w x 29" h
- 89 7/8" w cabinet = 45" w media section; monitor not to exceed 42" w x 29" h

Options:

- must specify chassis grain direction on artisan veneer, see pages 13-15 for details
- veneer door fronts in paint available, specify paint color and add \$354 list; see page 16 for details
- on laminate units, contrasting door fronts available, no upcharge; specify color, see page 16 for details
- white glass doors with aluminum trim available, specify and add \$2,808 list for 96" w, \$2,672 list for 90" w; see page 33 for details
- markerboard laminate doors available, specify and add \$598 list; see page 33 for details
- tackboard included in work-in-process section
- com ydg: 95 7/8" w cabinet = 3; 89 7/8" w cabinet = 3

Description	① Model		List Price Per Tackboard Fabric Grade											
			COM	A	B	C	D	E	F	G	H	I	J	
Center Monitor Cabinet with Side Storage and Side Work-in-Process Storage	FLT1684-40STVP	Laminate	\$4,004	\$4,051	\$4,061	\$4,089	\$4,128	\$4,165	\$4,205	\$4,254	\$4,358	\$4,411	\$4,502	
		Essentials	\$6,350	\$6,397	\$6,407	\$6,435	\$6,474	\$6,511	\$6,551	\$6,600	\$6,725	\$6,797	\$6,908	
	FLV1684-40STVP	Artisan	\$6,899	\$6,946	\$6,956	\$6,984	\$7,023	\$7,060	\$7,100	\$7,149	\$7,274	\$7,346	\$7,457	
		Laminate	\$4,004	\$4,051	\$4,061	\$4,089	\$4,128	\$4,165	\$4,205	\$4,254	\$4,358	\$4,411	\$4,502	
	FLT1684-40PTVS	Essentials	\$6,350	\$6,397	\$6,407	\$6,435	\$6,474	\$6,511	\$6,551	\$6,600	\$6,725	\$6,797	\$6,908	
		Artisan	\$6,899	\$6,946	\$6,956	\$6,984	\$7,023	\$7,060	\$7,100	\$7,149	\$7,274	\$7,346	\$7,457	
	D - 15 1/16 W - 83 7/8 H - 40 CTN WT - 234 CU FT - 38													

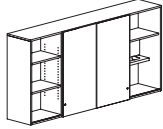
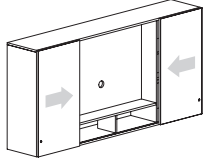

*STVP shown

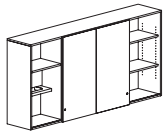

*PTVS

Features:

- use with primary height credenzas
- sliding doors
- locking is standard on sliding doors in closed storage position
- one side, shelf section - two adjustable shelves
- flat screen monitor may be mounted in center section
- divided shelf with oval grommet in back panel
- extreme back panel allows for monitor bracket mounting and wire pass through
- 42" w media section; monitor not to exceed 39" w x 29" h

Options:

- must specify chassis grain direction on artisan veneer, see pages 13-15 for details
- veneer door fronts in paint available, specify paint color and add \$354 list; see page 16 for details
- on laminate units, contrasting door fronts available, no upcharge; specify color, see page 16 for details
- white glass doors with aluminum trim available, specify and add \$2,536 list; see page 33 for details
- markerboard laminate doors available, specify and add \$598 list; see page 33 for details
- tackboard included in work-in-process section
- com ydg: 1

To Order, Specify:

① Model Number	② Fabric Selection	
	Vendor Pattern Color	Visit www.jsifurniture.com/finishes-and-materials/textiles for our textiles program. See selection of standard and graded in manufacturers and patterns.

To Order, Specify:

① Laminate Model #	② Laminate Selection	③ Metal Color	④ Other Product Options
Laminate (FLT)	See Laminate Selection	See Metal Finish Color Options	See list of options for each specific unit; Specify and add accordingly.

① Veneer Model #	② Wood Collection	③ Wood Finish	④ Metal Color	⑤ Other Product Options	
Veneer (FLV)	Essentials	See Essentials Wood Finish Options	See Metal Finish Color Options	See list of options for each specific unit; Specify and add accordingly.	
	Artisan	<table border="1"> <thead> <tr> <th>ⓐ Wood Finish</th> <th>ⓑ Chassis Grain Direction</th> </tr> </thead> <tbody> <tr> <td>See Artisan Wood Finish Options</td> <td>For Artisan Only: Vertical Horizontal</td> </tr> </tbody> </table>			ⓐ Wood Finish
ⓐ Wood Finish	ⓑ Chassis Grain Direction				
See Artisan Wood Finish Options	For Artisan Only: Vertical Horizontal				

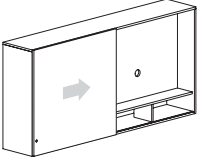
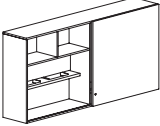
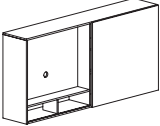
Description	Model	List Price Per Tackboard Fabric Grade												
		COM	A	B	C	D	E	F	G	H	I	J		
Monitor Cabinet with Work-in-Process Storage   *PTV shown  *TVP	FLT1696-40PTV	Laminate	\$4,259	\$4,330	\$4,345	\$4,387	\$4,446	\$4,500	\$4,562	\$4,634	\$4,775	\$4,839	\$4,962	
	FLV1696-40PTV	Essentials	\$6,710	\$6,781	\$6,795	\$6,838	\$6,897	\$6,951	\$7,012	\$7,085	\$7,248	\$7,332	\$7,475	
		Artisan	\$7,283	\$7,354	\$7,368	\$7,411	\$7,470	\$7,524	\$7,585	\$7,658	\$7,821	\$7,905	\$8,048	
	FLT1696-40TVP	Laminate	\$4,259	\$4,330	\$4,345	\$4,387	\$4,446	\$4,500	\$4,562	\$4,634	\$4,775	\$4,839	\$4,962	
		Essentials	\$6,710	\$6,781	\$6,795	\$6,838	\$6,897	\$6,951	\$7,012	\$7,085	\$7,248	\$7,332	\$7,475	
	Artisan	\$7,283	\$7,354	\$7,368	\$7,411	\$7,470	\$7,524	\$7,585	\$7,658	\$7,821	\$7,905	\$8,048		
D - 15 1/16 W - 95 7/8 H - 40 CTN WT - 257 CU FT - 43														
	FLT1690-40PTV	Laminate	\$4,137	\$4,208	\$4,223	\$4,265	\$4,324	\$4,379	\$4,440	\$4,512	\$4,652	\$4,715	\$4,837	
	FLV1690-40PTV	Essentials	\$6,518	\$6,589	\$6,603	\$6,645	\$6,705	\$6,759	\$6,820	\$6,893	\$7,054	\$7,137	\$7,278	
		Artisan	\$7,073	\$7,144	\$7,158	\$7,200	\$7,260	\$7,314	\$7,375	\$7,448	\$7,609	\$7,692	\$7,833	
	FLT1690-40TVP	Laminate	\$4,137	\$4,208	\$4,223	\$4,265	\$4,324	\$4,379	\$4,440	\$4,512	\$4,652	\$4,715	\$4,837	
		Essentials	\$6,518	\$6,589	\$6,603	\$6,645	\$6,705	\$6,759	\$6,820	\$6,893	\$7,054	\$7,137	\$7,278	
	Artisan	\$7,083	\$7,154	\$7,168	\$7,210	\$7,270	\$7,324	\$7,385	\$7,458	\$7,619	\$7,702	\$7,843		
D - 15 1/16 W - 89 7/8 H - 40 CTN WT - 243 CU FT - 41														
	FLT1684-40PTV	Laminate	\$4,021	\$4,092	\$4,107	\$4,149	\$4,208	\$4,262	\$4,324	\$4,396	\$4,535	\$4,597	\$4,718	
	FLV1684-40PTV	Essentials	\$6,329	\$6,400	\$6,415	\$6,457	\$6,516	\$6,570	\$6,632	\$6,704	\$6,864	\$6,945	\$7,085	
		Artisan	\$6,869	\$6,940	\$6,955	\$6,997	\$7,056	\$7,110	\$7,172	\$7,244	\$7,404	\$7,485	\$7,625	
	FLT1684-40TVP	Laminate	\$4,021	\$4,092	\$4,107	\$4,149	\$4,208	\$4,262	\$4,324	\$4,396	\$4,535	\$4,597	\$4,718	
		Essentials	\$6,329	\$6,400	\$6,415	\$6,457	\$6,516	\$6,570	\$6,632	\$6,704	\$6,864	\$6,945	\$7,085	
	Artisan	\$6,869	\$6,940	\$6,955	\$6,997	\$7,056	\$7,110	\$7,172	\$7,244	\$7,404	\$7,485	\$7,625		
D - 15 1/16 W - 83 7/8 H - 40 CTN WT - 231 CU FT - 38														
	FLT1678-40PTV	Laminate	\$3,904	\$3,963	\$3,975	\$4,010	\$4,060	\$4,105	\$4,156	\$4,216	\$4,337	\$4,393	\$4,499	
	FLV1678-40PTV	Essentials	\$6,146	\$6,205	\$6,218	\$6,253	\$6,302	\$6,347	\$6,398	\$6,459	\$6,599	\$6,674	\$6,798	
		Artisan	\$6,673	\$6,732	\$6,745	\$6,780	\$6,829	\$6,874	\$6,925	\$6,986	\$7,126	\$7,201	\$7,325	
	FLT1678-40TVP	Laminate	\$3,904	\$3,963	\$3,975	\$4,010	\$4,060	\$4,105	\$4,156	\$4,216	\$4,337	\$4,393	\$4,499	
		Essentials	\$6,146	\$6,205	\$6,218	\$6,253	\$6,302	\$6,347	\$6,398	\$6,459	\$6,599	\$6,674	\$6,798	
	Artisan	\$6,673	\$6,732	\$6,745	\$6,780	\$6,829	\$6,874	\$6,925	\$6,986	\$7,126	\$7,201	\$7,325		
D - 15 1/16 W - 77 7/8 H - 40 CTN WT - 218 CU FT - 35														

Features:

- use with primary height credenzas
- sliding door
- locking is standard on sliding doors in closed storage position
- work section - dual hanging letter size file pocket shelf with tackable surface above; upper fixed shelf
- flat screen monitor may be mounted in media section
- divided shelf with oval grommet in back panel
- extreme back panel allows for monitor bracket mounting and wire pass through
- 95 7/8" w cabinet = 48" w media section; monitor not to exceed 45" w x 29" h
- 89 7/8" w cabinet = 45" w media section; monitor not to exceed 42" w x 29" h
- 83 7/8" w cabinet = 42" w media section; monitor not to exceed 39" w x 29" h
- 77 7/8" w cabinet = 39" w media section; monitor not to exceed 36" w x 29" h

Options:

- must specify chassis grain direction on artisan veneer, see pages 13-15 for details
- veneer door fronts in paint available, specify paint color and add \$354 list; see page 16 for details
- on laminate units, contrasting door fronts available, no upcharge; specify color, see page 16 for details
- white glass doors with aluminum trim available, specify and add \$2,734 list for 96" w, \$2,354 list for 90" w, \$2,218 list for 84" w, \$2,083 list for 78" w; see page 33 for details
- markerboard laminate doors available, specify and add \$520 list; see page 33 for details
- tackboard included in work-in-process section
- com ydg: 95 7/8" w cabinet = 1 1/2; 89 7/8" w cabinet = 1 1/2; 83 7/8" w cabinet = 1 1/2; 77 7/8" w cabinet = 1 1/4

To Order, Specify:

1 Model Number	2 Fabric Selection
Vendor Pattern Color	Visit www.jsifurniture.com/finishes-and-materials/textiles for our textiles program. See selection of standard and graded in manufacturers and patterns.

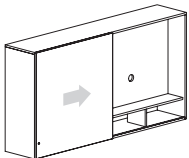
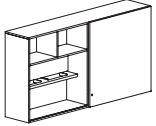
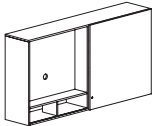
Description	Model		List Price Per Tackboard Fabric Grade											
			COM	A	B	C	D	E	F	G	H	I	J	
Monitor Cabinet with Work-in-Process Storage   *PTV shown  *TVP	FLT1672-40PTV	Laminate	\$3,859	\$3,918	\$3,930	\$3,965	\$4,015	\$4,060	\$4,111	\$4,172	\$4,292	\$4,348	\$4,453	
	FLV1672-40PTV	Essentials	\$6,081	\$6,140	\$6,152	\$6,187	\$6,237	\$6,282	\$6,333	\$6,393	\$6,533	\$6,608	\$6,731	
		Artisan	\$6,600	\$6,659	\$6,671	\$6,706	\$6,756	\$6,801	\$6,852	\$6,912	\$7,052	\$7,127	\$7,250	
	FLT1672-40TVP	Laminate	\$3,859	\$3,918	\$3,930	\$3,965	\$4,015	\$4,060	\$4,111	\$4,172	\$4,292	\$4,348	\$4,453	
		Essentials	\$6,081	\$6,140	\$6,152	\$6,187	\$6,237	\$6,282	\$6,333	\$6,393	\$6,533	\$6,608	\$6,731	
	FLV1672-40TVP	Artisan	\$6,600	\$6,659	\$6,671	\$6,706	\$6,756	\$6,801	\$6,852	\$6,912	\$7,052	\$7,127	\$7,250	
		D - 15 15/16 W - 71 7/8 H - 40 CTN WT - 205 CU FT - 33												
	*PTV shown *TVP	FLT1666-40PTV	Laminate	\$3,814	\$3,873	\$3,885	\$3,920	\$3,970	\$4,015	\$4,066	\$4,127	\$4,247	\$4,302	\$4,407
			Essentials	\$6,013	\$6,072	\$6,084	\$6,119	\$6,169	\$6,214	\$6,265	\$6,326	\$6,465	\$6,539	\$6,661
		FLV1666-40PTV	Artisan	\$6,526	\$6,585	\$6,597	\$6,632	\$6,682	\$6,727	\$6,778	\$6,839	\$6,978	\$7,052	\$7,174
			Laminate	\$3,814	\$3,873	\$3,885	\$3,920	\$3,970	\$4,015	\$4,066	\$4,127	\$4,247	\$4,302	\$4,407
		FLV1666-40TVP	Essentials	\$6,013	\$6,072	\$6,084	\$6,119	\$6,169	\$6,214	\$6,265	\$6,326	\$6,465	\$6,539	\$6,661
Artisan			\$6,526	\$6,585	\$6,597	\$6,632	\$6,682	\$6,727	\$6,778	\$6,839	\$6,978	\$7,052	\$7,174	
D - 15 15/16 W - 65 7/8 H - 40 CTN WT - 191 CU FT - 30														
FLT1660-40PTV		Laminate	\$3,770	\$3,818	\$3,827	\$3,855	\$3,895	\$3,931	\$3,972	\$4,020	\$4,123	\$4,173	\$4,263	
		Essentials	\$5,947	\$5,995	\$6,004	\$6,032	\$6,072	\$6,108	\$6,149	\$6,197	\$6,319	\$6,387	\$6,495	
FLV1660-40PTV		Artisan	\$7,457	\$7,505	\$7,514	\$7,542	\$7,582	\$7,618	\$7,659	\$7,707	\$7,829	\$7,897	\$8,005	
		Laminate	\$3,770	\$3,818	\$3,827	\$3,855	\$3,895	\$3,931	\$3,972	\$4,020	\$4,123	\$4,173	\$4,263	
FLV1660-40TVP		Essentials	\$5,947	\$5,995	\$6,004	\$6,032	\$6,072	\$6,108	\$6,149	\$6,197	\$6,319	\$6,387	\$6,495	
	Artisan	\$6,457	\$6,505	\$6,514	\$6,542	\$6,582	\$6,618	\$6,659	\$6,707	\$6,829	\$6,897	\$7,005		
D - 15 15/16 W - 59 7/8 H - 40 CTN WT - 180 CU FT - 27														

Features:

- use with primary height credenzas
- sliding door
- locking is standard on sliding doors in closed storage position
- work section - lower file shelf with full height tackboard; fixed upper shelf
- flat screen monitor may be mounted in media section
- divided shelf with oval grommet in back panel
- extreme back panel allows for monitor bracket mounting and wire pass through
- 71 7/8" w cabinet = 36" w media section; monitor not to exceed 33" w x 29" h
- 65 7/8" w cabinet = 33" w media section; monitor not to exceed 30" w x 29" h
- 59 7/8" w cabinet = 30" w media section; monitor not to exceed 27" w x 29" h

Options:

- must specify chassis grain direction on artisan veneer, see pages 13-15 for details
- veneer door fronts in paint available, specify paint color and add \$354 list; see page 16 for details
- on laminate units, contrasting door fronts available, no upcharge; specify color, see page 16 for details
- white glass doors with aluminum trim available, specify and add \$1,947 list for 72" w, \$1,812 list for 66" w, \$1,677 list for 60" w; see page 33 for details
- markerboard laminate doors available, specify and add \$520 list; see page 33 for details
- tackboard included in work-in-process section
- com ydg: 71 7/8" w cabinet = 1 1/4; 65 7/8" w cabinet = 1 1/4; 59 7/8" w cabinet = 1

To Order, Specify:

1 Laminate Model # Laminate (FLT)		2 Laminate Selection See Laminate Selection		3 Metal Color See Metal Finish Color Options	4 Other Product Options See list of options for each specific unit; Specify and add accordingly.
1 Veneer Model # Veneer (FLV)	2 Wood Collection Essentials	3 Wood Finish See Essentials Wood Finish Options		4 Metal Color See Metal Finish Color Options	5 Other Product Options See list of options for each specific unit; Specify and add accordingly.
	Artisan	3a Wood Finish See Artisan Wood Finish Options	3b Chassis Grain Direction For Artisan Only: Vertical Horizontal		

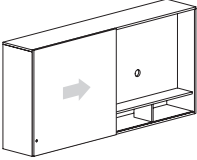
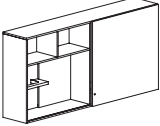
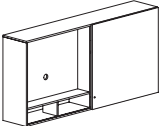
Description	Model	List Price Per Tackboard Fabric Grade												
		COM	A	B	C	D	E	F	G	H	I	J		
Monitor Cabinet with Side Work-in-Process Storage   *PTTV shown  *TVPT	FLT1696-40PTTV	Laminate	\$4,274	\$4,321	\$4,331	\$4,359	\$4,399	\$4,435	\$4,476	\$4,524	\$4,631	\$4,685	\$4,779	
	FLV1696-40PTTV	Essentials	\$6,725	\$6,772	\$6,782	\$6,810	\$6,849	\$6,886	\$6,926	\$6,975	\$7,103	\$7,178	\$7,292	
		Artisan	\$7,296	\$7,343	\$7,353	\$7,381	\$7,420	\$7,457	\$7,497	\$7,546	\$7,674	\$7,749	\$7,863	
	FLT1696-40TVPT	Laminate	\$4,274	\$4,321	\$4,331	\$4,359	\$4,399	\$4,435	\$4,476	\$4,524	\$4,631	\$4,685	\$4,779	
	FLV1696-40TVPT	Essentials	\$6,725	\$6,772	\$6,782	\$6,810	\$6,849	\$6,886	\$6,926	\$6,975	\$7,103	\$7,178	\$7,292	
		Artisan	\$7,296	\$7,343	\$7,353	\$7,381	\$7,420	\$7,457	\$7,497	\$7,546	\$7,674	\$7,749	\$7,863	
	D - 15 1/4" W - 95 7/8" H - 40" CTN WT - 252 CU FT - 43													
	FLT1690-40PTTV	Laminate	\$4,149	\$4,196	\$4,206	\$4,234	\$4,273	\$4,310	\$4,350	\$4,399	\$4,504	\$4,558	\$4,651	
	FLV1690-40PTTV	Essentials	\$6,529	\$6,576	\$6,586	\$6,614	\$6,654	\$6,690	\$6,731	\$6,779	\$6,906	\$6,979	\$7,092	
		Artisan	\$6,817	\$6,864	\$6,874	\$6,902	\$6,942	\$6,978	\$7,019	\$7,067	\$7,194	\$7,267	\$7,380	
	FLT1690-40TVPT	Laminate	\$4,149	\$4,196	\$4,206	\$4,234	\$4,273	\$4,310	\$4,350	\$4,399	\$4,504	\$4,558	\$4,651	
	FLV1690-40TVPT	Essentials	\$6,529	\$6,576	\$6,586	\$6,614	\$6,654	\$6,690	\$6,731	\$6,779	\$6,906	\$6,979	\$7,092	
Artisan		\$7,087	\$7,134	\$7,144	\$7,172	\$7,212	\$7,248	\$7,289	\$7,337	\$7,464	\$7,537	\$7,650		
D - 15 1/4" W - 89 7/8" H - 40" CTN WT - 238 CU FT - 41														
FLT1684-40PTTV	Laminate	\$4,030	\$4,078	\$4,087	\$4,115	\$4,155	\$4,191	\$4,232	\$4,280	\$4,385	\$4,437	\$4,529		
FLV1684-40PTTV	Essentials	\$6,340	\$6,388	\$6,398	\$6,426	\$6,465	\$6,501	\$6,542	\$6,591	\$6,716	\$6,787	\$6,898		
	Artisan	\$6,882	\$6,930	\$6,940	\$6,968	\$7,007	\$7,043	\$7,084	\$7,133	\$7,258	\$7,329	\$7,440		
FLT1684-40TVPT	Laminate	\$4,030	\$4,078	\$4,087	\$4,115	\$4,155	\$4,191	\$4,232	\$4,280	\$4,385	\$4,437	\$4,529		
FLV1684-40TVPT	Essentials	\$6,340	\$6,388	\$6,398	\$6,426	\$6,465	\$6,501	\$6,542	\$6,591	\$6,716	\$6,787	\$6,898		
	Artisan	\$6,882	\$6,930	\$6,940	\$6,968	\$7,007	\$7,043	\$7,084	\$7,133	\$7,258	\$7,329	\$7,440		
D - 15 1/4" W - 83 7/8" H - 40" CTN WT - 226 CU FT - 38														

Features:

- use with primary height credenzas
- sliding door
- locking is standard on sliding doors in closed storage position
- work section - one hanging letter size file pocket shelf with full height tackable surface; upper fixed shelf
- flat screen monitor may be mounted in media section
- divided shelf with oval grommet in back panel
- extreme back panel allows for monitor bracket mounting and wire pass through
- 95 7/8" w cabinet = 48" w media section; monitor not to exceed 45" w x 29" h
- 89 7/8" w cabinet = 45" w media section; monitor not to exceed 42" w x 29" h
- 83 7/8" w cabinet = 42" w media section; monitor not to exceed 39" w x 29" h

Options:

- must specify chassis grain direction on artisan veneer, see pages 13-15 for details
- veneer door fronts in paint available, specify paint color and add \$354 list; see page 16 for details
- on laminate units, contrasting door fronts available, no upcharge; specify color, see page 16 for details
- white glass doors with aluminum trim available, specify and add \$2,734 list for 96" w, \$2,354 list for 90" w, \$2,218 list for 84" w; see page 33 for details
- markerboard laminate doors available, specify and add \$520 list; see page 33 for details
- tackboard included in work-in-process section
- com ydg: 95 7/8" w cabinet = 1; 89 7/8" w cabinet = 1; 83 7/8" w cabinet = 1

To Order, Specify:

1 Model Number	2 Fabric Selection
Vendor Pattern Color	Visit www.jsifurniture.com/finishes-and-materials/textiles for our textiles program. See selection of standard and graded in manufacturers and patterns.

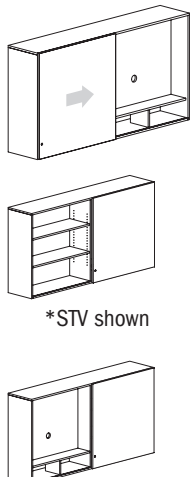
Description	D	W	H	CTN WT	CU FT	① Model	Laminate	Essentials Veneer	Artisan Veneer
 <p>*STV shown</p> <p>*TVS</p>	15 15/16	77 7/8	40	207	35	FLT1678-40STV	\$3,421		
	15 15/16	77 7/8	40	207	35	FLV1678-40STV		\$5,606	\$6,165
	15 15/16	77 7/8	40	207	35	FLT1678-40TVS	\$3,421		
	15 15/16	77 7/8	40	207	35	FLV1678-40TVS		\$5,606	\$6,165
	15 15/16	71 7/8	40	209	33	FLT1672-40STV	\$3,387		
	15 15/16	71 7/8	40	209	33	FLV1672-40STV		\$5,549	\$6,103
	15 15/16	71 7/8	40	209	33	FLT1672-40TVS	\$3,387		
	15 15/16	71 7/8	40	209	33	FLV1672-40TVS		\$5,549	\$6,103
	15 15/16	65 7/8	40	195	30	FLT1666-40STV	\$3,353		
	15 15/16	65 7/8	40	195	30	FLV1666-40STV		\$5,493	\$6,042
	15 15/16	65 7/8	40	195	30	FLT1666-40TVS	\$3,353		
	15 15/16	65 7/8	40	195	30	FLV1666-40TVS		\$5,493	\$6,042
	15 15/16	59 7/8	40	184	27	FLT1660-40STV	\$3,320		
	15 15/16	59 7/8	40	184	27	FLV1660-40STV		\$5,438	\$5,980
	15 15/16	59 7/8	40	184	27	FLT1660-40TVS	\$3,320		
	15 15/16	59 7/8	40	184	27	FLV1660-40TVS		\$5,438	\$5,980

Features:

- use with primary height credenzas
- two adjustable shelves in storage section
- flat screen monitor may be mounted in media section
- divided shelf with oval grommet in back panel
- lock is standard on storage section only
- extreme back panel allows for monitor bracket mounting and wire pass through
- 77 7/8" w cabinet = 39" w media section; monitor not to exceed 36" w x 29" h
- 71 7/8" w cabinet = 36" w media section; monitor not to exceed 33" w x 29" h
- 65 7/8" w cabinet = 33" w media section; monitor not to exceed 30" w x 29" h
- 59 7/8" w cabinet = 30" w media section; monitor not to exceed 27" w x 29" h

Options:

- must specify chassis grain direction on artisan veneer, see pages 13-15 for details
- veneer door fronts in paint available, specify paint color and add \$354 list; see page 16 for details
- on laminate units, contrasting laminate door fronts available, no upcharge; specify laminate color, see page 16 for details
- white glass doors with aluminum trim available, specify and add \$2,083 list for 78" w, \$1,947 list for 72" w, \$1,812 list for 66" w, \$1,677 list for 60" w; see page 33 for details
- markerboard laminate doors available, specify and add \$520 list; see page 33 for details

To Order, Specify:

① Laminate Model #	② Laminate Selection	③ Metal Color	④ Other Product Options
Laminate (FLT)	See Laminate Selection	See Metal Finish Color Options	See list of options for each specific unit; Specify and add accordingly.

① Veneer Model #	② Wood Collection	③ Wood Finish	④ Metal Color	⑤ Other Product Options		
Veneer (FLV)	Essentials	See Essentials Wood Finish Options	See Metal Finish Color Options	See list of options for each specific unit; Specify and add accordingly.		
	Artisan	<table border="1"> <thead> <tr> <th>ⓐ Wood Finish</th> <th>ⓑ Chassis Grain Direction</th> </tr> </thead> <tbody> <tr> <td>See Artisan Wood Finish Options</td> <td>For Artisan Only: Vertical Horizontal</td> </tr> </tbody> </table>	ⓐ Wood Finish		ⓑ Chassis Grain Direction	See Artisan Wood Finish Options
ⓐ Wood Finish	ⓑ Chassis Grain Direction					
See Artisan Wood Finish Options	For Artisan Only: Vertical Horizontal					

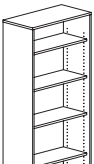
Description	D	W	H	CTN WT	CU FT	① Model	Laminate	Essentials Veneer	Artisan Veneer
	15	36	81	181	32	FLT1536-81FBC	\$1,635		
	15	36	81	181	32	FLV1536-81FBC		\$2,881	\$3,167
	15	30	81	169	27	FLT1530-81FBC	\$1,514		
	15	30	81	169	27	FLV1530-81FBC		\$2,704	\$2,976
	15	24	81	156	22	FLT1524-81FBC	\$1,396		
	15	24	81	156	22	FLV1524-81FBC		\$2,550	\$2,806

Features:

- square edge on top
- five adjustable shelves

Options:

- must specify chassis grain direction on artisan veneer, see pages 13-15 for details

	15	36	69	155	27	FLT1536-69FBC	\$1,558		
	15	36	69	155	27	FLV1536-69FBC		\$2,427	\$2,670
	15	30	69	142	23	FLT1530-69FBC	\$1,438		
	15	30	69	142	23	FLV1530-69FBC		\$2,343	\$2,576
	15	24	69	130	19	FLT1524-69FBC	\$1,323		
	15	24	69	130	19	FLV1524-69FBC		\$2,255	\$2,481

Features:

- square edge on top
- four adjustable shelves

Options:

- must specify chassis grain direction on artisan veneer, see pages 13-15 for details

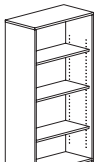
Description	D	W	H	CTN WT	CU FT	① Model	Laminate	Essentials Veneer	Artisan Veneer
	15	36	55 3/8	115	22	FLT1536-55FBC	\$1,403		
	15	36	55 3/8	115	22	FLV1536-55FBC		\$2,186	\$2,405
	15	30	55 3/8	108	19	FLT1530-55FBC	\$1,295		
	15	30	55 3/8	108	19	FLV1530-55FBC		\$2,107	\$2,319
	15	24	55 3/8	101	15	FLT1524-55FBC	\$1,192		
	15	24	55 3/8	101	15	FLV1524-55FBC		\$2,030	\$2,234

Features:

- square edge on top
- three adjustable shelves

Options:

- must specify chassis grain direction on artisan veneer, see pages 13-15 for details

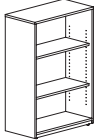
Description	D	W	H	CTN WT	CU FT	① Model	Laminate	Essentials Veneer	Artisan Veneer
	15	36	41 1/16	81	17	FLT1536-42FBC	\$1,151		
	15	36	41 1/16	81	17	FLV1536-42FBC		\$1,796	\$1,977
	15	30	41 1/16	76	14	FLT1530-42FBC	\$1,059		
	15	30	41 1/16	76	14	FLV1530-42FBC		\$1,734	\$1,907
	15	24	41 1/16	71	12	FLT1524-42FBC	\$984		
	15	24	41 1/16	71	12	FLV1524-42FBC		\$1,669	\$1,834

Features:

- square edge on top
- two adjustable shelves

Options:

- must specify chassis grain direction on artisan veneer, see pages 13-15 for details

To Order, Specify:

① Laminate Model #		② Laminate Selection		③ Metal Color		④ Other Product Options			
Laminate (FLT)		See Laminate Selection		See Metal Finish Color Options		See list of options for each specific unit; Specify and add accordingly.			
① Veneer Model #		② Wood Collection		③ Wood Finish		④ Metal Color		⑤ Other Product Options	
Veneer (FLV)		Essentials		See Essentials Wood Finish Options		See Metal Finish Color Options		See list of options for each specific unit; Specify and add accordingly.	

Description	D	W	H	CTN WT	CU FT	① Model	Laminate	Essentials Veneer	Artisan Veneer
Four Drawer Lateral File with Open Compartment	22	36	69	322	38	FLT2236-69F4LF0	\$3,322		
	22	36	69	322	38	FLV2236-69F4LF0		\$4,481	\$4,930
	22	30	69	305	32	FLT2230-69F4LF0	\$3,180		
	22	30	69	305	32	FLV2230-69F4LF0		\$4,255	\$4,685

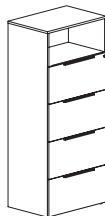

Features:

- square edge on top
- four drawers with open upper storage
- anti-tip interlock mechanism
- pedestal front locking

Options:

- must specify chassis grain direction on artisan veneer, see pages 13-15 for details
- veneer drawer fronts in paint available, specify paint color and add \$354 list; see page 16 for details
- on laminate units, contrasting drawer fronts available, no upcharge; specify color, see page 16 for details
- ledge pulls standard; prism pulls available, specify and see page 9

Four Drawer Lateral File with Hinge Door Storage Compartment	22	36	69	338	38	FLT2236-69F4LFD	\$3,515		
	22	36	69	338	38	FLV2236-69F4LFD		\$4,763	\$5,239
	22	30	69	321	32	FLT2230-69F4LFD	\$3,362		
	22	30	69	321	32	FLV2230-69F4LFD		\$4,539	\$4,992

FLUX

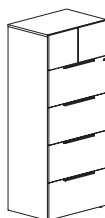

Features:

- square edge on top
- four drawers with hinged door upper compartment
- anti-tip interlock mechanism
- pedestal front locking

Options:

- must specify chassis grain direction on artisan veneer, see pages 13-15 for details
- veneer door and drawer fronts in paint available, specify paint color and add \$354 list; see page 16 for details
- on laminate units, contrasting door and drawer fronts available, no upcharge; specify color, see page 16 for details
- locking door available, specify and add \$147 list
- ledge pulls standard; prism pulls available, specify and see page 9

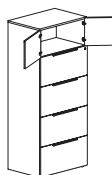

Description	D	W	H	CTN WT	CU FT	① Model	Laminate	Essentials Veneer	Artisan Veneer
Four Drawer Lateral File	22	36	55 3/8	287	31	FLT2236-55F4LF	\$2,636		
	22	36	55 3/8	287	31	FLV2236-55F4LF		\$3,557	\$3,912
	22	30	55 3/8	270	26	FLT2230-55F4LF	\$2,527		
	22	30	55 3/8	270	26	FLV2230-55F4LF		\$3,378	\$3,717



Features:

- four drawers
- anti-tip interlock mechanism
- pedestal front locking

Options:

- must specify chassis grain direction on artisan veneer, see pages 13-15 for details
- veneer drawer fronts in paint available, specify paint color and add \$354 list; see page 16 for details
- on laminate units, contrasting drawer fronts available, no upcharge; specify color, see page 16 for details
- ledge pulls standard; prism pulls available, specify and see page 9

Description	D	W	H	CTN WT	CU FT	① Model	Laminate	Essentials Veneer	Artisan Veneer
Three Drawer Lateral File	22	36	41 1/16	232	26	FLT2236-41F3LF	\$2,540		
	22	36	41 1/16	232	26	FLV2236-41F3LF		\$3,062	\$3,368
	22	30	41 1/16	218	20	FLT2230-41F3LF	\$2,390		
	22	30	41 1/16	218	20	FLV2230-41F3LF		\$2,885	\$3,174

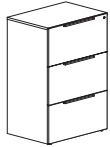

Features:

- three drawers
- anti-tip interlock mechanism
- pedestal front locking

Options:

- must specify chassis grain direction on artisan veneer, see pages 13-15 for details
- veneer drawer fronts in paint available, specify paint color and add \$354 list; see page 16 for details
- on laminate units, contrasting drawer fronts available, no upcharge; specify color, see page 16 for details
- ledge pulls standard; prism pulls available, specify and see page 9

To Order, Specify:

① Laminate Model #		② Laminate Selection		③ Metal Color	④ Other Product Options
Laminate (FLT)		See Laminate Selection		See Metal Finish Color Options	See list of options for each specific unit; Specify and add accordingly.
① Veneer Model #	② Wood Collection	③ Wood Finish		④ Metal Color	⑤ Other Product Options
Veneer (FLV)	Essentials	See Essentials Wood Finish Options		See Metal Finish Color Options	See list of options for each specific unit; Specify and add accordingly.
	Artisan	ⓐ Wood Finish See Artisan Wood Finish Options	ⓑ Chassis Grain Direction For Artisan Only: Vertical Horizontal		

Description	D	W	H	CTN WT	CU FT	① Model	Laminate	Essentials Veneer	Artisan Veneer
81" h Wardrobe	22	18	81	168	24	FLT2218-81FDWR	\$1,926		
	22	18	81	168	24	FLV2218-81FDWR		\$3,419	\$3,763
	22	18	81	168	24	FLT2218-81FDWL	\$1,926		
	22	18	81	168	24	FLV2218-81FDWL		\$3,419	\$3,763

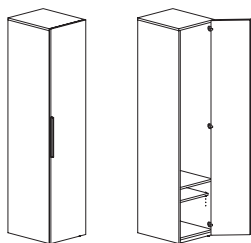

right shown

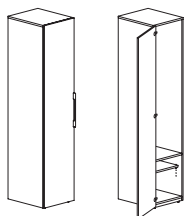

left

Features:

- lower adjustable shelf
- installed coat hooks

Options:

- must specify chassis grain direction on artisan veneer, see pages 13-15 for details
- veneer door front in paint available, specify paint color and add \$354 list; see page 16 for details
- on laminate units, contrasting doors fronts available, no upcharge; specify color, see page 16 for details
- locking door available, specify and add \$147 list
- ledge pulls standard, mounted vertical; prism pulls available, specify and see page 9
- vanity mirror available, specify and add \$149 list

81" h Storage Cabinet	22	18	81	188	24	FLT2218-81FDR	\$1,918		
	22	18	81	188	24	FLV2218-81FDR		\$3,410	\$3,752
	22	18	81	188	24	FLT2218-81FDL	\$1,918		
	22	18	81	188	24	FLV2218-81FDL		\$3,410	\$3,752

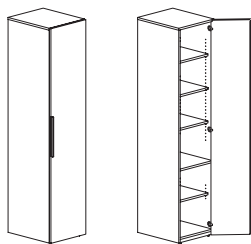

right shown

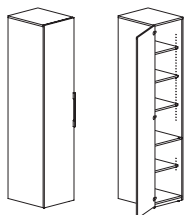

left

Features:

- five adjustable shelves

Options:

- must specify chassis grain direction on artisan veneer, see pages 13-15 for details
- veneer door front in paint available, specify paint color and add \$354 list; see page 16 for details
- on laminate units, contrasting doors fronts available, no upcharge; specify color, see page 16 for details
- locking door available, specify and add \$147 list
- ledge pulls standard, mounted vertical; prism pulls available, specify and see page 9
- vanity mirror available, specify and add \$149 list

Description	D	W	H	CTN WT	CU FT	① Model	Laminate	Essentials Veneer	Artisan Veneer
69" h Wardrobe	22	18	69	149	20	FLT2218-69FDWR	\$1,726		
	22	18	69	149	20	FLV2218-69FDWR		\$3,131	\$3,442
	22	18	69	149	20	FLT2218-69FDWL	\$1,726		
	22	18	69	149	20	FLV2218-69FDWL		\$3,131	\$3,442

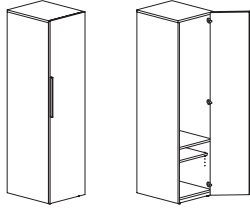

right shown

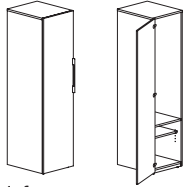

left

Features:

- lower adjustable shelf
- installed coat hooks

Options:

- must specify chassis grain direction on artisan veneer, see pages 13-15 for details
- veneer door front in paint available, specify paint color and add \$354 list; see page 16 for details
- on laminate units, contrasting doors fronts available, no upcharge; specify color, see page 16 for details
- locking door available, specify and add \$147 list
- ledge pulls standard, mounted vertical; prism pulls available, specify and see page 9
- vanity mirror available, specify and add \$149 list

69" h Storage Cabinet	22	18	69	168	20	FLT2218-69FDR	\$1,715		
	22	18	69	168	20	FLV2218-69FDR		\$3,122	\$3,434
	22	18	69	168	20	FLT2218-69FDL	\$1,715		
	22	18	69	168	20	FLV2218-69FDL		\$3,122	\$3,434

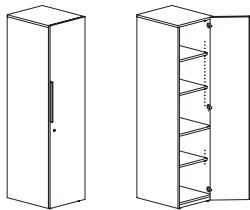

right shown

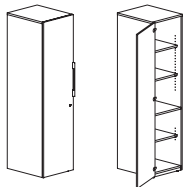

left

Features:

- four adjustable shelves

Options:

- must specify chassis grain direction on artisan veneer, see pages 13-15 for details
- veneer door front in paint available, specify paint color and add \$354 list; see page 16 for details
- on laminate units, contrasting doors fronts available, no upcharge; specify color, see page 16 for details
- locking door available, specify and add \$147 list
- ledge pulls standard, mounted vertical; prism pulls available, specify and see page 9
- vanity mirror available, specify and add \$149 list

To Order, Specify:

① Laminate Model #		② Laminate Selection		③ Metal Color	④ Other Product Options
Laminate (FLT)		See Laminate Selection		See Metal Finish Color Options	See list of options for each specific unit; Specify and add accordingly.
① Veneer Model #	② Wood Collection	③ Wood Finish		④ Metal Color	⑤ Other Product Options
Veneer (FLV)	Essentials	See Essentials Wood Finish Options		See Metal Finish Color Options	
	Artisan	③a Wood Finish See Artisan Wood Finish Options	③b Chassis Grain Direction For Artisan Only: Vertical Horizontal		

FLUX

Description	D	W	H	CTN WT	CU FT	① Model	Laminate	Essentials Veneer	Artisan Veneer
81" h File/File, Storage Cabinet with Side Wardrobe	22	24	81	274	30	FLT2224-81F2DWR	\$3,355		
	22	24	81	274	30	FLV2224-81F2DWR		\$5,299	\$5,828
	22	24	81	274	30	FLT2224-81F2DWL	\$3,355		
	22	24	81	274	30	FLV2224-81F2DWL		\$5,299	\$5,828

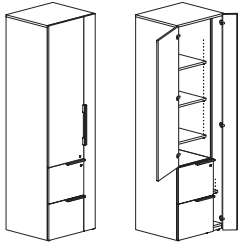

right shown

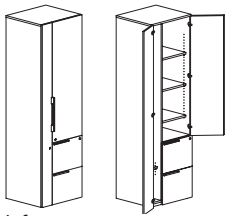

left

Features:

- aligns with primary height units
- pedestal front locking
- upper compartment has three adjustable shelves
- installed coat hook in wardrobe compartment

Options:

- must specify chassis grain direction on artisan veneer, see pages 13-15 for details
- veneer door and drawer front in paint available, specify paint color and add \$354; see page 16 for details
- on laminate units, contrasting door and drawer fronts available, no upcharge; specify color, see page 16 for details
- locking doors available, specify and add \$294 list
- ledge pulls standard; prism pulls available, specify and see page 9
- vanity mirror available, specify and add \$149 list

81" h Box/Box/File, Storage Cabinet with Side Wardrobe	22	24	81	276	30	FLT2224-81F1DWR	\$3,364		
	22	24	81	276	30	FLV2224-81F1DWR		\$5,306	\$5,837
	22	24	81	276	30	FLT2224-81F1DWL	\$3,364		
	22	24	81	276	30	FLV2224-81F1DWL		\$5,306	\$5,837

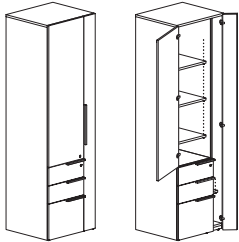

right shown

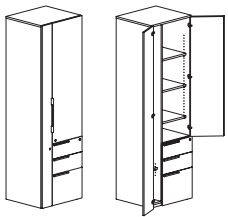

left

Features:

- aligns with primary height units
- pedestal front locking
- upper compartment has three adjustable shelves
- installed coat hook in wardrobe compartment

Options:

- must specify chassis grain direction on artisan veneer, see pages 13-15 for details
- veneer door and drawer front in paint available, specify paint color and add \$354; see page 16 for details
- on laminate units, contrasting door and drawer fronts available, no upcharge; specify color, see page 16 for details
- locking doors available, specify and add \$294 list
- ledge pulls standard; prism pulls available, specify and see page 9
- vanity mirror available, specify and add \$149 list

Description	D	W	H	CTN WT	CU FT	① Model	Laminate	Essentials Veneer	Artisan Veneer
81" h File/File, Open Storage Cabinet with Side Wardrobe	22	24	81	253	30	FLT2224-81F20WR	\$3,242		
	22	24	81	253	30	FLV2224-81F20WR		\$5,133	\$5,646
	22	24	81	253	30	FLT2224-81F20WL	\$3,242		
	22	24	81	253	30	FLV2224-81F20WL		\$5,133	\$5,646

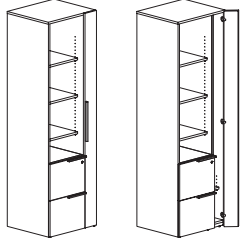

right shown

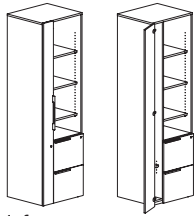

left

Features:

- aligns with primary height units
- pedestal front locking
- upper compartment has three adjustable shelves
- installed coat hook in wardrobe compartment

Options:

- must specify chassis grain direction on artisan veneer, see pages 13-15 for details
- veneer door and drawer front in paint available, specify paint color and add \$354; see page 16 for details
- on laminate units, contrasting door and drawer fronts available, no upcharge; specify color, see page 16 for details
- locking side door available, specify and add \$147 list
- ledge pulls standard; prism pulls available, specify and see page 9

81" h Box/Box/File, Open Storage Cabinet with Side Wardrobe	22	24	81	254	30	FLT2224-81F10WR	\$3,248		
	22	24	81	254	30	FLV2224-81F10WR		\$5,142	\$5,656
	22	24	81	254	30	FLT2224-81F10WL	\$3,248		
	22	24	81	254	30	FLV2224-81F10WL		\$5,142	\$5,656

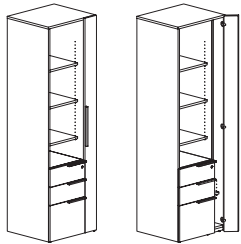

right shown

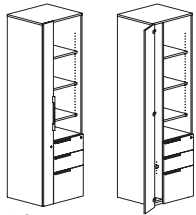

left

Features:

- aligns with primary height units
- pedestal front locking
- upper compartment has three adjustable shelves
- installed coat hook in wardrobe compartment

Options:

- must specify chassis grain direction on artisan veneer, see pages 13-15 for details
- veneer door and drawer front in paint available, specify paint color and add \$354; see page 16 for details
- on laminate units, contrasting door and drawer fronts available, no upcharge; specify color, see page 16 for details
- locking side door available, specify and add \$147 list
- ledge pulls standard; prism pulls available, specify and see page 9

To Order, Specify:

① Laminate Model #		② Laminate Selection		③ Metal Color	④ Other Product Options
Laminate (FLT)		See Laminate Selection		See Metal Finish Color Options	See list of options for each specific unit; Specify and add accordingly.
① Veneer Model #	② Wood Collection	③ Wood Finish		④ Metal Color	⑤ Other Product Options
Veneer (FLV)	Essentials	See Essentials Wood Finish Options		See Metal Finish Color Options	
	Artisan	Ⓐ Wood Finish See Artisan Wood Finish Options	Ⓑ Chassis Grain Direction For Artisan Only: Vertical Horizontal		

Description	D	W	H	CTN WT	CU FT	① Model	Laminate	Essentials Veneer	Artisan Veneer
81" h Lower and Upper Hinge Door Storage Cabinet with Side Wardrobe	22	24	81	254	30	FLT2224-81F7DWR	\$2,613		
	22	24	81	254	30	FLV2224-81F7DWR		\$4,480	\$4,928
	22	24	81	254	30	FLT2224-81F7DWL	\$2,613		
	22	24	81	254	30	FLV2224-81F7DWL		\$4,480	\$4,928

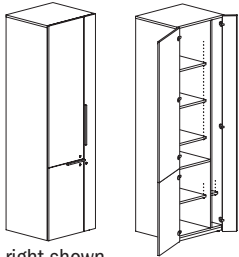

right shown

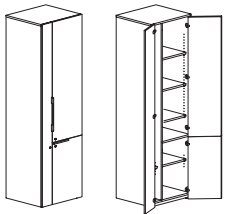

left

Features:

- aligns with primary height units
- upper compartment has three adjustable shelves, lower compartment has one adjustable shelf
- installed coat hook in wardrobe compartment

Options:

- must specify chassis grain direction on artisan veneer, see pages 13-15 for details
- veneer door fronts in paint available, specify paint color and add \$354 list; see page 16 for detail
- on laminate units, contrasting doors fronts available, no upcharge; specify color, see page 16 for details
- locking doors available, specify and add \$441 list
- ledge pulls standard; prism pulls available, specify and see page 9
- pull out trash can available, specify and add \$479 list; see page 38 for details

81" h Lower Hinge Door, Open Storage Cabinet with Side Wardrobe	22	24	81	232	30	FLT2224-81F70WR	\$2,497		
	22	24	81	232	30	FLV2224-81F70WR		\$4,316	\$4,749
	22	24	81	232	30	FLT2224-81F70WL	\$2,497		
	22	24	81	232	30	FLV2224-81F70WL		\$4,316	\$4,749

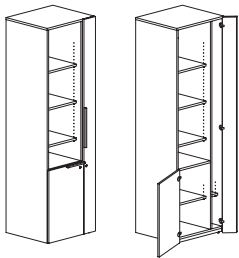

right shown

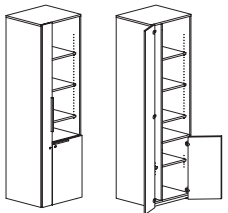

left

Features:

- aligns with primary height units
- upper compartment has three adjustable shelves, lower compartment has one adjustable shelf
- installed coat hook in wardrobe compartment

Options:

- must specify chassis grain direction on artisan veneer, see pages 13-15 for details
- veneer door fronts in paint available, specify paint color and add \$354 list; see page 16 for detail
- on laminate units, contrasting doors fronts available, no upcharge; specify color, see page 16 for details
- locking doors available, specify and add \$294 list
- ledge pulls standard; prism pulls available, specify and see page 9
- pull out trash can available, specify and add \$479 list; see page 38 for details

Description	D	W	H	CTN WT	CU FT	① Model	Laminate	Essentials Veneer	Artisan Veneer
69" h File/File, Storage Cabinet with Side Wardrobe	22	24	69	239	26	FLT2224-69F2DWR	\$3,155		
	22	24	69	239	26	FLV2224-69F2DWR		\$5,010	\$5,510
	22	24	69	239	26	FLT2224-69F2DWL	\$3,155		
	22	24	69	239	26	FLV2224-69F2DWL		\$5,010	\$5,510

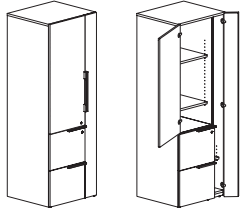

right shown

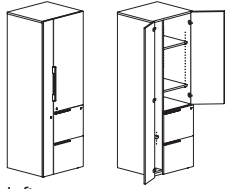

left

Features

- aligns with primary height units
- pedestal front locking
- upper compartment has two adjustable shelves
- installed coat hook in wardrobe compartment

Options:

- must specify chassis grain direction on artisan veneer, see pages 13-15 for details
- veneer door and drawer front in paint available, specify paint color and add \$354; see page 16 for details
- on laminate units, contrasting door and drawer fronts available, no upcharge; specify color, see page 16 for details
- locking doors available, specify and add \$294 list
- ledge pulls standard, mounted vertical; prism pulls available, specify and see page 9

69" h Box/Box/File, Storage Cabinet with Side Wardrobe	22	24	69	241	26	FLT2224-69F1DWR	\$3,161		
	22	24	69	241	26	FLV2224-69F1DWR		\$5,016	\$5,518
	22	24	69	241	26	FLT2224-69F1DWL	\$3,161		
	22	24	69	241	26	FLV2224-69F1DWL		\$5,016	\$5,518

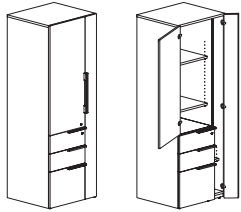

right shown

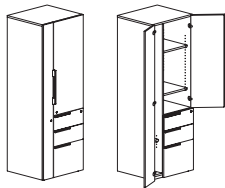

left

Features:

- aligns with primary height units
- pedestal front locking
- upper compartment has two adjustable shelves
- installed coat hook in wardrobe compartment

Options:

- must specify chassis grain direction on artisan veneer, see pages 13-15 for details
- veneer door and drawer front in paint available, specify paint color and add \$354; see page 16 for details
- on laminate units, contrasting door and drawer fronts available, no upcharge; specify color, see page 16 for details
- locking doors available, specify and add \$294 list
- ledge pulls standard, mounted vertical; prism pulls available, specify and see page 9

To Order, Specify:

① Laminate Model #	② Laminate Selection	③ Metal Color	④ Other Product Options			
Laminate (FLT)	See Laminate Selection	See Metal Finish Color Options	See list of options for each specific unit; Specify and add accordingly.			
① Veneer Model #	② Wood Collection	③ Wood Finish	④ Metal Color	⑤ Other Product Options		
Veneer (FLV)	Essentials	See Essentials Wood Finish Options	See Metal Finish Color Options	See list of options for each specific unit; Specify and add accordingly.		
	Artisan	<table border="1"> <thead> <tr> <th>ⓐ Wood Finish</th> <th>ⓑ Chassis Grain Direction</th> </tr> </thead> <tbody> <tr> <td>See Artisan Wood Finish Options</td> <td>For Artisan Only: Vertical Horizontal</td> </tr> </tbody> </table>	ⓐ Wood Finish		ⓑ Chassis Grain Direction	See Artisan Wood Finish Options
ⓐ Wood Finish	ⓑ Chassis Grain Direction					
See Artisan Wood Finish Options	For Artisan Only: Vertical Horizontal					

Description	D	W	H	CTN WT	CU FT	① Model	Laminate	Essentials Veneer	Artisan Veneer
69" h File/File, Open Storage Cabinet with Side Wardrobe	22	24	69	222	26	FLT2224-69F20WR	\$3,062		
	22	24	69	222	26	FLV2224-69F20WR		\$4,880	\$5,367
	22	24	69	222	26	FLT2224-69F20WL	\$3,062		
	22	24	69	222	26	FLV2224-69F20WL		\$4,880	\$5,367

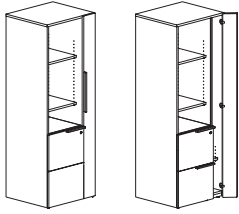

right shown

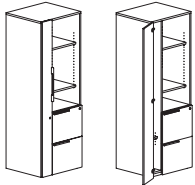

left

Features:

- aligns with primary height units
- pedestal front locking
- upper compartment has two adjustable shelves
- installed coat hook in wardrobe compartment

Options:

- must specify chassis grain direction on artisan veneer, see pages 13-15 for details
- veneer door and drawer front in paint available, specify paint color and add \$354; see page 16 for details
- on laminate units, contrasting door and drawer fronts available, no upcharge; specify color, see page 16 for details
- locking side door available, specify and add \$147 list
- ledge pulls standard, mounted vertical; prism pulls available, specify and see page 9

69" h Box/Box/File, Open Storage Cabinet with Side Wardrobe	22	24	69	224	26	FLT2224-69F10WR	\$3,072		
	22	24	69	224	26	FLV2224-69F10WR		\$4,887	\$5,374
	22	24	69	224	26	FLT2224-69F10WL	\$3,072		
	22	24	69	224	26	FLV2224-69F10WL		\$4,887	\$5,374

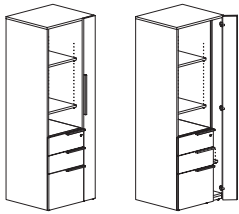

right shown

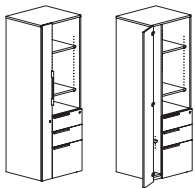

left

Features:

- aligns with primary height units
- pedestal front locking
- upper compartment has two adjustable shelves
- installed coat hook in wardrobe compartment

Options:

- must specify chassis grain direction on artisan veneer, see pages 13-15 for details
- veneer door and drawer front in paint available, specify paint color and add \$354; see page 16 for details
- on laminate units, contrasting door and drawer fronts available, no upcharge; specify color, see page 16 for details
- locking side door available, specify and add \$147 list
- ledge pulls standard, mounted vertical; prism pulls available, specify and see page 9

Description	D	W	H	CTN WT	CU FT	① Model	Laminate	Essentials Veneer	Artisan Veneer
69" h Lower and Upper Hinge Door Storage Cabinet with Side Wardrobe	22	24	69	218	26	FLT2224-69F7DWR	\$2,410		
	22	24	69	218	26	FLV2224-69F7DWR		\$4,192	\$4,613
	22	24	69	218	26	FLT2224-69F7DWL	\$2,410		
	22	24	69	218	26	FLV2224-69F7DWL		\$4,192	\$4,613

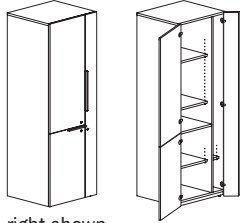

right shown

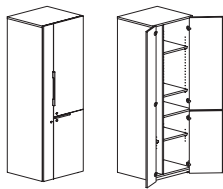

left

Features:

- aligns with primary height units
- upper compartment has two adjustable shelves, lower compartment has one adjustable shelf
- installed coat hook in wardrobe compartment

Options:

- must specify chassis grain direction on artisan veneer, see pages 13-15 for details
- veneer door fronts in paint available, specify paint color and add \$354 list; see page 16 for detail
- on laminate units, contrasting doors fronts available, no upcharge; specify color, see page 16 for details
- locking doors available, specify and add \$441 list
- ledge pulls standard, mounted vertical; prism pulls available, specify and see page 9
- pull out trash can available, specify and add \$479 list; see page 38 for details
- vanity mirror available, specify and add \$149 list

69" h Lower Hinge Door, Open Storage Cabinet with Side Wardrobe	22	24	69	201	26	FLT2224-69F7OWR	\$2,319		
	22	24	69	201	26	FLV2224-69F7OWR		\$4,061	\$4,466
	22	24	69	201	26	FLT2224-69F7OWL	\$2,319		
	22	24	69	201	26	FLV2224-69F7OWL		\$4,061	\$4,466

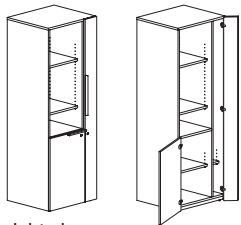

right shown

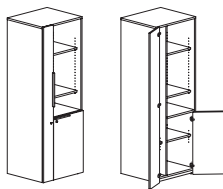

left

Features:

- aligns with primary height units
- upper compartment has two adjustable shelves, lower compartment has one adjustable shelf
- installed coat hook in wardrobe compartment

Options:

- must specify chassis grain direction on artisan veneer, see pages 13-15 for details
- veneer door fronts in paint available, specify paint color and add \$354 list; see page 16 for detail
- on laminate units, contrasting doors fronts available, no upcharge; specify color, see page 16 for details
- locking doors available, specify and add \$294 list
- ledge pulls standard, mounted vertical; prism pulls available, specify and see page 9
- pull out trash can available, specify and add \$479 list; see page 38 for details

To Order, Specify:

① Laminate Model #		② Laminate Selection		③ Metal Color	④ Other Product Options
Laminate (FLT)		See Laminate Selection		See Metal Finish Color Options	See list of options for each specific unit; Specify and add accordingly.
① Veneer Model #	② Wood Collection	③ Wood Finish		④ Metal Color	⑤ Other Product Options
Veneer (FLV)	Essentials	See Essentials Wood Finish Options		See Metal Finish Color Options	See list of options for each specific unit; Specify and add accordingly.
	Artisan	ⓐ Wood Finish See Artisan Wood Finish Options	ⓑ Chassis Grain Direction For Artisan Only: Vertical Horizontal		

Description	D	W	H	CTN WT	CU FT	① Model	Laminate	Essentials Veneer	Artisan Veneer
81" h Side Access Wardrobe with Open Shelves	15 7/8	36	81	211	32	FLT1636-81FSWR	\$2,510		
	15 7/8	36	81	211	32	FLV1636-81FSWR		\$4,010	\$4,414
	15 7/8	36	81	211	32	FLT1636-81FSWL	\$2,510		
	15 7/8	36	81	211	32	FLV1636-81FSWL		\$4,010	\$4,414
	15 7/8	30	81	185	27	FLT1630-81FSWR	\$2,314		
	15 7/8	30	81	185	27	FLV1630-81FSWR		\$3,701	\$4,071
	15 7/8	30	81	185	27	FLT1630-81FSWL	\$2,314		
	15 7/8	30	81	185	27	FLV1630-81FSWL		\$3,701	\$4,071

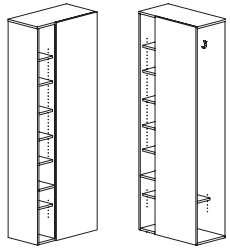

right shown

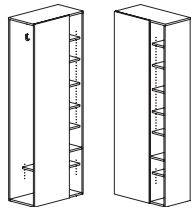

left

Features:

- attaching hardware included
- side entry wardrobe with two installed coat hooks and one lower adjustable shelf
- 8 1/4" w open compartment with five adjustable shelves

Options:

- must specify chassis grain direction on artisan veneer, see pages 13-15 for details

Description	D	W	H	CTN WT	CU FT	① Model	Laminate	Essentials Veneer	Artisan Veneer
69" h Side Access Wardrobe with Open Shelves	15 7/8	36	69	184	27	FLT1636-69FSWR	\$2,309		
	15 7/8	36	69	184	27	FLV1636-69FSWR		\$3,722	\$4,094
	15 7/8	36	69	184	27	FLT1636-69FSWL	\$2,309		
	15 7/8	36	69	184	27	FLV1636-69FSWL		\$3,722	\$4,094
	15 7/8	30	69	160	23	FLT1630-69FSWR	\$2,128		
	15 7/8	30	69	160	23	FLV1630-69FSWR		\$3,429	\$3,771
	15 7/8	30	69	160	23	FLT1630-69FSWL	\$2,128		
	15 7/8	30	69	160	23	FLV1630-69FSWL		\$3,429	\$3,771

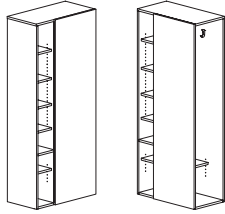

right shown

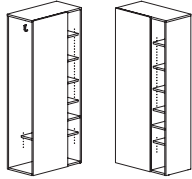

left

Features:

- attaching hardware included
- side entry wardrobe with two installed coat hooks and one lower adjustable shelf
- 8 1/4" w open compartment with four adjustable shelves

Options:

- must specify chassis grain direction on artisan veneer, see pages 13-15 for details

To Order, Specify:

① Laminate Model #		② Laminate Selection		③ Metal Color	④ Other Product Options
Laminate (FLT)		See Laminate Selection		See Metal Finish Color Options	See list of options for each specific unit; Specify and add accordingly.
① Veneer Model #	② Wood Collection	③ Wood Finish		④ Metal Color	⑤ Other Product Options
Veneer (FLV)	Essentials	See Essentials Wood Finish Options		See Metal Finish Color Options	See list of options for each specific unit; Specify and add accordingly.
	Artisan	③a Wood Finish See Artisan Wood Finish Options	③b Chassis Grain Direction For Artisan Only: Vertical Horizontal		

Description	D	W	H	CTN WT	CU FT	① Model	Laminate	Essentials Veneer	Artisan Veneer
81" h File/File Lateral, Storage Cabinet	22	36	81	326	44	FLT2236-81F4D	\$3,562		
	22	36	81	326	44	FLV2236-81F4D		\$5,630	\$6,193
	22	30	81	281	37	FLT2230-81F4D	\$3,373		
	22	30	81	281	37	FLV2230-81F4D		\$5,381	\$5,921

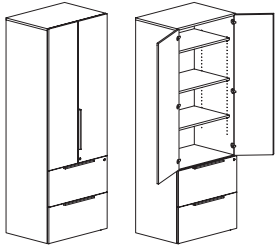

Features:

- aligns with primary height units
- pedestal front locking
- upper compartment has three adjustable shelves

Options:

- must specify chassis grain direction on artisan veneer, see pages 13-15 for details
- veneer door and drawer front in paint available, specify paint color and add \$354; see page 16 for details
- on laminate units, contrasting door and drawer fronts available, no upcharge; specify color, see page 16 for details
- locking upper doors available, specify and add \$147 list
- ledge pulls standard; prism pulls available, specify and see page 9

81" h Box/Box File Lateral, Storage Cabinet	22	36	81	326	44	FLT2236-81F3D	\$3,576		
	22	36	81	326	44	FLV2236-81F3D		\$5,643	\$6,206
	22	30	81	281	37	FLT2230-81F3D	\$3,384		
	22	30	81	281	37	FLV2230-81F3D		\$5,394	\$5,932

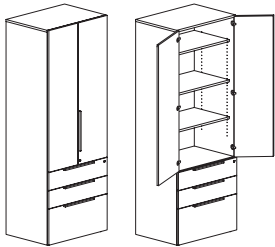

Features:

- aligns with primary height units
- pedestal front locking
- upper compartment has three adjustable shelves

Options:

- must specify chassis grain direction on artisan veneer, see pages 13-15 for details
- veneer door and drawer front in paint available, specify paint color and add \$354; see page 16 for details
- on laminate units, contrasting door and drawer fronts available, no upcharge; specify color, see page 16 for details
- locking upper doors available, specify and add \$147 list
- ledge pulls standard; prism pulls available, specify and see page 9

81" h Lower and Upper Hinge Door Storage Cabinet	22	36	81	310	44	FLT2236-81F7D	\$2,863		
	22	36	81	310	44	FLV2236-81F7D		\$4,891	\$5,380
	22	30	81	270	37	FLT2230-81F7D	\$2,688		
	22	30	81	270	37	FLV2230-81F7D		\$4,667	\$5,133

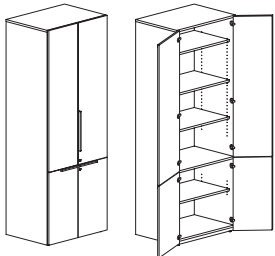

Features:

- aligns with primary height units
- upper compartment has three adjustable shelves, lower compartment has one adjustable shelf

Options:

- must specify chassis grain direction on artisan veneer, see pages 13-15 for details
- veneer door fronts in paint available, specify paint color and add \$354 list; see page 16 for details
- on laminate units, contrasting doors fronts available, no upcharge; specify color, see page 16 for details
- locking doors available, specify and add \$294 list
- ledge pulls standard, mounted vertical; prism pulls available, specify and see page 9

FLUX

Description	D	W	H	CTN WT	CU FT	① Model	Laminate	Essentials Veneer	Artisan Veneer
81" h File/File Lateral, Open Storage Cabinet	22	36	81	282	44	FLT2236-81F40	\$3,354		
	22	36	81	282	44	FLV2236-81F40		\$5,354	\$5,889
	22	30	81	255	37	FLT2230-81F40	\$3,178		
	22	30	81	255	37	FLV2230-81F40		\$5,126	\$5,637

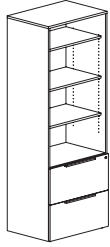

Features:

- aligns with primary height units
- pedestal front locking
- upper compartment has three adjustable shelves

Options:

- must specify chassis grain direction on artisan veneer, see pages 13-15 for details
- veneer drawer fronts in paint available, specify paint color and add \$354 list; see page 16 for details
- on laminate units, contrasting drawer fronts available, no upcharge; specify color, see page 16 for details
- ledge pulls standard; prism pulls available, specify and see page 9

81" h Box/Box/File Lateral, Open Storage Cabinet	22	36	81	282	44	FLT2236-81F30	\$3,366		
	22	36	81	282	44	FLV2236-81F30		\$5,368	\$5,905
	22	30	81	255	37	FLT2230-81F30	\$3,192		
	22	30	81	255	37	FLV2230-81F30		\$5,136	\$5,648

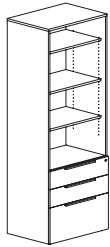

Features:

- aligns with primary height units
- pedestal front locking
- upper compartment has three adjustable shelves

Options:

- must specify chassis grain direction on artisan veneer, see pages 13-15 for details
- veneer drawer fronts in paint available, specify paint color and add \$354 list; see page 16 for details
- on laminate units, contrasting drawer fronts available, no upcharge; specify color, see page 16 for details
- ledge pulls standard; prism pulls available, specify and see page 9

81" h Lower Hinge Doors, Open Storage Cabinet	22	36	81	261	44	FLT2236-81F70	\$2,654		
	22	36	81	261	44	FLV2236-81F70		\$4,618	\$5,079
	22	30	81	233	37	FLT2230-81F70	\$2,492		
	22	30	81	233	37	FLV2230-81F70		\$4,409	\$4,850

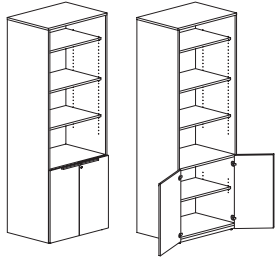

Features:

- aligns with primary height units
- upper compartment has three adjustable shelves, lower compartment has one adjustable shelf

Options:

- must specify chassis grain direction on artisan veneer, see pages 13-15 for details
- veneer door fronts in paint available, specify paint color and add \$354 list; see page 16 for details
- on laminate units, contrasting doors fronts available, no upcharge; specify color, see page 16 for details
- locking lower doors available specify and add \$147 list
- ledge pulls standard; prism pulls available, specify and see page 9

To Order, Specify:

① Laminate Model #	② Laminate Selection	③ Metal Color	④ Other Product Options
Laminate (FLT)	See Laminate Selection	See Metal Finish Color Options	See list of options for each specific unit; Specify and add accordingly.

① Veneer Model #	② Wood Collection	③ Wood Finish	④ Metal Color	⑤ Other Product Options		
Veneer (FLV)	Essentials	See Essentials Wood Finish Options	See Metal Finish Color Options	See list of options for each specific unit; Specify and add accordingly.		
	Artisan	<table border="1"> <thead> <tr> <th>Ⓐ Wood Finish</th> <th>Ⓑ Chassis Grain Direction</th> </tr> </thead> <tbody> <tr> <td>See Artisan Wood Finish Options</td> <td>For Artisan Only: Vertical Horizontal</td> </tr> </tbody> </table>	Ⓐ Wood Finish		Ⓑ Chassis Grain Direction	See Artisan Wood Finish Options
Ⓐ Wood Finish	Ⓑ Chassis Grain Direction					
See Artisan Wood Finish Options	For Artisan Only: Vertical Horizontal					

Description	D	W	H	CTN WT	CU FT	① Model	Laminate	Essentials Veneer	Artisan Veneer
69" h File/File Lateral, Storage Cabinet	22	36	69	305	38	FLT2236-69F4D	\$3,250		
	22	36	69	305	38	FLV2236-69F4D		\$5,184	\$5,701
	22	30	69	262	32	FLT2230-69F4D	\$3,091		
	22	30	69	262	32	FLV2230-69F4D		\$4,976	\$5,474

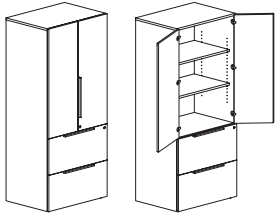

Features:

- aligns with primary height units
- upper compartment has two adjustable shelves

Options:

- must specify chassis grain direction on artisan veneer, see pages 13-15 for details
- veneer door and drawer front in paint available, specify paint color and add \$354; see page 16 for details
- on laminate units, contrasting door and drawer fronts available, no upcharge; specify color, see page 16 for details
- locking upper doors available, specify and add \$147 list
- ledge pulls standard; prism pulls available, specify and see page 9

69" h Box/Box/File Lateral, Storage Cabinet	22	36	69	303	38	FLT2236-69F3D	\$3,264		
	22	36	69	303	38	FLV2236-69F3D		\$5,198	\$5,718
	22	30	69	265	32	FLT2230-69F3D	\$3,103		
	22	30	69	265	32	FLV2230-69F3D		\$4,988	\$5,489

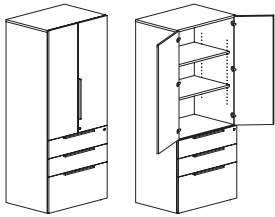

Features:

- aligns with primary height units
- pedestal front locking
- upper compartment has two adjustable shelves

Options:

- must specify chassis grain direction on artisan veneer, see pages 13-15 for details
- veneer door and drawer front in paint available, specify paint color and add \$354; see page 16 for details
- on laminate units, contrasting door and drawer fronts available, no upcharge; specify color, see page 16 for details
- locking upper doors available, specify and add \$147 list
- ledge pulls standard; prism pulls available, specify and see page 9

69" h Lower and Upper Hinge Door Storage Cabinet	22	36	69	267	38	FLT2236-69F7D	\$2,551		
	22	36	69	267	38	FLV2236-69F7D		\$4,446	\$4,891
	22	30	69	232	32	FLT2230-69F7D	\$2,405		
	22	30	69	232	32	FLV2230-69F7D		\$4,261	\$4,688

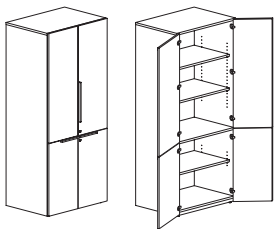

Features:

- aligns with primary height units
- upper compartment has two adjustable shelves, lower compartment has one adjustable shelf

Options:

- must specify chassis grain direction on artisan veneer, see pages 13-15 for details
- veneer door fronts in paint available, specify paint color and add \$354 list; see page 16 for details
- on laminate units, contrasting doors fronts available, no upcharge; specify color, see page 16 for details
- locking doors available, specify and add \$294 list
- ledge pulls standard; prism pulls available, specify and see page 9

Description	D	W	H	CTN WT	CU FT	① Model	Laminate	Essentials Veneer	Artisan Veneer
69" h File/File Lateral, Open Storage Cabinet	22	36	69	262	37	FLT2236-69F40	\$3,080		
	22	36	69	262	37	FLV2236-69F40		\$4,963	\$5,459
	22	30	69	225	32	FLT2230-69F40	\$2,930		
	22	30	69	225	32	FLV2230-69F40		\$4,963	\$5,459

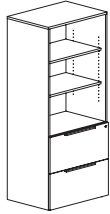

Features:

- aligns with primary height units
- pedestal front locking
- upper compartment has two adjustable shelves

Options:

- must specify chassis grain direction on artisan veneer, see pages 13-15 for details
- veneer drawer fronts in paint available, specify paint color and add \$354 list; see page 16 for details
- on laminate units, contrasting drawer fronts available, no upcharge; specify color, see page 16 for details
- ledge pulls standard; prism pulls available, specify and see page 9

69" h Box/Box/File Lateral, Open Storage Cabinet	22	36	69	261	37	FLT2236-69F30	\$3,091		
	22	36	69	261	37	FLV2236-69F30		\$4,973	\$5,473
	22	30	69	228	32	FLT2230-69F30	\$2,942		
	22	30	69	228	32	FLV2230-69F30		\$4,778	\$5,260

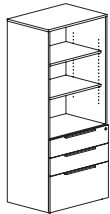

Features:

- aligns with primary height units
- pedestal front locking
- upper compartment has two adjustable shelves

Options:

- must specify chassis grain direction on artisan veneer, see pages 13-15 for details
- veneer drawer fronts in paint available, specify paint color and add \$354 list; see page 16 for details
- on laminate units, contrasting drawer fronts available, no upcharge; specify color, see page 16 for details
- ledge pulls standard; prism pulls available, specify and see page 9

69" h Lower Hinge Doors, Open Storage Cabinet	22	36	69	266	38	FLT2236-69F70	\$2,378		
	22	36	69	266	38	FLV2236-69F70		\$4,225	\$4,646
	22	30	69	204	32	FLT2230-69F70	\$2,242		
	22	30	69	204	32	FLV2230-69F70		\$4,050	\$4,459

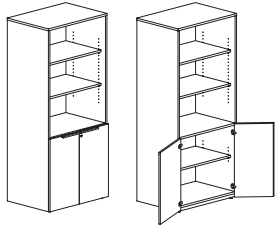

Features:

- aligns with primary height units
- upper compartment has two adjustable shelves, lower compartment has one adjustable shelf

Options:

- must specify chassis grain direction on artisan veneer, see pages 13-15 for details
- veneer door fronts in paint available, specify paint color and add \$354 list; see page 16 for details
- on laminate units, contrasting doors fronts available, no upcharge; specify color, see page 16 for details
- locking lower doors available specify and add \$147 list
- ledge pulls standard; prism pulls available, specify and see page 9

To Order, Specify:

① Laminate Model #		② Laminate Selection		③ Metal Color	④ Other Product Options
Laminate (FLT)		See Laminate Selection		See Metal Finish Color Options	See list of options for each specific unit; Specify and add accordingly.
① Veneer Model #	② Wood Collection	③ Wood Finish		④ Metal Color	⑤ Other Product Options
Veneer (FLV)	Essentials	See Essentials Wood Finish Options		See Metal Finish Color Options	See list of options for each specific unit; Specify and add accordingly.
	Artisan	ⓐ Wood Finish See Artisan Wood Finish Options	ⓑ Chassis Grain Direction For Artisan Only: Vertical Horizontal		

Description	D	W	H	CTN WT	CU FT	① Model	Laminate	Essentials Veneer	Artisan Veneer
81" h File/File, Storage Cabinet	22	18	81	209	24	FLT2218-81F2DR	\$2,657		
	22	18	81	209	24	FLV2218-81F2DR		\$4,172	\$4,589
	22	18	81	209	24	FLT2218-81F2DL	\$2,657		
	22	18	81	209	24	FLV2218-81F2DL		\$4,172	\$4,589

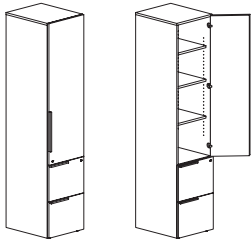

right shown

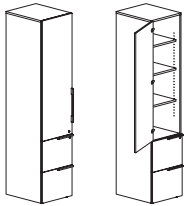

left

Features:

- aligns with primary height units
- pedestal front locking
- upper compartment has three adjustable shelves

Options:

- must specify chassis grain direction on artisan veneer, see pages 13-15 for details
- veneer door and drawer front in paint available, specify paint color and add \$354; see page 16 for details
- on laminate units, contrasting door and drawer fronts available, no upcharge; specify color, see page 16 for details
- locking upper door available, specify and add \$147 list
- ledge pulls standard; prism pulls available, specify and see page 9
- vanity mirror available, specify and add \$149 list

81" h Box/Box/File, Storage Cabinet	22	18	81	210	24	FLT2218-81F1DR	\$2,666		
	22	18	81	210	24	FLV2218-81F1DR		\$4,182	\$4,598
	22	18	81	210	24	FLT2218-81F1DL	\$2,666		
	22	18	81	210	24	FLV2218-81F1DL		\$4,182	\$4,598

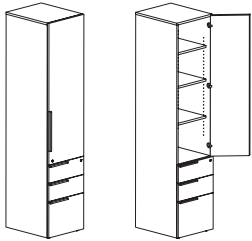

right shown

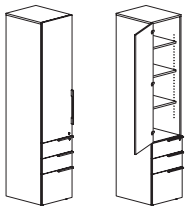

left

Features:

- aligns with primary height units
- pedestal front locking
- upper compartment has three adjustable shelves

Options:

- must specify chassis grain direction on artisan veneer, see pages 13-15 for details
- veneer door and drawer front in paint available, specify paint color and add \$354; see page 16 for details
- on laminate units, contrasting door and drawer fronts available, no upcharge; specify color, see page 16 for details
- locking upper door available, specify and add \$147 list
- ledge pulls standard; prism pulls available, specify and see page 9
- vanity mirror available, specify and add \$149 list

Description	D	W	H	CTN WT	CU FT	① Model	Laminate	Essentials Veneer	Artisan Veneer
81" h File/File, Open Storage Cabinet	22	18	81	187	24	FLT2218-81F20	\$2,545		
	22	18	81	187	24	FLV2218-81F20		\$4,007	\$4,408

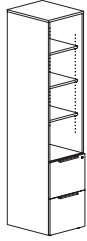

Features:

- aligns with primary height units
- pedestal front locking
- upper compartment has three adjustable shelves

Options:

- must specify chassis grain direction on artisan veneer, see pages 13-15 for details
- veneer drawer fronts in paint available, specify paint color and add \$354 list; see page 16 for details
- on laminate units, contrasting drawer fronts available, no upcharge; specify color, see page 16 for details
- ledge pulls standard; prism pulls available, specify and see page 9

81" h Box/Box/File, Open Storage Cabinet	22	18	81	187	24	FLT2218-81F10	\$2,552		
	22	18	81	187	24	FLV2218-81F10		\$4,017	\$4,418

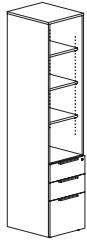

Features:

- aligns with primary height units
- pedestal front locking
- upper compartment has three adjustable shelves

Options:

- must specify chassis grain direction on artisan veneer, see pages 13-15 for details
- veneer drawer fronts in paint available, specify paint color and add \$354 list; see page 16 for details
- on laminate units, contrasting drawer fronts available, no upcharge; specify color, see page 16 for details
- ledge pulls standard; prism pulls available, specify and see page 9

FLUX

To Order, Specify:

① Laminate Model #		② Laminate Selection		③ Metal Color	④ Other Product Options
Laminate (FLT)		See Laminate Selection		See Metal Finish Color Options	See list of options for each specific unit; Specify and add accordingly.
① Veneer Model #	② Wood Collection	③ Wood Finish		④ Metal Color	⑤ Other Product Options
Veneer (FLV)	Essentials	See Essentials Wood Finish Options		See Metal Finish Color Options	See list of options for each specific unit; Specify and add accordingly.
	Artisan	③a Wood Finish See Artisan Wood Finish Options	③b Chassis Grain Direction For Artisan Only: Vertical Horizontal		

Description	D	W	H	CTN WT	CU FT	① Model	Laminate	Essentials Veneer	Artisan Veneer
69" h File/File, Storage Cabinet	22	18	69	192	20	FLT2218-69F2DR	\$2,454		
	22	18	69	192	20	FLV2218-69F2DR		\$3,884	\$4,273
	22	18	69	192	20	FLT2218-69F2DL	\$2,454		
	22	18	69	192	20	FLV2218-69F2DL		\$3,884	\$4,273

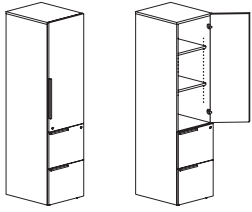

right shown

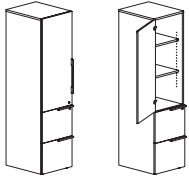

left

Features:

- aligns with primary height units
- pedestal front locking
- upper compartment has two adjustable shelves

Options:

- must specify chassis grain direction on artisan veneer, see pages 13-15 for details
- veneer door and drawer front in paint available, specify paint color and add \$354; see page 16 for details
- on laminate units, contrasting door and drawer fronts available, no upcharge; specify color, see page 16 for details
- locking upper door available, specify and add \$147 list
- ledge pulls standard; prism pulls available, specify and see page 9
- vanity mirror available, specify and add \$149 list

69" h Box/Box/File, Storage Cabinet	22	18	69	192	20	FLT2218-69F1DR	\$2,465		
	22	18	69	192	20	FLV2218-69F1DR		\$3,892	\$4,281
	22	18	69	192	20	FLT2218-69F1DL	\$2,465		
	22	18	69	192	20	FLV2218-69F1DL		\$3,892	\$4,281

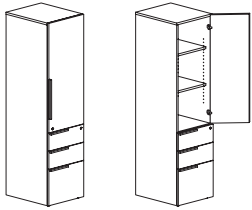

right shown

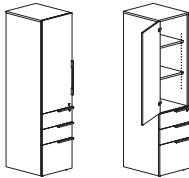

left

Features:

- aligns with primary height units
- pedestal front locking
- upper compartment has two adjustable shelves

Options:

- must specify chassis grain direction on artisan veneer, see pages 13-15 for details
- veneer door and drawer front in paint available, specify paint color and add \$354; see page 16 for details
- on laminate units, contrasting door and drawer fronts available, no upcharge; specify color, see page 16 for details
- locking upper door available, specify and add \$147 list
- ledge pulls standard; prism pulls available, specify and see page 9
- vanity mirror available, specify and add \$149 list

Description	D	W	H	CTN WT	CU FT	① Model	Laminate	Essentials Veneer	Artisan Veneer
69" h File/File, Open Storage Cabinet	22	18	69	166	20	FLT2218-69F20	\$2,365		
	22	18	69	166	20	FLV2218-69F20		\$3,753	\$4,129

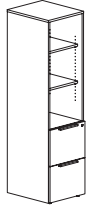

Features:

- aligns with primary height units
- pedestal front locking
- upper compartment has two adjustable shelves

Options:

- must specify chassis grain direction on artisan veneer, see pages 13-15 for details
- veneer drawer fronts in paint available, specify paint color and add \$354 list; see page 16 for details
- on laminate units, contrasting drawer fronts available, no upcharge; specify color, see page 16 for details
- ledge pulls standard; prism pulls available, specify and see page 9

69" h Box/Box/File, Open Storage Cabinet	22	18	69	166	20	FLT2218-69F10	\$2,373		
	22	18	69	166	20	FLV2218-69F10		\$3,763	\$4,139

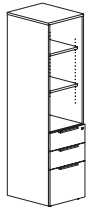

Features:

- aligns with primary height units
- pedestal front locking
- upper compartment has two adjustable shelves

Options:

- must specify chassis grain direction on artisan veneer, see pages 13-15 for details
- veneer drawer fronts in paint available, specify paint color and add \$354 list; see page 16 for details
- on laminate units, contrasting drawer fronts available, no upcharge; specify color, see page 16 for details
- ledge pulls standard; prism pulls available, specify and see page 9

To Order, Specify:

① Laminate Model #		② Laminate Selection		③ Metal Color	④ Other Product Options
Laminate (FLT)		See Laminate Selection		See Metal Finish Color Options	See list of options for each specific unit; Specify and add accordingly.
① Veneer Model #	② Wood Collection	③ Wood Finish		④ Metal Color	⑤ Other Product Options
Veneer (FLV)	Essentials	See Essentials Wood Finish Options		See Metal Finish Color Options	See list of options for each specific unit; Specify and add accordingly.
	Artisan	Ⓒa Wood Finish See Artisan Wood Finish Options	Ⓒb Chassis Grain Direction For Artisan Only: Vertical Horizontal		

FLUX

Description	D	W	H	CTN WT	CU FT	① Model	Laminate	Essentials Veneer	Artisan Veneer
81" h Lower and Upper Hinge Storage Cabinet	22	18	81	188	24	FLT2218-81F7DR	\$2,006		
	22	18	81	188	24	FLV2218-81F7DR		\$3,485	\$3,835
	22	18	81	188	24	FLT2218-81F7DL	\$2,006		
	22	18	81	188	24	FLV2218-81F7DL		\$3,485	\$3,835

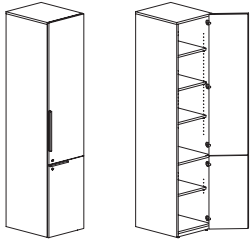

right shown

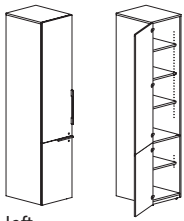

left

Features:

- aligns with primary height units
- upper compartment has three adjustable shelves, lower compartment has one adjustable shelf

Options:

- must specify chassis grain direction on artisan veneer, see pages 13-15 for details
- veneer door front in paint available, specify paint color and add \$354 list; see page 16 for details
- on laminate units, contrasting doors fronts available, no upcharge; specify color, see page 16 for details
- locking doors available, specify and add \$294 list
- ledge pulls standard, mounted vertical; prism pulls available, specify and see page 9
- pull out trash can available, specify and add \$479 list; see page 38 for details
- vanity mirror available, specify and add \$149 list

81" h Lower Hinge Door, Open Storage Cabinet	22	18	81	166	24	FLT2218-81F70R	\$1,894		
	22	18	81	166	24	FLV2218-81F70R		\$3,321	\$3,653
	22	18	81	166	24	FLT2218-81F70L	\$1,894		
	22	18	81	166	24	FLV2218-81F70L		\$3,321	\$3,653

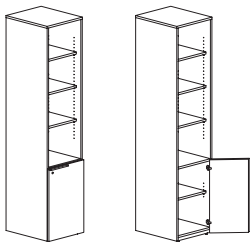

right shown

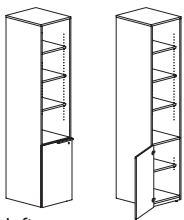

left

Features:

- aligns with primary height units
- upper compartment has three adjustable shelves, lower compartment has one adjustable shelf

Options:

- must specify chassis grain direction on artisan veneer, see pages 13-15 for details
- veneer door front in paint available, specify paint color and add \$354 list; see page 16 for details
- on laminate units, contrasting doors fronts available, no upcharge; specify color, see page 16 for details
- locking lower door available, specify and add \$147 list
- ledge pulls standard; prism pulls available, specify and see page 9
- pull out trash can available, specify and add \$479 list; see page 38 for details

Description	D	W	H	CTN WT	CU FT	① Model	Laminate	Essentials Veneer	Artisan Veneer
69" h Lower and Upper Hinge Door Storage Cabinet	22	18	69	163	20	FLT2218-69F7DR	\$1,805		
	22	18	69	163	20	FLV2218-69F7DR		\$3,199	\$3,517
	22	18	69	163	20	FLT2218-69F7DL	\$1,805		
	22	18	69	163	20	FLV2218-69F7DL		\$3,199	\$3,517

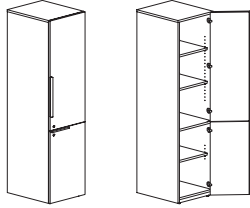

right shown

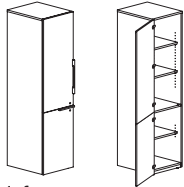

left

Features:

- aligns with primary height units
- upper compartment has two adjustable shelves, lower compartment has one adjustable shelf

Options:

- must specify chassis grain direction on artisan veneer, see pages 13-15 for details
- veneer door front in paint available, specify paint color and add \$354 list; see page 16 for details
- on laminate units, contrasting doors fronts available, no upcharge; specify color, see page 16 for details
- locking doors available, specify and add \$294 list
- ledge pulls standard, mounted vertical; prism pulls available, specify and see page 9
- pull out trash can available, specify and add \$479 list; see page 38 for details
- vanity mirror available, specify and add \$149 list

69" h Lower Hinge Door, Open Storage Cabinet	22	18	69	145	20	FLT2218-69F70R	\$1,712		
	22	18	69	145	20	FLV2218-69F70R		\$3,066	\$3,373
	22	18	69	145	20	FLT2218-69F70L	\$1,712		
	22	18	69	145	20	FLV2218-69F70L		\$3,066	\$3,373

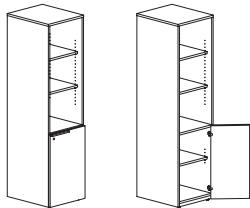

right shown

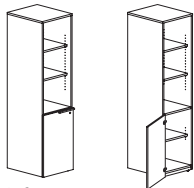

left

Features:

- aligns with primary height units
- upper compartment has two adjustable shelves

Options:

- must specify chassis grain direction on artisan veneer, see pages 13-15 for details
- veneer door front in paint available, specify paint color and add \$354 list; see page 16 for details
- on laminate units, contrasting doors fronts available, no upcharge; specify color, see page 16 for details
- locking lower door available, specify and add \$147 list
- ledge pulls standard; prism pulls available, specify and see page 9
- pull out trash can available, specify and add \$479 list; see page 38 for details

To Order, Specify:

① Laminate Model #		② Laminate Selection		③ Metal Color	④ Other Product Options
Laminate (FLT)		See Laminate Selection		See Metal Finish Color Options	See list of options for each specific unit; Specify and add accordingly.
① Veneer Model #	② Wood Collection	③ Wood Finish		④ Metal Color	⑤ Other Product Options
Veneer (FLV)	Essentials	See Essentials Wood Finish Options		See Metal Finish Color Options	See list of options for each specific unit; Specify and add accordingly.
	Artisan	3a Wood Finish See Artisan Wood Finish Options	3b Chassis Grain Direction For Artisan Only: Vertical Horizontal		

Description	D	W	H	CTN WT	CU FT	① Model	Laminate	Essentials Veneer	Artisan Veneer
81" h Pantry Drawer, Storage Cabinet	22	18	81	227	24	FLT2218-81FADR	\$2,808		
	22	18	81	227	24	FLV2218-81FADR		\$4,321	\$4,754
	22	18	81	227	24	FLT2218-81FADL	\$2,808		
	22	18	81	227	24	FLV2218-81FADL		\$4,321	\$4,754

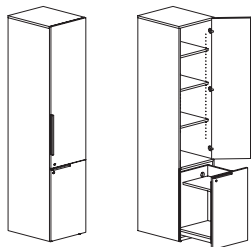

right shown

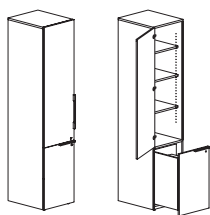

left

Features:

- aligns with primary height units
- concealed caster under drawer for added support
- upper compartment has three adjustable shelves
- oval back panel grommet standard with installed power unit
- pantry drawer front locking

Options:

- must specify chassis grain direction on artisan veneer, see pages 13-15 for details
- veneer door and drawer front in paint available, specify paint color and add \$354; see page 16 for details
- on laminate units, contrasting door and drawer fronts available, no upcharge; specify color, see page 16 for details
- locking door available, specify and add \$147 list
- ledge pulls standard; prism pulls available, specify and see page 9
- power unit (2 simplex and 2 USB charging ports) available, specify and add \$960 list; see page 38 for details
- vanity mirror available, specify and add \$149 list

81" h Pantry Drawer, Open Storage Cabinet	22	18	81	196	24	FLT2218-81FA0R	\$2,694		
	22	18	81	196	24	FLV2218-81FA0R		\$4,121	\$4,535
	22	18	81	196	24	FLT2218-81FA0L	\$2,694		
	22	18	81	196	24	FLV2218-81FA0L		\$4,121	\$4,535

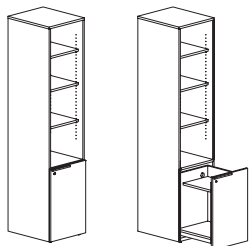

right shown

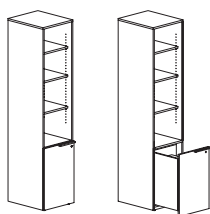

left

Features:

- aligns with primary height units
- concealed caster under drawer for added support
- upper compartment has three adjustable shelves
- oval back panel grommet standard with installed power unit
- pantry drawer front locking

Options:

- must specify chassis grain direction on artisan veneer, see pages 13-15 for details
- veneer drawer fronts in paint available, specify paint color and add \$354 list; see page 16 for details
- on laminate units, contrasting door front available, no upcharge; specify color, see page 16 for details
- ledge pulls standard; prism pulls available, specify and see page 9
- power unit (2 simplex and 2 USB charging ports) available, specify and add \$960 list; see page 38 for details

Description	D	W	H	CTN WT	CU FT	① Model	Laminate	Essentials Veneer	Artisan Veneer
69" h Pantry Drawer, Storage Cabinet	22	18	69	192	20	FLT2218-69FADR	\$2,606		
	22	18	69	192	20	FLV2218-69FADR		\$4,034	\$4,437
	22	18	69	192	20	FLT2218-69FADL	\$2,606		
	22	18	69	192	20	FLV2218-69FADL		\$4,034	\$4,437

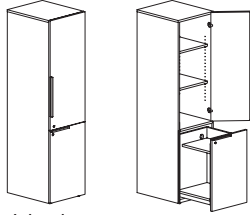

right shown

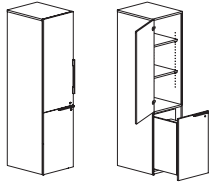

left

Features:

- aligns with primary height units
- concealed caster under drawer for added support
- upper compartment has two adjustable shelves
- oval back panel grommet standard with installed power unit
- pantry drawer front locking

Options:

- must specify chassis grain direction on artisan veneer, see pages 13-15 for details
- veneer door and drawer front in paint available, specify paint color and add \$354; see page 16 for details
- on laminate units, contrasting door and drawer fronts available, no upcharge; specify color, see page 16 for details
- locking door available, specify and add \$147 list
- ledge pulls standard, mounted vertical; prism pulls available, specify and see page 9
- power unit (2 simplex and 2 USB charging ports) available, specify and add \$960 list; see page 38 for details
- vanity mirror available, specify and add \$149 list

69" h Pantry Drawer, Open Storage Cabinet	22	18	69	173	20	FLT2218-69FA0R	\$2,513		
	22	18	69	173	20	FLV2218-69FA0R		\$3,903	\$4,294
	22	18	69	173	20	FLT2218-69FA0L	\$2,513		
	22	18	69	173	20	FLV2218-69FA0L		\$3,903	\$4,294

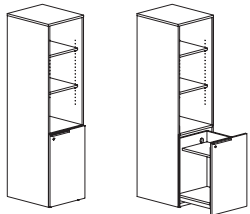

right shown

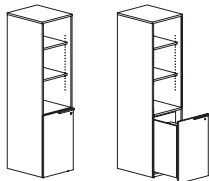

left

Features:

- aligns with primary height units
- concealed caster under drawer for added support
- upper compartment has two adjustable shelves
- oval back panel grommet standard with installed power unit
- pantry drawer front locking

Options:

- must specify chassis grain direction on artisan veneer, see pages 13-15 for details
- veneer drawer fronts in paint available, specify paint color and add \$354 list; see page 16 for details
- on laminate units, contrasting door front available, no upcharge; specify color, see page 16 for details
- ledge pulls standard; prism pulls available, specify and see page 9
- power unit (2 simplex and 2 USB charging ports) available, specify and add \$960 list; see page 38 for details

To Order, Specify:

① Laminate Model #		② Laminate Selection		③ Metal Color	④ Other Product Options
Laminate (FLT)		See Laminate Selection		See Metal Finish Color Options	See list of options for each specific unit; Specify and add accordingly.
① Veneer Model #	② Wood Collection	③ Wood Finish		④ Metal Color	⑤ Other Product Options
Veneer (FLV)	Essentials	See Essentials Wood Finish Options		See Metal Finish Color Options	See list of options for each specific unit; Specify and add accordingly.
	Artisan	ⓐ Wood Finish See Artisan Wood Finish Options	ⓑ Chassis Grain Direction For Artisan Only: Vertical Horizontal		

Description	D	W	H	CTN WT	CU FT	① Model	Laminate	Essentials Veneer	Artisan Veneer
81" h Box/File, Storage Cabinet with Side Wardrobe	22	24	81	275	30	FLT2224-81F5DWR	\$3,258		
	22	24	81	275	30	FLV2224-81F5DWR		\$5,202	\$5,723
	22	24	81	275	30	FLT2224-81F5DWL	\$3,258		
	22	24	81	275	30	FLV2224-81F5DWL		\$5,202	\$5,723

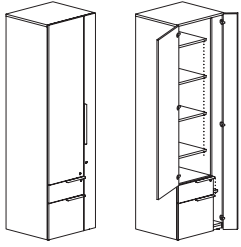

right shown

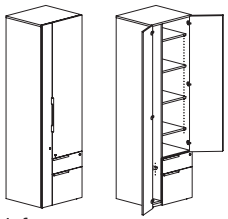

left

Features:

- aligns with secondary height units
- pedestal front locking
- upper compartment has four adjustable shelves
- installed coat hook in wardrobe compartment

Options:

- must specify chassis grain direction on artisan veneer, see pages 13-15 for details
- veneer door and drawer front in paint available, specify paint color and add \$354; see page 16 for details
- on laminate units, contrasting door and drawer fronts available, no upcharge; specify color, see page 16 for details
- locking doors available, specify and add \$294 list
- ledge pulls standard; prism pulls available, specify and see page 9

Description	D	W	H	CTN WT	CU FT	① Model	Laminate	Essentials Veneer	Artisan Veneer
81" h Box/File, Open Storage Cabinet with Side Wardrobe	22	24	81	250	30	FLT2224-81F50WR	\$3,147		
	22	24	81	250	30	FLV2224-81F50WR		\$5,037	\$5,541
	22	24	81	250	30	FLT2224-81F50WL	\$3,147		
	22	24	81	250	30	FLV2224-81F50WL		\$5,037	\$5,541

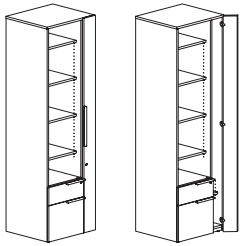

right shown

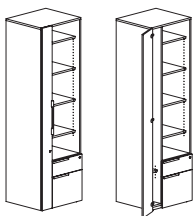

left

Features:

- aligns with secondary height units
- pedestal front locking
- upper compartment has four adjustable shelves
- installed coat hook in wardrobe compartment

Options:

- must specify chassis grain direction on artisan veneer, see pages 13-15 for details
- veneer door and drawer front in paint available, specify paint color and add \$354; see page 16 for details
- on laminate units, contrasting door and drawer fronts available, no upcharge; specify color, see page 16 for details
- locking door available, specify and add \$147 list
- ledge pulls standard; prism pulls available, specify and see page 9

Description	D	W	H	CTN WT	CU FT	① Model	Laminate	Essentials Veneer	Artisan Veneer
81" h Lower and Upper Hinge Door Storage Cabinet with Side Wardrobe	22	24	81	260	30	FLT2224-81F8DWR	\$2,613		
	22	24	81	260	30	FLV2224-81F8DWR		\$4,480	\$4,928
	22	24	81	260	30	FLT2224-81F8DWL	\$2,613		
	22	24	81	260	30	FLV2224-81F8DWL		\$4,480	\$4,928

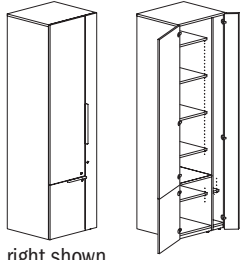

right shown

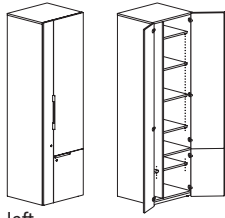

left

Features:

- aligns with secondary height units
- upper compartment has three adjustable shelves, lower compartment has one adjustable shelf
- installed coat hook in wardrobe compartment

Options:

- must specify chassis grain direction on artisan veneer, see pages 13-15 for details
- veneer door fronts in paint available, specify paint color and add \$354 list; see page 16 for detail
- on laminate units, contrasting doors fronts available, no upcharge; specify color, see page 16 for details
- locking doors available, specify and add \$441 list
- ledge pulls standard; prism pulls available, specify and see page 9
- vanity mirror available, specify and add \$149 list

81" h Lower Hinge Door, Open Storage Cabinet with Side Wardrobe	22	24	81	236	30	FLT2224-81F80WR	\$2,497		
	22	24	81	236	30	FLV2224-81F80WR		\$4,316	\$4,749
	22	24	81	236	30	FLT2224-81F80WL	\$2,497		
	22	24	81	236	30	FLV2224-81F80WL		\$4,316	\$4,749

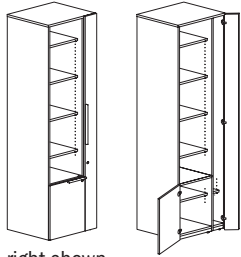

right shown

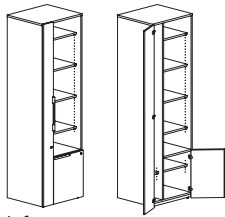

left

Features:

- aligns with secondary height units
- upper compartment has four adjustable shelves
- installed coat hook in wardrobe compartment

Options:

- must specify chassis grain direction on artisan veneer, see pages 13-15 for details
- veneer door fronts in paint available, specify paint color and add \$354 list; see page 16 for detail
- on laminate units, contrasting doors fronts available, no upcharge; specify color, see page 16 for details
- locking doors available, specify and add \$294 list
- ledge pulls standard; prism pulls available, specify and see page 9

To Order, Specify:

① Laminate Model #	② Laminate Type	③ Laminate Selection	④ Metal Color	⑤ Other Product Options
Laminate (FLT)	HPL	See Laminate Selection	See Metal Finish Color Options	See list of options for each specific unit; Specify and add accordingly.

① Veneer Model #	② Wood Collection	③ Wood Finish - Finishes with an asterisk (*) have a coordinating laminate available	④ Metal Color	⑤ Other Product Options		
Veneer (FLV)	Essentials	See Essentials Wood Finish Options	See Metal Finish Color Options	See list of options for each specific unit; Specify and add accordingly.		
	Artisan	<table border="1"> <thead> <tr> <th>③a Wood Finish</th> <th>③b Chassis Grain Direction</th> </tr> </thead> <tbody> <tr> <td>See Artisan Wood Finish Options</td> <td>For Artisan Only: Vertical Horizontal</td> </tr> </tbody> </table>	③a Wood Finish		③b Chassis Grain Direction	See Artisan Wood Finish Options
③a Wood Finish	③b Chassis Grain Direction					
See Artisan Wood Finish Options	For Artisan Only: Vertical Horizontal					

Description	D	W	H	CTN WT	CU FT	① Model	Laminate	Essentials Veneer	Artisan Veneer
69" h Box/File, Storage Cabinet with Side Wardrobe	22	24	69	233	26	FLT2224-69F5DWR	\$3,056		
	22	24	69	233	26	FLV2224-69F5DWR		\$4,914	\$5,405
	22	24	69	233	26	FLT2224-69F5DWL	\$3,056		
	22	24	69	233	26	FLV2224-69F5DWL		\$4,914	\$5,405

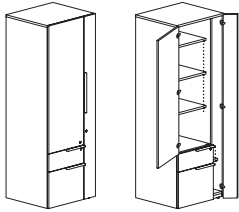

right shown

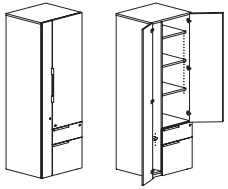

left

Features:

- aligns with secondary height units
- pedestal front locking
- upper compartment has three adjustable shelves
- installed coat hook in wardrobe compartment

Options:

- must specify chassis grain direction on artisan veneer, see pages 13-15 for details
- veneer door and drawer front in paint available, specify paint color and add \$354; see page 16 for details
- on laminate units, contrasting door and drawer fronts available, no upcharge; specify color, see page 16 for details
- locking doors available, specify and add \$294 list
- ledge pulls standard; prism pulls available, specify and see page 9
- vanity mirror available, specify and add \$149 list

69" h Box/File, Open Storage Cabinet with Side Wardrobe	22	24	69	214	26	FLT2224-69F50WR	\$2,967		
	22	24	69	214	26	FLV2224-69F50WR		\$4,783	\$5,263
	22	24	69	214	26	FLT2224-69F50WL	\$2,967		
	22	24	69	214	26	FLV2224-69F50WL		\$4,783	\$5,263

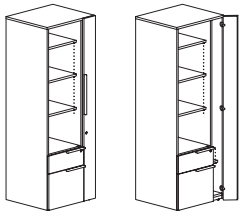

right shown

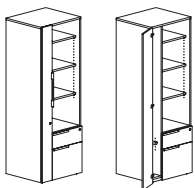

left

Features:

- aligns with secondary height units
- pedestal front locking
- upper compartment has three adjustable shelves
- installed coat hook in wardrobe compartment

Options:

- must specify chassis grain direction on artisan veneer, see pages 13-15 for details
- veneer door and drawer front in paint available, specify paint color and add \$354; see page 16 for details
- on laminate units, contrasting door and drawer fronts available, no upcharge; specify color, see page 16 for details
- locking side door available, specify and add \$147 list
- ledge pulls standard; prism pulls available, specify and see page 9

Description	D	W	H	CTN WT	CU FT	① Model	Laminate	Essentials Veneer	Artisan Veneer
69" h Lower and Upper Hinge Door Storage Cabinet with Side Wardrobe	22	24	69	219	26	FLT2224-69F8DWR	\$2,410		
	22	24	69	219	26	FLV2224-69F8DWR		\$4,192	\$4,613
	22	24	69	219	26	FLT2224-69F8DWL	\$2,410		
	22	24	69	219	26	FLV2224-69F8DWL		\$4,192	\$4,613

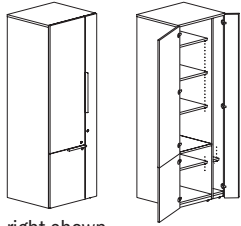

right shown

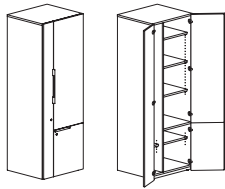

left

Features:

- aligns with secondary height units
- upper compartment has three adjustable shelves, lower compartment has one adjustable shelf
- installed coat hook in wardrobe compartment

Options:

- must specify chassis grain direction on artisan veneer, see pages 13-15 for details
- veneer door fronts in paint available, specify paint color and add \$354 list; see page 16 for detail
- on laminate units, contrasting door and drawer fronts available, no upcharge; specify color, see page 16 for details
- locking doors available, specify and add \$441 list
- ledge pulls standard; prism pulls available, specify and see page 9
- vanity mirror available, specify and add \$149 list

69" h Lower Hinge Door, Open Storage Cabinet with Side Wardrobe	22	24	69	199	26	FLT2224-69F8OWR	\$2,319		
	22	24	69	199	26	FLV2224-69F8OWR		\$4,061	\$4,466
	22	24	69	199	26	FLT2224-69F8OWL	\$2,319		
	22	24	69	199	26	FLV2224-69F8OWL		\$4,061	\$4,466

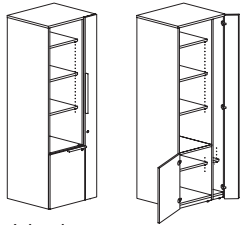

right shown

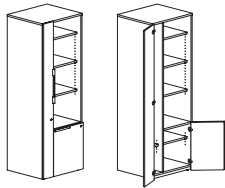

left

Features:

- aligns with secondary height units
- upper compartment has three adjustable shelves, lower compartment has one adjustable shelf
- installed coat hook in wardrobe compartment

Options:

- must specify chassis grain direction on artisan veneer, see pages 13-15 for details
- veneer door fronts in paint available, specify paint color and add \$354 list; see page 16 for detail
- on laminate units, contrasting doors fronts available, no upcharge; specify color, see page 16 for details
- locking doors available, specify and add \$294 list
- ledge pulls standard; prism pulls available, specify and see page 9

To Order, Specify:

① Laminate Model #		② Laminate Selection		③ Metal Color	④ Other Product Options
Laminate (FLT)		See Laminate Selection		See Metal Finish Color Options	See list of options for each specific unit; Specify and add accordingly.
① Veneer Model #	② Wood Collection	③ Wood Finish		④ Metal Color	⑤ Other Product Options
Veneer (FLV)	Essentials	See Essentials Wood Finish Options		See Metal Finish Color Options	See list of options for each specific unit; Specify and add accordingly.
	Artisan	ⓐ Wood Finish See Artisan Wood Finish Options	ⓑ Chassis Grain Direction For Artisan Only: Vertical Horizontal		

Description	D	W	H	CTN WT	CU FT	① Model	Laminate	Essentials Veneer	Artisan Veneer
81" h Box/ File Lateral, Storage Cabinet	22	36	81	342	44	FLT2236-81F6D	\$3,454		
	22	36	81	342	44	FLV2236-81F6D		\$5,521	\$6,074
	22	30	81	296	37	FLT2230-81F6D	\$3,264		
	22	30	81	296	37	FLV2230-81F6D		\$5,274	\$5,799

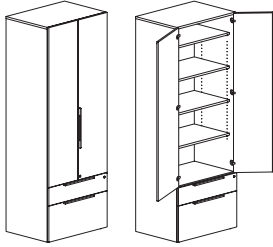

Features:

- aligns with secondary height units
- pedestal front locking
- upper compartment has four adjustable shelves

Options:

- must specify chassis grain direction on artisan veneer, see pages 13-15 for details
- veneer door and drawer front in paint available, specify paint color and add \$354; see page 16 for details
- on laminate units, contrasting door and drawer fronts available, no upcharge; specify color, see page 16 for details
- locking door available, specify and add \$147 list
- ledge pulls standard; prism pulls available, specify and see page 9

81" h Box/ File Lateral, Open Storage Cabinet	22	36	81	293	44	FLT2236-81F60	\$3,245		
	22	36	81	293	44	FLV2236-81F60		\$5,245	\$5,772
	22	30	81	255	37	FLT2230-81F60	\$3,072		
	22	30	81	255	37	FLV2230-81F60		\$5,014	\$5,516

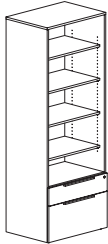

Features:

- aligns with secondary height units
- pedestal front locking
- upper compartment has four adjustable shelves

Options:

- must specify chassis grain direction on artisan veneer, see pages 13-15 for details
- veneer drawer fronts in paint available, specify paint color and add \$354 list; see page 16 for details
- on laminate units, contrasting drawer fronts available, no upcharge; specify color, see page 16 for details
- locking door available, specify and add \$147 list
- ledge pulls standard; prism pulls available, specify and see page 9

FLUX

Description	D	W	H	CTN WT	CU FT	① Model	Laminate	Essentials Veneer	Artisan Veneer
81" h Lower and Upper Hinge Door Storage Cabinet	22	36	81	324	44	FLT2236-81F8D	\$2,863		
	22	36	81	324	44	FLV2236-81F8D		\$4,891	\$5,380
	22	30	81	281	37	FLT2230-81F8D	\$2,688		
	22	30	81	281	37	FLV2230-81F8D		\$4,667	\$5,133

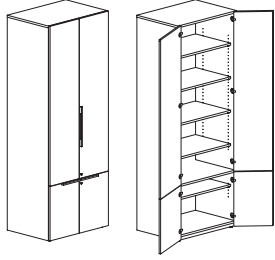

Features:

- aligns with secondary height units
- upper compartment has four adjustable shelves, lower compartment has one adjustable shelf

Options:

- must specify chassis grain direction on artisan veneer, see pages 13-15 for details
- veneer door fronts in paint available, specify paint color and add \$354 list; see page 16 for details
- on laminate units, contrasting doors fronts available, no upcharge; specify color, see page 16 for details
- locking doors available, specify and add \$294 list
- ledge pulls standard, mounted vertical; prism pulls available, specify and see page 9

81" h Lower Hinge Doors, Open Storage Cabinet	22	36	81	275	44	FLT2236-81F80	\$2,654		
	22	36	81	275	44	FLV2236-81F80		\$4,618	\$5,079
	22	30	81	240	37	FLT2230-81F80	\$2,492		
	22	30	81	240	37	FLV2230-81F80		\$4,409	\$4,850

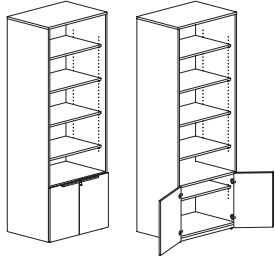

Features:

- aligns with secondary height units
- upper compartment has four adjustable shelves, lower compartment has one adjustable shelf

Options:

- must specify chassis grain direction on artisan veneer, see pages 13-15 for details
- veneer door fronts in paint available, specify paint color and add \$354 list; see page 16 for details
- on laminate units, contrasting doors fronts available, no upcharge; specify color, see page 16 for details
- locking doors available, specify and add \$147 list
- ledge pulls standard; prism pulls available, specify and see page 9

To Order, Specify:

① Laminate Model #		② Laminate Selection		③ Metal Color	④ Other Product Options
Laminate (FLT)		See Laminate Selection		See Metal Finish Color Options	See list of options for each specific unit; Specify and add accordingly.
① Veneer Model #	② Wood Collection	③ Wood Finish		④ Metal Color	⑤ Other Product Options
Veneer (FLV)	Essentials	See Essentials Wood Finish Options		See Metal Finish Color Options	See list of options for each specific unit; Specify and add accordingly.
	Artisan	③a Wood Finish See Artisan Wood Finish Options	③b Chassis Grain Direction For Artisan Only: Vertical Horizontal		

Description	D	W	H	CTN WT	CU FT	① Model	Laminate	Essentials Veneer	Artisan Veneer
69" h Box/File Lateral, Storage Cabinet	22	36	69	292	38	FLT2236-69F6D	\$3,143		
	22	36	69	292	38	FLV2236-69F6D		\$5,077	\$5,582
	22	30	69	205	32	FLT2230-69F6D	\$2,982		
	22	30	69	205	32	FLV2230-69F6D		\$4,868	\$5,354

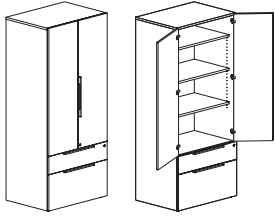

Features:

- aligns with secondary height units
- pedestal front locking
- upper compartment has three adjustable shelves

Options:

- must specify chassis grain direction on artisan veneer, see pages 13-15 for details
- veneer door and drawer front in paint available, specify paint color and add \$354; see page 16 for details
- on laminate units, contrasting door and drawer fronts available, no upcharge; specify color, see page 16 for details
- locking upper doors available, specify and add \$147 list
- ledge pulls standard; prism pulls available, specify and see page 9

69" h Box/File Lateral, Open Storage Cabinet	22	36	69	261	38	FLT2236-69F60	\$2,970		
	22	36	69	261	38	FLV2236-69F60		\$4,853	\$5,339
	22	30	69	235	32	FLT2230-69F60	\$2,820		
	22	36	69	235	32	FLV2230-69F60		\$4,659	\$5,126

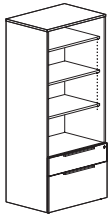

Features:

- aligns with secondary height units
- pedestal front locking
- upper compartment has three adjustable shelves

Options:

- must specify chassis grain direction on artisan veneer, see pages 13-15 for details
- veneer drawer fronts in paint available, specify paint color and add \$354 list; see page 16 for details
- on laminate units, contrasting drawer fronts available, no upcharge; specify color, see page 16 for details
- ledge pulls standard; prism pulls available, specify and see page 9

FLUX

Description	D	W	H	CTN WT	CU FT	① Model	Laminate	Essentials Veneer	Artisan Veneer
69" h Lower and Upper Hinge Door Storage Cabinet	22	36	69	235	38	FLT2236-69F8D	\$2,551		
	22	36	69	235	38	FLV2236-69F8D		\$4,446	\$4,891
	22	30	69	232	32	FLT2230-69F8D	\$2,405		
	22	30	69	232	32	FLV2230-69F8D		\$4,261	\$4,688

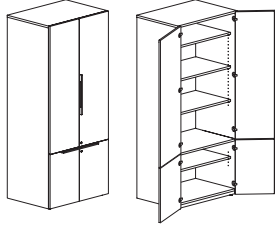

Features:

- aligns with secondary height units
- upper compartment has three adjustable shelves, lower compartment has one adjustable shelf

Options:

- must specify chassis grain direction on artisan veneer, see pages 13-15 for details
- veneer door fronts in paint available, specify paint color and add \$354 list; see page 16 for details
- on laminate units, contrasting doors fronts available, no upcharge; specify color, see page 16 for details
- locking doors available, specify and add \$294 list
- ledge pulls standard; prism pulls available, specify and see page 9

69" h Lower Hinge Doors, Open Storage Cabinet	22	36	69	216	38	FLT2236-69F80	\$2,378		
	22	36	69	216	38	FLV2236-69F80		\$4,225	\$4,646
	22	30	69	199	32	FLT2230-69F80	\$2,242		
	22	30	69	199	32	FLV2230-69F80		\$4,050	\$4,459

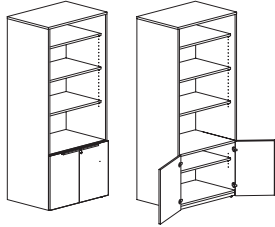

Features:

- aligns with secondary height units
- upper compartment has three adjustable shelves, lower compartment has one adjustable shelf

Options:

- must specify chassis grain direction on artisan veneer, see pages 13-15 for details
- veneer door fronts in paint available, specify paint color and add \$354 list; see page 16 for details
- on laminate units, contrasting doors fronts available, no upcharge; specify color, see page 16 for details
- locking lower doors available specify and add \$147 list
- ledge pulls standard; prism pulls available, specify and see page 9

To Order, Specify:

① Laminate Model #		② Laminate Selection		③ Metal Color	④ Other Product Options
Laminate (FLT)		See Laminate Selection		See Metal Finish Color Options	See list of options for each specific unit; Specify and add accordingly.
① Veneer Model #	② Wood Collection	③ Wood Finish		④ Metal Color	⑤ Other Product Options
Veneer (FLV)	Essentials	See Essentials Wood Finish Options		See Metal Finish Color Options	See list of options for each specific unit; Specify and add accordingly.
	Artisan	③a Wood Finish See Artisan Wood Finish Options	③b Chassis Grain Direction For Artisan Only: Vertical Horizontal		

Description	D	W	H	CTN WT	CU FT	① Model	Laminate	Essentials Veneer	Artisan Veneer
81" h Box/File, Storage Cabinet	22	18	81	210	24	FLT2218-81F5DR	\$2,562		
	22	18	81	210	24	FLV2218-81F5DR		\$4,078	\$4,486
	22	18	81	210	24	FLT2218-81F5DL	\$2,562		
	22	18	81	210	24	FLV2218-81F5DL		\$4,078	\$4,486

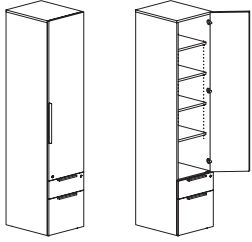

right shown

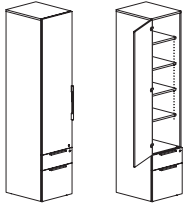

left

Features:

- aligns with secondary height units
- pedestal front locking
- upper compartment has four adjustable shelves

Options:

- must specify chassis grain direction on artisan veneer, see pages 13-15 for details
- veneer door and drawer front in paint available, specify paint color and add \$354; see page 16 for details
- on laminate units, contrasting door and drawer fronts available, no upcharge; specify color, see page 16 for details
- locking door available, specify and add \$147 list
- ledge pulls standard; prism pulls available, specify and see page 9
- vanity mirror available, specify and add \$149 list

81" h Box/File, Open Storage Cabinet	22	18	81	185	24	FLT2218-81F50	\$2,448		
	22	18	81	185	24	FLV2218-81F50		\$3,912	\$4,304

Features:

- aligns with secondary height units
- pedestal front locking
- upper compartment has four adjustable shelves

Options:

- must specify chassis grain direction on artisan veneer, see pages 13-15 for details
- veneer drawer fronts in paint available, specify paint color and add \$354 list; see page 16 for details
- on laminate units, contrasting drawer fronts available, no upcharge; specify color, see page 16 for details
- ledge pulls standard; prism pulls available, specify and see page 9

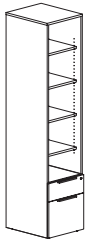

FLUX

Description	D	W	H	CTN WT	CU FT	① Model	Laminate	Essentials Veneer	Artisan Veneer
81" h Lower and Upper Hinge Door Storage Cabinet	22	18	81	188	24	FLT2218-81F8DR	\$2,006		
	22	18	81	188	24	FLV2218-81F8DR		\$3,485	\$3,835
	22	18	81	188	24	FLT2218-81F8DL	\$2,006		
	22	18	81	188	24	FLV2218-81F8DL		\$3,485	\$3,835

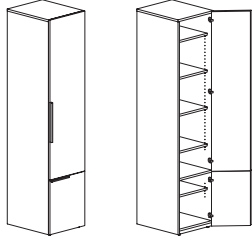

right shown

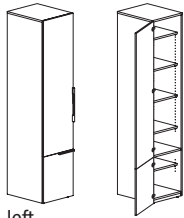

left

Features:

- aligns with secondary height units
- upper compartment has four adjustable shelves, lower compartment has one adjustable shelf

Options:

- must specify chassis grain direction on artisan veneer, see pages 13-15 for details
- veneer door fronts in paint available, specify paint color and add \$354 list; see page 16 for details
- on laminate units, contrasting doors fronts available, no upcharge; specify color, see page 16 for details
- locking doors available, specify and add \$294 list
- ledge pulls standard, mounted vertical; prism pulls available, specify and see page 9
- vanity mirror available, specify and add \$149 list

81" h Lower Hinge Door, Open Storage Cabinet	D	W	H	CTN WT	CU FT	Model	Laminate	Essentials Veneer	Artisan Veneer
	22	18	81	170	24	FLT2218-81F80R	\$1,894		
	22	18	81	170	24	FLV2218-81F80R		\$3,321	\$3,653
	22	18	81	170	24	FLT2218-81F80L	\$1,894		
	22	18	81	170	24	FLV2218-81F80L		\$3,321	\$3,653

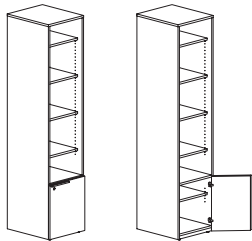

right shown

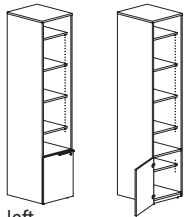

left

Features:

- aligns with secondary height units
- upper compartment has four adjustable shelves

Options:

- must specify chassis grain direction on artisan veneer, see pages 13-15 for details
- veneer door front in paint available, specify paint color and add \$354 list; see page 16 for details
- on laminate units, contrasting doors fronts available, no upcharge; specify color, see page 16 for details
- locking lower door available, specify and add \$147 list
- ledge pulls standard; prism pulls available, specify and see page 9

To Order, Specify:

① Laminate Model #	② Laminate Selection	③ Metal Color	④ Other Product Options
Laminate (FLT)	See Laminate Selection	See Metal Finish Color Options	See list of options for each specific unit; Specify and add accordingly.

① Veneer Model #	② Wood Collection	③ Wood Finish	④ Metal Color	⑤ Other Product Options	
Veneer (FLV)	Essentials	See Essentials Wood Finish Options	See Metal Finish Color Options	See list of options for each specific unit; Specify and add accordingly.	
	Artisan	<table border="1"> <thead> <tr> <th>Ⓐ Wood Finish</th> <th>Ⓑ Chassis Grain Direction</th> </tr> </thead> <tbody> <tr> <td>See Artisan Wood Finish Options</td> <td>For Artisan Only: Vertical Horizontal</td> </tr> </tbody> </table>			Ⓐ Wood Finish
Ⓐ Wood Finish	Ⓑ Chassis Grain Direction				
See Artisan Wood Finish Options	For Artisan Only: Vertical Horizontal				

Description	D	W	H	CTN WT	CU FT	① Model	Laminate	Essentials Veneer	Artisan Veneer
69" h Box/File, Storage Cabinet	22	18	69	183	20	FLT2218-69F5DR	\$2,360		
	22	18	69	183	20	FLV2218-69F5DR		\$3,788	\$4,167
	22	18	69	183	20	FLT2218-69F5DL	\$2,360		
	22	18	69	183	20	FLV2218-69F5DL		\$3,788	\$4,167

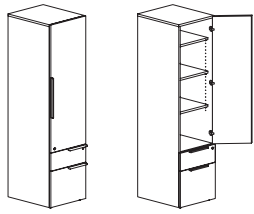

right shown

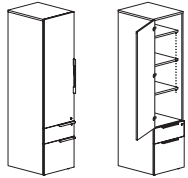

left

Features:

- aligns with secondary height units
- pedestal front locking
- upper compartment has three adjustable shelves

Options:

- must specify chassis grain direction on artisan veneer, see pages 13-15 for details
- veneer door and drawer front in paint available, specify paint color and add \$354; see page 16 for details
- on laminate units, contrasting door and drawer fronts available, no upcharge; specify color, see page 16 for details
- locking upper door available, specify and add \$147 list
- ledge pulls standard; prism pulls available, specify and see page 9
- vanity mirror available, specify and add \$149 list

69" h Box/File, Open Storage Cabinet	22	18	69	163	20	FLT2218-69F50	\$2,270		
	22	18	69	163	20	FLV2218-69F50		\$3,657	\$4,024

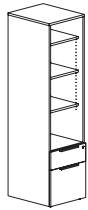

Features:

- aligns with secondary height units
- pedestal front locking
- upper compartment has three adjustable shelves

Options:

- must specify chassis grain direction on artisan veneer, see pages 13-15 for details
- veneer drawer fronts in paint available, specify paint color and add \$354 list; see page 16 for details
- on laminate units, contrasting drawer fronts available, no upcharge; specify color, see page 16 for details
- ledge pulls standard; prism pulls available, specify and see page 9

Description	D	W	H	CTN WT	CU FT	① Model	Laminate	Essentials Veneer	Artisan Veneer
69" h Lower and Upper Hinge Door Storage Cabinet	22	18	69	168	20	FLT2218-69F8DR	\$1,805		
	22	18	69	168	20	FLV2218-69F8DR		\$3,199	\$3,517
	22	18	69	168	20	FLT2218-69F8DL	\$1,805		
	22	18	69	168	20	FLV2218-69F8DL		\$3,199	\$3,517

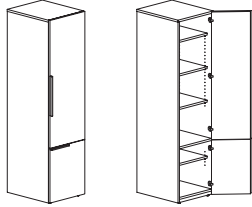

right shown

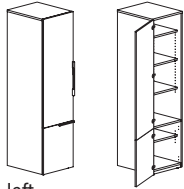

left

Features:

- aligns with secondary height units
- upper compartment has three adjustable shelves, lower compartment has one adjustable shelf

Options:

- must specify chassis grain direction on artisan veneer, see pages 13-15 for details
- veneer door fronts in paint available, specify paint color and add \$354 list; see page 16 for details
- on laminate units, contrasting doors fronts available, no upcharge; specify color, see page 16 for details
- locking doors available, specify and add \$294 list
- ledge pulls standard; prism pulls available, specify and see page 9

69" h Lower Hinge Door, Open Storage Cabinet	22	18	69	148	20	FLT2218-69F8OR	\$1,712		
	22	18	69	148	20	FLV2218-69F8OR		\$3,066	\$3,373
	22	18	69	148	20	FLT2218-69F8OL	\$1,712		
	22	18	69	148	20	FLV2218-69F8OL		\$3,066	\$3,373

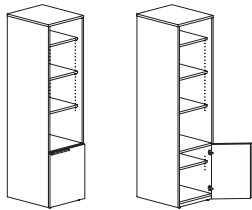

right shown

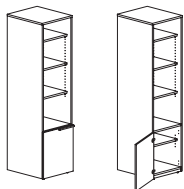

left

Features:

- aligns with secondary height units
- upper compartment has three adjustable shelves

Options:

- must specify chassis grain direction on artisan veneer, see pages 13-15 for details
- veneer door front in paint available, specify paint color and add \$354 list; see page 16 for details
- on laminate units, contrasting doors fronts available, no upcharge; specify color, see page 16 for details
- locking door available, specify and add \$147 list
- ledge pulls standard; prism pulls available, specify and see page 9

To Order, Specify:

① Laminate Model #		② Laminate Selection		③ Metal Color	④ Other Product Options
Laminate (FLT)		See Laminate Selection		See Metal Finish Color Options	See list of options for each specific unit; Specify and add accordingly.
① Veneer Model #	② Wood Collection	③ Wood Finish		④ Metal Color	⑤ Other Product Options
Veneer (FLV)	Essentials	See Essentials Wood Finish Options		See Metal Finish Color Options	See list of options for each specific unit; Specify and add accordingly.
	Artisan	3a Wood Finish See Artisan Wood Finish Options	3b Chassis Grain Direction For Artisan Only: Vertical Horizontal		

Description	D	W	H	CTN WT	CU FT	① Model	Laminate	Essentials Veneer	Artisan Veneer
81" h Wardrobe	22	18	81	161	24	FLT2218-81LDWR	\$2,643		
	22	18	81	161	24	FLV2218-81LDWR		\$3,663	\$4,026
	22	18	81	161	24	FLT2218-81LDWL	\$2,643		
	22	18	81	161	24	FLV2218-81LDWL		\$3,663	\$4,026

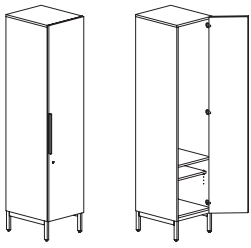

right shown



left

Features:

- lower adjustable shelf
- installed coat hooks

Options:

- must specify chassis grain direction on artisan veneer, see pages 13-15 for details
- veneer door front in paint available, specify paint color and add \$354 list; see page 16 for details
- on laminate units, contrasting doors fronts available, no upcharge; specify color, see page 16 for details
- locking door available, specify and add \$147 list
- ledge pulls standard, mounted vertical; prism pulls available, specify and see page 9
- vanity mirror available, specify and add \$149 list

81" h Storage Cabinet	22	18	81	187	24	FLT2218-81LDR	\$2,633		
	22	18	81	187	24	FLV2218-81LDR		\$3,652	\$4,019
	22	18	81	187	24	FLT2218-81LDL	\$2,633		
	22	18	81	187	24	FLV2218-81LDL		\$3,652	\$4,019

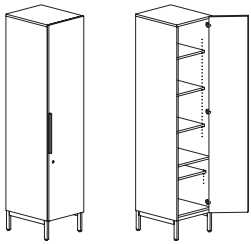

right shown

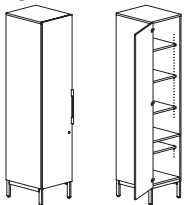

left

Features:

- five adjustable shelves

Options:

- must specify chassis grain direction on artisan veneer, see pages 13-15 for details
- veneer door fronts in paint available, specify paint color and add \$354 list; see page 16 for details
- on laminate units, contrasting doors fronts available, no upcharge; specify color, see page 16 for details
- locking door available, specify and add \$147 list
- ledge pulls standard, mounted vertical; prism pulls available, specify and see page 9
- vanity mirror available, specify and add \$149 list

Description	D	W	H	CTN WT	CU FT	① Model	Laminate	Essentials Veneer	Artisan Veneer
69" h Wardrobe	22	18	69	147	20	FLT2218-69LDWR	\$2,440		
	22	18	69	147	20	FLV2218-69LDWR		\$3,372	\$3,709
	22	18	69	147	20	FLT2218-69LDWL	\$2,440		
	22	18	69	147	20	FLV2218-69LDWL		\$3,372	\$3,709

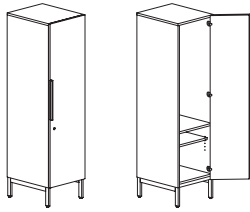

right shown

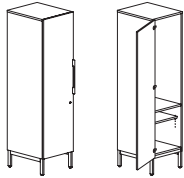

left

Features:

- lower adjustable shelf
- installed coat hooks

Options:

- must specify chassis grain direction on artisan veneer, see pages 13-15 for details
- veneer door front in paint available, specify paint color and add \$354 list; see page 16 for details
- on laminate units, contrasting doors fronts available, no upcharge; specify color, see page 16 for details
- locking door available, specify and add \$147 list
- ledge pulls standard, mounted vertical; prism pulls available, specify and see page 9
- vanity mirror available, specify and add \$149 list

69" h Storage Cabinet	22	18	69	159	20	FLT2218-69LDR	\$2,432		
	22	18	69	159	20	FLV2218-69LDR		\$3,364	\$3,701
	22	18	69	159	20	FLT2218-69LDL	\$2,432		
	22	18	69	159	20	FLV2218-69LDL		\$3,364	\$3,701

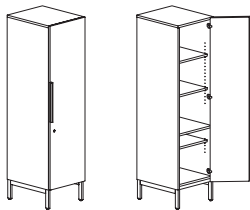

right shown

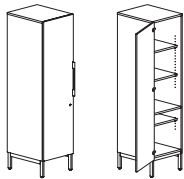

left

Features:

- four adjustable shelves

Options:

- must specify chassis grain direction on artisan veneer, see pages 13-15 for details
- veneer door front in paint available, specify paint color and add \$354 list; see page 16 for details
- on laminate units, contrasting doors fronts available, no upcharge; specify color, see page 16 for details
- locking door available, specify and add \$147 list
- ledge pulls standard, mounted vertical; prism pulls available, specify and see page 9
- vanity mirror available, specify and add \$149 list

To Order, Specify:

① Laminate Model #	② Laminate Selection	③ Metal Color	④ Other Product Options			
Laminate (FLT)	See Laminate Selection	See Metal Finish Color Options	See list of options for each specific unit; Specify and add accordingly.			
① Veneer Model #	② Wood Collection	③ Wood Finish	④ Metal Color	⑤ Other Product Options		
Veneer (FLV)	Essentials	See Essentials Wood Finish Options	See Metal Finish Color Options	See list of options for each specific unit; Specify and add accordingly.		
	Artisan	<table border="1"> <thead> <tr> <th>③a Wood Finish</th> <th>③b Chassis Grain Direction</th> </tr> </thead> <tbody> <tr> <td>See Artisan Wood Finish Options</td> <td>For Artisan Only: Vertical Horizontal</td> </tr> </tbody> </table>	③a Wood Finish		③b Chassis Grain Direction	See Artisan Wood Finish Options
③a Wood Finish	③b Chassis Grain Direction					
See Artisan Wood Finish Options	For Artisan Only: Vertical Horizontal					

Description	D	W	H	CTN WT	CU FT	① Model	Laminate	Essentials Veneer	Artisan Veneer
81" h Box/File, Storage Cabinet with Side Wardrobe	22	24	81	260	30	FLT2224-81L5DWR	\$3,994		
	22	24	81	260	30	FLV2224-81L5DWR		\$5,466	\$6,012
	22	24	81	260	30	FLT2224-81L5DWL	\$3,994		
	22	24	81	260	30	FLV2224-81L5DWL		\$5,466	\$6,012

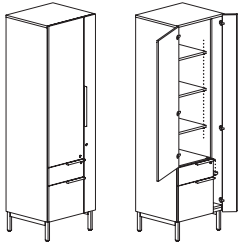

right shown

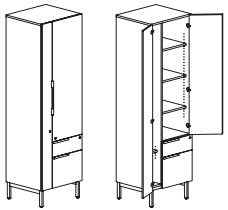

left

Features:

- aligns with primary height units
- pedestal front locking
- upper compartment has three adjustable shelves
- installed coat hook in wardrobe compartment

Options:

- must specify chassis grain direction on artisan veneer, see pages 13-15 for details
- veneer door and drawer front in paint available, specify paint color and add \$354; see page 16 for details
- on laminate units, contrasting door and drawer fronts available, no upcharge; specify color, see page 16 for details
- locking doors available, specify and add \$294 list
- ledge pulls standard; prism pulls available, specify and see page 9
- vanity mirror available, specify and add \$149 list

81" h Box/File, Open Storage Cabinet with Side Wardrobe	22	24	81	241	30	FLT2224-81L50WR	\$3,880		
	22	24	81	241	30	FLV2224-81L50WR		\$5,301	\$5,831
	22	24	81	241	30	FLT2224-81L50WL	\$3,880		
	22	24	81	241	30	FLV2224-81L50WL		\$5,301	\$5,831

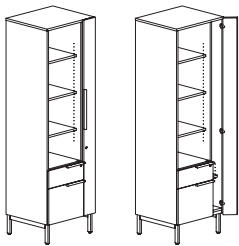

right shown

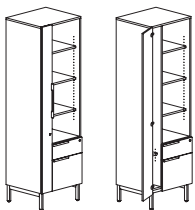

left

Features:

- aligns with primary height units
- pedestal front locking
- upper compartment has three adjustable shelves
- installed coat hook in wardrobe compartment

Options:

- must specify chassis grain direction on artisan veneer, see pages 13-15 for details
- veneer door and drawer front in paint available, specify paint color and add \$354; see page 16 for details
- on laminate units, contrasting door and drawer fronts available, no upcharge; specify color, see page 16 for details
- locking door available, specify and add \$147 list
- ledge pulls standard; prism pulls available, specify and see page 9

Description	D	W	H	CTN WT	CU FT	① Model	Laminate	Essentials Veneer	Artisan Veneer
81" Lower and Upper Hinge Door Storage Cabinet with Side Wardrobe	22	24	81	253	30	FLT2224-81L8DWR	\$3,344		
	22	24	81	253	30	FLV2224-81L8DWR		\$4,743	\$5,219
	22	24	81	253	30	FLT2224-81L8DWL	\$3,344		
	22	24	81	253	30	FLV2224-81L8DWL		\$4,743	\$5,219

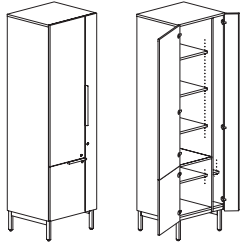

right shown

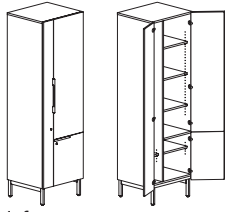

left

Features:

- aligns with primary height units
- upper compartment has three adjustable shelves, lower compartment has one adjustable shelf
- installed coat hook in wardrobe compartment

Options:

- must specify chassis grain direction on artisan veneer, see pages 13-15 for details
- veneer door fronts in paint available, specify paint color and add \$354 list; see page 16 for detail
- on laminate units, contrasting doors fronts available, no upcharge; specify color, see page 16 for details
- locking doors available, specify and add \$441 list
- ledge pulls standard; prism pulls available, specify and see page 9
- vanity mirror available, specify and add \$149 list

81" h Lower Hinge Door, Open Storage Cabinet with Side Wardrobe	22	24	81	226	30	FLT2224-81L80WR	\$3,232		
	22	24	81	226	30	FLV2224-81L80WR		\$4,578	\$5,036
	22	24	81	226	30	FLT2224-81L80WL	\$3,232		
	22	24	81	226	30	FLV2224-81L80WL		\$4,578	\$5,036

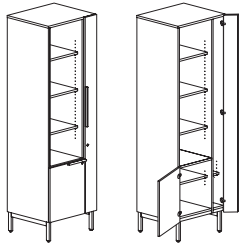

right shown

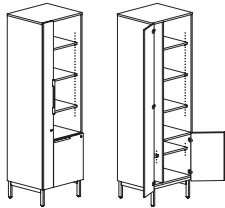

left

Features:

- aligns with primary height units
- upper compartment has two adjustable shelves, lower compartment has one adjustable shelf
- installed coat hook in wardrobe compartment

Options:

- must specify chassis grain direction on artisan veneer, see pages 13-15 for details
- veneer door fronts in paint available, specify paint color and add \$354 list; see page 16 for detail
- on laminate units, contrasting doors fronts available, no upcharge; specify color, see page 16 for details
- locking doors available, specify and add \$294 list
- ledge pulls standard; prism pulls available, specify and see page 9

To Order, Specify:

① Laminate Model #	② Laminate Type	③ Laminate Selection	④ Metal Color	⑤ Other Product Options
Laminate (FLT)	HPL	See Laminate Selection	See Metal Finish Color Options	See list of options for each specific unit; Specify and add accordingly.

① Veneer Model #	② Wood Collection	③ Wood Finish - Finishes with an asterisk (*) have a coordinating laminate available	④ Metal Color	⑤ Other Product Options		
Veneer (FLV)	Essentials	See Essentials Wood Finish Options	See Metal Finish Color Options	See list of options for each specific unit; Specify and add accordingly.		
	Artisan	<table border="1"> <thead> <tr> <th>③a Wood Finish</th> <th>③b Chassis Grain Direction</th> </tr> </thead> <tbody> <tr> <td>See Artisan Wood Finish Options</td> <td>For Artisan Only: Vertical Horizontal</td> </tr> </tbody> </table>	③a Wood Finish		③b Chassis Grain Direction	See Artisan Wood Finish Options
③a Wood Finish	③b Chassis Grain Direction					
See Artisan Wood Finish Options	For Artisan Only: Vertical Horizontal					

Description	D	W	H	CTN WT	CU FT	① Model	Laminate	Essentials Veneer	Artisan Veneer
69" h Box/File, Storage Cabinet with Side Wardrobe	22	24	69	236	26	FLT2224-69L5DWR	\$3,789		
	22	24	69	236	26	FLV2224-69L5DWR		\$5,176	\$5,695
	22	24	69	236	26	FLT2224-69L5DWL	\$3,789		
	22	24	69	236	26	FLV2224-69L5DWL		\$5,176	\$5,695

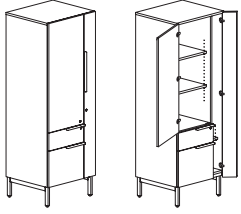

right shown

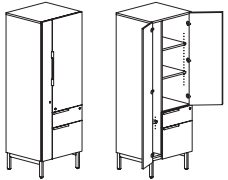

left

Features:

- aligns with primary height units
- pedestal front locking
- upper compartment has two adjustable shelves
- installed coat hook in wardrobe compartment

Options:

- must specify chassis grain direction on artisan veneer, see pages 13-15 for details
- veneer door and drawer front in paint available, specify paint color and add \$354; see page 16 for details
- on laminate units, contrasting door and drawer fronts available, no upcharge; specify color, see page 16 for details
- locking doors available, specify and add \$294 list
- ledge pulls standard; prism pulls available, specify and see page 9
- vanity mirror available, specify and add \$149 list

69" h Box/File, Open Storage Cabinet with Side Wardrobe	22	24	69	208	26	FLT2224-69L50WR	\$3,700		
	22	24	69	208	26	FLV2224-69L50WR		\$5,047	\$5,552
	22	24	69	208	26	FLT2224-69L50WL	\$3,700		
	22	24	69	208	26	FLV2224-69L50WL		\$5,047	\$5,552

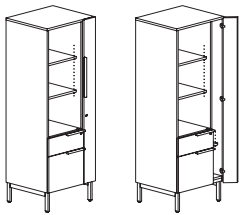

right shown

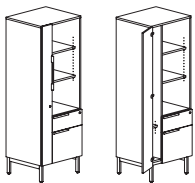

left

Features:

- aligns with primary height units
- pedestal front locking
- upper compartment has two adjustable shelves
- installed coat hook in wardrobe compartment

Options:

- must specify chassis grain direction on artisan veneer, see pages 13-15 for details
- veneer door and drawer front in paint available, specify paint color and add \$354; see page 16 for details
- on laminate units, contrasting door and drawer fronts available, no upcharge; specify color, see page 16 for details
- locking door available, specify and add \$147 list
- ledge pulls standard; prism pulls available, specify and see page 9

Description	D	W	H	CTN WT	CU FT	① Model	Laminate	Essentials Veneer	Artisan Veneer
69" h Lower and Upper Hinge Door Storage Cabinet with Side Wardrobe	22	24	69	224	26	FLT2224-69L8DWR	\$3,143		
	22	24	69	224	26	FLV2224-69L8DWR		\$4,456	\$4,899
	22	24	69	224	26	FLT2224-69L8DWL	\$3,143		
	22	24	69	224	26	FLV2224-69L8DWL		\$4,456	\$4,899

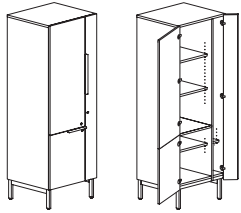

right shown

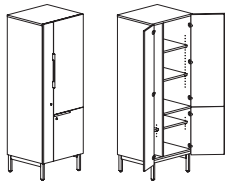

left

Features:

- aligns with primary height units
- upper compartment has two adjustable shelves, lower compartment has one adjustable shelf
- installed coat hook in wardrobe compartment

Options:

- must specify chassis grain direction on artisan veneer, see pages 13-15 for details
- veneer door fronts in paint available, specify paint color and add \$354 list; see page 16 for detail
- on laminate units, contrasting doors fronts available, no upcharge; specify color, see page 16 for details
- locking doors available, specify and add \$441 list
- ledge pulls standard; prism pulls available, specify and see page 9
- vanity mirror available, specify and add \$149 list

69" h Lower Hinge Door, Open Storage Cabinet with Side Wardrobe	22	24	69	202	26	FLT2224-69L8OWR	\$3,051		
	22	24	69	202	26	FLV2224-69L8OWR		\$4,322	\$4,755
	22	24	69	202	26	FLT2224-69L8OWL	\$3,051		
	22	24	69	202	26	FLV2224-69L8OWL		\$4,322	\$4,755

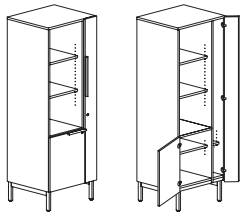

right shown

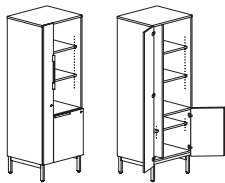

left

Features:

- aligns with primary height units
- upper compartment has two adjustable shelves, lower compartment has one adjustable shelf
- installed coat hook in wardrobe compartment

Options:

- must specify chassis grain direction on artisan veneer, see pages 13-15 for details
- veneer door fronts in paint available, specify paint color and add \$354 list; see page 16 for detail
- on laminate units, contrasting doors fronts available, no upcharge; specify color, see page 16 for details
- locking doors available, specify and add \$294 list
- ledge pulls standard; prism pulls available, specify and see page 9

To Order, Specify:

① Laminate Model #	② Laminate Selection	③ Metal Color	④ Other Product Options
Laminate (FLT)	See Laminate Selection	See Metal Finish Color Options	See list of options for each specific unit; Specify and add accordingly.

① Veneer Model #	② Wood Collection	③ Wood Finish	④ Metal Color	⑤ Other Product Options		
Veneer (FLV)	Essentials	See Essentials Wood Finish Options	See Metal Finish Color Options	See list of options for each specific unit; Specify and add accordingly.		
	Artisan	<table border="1"> <thead> <tr> <th>③a Wood Finish</th> <th>③b Chassis Grain Direction</th> </tr> </thead> <tbody> <tr> <td>See Artisan Wood Finish Options</td> <td>For Artisan Only: Vertical Horizontal</td> </tr> </tbody> </table>	③a Wood Finish		③b Chassis Grain Direction	See Artisan Wood Finish Options
③a Wood Finish	③b Chassis Grain Direction					
See Artisan Wood Finish Options	For Artisan Only: Vertical Horizontal					

Description	D	W	H	CTN WT	CU FT	① Model	Laminate	Essentials Veneer	Artisan Veneer
81" h Side Access Wardrobe with Open Shelves	15 $\frac{7}{8}$	36	81	203	32	FLT1636-81LSWR	\$2,865		
	15 $\frac{7}{8}$	36	81	203	32	FLV1636-81LSWR		\$4,381	\$4,819
	15 $\frac{7}{8}$	36	81	203	32	FLT1636-81LSWL	\$2,865		
	15 $\frac{7}{8}$	36	81	203	32	FLV1636-81LSWL		\$4,381	\$4,819
	15 $\frac{7}{8}$	30	81	178	27	FLT1630-81LSWR	\$2,669		
	15 $\frac{7}{8}$	30	81	178	27	FLV1630-81LSWR		\$4,055	\$4,461
	15 $\frac{7}{8}$	30	81	178	27	FLT1630-81LSWL	\$2,669		
	15 $\frac{7}{8}$	30	81	178	27	FLV1630-81LSWL		\$4,055	\$4,461

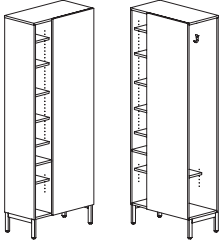

right shown

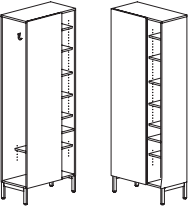

left

Features:

- side entry wardrobe with two installed coat hooks and one lower adjustable shelf
- 8 $\frac{1}{4}$ " w open compartment with five adjustable shelves

Options:

- must specify chassis grain direction on artisan veneer, see pages 13-15 for details

Description	D	W	H	CTN WT	CU FT	① Model	Laminate	Essentials Veneer	Artisan Veneer
69" h Side Access Wardrobe with Open Shelves	15 7/8	36	69	172	27	FLT1636-69LSWR	\$2,664		
	15 7/8	36	69	172	27	FLV1636-69LSWR		\$4,090	\$4,502
	15 7/8	36	69	172	27	FLT1636-69LSWL	\$2,664		
	15 7/8	36	69	172	27	FLV1636-69LSWL		\$4,090	\$4,502
	15 7/8	30	69	147	23	FLT1630-69LSWR	\$2,484		
	15 7/8	30	69	147	23	FLV1630-69LSWR		\$3,783	\$4,162
	15 7/8	30	69	147	23	FLT1630-69LSWL	\$2,484		
	15 7/8	30	69	147	23	FLV1630-69LSWL		\$3,783	\$4,162

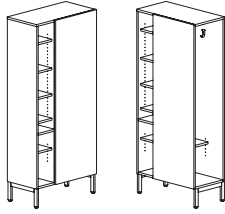

right shown

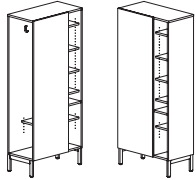

left

Features:

- side entry wardrobe with two installed coat hooks and one lower adjustable shelf
- 8 1/4" w open compartment with four adjustable shelves

Options:

- must specify chassis grain direction on artisan veneer, see pages 13-15 for details

To Order, Specify:

① Laminate Model #	② Laminate Selection		③ Metal Color	④ Other Product Options	
Laminate (FLT)	See Laminate Selection		See Metal Finish Color Options	See list of options for each specific unit; Specify and add accordingly.	
① Veneer Model #	② Wood Collection	③ Wood Finish		④ Metal Color	⑤ Other Product Options
Veneer (FLV)	Essentials	See Essentials Wood Finish Options		See Metal Finish Color Options	See list of options for each specific unit; Specify and add accordingly.
	Artisan	③a Wood Finish See Artisan Wood Finish Options	③b Chassis Grain Direction For Artisan Only: Vertical Horizontal		

FLUX

Description	D	W	H	CTN WT	CU FT	① Model	Laminate	Essentials Veneer	Artisan Veneer
81" h Box/File Lateral, Storage Cabinet	22	36	81	305	44	FLT2236-81L6D	\$4,187		
	22	36	81	305	44	FLV2236-81L6D		\$5,785	\$6,362
	22	30	81	284	37	FLT2230-81L6D	\$3,997		
	22	30	81	284	37	FLV2230-81L6D		\$5,536	\$6,089

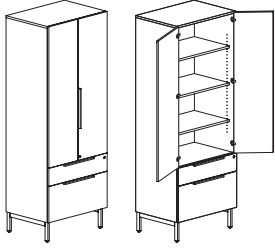

Features:

- aligns with primary height units
- pedestal front locking
- upper compartment has three adjustable shelves

Options:

- must specify chassis grain direction on artisan veneer, see pages 13-15 for details
- veneer door and drawer front in paint available, specify paint color and add \$354; see page 16 for details
- on laminate units, contrasting door and drawer fronts available, no upcharge; specify color, see page 16 for details
- locking door available, specify and add \$147 list
- ledge pulls standard; prism pulls available, specify and see page 9

81" h Box/File Lateral, Open Storage Cabinet	22	36	81	270	44	FLT2236-81L60	\$3,978		
	22	36	81	270	44	FLV2236-81L60		\$5,510	\$6,063
	22	30	81	247	37	FLT2230-81L60	\$3,804		
	22	30	81	247	37	FLV2230-81L60		\$5,279	\$5,807

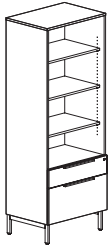

Features:

- aligns with primary height units
- pedestal front locking
- upper compartment has three adjustable shelves

Options:

- must specify chassis grain direction on artisan veneer, see pages 13-15 for details
- veneer drawer fronts in paint available, specify paint color and add \$354 list; see page 16 for details
- on laminate units, contrasting drawer fronts available, no upcharge; specify color, see page 16 for details
- ledge pulls standard; prism pulls available, specify and see page 9

FLUX

Description	D	W	H	CTN WT	CU FT	① Model	Laminate	Essentials Veneer	Artisan Veneer
81" h Lower and Upper Hinge Door Storage Cabinet	22	36	81	265	44	FLT2236-81L8D	\$3,595		
	22	36	81	265	44	FLV2236-81L8D		\$5,155	\$5,672
	22	30	81	248	37	FLT2230-81L8D	\$3,419		
	22	30	81	248	37	FLV2230-81L8D		\$4,930	\$5,422

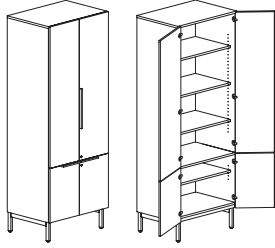

Features:

- aligns with primary height units
- upper compartment has three adjustable shelves, lower compartment has one adjustable shelf

Options:

- must specify chassis grain direction on artisan veneer, see pages 13-15 for details
- veneer door fronts in paint available, specify paint color and add \$354 list; see page 16 for details
- on laminate units, contrasting doors fronts available, no upcharge; specify color, see page 16 for details
- locking doors available, specify and add \$294 list
- ledge pulls standard; prism pulls available, specify and see page 9

81" h Lower Hinge Doors, Open Storage Cabinet	22	36	81	241	44	FLT2236-81L80	\$3,386		
	22	36	81	241	44	FLV2236-81L80		\$4,881	\$5,368
	22	30	81	224	37	FLT2230-81L80	\$3,224		
	22	30	81	224	37	FLV2230-81L80		\$4,671	\$5,141

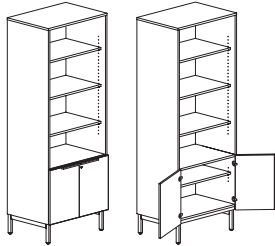

Features:

- aligns with primary height units
- upper compartment has three adjustable shelves, lower compartment has one adjustable shelf

Options:

- must specify chassis grain direction on artisan veneer, see pages 13-15 for details
- veneer door fronts in paint available, specify paint color and add \$354 list; see page 16 for details
- on laminate units, contrasting doors fronts available, no upcharge; specify color, see page 16 for details
- locking door available, specify and add \$147 list
- ledge pulls standard; prism pulls available, specify and see page 9

To Order, Specify:

① Laminate Model #		② Laminate Selection		③ Metal Color	④ Other Product Options
Laminate (FLT)		See Laminate Selection		See Metal Finish Color Options	See list of options for each specific unit; Specify and add accordingly.
① Veneer Model #	② Wood Collection	③ Wood Finish		④ Metal Color	⑤ Other Product Options
Veneer (FLV)	Essentials	See Essentials Wood Finish Options		See Metal Finish Color Options	See list of options for each specific unit; Specify and add accordingly.
	Artisan	③a Wood Finish See Artisan Wood Finish Options	③b Chassis Grain Direction For Artisan Only: Vertical Horizontal		

Description	D	W	H	CTN WT	CU FT	① Model	Laminate	Essentials Veneer	Artisan Veneer
69" h Box/ File Lateral, Storage Cabinet	22	36	69	261	38	FLT2236-69L6D	\$3,877		
	22	36	69	261	38	FLV2236-69L6D		\$5,339	\$5,874
	22	30	69	239	32	FLT2230-69L6D	\$3,713		
	22	30	69	239	32	FLV2230-69L6D		\$5,131	\$5,644

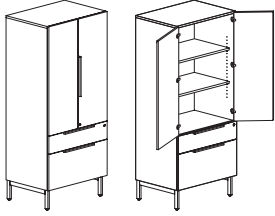

Features:

- aligns with primary height units
- pedestal front locking
- upper compartment has two adjustable shelves

Options:

- must specify chassis grain direction on artisan veneer, see pages 13-15 for details
- veneer door and drawer front in paint available, specify paint color and add \$354; see page 16 for details
- on laminate units, contrasting door and drawer fronts available, no upcharge; specify color, see page 16 for details
- locking door available, specify and add \$147 list
- ledge pulls standard; prism pulls available, specify and see page 9

69" h Box/ File Lateral, Open Storage Cabinet	22	36	69	241	38	FLT2236-69L60	\$3,703		
	22	36	69	241	38	FLV2236-69L60		\$5,118	\$5,630
	22	30	69	219	32	FLT2230-69L60	\$3,552		
	22	30	69	219	32	FLV2230-69L60		\$4,921	\$5,414

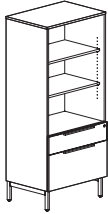

Features:

- aligns with primary height units
- pedestal front locking
- upper compartment has two adjustable shelves

Options:

- must specify chassis grain direction on artisan veneer, see pages 13-15 for details
- veneer drawer fronts in paint available, specify paint color and add \$354 list; see page 16 for details
- on laminate units, contrasting drawer fronts available, no upcharge; specify color, see page 16 for details
- ledge pulls standard; prism pulls available, specify and see page 9

FLUX

Description	D	W	H	CTN WT	CU FT	① Model	Laminate	Essentials Veneer	Artisan Veneer
69" h Lower and Upper Hinge Door Storage Cabinet	22	36	69	240	37	FLT2236-69L8D	\$3,285		
	22	36	69	240	37	FLV2236-69L8D		\$4,709	\$5,179
	22	30	69	223	32	FLT2230-69L8D	\$3,136		
	22	30	69	223	32	FLV2230-69L8D		\$4,527	\$4,977

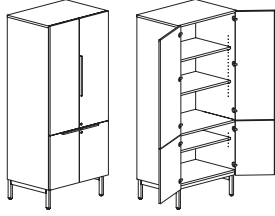

Features:

- aligns with primary height units
- upper compartment has two adjustable shelves, lower compartment has one adjustable shelf

Options:

- must specify chassis grain direction on artisan veneer, see pages 13-15 for details
- veneer door fronts in paint available, specify paint color and add \$354 list; see page 16 for details
- on laminate units, contrasting doors fronts available, no upcharge; specify color, see page 16 for details
- locking doors available, specify and add \$294 list
- ledge pulls standard; prism pulls available, specify and see page 9

69" h Lower Hinge Doors, Open Storage Cabinet	22	36	69	221	38	FLT2236-69L80	\$3,113		
	22	36	69	221	38	FLV2236-69L80		\$4,489	\$4,937
	22	30	69	204	32	FLT2230-69L80	\$2,974		
	22	30	69	204	32	FLV2230-69L80		\$4,316	\$4,749

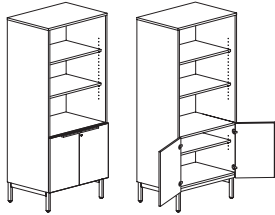

Features:

- aligns with primary height units
- upper compartment has two adjustable shelves, lower compartment has one adjustable shelf

Options:

- must specify chassis grain direction on artisan veneer, see pages 13-15 for details
- veneer door fronts in paint available, specify paint color and add \$354 list; see page 16 for details
- on laminate units, contrasting doors fronts available, no upcharge; specify color, see page 16 for details
- locking door available, specify and add \$147 list
- ledge pulls standard; prism pulls available, specify and see page 9

To Order, Specify:

① Laminate Model #		② Laminate Selection		③ Metal Color	④ Other Product Options
Laminate (FLT)		See Laminate Selection		See Metal Finish Color Options	See list of options for each specific unit; Specify and add accordingly.
① Veneer Model #	② Wood Collection	③ Wood Finish		④ Metal Color	⑤ Other Product Options
Veneer (FLV)	Essentials	See Essentials Wood Finish Options		See Metal Finish Color Options	See list of options for each specific unit; Specify and add accordingly.
	Artisan	Ⓐ Wood Finish See Artisan Wood Finish Options	Ⓑ Chassis Grain Direction For Artisan Only: Vertical Horizontal		

Description	D	W	H	CTN WT	CU FT	① Model	Laminate	Essentials Veneer	Artisan Veneer
81" h Box/File, Storage Cabinet	22	18	81	209	24	FLT2218-81L5DR	\$3,278		
	22	18	81	209	24	FLV2218-81L5DR		\$4,319	\$4,752
	22	18	81	209	24	FLT2218-81L5DL	\$3,278		
	22	18	81	209	24	FLV2218-81L5DL		\$4,319	\$4,752

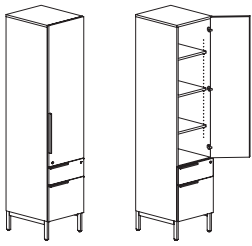

right shown

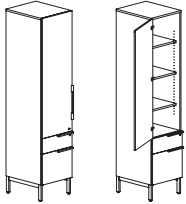

left

Features:

- aligns with primary height units
- pedestal front locking
- upper compartment has three adjustable shelves

Options:

- must specify chassis grain direction on artisan veneer, see pages 13-15 for details
- veneer door and drawer front in paint available, specify paint color and add \$354; see page 16 for details
- on laminate units, contrasting door and drawer fronts available, no upcharge; specify color, see page 16 for details
- locking door available, specify and add \$147 list
- ledge pulls standard; prism pulls available, specify and see page 9
- vanity mirror available, specify and add \$149 list

81" h Box/File, Open Storage Cabinet	22	18	81	182	24	FLT2218-81L50	\$3,163		
	22	18	81	182	24	FLV2218-81L50		\$4,155	\$4,571

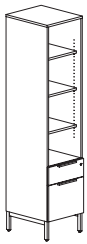

Features:

- aligns with primary height units
- pedestal front locking
- upper compartment has three adjustable shelves

Options:

- must specify chassis grain direction on artisan veneer, see pages 13-15 for details
- veneer drawer fronts in paint available, specify paint color and add \$354 list; see page 16 for details
- on laminate units, contrasting drawer fronts available, no upcharge; specify color, see page 16 for details
- ledge pulls standard; prism pulls available, specify and see page 9

Description	D	W	H	CTN WT	CU FT	① Model	Laminate	Essentials Veneer	Artisan Veneer
81" h Lower and Upper Hinge Door Storage Cabinet	22	18	81	187	24	FLT2218-81L8DR	\$2,720		
	22	18	81	187	24	FLV2218-81L8DR		\$3,728	\$4,100
	22	18	81	187	24	FLT2218-81L8DL	\$2,720		
	22	18	81	187	24	FLV2218-81L8DL		\$3,728	\$4,100

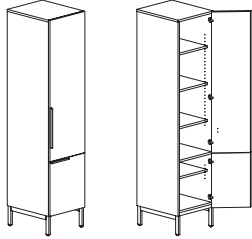

right shown

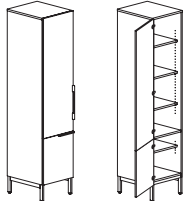

left

Features:

- aligns with primary height units
- upper compartment has two adjustable shelves, lower compartment has one adjustable shelf

Options:

- must specify chassis grain direction on artisan veneer, see pages 13-15 for details
- veneer door fronts in paint available, specify paint color and add \$354 list; see page 16 for details
- on laminate units, contrasting doors fronts available, no upcharge; specify color, see page 16 for details
- locking doors available, specify and add \$294 list
- ledge pulls standard; prism pulls available, specify and see page 9
- vanity mirror available, specify and add \$149 list

81" h Lower Hinge Door, Open Storage Cabinet	22	18	81	165	24	FLT2218-81L8OR	\$2,607		
	22	18	81	165	24	FLV2218-81L8OR		\$3,562	\$3,918
	22	18	81	165	24	FLT2218-81L8OL	\$2,607		
	22	18	81	165	24	FLV2218-81L8OL		\$3,562	\$3,918

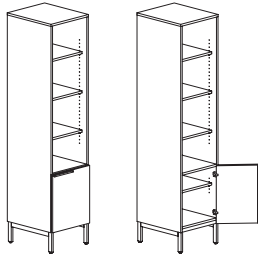

right shown

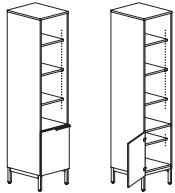

left

Features:

- aligns with primary height units
- upper compartment has three adjustable shelves, lower compartment has one adjustable shelf

Options:

- must specify chassis grain direction on artisan veneer, see pages 13-15 for details
- veneer door front in paint available, specify paint color and add \$354 list; see page 16 for details
- on laminate units, contrasting doors fronts available, no upcharge; specify color, see page 16 for details
- locking door available, specify and add \$147 list
- ledge pulls standard; prism pulls available, specify and see page 9

To Order, Specify:

① Laminate Model #		② Laminate Selection		③ Metal Color	④ Other Product Options
Laminate (FLT)		See Laminate Selection		See Metal Finish Color Options	See list of options for each specific unit; Specify and add accordingly.
① Veneer Model #		② Wood Collection	③ Wood Finish		④ Metal Color
Veneer (FLV)		Essentials	See Essentials Wood Finish Options		See Metal Finish Color Options
		Artisan	③a Wood Finish See Artisan Wood Finish Options	③b Chassis Grain Direction For Artisan Only: Vertical Horizontal	See list of options for each specific unit; Specify and add accordingly.

Description	D	W	H	CTN WT	CU FT	① Model	Laminate	Essentials Veneer	Artisan Veneer
69" h Box/File, Storage Cabinet	22	18	69	181	20	FLT2218-69L5DR	\$3,077		
	22	18	69	181	20	FLV2218-69L5DR		\$4,031	\$4,434
	22	18	69	181	20	FLT2218-69L5DL	\$3,077		
	22	18	69	181	20	FLV2218-69L5DL		\$4,031	\$4,434

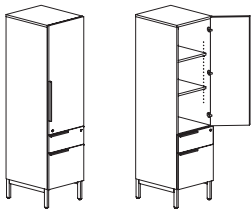

right shown

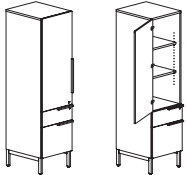

left

Features:

- aligns with primary height units
- pedestal front locking
- upper compartment has two adjustable shelves

Options:

- must specify chassis grain direction on artisan veneer, see pages 13-15 for details
- veneer door and drawer front in paint available, specify paint color and add \$354; see page 16 for details
- on laminate units, contrasting door and drawer fronts available, no upcharge; specify color, see page 16 for details
- locking door available, specify and add \$147 list
- ledge pulls standard; prism pulls available, specify and see page 9
- vanity mirror available, specify and add \$149 list

69" h Box/File, Open Storage Cabinet	22	18	69	160	20	FLT2218-69L50	\$2,984		
	22	18	69	160	20	FLV2218-69L50		\$3,901	\$4,292

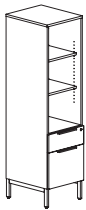

Features:

- aligns with primary height units
- pedestal front locking
- upper compartment has two adjustable shelves

Options:

- must specify chassis grain direction on artisan veneer, see pages 13-15 for details
- veneer drawer fronts in paint available, specify paint color and add \$354 list; see page 16 for details
- on laminate units, contrasting drawer fronts available, no upcharge; specify color, see page 16 for details
- ledge pulls standard; prism pulls available, specify and see page 9

Description	D	W	H	CTN WT	CU FT	① Model	Laminate	Essentials Veneer	Artisan Veneer
69" Lower and Upper Hinge Door Storage Cabinet	22	18	69	161	20	FLT2218-69L8DR	\$2,517		
	22	18	69	161	20	FLV2218-69L8DR		\$3,438	\$3,783
	22	18	69	161	20	FLT2218-69L8DL	\$2,517		
	22	18	69	161	20	FLV2218-69L8DL		\$3,438	\$3,783

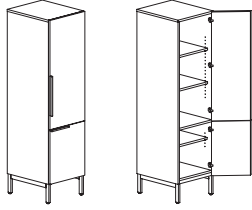

right shown



left

Features:

- aligns with primary height units
- upper compartment has two adjustable shelves, lower compartment has one adjustable shelf

Options:

- must specify chassis grain direction on artisan veneer, see pages 13-15 for details
- veneer door fronts in paint available, specify paint color and add \$354 list; see page 16 for details
- on laminate units, contrasting doors fronts available, no upcharge; specify color, see page 16 for details
- locking doors available, specify and add \$294 list
- ledge pulls standard; prism pulls available, specify and see page 9
- vanity mirror available, specify and add \$149 list

69" Lower Hinge Door, Open Storage Cabinet	22	18	69	144	20	FLT2218-69L8OR	\$2,427		
	22	18	69	144	20	FLV2218-69L8OR		\$3,308	\$3,638
	22	18	69	144	20	FLT2218-69L8OL	\$2,427		
	22	18	69	144	20	FLV2218-69L8OL		\$3,308	\$3,638

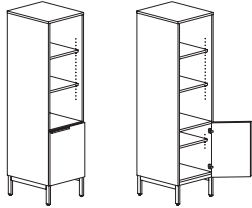

right shown

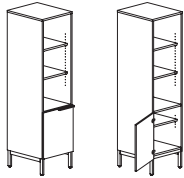

left

Features:

- aligns with primary height units
- upper compartment has two adjustable shelves, lower compartment has one adjustable shelf

Options:

- must specify chassis grain direction on artisan veneer, see pages 13-15 for details
- veneer door front in paint available, specify paint color and add \$354 list; see page 16 for details
- on laminate units, contrasting doors fronts available, no upcharge; specify color, see page 16 for details
- locking door available, specify and add \$147 list
- ledge pulls standard; prism pulls available, specify and see page 9

To Order, Specify:

① Laminate Model #		② Laminate Selection		③ Metal Color	④ Other Product Options
Laminate (FLT)		See Laminate Selection		See Metal Finish Color Options	See list of options for each specific unit; Specify and add accordingly.
① Veneer Model #	② Wood Collection	③ Wood Finish		④ Metal Color	⑤ Other Product Options
Veneer (FLV)	Essentials	See Essentials Wood Finish Options		See Metal Finish Color Options	
	Artisan	ⓐ Wood Finish	ⓑ Chassis Grain Direction		
		See Artisan Wood Finish Options	For Artisan Only: Vertical Horizontal		

Description	D	W	H	CTN WT	CU FT	① Model	Laminate	Essentials Veneer	Artisan Veneer
81" h File Drawer, Storage Cabinet with Side Wardrobe	22	24	81	260	30	FLT2224-81SL5DWR	\$3,888		
	22	24	81	260	30	FLV2224-81SL5DWR		\$5,362	\$5,897
	22	24	81	260	30	FLT2224-81SL5DWL	\$3,888		
	22	24	81	260	30	FLV2224-81SL5DWL		\$5,362	\$5,897

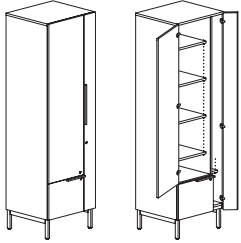

right shown

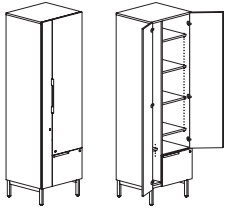

left

Features:

- aligns with secondary height units
- pedestal front locking
- upper compartment has four adjustable shelves
- installed coat hook in wardrobe compartment

Options:

- must specify chassis grain direction on artisan veneer, see pages 13-15 for details
- veneer door and drawer front in paint available, specify paint color and add \$354; see page 16 for details
- on laminate units, contrasting door and drawer fronts available, no upcharge; specify color, see page 16 for details
- locking doors available, specify and add \$294 list
- ledge pulls standard; prism pulls available, specify and see page 9
- vanity mirror available, specify and add \$149 list

81" h File Drawer, Open Storage Cabinet with Side Wardrobe	22	24	81	230	30	FLT2224-81SL50WR	\$3,774		
	22	24	81	230	30	FLV2224-81SL50WR		\$5,198	\$5,718
	22	24	81	230	30	FLT2224-81SL50WL	\$3,774		
	22	24	81	230	30	FLV2224-81SL50WL		\$5,198	\$5,718

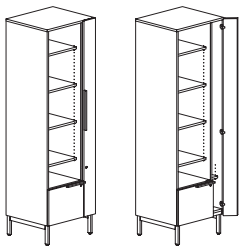

right shown

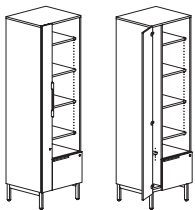

left

Features:

- aligns with secondary height units
- pedestal front locking
- upper compartment has four adjustable shelves
- installed coat hook in wardrobe compartment

Options:

- must specify chassis grain direction on artisan veneer, see pages 13-15 for details
- veneer door and drawer front in paint available, specify paint color and add \$354; see page 16 for details
- on laminate units, contrasting door and drawer fronts available, no upcharge; specify color, see page 16 for details
- locking door available, specify and add \$147 list
- ledge pulls standard; prism pulls available, specify and see page 9

Description	D	W	H	CTN WT	CU FT	① Model	Laminate	Essentials Veneer	Artisan Veneer
81" h Upper and Lower Hinge Door Storage Cabinet with Side Wardrobe	22	24	81	249	30	FLT2224-81SL8DWR	\$3,344		
	22	24	81	246	30	FLV2224-81SL8DWR		\$4,743	\$5,219
	22	24	81	246	30	FLT2224-81SL8DWL	\$3,344		
	22	24	81	246	30	FLV2224-81SL8DWL		\$4,743	\$5,219

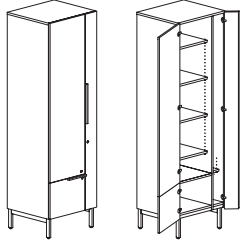

right shown

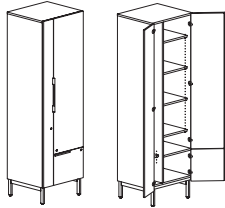

left

Features:

- aligns with secondary height units
- upper compartment has four adjustable shelves
- installed coat hook in wardrobe compartment

Options:

- must specify chassis grain direction on artisan veneer, see pages 13-15 for details
- veneer door fronts in paint available, specify paint color and add \$354 list; see page 16 for details
- on laminate units, contrasting doors fronts available, no upcharge; specify color, see page 16 for details
- locking doors available, specify and add \$294 list
- ledge pulls standard; prism pulls available, specify and see page 9
- vanity mirror available, specify and add \$149 list

81" h Lower Hinge Door, Open Storage Cabinet with Side Wardrobe	22	24	81	217	30	FLT2224-81SL80WR	\$3,232		
	22	24	81	217	30	FLV2224-81SL80WR		\$4,578	\$5,036
	22	24	81	217	30	FLT2224-81SL80WL	\$3,232		
	22	24	81	217	30	FLV2224-81SL80WL		\$4,578	\$5,036

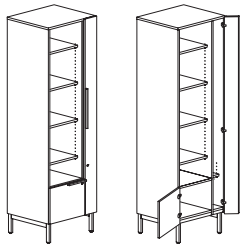

right shown

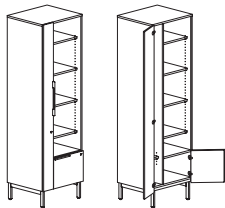

left

Features:

- aligns with secondary height units
- upper compartment has four adjustable shelves
- installed coat hook in wardrobe compartment

Options:

- must specify chassis grain direction on artisan veneer, see pages 13-15 for details
- veneer door fronts in paint available, specify paint color and add \$354 list; see page 16 for detail
- on laminate units, contrasting doors fronts available, no upcharge; specify color, see page 16 for details
- locking doors available, specify and add \$294 list
- ledge pulls standard; prism pulls available, specify and see page 9

To Order, Specify:

① Laminate Model #	② Laminate Type	③ Laminate Selection	④ Metal Color	⑤ Other Product Options
Laminate (FLT)	HPL	See Laminate Selection	See Metal Finish Color Options	See list of options for each specific unit; Specify and add accordingly.

① Veneer Model #	② Wood Collection	③ Wood Finish - Finishes with an asterisk (*) have a coordinating laminate available	④ Metal Color	⑤ Other Product Options		
Veneer (FLV)	Essentials	See Essentials Wood Finish Options	See Metal Finish Color Options	See list of options for each specific unit; Specify and add accordingly.		
	Artisan	<table border="1"> <thead> <tr> <th>③a Wood Finish</th> <th>③b Chassis Grain Direction</th> </tr> </thead> <tbody> <tr> <td>See Artisan Wood Finish Options</td> <td>For Artisan Only: Vertical Horizontal</td> </tr> </tbody> </table>	③a Wood Finish		③b Chassis Grain Direction	See Artisan Wood Finish Options
③a Wood Finish	③b Chassis Grain Direction					
See Artisan Wood Finish Options	For Artisan Only: Vertical Horizontal					

Description	D	W	H	CTN WT	CU FT	① Model	Laminate	Essentials Veneer	Artisan Veneer
69" h File Drawer, Upper Hinge	22	24	69	229	26	FLT2224-69SL5DWR	\$3,686		
Door Storage Cabinet with Side Wardrobe	22	24	69	229	26	FLV2224-69SL5DWR		\$5,074	\$5,580
	22	24	69	229	26	FLT2224-69SL5DWL	\$3,686		
	22	24	69	229	26	FLV2224-69SL5DWL		\$5,074	\$5,580

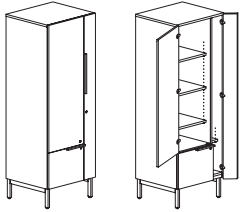

right shown

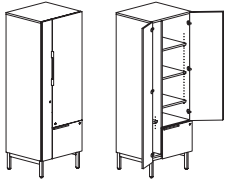

left

Features:

- aligns with secondary height units
- pedestal front locking
- upper compartment has three adjustable shelves
- installed coat hook in wardrobe compartment

Options:

- must specify chassis grain direction on artisan veneer, see pages 13-15 for details
- veneer door and drawer front in paint available, specify paint color and add \$354; see page 16 for details
- on laminate units, contrasting door and drawer fronts available, no upcharge; specify color, see page 16 for details
- locking doors available, specify and add \$294 list
- ledge pulls standard; prism pulls available, specify and see page 9
- vanity mirror available, specify and add \$149 list

69" h File Drawer, Open Storage Cabinet with Side Wardrobe	22	24	69	204	26	FLT2224-69SL50WR	\$3,595		
	22	24	69	204	26	FLV2224-69SL50WR		\$4,942	\$5,437
	22	24	69	204	26	FLT2224-69SL50WL	\$3,595		
	22	24	69	204	26	FLV2224-69SL50WL		\$4,942	\$5,437

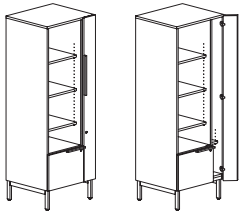

right shown

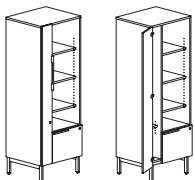

left

Features:

- aligns with secondary height units
- pedestal front locking
- upper compartment has three adjustable shelves
- installed coat hook in wardrobe compartment

Options:

- must specify chassis grain direction on artisan veneer, see pages 13-15 for details
- veneer door and drawer front in paint available, specify paint color and add \$354; see page 16 for details
- on laminate units, contrasting door and drawer fronts available, no upcharge; specify color, see page 16 for details
- locking door available, specify and add \$147 list
- ledge pulls standard; prism pulls available, specify and see page 9

Description	D	W	H	CTN WT	CU FT	① Model	Laminate	Essentials Veneer	Artisan Veneer
69" h Lower and Upper Hinge Door Storage Cabinet with Side Wardrobe	22	24	69	215	26	FLT2224-69SL8DWR	\$3,143		
	22	24	69	215	26	FLV2224-69SL8DWR		\$4,456	\$4,899
	22	24	69	215	26	FLT2224-69SL8DWL	\$3,143		
	22	24	69	215	26	FLV2224-69SL8DWL		\$4,456	\$4,899

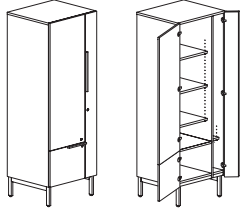

right shown

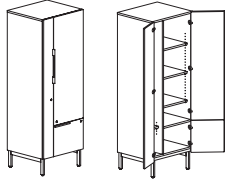

left

Features:

- aligns with secondary height units
- upper compartment has three adjustable shelves
- installed coat hook in wardrobe compartment

Options:

- must specify chassis grain direction on artisan veneer, see pages 13-15 for details
- veneer door fronts in paint available, specify paint color and add \$354 list; see page 16 for detail
- on laminate units, contrasting doors fronts available, no upcharge; specify color, see page 16 for details
- locking doors available, specify and add \$441 list
- ledge pulls standard; prism pulls available, specify and see page 9
- vanity mirror available, specify and add \$149 list

69" h Lower Hinge Door, Open Storage Cabinet with Side Wardrobe	22	24	69	191	26	FLT2224-69SL80WR	\$3,051		
	22	24	69	191	26	FLV2224-69SL80WR		\$4,322	\$4,755
	22	24	69	191	26	FLT2224-69SL80WL	\$3,051		
	22	24	69	191	26	FLV2224-69SL80WL		\$4,322	\$4,755

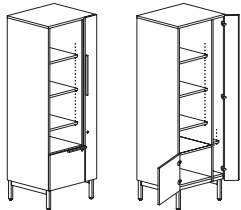

right shown

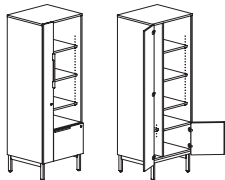

left

Features:

- aligns with secondary height units
- upper compartment has three adjustable shelves
- installed coat hook in wardrobe compartment

Options:

- must specify chassis grain direction on artisan veneer, see pages 13-15 for details
- veneer door fronts in paint available, specify paint color and add \$354 list; see page 16 for detail
- on laminate units, contrasting doors fronts available, no upcharge; specify color, see page 16 for details
- locking doors available, specify and add \$294 list
- ledge pulls standard; prism pulls available, specify and see page 9

To Order, Specify:

① Laminate Model #		② Laminate Selection		③ Metal Color	④ Other Product Options
Laminate (FLT)		See Laminate Selection		See Metal Finish Color Options	See list of options for each specific unit; Specify and add accordingly.
① Veneer Model #	② Wood Collection	③ Wood Finish		④ Metal Color	⑤ Other Product Options
Veneer (FLV)	Essentials	See Essentials Wood Finish Options		See Metal Finish Color Options	See list of options for each specific unit; Specify and add accordingly.
	Artisan	3a Wood Finish See Artisan Wood Finish Options	3b Chassis Grain Direction For Artisan Only: Vertical Horizontal		

Description	D	W	H	CTN WT	CU FT	① Model	Laminate	Essentials Veneer	Artisan Veneer
81" h File Drawer, Storage Cabinet	22	36	81	259	44	FLT2236-81SL6D	\$4,068		
	22	36	81	259	44	FLV2236-81SL6D		\$5,664	\$6,230
	22	30	81	237	37	FLT2230-81SL6D	\$3,877		
	22	30	81	237	37	FLV2230-81SL6D		\$5,415	\$5,957

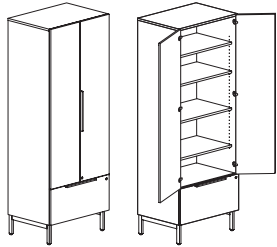

Features:

- aligns with secondary height units
- pedestal front locking
- upper compartment has four adjustable shelves

Options:

- must specify chassis grain direction on artisan veneer, see pages 13-15 for details
- veneer door and drawer front in paint available, specify paint color and add \$354; see page 16 for details
- on laminate units, contrasting door and drawer fronts available, no upcharge; specify color, see page 16 for details
- locking door available, specify and add \$147 list
- ledge pulls standard, mounted vertical; prism pulls available, specify and see page 9

81" h Lateral File Drawer, Open Storage Cabinet	22	36	81	239	44	FLT2236-81SL60	\$3,858		
	22	36	81	239	44	FLV2236-81SL60		\$5,390	\$5,928
	22	30	81	217	37	FLT2230-81SL60	\$3,681		
	22	30	81	217	37	FLV2230-81SL60		\$5,158	\$5,674

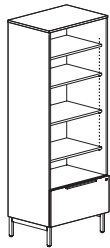

Features:

- aligns with secondary height units
- pedestal front locking
- upper compartment has four adjustable shelves

Options:

- must specify chassis grain direction on artisan veneer, see pages 13-15 for details
- veneer drawer fronts in paint available, specify paint color and add \$354 list; see page 16 for details
- on laminate units, contrasting door front available, no upcharge; specify color, see page 16 for details
- ledge pulls standard; prism pulls available, specify and see page 9

FLUX

Description	D	W	H	CTN WT	CU FT	① Model	Laminate	Essentials Veneer	Artisan Veneer
81" Lower and Upper Hinge Door Storage Cabinet	22	36	81	240	44	FLT2236-81SL8D	\$3,474		
	22	36	81	240	44	FLV2236-81SL8D		\$5,033	\$5,537
	22	30	81	223	37	FLT2230-81SL8D	\$3,296		
	22	30	81	223	37	FLV2230-81SL8D		\$4,808	\$5,288

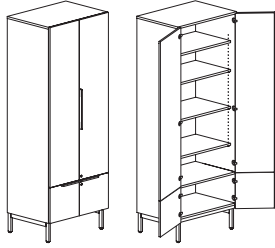

Features:

- aligns with secondary height units
- upper compartment has four adjustable shelves

Options:

- must specify chassis grain direction on artisan veneer, see pages 13-15 for details
- veneer door fronts in paint available, specify paint color and add \$354 list; see page 16 for details
- on laminate units, contrasting doors fronts available, no upcharge; specify color, see page 16 for details
- locking doors available, specify and add \$294 list
- ledge pulls standard; prism pulls available, specify and see page 9

81" Lower Hinge Doors, Open Storage Cabinet	22	36	81	219	44	FLT2236-81SL80	\$3,265		
	22	36	81	219	44	FLV2236-81SL80		\$4,759	\$5,235
	22	30	81	202	37	FLT2230-81SL80	\$3,104		
	22	30	81	202	37	FLV2230-81SL80		\$4,550	\$5,007

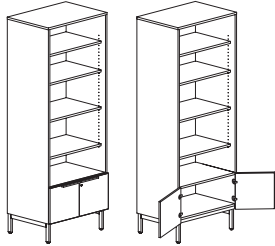

Features:

- aligns with secondary height units
- upper compartment has four adjustable shelves

Options:

- must specify chassis grain direction on artisan veneer, see pages 13-15 for details
- veneer door fronts in paint available, specify paint color and add \$354 list; see page 16 for details
- on laminate units, contrasting doors fronts available, no upcharge; specify color, see page 16 for details
- locking door available, specify and add \$147 list
- ledge pulls standard; prism pulls available, specify and see page 9

To Order, Specify:

① Laminate Model #		② Laminate Selection		③ Metal Color	④ Other Product Options
Laminate (FLT)		See Laminate Selection		See Metal Finish Color Options	See list of options for each specific unit; Specify and add accordingly.
① Veneer Model #	② Wood Collection	③ Wood Finish		④ Metal Color	⑤ Other Product Options
Veneer (FLV)	Essentials	See Essentials Wood Finish Options		See Metal Finish Color Options	See list of options for each specific unit; Specify and add accordingly.
	Artisan	③a Wood Finish See Artisan Wood Finish Options	③b Chassis Grain Direction For Artisan Only: Vertical Horizontal		

Description	D	W	H	CTN WT	CU FT	① Model	Laminate	Essentials Veneer	Artisan Veneer
69" h Lateral File Drawer, Storage Cabinet	22	36	69	259	38	FLT2236-69SL6D	\$3,754		
	22	36	69	259	38	FLV2236-69SL6D		\$5,219	\$5,740
	22	30	69	237	32	FLT2230-69SL6D	\$3,594		
	22	30	69	237	32	FLV2230-69SL6D		\$5,010	\$5,510

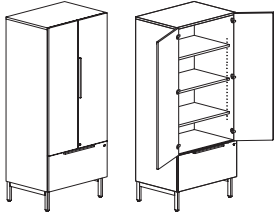

Features:

- aligns with secondary height units
- pedestal front locking
- upper compartment has three adjustable shelves

Options:

- must specify chassis grain direction on artisan veneer, see pages 13-15 for details
- veneer door and drawer front in paint available, specify paint color and add \$354; see page 16 for details
- on laminate units, contrasting door and drawer fronts available, no upcharge; specify color, see page 16 for details
- locking door available, specify and add \$147 list
- ledge pulls standard; prism pulls available, specify and see page 9

69" h Lateral File Drawer, Open Storage Cabinet	22	36	69	239	38	FLT2236-69SL60	\$3,583		
	22	36	69	239	38	FLV2236-69SL60		\$5,000	\$5,495
	22	30	69	217	32	FLT2230-69SL60	\$3,431		
	22	30	69	217	32	FLV2230-69SL60		\$4,801	\$5,281

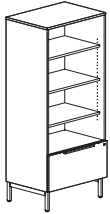

Features:

- aligns with secondary height units
- pedestal front locking
- upper compartment has three adjustable shelves

Options:

- must specify chassis grain direction on artisan veneer, see pages 13-15 for details
- veneer drawer fronts in paint available, specify paint color and add \$354 list; see page 16 for details
- on laminate units, contrasting door front available, no upcharge; specify color, see page 16 for details
- ledge pulls standard; prism pulls available, specify and see page 9

FLUX

Description	D	W	H	CTN WT	CU FT	① Model	Laminate	Essentials Veneer	Artisan Veneer
69" Lower and Upper Hinge Door Storage Cabinet	22	36	69	240	38	FLT2236-69SL8D	\$3,285		
	22	36	69	240	38	FLV2236-69SL8D		\$4,709	\$5,179
	22	30	69	223	32	FLT2230-69SL8D	\$3,136		
	22	30	69	223	32	FLV2230-69SL8D		\$4,527	\$4,977

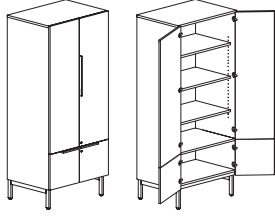

Features:

- aligns with secondary height units
- upper compartment has three adjustable shelves

Options:

- must specify chassis grain direction on artisan veneer, see pages 13-15 for details
- veneer door fronts in paint available, specify paint color and add \$354 list; see page 16 for details
- on laminate units, contrasting doors fronts available, no upcharge; specify color, see page 16 for details
- locking doors available, specify and add \$294 list
- ledge pulls standard; prism pulls available, specify and see page 9

69" Lower Hinge Doors, Open Storage Cabinet	22	36	69	219	38	FLT2236-69SL80	\$3,113		
	22	36	69	219	38	FLV2236-69SL80		\$4,489	\$4,937
	22	30	69	202	32	FLT2230-69SL80	\$2,974		
	22	30	69	202	32	FLV2230-69SL80		\$4,316	\$4,749

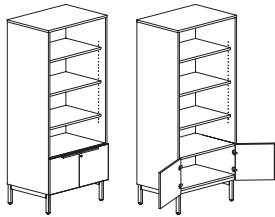

Features:

- aligns with secondary height units
- upper compartment has three adjustable shelves

Options:

- must specify chassis grain direction on artisan veneer, see pages 13-15 for details
- veneer door fronts in paint available, specify paint color and add \$354 list; see page 16 for details
- on laminate units, contrasting doors fronts available, no upcharge; specify color, see page 16 for details
- locking door available, specify and add \$147 list
- ledge pulls standard; prism pulls available, specify and see page 9

To Order, Specify:

① Laminate Model #		② Laminate Selection		③ Metal Color	④ Other Product Options
Laminate (FLT)		See Laminate Selection		See Metal Finish Color Options	See list of options for each specific unit; Specify and add accordingly.
① Veneer Model #	② Wood Collection	③ Wood Finish		④ Metal Color	⑤ Other Product Options
Veneer (FLV)	Essentials	See Essentials Wood Finish Options		See Metal Finish Color Options	See list of options for each specific unit; Specify and add accordingly.
	Artisan	3a Wood Finish See Artisan Wood Finish Options	3b Chassis Grain Direction For Artisan Only: Vertical Horizontal		

Description	D	W	H	CTN WT	CU FT	① Model	Laminate	Essentials Veneer	Artisan Veneer
81" h File Drawer, Storage Cabinet	22	18	81	201	24	FLT2218-81SL5DR	\$3,171		
	22	18	81	201	24	FLV2218-81SL5DR		\$4,214	\$4,636
	22	18	81	201	24	FLT2218-81SL5DL	\$3,171		
	22	18	81	201	24	FLV2218-81SL5DL		\$4,214	\$4,636

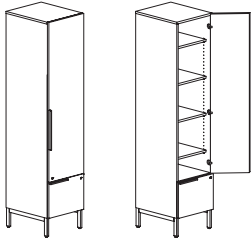

right shown

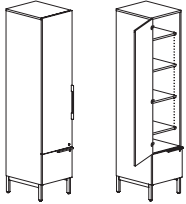

left

Features:

- aligns with secondary height units
- upper compartment has four adjustable shelves

Options:

- must specify chassis grain direction on artisan veneer, see pages 13-15 for details
- veneer door and drawer front in paint available, specify paint color and add \$354; see page 16 for details
- on laminate units, contrasting door and drawer fronts available, no upcharge; specify color, see page 16 for details
- locking door available, specify and add \$147 list
- ledge pulls standard; prism pulls available, specify and see page 9
- vanity mirror available, specify and add \$149 list

81" h File Drawer, Open Storage Cabinet	22	18	81	176	23	FLT2218-81SL50	\$3,057		
	22	18	81	176	23	FLV2218-81SL50		\$4,049	\$4,977

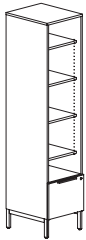

Features:

- aligns with secondary height units
- pedestal front locking
- upper compartment has four adjustable shelves

Options:

- must specify chassis grain direction on artisan veneer, see pages 13-15 for details
- veneer drawer fronts in paint available, specify paint color and add \$354 list; see page 16 for details
- on laminate units, contrasting door front available, no upcharge; specify color, see page 16 for details
- ledge pulls standard; prism pulls available, specify and see page 9

Description	D	W	H	CTN WT	CU FT	① Model	Laminate	Essentials Veneer	Artisan Veneer
81" h Lower and Upper Hinge Door Storage Cabinet	22	18	81	187	24	FLT2218-81SL8DR	\$2,720		
	22	18	81	187	24	FLV2218-81SL8DR		\$3,728	\$4,100
	22	18	81	187	24	FLT2218-81SL8DL	\$2,720		
	22	18	81	187	24	FLV2218-81SL8DL		\$3,728	\$4,100

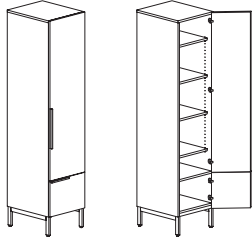

right shown

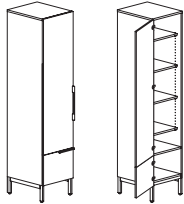

left

Features:

- aligns with secondary height units
- upper compartment has four adjustable shelves

Options:

- must specify chassis grain direction on artisan veneer, see pages 13-15 for details
- veneer door fronts in paint available, specify paint color and add \$354 list; see page 16 for details
- on laminate units, contrasting doors fronts available, no upcharge; specify color, see page 16 for details
- locking doors available, specify and add \$294 list
- ledge pulls standard; prism pulls available, specify and see page 9
- vanity mirror available, specify and add \$149 list

81" h Lower Hinge Door, Open Storage Cabinet	22	18	81	163	24	FLT2218-81SL80R	\$2,607		
	22	18	81	163	24	FLV2218-81SL80R		\$3,562	\$3,918
	22	18	81	163	24	FLT2218-81SL80L	\$2,607		
	22	18	81	163	24	FLV2218-81SL80L		\$3,562	\$3,918

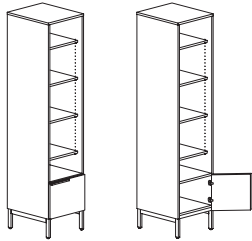

right shown

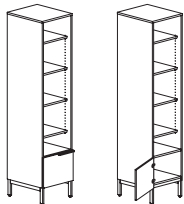

left

Features:

- aligns with secondary height units
- upper compartment has four adjustable shelves

Options:

- must specify chassis grain direction on artisan veneer, see pages 13-15 for details
- veneer door front in paint available, specify paint color and add \$354 list; see page 16 for details
- on laminate units, contrasting doors fronts available, no upcharge; specify color, see page 16 for details
- locking lower door available, specify and add \$147 list
- ledge pulls standard; prism pulls available, specify and see page 9

To Order, Specify:

① Laminate Model #		② Laminate Selection		③ Metal Color	④ Other Product Options
Laminate (FLT)		See Laminate Selection		See Metal Finish Color Options	See list of options for each specific unit; Specify and add accordingly.
① Veneer Model #	② Wood Collection	③ Wood Finish		④ Metal Color	⑤ Other Product Options
Veneer (FLV)	Essentials	See Essentials Wood Finish Options		See Metal Finish Color Options	
	Artisan	ⓐ Wood Finish See Artisan Wood Finish Options	ⓑ Chassis Grain Direction For Artisan Only: Vertical Horizontal		

Description	D	W	H	CTN WT	CU FT	① Model	Laminate	Essentials Veneer	Artisan Veneer
69" h File Drawer, Storage Cabinet	22	18	69	179	20	FLT2218-69SL5DR	\$3,171		
	22	18	69	179	20	FLV2218-69SL5DR		\$4,214	\$4,636
	22	18	69	179	20	FLT2218-69SL5DL	\$3,171		
	22	18	69	179	20	FLV2218-69SL5DL		\$4,214	\$4,636

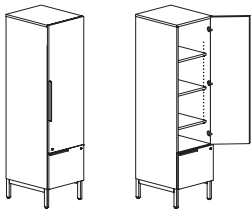

right shown



left

Features:

- aligns with secondary height units
- pedestal front locking
- upper compartment has three adjustable shelves

Options:

- must specify chassis grain direction on artisan veneer, see pages 13-15 for details
- veneer door and drawer front in paint available, specify paint color and add \$354; see page 16 for details
- on laminate units, contrasting door and drawer fronts available, no upcharge; specify color, see page 16 for details
- locking door available, specify and add \$147 list
- ledge pulls standard; prism pulls available, specify and see page 9
- vanity mirror available, specify and add \$149 list

69" h File Drawer, Open Storage Cabinet	22	18	69	154	20	FLT2218-69SL50	\$3,057		
	22	18	69	154	20	FLV2218-69SL50		\$4,049	\$4,457

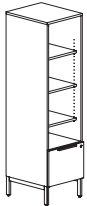

Features:

- aligns with secondary height units
- pedestal front locking
- upper compartment has three adjustable shelves

Options:

- must specify chassis grain direction on artisan veneer, see pages 13-15 for details
- veneer drawer fronts in paint available, specify paint color and add \$354 list; see page 16 for details
- on laminate units, contrasting door front available, no upcharge; specify color, see page 16 for details
- ledge pulls standard; prism pulls available, specify and see page 9

Description	D	W	H	CTN WT	CU FT	① Model	Laminate	Essentials Veneer	Artisan Veneer
69" h Lower and Upper Hinge Door Storage Cabinet	22	18	69	166	20	FLT2218-69SL8DR	\$2,720		
	22	18	69	166	20	FLV2218-69SL8DR		\$3,728	\$4,100
	22	18	69	166	20	FLT2218-69SL8DL	\$2,720		
	22	18	69	166	20	FLV2218-69SL8DL		\$3,728	\$4,100

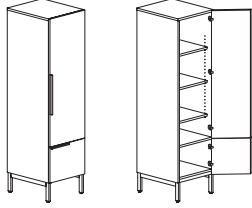

right shown

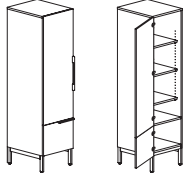

left

Features:

- aligns with secondary height units
- upper compartment has three adjustable shelves, lower compartment has one adjustable shelf

Options:

- must specify chassis grain direction on artisan veneer, see pages 13-15 for details
- veneer door fronts in paint available, specify paint color and add \$354 list; see page 16 for details
- on laminate units, contrasting doors fronts available, no upcharge; specify color, see page 16 for details
- locking doors available, specify and add \$294 list
- ledge pulls standard; prism pulls available, specify and see page 9
- vanity mirror available, specify and add \$149 list

69" h Lower Hinge Door, Open Storage Cabinet	22	18	69	141	20	FLT2218-69SL80R	\$2,607		
	22	18	69	141	20	FLV2218-69SL80R		\$3,562	\$3,918
	22	18	69	141	20	FLT2218-69SL80L	\$2,607		
	22	18	69	141	20	FLV2218-69SL80L		\$3,562	\$3,918

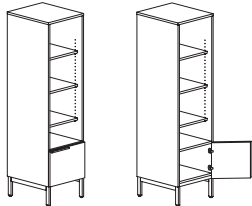

right shown

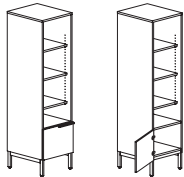

left

Features:

- aligns with secondary height units
- upper compartment has three adjustable shelves, lower compartment has one adjustable shelf

Options:

- must specify chassis grain direction on artisan veneer, see pages 13-15 for details
- veneer drawer fronts in paint available, specify paint color and add \$354 list; see page 16 for details
- on laminate units, contrasting door front available, no upcharge; specify color, see page 16 for details
- locking door available, specify and add \$147 list
- ledge pulls standard; prism pulls available, specify and see page 9

To Order, Specify:

① Laminate Model #		② Laminate Selection		③ Metal Color	④ Other Product Options
Laminate (FLT)		See Laminate Selection		See Metal Finish Color Options	See list of options for each specific unit; Specify and add accordingly.
① Veneer Model #	② Wood Collection	③ Wood Finish		④ Metal Color	⑤ Other Product Options
Veneer (FLV)	Essentials	See Essentials Wood Finish Options		See Metal Finish Color Options	See list of options for each specific unit; Specify and add accordingly.
	Artisan	Ⓐ Wood Finish See Artisan Wood Finish Options	Ⓑ Chassis Grain Direction For Artisan Only: Vertical Horizontal		

Description	D	W	H	CTN WT	CU FT	① Model	Laminate	Essentials Veneer	Artisan Veneer
48" h Pantry Drawer with Filing and Wardrobe, Single User	30	18	48	254	23	FLT3018-48PTAR	\$2,882		
	30	18	48	254	23	FLV3018-48PTAR		\$3,708	\$4,062
	30	18	48	254	23	FLT3018-48PTAL	\$2,882		
	30	18	48	254	23	FLV3018-48PTAL		\$3,708	\$4,062

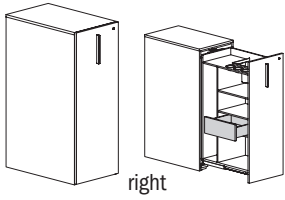

right

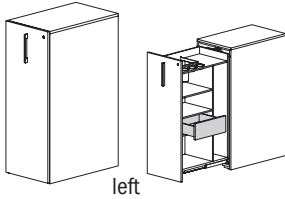

left

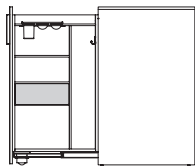

side view

Features:

- filing brackets, accessory trays, fixed shelf, box drawer and wardrobe coat hook
- may not be used with Mid Support bracket to support Bench or Table Surfaces
- drawer extends 26"

Options:

- must specify drawer interior color, Designer White or Slate Grey
- must specify chassis grain direction on artisan veneer, see pages 13-15 for details
- veneer door and drawer fronts available in contrasting paint color, specify paint color and add \$354 list; see pages 16 for details
- laminate door and drawer fronts available in contrasting color, no upcharge, specify color; see pages 16 for details
- ledge pulls standard; prism pulls available, specify and see page 9
- locking door available, specify and add \$147 list
- wire pass-thru grommets available, specify and add \$120 list
- markerboard available on drawer back panel, specify and add \$536 list
- power jumper available; specify and add \$48 list (wire pass-thru grommet option must also be specified)

48" h Pantry Drawer with Paper Sorter and Wardrobe, Single User	30	18	48	234	23	FLT3018-48PTBR	\$2,753		
	30	18	48	234	23	FLV3018-48PTBR		\$3,580	\$3,920
	30	18	48	234	23	FLT3018-48PTBL	\$2,753		
	30	18	48	234	23	FLV3018-48PTBL		\$3,580	\$3,920
	24	18	48	169	18	FLT2418-48PTBR	\$2,679		
	24	18	48	169	18	FLV2418-48PTBR		\$3,482	\$3,779
	24	18	48	169	18	FLT2418-48PTBL	\$2,679		
	24	18	48	169	18	FLV2418-48PTBL		\$3,482	\$3,779

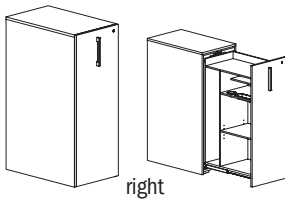

right

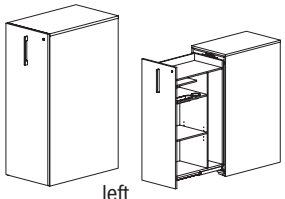

left

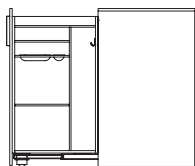

side view

Features:

- paper shelves, accessory trays, fixed shelves and wardrobe coat hook
- may not be used with Mid Support bracket to support Bench or Table Surfaces
- drawer extends 26" on 30"d units, 20" on 24"d units

Options:

- must specify drawer interior color, Designer White or Slate Grey
- must specify chassis grain direction on artisan veneer, see pages 13-15 for details
- veneer door and drawer fronts available in contrasting paint color, specify paint color and add \$354 list; see pages 16 for details
- laminate door and drawer fronts available in contrasting color, no upcharge, specify color; see pages 16 for details
- ledge pulls standard; prism pulls available, specify and see page 9
- locking door available, specify and add \$147 list
- wire pass-thru grommets available, specify and add \$120 list
- markerboard available on drawer back panel, specify and add \$536 list
- power jumper available; specify and add \$48 list (wire pass-thru grommet option must also be specified)

Description	D	W	H	CTN WT	CU FT	① Model	Laminate	Essentials Veneer	Artisan Veneer
48" h Pantry Drawer with Filing, Single User	30	18	48	218	23	FLT3018-48PTCR	\$2,790		
	30	18	48	218	23	FLV3018-48PTCR		\$3,631	\$3,976
	30	18	48	218	23	FLT3018-48PTCL	\$2,790		
	30	18	48	218	23	FLV3018-48PTCL		\$3,631	\$3,976
	24	18	48	192	18	FLT2418-48PTCR	\$2,718		
	24	18	48	192	18	FLV2418-48PTCR		\$3,535	\$3,835
	24	18	48	192	18	FLT2418-48PTCL	\$2,718		
	24	18	48	192	18	FLV2418-48PTCL		\$3,535	\$3,835

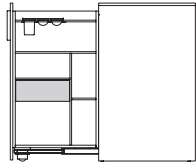
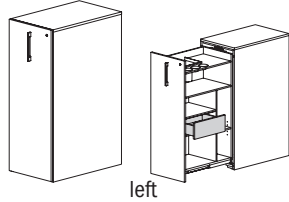
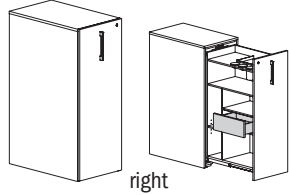

Features:

- filing brackets, accessory trays, fixed shelves and box drawer
- may not be used with Mid Support bracket to support Bench or Table Surfaces
- drawer extends 26" on 30"d units, 20" on 24"d units

Options:

- must specify drawer interior color, Designer White or Slate Grey
- must specify chassis grain direction on artisan veneer, see pages 13-15 for details
- veneer door and drawer fronts available in contrasting paint color, specify paint color and add \$354 list; see page 16 for details
- laminate door and drawer fronts available in contrasting color, no upcharge, specify color; see page 16 for details
- ledge pulls standard; prism pulls available, specify and see page 9
- locking door available, specify and add \$147 list
- wire pass-thru grommets available, specify and add \$120 list
- markerboard available on drawer back panel, specify and add \$536 list
- power jumper available; specify and add \$48 list (wire pass-thru grommet option must also be specified)

To Order, Specify:

① Laminate Model #	② Laminate Selection	③ Metal Color	④ Other Product Options			
Laminate (FLT)	See Laminate Selection	See Metal Finish Color Options	See list of options for each specific unit; Specify and add accordingly.			
① Veneer Model #	② Wood Collection	③ Wood Finish	④ Metal Color	⑤ Other Product Options		
Veneer (FLV)	Essentials	See Essentials Wood Finish Options	See Metal Finish Color Options	See list of options for each specific unit; Specify and add accordingly.		
	Artisan	<table border="1"> <thead> <tr> <th>ⓐ Wood Finish</th> <th>ⓑ Chassis Grain Direction</th> </tr> </thead> <tbody> <tr> <td>See Artisan Wood Finish Options</td> <td>For Artisan Only: Vertical Horizontal</td> </tr> </tbody> </table>	ⓐ Wood Finish		ⓑ Chassis Grain Direction	See Artisan Wood Finish Options
ⓐ Wood Finish	ⓑ Chassis Grain Direction					
See Artisan Wood Finish Options	For Artisan Only: Vertical Horizontal					

Description	D	W	H	CTN WT	CU FT	① Model	Laminate	Essentials Veneer	Artisan Veneer
48" h Pantry Drawer with Paper Sorter, Single User	30	18	48	209	23	FLT3018-48PTDR	\$2,726		
	30	18	48	209	23	FLV3018-48PTDR		\$3,546	\$3,884
	30	18	48	209	23	FLT3018-48PTDL	\$2,726		
	30	18	48	209	23	FLV3018-48PTDL		\$3,546	\$3,884
	24	18	48	163	18	FLT2418-48PTDR	\$2,655		
	24	18	48	163	18	FLV2418-48PTDR		\$3,450	\$3,745
	24	18	48	163	18	FLT2418-48PTDL	\$2,655		
	24	18	48	163	18	FLV2418-48PTDL		\$3,450	\$3,745

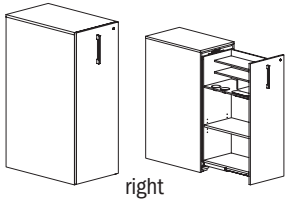

right

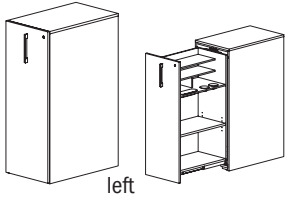

left

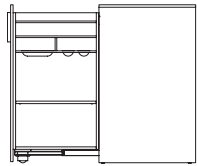

side view

Features:

- paper shelves, accessory trays and fixed shelves
- may not be used with Mid Support bracket to support Bench or Table Surfaces
- drawer extends 26" on 30"d units, 20" on 24"d units

Options:

- must specify drawer interior color, Designer White or Slate Grey
- must specify chassis grain direction on artisan veneer, see pages 13-15 for details
- veneer door and drawer fronts available in contrasting paint color, specify paint color and add \$354 list; see pages 16 for details
- laminate door and drawer fronts available in contrasting color, no upcharge, specify color; see pages 16 for details
- ledge pulls standard; prism pulls available, specify and see page 9
- locking door available, specify and add \$147 list
- wire pass-thru grommets available, specify and add \$120 list
- markerboard available on drawer back panel, specify and add \$536 list
- power jumper available; specify and add \$48 list (wire pass-thru grommet option must also be specified)

48" h Pantry Drawer, Dual User	30	18	48	225	23	FLT3018-48PTE	\$2,922		
	30	18	48	225	23	FLV3018-48PTE		\$3,805	\$4,166
	24	18	48	184	18	FLT2418-48PTE	\$2,846		
	24	18	48	184	18	FLV2418-48PTE		\$3,701	\$4,053

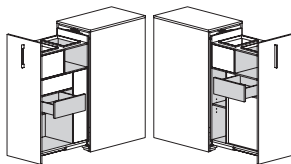
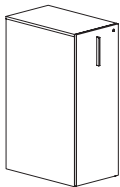

side view

Features:

- filing brackets, fixed shelves and box drawer for each side
- may not be used with Mid Support bracket to support Bench or Table Surfaces
- drawer extends 26" on 30"d units, 20" on 24"d units

Options:

- must specify drawer interior color, Designer White or Slate Grey
- must specify chassis grain direction on artisan veneer, see pages 13-15 for details
- veneer door and drawer fronts available in contrasting paint color, specify paint color and add \$354 list; see pages 16 for details
- laminate door and drawer fronts available in contrasting color, no upcharge, specify color; see pages 16 for details
- ledge pulls standard; prism pulls available, specify and see page 9
- locking door available, specify and add \$147 list
- wire pass-thru grommets available, specify and add \$120 list
- power jumper available; specify and add \$48 list (wire pass-thru grommet option must also be specified)

Description	D	W	H	CTN WT	CU FT	① Model	List Price
Tack Panel	½	28⅞	17½	13	2	FLB30-18B1-FTK	\$193
	½	23⅞	17½	12	2	FLB24-18B1-FTK	\$158

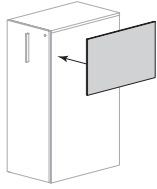

Features:

- mounts to sides of 48”h Storage Cabinets
- sizes coordinate with depth of Storage Cabinets

Options:

- select color, ash grey or silver grey

FLUX

To Order, Specify:

① Laminate Model #	② Laminate Type	③ Laminate Selection	④ Metal Color	⑤ Other Product Options
Laminate (FLT)	HPL	See Laminate Selection	See Metal Finish Color Options	See list of options for each specific unit; Specify and add accordingly.

① Veneer Model #	② Wood Collection	③ Wood Finish - Finishes with an asterisk (*) have a coordinating laminate available	④ Metal Color	⑤ Other Product Options		
Veneer (FLV)	Essentials	See Essentials Wood Finish Options	See Metal Finish Color Options	See list of options for each specific unit; Specify and add accordingly.		
	Artisan	<table border="1"> <thead> <tr> <th>③a Wood Finish</th> <th>③b Chassis Grain Direction</th> </tr> </thead> <tbody> <tr> <td>See Artisan Wood Finish Options</td> <td>For Artisan Only: Vertical Horizontal</td> </tr> </tbody> </table>	③a Wood Finish		③b Chassis Grain Direction	See Artisan Wood Finish Options
③a Wood Finish	③b Chassis Grain Direction					
See Artisan Wood Finish Options	For Artisan Only: Vertical Horizontal					

Description	D	W	H	CTN WT	CU FT	① Model	List Price
42" h Locker - Open Shelves	22	12	42	77	11	FLT2212-42FLK-E	\$1,127
	18	12	42	65	9	FLT1812-42FLK-E	\$1,064

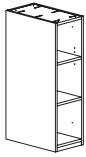

Features:

- must be connected to another locker with a common top, this unit is not freestanding; see pages 450-452 for modular tops
- one adjustable shelf and one fixed shelf (lower)
- unfinished back; modular common top & finished back panels available

42" h Locker - Storage Cabinet	22	12	42	98	11	FLT2212-42FLK-EDR	\$1,335
	22	12	42	98	11	FLT2212-42FLK-EDL	\$1,335
	18	12	42	86	9	FLT1812-42FLK-EDR	\$1,265
	18	12	42	86	9	FLT1812-42FLK-EDL	\$1,265

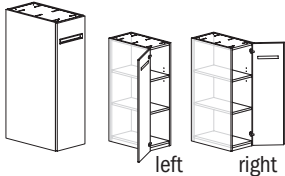

Features:

- must be connected to another locker with a common top, this unit is not freestanding; see pages 450-452 for modular tops
- one adjustable shelf and one fixed shelf (lower)
- unfinished back; modular common top & finished back panels available

Options:

- laminate door fronts available in contrasting color, no upcharge, specify color
- specify pull; see page 10
- locking options available; see page 455 for details and upcharge
- number plate available, order separately; see page 455

42" h Locker - Storage Cabinet with Wardrobe Hooks	22	12	42	96	11	FLT2212-42FLK-BDR	\$1,391
	22	12	42	96	11	FLT2212-42FLK-BDL	\$1,391
	18	12	42	85	9	FLT1812-42FLK-BDR	\$1,321
	18	12	42	85	9	FLT1812-42FLK-BDL	\$1,321

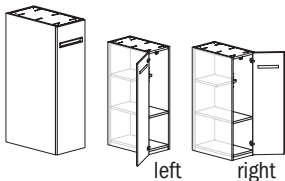

Features:

- must be connected to another locker with a common top, this unit is not freestanding; see pages 450-452 for modular tops
- one full depth fixed shelf, one shallow adjustable shelf and two coat hooks
- unfinished back; modular common top & finished back panels available

Options:

- laminate door fronts available in contrasting color, no upcharge, specify color
- specify pull; see page 10
- locking options available; see page 455 for details and upcharge
- number plate available, order separately; see page 455

42" h Locker - Wardrobe	22	12	42	89	11	FLT2212-42FLK-CDR	\$1,329
	22	12	42	89	11	FLT2212-42FLK-CDL	\$1,329
	18	12	42	79	9	FLT1812-42FLK-CDR	\$1,260
	18	12	42	79	9	FLT1812-42FLK-CDL	\$1,260

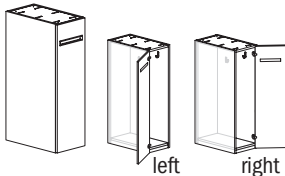

Features:

- must be connected to another locker with a common top, this unit is not freestanding; see pages 450-452 for modular tops
- one wardrobe bar in 22" d units; two coat hooks in 18" d units
- unfinished back; modular common top & finished back panels available

Options:

- laminate door fronts available in contrasting color, no upcharge, specify color
- specify pull; see page 10
- locking options available; see page 455 for details and upcharge
- number plate available, order separately; see page 455

Description	D	W	H	CTN WT	CU FT	① Model	List Price
48" h Locker - Open Shelves	22	12	48	84	13	FLT2212-48FLK-E	\$1,180
	18	12	48	65	11	FLT1812-48FLK-E	\$1,116

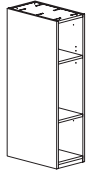

Features:

- must be connected to another locker with a common top, this unit is not freestanding; see pages 450-452 for modular tops
- one adjustable shelf and one fixed shelf (lower)
- unfinished back; modular common top & finished back panels available

48" h Locker - Storage Cabinet	22	12	48	107	13	FLT2212-48FLK-EDR	\$1,397
	22	12	48	107	13	FLT2212-48FLK-EDL	\$1,397
	18	12	48	86	11	FLT1812-48FLK-EDR	\$1,323
	18	12	48	86	11	FLT1812-48FLK-EDL	\$1,323

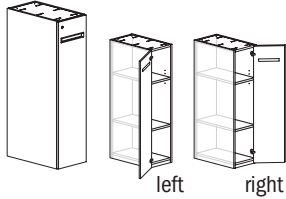

Features:

- must be connected to another locker with a common top, this unit is not freestanding; see pages 450-452 for modular tops
- one adjustable shelf and one fixed shelf (lower)
- unfinished back; modular common top & finished back panels available

Options:

- laminate door fronts available in contrasting color, no upcharge, specify color
- specify pull; see page 10
- locking options available; see page 455 for details and upcharge
- number plate available, order separately; see page 455

48" h Locker - Storage Cabinet with Wardrobe Hooks	22	12	48	106	13	FLT2212-48FLK-BDR	\$1,452
	22	12	48	106	13	FLT2212-48FLK-BDL	\$1,452
	18	12	48	94	11	FLT1812-48FLK-BDR	\$1,380
	18	12	48	94	11	FLT1812-48FLK-BDL	\$1,380

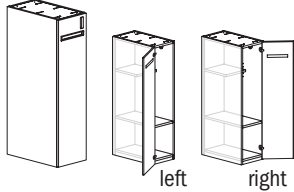

Features:

- must be connected to another locker with a common top, this unit is not freestanding; see pages 450-452 for modular tops
- one full depth fixed shelf, one shallow adjustable shelf and two coat hooks
- unfinished back; modular common top & finished back panels available

Options:

- laminate door fronts available in contrasting color, no upcharge, specify color
- specify pull; see page 10
- locking options available; see page 455 for details and upcharge
- number plate available, order separately; see page 455

To Order, Specify:

① Laminate Model #	② Laminate Type	③ Laminate Selection	④ Metal Color	⑤ Other Product Options
Laminate (FLT)	HPL	See Laminate Selection	See Metal Finish Color Options	See list of options for each specific unit; Specify and add accordingly.

Description	D	W	H	CTN WT	CU FT	① Model	List Price
48" h Locker - Wardrobe	22	12	48	99	13	FLT2212-48FLK-CDR	\$1,393
	22	12	48	99	13	FLT2212-48FLK-CDL	\$1,393
	18	12	48	88	11	FLT1812-48FLK-CDR	\$1,321
	18	12	48	88	11	FLT1812-48FLK-CDL	\$1,321

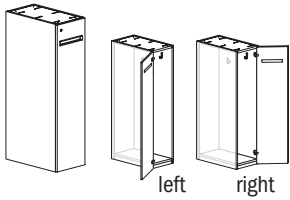

Features:

- must be connected to another locker with a common top, this unit is not freestanding; see pages 450-452 for modular tops
- one wardrobe bar in 22" d units; two coat hooks in 18" d units
- unfinished back; modular common top & finished back panels available

Options:

- laminate door fronts available in contrasting color, no upcharge, specify color
- specify pull; see page 10
- locking options available; see page 455 for details and upcharge
- number plate available, order separately; see page 455

69" h Locker - Open Shelves	22	12	69	116	13	FLT2212-69FLK-F	\$1,320
	18	12	69	98	11	FLT1812-69FLK-F	\$1,248

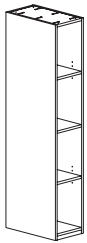

Features:

- must be connected to another locker with a common top, this unit is not freestanding; see pages 450-452 for modular tops
- two adjustable shelves and one fixed shelf (center)
- unfinished back; modular common top & finished back panels available

69" h Locker - Storage Cabinet	22	12	69	150	18	FLT2212-69FLK-FDR	\$1,565
	22	12	69	150	18	FLT2212-69FLK-FDL	\$1,565
	18	12	69	133	15	FLT1812-69FLK-FDR	\$1,483
	18	12	69	133	15	FLT1812-69FLK-FDL	\$1,483

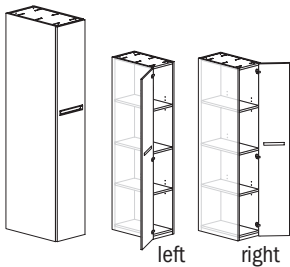

Features:

- must be connected to another locker with a common top, this unit is not freestanding; see pages 450-452 for modular tops
- two adjustable shelves and one fixed shelf (center)
- unfinished back; modular common top & finished back panels available

Options:

- laminate door fronts available in contrasting color, no upcharge, specify color
- specify pull; see page 10
- locking options available; see page 455 for details and upcharge
- number plate available, order separately; see page 455

69" h Locker - Storage Cabinet with Wardrobe Hooks	22	12	69	146	18	FLT2212-69FLK-GDR	\$1,626
	22	12	69	146	18	FLT2212-69FLK-GDL	\$1,626
	18	12	69	130	15	FLT1812-69FLK-GDR	\$1,546
	18	12	69	130	15	FLT1812-69FLK-GDL	\$1,546

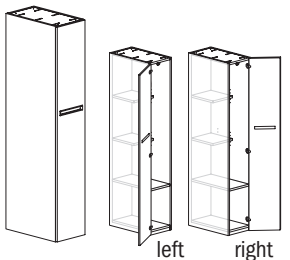

Features:

- must be connected to another locker with a common top, this unit is not freestanding; see pages 450-452 for modular tops
- one full depth fixed shelf, two shallow adjustable shelves and two coat hooks
- unfinished back; modular common top & finished back panels available

Options:

- laminate door fronts available in contrasting color, no upcharge, specify color
- specify pull; see page 452
- locking options available; see page 452 for details and upcharge
- number plate available, order separately; see page 455

Description	D	W	H	CTN WT	CU FT	① Model	List Price
69" h Locker - Wardrobe	22	12	69	141	18	FLT2212-69FLK-HDR	\$1,586
	22	12	69	141	18	FLT2212-69FLK-HDL	\$1,586
	18	12	69	125	15	FLT1812-69FLK-HDR	\$1,505
	18	12	69	125	15	FLT1812-69FLK-HDL	\$1,505

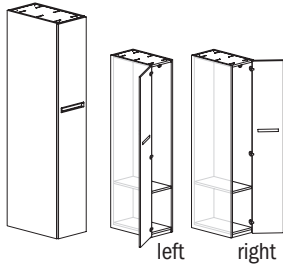

Features:

- must be connected to another locker with a common top, this unit is not freestanding; see pages 450-452 for modular tops
- one full depth fixed shelf and one wardrobe bar in 22" d units; two coat hooks in 18" d units
- unfinished back; modular common top & finished back panels available

Options:

- laminate door fronts available in contrasting color, no upcharge, specify color
- specify pull; see page 10
- locking options available; see page 455 for details and upcharge
- number plate available, order separately; see page 455

69" h Dual Locker - Storage Cabinet	22	12	69	151	18	FLT2212-69FLK-F2DR	\$1,608
	22	12	69	151	18	FLT2212-69FLK-F2DL	\$1,608
	18	12	69	133	15	FLT1812-69FLK-F2DR	\$1,525
	18	12	69	133	15	FLT1812-69FLK-F2DL	\$1,525

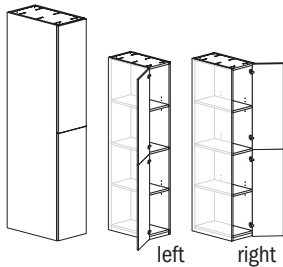

Features:

- must be connected to another locker with a common top, this unit is not freestanding; see pages 450-452 for modular tops
- one adjustable shelf per compartment
- unfinished back; modular common top & finished back panels available

Options:

- laminate door fronts available in contrasting color, no upcharge, specify color
- specify pull; see page 10
- locking options available; see page 455 for details and upcharge
- number plate available, order separately; see page 455

69" h Triple Locker - Storage Cabinet	22	12	69	160	18	FLT2212-69FLK-J3DR	\$1,648
	22	12	69	160	18	FLT2212-69FLK-J3DL	\$1,648
	18	12	69	140	15	FLT1812-69FLK-J3DR	\$1,567
	18	12	69	140	15	FLT1812-69FLK-J3DL	\$1,567

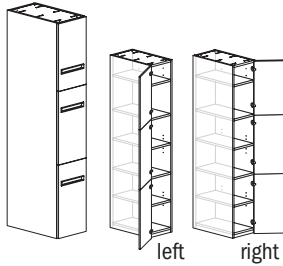

Features:

- must be connected to another locker with a common top, this unit is not freestanding; see pages 450-452 for modular tops
- one adjustable shelf per compartment
- unfinished back; modular common top & finished back panels available

Options:

- laminate door fronts available in contrasting color, no upcharge, specify color
- specify pull; see page 10
- locking options available; see page 455 for details and upcharge
- number plate available, order separately; see page 455

To Order, Specify:

① Laminate Model #	② Laminate Type	③ Laminate Selection	④ Metal Color	⑤ Other Product Options
Laminate (FLT)	HPL	See Laminate Selection	See Metal Finish Color Options	See list of options for each specific unit; Specify and add accordingly.

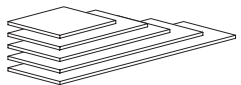
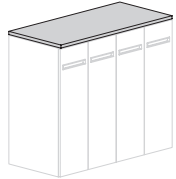
Description	D	W	H	CTN WT	CU FT	① Model	List Price
Modular Top - Single Depth Locker   in application	22	96 1/8	1 3/16	78	5	FLT2296LKMT	\$803
	22	84 1/8	1 3/16	69	5	FLT2284LKMT	\$704
	22	72 1/8	1 3/16	60	4	FLT2272LKMT	\$603
	22	60 1/8	1 3/16	50	4	FLT2260LKMT	\$503
	22	48 1/8	1 3/16	42	3	FLT2248LKMT	\$405
	22	36 1/8	1 3/16	33	2	FLT2236LKMT	\$304
	22	24 1/8	1 3/16	24	2	FLT2224LKMT	\$238
	18	96 1/8	1 3/16	65	5	FLT1896LKMT	\$788
	18	84 1/8	1 3/16	56	4	FLT1884LKMT	\$688
	18	72 1/8	1 3/16	50	4	FLT1872LKMT	\$591
	18	60 1/8	1 3/16	44	3	FLT1860LKMT	\$493
	18	48 1/8	1 3/16	35	3	FLT1848LKMT	\$396
	18	36 1/8	1 3/16	28	2	FLT1836LKMT	\$297
	18	24 1/8	1 3/16	20	2	FLT1824LKMT	\$233

Features:

- use with modular Locker Storage Cabinets
- eased edge profile user side

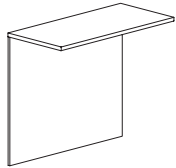
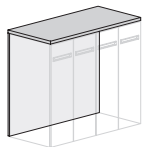
42" h Modular Top & Common Back - Single Depth Locker   in application	22 3/4	60 1/8	42	105	44	FLT2360-42LKMTB	\$1,199
	22 3/4	48 1/8	42	85	36	FLT2348-42LKMTB	\$960
	22 3/4	36 1/8	42	65	28	FLT2336-42LKMTB	\$722
	22 3/4	24 1/8	42	45	20	FLT2324-42LKMTB	\$564
	18 3/4	60 1/8	42	97	38	FLT1960-42LKMTB	\$1,189
	18 3/4	48 1/8	42	85	31	FLT1948-42LKMTB	\$953
	18 3/4	36 1/8	42	60	24	FLT1936-42LKMTB	\$716
	18 3/4	24 1/8	42	42	17	FLT1924-42LKMTB	\$560

Features:

- use with modular Locker Storage Cabinets to create a finished back
- eased edge profile user side

Description	D	W	H	CTN WT	CU FT	① Model	List Price
48" h Modular Top & Common Back - Single Depth Locker	22 3/4	60 1/8	48	113	50	FLT2360-48LKMTB	\$1,298
	22 3/4	48 1/8	48	91	41	FLT2348-48LKMTB	\$1,041
	22 3/4	36 1/8	48	69	32	FLT2336-48LKMTB	\$783
	22 3/4	24 1/8	48	49	23	FLT2324-48LKMTB	\$612
	18 3/4	60 1/8	48	104	43	FLT1960-48LKMTB	\$1,290
	18 3/4	48 1/8	48	85	35	FLT1948-48LKMTB	\$1,031
	18 3/4	36 1/8	48	65	27	FLT1936-48LKMTB	\$775
	18 3/4	24 1/8	48	45	19	FLT1924-48LKMTB	\$607

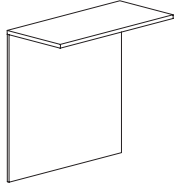

in application

Features:

- use with modular Locker Storage Cabinets to create a finished back
- eased edge profile user side

Description	D	W	H	CTN WT	CU FT	① Model	List Price
69" h Modular Top & Common Back - Single Depth Locker	22 3/4	60 1/8	69	140	71	FLT2360-69LKMTB	\$1,645
	22 3/4	48 1/8	69	113	58	FLT2348-69LKMTB	\$1,318
	22 3/4	36 1/8	69	80	45	FLT2336-69LKMTB	\$993
	22 3/4	24 1/8	69	59	31	FLT2324-69LKMTB	\$774
	18 3/4	60 1/8	69	132	60	FLT1960-69LKMTB	\$1,638
	18 3/4	48 1/8	69	107	49	FLT1948-69LKMTB	\$1,311
	18 3/4	36 1/8	69	80	38	FLT1936-69LKMTB	\$983
	18 3/4	24 1/8	69	56	27	FLT1924-69LKMTB	\$770

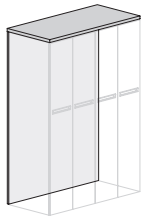
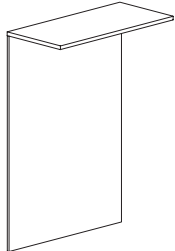

Features:

- use with modular Locker Storage Cabinets to create a finished back
- eased edge profile user side

To Order, Specify:

① Laminate Model #	② Laminate Type	③ Laminate Selection	④ Metal Color	⑤ Other Product Options
Laminate (FLT)	HPL	See Laminate Selection	See Metal Finish Color Options	See list of options for each specific unit; Specify and add accordingly.

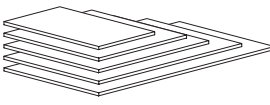
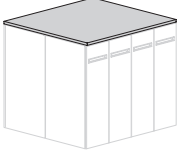
Description	D	W	H	CTN WT	CU FT	① Model	List Price	
Modular Top - Back to Back Lockers 	44	96 1/8	1 3/16	150	9	FLT4496LKMT	\$1,591	
	44	84 1/8	1 3/16	133	8	FLT4484LKMT	\$1,395	
	44	72 1/8	1 3/16	114	7	FLT4472LKMT	\$1,199	
	44	60 1/8	1 3/16	96	6	FLT4460LKMT	\$993	
	44	48 1/8	1 3/16	78	5	FLT4448LKMT	\$705	
	44	36 1/8	1 3/16	60	4	FLT4436LKMT	\$605	
	44	24 1/8	1 3/16	42	3	FLT4424LKMT	\$363	
	 in application	36	96 1/8	1 3/16	124	8	FLT3696LKMT	\$1,308
		36	84 1/8	1 3/16	109	7	FLT3684LKMT	\$1,147
		36	72 1/8	1 3/16	95	6	FLT3672LKMT	\$983
36		61 1/8	1 3/16	80	5	FLT3660LKMT	\$822	
36		48 1/8	1 3/16	65	4	FLT3648LKMT	\$663	
36		36 1/8	1 3/16	35	3	FLT3636LKMT	\$511	
36		24 1/8	1 3/16	35	3	FLT3624LKMT	\$311	

Features:

- use with modular Locker Storage Cabinets to span back-to-back units
- eased edge profile user side

Description	D	W	H	CTN WT	CU FT	① Model	List Price
Locker Number Plate	1/8	1	1	1	1	FLB-NUMPLT	\$39

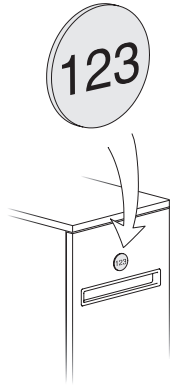

Features:

- helvetica font, 1-3 character

Options:

- select silver with black numerals or black with silver numerals

Lock & Key				1	1	FLB-LOCKCORE-A	\$32
------------	--	--	--	---	---	----------------	------

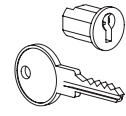

Features:

- key #'s start at 100

Options:

- select key #'s
- select Silver or Black

Digital Lock Master Key				1	1	FLB-MASTKEY-B	\$103
-------------------------	--	--	--	---	---	---------------	-------

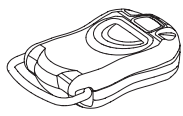

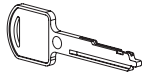

Keyless Radial Lock Master Key				1	1	FLB-MASTKEY-C	\$103
--------------------------------	--	--	--	---	---	---------------	-------



To Order, Specify:

① Laminate Model #	② Laminate Type	③ Laminate Selection	④ Metal Color	⑤ Other Product Options
Laminate (FLT)	HPL	See Laminate Selection	See Metal Finish Color Options	See list of options for each specific unit; Specify and add accordingly.

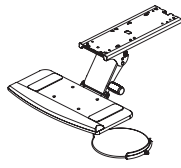
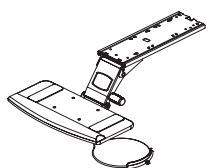
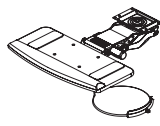
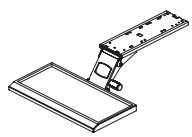
FLUX

Description	D	W	H	CTN WT	CU FT	① Model	List Price
 <p>Articulating Keyboard Tray</p> <ul style="list-style-type: none"> · articulating keyboard tray - black color · mouse tray included · 16" glide track · easy one-handed adjustment; vertical range of motion of 5.1" below glide track · tray tilt range +10 degree to -20 degree · unit swivels side-to-side · tray size is 19.4" wide x 9.4" deep · tray includes palm rest · tray is made with recyclable high density polyethylene 	13	24	7	14	2	AK2	\$536
 <p>Articulating Keyboard Tray</p> <ul style="list-style-type: none"> · articulating keyboard tray - black color · mouse tray included · 17" glide track · easy one-handed adjustment; vertical range of motion of 8.9"; (6.5" below the glide track and an additional 2.38" above) · tray tilt range +10 degree to -20 degree · unit swivels side-to-side · tray size is 19.4" wide x 9.4" deep · tray includes palm rest · tray is made with recyclable high density polyethylene 	13	24	7	12	2	AK3	\$567
 <p>Articulating Keyboard Tray</p> <ul style="list-style-type: none"> · articulating keyboard tray - wood finish tray with black mechanism · mouse tray included · use when depth under work surface for mounting is limited; minimum of 9.38" depth recommended · easy one-handed adjustment; vertical range of motion of 5.73 · tray tilt range +10 degree to -20 degree · unit swivels side-to-side · tray size is 21.75" wide x 11" deep · wood tray requires finish selection; see component finishes for the selection 	11	23	3	11	2	AK5	\$552
 <p>Articulating Keyboard Tray</p> <ul style="list-style-type: none"> · trackless articulating keyboard tray - black color · mouse tray included · use when depth under work surface for mounting is limited; minimum of 9.38" depth recommended · easy one-handed adjustment; vertical range of motion of 5.73 · tray tilt range +10 degree to -15 degree · unit swivels side-to-side · tray size is 19.4" wide x 9.4" deep · tray includes palm rest · tray is made with recyclable high density polyethylene 	14	23	7	15	2	AK4	\$598
 <p>Keyboard Tray Mouse Pad</p> <ul style="list-style-type: none"> · adjusts for user comfort · 8" x 8" · for left or right hand operation · compatible with AK4 Keyboard Drawer only 	8	8	1/4	2		MT4	\$201

FLUX

Description	D	W	H	CTN WT	CU FT	① Model	List Price
-------------	---	---	---	-----------	----------	---------	------------

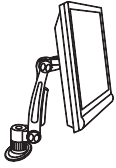
 <ul style="list-style-type: none"> • 360 degree swivel • adjusts height, tilt and distance of monitor screen to user • integrated cable management • grommet and edge clamp mount included • black finish • monitor not included • will fit monitors made to the VESA standard of 75 mm or 100 mm hole spacing in a square configuration 	12	6	17	9		AMA3B	\$666
---	----	---	----	---	--	-------	-------

 <ul style="list-style-type: none"> • mounts to edge of worksurface • silver or black 				9	1	GP5901MA	\$709
--	--	--	--	---	---	----------	-------

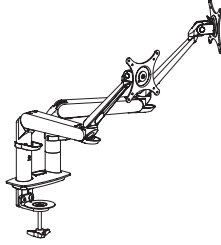
 <ul style="list-style-type: none"> • mounts to edge of worksurface • supports two monitors • silver or black 				18	2	GP5902MA	\$1,277
--	--	--	--	----	---	----------	---------

 <ul style="list-style-type: none"> • mounts through hole in worksurface • field drilled and field installed • supports up to 12 lbs and/or 27" monitor • silver or black 				9	1	GP5905MA	\$791
--	--	--	--	---	---	----------	-------

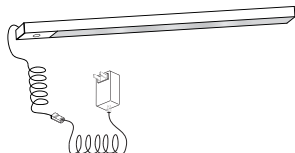
 <ul style="list-style-type: none"> • low profile LED tasklight • toggle on and off switch • 4000K cool white • 13ft cord • dimmable • includes attaching brackets, adhesive tape and wire manager • recommended tasklight length for each cabinet size; see chart on page 33 	1/2	60	3/4	3	1	TL60LEDF	\$348
	1/2	45	3/4	3	1	TL45LEDF	\$299
	1/2	39	3/4	3	1	TL39LEDF	\$265
	1/2	27	3/4	3	1	TL27LEDF	\$231

To Order, Specify:

① Model Number	
----------------	--

FLUX

Description	D	W	H	CTN WT	CU FT	① Model	List Price
Wide Pencil Drawer	19 1/4	22	1 7/8	5	1	GP2219CD	\$129

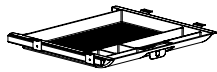

· plastic

Pencil Drawer	19 1/4	16 1/8	2 3/8	4	1	GP1619CD	\$119
---------------	--------	--------	-------	---	---	----------	-------



· plastic

Center Nook Drawer	8 1/4	15 1/4	2	2	1	GP1509CD	\$114
--------------------	-------	--------	---	---	---	----------	-------

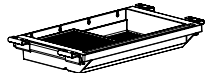

· plastic

Worksurface Power	2 5/8	6 3/8	3	3	1	EC26	\$532
-------------------	-------	-------	---	---	---	------	-------

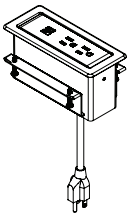

- two power receptacles - 120 volt; 15 amp dual powered USB
- 120" power cord with molded plug
- White (W) or Black (B) finish available, specify when ordering
- UL recognized
- meets UL spill requirements

Edge Mount Power	3 1/2	5 1/2	7 1/2	3	1	EC28	\$427
------------------	-------	-------	-------	---	---	------	-------

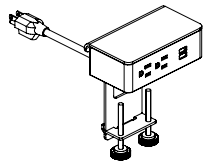

- two power receptacles - 120 volt; 15 amp dual powered USB
- 120" power cord with molded plug
- White (W) or Black (B) finish available, specify when ordering
- UL recognized

FLUX

Description	D	W	H	CTN WT	CU FT	① Model	List Price
Wireless Charging Unit	3½	3½	1	3	1	EC33	\$348

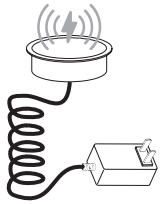

- wireless charging for use with Q enabled devices
- 72" power cord
- black
- UL Listed
- CE / FCC certified

Under Surface Convenience Power Unit	3½	7½	2½	3	1	EC34	\$303
--------------------------------------	----	----	----	---	---	------	-------

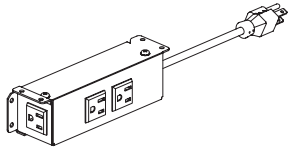

- three outlets
- 120" power cord
- black
- ETL Listed for US

FLUX

To Order, Specify:

① Model Number	
----------------	--

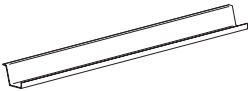
Description	D	W	H	CTN WT	CU FT	① Model	List Price
Metal Wire Manager 	3 3/16	80	2 13/16	10	6	FLB0480MWM	\$574
	3 3/16	74	2 13/16	9	6	FLB0474MWM	\$562
	3 3/16	68	2 13/16	9	5	FLB0468MWM	\$513
	3 3/16	62	2 13/16	8	4	FLB0462MWM	\$498
	3 3/16	56	2 13/16	7	4	FLB0456MWM	\$472
	3 3/16	50	2 13/16	7	4	FLB0450MWM	\$417
	3 3/16	44	2 13/16	6	4	FLB0444MWM	\$396
	3 3/16	38	2 13/16	5	3	FLB0438MWM	\$388
	3 3/16	32	2 13/16	4	2	FLB0432MWM	\$381

- to be used with peninsula and runoff desks; see chart on pages 50-51 for appropriate size to be used
- 3 gauge steel mounting plate

Flexible Wire Manager - Surface to Surface 	1	2	30	4	1	GP230VWM	\$202
---	---	---	----	---	---	----------	-------

- 30" flexible vertical wire manager with one vertical mounting bracket and one magnetic attachment bracket
- black with silver accents

Flexible Wire Manager - Surface to Surface 	1	2	40	4	1	GP240VWM	\$260
---	---	---	----	---	---	----------	-------

- 40" flexible vertical wire manager with one vertical mounting bracket and one magnetic attachment bracket
- black with silver accents

Flexible Wire Manager - Surface to Floor 	1	2	50	12	1	GP250VWM	\$312
---	---	---	----	----	---	----------	-------

- 50" flexible vertical wire manager with one vertical mounting bracket and one counter weight base
- black with silver accents

FLUX

Description	D	W	H	CTN WT	CU FT	❶ Model	List Price
Portable Slide on Screen	1	24	21 ½	10	2	GPB2422PDP	\$856

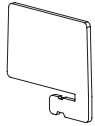

- works with any surface material
- works in any location, with the exception of where tilt release paddle is located on tilting tables
- specify Ash Grey (ASH) or Silver Grey (SIL)

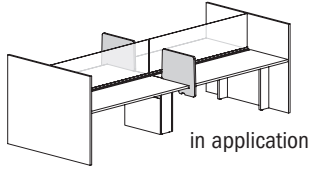

FLUX

To Order, Specify:

❶ Model Number	
-----------------------	--