

pricelist

effective July 1, 2024

LOK

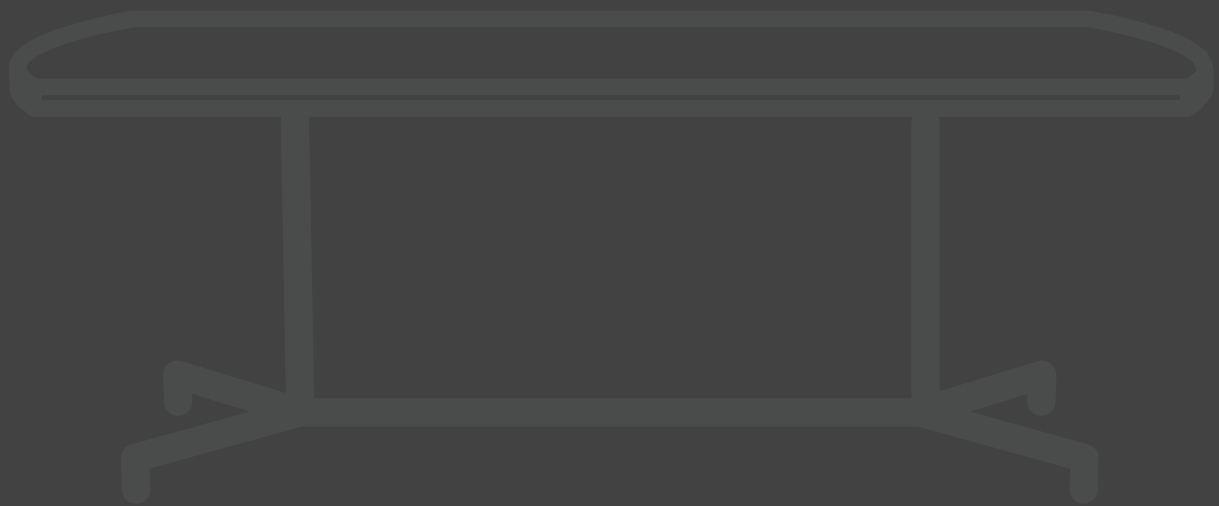

JSI Price Lists

Tables + Casegoods

[Bourne Tables](#)
[Brogan](#)
[Copilot](#)
[Finale](#)
[Lincoln](#)
[Native](#)
[Nosh](#)
[Privacy Program](#)
[Prost](#)
[Reef](#)
[Romy](#)
[Traditional](#)
[Trail](#)
[Walden](#)
[Wellington](#)
[Accessories](#)

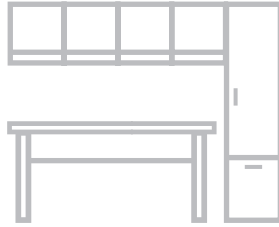

Lok

[Training Tables](#)
[Teamwork Tables](#)
[Conference Tables](#)
[Occasional Tables](#)

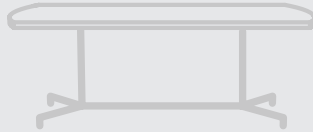

Flux

[Private Office](#)

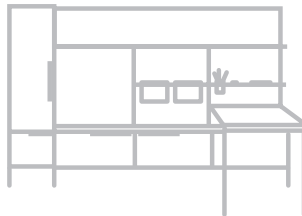

Healthcare

[Seating](#)
[Kindera](#)
[Satisse](#)
[Somna](#)

[Casework](#)
[Forge](#)



Vision

[Casegoods](#)
[Tables](#)



Seating

Addison	Kyla
Americana	Mackey
Ansen	Madison
Arwyn	Millie
Avini	Moto
BeSpace	Newton
Boston	Oxley
Bourne Seating	Pillow
Bryn	Poet
Caav	Protocol
Class Act	Proxy
Collective Motion	Ramona
Cosgrove	Ria
Connect	Sosa
Encore	Teekan
Finn	Totem
Finn Nu	Trinity
Garvey R5	Wink
Gatsby	Ziva
Harbor	
Hoopz	
Indie	
Jude	
Knox	



Environmental Mission

Our vision and goal is a sustaining supplier, manufacturer and customer for the long term protection and preservation of our environment for future generations.

MISSION

To achieve this vision, we are dedicated to ensuring the health and wellbeing of all of our partners, reducing negative impact on the environment, and maintaining price structure by increasing efficiencies and reducing consumption.

JSI, and it's parent company, is an internal manufacturer and has been an environmentally conscious organization for more than 80 years.

We are proud to use wood as our primary sustainable material resource and all corporate policies and procedures support the efforts to "recover, recycle, reuse, repurpose, reduce, refuse, and re-engineer". In doing this, we are committed to the conservation of the environment and its natural resources as well as encouraging our suppliers and customers to do the same. A goal of a "Sustainable Partnership", supplier, manufacturer and customer, is essential for the long term protection preservation and sustainability of our environment for future generations.

LOCATION

Our manufacturing facilities are located in the center of Southern Indiana. With our diverse product offering and manufacturing capabilities, we provide a single source for all of your project needs allowing you to conserve our fossil fuels and reduce greenhouse gases.

PACKAGING

We place emphasis on the minimal use of disposable packaging while still providing adequate protection to the finished product. Our corrugated packaging is recyclable, reusable, and up to 100% recycled content. We reuse or recycle more than 175 tons of corrugated material annually.

REGULATORY

All of our manufacturing facilities are in compliance with applicable OSHA regulations and meet or exceed all applicable DEM and EPA regulations for air emissions, storm water and hazardous waste disposal.

MANUFACTURING FACILITIES

Our manufacturing facilities are geared toward eco-efficiency and are encouraged to continually improve and conserve. Solid wood not used in the direct manufacturing process is recovered for the operation of our dry kilns, thus reducing greenhouse gases, the use of fossil fuels, and the burden of waste placed on landfills. Composite panels not used in the direct manufacturing process are ground and sold for use as animal bedding and boiler fuel. In addition to other energy savings techniques, our manufacturing facilities use high efficient lighting, make use of power factor capacitors, and encourage all to conserve and reduce energy consumption and water usage. Condensation pumps are used to aid in water conservation as well as extending boiler life.

MANUFACTURING PROCESSES

Our finish processes utilize efficient spray guns and proper spray techniques to reduce wasted material. Excess finish material, solvents, and waste are recycled. Many of the assembly processes use water based glues that contain no hazardous ingredients.

TEXTILES

Many of our fabric options utilize up to 100% recycled content. Our leather alternative program includes selections that contain no toxic materials, plasticizers, heavy metals, or formaldehyde and have a 100% biodegradable back cloth. Some of the available panel fabric used, if discarded is a biological nutrient for the soil. Most of the components (foam, batting, and polycord) used in upholstered products are recyclable. Excess fabrics and leathers not utilized in the upholstery process go to recyclers and local charities for additional use.

WOOD

Wood is the most diverse, most process friendly, and most widely utilized natural resource in mankind's history. No other natural resource can match the environmental advantages of wood, including being renewable, recyclable, natural, carbon negative, and biodegradable. Utilizing the sun's energy, trees grow and remove carbon dioxide from the air while giving off oxygen to benefit the entire planet. Approximately 49% of wood's dry weight is carbon and harvesting mature trees in a sustainable forest, which has slowed in the absorption of carbon dioxide, allows the photosynthetic cycle to continue at full optimization and allow for the carbon to remain sequestered. We are proud to use wood as our primary "sustainable" renewable resource.

WOOD OPTIONS

Many environmentally friendly solid wood and engineered wood options are available for quote, including: Lyptus®, Plyboo®, reclaimed woods, agricultural and post-consumer waste fiber products, etc.

INDOOR AIR QUALITY

Our goal is to reduce the impact our products will have on the indoor air quality. We practice the latest technologies and utilize a third party to assure we meet this goal. GreenGuard, one of the leaders in IAQ certification, continues to certify our product offering with UL2818-GreenGuard Indoor Air Quality certification.

PARTNERSHIPS

BIFMA
Business and Institutional Furniture Manufacturer Association
 USGBC
United States Green Building Council
 IIDA
International Interior Design Association
 FSC
Forest Stewardship Council - Forestland
 UL GreenGuard
Indiana Department of Natural Resources - Division of Forestry - Classified Forest, Wildlands Program

Lifetime Warranty

JSI warrants to the original purchaser that each piece of furniture will be free from defects in workmanship, given normal use and care for as long as the original customer owns and uses the product. Normal use is defined as the equivalent of a single shift, 40-hour work week.

JSI will, at its option, repair or replace with comparable product within the terms of the warranty.

Exceptions to Warranty:

12 Years (from date of purchase)

- Wood Seating
- Seating Controls
- Pneumatic Cylinders
- Laminate Surfaces
- Veneer Surfaces
- Solid Surface Components
- Somna, Kindera, Satisse and Forge in multi-shift environment except components as specifically identified below

10 Years (from date of purchase)

- Recliner Mechanisms and Associated Levelers (regardless of shift usage)

5 Years (from date of purchase)

- Casters (including recliner central locking)
- Glides (including MagLinx™)
- Electric Height Adjustable Bases
- Task Lights
- Mesh/Knit Materials
- Electrical Components
- Foam
- Recliner Heat Components

This Warranty Does Not Cover:

- Natural variations in color, grain or texture of wood and other covering materials over which JSI has no control
- Normal wear, color fastness, shrinkage, puddling, wrinkling and stretching of upholsteries including fabric, vinyl, leather and other textiles. This warranty does not cover any defects that may arise in the use of COM or COL upholstery materials. Textile manufacturer's warranty will apply.
- Damages resulting from transportation, improper assembly, installation, handling, accident, user modification attachments, misuse, or neglect of product care.
- Damage resulting from extreme climate conditions
- Finish damages resulting from normal wear and tear, improper maintenance, water damage, exposure to sunlight, extreme high or low humidity or temperature, or other acts of nature.
- Damage created by loading file drawers with anything other than hanging folders.
- Use of any unauthorized non-JSI components for use in the place of JSI components, including but not limited to worksurfaces, bases, brackets, or other essential components.

Replacement components are warranted for a duration of 2 years or for the remaining duration of the initial warranty, whichever extends further.

Textile supplier's warranty will apply. Given the diverse range of cleaning agents used by various facilities, it is advisable to conduct testing on each textile choice using the facility's designated cleaning techniques prior to placing an order.

JSI makes no expressed or implied warranties to any product and, in particular, makes no warranty of merchantability of fitness for any particular purpose. JSI will not be liable for any consequential or incidental damages under this warranty.

Unique Characteristic of Natural Woods and Veneers

JSI uses high quality wood and veneer harvested from sustainably managed forests. Every tree has unique and defining characteristics, like fingerprints. These characteristics can be defined by differences in color, grain configuration, and textures. These characteristics will be more noticeable if the product has a clear or lighter finish.

JSI uses select beech, cherry, maple, oak and walnut cut wood products to produce the desired look of our furniture products.

Maple and Cherry species have a higher degree of uneven distribution of grain, small color streaks, and pin knots.

At JSI, we take care of selecting woods and veneers that are used in our products. With this in mind, we hope you appreciate the beauty of each tree's fingerprints. Products will not be replaced due to these natural characteristics.

Veneers can be sliced in a variety of ways to create unique patterns. JSI uses several different patterns, as shown below.

Flat (Plain) Cut as shown



Quarter Sliced as shown

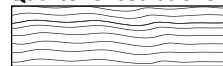

Double Cut as shown



Rift Cut as shown

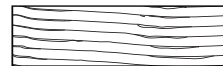

Double Cut

The Double Cut veneer is a processed product that has at least two cuttings to create the final veneers. These cuts of veneer strands are dyed and layered into a block to create variation of patterns from a very tight grain pattern to an exotic figure grain pattern.

JSI offers two collection of veneer, our Essentials and Artisan Collections.

Essentials

The Essentials Collection allows users to specify beautiful veneers, without sacrificing budget, providing grain patterns and hues for maximum material flexibility and style range.

Artisan

The Artisan Collection provides a curated selection of finishes expressing an elevated style and contemporary nature.

Laminates (Veneer Series)

An alternative HPL (Higher Pressure Laminate) laminate work surface can be specified on most of our casegood product lines. The specification pages will also list the available coordinating finishes.

Laminate Series

JSI laminate series offer a full laminated product with imprinted grain to hide finger prints and provide durability. The worksurface tops are HPL (High Pressure Laminate) or TFL (Thermal Fused Laminate). TFL is used on the product's chassis.

An overview of finishes and laminates appear on page IV, detailing which species each veneer finish is applied to.

Series Material Offering

Select finishes, species and materiality are available on a per series offering, with JSI curating the correct palette offering for the series intent. Please refer to each series feature highlights within the product pages to identify the material, species, grain patterns and finishes available for that specific series.

JSI Core Materials

For projects requiring similar finishes across multiple series, JSI recommends using our Core Materials program. Finishes in this group are offered throughout the vast majority* of JSI products in the three main material categories Essentials and Artisan Veneer, Laminate and Solid Maple, in a spectrum of light to dark.

*note: not applicable to all series, for example BeSpace only offers clear veneer finish.

Finish - Top Coat

To reduce hazardous formaldehyde emissions, we use our proprietary specially designed top coat, DuraTex™. It significantly reduces hazardous formaldehyde emissions and helps improve indoor air quality.

Finish - Color/Stains

A wide range of stains are available to bring out the beautiful characteristics of each wood species. We coordinate finish color between our veneer stains and solid lumber stains; however, not all may be a perfect match. The stains are continually reviewed for accuracy of color, as well as a constant monitoring of the latest color trends in the furniture market.

Finish - Matching

Due to the natural characteristics of wood, environmental effects, and material upgrades, JSI cannot guarantee exact finish matches on existing furniture previously ordered.

If an exact match is required to accompany existing furniture, it must be specified at the time of order placement, so specific internal procedures can be followed to ensure a proper and acceptable finish match. We reserve the right to change our finish formula at any time to improve safety, quality, and appearance. Unless a finish match for existing furniture is requested at the time of ordering, we accept no liability for finish that may not match the existing furniture from prior orders.

Solid lumber may inherently have mineral streaks, pits, and various other natural occurrences. Care is taken in selecting the solid lumber to coordinate with the requested finish on our veneer products. This internal selection process is subject to availability of solid lumber parts.

Finish Sheen

All casegood veneer finishes are standard in 35-sheen, with the exception of Raven, which is only offered in 15-sheen. All other finishes are available in 15-sheen, with a 5% upcharge, per model.

Custom/Special Finishes

JSI, upon request, will accommodate special finishes. A written request is required to proceed with custom finish orders. A sample reference is required for first-time matches and must be included with the written request.

There is a charge of **\$384 list per order** for any non-standard wood finish.

Orders will be entered noting the special finish. A sample match will be provided to the customer. Written approval is needed before the finish process can be started. Delays in approval may have an impact on lead times.

Every effort will be made to create the requested match; however, an acceptable match may not be possible because of natural variations of wood. These natural variations can also cause minor differences in the final finish product.

Use standard pricing and option pricing for each line item with a special finish, unless additional modifications have been specified. For items available in both Essential and Artisan veneers, apply the Essentials pricing.

Samples

Samples of standard wood finishes, paints colors, metal colors, and standard laminate are available upon request. The fastest way for requests to be filled is by using our website. See below for options to request samples.

Website – jsifurniture.com (click the resource tab)
 JSI Sales representatives
 Phone – 800.457.4511 – Customer Service
 Email – customerservice@jaspergroup.us.com

Veneer Finish and Laminate Overview

Designator	Finish	Veneer Collection	Veneer Species	Laminate	Core Program
BAR	Barrel	Artisan	White Oak- Double Cut	n/a	N
BRK	Brickdust	Essentials	Cherry	HPL & TFL	Y
BUF	Buff	Artisan	White Oak- Double Cut	n/a	N
CSK	Cask	Essentials	Walnut	HPL & TFL	Y
CND	Cinder	Artisan	White Oak- Double Cut	n/a	N
CLY	Clay	Essentials	Cherry	HPL & TFL	Y
EGR	Egret	Artisan	White Oak- Double Cut	HPL & TFL	N
FAW	Fawn	Essentials	Linear - Double Cut	HPL & TFL	Y
FLX	Flax	Essentials	Maple	n/a	N
FLN	Flint	Essentials	Linear - Double Cut	HPL & TFL	Y
LOF	Loft	Essentials	Linear - Double Cut	HPL & TFL	Y
MES	Mesa	Essentials	Cherry	HPL & TFL	Y
MIN	Mineral	Essentials	White Oak- Double Cut	HPL & TFL	Y
MCH	Mocha	Essentials	Walnut	HPL & TFL	Y
OBK	Outback	Essentials	Cherry	HPL & TFL	Y
PIL	Pilsner	Essentials	Maple	HPL & TFL	Y
RAV	Raven	Artisan	Black Oak	n/a	N
RYE	Rye	Artisan	White Oak- Double Cut	n/a	N
SAB	Sable	Artisan	White Oak- Double Cut	n/a	N
SAD	Saddle	Artisan	White Oak- Double Cut	n/a	N
SIE	Sienna	Essentials	Walnut	n/a	N
TRF	Truffle	Essentials	Walnut	n/a	N
UMB	Umber	Essentials	Walnut	HPL & TFL	Y
VAL	Valley	Essentials	Linear - Double Cut	HPL & TFL	Y



Pricing

Prices found in this document or on our website are list prices in U.S. dollars for standard product delivery to one destination. Prices do not include storage, installation, or taxes. Possession of this price list does not constitute an offer to sell. Orders can only be received from approved authorized JSI dealers.

Prices and product information in this document, as well as our website, are subject to change without notice. Reference website for most up to date product offering and pricing.

In our ongoing efforts to minimize ancillary charges. JSI does not include these fees in any calculations for dealer participation fees or commissions in any form. Ancillary charges include but are not limited to special finish charges, special laminate charges and handling fees. When calculating your dealer participation fee or commission earned, please include product lines only and exclude any ancillary charges. Should you have any questions, please call our office for clarification.

Orders

Detailed specification pages are available in the price list at the beginning of each series.

Additional information may be obtained by consulting the Customer Service Department or our website.

Indicate shipping address if different from billing address.

Send Orders To:

US Mail – JSI
225 Clay Street
Jasper, IN 47546
Fax – 812-482-1548
Email – orders@jaspergroup.us.com

JSI reserves the right to make changes in dimensions, styles, or specifications if we believe these changes will improve the safety, quality, or appearance of the product.

Acceptance of orders will be subject to credit approval, barring any acts of governments, or any other causes beyond our control (e.g. strikes, fire, embargo of materials, etc).

Product Modifications

While we offer a wide range of products to accommodate many possible solutions, we also recognize the needs for our products to be modified from our standard offering.

In the series introduction section of each product, we address modification options for that series.

To see if the desired modification is possible, please contact our Customer Service Department for a quote. Note that order quantities and material availability can affect the quote. Additional information may be requested to fully quote modifications.

Order Acknowledgments

All orders will be acknowledged promptly upon entry of a clean order. The acknowledgment will show how the order was entered, ship date and any other information pertinent to the order. It is the purchaser's responsibility to verify all the information on the acknowledgment carefully and notify us immediately, in writing, of any discrepancies.

Every reasonable effort is made to ship as acknowledged; however, the acknowledged ship date is approximate. Company will generally ship within five (5) working days of the acknowledged ship date. If a firm ship date is necessary, customer must inform company at time of order and company will make all reasonable efforts to meet each customer's request. Acknowledged shipping dates are contingent upon the force majeure conditions contained in these terms and conditions.

Cancellations and Changes

All orders are considered firm and are not subject to cancellation or change without approval from JSI. All approved changes are subject to additional charges and revised lead times

Quickship

JSI offers select Vision models, with select options, in our Quickship program. These items ship within 10 business days after receipt of a clean, credit approved purchase order. Items should be placed on order separate from standard lead time models.

Product for up to 10 offices or 10 tables can be included on a single Quickship order. Available capacity is filled by orders as they are received. If normal 10 day Quickship is not available because capacity has been filled, you will be immediately notified by JSI customer service. Changes and cancellations to Quickship orders are not allowed under any circumstances, nor are modifications to the pre-determined Quickship offering. Limit one order per project.

Delivery

Our freight policy consists of prepaid freight to the 48 contiguous states; all other shipments are prepaid to port of exit ONLY. JSI reserves the right to select the appropriate carrier and shipment routes, most shipments are on freight carriers that are dedicated furniture specialists. Standard deliveries require a DOCK that can accommodate 75 foot trucks. Ownership and inspection of product is the responsibility of the buyer upon pickup by the freight carrier. Pricing in this book is for standard delivery only. Standard delivery does not include non-dock delivery, inside delivery, residential delivery or installation of product. Fees and changes for non-standard deliveries are listed below.

Shipping Destination

Changes to ship to locations may not occur within seven days prior to the ship date, however, in atypical situations a **\$250 change fee** will be applied to accommodate additional carrier fees.

Standard Delivery Time

Between 8 AM and 3 PM Monday through Friday. Special delivery requests can be subject to additional fees to accommodate requests.

No Touch Freight

Our freight is considered "no touch". Therefore, customers are to be prepared to unload freight from inside the truck prior to arrival. In the instance that a driver must unload the shipment, driver assists fees will apply (see fees below).

On-Site Deliveries

Shipments to the installation site, and time deliveries are available on full truckloads or slightly less, at no additional charge. Shipments or timed deliveries for smaller shipments may not be available, or if available may require an additional charge.

Detention Fees

- Carriers are given two-hour maximum time allotment to unload for one-stop truckloads.
- Carriers are given one hour maximum time allotment to unload for multi-stop truckloads

*Detention fees apply after allotted unloading time and will be at buyer's expense.

Fees

Orders of less than \$1,000 net \$93 net per order
(If order is UPS shippable, the handling fee is waived and customer is invoiced for exact shipping charges.)

Weekday deliveries outside of standard delivery times . . . \$309 net

Weekend deliveries (Saturday or Sunday). \$618 net

Liftgate Deliveries \$515 net minimum 7% of net price

Driver Assist \$93 net

Jobsite Non-Dock Delivery \$155 net per truck

Inside Delivery (first floor inside only)- no installation

or carton removal \$258 net minimum 7% of net price

NO RESIDENTIAL DELIVERIES

Warehouse/Storage Fees

Additional storage time with a provided two-week approved notice is calculated at 3% per month of the product amount or per day.

Please be Advised

- Reconsignment fees are the responsibility of the buyer.
- Any charges arising from failure to meet shipment, re-routing while in transit or carrier storage charges are the responsibility of the buyer.
- Contact Customer Service to inquire about skidding of products, special crating of products and product installation. These requests must be approved by JSI and made at the time of order.
- Carriers have the right to refuse delivery to a specified location if it conflicts with their liability policy.

Freight Damage

JSI products are packed in cartons and meet or exceed existing codes for furniture and seating products. All shipments are delivered to the carrier in good condition and our liability ceases thereafter. If delivery arrives short or damaged, contact Customer Service immediately to file a claim. In the event of concealed damage, notify Customer Service and request immediate inspection. Failure to file a claim within 15 days after receipt of merchandise constitutes acceptance and a waiver of any such claims. Please inspect merchandise immediately upon receipt, otherwise there is no recourse. Keep all cartons and packing material, discarding these materials may negate your claim.

Storage of product in areas of uncontrolled humidity and temperature may cause damage to the product and void the JSI warranty.

Repairs

JSI will not issue credit allowance for any type of repairs without prior written consent.

Sales order, product model numbers, and reason for repair will be expected in order to process the repair request. A digital photo will help to expedite the request. JSI reserves the right to recommend solutions for repair.

Replacement Parts

Obtain information and pricing on replacement parts by contacting Customer Service. Please have the model number available when requesting replacement parts. Additional information may be required to ensure proper replacement parts.

Returns

JSI products are made to order and may not be returned for credit. No merchandise may be returned to JSI without a signed Return Good Authorization (RGA) form issued by our Customer Service Department. RGA's will be considered for the following reasons:

1. Manufacturing defect (validated by JSI representative).
2. JSI order processing error.
3. Shipping error.
4. Mis-marked cartons.
5. Duplicate shipments.

Liability for defective merchandise shall be limited to replacement or repair.

If you have questions as to whether your reason for return qualifies for consideration, please contact Customer Service. At the discretion of JSI, returns on stocked items may be considered with the following stipulations:

1. 60% restocking fee.
2. All return freight charges must be prepaid by dealer.
3. Product was never removed from the original carton.
4. Product must be returned within 30 days of RGA issue date.
5. Credit will not be issued if product returned is damaged.
6. Under no circumstances can we accept COD (Cash on Delivery) returns. Any such shipment will be refused.

Please note most models on Quickship are produced on demand and cannot be returned. Modified, special or custom-built product is not eligible for return.

Fire Retardancy

All JSI upholstered components comply with California Bureau of Home Furnishings and Thermal Insulation-Technical Bulletin 117-2013 issued by State of California Department of Consumer Affairs. This standard requires upholstered furniture to be safer from the hazards associated with smolder ignition in all four (4) categories of materials, as applicable.

Compliance with more stringent codes may require special manufacturing considerations and upcharges.

California Technical Bulletin 133 (CAL 133)

JSI uses a barrier material between the foam cushioning and the upholstery cover in order to comply with CAL 133. The standard upcharge on products specified to comply with CAL 133 is **\$81 list per yard** of textile.

JSI has performed a series of full scale fire tests on samples-representing worst case scenarios of upholstered units- to comply with the requirements of the state of California Technical Bulletin 133 (CAL 133). Products in compliance are labeled in accordance of the standards.

Some product designs and fabric cannot be combined to comply with CAL 133. Because of this, we reserve the right to reject any request for an upholstery cover, including COM, textile may not contain olefin or product style that we feel may compromise the integrity or safety of a product specified to comply with CAL 133.

Contact Customer Service for a quote if you require laboratory certification that a specific product and upholstery combination WILL PASS CAL 133. The quotation will include testing, video, and transportation charges plus the list cost of the sample.

Our standard lead time will apply to products that do not require certification. Allow an additional six weeks over the standard lead time for products that need actual laboratory certification.

The end user, specifier and/or dealer have the responsibility to make sure all products specified will meet the flammability and safety codes of the jurisdiction where the products will be located and used.



Flame Spread

All JSI may be required to comply with the requirements of Flame Spread based on ASTM standards/NFPA Life Safety Codes and general public knowledge are as follows:

- Solid Wood- Class C
- Topcoats- Class A
- Carded Fabric- Class A
- Composite Panels- Class C
- Laminate- Class B

Plastics- According to the NFPA, the lack of stability of plastics under high temperature conditions and inherit combustibility have eliminated the use of plastics for applications requiring a flame spread rating.

Also be advised that improvements may be attained in certain instances with the addition of chemicals which may add additional costs, chemical exposure and/or compromise the integrity of the product.

Textile Carded Programs

JSI is proud to partner with Maharam, Momentum, Spradling, Stinson, Ultrafabrics, Camira and Cortina Leather. Please refer to our website for our standard patterns, along with the current grade.

<https://www.jsifurniture.com/finishes-and-materials/textiles>

Textile Grade-In Programs

For the convenience of our specifiers, we offer an extensive graded in program. Please reference our website for the most up to date information on our graded in program.

<https://www.jsifurniture.com/resources/textile-partner-info/overview/>

For additional specifications on the pattern or to order memo samples, please contact the textile suppliers directly:

- Arc Com www.arc-com.com
- Camira www.camirafabrics.com
- DesignTex www.designtex.com
- Maharam www.maharam.com
- Mayer www.mayerfabrics.com
- Momentum www.themomgroup.com
- Spradling www.spradlinggroup.com
- Stinson www.cfstinson.com
- Ultrafabrics www.ultrafabricsllc.com
- Cortina Leather www.cortinaleathers.com

Any textile not graded in or pre-approved for COM/COL will require application test approval prior to order entry and shipment of fabric or leather to JSI. For current JSI grades and application status by series visit www.jsifurniture.com Resources > Graded-In + COM; [Graded-In + COM](#).

Indicate on purchase order if JSI is to order the fabric.

Grades and availability of fabric are subject to change without notice. Changes could include but are not limited to price increase, discontinued patterns, discontinued colors, etc. See www.jsifurniture.com for up to date information.

Many textiles have repeats and the additional yardage required has been factored in for textiles ordered through the JSI Carded and Grade-In Programs. We reserve the right not to match textiles with a horizontal or vertical repeat greater than 17". Additional charges may apply for textile being applied with special instructions.

Some fabric thickness or stiffness may cause issue with proper upholstering of tackable wall panels or upholstery privacy screens. Please contact customer service with concerns on the fabric thickness for these items.

COM/COL Address

JSI
Attn: COM/COL Department
Receiving B
Dock 71
201 East Martin St.
Orleans, IN 47452

Tag: Dealer Name / Purchase Order #

General COM Fabric/COL Hide Policy

Refer to the COM/COL Price Columns for list prices.

All yardage requirements listed in the price list are based upon 54" plain non-directional material. Additional yardage may be required based on fabric repeat and matching.

All square footage requirements for COL are based on an average hide size of 50 square feet.

Contact Customer Service for any of the following conditions:

- + approval of COM/COL to be used (see policy on the next page)
- + fabric repeats greater than 3"
- + fabric less than 54" wide
- + leather hides smaller than 50 square feet
- + special application requirements request

When requesting information from Customer Service on COM/COL please supply the following information:

- + model number and quantity of the product the COM/COL will be applied
- + COM/COL textile supplier's name
- + name of pattern and color of the textile
- + any special application request

Visit www.jsifurniture.com Resources > Graded-In + COM to see if the textile has already been approved. If there is no record for this particular textile then a Memo Sample will be required.

JSI takes no responsibility when additional materials must be ordered.

COM Fabric Repeat Guide

Roll Width	Plain Fabric	1" - 5" Repeat	6" - 10" Repeat	11" - 15" Repeat	16" - 20" Repeat	21" - 30" Repeat	31" - 40" Repeat	41" - 50" Repeat
54"	0%	10%	15%	20%	25%	30%	40%	50%
53" to 51"	15%	20%	25%	30%	35%	40%	50%	60%
50" to 48"	30%	35%	40%	45%	50%	55%	70%	90%
47" to 36"	60%	65%	70%	75%	80%	85%	100%	120%

The percentage represents the additional fabric yardage that needs to be added to the COM yardage. Contact Customer Service for repeats greater than 50".

All COM/COL must meet applicable codes and regulations, including TB117-2013. By selecting COM/COL, customer certifies that the material meets such codes. JSI assumes no responsibility for the applicable codes and regulation regarding flammability rating and safety rating of any COM/COL.

JSI cannot be held responsible for receipt of defective fabrics, as we apply all COM as first quality goods.

We can take no responsibility for tailoring, wear-ability or application of COM/COL textiles. Any warranty claims for the COM/COL Textile materials will fall to the original vendor of the textile, not JSI.

COM Fabric/COL Hide Process for JSI Seating

General COM Fabric and COL Hide Policy also apply.

JSI will approve or disapprove COM/COL on all products. An approval of a textile from JSI makes no claim that performance, durability or tailoring of COM/COL will result in satisfactory upholstery. Every effort will be made to meet customer's expectation, but fabrics/leathers have unforeseen inherent characteristics that may limit JSI's ability to deliver a well tailored product.

Approval COM Textile/COL Hide Process for Seating

Follow the Steps Below:

1. Send a Memo Sample of the COM/COL (recommended memo be at least 4" x 4")
 JSI
 Attn: COM/COL Approval Department
 201 East Martin Street
 Receiving B, Dock 71
 Orleans, IN 47452
2. Call our Customer Service Department at 812-482-3204 to request an electronic version of approval form.

Guide Order Form for COM and COL

Please send sample to:
 JSI
 Attn: COM/COL Approval Depart.
 201 East Martin St.
 Receiving B, Dock 71
 Orleans, IN 47452

① **Order Information:**

Quote #: _____ **Purchase Order #:** _____

Customer Service: _____

Dealer Name/Project Name: _____

Contact: _____

Address: _____

Phone: _____ **Email:** _____

Model Number(s) Receiving COM / COL: _____

Please forward a copy of this form to your JSI CSR for record keeping

② **Select off the bolt application: (Check one of the boxes)**

Up the roll (standard on most seating) Railroaded

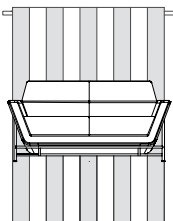
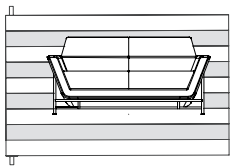
③ **Additional information:** _____

④

Attach sample here.

JSI will review and test as needed all requests. You will be notified as soon as results are documented by our review personnel. JSI reserves the right to reject any COM/COL on our products. We will provide COM/COL explanation of any unapproved textile whenever possible.

Custom Options

Wood Laser Engraved Back

Many of our seating models are available with a custom wood laser engraved back. University seals, logos, unique designs, or any type of graphic can be designed into the seating back for a custom creation. Copyright approval may be required. Consult JSI Customer Service for pricing and artwork specifications. Artwork must be submitted as a JPG or PDF file.



Wood Laser Engraved Back General Pricing

* must order plain back when choosing these options

For Artwork 4" x 4" or Less	\$58 list per chair
For Artwork Less than 6" x 6"	\$102 list per chair
For Artwork Larger than 6" x 6"	Call For Pricing

For orders fewer than 50 pieces, add \$158 list per design, per order. This pricing reflects etching (leaving the wood dark). If additional painted colors are added to artwork please call customer service for pricing.

A \$139 list set-up fee applies.

Care and Maintenance

Care and Maintenance

Care of Upholstery Surfaces

Cleanability will vary based on the fabric type. For best results, a professional service is recommended. Dirt and crumbs may be gently brushed or vacuumed off. Spills should be wiped up immediately with a cloth. Vinyl textiles can be cleaned with warm soapy water and then wiped down with a warm damp cloth. For more details on any JSI carded fabric and vinyl, please visit our website at jsifurniture.com or consult the back of the appropriate swatch card for cleaning codes and any specific instructions. For COM materials, consult with the individual textile manufacturer for cleaning codes and any specific instructions pertaining to your particular fabric.

Maintenance of Mechanical Parts

Clean any lint or debris from the moving parts of the base mechanisms. Mechanisms have been designed and tested to not require lubrication under normal conditions; however, lubricant can be used if needed.

Care of Wood Edges and Veneer Surfaces

Clean all surfaces frequently with water dampened soft cloth, moving the cloth with the grain direction. Immediately remove any liquids that come in contact with wood surfaces with a blotting action to absorb liquid. Buff dry. Lift objects to move them, never pull them across the finished surface. For an additional safeguard, use a protective surface pad. This will ensure a lasting finish by protecting your furniture from possible damage caused by pens, cups and sharp objects. Avoid exposure of furniture to extremes of heat and cold, or to wide humidity variances. Avoid exposure of furniture to strong sunlight. Avoid exposure of furniture to harsh solvents such as nail polish remover, acetates, etc., as it will cause finish deterioration. If using a protective glass top, place spacer pads under the glass top to allow the wood to breathe.

Care of Metal Finishes

Wash your powder-coated item at least one every six months. Use soft rags only - No abrasives. For stubborn stains and grease marks, use soap and water mixture. Combine 1 gallon of water and 1 cup of the neutral detergent in the bucket. Mix it up by swirling one of the rags around in it. Wipe down the powder coat with a rag that has been dampened with the cleaning solution. Do not scrub, but use gentle, repetitive pressure to remove any built-up grime. Rinse the powder coat off with a rag dampened with clear, clean water. Do not spray it down, but rather wipe it off with the rag. You may need to do this several times to get all the soap off. Wipe the powder coat down with a clean dry rag. This will prevent streaking and spotting.

Care of Frosted Glass

Use a clean, dry lint free cloth to wipe the surface. Follow with warm water and a clean rag; no soap or chemicals. Wipe dry with a clean, dry lint free cloth. Cleaning the frosted side is not recommended, if desired to clean use the above method but do not spray the water on the frosted side, use a clean rag. Please allow 48 hours for the frosted side to dry and not to show cloudiness.

Tempered Glass Information

JSI is aware of occasional occurrences of spontaneous glass breakage in various furniture products. Tempered glass makes it stronger and if it breaks, will cause it to break into many small pieces of “cubes” rather than sharp and potentially dangerous shards.

Glass breakage in furniture may occur for a variety of reasons. Tempered glass is particularly prone to breakage from damage (scratches, nicks, etc.) that may occur during shipping, handling, installation, use or maintenance. Exposure to rapid changes in temperature or concentrated temperature zones may also cause breakage.

Tempered glass may also break due to a specific type of imperfection or “inclusion” that occurs within the glass when manufactured. When this condition exists glass breakage may occur without any obvious cause. This is often referred to as “spontaneous” breakage but is a very isolated occurrence in the glass industry.

Care of Dry Erase Boards

Erase after every use to eliminate ghosting. Clean weekly with a Dry Erase Cleaner. Avoid the use of orange and red Dry Erase Markers. Follow manufacturers cleaning instructions for the eraser. If ghosting or staining remains use a small amount of rubbing alcohol on a clean, soft towel to remove.

Care of Solid Surface

Although liquids cannot penetrate Solid Surface, it is best to wipe up spills as they occur. Generally, a damp microfiber cloth used with a standard household kitchen spray should remove most stains.

For most residues, all you need to clean your Solid Surface countertops is a warm soapy water, ammonia-based household cleaner or a dedicated countertop cleaner. Do avoid window cleaners; however, as they can leave a waxy build-up that dulls the surface. Always clean using a circular motion.

Film will build up on countertops if water is left to dry on the surface. This film will dull the countertop surface, making the finish appear blotchy and uneven. To prevent film build-up, it is very important to wipe the countertop completely dry immediately after spills and cleaning.

Some color of Solid Surface may require more frequent cleaning to maintain a uniform finish. Darker colors tend to require more attention than lighter colors. Over time, even with proper care, your countertop will acquire a sheen. Dark colors may show light scratches more readily.

Specification Tools

JSI products are manufactured to order and provide a multitude of options to address your individual customer needs. As you process your order do not forget to include all the necessary information to allow the order entry process to be completed. Please see the order checklist at the beginning of every series.

JSI Customer Service edits every order for complete information. If details are not included with the purchase order, Customer Service will contact you to answer these questions. If information is not completed in a timely manner it will delay the entry process and could affect your product delivery date. To avoid delay in order entry and potential delay in delivery of your order, please double check the line items to ensure all selections have been completed.

To ensure completion of details on your purchase order, electronic catalogs and specification tools have been developed to aid in the process. These electronic tools include:

20-20 GIZA Studio and 20-20 CAP Studio software offers state-of-the-art design, specification, photo-realistic rendering and three-dimensional visualization capabilities for configurable products in the commercial interior design markets. 20-20 GIZA Studio and 20-20 CAP Studio are available for all JSI Casework and Seating products, in 2D and 3D graphics and the Specifier Catalog. Updates are made monthly reflecting any changes that occurred. To be sure the most up to date information is provided on orders, users of this software program are responsible to update their catalogs.

CET Designer, by Configura is an all-in-one software solution for space planning and configuration of products. The intuitive workflow guides you through entire process from idea to reality- supporting every step of the sales process

GSA Advantage is a Federal Government electronic catalog site offered to assist GSA customers in specifying and pricing JSI product. Listed at this site are all contract items and prices under GSA Contract # GS-28F-0030U.

Our JSI website jsifurniture.com provides many tools to assist in the design and order selection. Included in the site are downloadable images, typicals, product symbols, brochures, contact information, price lists, sales representative locations, warranty and environmental information.

GSA Terms and Conditions



Contract Holder

Contract # GS-28F-0030U

Maximum Order
\$250,000 net

Geographic Coverage
48 contiguous states and Washington D.C.

Point of Production
Jasper, Dubois County, Indiana
Orleans, Orange County, Indiana

Discount
Discount 61.6%* off list.

*Discount for Walden and Wellington is 61.71% off list.

Discount Quantity
Walden and Wellington only
\$300,000 to \$350,000 Net = 0.5%
\$350,001 to \$400,000 Net = 1%
\$400,001 to \$450,000 Net = 1.5%

Prompt Payment Terms
1% 15 - net 30 days from date of invoice.

Government purchase cards are accepted at or below the micro-purchase threshold

Government purchase cards are accepted above the micro-purchase threshold

Foreign Terms
Not applicable.

Time of Delivery
30-75 days after receipt of order, 90 days maximum.

Expedited Delivery
Contact Customer Service 800-457-4511

Overnight and 2-day Delivery
Not applicable.

Urgent Requirements
Contact Customer Service 800-457-4511

F.O.B. Points
F.O.B. destination, freight prepaid and allowed to 48 contiguous states and Washington D.C. excludes special delivery requirements.

In addition to the standard terms and conditions, the following terms and conditions apply to GSA contract.

Contract Number
GS-28F-0030U

Contract Period
June 24, 2013 - June 24, 2028

Statement of Intended Use
The furniture covered by special item number 33721 Office Furniture shall comply with the requirements defined in purchase description 3QSAB 09-608. All furniture offered under this SIN shall be GSA Chassis Grade 1, 2, 3 or NA, GSA Drawer Grade 1, 2, 3, 4 or NA, Design A B or C, as defined in 3QSAB 09-608.

Description of Special Item Number SIN #33721

Cooperative Purchasing
No

Set Aside
No

FSC/PSC Code
7125

NAICS 337211 Wood Office Furniture Manufacturing 1000 employees

Includes all furniture placed in an office, such as chairs, desks, etc. In addition, ancillary services are included, however services performed shall not be the primary purpose of the work ordered.

Lowest Price Model

SIN #	Model Number	Net Price
33721	VS-LBRKT-20	\$28.03



GSA Terms and Conditions

Ordering Address

Jasper Seating Company, Inc. d/b/a JSI
Attn: Participating Dealer
225 Clay Street
Jasper, IN 47546
Fax: 812-482-1548
Phone: 800-457-4511
Email: orders@jaspergroup.us.com

Order Procedures:

Per contract

Payment Address

JSI
225 Clay Street
Jasper, IN 47546

Warranty Provision

Limited Lifetime

Export Package Charges

Quoted on project-by-project basis.

Terms of Government Commercial Credit Card Acceptance

Accepted.

Rental, Maintenance, and Repair

Not applicable.

Terms and Conditions of installation

12% of net purchase order for installation services up to \$250,000.00 of net purchase price.

Terms and conditions of repair parts, etc.

See warranty.

List of service and distribution points

Contact Customer Service 800-457-4511.

List of participating dealers

Contact Customer Service 800-457-4511.

Preventive Maintenance

N/A

Environmental Attributes

GreenGuard Certified and recycled wood waste and fabric remnants

Section 508 Compliance

N/A

DUNS

00-636-7767

CCR and SAMS Registration

Jasper Seating Company, Inc. is registered
Cage Code #31881
Federal ID #35-0420370
UEI #DDJ2GKQM7M84

Product Modifications

We willingly accept customers' modifications to standard products. See product modification information by series at the start of each series under the "Product Modification" sections. If there is a modification you desire that is not listed in this section, please call Customer Service for a modification quote/price

Acceptance, Modification, Assignment

By placing this order for furniture, material or other products (sometimes collectively referred to as "goods"), customer agrees to these terms and conditions which shall prevail over inconsistent provisions in any other form or document of customer. No change or modification shall be applicable unless set forth in writing and signed by company. Neither this order nor any interest therein shall be assigned by customer except with the prior written consent of company.

Payment

Customer agrees to pay to company the amount indicated on the invoice, 1% 15 days, net 30 days from date of invoice (U.S. funds only), for goods ordered. Interest will be charged after 30 days from the date of invoice at the rate of one and a half percent (1.5%) per month. International sales will require additional payment arrangements. No goods shall be sold on consignment or conditional sales basis. Payment for the goods delivered hereunder shall constitute acceptance thereof.

Attorneys' Fees

Customer shall be responsible for all expenses and cost in connection with the enforcement by company of these terms and conditions and the cost of collection (including the fees of any collection agencies to whom the customer's account may be referred), plus reasonable attorneys' fees (which attorneys' fees shall not be less than 25% of the amount due, unless a lower amount is specified by applicable law).

Remedies

The remedies herein reserved shall be cumulative, and additional to any other or further remedies provided in law or equity. No waiver of a breach of any provision of these terms and conditions shall constitute waiver of any other breach or of such provision.

Insolvency

Company may forthwith cancel this order in the event of the happening of any of the following or any other comparable event: insolvency of the customer, the filing of a voluntary petition in bankruptcy, the filing of any involuntary petition to have customer declared bankrupt provided it is not vacated within thirty (30) days from the date of filing, the appointment of a receiver or trustee for customer provided such appointment is not vacated within thirty (30) days from the date of such appointment, or the execution by customer of an assignment for the benefit of creditors.

GSA Terms and Conditions

Limitation of Liability

The Company shall not under any circumstances be liable to the customer, owner of the goods or any third party for special, indirect, incidental, or consequential damages, including, without limitation, loss of profits or revenues, loss or damage to other property or equipment, cost of capital or of purchased or replacement goods, or expense, delay, or inconvenience caused by or arising from the purchase, sale, use, repair or inability to use the goods or by any performance or non-performance under, or breach of, these terms and conditions. The Company's sole liability for any defective goods shall be its repair or its replacement pursuant to the express warranties set forth above, or if amended, as applicable at the time of manufacture or repair of the goods. Some states do not allow the exclusion or limitation of incidental or consequential damages, so the above limitations or exclusion may not apply to all customers. Any action resulting from any breach on the part of company as to the goods or services delivered here under must be commenced within one year after the cause of action has occurred.

Returns and Allowances

Reasonable touch-up and deluxing is the dealer's responsibility. The Company will not make allowances for trip or delivery charges, but will only make allowance for actual work performed to correct manufacturing defects. Allowances maybe authorized only by a company officer. It is the responsibility of the field sales representative to inspect any defective merchandise and make suggestions and recommendations as to the proper disposition. Field personnel cannot obligate or bind the company by definite agreement, without final authorization by a company officer. Company will not accept automatic charge backs which do not have prior authorization. All defects must be called to the company's attention upon arrival at the customer's "ship to" destination. To initiate any type of claim or request for parts, it is imperative to have the model number or fabric number, which may be located on the tag attached to the frame of the unit. Authorization for return to the company via a return goods authorization. Company will not issue credit allowances for any repairs without company's prior consent. Under no circumstances shall the company accept COD (cash on delivery) returns, and any such shipment will be refused.

Security Agreement

The Company may require and customer shall grant a security interest in goods sold pursuant to any credit the company may extend to the customer.

Governing Law

All disputes between the parties, whether or not arising out of these terms and conditions, will be governed by the laws of the state of Indiana. Customer agrees to submit to the jurisdiction of and agrees all lawsuits relating to any disputes between the customer and the company will be brought only in a state court located in Dubois County, Indiana or the United States District Court for the Southern District of Indiana. The customer hereby waives the right to a trial by jury in any action, proceeding, claim, or counterclaim whether in contract or tort, at law or in equity, arising out of or relating in any way to these terms and conditions and all other disputes between the parties.

Mitigation

If the company repossesses the goods prior to payment by the customer of all amounts due hereunder, the company may sell the goods, as is, where is, free and clear of all rights of the customer at either public or private sales, and apply the net proceeds (after deducting expenses of repossession and sale) to the obligation of customer hereunder. The customer may dispose of the goods in any commercially reasonable place and manner and the customer waives any notice of time, place and manner of sale.

Integration

This order for goods, including these terms and conditions, along with any credit application, invoice, statement, dealer contract, acknowledgment, bill of lading (and any exhibits, addenda or amendments thereto) of which this order may be a part, constitutes the sole and complete agreement between the company and the customer with respect to the purchase of the goods.

Dimensions/Specifications/Finishes

All dimensions are approximate and may vary due to the upholstery technique of each craftsman. If exact dimensions are required, it is necessary for the customer to state such specifications with the order. Detailed specifications sheets are available for each series of goods, and customer should consult the company's customer service department for these specification sheets. Company reserves the right to make changes in dimensions, style, or specifications if company believes these changes will improve the goods' quality or appearance. Company reserves the right to substitute hardwoods due to availability at production. Due to the natural characteristics of wood, environmental effects, and material upgrades, the company cannot guarantee exact finish matches on existing goods previously ordered from company. If an exact match to customer's existing goods is required, it must be specified so that the proper procedures can be followed to ensure an acceptable finish. Company will accept no liability for the finish if this procedure isn't followed. Company reserves the right to make changes in a finish formula if company believes the change will improve the quality or appearance of company's goods.

Company's Performance of Its Obligation

The production and delivery of the goods to the extent delayed or hindered or prevented from the performance by reason of natural disasters, acts of god, strikes, lockouts, labor troubles, inability to procure materials, casualties, failure of power, restrictive governmental laws or regulations, riots, insurrections, acts of terrorism, war or other reason of a like nature not the fault of the company shall excuse for the period of the delay the company's performance and the period for the performance shall be extended for a period equivalent to the period of such delay.

Training - Table of Contents



Training



Teamwork



Conference



Lounge

Lok - Training

Product Information

Training Overview	3
Tables Shapes & Sizes	4
Laminate Specifications	5
Base Styles - Features	6
Nesting Details	7
Modesty Details	8-9
Screen Details	10-11
Electrical Planning - Options	12-13
How To Specify	14-15

Pricing Pages

Training Table Tops	16-37
Bases	17-63
Modesty Panels	64-66
Privacy Screens	67
Portable Slide On Screens	68-69
Instructor Stations	70-71
Podiums	72
Mobile & Fixed Screens	73
ECONO Electrical	74-75
LINK Electrical	76-77
Wire Management	78
Accessories	79

Training - Overview



rectangular
pages 22-26



trapezoid
pages 28

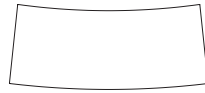

lecture
pages 30

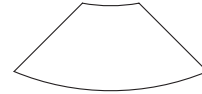

crescent
pages 32

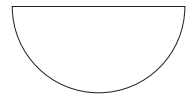

half round
pages 34

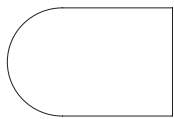

bullet
pages 36

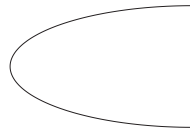

hive
pages 37

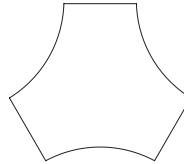

intersect
pages 38

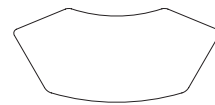

huddle
pages 39

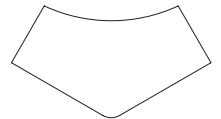

one twenty
pages 40

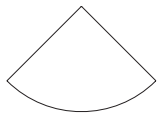

quarter round
pages 42

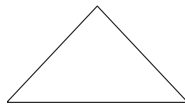

wedge link
pages 43

Training - Top Shapes

Lok offers 12 training table top shapes. Tables are available in 29" and are always laminate. Compatible bases are: T Base, Cantilever T Base or In Line. Seating capacity below assumes that only one side is used.

LOK - TRAINING



rectangular

29"h

- 20" x 36" Seats 1
- 20" x 48" Seats 1
- 20" x 60" Seats 2
- 20" x 66" Seats 2
- 20" x 72" Seats 3
- 20" x 84" Seats 3
- 20" x 96" Seats 4
- 24" x 36" Seats 1
- 24" x 48" Seats 1
- 24" x 60" Seats 2
- 24" x 66" Seats 2
- 24" x 72" Seats 3
- 24" x 84" Seats 3
- 24" x 96" Seats 4
- 30" x 36" Seats 1
- 30" x 48" Seats 1
- 30" x 60" Seats 2
- 30" x 72" Seats 3
- 30" x 84" Seats 3
- 30" x 96" Seats 4



trapezoid

29"h

- 24" x 48" Seats 1
- 30" x 48" Seats 1



lecture

29"h

- 24" x 48" Seats 1
- 24" x 60" Seats 2
- 30" x 48" Seats 1
- 30" x 60" Seats 2

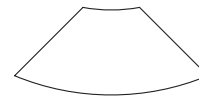

crescent

29"h

- 24" x 48" Seats 1
- 30" x 48" Seats 1

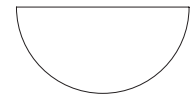

half round

29"h

- 24" x 48" Seats 2
- 30" x 60" Seats 2

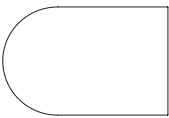

bullet

29"h

- 30" x 60" Seats 4
- 30" x 66" Seats 4
- 30" x 72" Seats 5
- 36" x 60" Seats 4
- 36" x 66" Seats 5
- 36" x 72" Seats 5
- 48" x 72" Seats 6

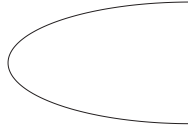

hive

29"h

- 30" x 60" Seats 4
- 30" x 66" Seats 4
- 30" x 72" Seats 5
- 36" x 60" Seats 4
- 36" x 66" Seats 5
- 36" x 72" Seats 5
- 48" x 72" Seats 6

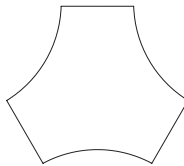

intersect

29"h

- 24" x 60" Seats 6
- 30" x 60" Seats 6

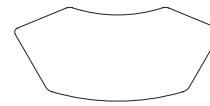

huddle

29"h

- 30" x 72" Seats 6
- 36" x 84" Seats 6

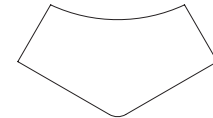

one twenty

29"h

- 42" x 73" Seats 4
- 45" x 84" Seats 4



quarter round

29"h

- 24" Seats 1
- 30" Seats 1

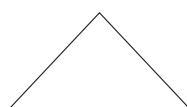

wedge link

29"h

- 24" Seats 1
- 30" Seats 1

Training - Surface Materials

Laminate Tops

Lok training table worksurfaces are offered in both TFL (Thermal Fused Laminate) and HPL (High Pressure Laminate).

The tops are 1 3/8" thick, 3 ply balanced construction.

HPL - Particle board core, HPL face and a phenolic backer sheet complete the balanced construction.

TFL - Particle board core, TFL thermally fused face and matching backer complete the balanced construction.

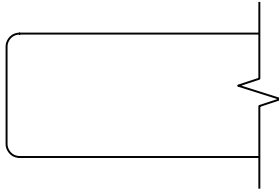

Eased Edge (R3)

PVC

Standard PVC Edge Colors

JSI supports 26 standard PVC edge colors listed below. These coordinate with our Standard TFL and HPL (T1) Laminates.

When selecting a Standard TFL or HPL 1 Laminate, the coordinating PVC edge color is automatically applied. When selecting a Graded-In Laminate (HPL 2), you will be prompted to choose between one of those 26 PVC edge colors to be applied to the edge.

ALB	Alabaster	MES	Mesa
BEL	Belair	MIN	Mineral
BLK	Black	MCH	Mocha
BRK	Brickdust	OBK	Outback
BBL	Bridal Blanco	PIL	Pilsner
CSK	Cask	PIN	Pinnacle Walnut
CLY	Clay	SHD	Shadow
DWH	Designer White	SLG	Slate Grey
EGR	Egret	UMB	Umber
FAW	Fawn	VAL	Valley
FLN	Flint	WAL	Walnut Heights
FLO	Florence Walnut	WEA	Weathered Ash
LOF	Loft	ZEN	Zen Grey

Standard Laminates

JSI Standard Laminate program consists of 26 solid and wood grain patterns, and establish our standard TFL and HPL (T1) laminate pricing. Each has a coordinating PVC edge color that is automatically used with the Standard Laminates.

Wood Grain Laminate

BEL	Belair	MIN	Mineral
BRK	Brickdust	MCH	Mocha
CSK	Cask	OBK	Outback
CLY	Clay	PIL	Pilsner
EGR	Egret	PIN	Pinnacle Walnut
FAW	Fawn	UMB	Umber
FLN	Flint	VAL	Valley
FLO	Florence Walnut	WAL	Walnut Heights
LOF	Loft	WEA	Weathered Ash
MES	Mesa		

Solid Laminate

ALB	Alabaster
BLK	Black
BBL	Bridal Blanco
DWH	Designer White
SHD	Shadow
SLG	Slate Grey
ZEN	Zen Grey

See pages 456-461 for Tier 2 Laminates.

Training - Base Styles

Lok provides a choice selection of bases in both function and aesthetics to serve a variety of needs. The training offering includes: T-base, Cantilever T-Base, and In-Line T-Base

LOK - TRAINING

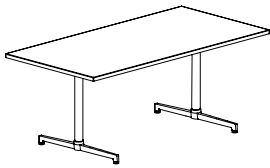

T-Base

- models offered in fixed leg with glide or caster, tilt with caster, or 9 pin adjustable height leg
- compatible with the following top shapes: bullet, crescent, half round, lecture, rectangular, trapezoid, intersect, huddle, hive, one-twenty
- base finish - select single metal finish or two-tone metal finish. See options listed below.

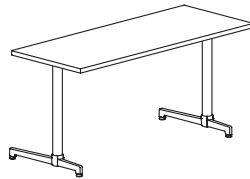

Cantilever T-Base

- models offered in fixed leg with glide or caster, tilt with caster, or 9 pin adjustable height leg
- compatible with the following top shapes: crescent, half round, lecture, rectangular, trapezoid
- base finish - select single metal finish or two-tone metal finish. See options listed below.

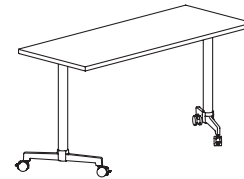

In-Line T-Base

- available in 29" h leg with caster
- compatible with the following top shapes: crescent, half round, lecture, rectangular, trapezoid
- base finish - select single metal finish or two-tone metal finish. See options listed below.
- allows tables to nest inline

Single Metal Finish

- ABZ** Aged Bronze Feet & Post
- ASL** Arctic Silver Feet & Post
- GLD** Gold Feet & Post
- PEW** Pewter Feet & Post
- MBK** Matte Black Feet & Post
- SBZ** Soft Bronze Feet & Post
- SNK** Soft Nickel Feet & Post

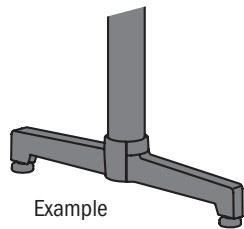

Two - Tone Metal Finish

Two - Tone Aesthetics can be achieved by specifying Polished Aluminum on the foot and a contrasting finish on the post

Polished Aluminum Feet

- ABZ** Aged Bronze Post
- ASL** Arctic Silver Post
- GLD** Gold Post
- PEW** Pewter Post
- MBK** Matte Black Post
- SBZ** Soft Bronze Post
- SNK** Soft Nickel Post

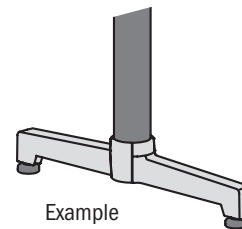

9-Pin Adjustable Height

Pin adjustment located on column offers the ability to adjust tables from 26" to 34" high.

Easy operation by pushing in spring loaded latch pins, slide to desired height position and release pins to lock into place.

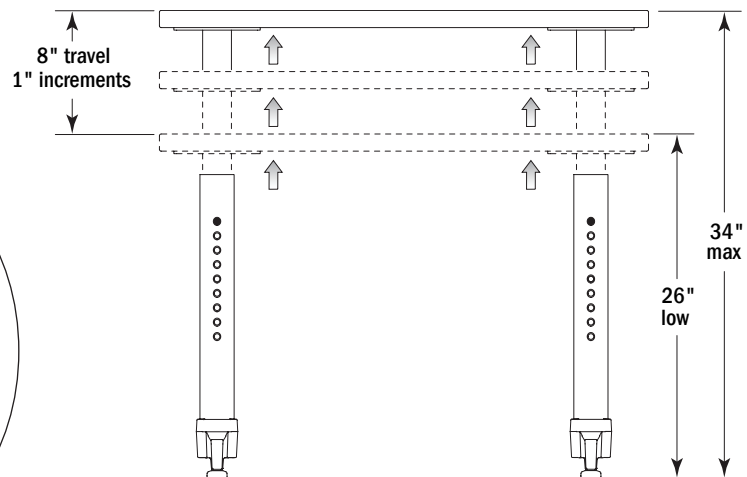
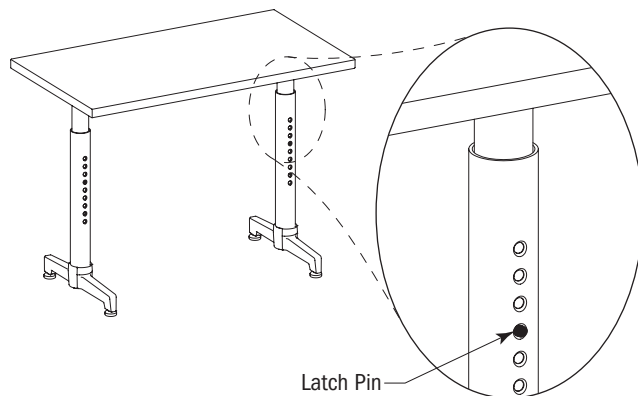

Training - Nesting/Space Planning

Lok In line and Offset Nesting

- adapt to ever changing multi-purpose areas, providing reconfigurability
- modularity, flexibility and ease of use by a single individual with single paddle release
- tilt and lock in position for easy nested storage
- T-Base & Cantilever T-Base allows nesting applications with the offset spacing, while In Line nesting is achieved by the In Line T-Base
- offset or in line nesting limit storage space required to move the tables out of the way
- compact tilted tables easily move to another location
- wire management clips are incorporated into the horizontal top cross beam in 48" or wider tables

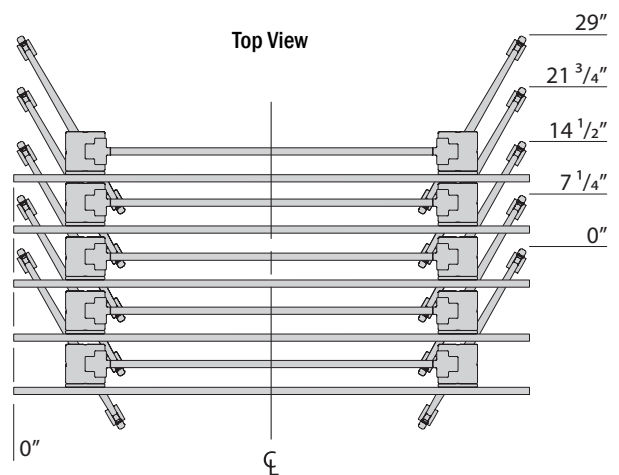
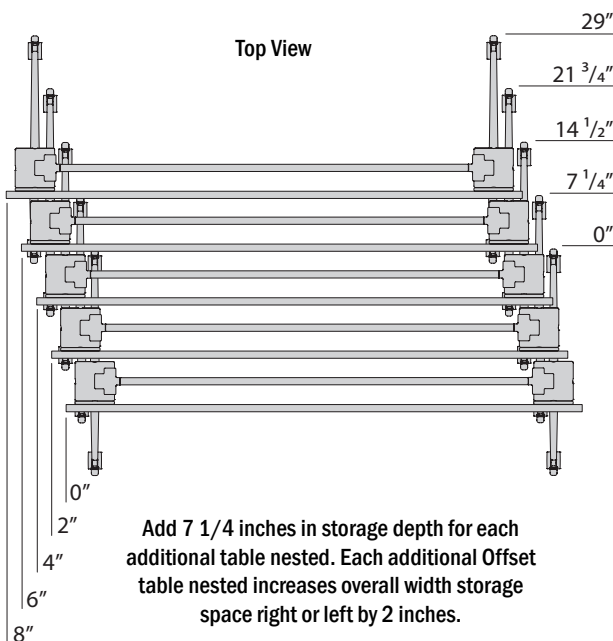
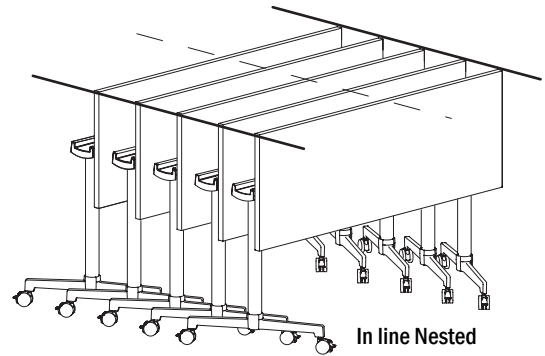
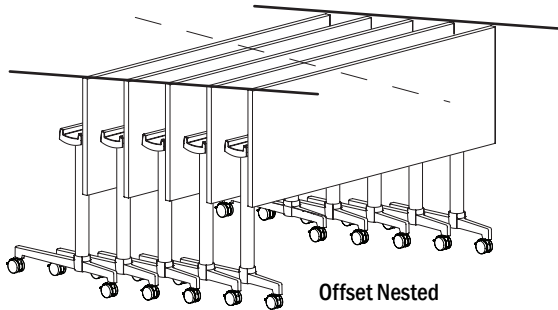
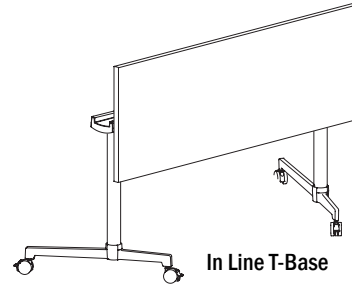
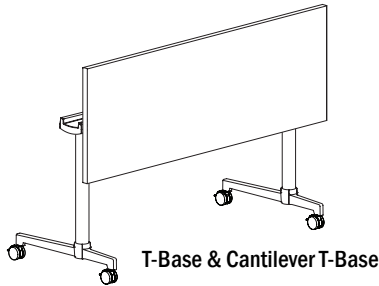

Training - Modesty Panels

Modesty Panels

Full table width panels provide user 9" of privacy and conceal electrical components and wire channels.

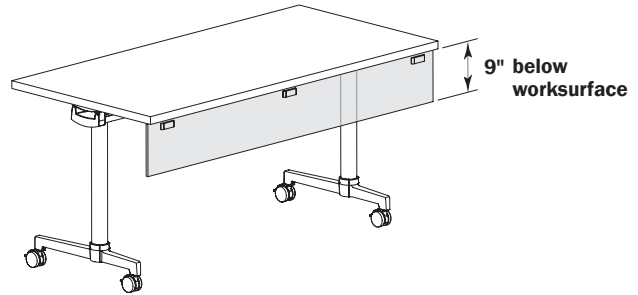
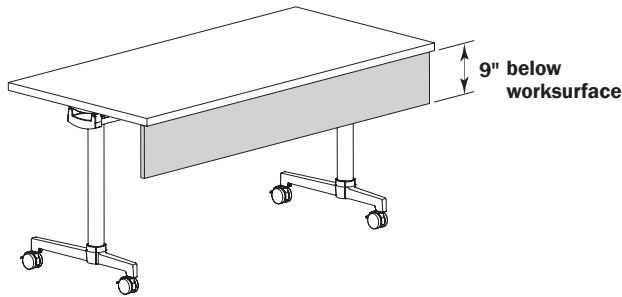

Laminate

- 3/4" thick
- 21 standard TFL or Tier 1 HPL with matching PVC edge
- additional graded in laminates, select from standard PVC edges
- supported with concealed hinge or support brackets
- 5/8" space provided between top edge of modesty panel and bottom surface of top to route electrical wires from top of table to under side

Frosted Acrylic

- 1/4" two sided frosted acrylic
- acrylic panels supported with hinge or bracket with powder-coated cover plate to conceal support hardware
- 5/8" space provided between top edge of modesty panel and bottom surface of top to route electrical wires from top of table to under side
- specify trim cap Aged Bronze, Arctic Silver, Gold, Pewter, Matte Black, Soft Bronze, Soft Nickel

3 Attachment Methods

Acrylic and laminate modesty panels can be specified with 3 different attachment methods. Select from Hinged, Removable, or Fixed - see pages 70-72.

1 Hinged Modesty Panels with Tilt Table Option

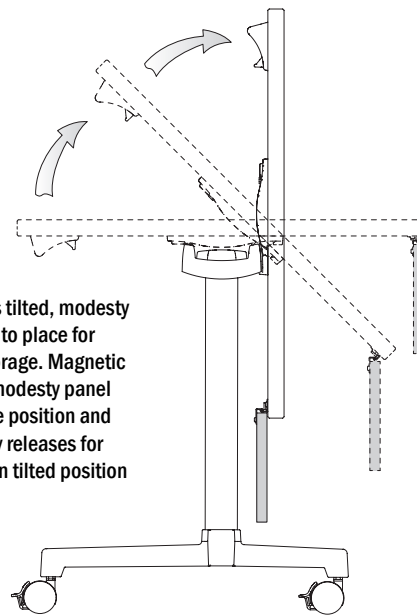
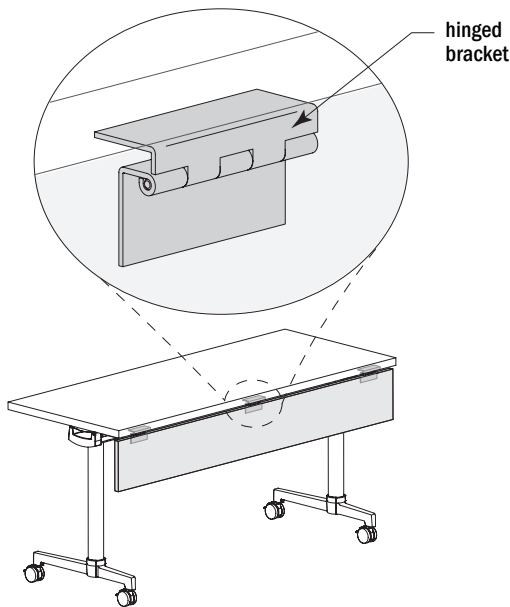

When table is tilted, modesty panel folds into place for organized storage. Magnetic hinge holds modesty panel vertical in use position and automatically releases for self-storage in tilted position

Hinged Modesty Panels allows for table nesting

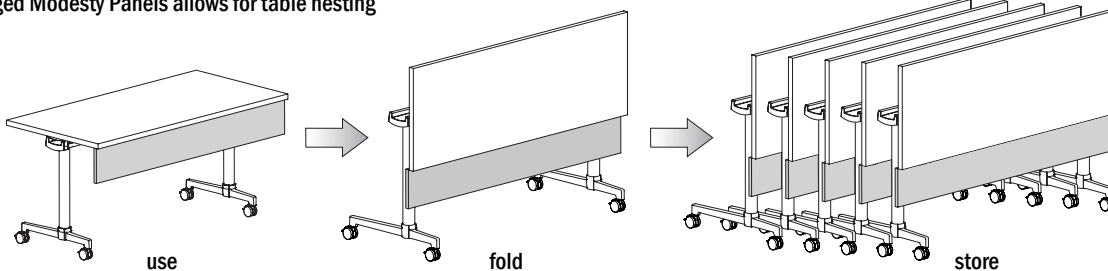

Training - Modesty Panel Attachment Methods

2 Removable Modesty Panels with Tilt Table Option

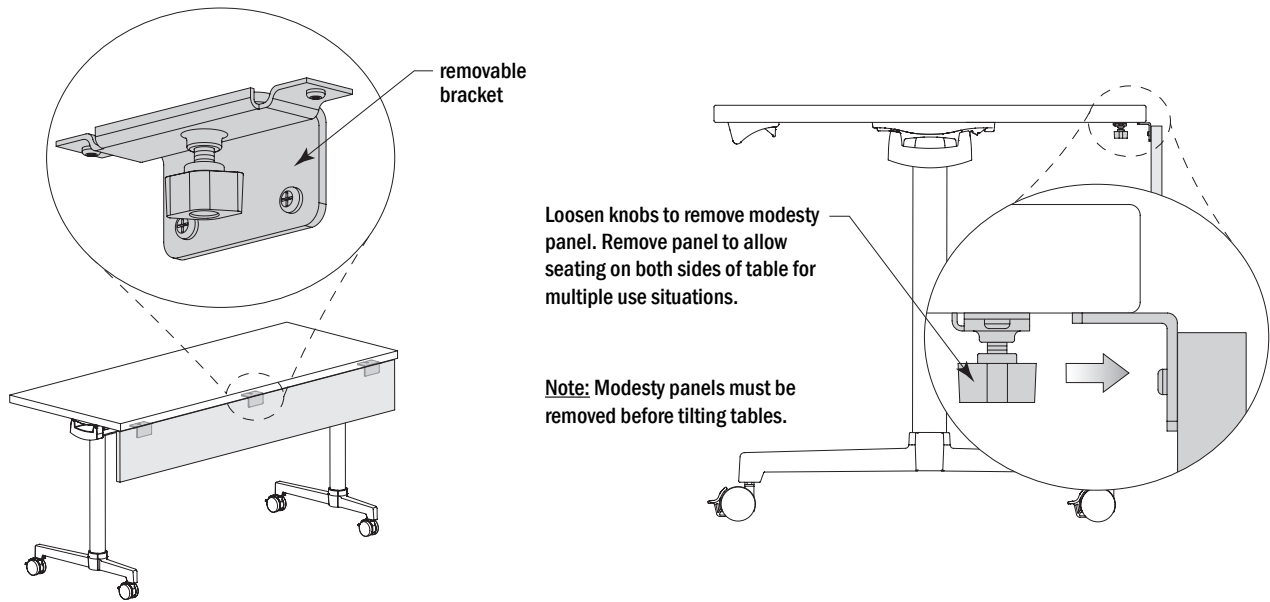

Removable modesty panels allows for single and dual users and storage

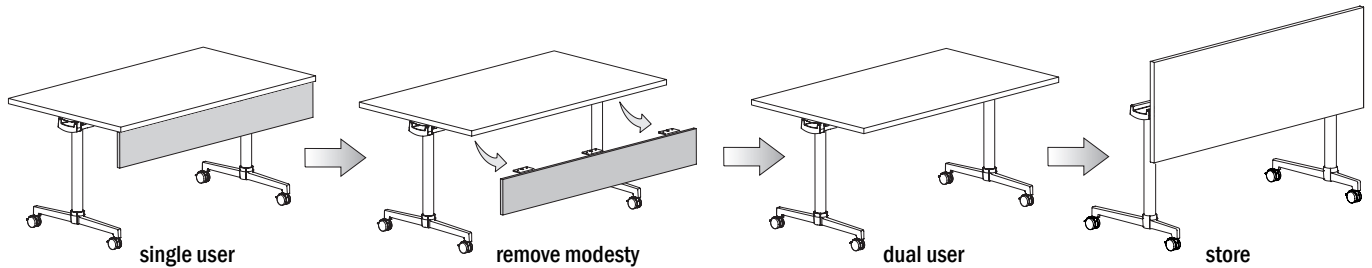

3 Fixed Modesty Panels

Fixed modesty panels are intended to always be attached and should not be specified in conjunction with tilt top tables.

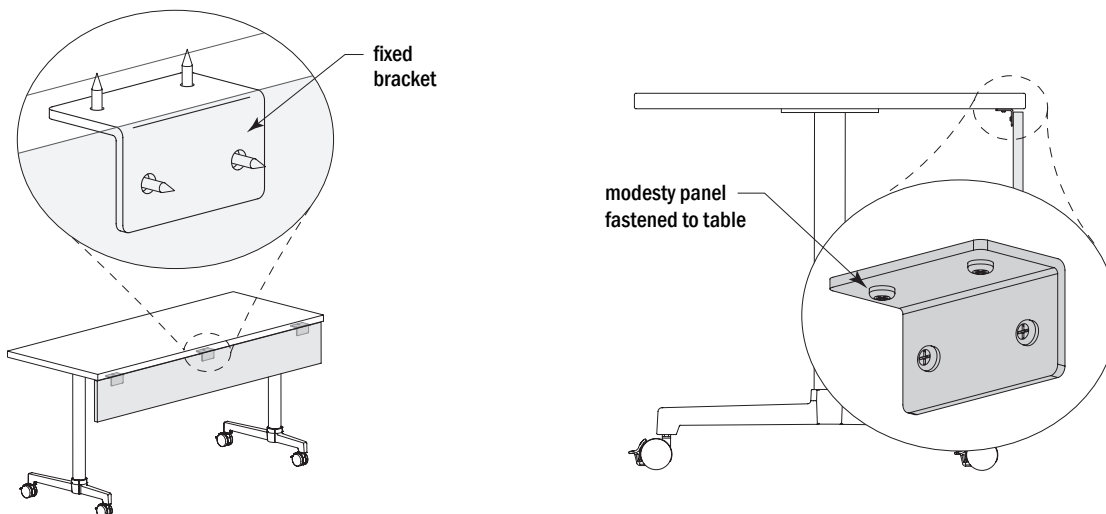

Training - Screens

Portable Slide-On Divider Screen

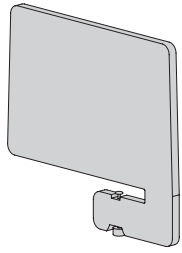

Portable divider panel divides space between seats and acoustic materials muffles sound in high traffic areas

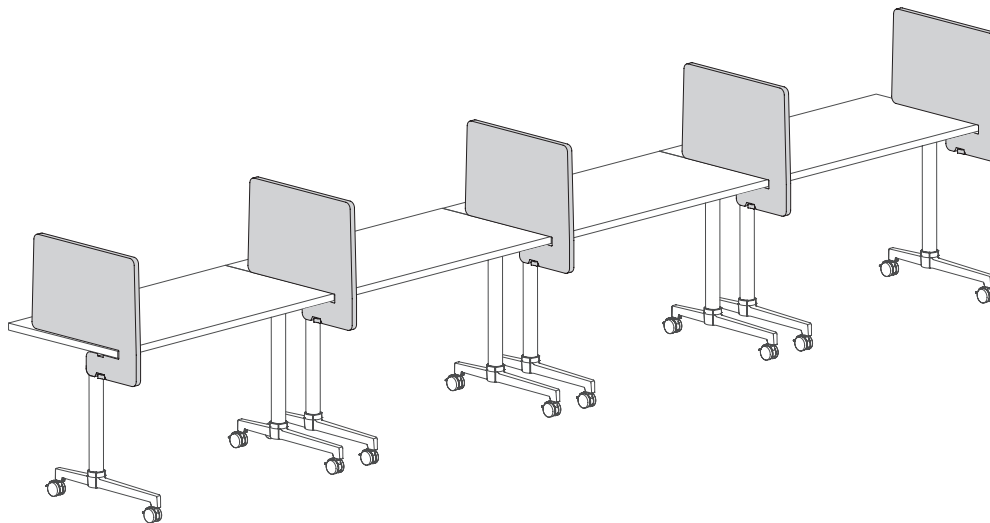
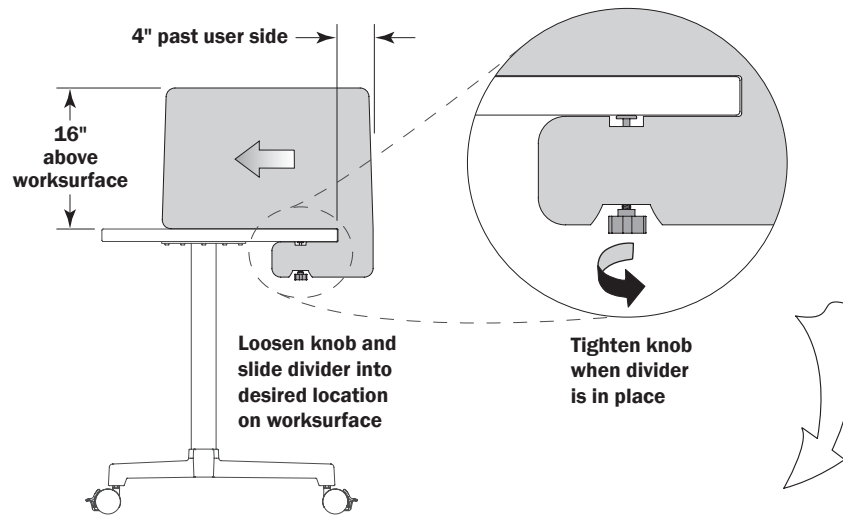

Acoustic

- screen provides 16" above and 4" user side concealment
- 1" tackable acoustic 100% polyester screens in silver or ash grey
 - acoustic rating: 0.45 - 0.90 NRC
 - fire rating: ASTM-E84 / class A
 - colorfastness to light: AACC 16.3 option 3 color change @ 20AFU = 4.5
 - vacuum to remove dust, remove spills immediately using a clean damp cloth or with soap and water
 - carpet or fabric cleaner can be used for difficult spills - always test on an inconspicuous area first
- easily repositioned by user to divide space or as end of table privacy
- can be secured to any surface 1 ¼" - 1 ½" thickness and 20" or greater depth
- knob on underside of table temporarily clamps screen in position for easy repositioning

HPL

- particle board core
- HPL laminate surfaces - JSI standards
- matching PVC edge

Markerboard

- plywood core
- white marker HPL surfaces
- white PVC edge

Magnetic Markerboard

- plywood core
- white magnetic marker HPL surfaces
- white PVC edge

Training - Screens

Privacy Panel Screens

Full width panel to provide user privacy concealing electrical components, wire channels and equipment on table top. Screens provide 8 1/2" below and 14" above top concealment

Privacy Panel

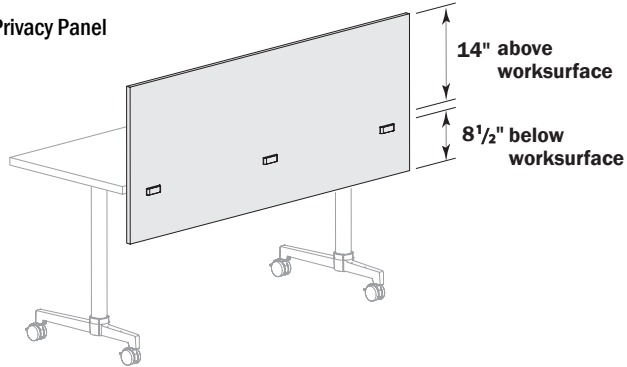

Privacy Acrylic Panel

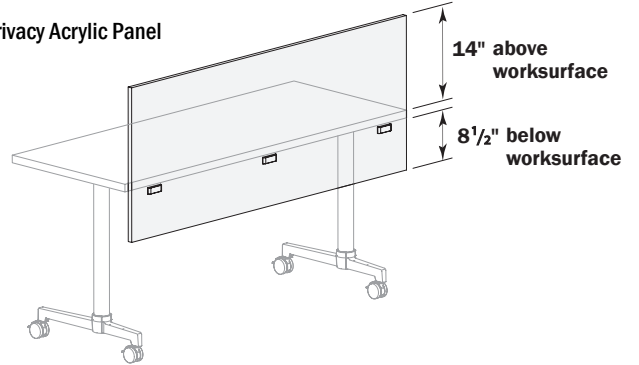

Acoustic

- 1/2" tackable acoustic 100% polyester screens in silver or ash grey
 - acoustic rating: 0.45 - 0.90 NRC
 - fire rating: ASTM-E84 / class A
 - colorfastness to light: AACC 16.3 option 3 color change @ 20AFU = 4.5
 - vacuum to remove dust, remove spills immediately using a clean damp cloth or with soap and water
 - carpet or fabric cleaner can be used for difficult spills - always test on an inconspicuous area first

Acrylic

- 1/4" two sided frosted acrylic

Privacy Panel Colors

ASH	Ash Grey
SIL	Silver Grey

Screen Mounting

- screens supported by brackets with powder coated cover plates fastened to underside of top
- mounting brackets can be fastened out for routing cables to underside of top or to install monitor arm
- screens available for approach and end of table applications
- linking kits available for shared privacy screen application between two tables approach or end applications
- screens must be removed before tilting

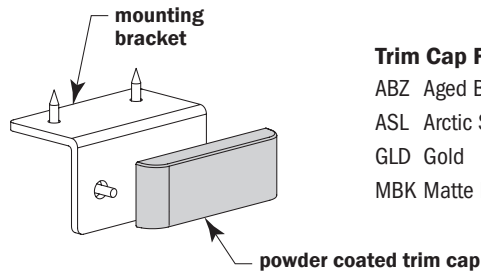

Trim Cap Finishes

- ABZ Aged Bronze
- ASL Arctic Silver
- GLD Gold
- MBK Matte Black
- PEW Pewter
- SBZ Soft Bronze
- SNK Soft Nickel

Training - Electrical - LINK System

Overview

LINK has in-surface 110 power with USB A charging. Non-direction/non-sequential power cables plug together with red, green, white and black terminal connections. Configure with single or dual circuit units to maximize power flexibility. LINK provides three power infeed models; NEMA 15amp or 20amp three prong plug single circuit, quick disconnect or hardwire to support single or dual circuit applications.

- two 110 power and dual USB type A charging
- Metal unit - black or white color selection
- Non-directional/non-sequential power
- Three building power connection infeed models to select from
- Up to eight duplex devices per infeed circuit

Components included when LINK Power selected:

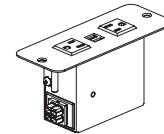

Top Unit x 1

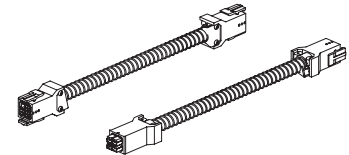

Jumper x 2

- 1 - female to female
- 1 - female to male

Above quantity shows when C (Center) is specified.

When L (Left) / R (Right) are specified, the quantity is double.
Top Unit x 2 and Jumper x 3

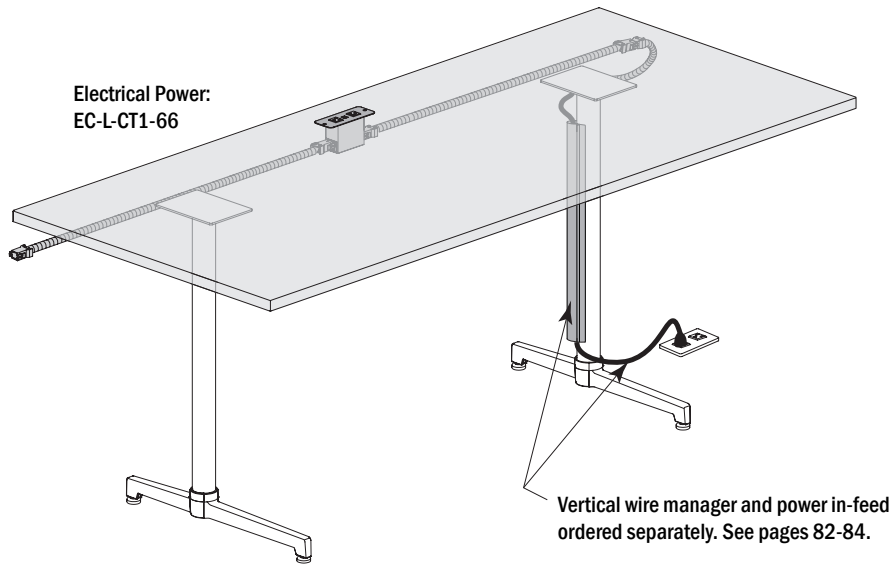

Electrical

Power Packages are measured and located out from the center of the table. Shown on rectangular tops, these dimensions are the same from center regardless of table shape. Power in-feed is specified separately to support building electrical connection.

LINK Components:

Ganged Tables	Power In-Feed	Power Centers	Jumpers
48" - 96" Tables - CT1			
8	1	8	16
7	1	7	14
6	1	6	12
5	1	5	10
4	1	4	8
3	1	3	6
2	1	2	4
1	1	1	2
66" - 96" Tables - LRT2			
4	1	8	12
3	1	6	9
2	1	4	6
1	1	2	3

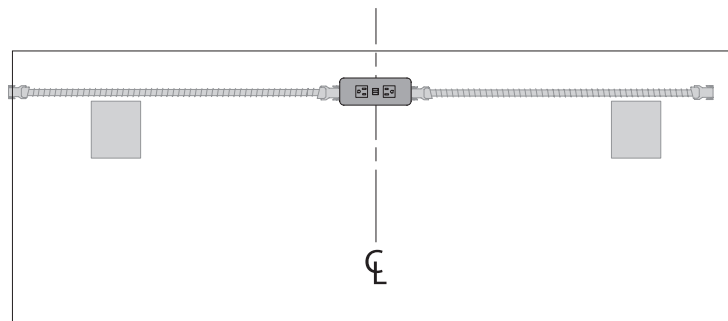

L-CT1-C0 - Single Power in Center Location on top cutout locations

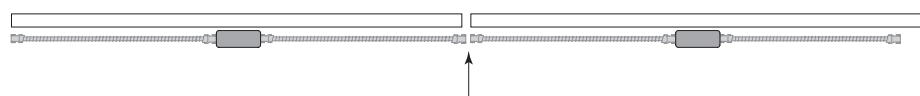

Jumper connection at edge of tables.

Training - Electrical - ECONO System

Overview

ECONO electrical system allows up to eight duplex power modules to be daisy-chained together (non-direction/non-sequential) and powered from a single power in-feed. The number of power modules connected is limited to the maximum allowed under UL Standard 962. If too many are connected, the control module disconnects all power to the system and signals red. Power is restored to the system after the extra power module(s) are disconnected, which is indicated by a green light. Econo will not work with GFI or GFCI - Ground Fault Circuit Interrupter Wall or Floor Outlets.

- Two 110 power and two data openings
- Single circuit power with 12 amp total system
- Plastic unit with retractable lid - black or grey color selection
- Over-current protection
- Up to eight duplex devices per infeed

Electrical Power
EC-E-CT1-66

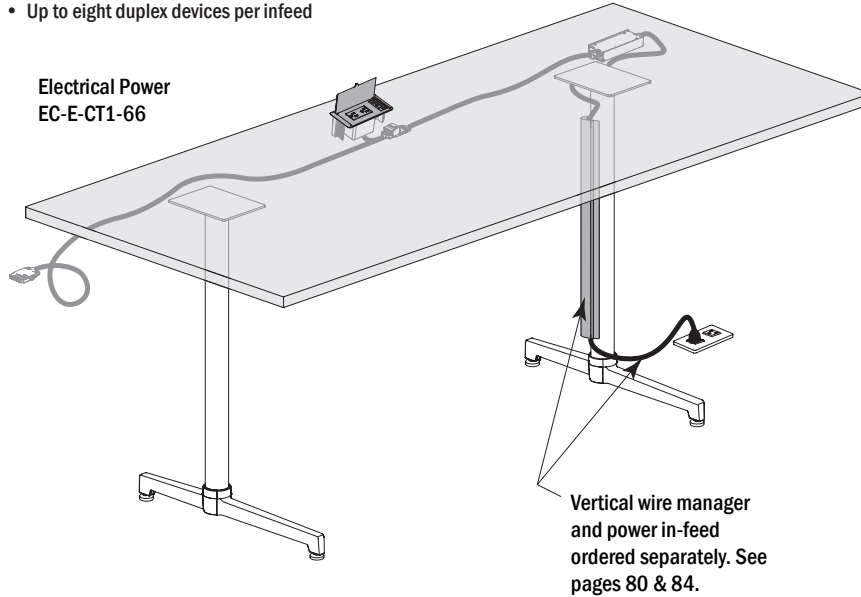

Components included when ECONO Power selected:

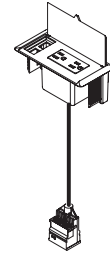

Top Unit x 1



Jumper x 1

Above quantity shows when C (Center) is specified.

When L (Left) / R (Right) are specified, the quantity is double.
Top Unit x 2 and Jumper x 2

Electrical

Power is measured and located out from the center of the table. Shown on rectangular tops, these dimensions are the same from center regardless of table shape. Power in-feed is specified separately to support building electrical connection.

ECONO Components:

Ganged Tables	Power In-Feed	Power Centers	Jumpers
---------------	---------------	---------------	---------

48" - 96" Tables - CT1

8	1	8	8
7	1	7	7
6	1	6	6
5	1	5	5
4	1	4	4
3	1	3	3
2	1	2	2
1	1	1	1

66" - 96" Tables - LRT2

4	1	8	8
3	1	6	6
2	1	4	4
1	1	2	2

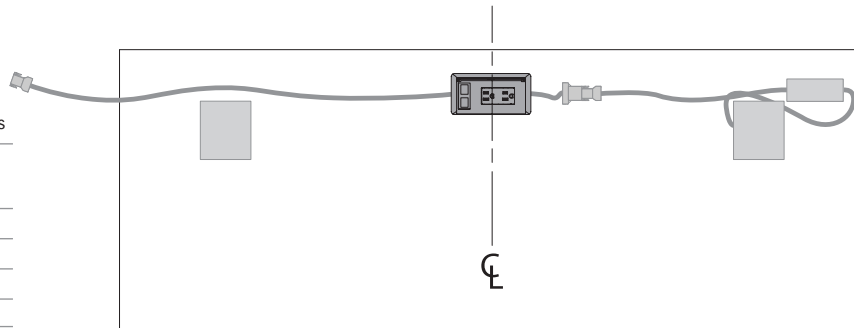

E-CT1-CO - Single Power in Center Location on top cutout locations

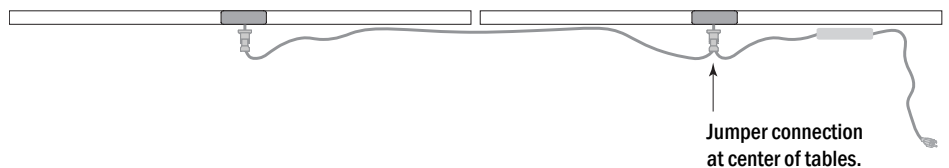

Training - Cantilever Tilt Specifying

Overview

Lok Training was created with the simple a la carte, select of top, base, electrical, and screens. Pages with tops list all the necessary details to determine your budget with page references to guide you to the detail selections, including all the available options, colors and finishes. Build it your way in 5 easy steps!

1. Specify Top

- a. power cut out (optional)
- b. link (optional)

2. Specify Base

3. Specify Modesty Panel

- a. (optional)

4. Specify Electrical

- a. (optional) - not shown below

5. Specify Accessories

- a. (optional) - not shown below

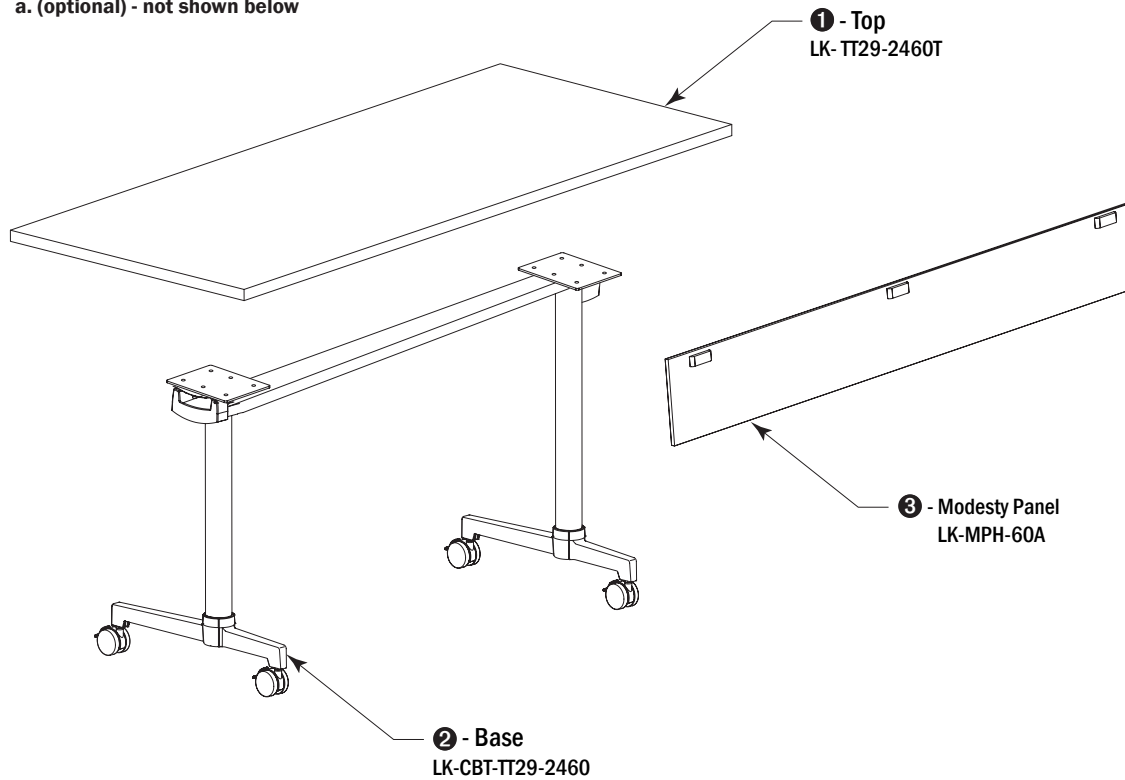

Model Number Breakdown

1 - Top

LK-TT29-2460T

LK	TT	29	2460	T	
Lok Designator	Top Shape - Rectangular	Table Height - 29"	Top Size - 24" x 60"	Top Material - Laminate	

2 - Base

LK-CBT-TT29-2460

LK	CBT	TT	29	2460	
Lok Designator	Base Type - Cantilever T-Base Tilt (with casters option)	29" Table Height	Table Height - 29"	Top Size - 24" x 60"	

3 - Modesty Panel

LK-MPH-60A

LK	MP	H	60	A	
Lok Designator	Panel Type - Modesty	Function - Hinged	Panel Size - 60"	Panel Material - Frosted Acrylic	

Training - Fixed T Specifying

Overview

Lok Training table offer the many configurations and room layouts to support todays diverse learning environments. When planning a space, select the size and shape tops that best fit the space you are planning. Then select the base type that supports the function the space requires, static setting with T-Base and glides, additional knee space with cantilever T-base, easy reconfiguration by adding casters, compact storage with offset or inline tilt/nest, special height considerations with pin height adjustment.

1. Specify Top
 - a. power cut out (optional)
 - b. link (optional)
2. Specify Base
3. Specify Modesty Panel
 - a. (optional)
4. Specify Electrical
 - a. (optional) - not shown below
5. Specify Accessories
 - a. (optional) - not shown below

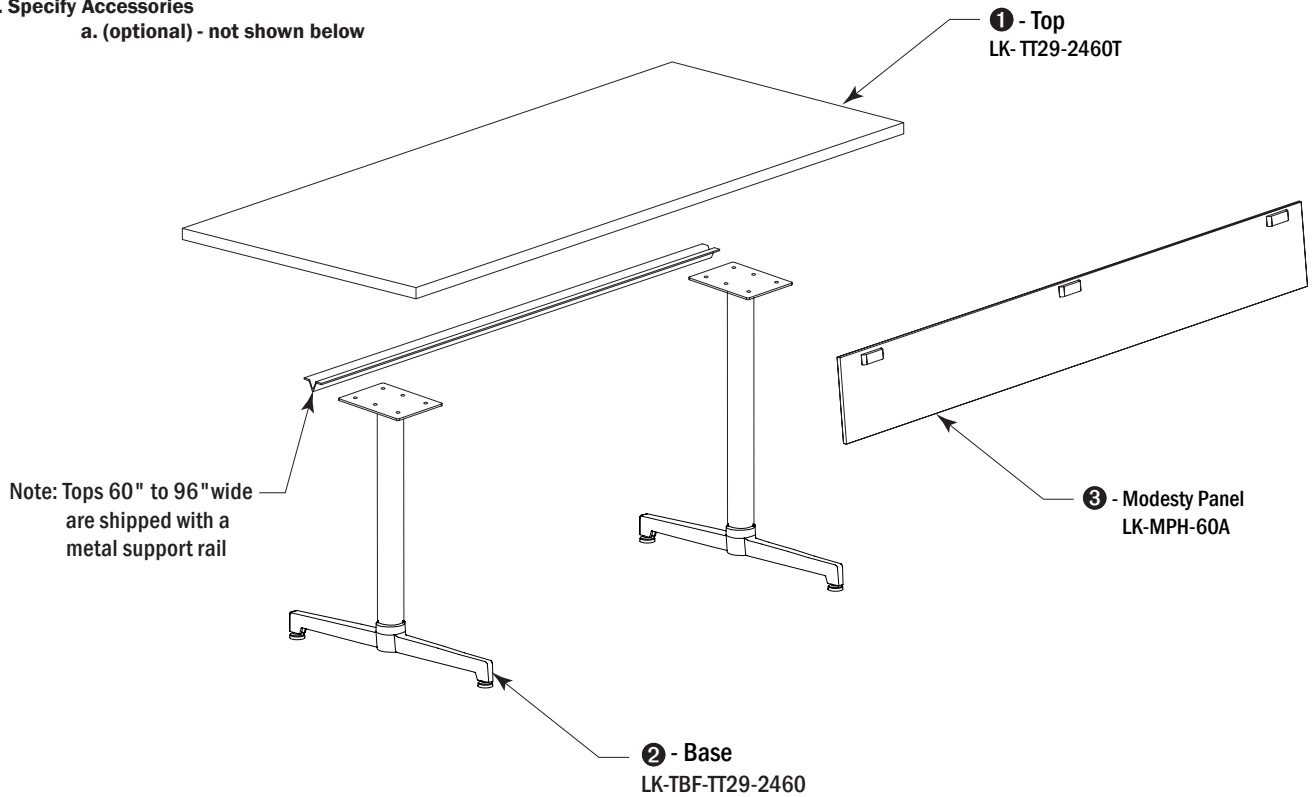

Model Number Breakdown

1 - Top

LK-TT29-2460T					
LK	TT	29	2460	T	
Lok Designator	Top Shape - Rectangular	Table Height - 29"	Top Size - 24" x 60"	Top Material - Laminate	

2 - Base

LK-TBF-TT29-2460					
LK	TBF	TT	29	2460	
Lok Designator	Base Type - Fixed T-Base (standard with glides)	29" Table Height	Table Height - 29"	Top Size - 24" x 60"	

3 - Modesty Panel

LK-MPH-60A					
LK	MP	H	60	A	
Lok Designator	Panel Type - Modesty	Function - Hinged	Panel Size - 60"	Panel Material - Frosted Acrylic	

Description

Rectangular Training Top

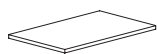

top shape

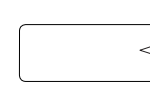

Eased Edge (R3)

D	W	H	CTN WT	CU FT	① Model	TFL	Standard	Graded In
							HPL 1	HPL 2
20	36	29	22	2	LK-TT29-2036T	\$257	\$346	\$361
24	36	29	26	2	LK-TT29-2436T	\$290	\$370	\$390
30	36	29	33	3	LK-TT29-3036T	\$302	\$411	\$434
20	48	29	29	2	LK-TT29-2048T	\$290	\$399	\$418
24	48	29	35	3	LK-TT29-2448T	\$329	\$433	\$457
30	48	29	43	3	LK-TT29-3048T	\$346	\$486	\$517

LAMINATE
LOK - TRAINING

Table Components: (order separately)

- base, modesty panel, electrical, and privacy screens sold and ship separately
- specify power option, see below
- optional set of (2) linking bracket, specify and add an additional \$62 list

Electrical Options/Cutout Locations:

- specify power cutout and indicate if Link or Econo System will be used
- reference drawing below for approximate location

CT1 : Single Power Center Top Cutout Location

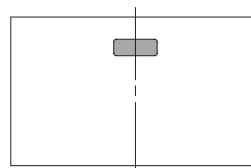

(36"- 48" wide)

To Order Specify

① Model #	②a Laminate Selection	②b PVC Edge Color	③ Electrical
Model (LK)	See Laminate Selection	See PVC Edge Color Options	N None L-CT1-CO Link System - Center Top Single Power Cutout E-CT1-CO Econo System - Center Top Single Power Cutout

Model Number Breakdown

LK-TT29-2036T					
LK	TT	29	2036	T	
LOK	Rectangular Top Shape	Height	20" x 36"	Laminate	

Training Table Bases

Select base preference below to go with corresponding Top. **Note:** Base depth and width must match Top depth (D) and width (W).

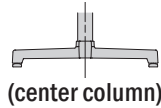

T-Bases

(center column)

Fixed

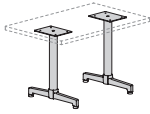

T-Base Fixed

Width	Model	List Price
36"	LK-TBF-TT29-2036	+\$501
	LK-TBF-TT29-2436	+\$529
	LK-TBF-TT29-3036	+\$562
48"	LK-TBF-TT29-2048	+\$501
	LK-TBF-TT29-2448	+\$529
	LK-TBF-TT29-3048	+\$562

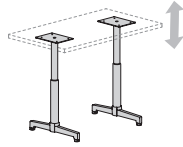

T-Base Adjustable

Width	Model	List Price
36"	LK-TBA-TT29-2036	+\$616
	LK-TBA-TT29-2436	+\$645
	LK-TBA-TT29-3036	+\$676
48"	LK-TBA-TT29-2048	+\$616
	LK-TBA-TT29-2448	+\$645
	LK-TBA-TT29-3048	+\$676

Tilt

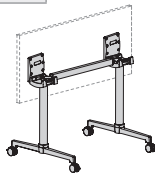

T-Base Tilt

Width	Model	List Price
36"	LK-TBT-TT29-2036	+\$876
	LK-TBT-TT29-2436	+\$904
	LK-TBT-TT29-3036	+\$938
48"	LK-TBT-TT29-2048	+\$1,003
	LK-TBT-TT29-2448	+\$1,030
	LK-TBT-TT29-3048	+\$1,064

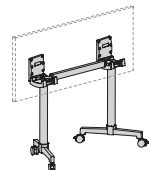

Inline T-Base

Width	Model	List Price
48"	LK-IBT-TT29-2048	+\$919
	LK-IBT-TT29-2448	+\$919

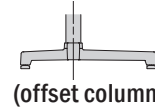

Cantilever T-Bases

(offset column)

Fixed

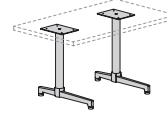

Cantilever T-Base Fixed

Width	Model	List Price
36"	LK-CBF-TT29-2036	+\$517
	LK-CBF-TT29-2436	+\$531
	LK-CBF-TT29-3036	+\$559
48"	LK-CBF-TT29-2048	+\$517
	LK-CBF-TT29-2448	+\$531
	LK-CBF-TT29-3048	+\$559

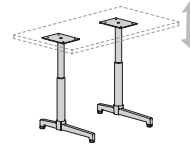

Cantilever T-Base Adj.

Width	Model	List Price
36"	LK-CBA-TT29-2036	+\$631
	LK-CBA-TT29-2436	+\$647
	LK-CBA-TT29-3036	+\$673
48"	LK-CBA-TT29-2048	+\$631
	LK-CBA-TT29-2448	+\$647
	LK-CBA-TT29-3048	+\$673

Tilt

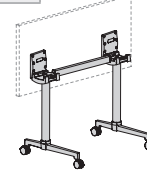

Cantilever T-Base Tilt

Width	Model	List Price
36"	LK-CBT-TT29-2036	+\$906
	LK-CBT-TT29-2436	+\$921
	LK-CBT-TT29-3036	+\$949
48"	LK-CBT-TT29-2048	+\$1,033
	LK-CBT-TT29-2448	+\$1,048
	LK-CBT-TT29-3048	+\$1,075

See pages 6-7 for additional information on Lok Bases.

See pages 38-44 on how to order/specify Lok Bases for Rectangular Tops, including caster color options.

Training Table Modesty Panels

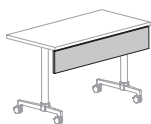

Fixed Modesty

Material	Model	Standard List	Graded In HPL 2
Acrylic	LK-MPF-36A	+\$319	--
	LK-MPF-48A	+\$357	--
TFL	LK-MPF-36T	+\$171	--
	LK-MPF-48T	+\$180	--
HPL	LK-MPF-36H	+\$250	+\$259
	LK-MPF-48H	+\$265	+\$277

Note: Fixed modesty panels are intended to always be attached to top and should not be specified in conjunction with Tilt T-Bases.

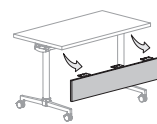

Removable Modesty

Material	Model	Standard List	Graded In HPL 2
Acrylic	LK-MPR-36A	+\$358	--
	LK-MPR-48A	+\$395	--
TFL	LK-MPR-36T	+\$210	--
	LK-MPR-48T	+\$218	--
HPL	LK-MPR-36H	+\$288	+\$298
	LK-MPR-48H	+\$304	+\$316

Note: Removable modesty panels when used with Tilt T-bases must be removed before tilting table.

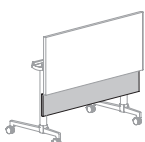

Hinged Modesty

Material	Model	Standard List	Graded In HPL 2
Acrylic	LK-MPH-36A	+\$340	--
	LK-MPH-48A	+\$392	--
TFL	LK-MPH-36T	+\$209	--
	LK-MPH-48T	+\$217	--
HPL	LK-MPH-36H	+\$287	+\$296
	LK-MPH-48H	+\$303	+\$315

Note: Hinged modesty panels are intended to be used with Tilt T-Bases for tilting and table nesting. Not to be specified with Fixed T-Bases.

See pages 8-9 for additional information on Lok Modesty Panels.

See pages 64-66 on how to order/specify Lok Modesty Panels.

Description

Rectangular Training Top



top shape

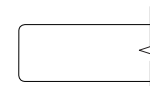

Eased Edge (R3)

D	W	H	CTN WT	CU FT	① Model	TFL	Standard	Graded In
							HPL 1	HPL 2
20	60	29	36	3	LK-TT29-2060T	\$319	\$445	\$470
24	60	29	43	3	LK-TT29-2460T	\$369	\$487	\$519
30	60	29	54	4	LK-TT29-3060T	\$389	\$554	\$589
20	66	29	39	3	LK-TT29-2066T	\$367	\$471	\$498
24	66	29	47	4	LK-TT29-2466T	\$441	\$521	\$556
30	66	29	60	5	LK-TT29-3066T	\$464	\$601	\$642
20	72	29	43	3	LK-TT29-2072T	\$388	\$497	\$528
24	72	29	52	4	LK-TT29-2472T	\$461	\$547	\$585
30	72	29	65	5	LK-TT29-3072T	\$486	\$630	\$673

Table Components: (order separately)

- base, modesty panel, electrical, and privacy screens sold and ship separately
- specify power option, see below
- optional set of (2) linking bracket, specify and add an additional \$62 list

Electrical Options/Cutout Locations:

- specify power cutout and indicate if Link or Econo System will be used
- reference drawing below for approximate location

CT1 : Single Power Center Top Cutout Location

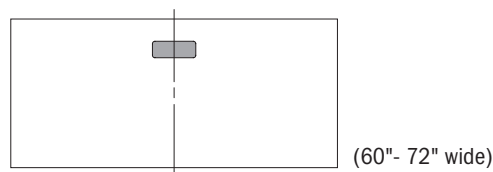

LRT2 : Dual Power Left/Right Top Cutout Location

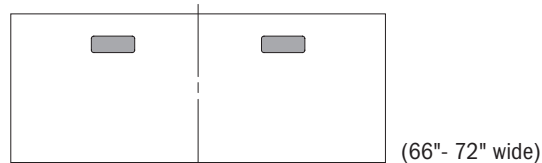

To Order Specify

① Model #	②a Laminate Selection	②b PVC Edge Color	③ Electrical
Model (LK)	See Laminate Selection	See PVC Edge Color Options	N None L-CT1-CO Link System - Center Top Single Power Cutout E-CT1-CO Econo System - Center Top Single Power Cutout L-LRT2-CO Link System - Left/Right Top Dual Power Cutout E-LRT2-CO Econo System - Left/Right Top Dual Power Cutout

Model Number Breakdown

LK-TT29-2060T					
LK	TT	29	2060	T	
LOK	Rectangular Top Shape	Height	20" x 60"	Laminate	

Training Table Bases

Select base preference below to go with corresponding Top. **Note:** Base depth and width must match Top depth (D) and width (W).

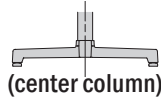

T-Bases
(center column)

Fixed	Width	Model	List Price
 T-Base Fixed	60"	LK-TBF-TT29-2060	+\$560
		LK-TBF-TT29-2460	+\$586
		LK-TBF-TT29-3060	+\$618
	66"	LK-TBF-TT29-2066	+\$560
		LK-TBF-TT29-2466	+\$586
		LK-TBF-TT29-3066	+\$618
	72"	LK-TBF-TT29-2072	+\$569
		LK-TBF-TT29-2472	+\$597
		LK-TBF-TT29-3072	+\$630

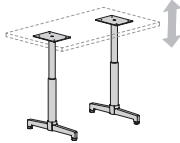

T-Base Adjustable

Width	Model	List Price
60"	LK-TBA-TT29-2060	+\$674
	LK-TBA-TT29-2460	+\$701
	LK-TBA-TT29-3060	+\$735
66"	LK-TBA-TT29-2066	+\$674
	LK-TBA-TT29-2466	+\$701
	LK-TBA-TT29-3066	+\$735
72"	LK-TBA-TT29-2072	+\$684
	LK-TBA-TT29-2472	+\$712
	LK-TBA-TT29-3072	+\$745

Tilt

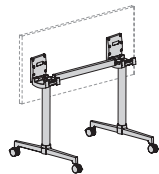

T-Base Tilt

Width	Model	List Price
60"	LK-TBT-TT29-2060	+\$1,019
	LK-TBT-TT29-2460	+\$1,046
	LK-TBT-TT29-3060	+\$1,078
66"	LK-TBT-TT29-2066	+\$1,019
	LK-TBT-TT29-2466	+\$1,046
	LK-TBT-TT29-3066	+\$1,078
72"	LK-TBT-TT29-2072	+\$1,048
	LK-TBT-TT29-2472	+\$1,077
	LK-TBT-TT29-3072	+\$1,109

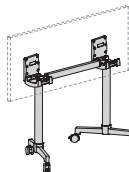

Inline T-Base

Width	Model	List Price
60"	LK-IBT-TT29-2060	+\$1,046
	LK-IBT-TT29-2460	+\$1,046
66"	LK-IBT-TT29-2066	+\$1,046
	LK-IBT-TT29-2466	+\$1,046
72"	LK-IBT-TT29-2072	+\$1,062
	LK-IBT-TT29-2472	+\$1,062

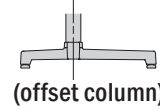

Cantilever T-Bases
(offset column)

Fixed	Width	Model	List Price
 Cantilever T-Base Fixed	60"	LK-CBF-TT29-2060	+\$572
		LK-CBF-TT29-2460	+\$588
		LK-CBF-TT29-3060	+\$616
	66"	LK-CBF-TT29-2066	+\$572
		LK-CBF-TT29-2466	+\$588
		LK-CBF-TT29-3066	+\$616
	72"	LK-CBF-TT29-2072	+\$583
		LK-CBF-TT29-2472	+\$600
		LK-CBF-TT29-3072	+\$626

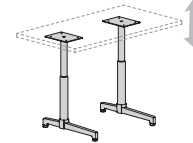

Cantilever T-Base Adj.

Width	Model	List Price
60"	LK-CBA-TT29-2060	+\$689
	LK-CBA-TT29-2460	+\$703
	LK-CBA-TT29-3060	+\$733
66"	LK-CBA-TT29-2066	+\$689
	LK-CBA-TT29-2466	+\$703
	LK-CBA-TT29-3066	+\$733
72"	LK-CBA-TT29-2072	+\$699
	LK-CBA-TT29-2472	+\$714
	LK-CBA-TT29-3072	+\$741

Tilt

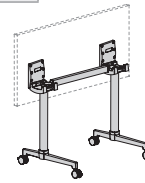

Cantilever T-Base Tilt

Width	Model	List Price
60"	LK-CBT-TT29-2060	+\$1,047
	LK-CBT-TT29-2460	+\$1,064
	LK-CBT-TT29-3060	+\$1,091
66"	LK-CBT-TT29-2066	+\$1,047
	LK-CBT-TT29-2466	+\$1,064
	LK-CBT-TT29-3066	+\$1,091
72"	LK-CBT-TT29-2072	+\$1,078
	LK-CBT-TT29-2472	+\$1,093
	LK-CBT-TT29-3072	+\$1,121

See pages 6-7 for additional information on Lok Bases.

See pages 38-44 on how to order/specify Lok Bases for Rectangular Tops, including caster color options.

Training Table Modesty Panels

 Fixed Modesty	Material	Model	Standard List	Graded In HPL 2	Graded In HPL 3
	Acrylic	LK-MPF-60A	+\$437	--	--
LK-MPF-66A		+\$467	--	--	
LK-MPF-72A		+\$493	--	--	
TFL	LK-MPF-60T	+\$202	--	--	
	LK-MPF-66T	+\$208	--	--	
	LK-MPF-72T	+\$211	--	--	
HPL	LK-MPF-60H	+\$299	+\$313	+\$396	
	LK-MPF-66H	+\$307	+\$323	+\$416	
	LK-MPF-72H	+\$317	+\$331	+\$434	

Note: Fixed modesty panels are intended to always be attached to top and should not be specified in conjunction with Tilt T-Bases.

 Removable Modesty	Material	Model	Standard List	Graded In HPL 2
	Acrylic	LK-MPR-60A	+\$495	--
LK-MPR-66A		+\$525	--	--
LK-MPR-72A		+\$549	--	--
TFL	LK-MPR-60T	+\$261	--	--
	LK-MPR-66T	+\$265	--	--
	LK-MPR-72T	+\$269	--	--
HPL	LK-MPR-60H	+\$357	+\$369	--
	LK-MPR-66H	+\$365	+\$381	--
	LK-MPR-72H	+\$374	+\$391	--

Note: Removable modesty panels when used with Tilt T-bases must be removed before tilting table.

See pages 8-9 for additional information on Lok Modesty Panels.

See pages 64-66 on how to order/specify Lok Modesty Panels.

 Hinged Modesty	Material	Model	Standard List	Graded In HPL 2
	Acrylic	LK-MPH-60A	+\$490	--
LK-MPH-66A		+\$523	--	--
LK-MPH-72A		+\$544	--	--
TFL	LK-MPH-60T	+\$252	--	--
	LK-MPH-66T	+\$257	--	--
	LK-MPH-72T	+\$261	--	--
HPL	LK-MPH-60H	+\$349	+\$362	--
	LK-MPH-66H	+\$358	+\$371	--
	LK-MPH-72H	+\$366	+\$383	--

Note: Hinged modesty panels are intended to be used with Tilt T-Bases for tilting and table nesting. Not to be specified with Fixed T-Bases.

Description

Rectangular Training Top



top shape

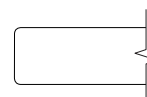

Eased Edge (R3)

D	W	H	CTN WT	CU FT	① Model	TFL	Standard	Graded In
							HPL 1	HPL 2
20	84	29	51	4	LK-TT29-2084T	\$412	\$554	\$588
24	84	29	61	4	LK-TT29-2484T	\$486	\$610	\$652
30	84	29	76	5	LK-TT29-3084T	\$507	\$697	\$748
20	96	29	58	4	LK-TT29-2096T	\$429	\$601	\$640
24	96	29	69	5	LK-TT29-2496T	\$504	\$667	\$713
30	96	29	86	6	LK-TT29-3096T	\$529	\$765	\$824

LAMINATE
LOK - TRAINING

Table Components: (order separately)

- base, modesty panel, electrical, and privacy screens sold and ship separately
- specify power option, see below
- optional set of (2) linking bracket, specify and add an additional \$62 list

Electrical Options/Cutout Locations:

- specify power cutout and indicate if Link or Econo System will be used
- reference drawing below for approximate location

CT1 : Single Power Center Top Cutout Location

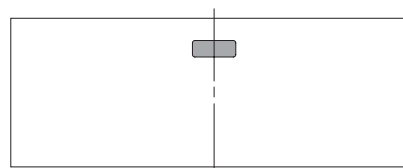

(84" - 96" wide)

LRT2 : Dual Power Left/Right Top Cutout Location

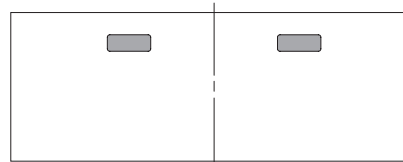

(84" - 96" wide)

To Order Specify

① Model #	②a Laminate Selection	②b PVC Edge Color	③ Electrical
Model (LK)	See Laminate Selection	See PVC Edge Color Options	N None L-CT1-CO Link System - Center Top Single Power Cutout E-CT1-CO Econo System - Center Top Single Power Cutout L-LRT2-CO Link System - Left/Right Top Dual Power Cutout E-LRT2-CO Econo System - Left/Right Top Dual Power Cutout

Model Number Breakdown

LK-TT29-2084T					
LK	TT	29	2084	T	
LOK	Rectangular Top Shape	Height	20" x 84"	Laminate	

Training Table Bases

Select base preference below to go with corresponding Top. Note: Base depth and width must match Top depth (D) and width (W).

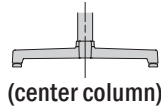

T-Bases

Fixed	Width	Model	List Price
<p>T-Base Fixed</p>	84"	LK-TBF-TT29-2084	+\$569
		LK-TBF-TT29-2484	+\$597
		LK-TBF-TT29-3084	+\$630
	96"	LK-TBF-TT29-2096	+\$588
		LK-TBF-TT29-2496	+\$616
		LK-TBF-TT29-3096	+\$649

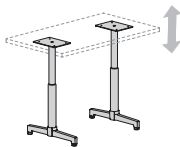

T-Base Adjustable

Width	Model	List Price
84"	LK-TBA-TT29-2084	+\$684
	LK-TBA-TT29-2484	+\$712
	LK-TBA-TT29-3084	+\$745
96"	LK-TBA-TT29-2096	+\$703
	LK-TBA-TT29-2496	+\$733
	LK-TBA-TT29-3096	+\$765

Tilt

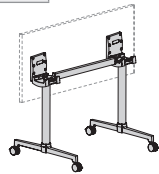

T-Base Tilt

Width	Model	List Price
84"	LK-TBT-TT29-2084	+\$1,048
	LK-TBT-TT29-2484	+\$1,077
	LK-TBT-TT29-3084	+\$1,109
96"	LK-TBT-TT29-2096	+\$1,106
	LK-TBT-TT29-2496	+\$1,133
	LK-TBT-TT29-3096	+\$1,164

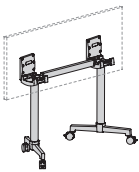

Inline T-Base

Width	Model	List Price
84"	LK-IBT-TT29-2084	+\$1,092
	LK-IBT-TT29-2484	+\$1,092
96"	LK-IBT-TT29-2096	+\$1,149
	LK-IBT-TT29-2496	+\$1,149

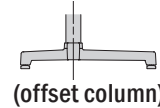

Cantilever T-Bases

Fixed	Width	Model	List Price
<p>Cantilever T-Base Fixed</p>	84"	LK-CBF-TT29-2084	+\$583
		LK-CBF-TT29-2484	+\$600
		LK-CBF-TT29-3084	+\$626
	96"	LK-CBF-TT29-2096	+\$604
		LK-CBF-TT29-2496	+\$618
		LK-CBF-TT29-3096	+\$646

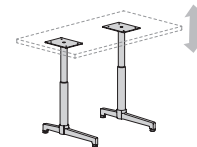

Cantilever T-Base Adj.

Width	Model	List Price
84"	LK-CBA-TT29-2084	+\$699
	LK-CBA-TT29-2484	+\$714
	LK-CBA-TT29-3084	+\$741
96"	LK-CBA-TT29-2096	+\$718
	LK-CBA-TT29-2496	+\$735
	LK-CBA-TT29-3096	+\$761

Tilt

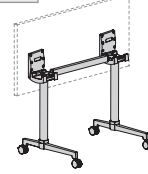

Cantilever T-Base Tilt

Width	Model	List Price
84"	LK-CBT-TT29-2084	+\$1,078
	LK-CBT-TT29-2484	+\$1,093
	LK-CBT-TT29-3084	+\$1,121
96"	LK-CBT-TT29-2096	+\$1,135
	LK-CBT-TT29-2496	+\$1,151
	LK-CBT-TT29-3096	+\$1,177

See pages 6-7 for additional information on Lok Bases.

See pages 38-44 on how to order/specify Lok Bases for Rectangular Tops, including caster color options.

Training Table Modesty Panels

<p>Fixed Modesty</p>	Material	Model	Standard List	Graded In HPL 2
	Acrylic	LK-MPF-84A	+\$543	--
		LK-MPF-96A	+\$594	--
	TFL	LK-MPF-84T	+\$220	--
		LK-MPF-96T	+\$227	--
	HPL	LK-MPF-84H	+\$335	+\$353
LK-MPF-96H		+\$352	+\$373	

Note: Fixed modesty panels are intended to always be attached to top and should not be specified in conjunction with Tilt T-Bases.

<p>Removable Modesty</p>	Material	Model	Standard List	Graded In HPL 2
	Acrylic	LK-MPR-84A	+\$602	--
		LK-MPR-96A	+\$651	--
	TFL	LK-MPR-84T	+\$278	--
		LK-MPR-96T	+\$285	--
	HPL	LK-MPR-84H	+\$393	+\$411
LK-MPR-96H		+\$409	+\$432	

Note: Removable modesty panels when used with Tilt T-bases must be removed before tilting table.

<p>Hinged Modesty</p>	Material	Model	Standard List	Graded In HPL 2
	Acrylic	LK-MPH-84A	+\$596	--
		LK-MPH-96A	+\$646	--
	TFL	LK-MPH-84T	+\$269	--
		LK-MPH-96T	+\$278	--
	HPL	LK-MPH-84H	+\$385	+\$403
LK-MPH-96H		+\$403	+\$425	

Note: Hinged modesty panels are intended to be used with Tilt T-Bases for tilting and table nesting. Not to be specified with Fixed T-Bases.

See pages 8-9 for additional information on Lok Modesty Panels.

See pages 64-66 on how to order/specify Lok Modesty Panels.

Description

Trapezoid Training Top

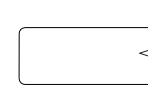
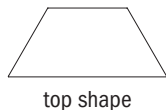
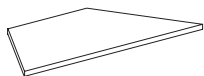

Eased Edge (R3)

LAM

LOK - TRAINING

D	W	H	CTN WT	CU FT	① Model	TFL	Standard	Graded In
							HPL 1	HPL 2
24	48	29	35	3	LK-TZ29-2448T	\$375	\$487	\$498
30	48	29	43	3	LK-TZ29-3048T	\$395	\$545	\$561

Table Components: (order separately)

- base, modesty panel, electrical, and privacy screens sold and ship separately
- specify power option, see below
- optional set of (2) linking bracket, specify and add an additional \$62 list

Electrical Options/Cutout Locations:

- specify power cutout and indicate if Link or Econo System will be used
- reference drawing below for approximate location

CT1 : Single Power Center Top Cutout Location

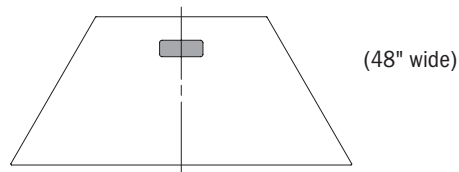

To Order Specify

① Model #	②a Laminate Selection	②b PVC Edge Color	③ Electrical
Model (LK)	See Laminate Selection	See PVC Edge Color Options	N None L-CT1-CO Link System - Center Top Single Power Cutout E-CT1-CO Econo System - Center Top Single Power Cutout

Model Number Breakdown

LK-TZ29-2448T					
LK	TZ	29	2448	T	
LOK	Trapezoid Top Shape	Height	24" x 48"	Laminate	

Training Table Bases

Select base preference below to go with corresponding Top. Note: Base depth and width must match Top depth (D) and width (W).

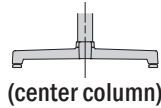

T-Bases
(center column)

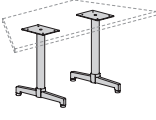
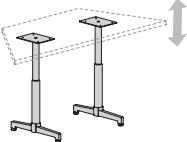
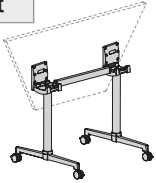
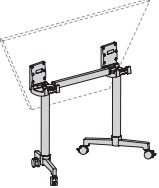
Fixed			
	Width	Model	List Price
 T-Base Fixed	48"	LK-TBF-TZ29-2448	+\$529
		LK-TBF-TZ29-3048	+\$562
T-Base Adjustable			
	Width	Model	List Price
 T-Base Adjustable	48"	LK-TBA-TZ29-2448	+\$645
		LK-TBA-TZ29-3048	+\$676
Tilt			
	Width	Model	List Price
 T-Base Tilt	48"	LK-TBT-TZ29-2448	+\$1,030
		LK-TBT-TZ29-3048	+\$1,064
 Inline T-Base	48"	LK-IBT-TZ29-2448	+\$919
		LK-IBT-TZ29-3048	+\$953

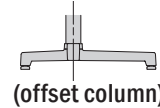

Cantilever T-Bases
(offset column)

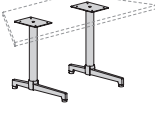
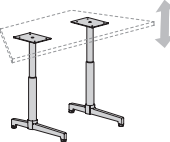
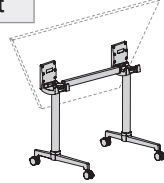
Fixed			
	Width	Model	List Price
 Cantilever T-Base Fixed	48"	LK-CBF-TZ29-2448	+\$531
		LK-CBF-TZ29-3048	+\$559
Cantilever T-Base Adj.			
	Width	Model	List Price
 Cantilever T-Base Adj.	48"	LK-CBA-TZ29-2448	+\$647
		LK-CBA-TZ29-3048	+\$673
Tilt			
	Width	Model	List Price
 Cantilever T-Base Tilt	48"	LK-CBT-TZ29-2448	+\$1,048
		LK-CBT-TZ29-3048	+\$1,075

See pages 6-7 for additional information on Lok Bases.

See pages 46-49 on how to order/specify Lok Bases for Trapezoid Tops, including caster color options.

Training Table Modesty Panels

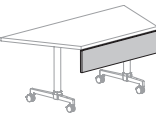
	Material	Model	Standard List	Graded In HPL 2
 Fixed Modesty	Acrylic	LK-MPF-26A	+\$316	--
		LK-MPF-30A	+\$317	--
	TFL	LK-MPF-26T	+\$166	--
		LK-MPF-30T	+\$168	--
	HPL	LK-MPF-26H	+\$247	+\$254
		LK-MPF-30H	+\$248	+\$256

Note: Fixed modesty panels are intended to always be attached to top and should not be specified in conjunction with Tilt T-Bases.

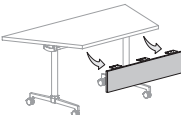
	Material	Model	Standard List	Graded In HPL 2
 Removable Modesty	Acrylic	LK-MPR-26A	+\$354	--
		LK-MPR-30A	+\$356	--
	TFL	LK-MPR-26T	+\$206	--
		LK-MPR-30T	+\$208	--
	HPL	LK-MPR-26H	+\$285	+\$293
		LK-MPR-30H	+\$286	+\$294

Note: Removable modesty panels when used with Tilt T-bases must be removed before tilting table.

	Material	Model	Standard List	Graded In HPL 2
 Hinged Modesty	Acrylic	LK-MPH-26A	+\$336	--
		LK-MPH-30A	+\$337	--
	TFL	LK-MPH-26T	+\$206	--
		LK-MPH-30T	+\$208	--
	HPL	LK-MPH-26H	+\$284	+\$292
		LK-MPH-30H	+\$285	+\$293

Note: Hinged modesty panels are intended to be used with Tilt T-Bases for tilting and table nesting. Not to be specified with Fixed T-Bases.

See pages 8-9 for additional information on Lok Modesty Panels.

See pages 64-66 on how to order/specify Lok Modesty Panels.

LOK - TRAINING

Description

Lecture Training Top

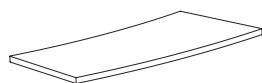

top shape

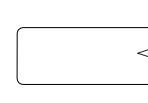

Eased Edge (R3)

D	W	H	CTN WT	CU FT	① Model	TFL	Standard	Graded In
							HPL 1	HPL 2
24	48	29	35	3	LK-LC29-2448T	\$383	\$506	\$520
30	48	29	43	3	LK-LC29-3048T	\$493	\$566	\$581
24	60	29	43	3	LK-LC29-2460T	\$428	\$571	\$587
30	60	29	54	4	LK-LC29-3060T	\$563	\$645	\$663

Table Components: (order separately)

- base, modesty panel, electrical, and privacy screens sold and ship separately
- specify power option, see below
- optional set of (2) linking bracket, specify and add an additional \$62 list

Electrical Options/Cutout Locations:

- specify power cutout and indicate if Link or Econo System will be used
- reference drawing below for approximate location

CT1 : Single Power Center Top Cutout Location

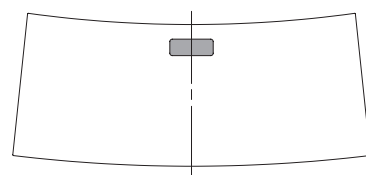

(48", 60" wide)

To Order Specify

① Model #	②a Laminate Selection	②b PVC Edge Color	③ Electrical
Model (LK)	See Laminate Selection	See PVC Edge Color Options	N None L-CT1-CO Link System - Center Top Single Power Cutout E-CT1-CO Econo System - Center Top Single Power Cutout

Model Number Breakdown

LK-LC29-2448T					
LK	LC	29	2448	T	
LOK	Lecture Top Shape	Height	24" x 48"	Laminate	

Training Table Bases

Select base preference below to go with corresponding Top. Note: Base depth and width must match Top depth (D) and width (W).

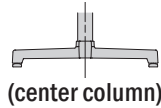

T-Bases

(center column)

Fixed		Width	Model	List Price
 T-Base Fixed	48"	60"	LK-TBF-LC29-2448	+\$544
			LK-TBF-LC29-3048	+\$578
	60"	60"	LK-TBF-LC29-2460	+\$586
			LK-TBF-LC29-3060	+\$618

Adjustable		Width	Model	List Price
 T-Base Adjustable	48"	60"	LK-TBA-LC29-2448	+\$660
			LK-TBA-LC29-3048	+\$694
	60"	60"	LK-TBA-LC29-2460	+\$701
			LK-TBA-LC29-3060	+\$735

Tilt		Width	Model	List Price
 T-Base Tilt	48"	60"	LK-TBT-LC29-2448	+\$1,046
			LK-TBT-LC29-3048	+\$1,079
	60"	60"	LK-TBT-LC29-2460	+\$1,062
			LK-TBT-LC29-3060	+\$1,093

Inline		Width	Model	List Price
 Inline T-Base	48"	60"	LK-IBT-LC29-2448	+\$919
			LK-IBT-LC29-3048	+\$953
	60"	60"	LK-IBT-LC29-2460	+\$1,046
			LK-IBT-LC29-3060	+\$1,079

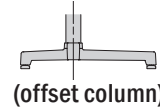

Cantilever T-Bases

Fixed		Width	Model	List Price
 Cantilever T-Base Fixed	48"	60"	LK-CBF-LC29-2448	+\$531
			LK-CBF-LC29-3048	+\$573
	60"	60"	LK-CBF-LC29-2460	+\$572
			LK-CBF-LC29-3060	+\$616

Adjustable		Width	Model	List Price
 Cantilever T-Base Adj.	48"	60"	LK-CBA-LC29-2448	+\$647
			LK-CBA-LC29-3048	+\$690
	60"	60"	LK-CBA-LC29-2460	+\$689
			LK-CBA-LC29-3060	+\$733

Tilt		Width	Model	List Price
 Cantilever T-Base Tilt	48"	60"	LK-CBT-LC29-2448	+\$1,064
			LK-CBT-LC29-3048	+\$1,075
	60"	60"	LK-CBT-LC29-2460	+\$1,048
			LK-CBT-LC29-3060	+\$1,091

See pages 6-7 for additional information on Lok Bases.

See pages 50-53 on how to order/specify Lok Bases for Lecture Tops, including caster color options.

Training Table Modesty Panels

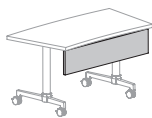

Fixed Modesty

Material	Model	List Price
Acrylic	LK-MPF-48A	+\$357
	LK-MPF-60A	+\$437

Note: Fixed modesty panels are intended to always be attached to top and should not be specified in conjunction with Tilt T-Bases.

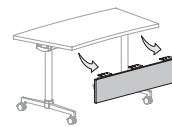

Removable Modesty

Material	Model	List Price
Acrylic	LK-MPR-48A	+\$395
	LK-MPR-60A	+\$495

Note: Removable modesty panels when used with Tilt T-bases must be removed before tilting table.

See pages 8-9 for additional information on Lok Modesty Panels.

See pages 64-66 on how to order/specify Lok Modesty Panels.

Description

Crescent Training Top

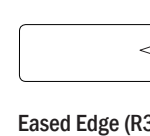
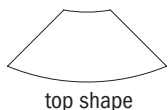
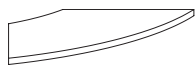

Eased Edge (R3)

LAM

LOK - TRAINING

D	W	H	CTN WT	CU FT	① Model	TFL	Standard	Graded In
							HPL 1	HPL 2
24	48	29	35	3	LK-CR29-2448T	\$390	\$527	\$540
30	48	29	43	3	LK-CR29-3048T	\$498	\$585	\$601

Table Components: (order separately)

- base, electrical, and privacy screens sold and ship separately
- top does not accommodate modesty panel
- specify power option, see below
- optional set of (2) linking bracket, specify and add an additional \$62 list

Electrical Options/Cutout Locations:

- specify power cutout and indicate if Link or Econo System will be used
- reference drawing below for approximate location

CT1 : Single Power Center Top Cutout Location

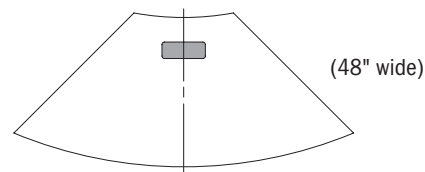

To Order Specify

① Model #	②a Laminate Selection	②b PVC Edge Color	③ Electrical
Model (LK)	See Laminate Selection	See PVC Edge Color Options	N None L-CT1-CO Link System - Center Top Single Power Cutout E-CT1-CO Econo System - Center Top Single Power Cutout

Model Number Breakdown

LK-CR29-2448T					
LK	CR	29	2448	T	
LOK	Crescent Top Shape	Height	24" x 48"	Laminate	

Training Table Bases

Select base preference below to go with corresponding Top. Note: Base depth and width must match Top depth (D) and width (W).



T-Bases

Fixed			
	Width	Model	List Price
 T-Base Fixed	48"	LK-TBF-CR29-2448	+\$529
		LK-TBF-CR29-3048	+\$562
Adjustable			
	Width	Model	List Price
 T-Base Adjustable	48"	LK-TBA-CR29-2448	+\$645
		LK-TBA-CR29-3048	+\$676
Tilt			
	Width	Model	List Price
 T-Base Tilt	48"	LK-TBT-CR29-2448	+\$1,030
		LK-TBT-CR29-3048	+\$1,064
Inline			
	Width	Model	List Price
 Inline T-Base	48"	LK-IBT-CR29-2448	+\$919
		LK-IBT-CR29-3048	+\$953

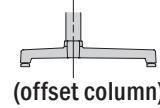

Cantilever T-Bases

Fixed			
	Width	Model	List Price
 Cantilever T-Base Fixed	48"	LK-CBF-CR29-2448	+\$531
		LK-CBF-CR29-3048	+\$559
Adjustable			
	Width	Model	List Price
 Cantilever T-Base Adj.	48"	LK-CBA-CR29-2448	+\$647
		LK-CBA-CR29-3048	+\$673
Tilt			
	Width	Model	List Price
 Cantilever T-Base Tilt	48"	LK-CBT-CR29-2448	+\$1,048
		LK-CBT-CR29-3048	+\$1,075

See pages 6-7 for additional information on Lok Bases.

See pages 54-57 on how to order/specify Lok Bases for Crescent Tops, including caster color options.

Note: Standard Training Table Modesty Panels are not available for Crescent Top shaped tables

Description

Half Round Training Top



top shape

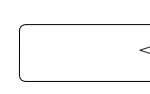

Eased Edge (R3)

D	W	H	CTN WT	CU FT	① Model	TFL	Standard	Graded In
							HPL 1	HPL 2
24	48	29	35	3	LK-HR29-2448T	\$385	\$487	\$487
30	60	29	54	4	LK-HR29-3060T	\$494	\$545	\$545

Table Components: (order separately)

- base, modesty panel, electrical, and privacy screens sold and ship separately
- specify power option or power jumper, see below
- optional set of (2) linking bracket, specify and add an additional \$62 list

Electrical Options/Cutout Locations:

- specify power cutout and indicate if Link or Econo System will be used
- reference drawing below for approximate location

CT1 : Single Power Center Top Cutout Location

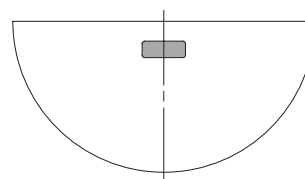

(48"- 60" wide)

To Order Specify

① Model #	②a Laminate Selection	②b PVC Edge Color	③ Electrical
Model (LK)	See Laminate Selection	See PVC Edge Color Options	N None L-CT1-CO Link System - Center Top Single Power Cutout E-CT1-CO Econo System - Center Top Single Power Cutout

Model Number Breakdown

LK-HR29-2448T					
LK	HR	29	2448	T	
LOK	Half Round Top Shape	Height	24" x 48"	Laminate	

Training Table Bases

Select base preference below to go with corresponding Top. Note: Base depth and width must match Top depth (D) and width (W).

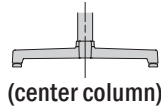

T-Bases
(center column)

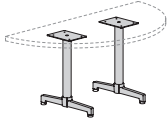
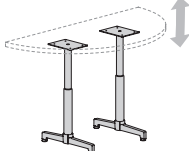
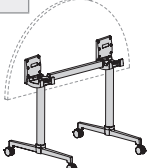
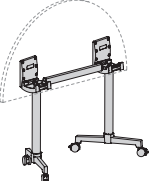
Fixed		Width	Model	List Price
		48"	LK-TBF-HR29-2448	+\$529
		60"	LK-TBF-HR29-3060	+\$618
T-Base Fixed				
Adjustable		Width	Model	List Price
		48"	LK-TBA-HR29-2448	+\$645
		60"	LK-TBA-HR29-3060	+\$735
T-Base Adjustable				
Tilt		Width	Model	List Price
		48"	LK-TBT-HR29-2448	+\$919
		60"	LK-TBT-HR29-3060	+\$1,079
T-Base Tilt				
		48"	LK-IBT-HR29-2448	+\$919
		60"	LK-IBT-HR29-3060	+\$1,079
Inline T-Base				

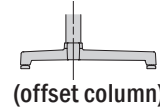

Cantilever T-Bases
(offset column)

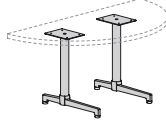
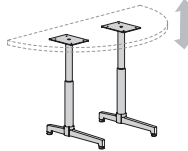
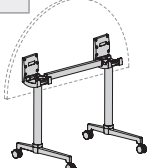
Fixed		Width	Model	List Price
		48"	LK-CBF-HR29-2448	+\$517
		60"	LK-CBF-HR29-3060	+\$616
Cantilever T-Base Fixed				
Adjustable		Width	Model	List Price
		48"	LK-CBA-HR29-2448	+\$631
		60"	LK-CBA-HR29-3060	+\$733
Cantilever T-Base Adj.				
Tilt		Width	Model	List Price
		48"	LK-CBT-HR29-2448	+\$921
		60"	LK-CBT-HR29-3060	+\$1,075
Cantilever T-Base Tilt				

See pages 6-7 for additional information on Lok Bases.

See pages 58-61 on how to order/specify Lok Bases for Half Round Tops, including caster color options.

Training Table Modesty Panels

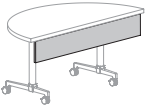
	Material	Model	Standard List	Graded In HPL 2
	Fixed Modesty	Acrylic	LK-MPF-48A	+\$357
LK-MPF-60A			+\$437	--
	TFL	LK-MPF-48T	+\$180	--
		LK-MPF-60T	+\$202	--
	HPL	LK-MPF-48H	+\$265	+\$277
		LK-MPF-60H	+\$299	+\$313

Note: Fixed modesty panels are intended to always be attached to top and should not be specified in conjunction with Tilt T-Bases.

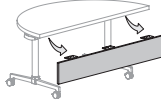
	Material	Model	Standard List	Graded In HPL 2
	Removable Modesty	Acrylic	LK-MPR-48A	+\$395
LK-MPR-60A			+\$495	--
	TFL	LK-MPR-48T	+\$218	--
		LK-MPR-60T	+\$261	--
	HPL	LK-MPR-48H	+\$304	+\$316
		LK-MPR-60H	+\$357	+\$369

Note: Removable modesty panels when used with Tilt T-bases must be removed before tilting table.

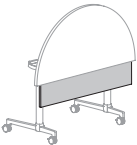
	Material	Model	Standard List	Graded In HPL 2
	Hinged Modesty	Acrylic	LK-MPH-48A	+\$392
LK-MPH-60A			+\$490	--
	TFL	LK-MPH-48T	+\$217	--
		LK-MPH-60T	+\$252	--
	HPL	LK-MPH-48H	+\$303	+\$315
		LK-MPH-60H	+\$349	+\$362

Note: Hinged modesty panels are intended to be used with Tilt T-Bases for tilting and table nesting. Not to be specified with Fixed T-Bases.

See pages 8-9 for additional information on Lok Modesty Panels.

See pages 64-66 on how to order/specify Lok Modesty Panels.

Description

Bullet Training Top

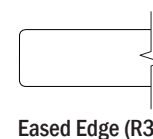
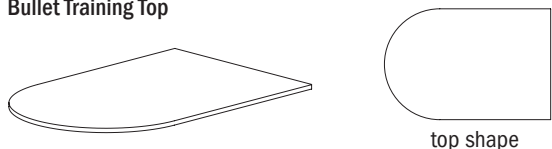

D	W	H	CTN WT	CU FT	① Model	TFL	Standard	Graded In
							HPL 1	HPL 2
30	60	29	54	4	LK-BU29-3060T	\$428	\$571	\$587
36	60	29	61	5	LK-BU29-3660T	\$572	\$669	\$723
30	66	29	58	4	LK-BU29-3066T	\$467	\$611	\$637
36	66	29	67	5	LK-BU29-3666T	\$597	\$697	\$751
30	72	29	61	5	LK-BU29-3072T	\$501	\$642	\$688
36	72	29	73	6	LK-BU29-3672T	\$657	\$773	\$811
48	72	29	96	7	LK-BU29-4872T	\$747	\$873	\$943

LOK - TRAINING LAMINATE

Table Components: (order separately)

- base, electrical, and privacy screens sold and ship separately
- optional set of (2) linking bracket, specify and add an additional \$62 list
- specify power option, see below for options

Electrical Options/Cutout Locations:

- specify power cutout
- reference drawing below for approximate location

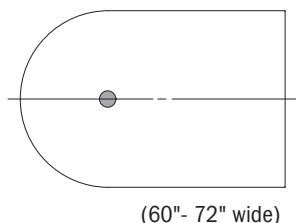

Select base preference below to go with corresponding Top.

Note: Base depth and width must match Top depth (D) and width (W).

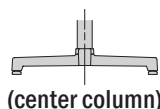

T-Bases

Fixed

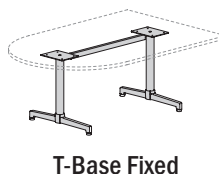

Width	Model	List Price
60"	LK-TBF-BU29-3060	+\$618
	LK-TBF-BU29-3660	+\$656
66"	LK-TBF-BU29-3066	+\$618
	LK-TBF-BU29-3666	+\$656
72"	LK-TBF-BU29-3072	+\$630
	LK-TBF-BU29-3672	+\$667
	LK-TBF-BU29-4872	+\$667

See intro page 6 for additional information on Lok Bases, including base color options.

See pricing page 62 on how to order/specify Lok Bases for Bullet Tops, including caster color options.

To Order Specify

① Model #	②a Laminate Selection	②b PVC Edge Color	③ Electrical
Model (LK)	See Laminate Selection	See PVC Edge Color Options	N None CTEC23-CO Electrical Cutout for EC23 CTEC24-CO Electrical Cutout for EC24

Model Number Breakdown

LK-BU29-3060T					
LK	BU	29	3060	T	
LOK	Bullet Top Shape	Height	30" x 60"	Laminate	

Description

Hive Training Top

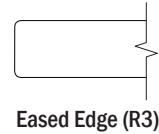
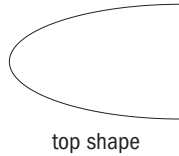
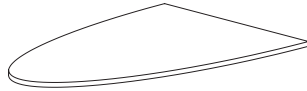

LAMINATE	W	D	H	CTN WT	CU FT	① Model	TFL	Standard HPL 1	Graded In HPL 2
		30	60	29	54	4	LK-HV29-3060T	\$430	\$573
	36	60	29	61	5	LK-HV29-3660T	\$574	\$671	\$725
	30	66	29	58	4	LK-HV29-3066T	\$469	\$613	\$639
	36	66	29	67	5	LK-HV29-3666T	\$600	\$699	\$754
	30	72	29	61	5	LK-HV29-3072T	\$503	\$645	\$690
	36	72	29	73	6	LK-HV29-3672T	\$659	\$776	\$813
	48	72	29	96	7	LK-HV29-4872T	\$750	\$876	\$946

Table Components: (order separately)

- base, electrical, and privacy screens sold and ship separately
- optional set of (2) ganging bracket, specify and add an additional \$62 list
- specify power option, see below for options

Electrical Options/Cutout Locations:

- specify power cutout
- reference drawing below for approximate location

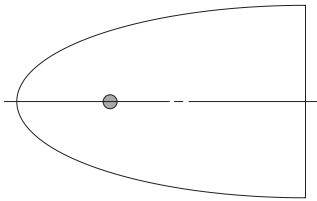

(60"- 72" wide)

Select base preference below to go with corresponding Top.

Note: Base depth and width must match Top depth (D) and width (W).

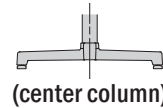

Fixed

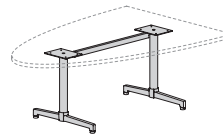

T-Base Fixed

T-Bases

Width	Model	List Price
60"	LK-TBF-HV29-3060	+\$618
	LK-TBF-HV29-3660	+\$656
66"	LK-TBF-HV29-3066	+\$618
	LK-TBF-HV29-3666	+\$656
72"	LK-TBF-HV29-3072	+\$630
	LK-TBF-HV29-3672	+\$656
	LK-TBF-HV29-4872	+\$656

See page 6 for additional information on Lok Bases.

See page 62 on how to order/specify Lok Bases for Hive Tops, including caster color options.

To Order Specify

① Model #	②a Laminate Selection	②b PVC Edge Color	③ Electrical
Model (LK)	See Laminate Selection	See PVC Edge Color Options	N None CTEC23-CO Electrical Cutout for EC23 CTEC24-CO Electrical Cutout for EC24

Model Number Breakdown

LK-HV29-3060T					
LK	HV	29	3060	T	
LOK	Hive Top Shape	Height	30" x 60"	Laminate	

Description

Intersect Training Top

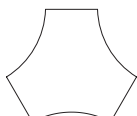
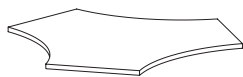

top shape

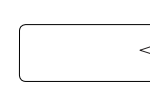

Eased Edge (R3)

LAM

LOK - TRAINING

D	W	H	CTN WT	CU FT	1 Model	TFL	Standard HPL 1	Graded In HPL 2
24	60	29	88	7	LK-IN29-2460T	\$625	\$904	\$979
30	60	29	96	7	LK-IN29-3060T	\$629	\$908	\$982

Table Components: (order separately)

- base, electrical, and privacy screens sold and ship separately
- specify power option, see below
- optional set of (2) linking bracket, specify and add an additional \$62 list

Electrical Options/Cutout Locations:

- specify power cutout
- reference drawing below for approximate location

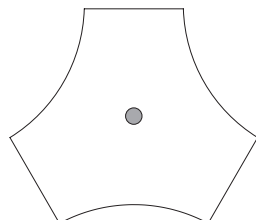

(60" wide)

Select base preference below to go with corresponding Top.

Note: Base depth and width must match Top depth (D) and width (W).

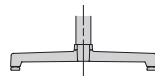

(center column)

Fixed

T-Bases

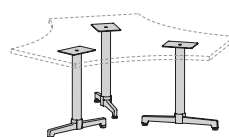

T-Base Fixed

Width	Model	List Price
60"	LK-TBF-IN29-2460	+\$788
	LK-TBF-IN29-3060	+\$788

See intro page 6 for additional information on Lok Bases, including base color options.

See pricing page 63 on how to order/specify Lok Bases for Intersect Tops, including caster color options.

To Order Specify

1 Model #	2a Laminate Selection	2b PVC Edge Color	3 Electrical
Model (LK)	See Laminate Selection	See PVC Edge Color Options	N None CTEC23-CO Electrical Cutout for EC23 CTEC24-CO Electrical Cutout for EC24

Model Number Breakdown

LK-IN29-2460T				
LK	IN	29	2460	T
LOK	Intersect Top Shape	Height	24" x 60"	Laminate

Description

Huddle Training Top

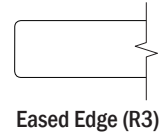
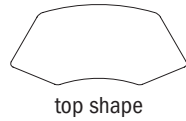

W	D	H	CTN WT	CU FT	① Model	TFL	Standard HPL 1	Graded In HPL 2
30	72	29	65	5	LK-HU29-3072T	\$501	\$642	\$688
36	84	29	91	6	LK-HU29-3684T	\$729	\$799	\$861

Table Components: (order separately)

- base and electrical sold and ship separately
- specify power option, see below
- optional set of (2) linking bracket, specify and add an additional \$62 list

Electrical Options/Cutout Locations:

- specify power cutout and indicate if Link or Econo System will be used
- reference drawing below for approximate location

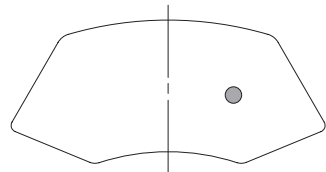

(72"- 84" wide)

Select base preference below to go with corresponding Top.

Note: Base depth and width must match Top depth (D) and width (W).

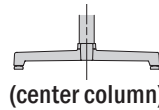

Fixed

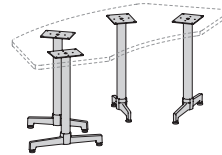

T-Base Fixed

T-Bases

Width	Model	List Price
72"	LK-TBF-HU29-3072	+\$1,028
84"	LK-TBF-HU29-3684	+\$1,028

See page 6 for additional information on Lok Bases.

See page 63 on how to order/specify Lok Bases for Huddle Tops, including caster color options.

To Order Specify

① Model #	②a Laminate Selection	②b PVC Edge Color	③ Electrical
Model (LK)	See Laminate Selection	See PVC Edge Color Options	N None CTEC23-CO Electrical Cutout for EC23 CTEC24-CO Electrical Cutout for EC24

Model Number Breakdown

LK-HU29-3072T					
LK	HU	29	3072	T	
LOK	Huddle Top Shape	Height	30" x 72"	Laminate	

Description

One-twenty Training Top

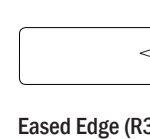
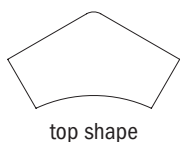
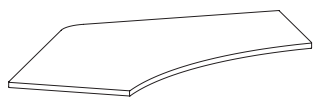

D	W	H	CTN WT	CU FT	① Model	TFL	Standard	Graded In
							HPL 1	HPL 2
42	72	29	81	6	LK-YG29-4272T	\$726	\$801	\$865
45	84	29	95	8	LK-YG29-4584T	\$754	\$923	\$1,002

Table Components: (order separately)

- base, modesty panel, electrical, and privacy screens sold and ship separately
- specify power option, see below

Options:

- optional set of (2) linking bracket, specify and add an additional \$62 list

Electrical Options/Cutout Locations:

- specify power cutout and indicate if Link or Econo System will be used
- reference drawing below for approximate location

CT1 : Single Power Center Top

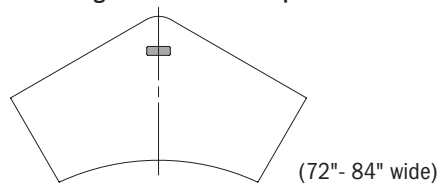

LRT2 : Dual Power Left/Right Top

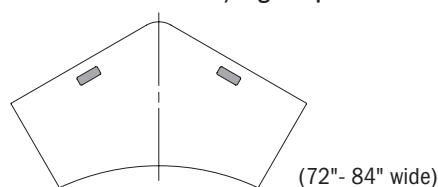

To Order Specify

① Model #	②a Laminate Selection	②b PVC Edge Color	③ Electrical
Model (LK)	See Laminate Selection	See PVC Edge Color Options	N None L-CT1-CO Link System - Center Top Single Power Cutout E-CT1-CO Econo System - Center Top Single Power Cutout L-LRT2-CO Link System - Left/Right Top Dual Power Cutout E-LRT2-CO Econo System - Left/Right Top Dual Power Cutout

Model Number Breakdown

LK-YG29-4272T					
LK	YG	29	4272	T	
LOK	One-twenty Top Shape	Height	42" x 72"	Laminate	

Training Table Bases

Select base preference below to go with corresponding Top. Note: Base depth and width must match Top depth (D) and width (W).

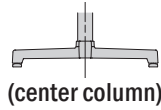

T-Bases

(center column)

Fixed

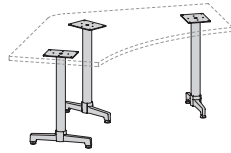

T-Base Fixed

Width	Model	List Price
72"	LK-TBF-YG29-4272	+\$747
84"	LK-TBF-YG29-4584	+\$747

Training Table Modesty Panels



Fixed Modesty

Material	Model	Standard List	Graded In HPL 2
Acrylic	LK-MPF-36A	+\$319	--
	LK-MPF-42A	+\$354	--
TFL	LK-MPF-36T	+\$171	--
	LK-MPF-42T	+\$177	--
HPL	LK-MPF-36H	+\$250	+\$259
	LK-MPF-42H	+\$263	+\$274

Note: Fixed modesty panels are intended to always be attached to top and should not be specified in conjunction with Tilt T-Bases.



Removable Modesty

Material	Model	Standard List	Graded In HPL 2
Acrylic	LK-MPR-36A	+\$358	--
	LK-MPR-42A	+\$392	--
TFL	LK-MPR-36T	+\$210	--
	LK-MPR-42T	+\$216	--
HPL	LK-MPR-36H	+\$288	+\$298
	LK-MPR-42H	+\$302	+\$314

Note: Removable modesty panels when used with Tilt T-bases must be removed before tilting table.

See pages 8-9 for additional information on Lok Modesty Panels.

See pages 64-66 on how to order/specify Lok Modesty Panels.

Description

Quarter Round Training Top

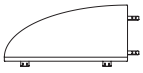

top shape

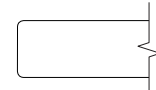

Eased Edge (R3)

D	W	H	CTN WT	CU FT	① Model	TFL	Standard	Graded In
							HPL 1	HPL 2
24			15	2	LK-Q90-24T	\$316	\$380	\$385
30			22	2	LK-Q90-30T	\$338	\$444	\$453

Features:

- electrical sold and ship separately
- base not required; flat plates included - use for attachment between two tables

Options:

- power continued from adjacent tables with jumper; specify no (PJN) or yes Link(PJY-L) - add \$116 list or Econo(PJY-E) - add \$129 list

LAM
LOK - TRAINING

To Order Specify

① Model #	②a Laminate Selection	②b PVC Edge Color	③ Electrical
Model (LK)	See Laminate Selection	See PVC Edge Color Options	PJY-L LINK System Jumper PJY-E ECONO System Jumper

Model Number Breakdown

LK-Q90-24T					
LK	Q	90	24	T	
LOK	Quarter Round Top Shape	90° Quarter Round	24" Depth	Laminate	

Wedge LinkTraining Top

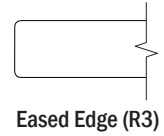
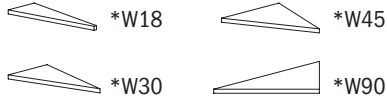

LAMINATE	D	W	H	CTN WT	CU FT	① Model	TFL	Standard HPL 1	Graded In HPL 2
		24			6	1	LK-W18-24T	\$231	\$285
	30			7	1	LK-W18-30T	\$244	\$309	\$313
	24			7	1	LK-W30-24T	\$248	\$304	\$307
	30			9	1	LK-W30-30T	\$271	\$340	\$343
	24			9	1	LK-W45-24T	\$266	\$335	\$338
	30			11	2	LK-W45-30T	\$303	\$383	\$389
	24			13	2	LK-W90-24T	\$293	\$361	\$365
	30			17	2	LK-W90-30T	\$318	\$426	\$433

Features:

- electrical sold and ship separately
- base not required; flat plates included - use for attachment between two tables

Options:

- power continued from adjacent tables with jumper; specify no (PJN) or yes Link(PJY-L) - add \$116 list or Econo(PJY-E) -add \$129 list

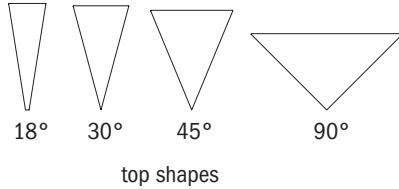

To Order Specify

① Model #	②a Laminate Selection	②b PVC Edge Color	③ Electrical
Model (LK)	See Laminate Selection	See PVC Edge Color Options	PJY-L LINK System Jumper PJY-E ECONO System Jumper

Model Number Breakdown

LK-W18-24T				
LK	W	18	24	T
LOK	Wedge Top Shape	18° Wedge	24" Depth	Laminate

Description	D	W	H	CTN WT	CU FT	1 Model	List Price
<p>36" & 48"w</p>	20	36	29	22	4	LK-TBF-TT29-2036	\$501
	24	36	29	23	5	LK-TBF-TT29-2436	\$529
	30	36	29	24	7	LK-TBF-TT29-3036	\$562
	20	48	29	22	4	LK-TBF-TT29-2048	\$501
	24	48	29	23	5	LK-TBF-TT29-2448	\$529
	30	48	29	24	7	LK-TBF-TT29-3048	\$562
	20	60	29	26	5	LK-TBF-TT29-2060	\$560
	24	60	29	27	6	LK-TBF-TT29-2460	\$586
	30	60	29	28	8	LK-TBF-TT29-3060	\$618
<p>60" - 96"w includes a metal support rail</p>	20	66	29	26	5	LK-TBF-TT29-2066	\$560
	24	66	29	27	6	LK-TBF-TT29-2466	\$586
	30	66	29	28	8	LK-TBF-TT29-3066	\$618
	20	72	29	27	5	LK-TBF-TT29-2072	\$569
	24	72	29	28	6	LK-TBF-TT29-2472	\$597
	30	72	29	29	8	LK-TBF-TT29-3072	\$630
	20	84	29	27	5	LK-TBF-TT29-2084	\$569
	24	84	29	28	6	LK-TBF-TT29-2484	\$597
	30	84	29	29	8	LK-TBF-TT29-3084	\$630
20	96	29	28	6	LK-TBF-TT29-2096	\$588	
24	96	29	29	7	LK-TBF-TT29-2496	\$616	
30	96	29	30	9	LK-TBF-TT29-3096	\$649	

Features:



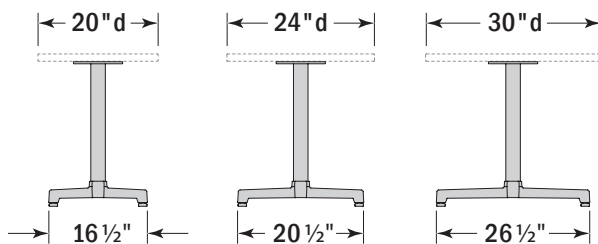

- bases include all necessary field assembly hardware

Options:

- specify Glide (G) or Caster(C) - choice of Black(BL) or White/Grey (WG) Caster; add \$43 list for casters
- specify metal finish, see below for options and two-tone capabilities

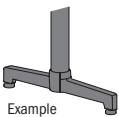
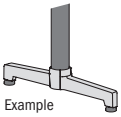

To Order Specify

1 Model #	2 Feet & Post Finish	Dual Finish	3 Glides or Casters
Lok (LK)	See Feet & Post Finish Options  <p>Example</p>	2a Feet Finish See Feet Finish Options 2b Post Finish See Post Finish Options  <p>Example</p>	G Glides  Standard (no upcharge) C Casters - BL Black +\$40  - WG White w/Grey Wheels +\$40 

LK-TBF-TT29-3072					
LK	TBF	TT	29	3072	
LOK	T-Base Fixed	Rectangular Top Shape	Height	Used on 30" x 72" Tops	

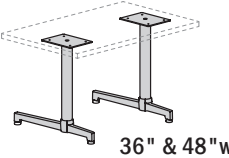
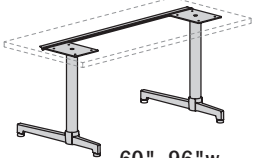
Description	D	W	H	CTN WT	CU FT	① Model	List Price
Cantilever Fixed T-Base for Rectangular Top	20	36	29	22	4	LK-CBF-TT29-2036	\$517
	24	36	29	23	5	LK-CBF-TT29-2436	\$531
	30	36	29	24	7	LK-CBF-TT29-3036	\$559
 36" & 48" w	20	48	29	22	4	LK-CBF-TT29-2048	\$517
	24	48	29	23	5	LK-CBF-TT29-2448	\$531
	30	48	29	24	7	LK-CBF-TT29-3048	\$559
	20	60	29	26	5	LK-CBF-TT29-2060	\$572
	24	60	29	27	6	LK-CBF-TT29-2460	\$588
	30	60	29	28	8	LK-CBF-TT29-3060	\$616
	20	66	29	26	5	LK-CBF-TT29-2066	\$572
	24	66	29	27	6	LK-CBF-TT29-2466	\$588
	30	66	29	28	8	LK-CBF-TT29-3066	\$616
 60" - 96" w includes a metal support rail	20	72	29	27	5	LK-CBF-TT29-2072	\$583
	24	72	29	28	6	LK-CBF-TT29-2472	\$600
	30	72	29	29	8	LK-CBF-TT29-3072	\$626
	20	84	29	27	5	LK-CBF-TT29-2084	\$583
	24	84	29	28	6	LK-CBF-TT29-2484	\$600
	30	84	29	29	8	LK-CBF-TT29-3084	\$626
	20	96	29	28	6	LK-CBF-TT29-2096	\$604
	24	96	29	29	7	LK-CBF-TT29-2496	\$618
	30	96	29	30	9	LK-CBF-TT29-3096	\$646



Features:

- bases include all necessary field assembly hardware

Options:

- specify metal finish, see below for options and two-tone capabilities
- specify Glide (G) or Caster (C) - choice of Black (BL) or White/Grey (WG) Caster; add \$43 list for casters

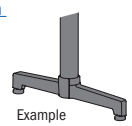
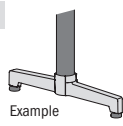
To Order Specify

① Model #	② Feet & Post Finish	Dual Finish	③ Glides or Casters
Lok (LK)	See Feet & Post Finish Options  Example	2a Feet Finish See Feet Finish Options 2b Post Finish See Post Finish Options  Example	G Glides  Standard (no upcharge) C Casters - BL Black +\$40 - WG White w/Grey Wheels +\$40

LK-CBF-TT29-3072					
LK	CBF	TT	29	3072	
LOK	Cantilever T-Base Fixed	Rectangular Top Shape	Height	Used on 30" x 72" Tops	

LOK - TRAINING

LOK - TRAINING

Description	D	W	H	CTN WT	CU FT	① Model	List Price
Adjustable T Base for Rectangular Top 	20	36	29	22	4	LK-TBA-TT29-2036	\$616
	24	36	29	23	5	LK-TBA-TT29-2436	\$645
	30	36	29	24	7	LK-TBA-TT29-3036	\$676
	20	48	29	22	4	LK-TBA-TT29-2048	\$616
	24	48	29	23	5	LK-TBA-TT29-2448	\$645
	30	48	29	24	7	LK-TBA-TT29-3048	\$676
	20	60	29	26	5	LK-TBA-TT29-2060	\$674
	24	60	29	27	6	LK-TBA-TT29-2460	\$701
	30	60	29	28	8	LK-TBA-TT29-3060	\$735
	20	66	29	26	5	LK-TBA-TT29-2066	\$674
	24	66	29	27	6	LK-TBA-TT29-2466	\$701
	30	66	29	28	8	LK-TBA-TT29-3066	\$735
	20	72	29	27	5	LK-TBA-TT29-2072	\$684
	24	72	29	28	6	LK-TBA-TT29-2472	\$712
	30	72	29	29	8	LK-TBA-TT29-3072	\$745
	20	84	29	27	5	LK-TBA-TT29-2084	\$684
	24	84	29	28	6	LK-TBA-TT29-2484	\$712
	30	84	29	29	8	LK-TBA-TT29-3084	\$745
	20	96	29	28	6	LK-TBA-TT29-2096	\$703
	24	96	29	29	7	LK-TBA-TT29-2496	\$733
	30	96	29	30	9	LK-TBA-TT29-3096	\$765

Features:



- pin adjustment base provides range of 26"-34"
- bases include all necessary field assembly hardware

Options:

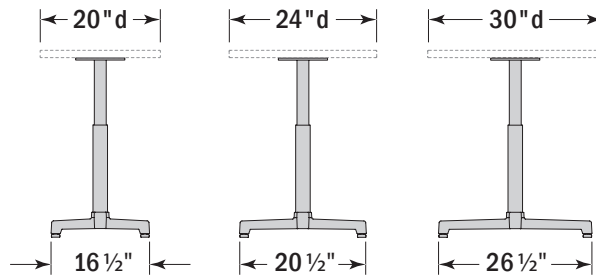
- specify metal finish, see below for options and two-tone capabilities

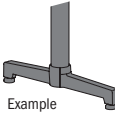
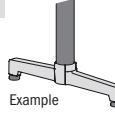

To Order Specify

① Model #	② Feet & Post Finish	Dual Finish		G Glides
Lok (LK)	See Feet & Post Finish Options  Example	2a Feet Finish See Feet Finish Options	2b Post Finish See Post Finish Options  Example	 Standard (no upcharge)

LK-TBA-TT29-3072					
LK	TBA	TT	29	3072	
LOK	T-Base Adjustable	Rectangular Top Shape	Height	Used on 30" x 72" Tops	

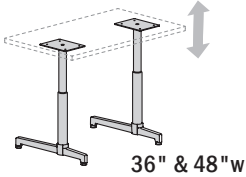
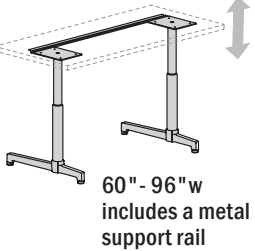
Description	D	W	H	CTN WT	CU FT	① Model	List Price
 <p>36" & 48" w</p>	20	36	29	22	4	LK-CBA-TT29-2036	\$631
	24	36	29	23	5	LK-CBA-TT29-2436	\$647
	30	36	29	24	7	LK-CBA-TT29-3036	\$673
	20	48	29	22	4	LK-CBA-TT29-2048	\$631
	24	48	29	23	5	LK-CBA-TT29-2448	\$647
	30	48	29	24	7	LK-CBA-TT29-3048	\$673
	20	60	29	26	5	LK-CBA-TT29-2060	\$689
	24	60	29	27	6	LK-CBA-TT29-2460	\$703
	30	60	29	28	8	LK-CBA-TT29-3060	\$733
 <p>60" - 96" w includes a metal support rail</p>	20	66	29	26	5	LK-CBA-TT29-2066	\$689
	24	66	29	27	6	LK-CBA-TT29-2466	\$703
	30	66	29	28	8	LK-CBA-TT29-3066	\$733
	20	72	29	27	5	LK-CBA-TT29-2072	\$699
	24	72	29	28	6	LK-CBA-TT29-2472	\$714
	30	72	29	29	8	LK-CBA-TT29-3072	\$741
	20	84	29	27	5	LK-CBA-TT29-2084	\$699
	24	84	29	28	6	LK-CBA-TT29-2484	\$714
	30	84	29	29	8	LK-CBA-TT29-3084	\$741
20	96	29	28	6	LK-CBA-TT29-2096	\$718	
24	96	29	29	7	LK-CBA-TT29-2496	\$735	
30	96	29	30	9	LK-CBA-TT29-3096	\$761	



Features:

- pin adjustment base provides range of 26"-34"
- bases include all necessary field assembly hardware

Options:

- specify metal finish, see below for options and two-tone capabilities

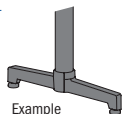
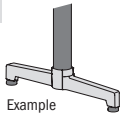
To Order Specify

① Model #	② Feet & Post Finish	Dual Finish		G Glides
Lok (LK)	See Feet & Post Finish Options  <p>Example</p>	2a Feet Finish See Feet Finish Options	2b Post Finish See Post Finish Options  <p>Example</p>	 Standard (no upcharge)

LK-CBA-TT29-3072					
LK	CBA	TT	29	3072	
LOK	Cantilever T-Base Adjustable	Rectangular Top Shape	Height	Used on 30" x 72" Tops	

LOK - TRAINING

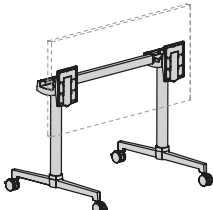
Description	D	W	H	CTN WT	CU FT	1 Model	List Price
	20	36	29	27	5	LK-TBT-TT29-2036	\$876
	24	36	29	28	6	LK-TBT-TT29-2436	\$904
	30	36	29	28	8	LK-TBT-TT29-3036	\$938
	20	48	29	28	6	LK-TBT-TT29-2048	\$1,003
	24	48	29	29	7	LK-TBT-TT29-2448	\$1,030
	30	48	29	30	9	LK-TBT-TT29-3048	\$1,064
	20	60	29	29	6	LK-TBT-TT29-2060	\$1,019
	24	60	29	30	7	LK-TBT-TT29-2460	\$1,046
	30	60	29	31	9	LK-TBT-TT29-3060	\$1,078
	20	66	29	31	9	LK-TBT-TT29-2066	\$1,019
	24	66	29	30	7	LK-TBT-TT29-2466	\$1,046
	30	66	29	29	6	LK-TBT-TT29-3066	\$1,078
	20	72	29	30	6	LK-TBT-TT29-2072	\$1,048
	24	72	29	31	7	LK-TBT-TT29-2472	\$1,077
	30	72	29	32	9	LK-TBT-TT29-3072	\$1,109
	20	84	29	30	6	LK-TBT-TT29-2084	\$1,048
	24	84	29	31	7	LK-TBT-TT29-2484	\$1,077
	30	84	29	32	9	LK-TBT-TT29-3084	\$1,109
	20	96	29	32	6	LK-TBT-TT29-2096	\$1,106
	24	96	29	32	7	LK-TBT-TT29-2496	\$1,133
	30	96	29	33	9	LK-TBT-TT29-3096	\$1,164

Features:



- base nests in offset position when top is tilted
- bases include all necessary field assembly hardware

Options:

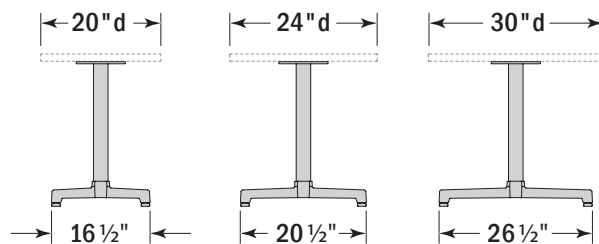
- specify Black (BL) or White/Grey (WG) Caster
- specify metal finish, see below for options and two-tone capabilities

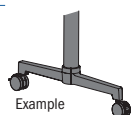
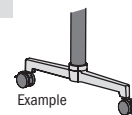

To Order Specify

1 Model #	2 Feet & Post Finish	Dual Finish	3 Casters
Lok (LK)	See Feet & Post Finish Options 	2a Feet Finish See Feet Finish Options 2b Post Finish See Post Finish Options 	C Casters - Standard (no upcharge) - BL Black - WG White w/ Grey Wheels 

LK-TBT-TT29-3072					
LK	TBT	TT	29	3072	
LOK	T-Base Tilt	Rectangular Top Shape	Height	Used on 30" x 72" Tops	

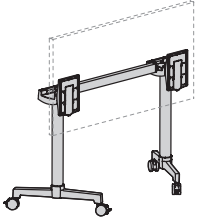
Description	D	W	H	CTN WT	CU FT	① Model	List Price
Inline Tilt T-Base for Rectangular Top 	20	48	29	28	6	LK-IBT-TT29-2048	\$919
	24	48	29	28	6	LK-IBT-TT29-2448	\$919
	20	60	29	29	7	LK-IBT-TT29-2060	\$1,046
	24	60	29	29	7	LK-IBT-TT29-2460	\$1,046
	20	66	29	29	7	LK-IBT-TT29-2066	\$1,046
	24	66	29	29	7	LK-IBT-TT29-2466	\$1,046
	20	72	29	30	7	LK-IBT-TT29-2072	\$1,062
	24	72	29	30	7	LK-IBT-TT29-2472	\$1,062
	20	84	29	31	7	LK-IBT-TT29-2084	\$1,092
	24	84	29	31	7	LK-IBT-TT29-2484	\$1,092
	20	96	29	32	7	LK-IBT-TT29-2096	\$1,149
	24	96	29	32	7	LK-IBT-TT29-2496	\$1,149



Features:

- base nests in inline position when top is tilted
- bases include all necessary field assembly hardware

Options:

- specify Black (BL) or White/Grey (WG) Caster
- specify metal finish, see below for options and two-tone capabilities

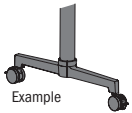
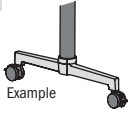
To Order Specify

① Model #	② Feet & Post Finish	Dual Finish		③ Casters
Lok (LK)	See Feet & Post Finish Options  Example	2a Feet Finish See Feet Finish Options	2b Post Finish See Post Finish Options  Example	C Casters - Standard (no upcharge) - BL Black - WG White w/Grey Wheels 
LK-IBT-TT29-3072				
LK	IBT	TT	29	3072
LOK	Inline T-Base Tilt	Rectangular Top Shape	Height	Used on 30" x 72" Tops

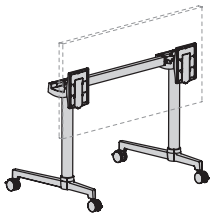
Description	D	W	H	CTN WT	CU FT	① Model	List Price
	20	36	29	27	5	LK-CBT-TT29-2036	\$906
	24	36	29	28	6	LK-CBT-TT29-2436	\$921
	30	36	29	28	8	LK-CBT-TT29-3036	\$949
	20	48	29	28	6	LK-CBT-TT29-2048	\$1,033
	24	48	29	29	7	LK-CBT-TT29-2448	\$1,048
	30	48	29	30	9	LK-CBT-TT29-3048	\$1,075
	20	60	29	29	6	LK-CBT-TT29-2060	\$1,047
	24	60	29	30	7	LK-CBT-TT29-2460	\$1,064
	30	60	29	31	9	LK-CBT-TT29-3060	\$1,091
	20	66	29	29	6	LK-CBT-TT29-2066	\$1,047
	24	66	29	30	7	LK-CBT-TT29-2466	\$1,064
	30	66	29	31	9	LK-CBT-TT29-3066	\$1,091
	20	72	29	30	6	LK-CBT-TT29-2072	\$1,078
	24	72	29	31	7	LK-CBT-TT29-2472	\$1,093
	30	72	29	32	9	LK-CBT-TT29-3072	\$1,121
	20	84	29	30	6	LK-CBT-TT29-2084	\$1,078
	24	84	29	31	7	LK-CBT-TT29-2484	\$1,093
	30	84	29	32	9	LK-CBT-TT29-3084	\$1,121
	20	96	29	32	6	LK-CBT-TT29-2096	\$1,135
	24	96	29	32	7	LK-CBT-TT29-2496	\$1,151
	30	96	29	33	9	LK-CBT-TT29-3096	\$1,177



Features:

- base nests in offset position when top is tilted
- bases include all necessary field assembly hardware

Options:

- specify Black (BL) or White/Grey (WG) Caster
- specify metal finish, see below for options and two-tone capabilities

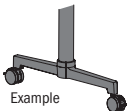
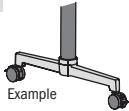
To Order Specify

① Model #	② Feet & Post Finish	Dual Finish		③ Casters
Lok (LK)	See Feet & Post Finish Options 	2a Feet Finish See Feet Finish Options	2b Post Finish See Post Finish Options 	C Casters - Standard (no upcharge) - BL Black - WG White w/ Grey Wheels 
LK-CBT-TT29-3072				
LK	CBT	TT	29	3072
LOK	Cantilever T-Base Tilt	Rectangular Top Shape	Height	Used on 30" x 72" Tops

Page left intentionally blank

Description	D	W	H	CTN WT	CU FT	① Model	List Price
Fixed T Base for Trapezoid Top	24	48	29	23	5	LK-TBF-TZ29-2448	\$529
	30	48	29	24	7	LK-TBF-TZ29-3048	\$562

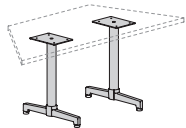

Features:

- specify Glide (G) or Caster(C) -choice of Black(BL) or White/Grey (WG) Caster; add \$43 list for casters

Options:

- bases include all necessary field assembly hardware
- specify metal finish, see below for options and two-tone capabilities

LOK - TRAINING

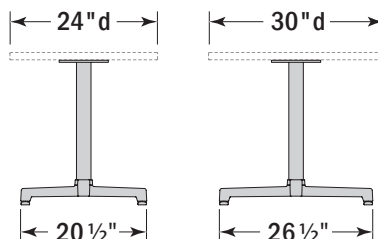

Cantilever Fixed T-Base for Trapezoid Top	24	48	29	23	5	LK-CBF-TZ29-2448	\$531
	30	48	29	24	7	LK-CBF-TZ29-3048	\$559

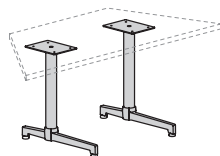





Features:

- specify Glide (G) or Caster(C) -choice of Black(BL) or White/Grey (WG) Caster; add \$43 list for casters

Options:

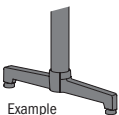
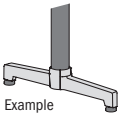
- bases include all necessary field assembly hardware
- specify metal finish, see below for options and two-tone capabilities

To Order Specify

① Model #	② Feet & Post Finish	Dual Finish		③ Glides or Casters		
Lok (LK)	See Feet & Post Finish Options  Example	2a Feet Finish See Feet Finish Options	2b Post Finish See Post Finish Options  Example	G Glides  Standard (no upcharge)	C Casters - BL Black  +\$40	- WG White w/Grey Wheels  +\$40

LK-TBF-TZ29-3072					
LK	TBF	TZ	29	3072	
LOK	T-Base Fixed	Trapezoid Top Shape	Height	Used on 30" x 72" Tops	

Description	D	W	H	CTN WT	CU FT	① Model	List Price
Adjustable T Base for Trapezoid Top	24	48	29	23	5	LK-TBA-TZ29-2448	\$645
	30	48	29	24	7	LK-TBA-TZ29-3048	\$676

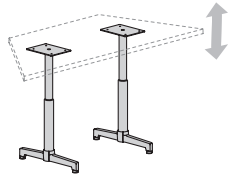

Features:

- pin adjustment base provides range of 26"-34"
- ADA Compliant
- bases include all necessary field assembly hardware

Options:

- specify metal finish, see below for options and two-tone capabilities

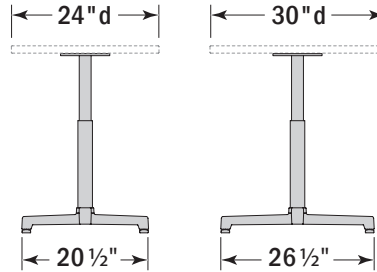

Cantilever Adjustable T-Base for Trapezoid Top	24	48	29	23	5	LK-CBA-TZ29-2448	\$647
	30	48	29	24	7	LK-CBA-TZ29-3048	\$673

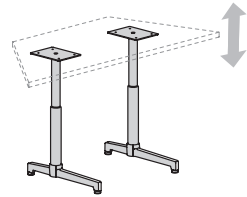

Features:



- pin adjustment base provides range of 26"-34"
- ADA Compliant
- bases include all necessary field assembly hardware

Options:

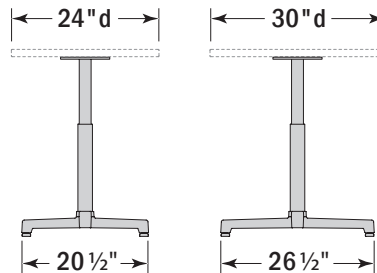
- specify metal finish, see below for options and two-tone capabilities

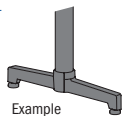
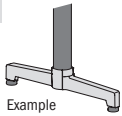

To Order Specify

① Model #	② Feet & Post Finish	Dual Finish		G Glides
Lok (LK)	See Feet & Post Finish Options  <p>Example</p>	2a Feet Finish See Feet Finish Options	2b Post Finish See Post Finish Options  <p>Example</p>	 Standard (no upcharge)

LK-TBF-TZ29-3072					
LK	TBA	TZ	29	3072	
LOK	T-Base Adjustable	Trapezoid Top Shape	Height	Used on 30" x 72" Tops	

Description	D	W	H	CTN WT	CU FT	1 Model	List Price
Tilt T Base for Trapezoid Top	24	48	29	29	7	LK-TBT-TZ29-2448	\$1,030
	30	48	29	30	9	LK-TBT-TZ29-3048	\$1,064

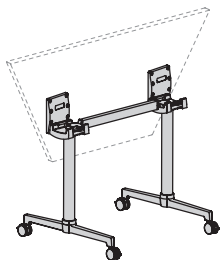

Features:

- base nests in offset position when top is tilted
- bases include all necessary field assembly hardware

Options:

- specify Black (BL) or White/Grey (WG) Caster
- specify metal finish, see below for options and two-tone capabilities

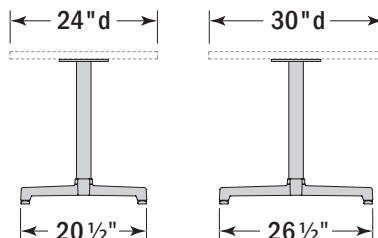

Inline Tilt T-Base for Trapezoid Top	24	48	29	27	6	LK-IBT-TZ29-2448	\$919
	30	48	29	28	8	LK-IBT-TZ29-3048	\$953

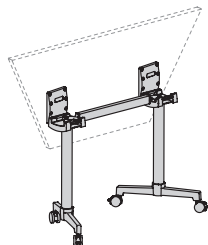



Features:

- base nests in inline position when top is tilted
- bases include all necessary field assembly hardware

Options:

- specify metal finish, see below for options and two-tone capabilities
- specify Black (BL) or White/Grey (WG) Caster

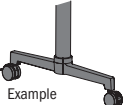
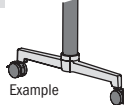
To Order Specify

1 Model #	2 Feet & Post Finish	Dual Finish		3 Casters
Lok (LK)	See Feet & Post Finish Options 	2a Feet Finish See Feet Finish Options	2b Post Finish See Post Finish Options 	C Casters - Standard (no upcharge) - BL Black - WG White w/ Grey Wheels 

LK-TBT-TZ29-3048					
LK	TBT	TZ	29	3048	
LOK	T-Base Tilt	Trapezoid Top Shape	Height	Used on 30" x 48" Tops	

Description	D	W	H	CTN WT	CU FT	① Model	List Price
Cantilever Tilt T-Base for Trapezoid Top	24	48	29	29	7	LK-CBT-TZ29-2448	\$1,048
	30	48	29	30	9	LK-CBT-TZ29-3048	\$1,075

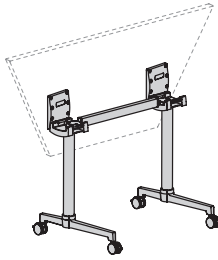



Features:

- base nests in offset position when top is tilted
- bases include all necessary field assembly hardware

Options:

- specify Black (BL) or White/Grey (WG) Caster
- specify metal finish, see below for options and two-tone capabilities

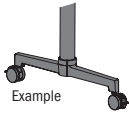
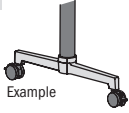
To Order Specify

① Model #	② Feet & Post Finish	Dual Finish		③ Casters
Lok (LK)	See Feet & Post Finish Options 	2a Feet Finish See Feet Finish Options	2b Post Finish See Post Finish Options 	C Casters - Standard (no upcharge) - BL Black - WG White w/Grey Wheels  

LK-IBT-TT29-3072					
LK	IBT	TZ	29	3072	
LOK	Inline T-Base Tilt	Trapezoid Top Shape	Height	Used on 30" x 72" Tops	

Description	D	W	H	CTN WT	CU FT	① Model	List Price
Fixed T Base for Lecture Top	24	48	29	23	5	LK-TBF-LC29-2448	\$544
	30	48	29	24	7	LK-TBF-LC29-3048	\$578
	24	60	29	27	6	LK-TBF-LC29-2460	\$586
	30	60	29	28	8	LK-TBF-LC29-3060	\$618

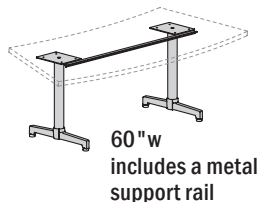
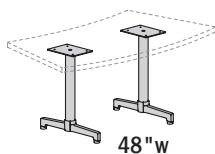

Features:

- bases include all necessary field assembly hardware

Options:

- specify metal finish, see below for options and two-tone capabilities
- specify Glide (G) or Caster(C) -choice of Black(BL) or White/Grey (WG) Caster; add \$43 list for casters

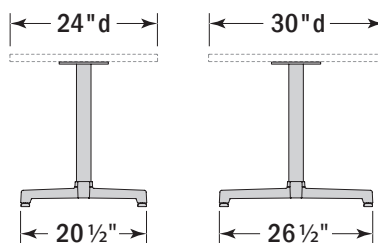

Description	D	W	H	CTN WT	CU FT	① Model	List Price
Cantilever Fixed T-Base for Lecture Top	24	48	29	22	4	LK-CBF-LC29-2448	\$531
	30	48	29	24	7	LK-CBF-LC29-3048	\$573
	24	60	29	26	5	LK-CBF-LC29-2460	\$572
	30	60	29	28	8	LK-CBF-LC29-3060	\$616

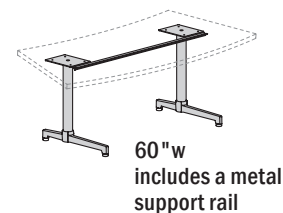
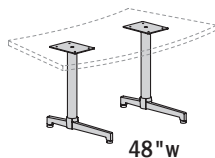

Features:

- bases include all necessary field assembly hardware

Options:

- specify metal finish, see below for options and two-tone capabilities
- specify Glide (G) or Caster(C) - choice of Black(BL) or White/Grey (WG) Caster; add \$43 list for casters

To Order Specify

① Model #	② Feet & Post Finish	Dual Finish	③ Glides or Casters
Lok (LK)	See Feet & Post Finish Options <p>Example</p>	2a Feet Finish See Feet Finish Options 2b Post Finish See Post Finish Options <p>Example</p>	G Glides <p>Standard (no upcharge)</p> C Casters - BL Black +\$40 - WG White w/Grey Wheels +\$40

LK-CBF-LC29-3072					
LK	CBF	LC	29	3060	
LOK	T-Base Fixed	Lecture Top Shape	Height	Used on 30" x 72" Tops	

Description	D	W	H	CTN WT	CU FT	① Model	List Price
Adjustable T Base for Lecture Top	24	48	29	23	5	LK-TBA-LC29-2448	\$660
	30	48	29	24	7	LK-TBA-LC29-3048	\$694
	24	60	29	27	6	LK-TBA-LC29-2460	\$701
	30	60	29	28	8	LK-TBA-LC29-3060	\$735

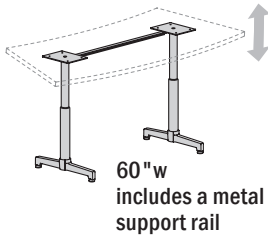
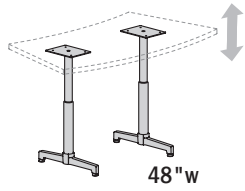

Features:

- pin adjustment base provides range of 26"-34"
- ADA Compliant
- bases include all necessary field assembly hardware

Options:

- specify metal finish, see below for options and two-tone capabilities

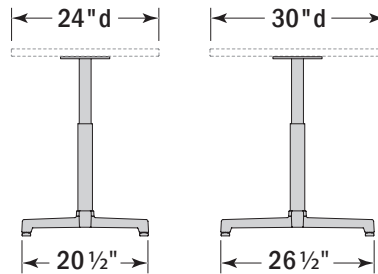

Description	D	W	H	CTN WT	CU FT	Model	List Price
Cantilever Adjustable T-Base for Lecture Top	24	48	29	22	4	LK-CBA-LC29-2448	\$647
	30	48	29	24	7	LK-CBA-LC29-3048	\$690
	24	60	29	26	5	LK-CBA-LC29-2460	\$689
	30	60	29	28	8	LK-CBA-LC29-3060	\$733

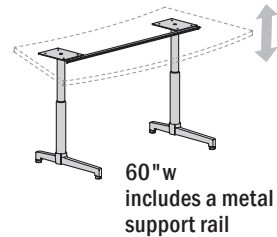
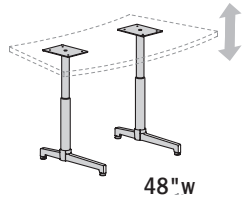

Features:

- pin adjustment base provides range of 26"-34"
- ADA Compliant
- bases include all necessary field assembly hardware

Options:

- specify metal finish, see below for options and two-tone capabilities

To Order Specify

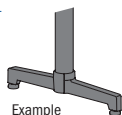
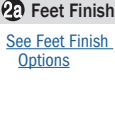
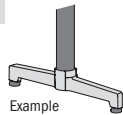
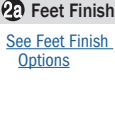
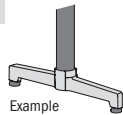
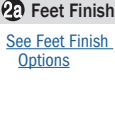
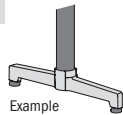
① Model #	② Feet & Post Finish	Dual Finish				
Lok (LK)	See Feet & Post Finish Options 	<table border="0"> <tr> <td> 2a Feet Finish See Feet Finish Options </td> <td> 2b Post Finish See Post Finish Options </td> </tr> <tr> <td></td> <td></td> </tr> </table>	2a Feet Finish See Feet Finish Options	2b Post Finish See Post Finish Options		
2a Feet Finish See Feet Finish Options	2b Post Finish See Post Finish Options					
						

LK-CBA-LC29-3060					
LK	CBA	LC	29	3060	
LOK	Cantilever T-Base Adjustable	Lecture Top Shape	Height	Used on 30" x 60" Tops	

Description	D	W	H	CTN WT	CU FT	① Model	List Price
Tilt T Base for Lecture Top	24	48	29	29	7	LK-TBT-LC29-2448	\$1,046
	30	48	29	30	9	LK-TBT-LC29-3048	\$1,079
	24	60	29	30	7	LK-TBT-LC29-2460	\$1,062
	30	60	29	31	9	LK-TBT-LC29-3060	\$1,093

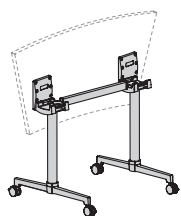

Features:

- base nests in offset position when top is tilted
- bases include all necessary field assembly hardware

Options:

- specify metal finish, see below for options and two-tone capabilities

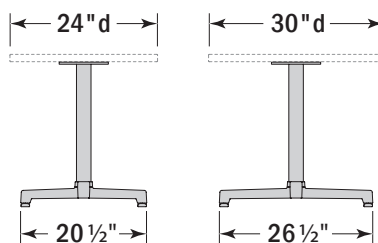

Description	D	W	H	CTN WT	CU FT	Model	List Price
Inline Tilt T-Base for Lecture Top	24	48	29	28	6	LK-IBT-LC29-2448	\$919
	30	48	29	28	8	LK-IBT-LC29-3048	\$953
	24	60	29	29	7	LK-IBT-LC29-2460	\$1,046
	30	60	29	30	9	LK-IBT-LC29-3060	\$1,079

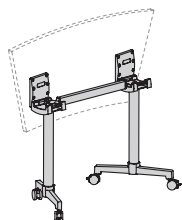



Features:

- base nests in inline position when top is tilted
- bases include all necessary field assembly hardware

Options:

- specify metal finish, see below for options and two-tone capabilities
- specify Black (BL) or White/Grey (WG) Caster

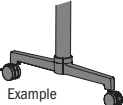
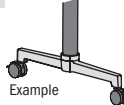
To Order Specify

① Model #	② Feet & Post Finish	Dual Finish	③ Casters
Lok (LK)	See Feet & Post Finish Options 	2a Feet Finish See Feet Finish Options 2b Post Finish See Post Finish Options 	C Casters - Standard (no upcharge) - BL Black - WG White w/ Grey Wheels 

LK-TBF-TT29-3072					
LK	TBF	TT	29	3072	
LOK	T-Base Fixed	Rectangular Top Shape	Height	Used on 30" x 72" Tops	

Description	D	W	H	CTN WT	CU FT	❶ Model	List Price
Cantilever Tilt T-Base for Lecture Top	24	48	29	29	7	LK-CBT-LC29-2448	\$1,064
	30	48	29	30	9	LK-CBT-LC29-3048	\$1,075
	24	60	29	30	7	LK-CBT-LC29-2460	\$1,048
	30	60	29	31	9	LK-CBT-LC29-3060	\$1,091

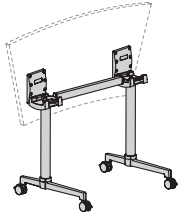



Features:

- bases include all necessary field assembly hardware
- specify metal finish, see below for options and two-tone capabilities

Options:

- specify Black (BL) or White/Grey (WG) Caster

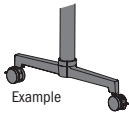
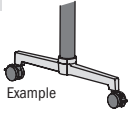
To Order Specify

❶ Model #	❷ Feet & Post Finish	Dual Finish		❸ Casters
Lok (LK)	See Feet & Post Finish Options 	2a Feet Finish See Feet Finish Options	2b Post Finish See Post Finish Options 	C Casters - Standard (no upcharge) - BL Black - WG White w/ Grey Wheels  

LK-TBF-TT29-3072					
LK	TBA	TT	29	3072	
LOK	T-Base Adjustable	Rectangular Top Shape	Height	Used on 30" x 72" Tops	

Description	D	W	H	CTN WT	CU FT	① Model	List Price
Fixed T Base for Crescent Top	24	48	29	23	5	LK-TBF-CR29-2448	\$529
	30	48	29	24	7	LK-TBF-CR29-3048	\$562

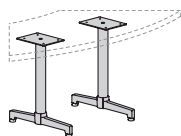

Features:

- bases include all necessary field assembly hardware

Options:

- specify metal finish, see below for options and two-tone capabilities
- specify Glide (G) or Caster(C) - choice of Black(BL) or White/Grey (WG) Caster; add \$43 list for casters

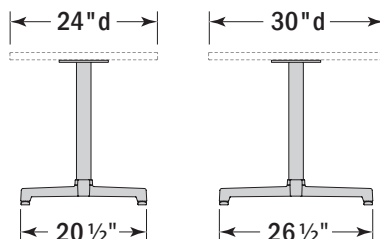

Cantilever Fixed T-Base for Crescent Top	24	48	29	23	5	LK-CBF-CR29-2448	\$531
	30	48	29	24	7	LK-CBF-CR29-3048	\$559

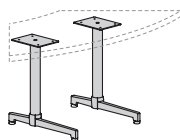

Features:

- bases include all necessary field assembly hardware

Options:

- specify metal finish, see below for options and two-tone capabilities
- specify Glide (G) or Caster(C) - choice of Black(BL) or White/Grey (WG) Caster; add \$43 list for casters

To Order Specify

① Model #	② Feet & Post Finish	Dual Finish	③ Glides or Casters
Lok (LK)	See Feet & Post Finish Options Example	2a Feet Finish See Feet Finish Options 2b Post Finish See Post Finish Options Example	G Glides Standard (no upcharge) C Casters - BL Black +\$40 - WG White w/Grey Wheels +\$40

LK-TBF-TT29-3072					
LK	TBF	TT	29	3072	
LOK	T-Base Fixed	Rectangular Top Shape	Height	Used on 30" x 72" Tops	

Description	D	W	H	CTN WT	CU FT	① Model	List Price
Adjustable T Base for Crescent Top	24	48	29	23	5	LK-TBA-CR29-2448	\$645
	30	48	29	24	7	LK-TBA-CR29-3048	\$676

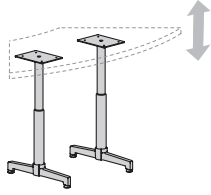

Features:

- pin adjustment base provides range of 26"-34"
- ADA Compliant
- bases include all necessary field assembly hardware

Options:

- specify metal finish, see below for options and two-tone capabilities

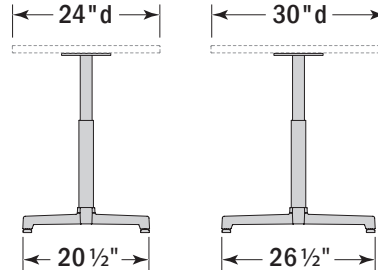

Cantilever Adjustable T-Base for Crescent Top	24	48	29	23	5	LK-CBA-CR29-2448	\$647
	30	48	29	24	7	LK-CBA-CR29-3048	\$673

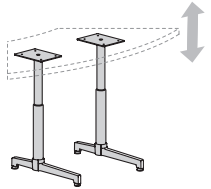

Features:

- pin adjustment base provides range of 26"-34"
- ADA Compliant
- bases include all necessary field assembly hardware

Options:

- specify metal finish, see below for options and two-tone capabilities

To Order Specify

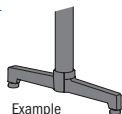
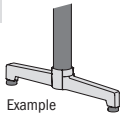
① Model #	② Feet & Post Finish	Dual Finish	
Lok (LK)	See Feet & Post Finish Options  <p>Example</p>	2a Feet Finish See Feet Finish Options	2b Post Finish See Post Finish Options  <p>Example</p>

LK-TBF-TT29-3072					
LK	TBA	TT	29	3072	
LOK	T-Base Adjustable	Rectangular Top Shape	Height	Used on 30" x 72" Tops	

Description	D	W	H	CTN WT	CU FT	1 Model	List Price
Tilt T Base for Crescent Top	24	48	29	29	7	LK-TBT-CR29-2448	\$1,030
	30	48	29	30	9	LK-TBT-CR29-3048	\$1,064

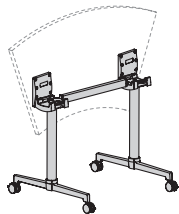

Features:

- base nests in offset position when top is tilted
- bases include all necessary field assembly hardware

Options:

- specify metal finish, see below for options and two-tone capabilities

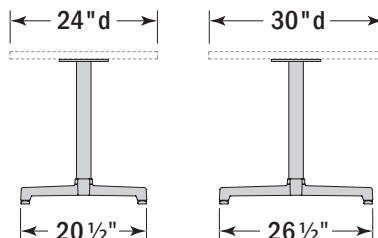

Inline Tilt T-Base for Crescent Top	24	48	29	28	6	LK-IBT-CR29-2448	\$919
	30	48	29	28	8	LK-IBT-CR29-3048	\$953

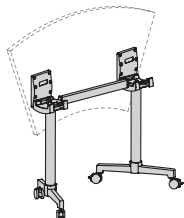



Features:

- base nests in inline position when top is tilted
- bases include all necessary field assembly hardware

Options:

- specify metal finish, see below for options and two-tone capabilities
- specify Black (BL) or White/Grey (WG) Caster

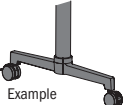
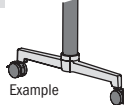
To Order Specify

1 Model #	2 Feet & Post Finish	Dual Finish		3 Casters
Lok (LK)	See Feet & Post Finish Options 	2a Feet Finish See Feet Finish Options	2b Post Finish See Post Finish Options 	C Casters - Standard (no upcharge) - BL Black - WG White w/ Grey Wheels  

LK-TBF-TT29-3072					
LK	TBF	TT	29	3072	
LOK	T-Base Fixed	Rectangular Top Shape	Height	Used on 30" x 72" Tops	

Description	D	W	H	CTN WT	CU FT	① Model	List Price
Cantilever Tilt T-Base for Crescent Top	24	48	29	29	7	LK-CBT-CR29-2448	\$1,048
	30	48	29	30	9	LK-CBT-CR29-3048	\$1,075

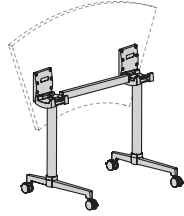



Features:

- bases include all necessary field assembly hardware
- specify metal finish, see below for options and two-tone capabilities

Options:

- specify Black (BL) or White/Grey (WG) Caster

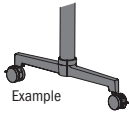
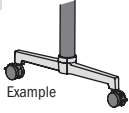
To Order Specify

① Model #	② Feet & Post Finish	Dual Finish		③ Casters
Lok (LK)	See Feet & Post Finish Options 	2a Feet Finish See Feet Finish Options	2b Post Finish See Post Finish Options 	C Casters - Standard (no upcharge) - BL Black - WG White w/ Grey Wheels 

LK-TBF-TT29-3072					
LK	TBA	TT	29	3072	
LOK	T-Base Adjustable	Rectangular Top Shape	Height	Used on 30" x 72" Tops	

Description	D	W	H	CTN WT	CU FT	① Model	List Price
Fixed T Base for Half Round Top	24	48	29	23	5	LK-TBF-HR29-2448	\$529
	30	60	29	28	8	LK-TBF-HR29-3060	\$618

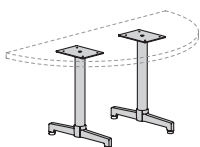

Features:

- bases include all necessary field assembly hardware

Options:

- specify metal finish, see below for options and two-tone capabilities
- specify Glide (G) or Caster(C) - choice of Black(BL) or White/Grey (WG) Caster; add \$43 list for casters

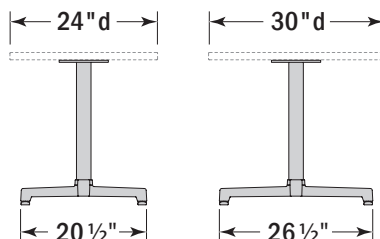

Cantilever Fixed T-Base for Half Round Top	24	48	29	23	5	LK-CBF-HR29-2448	\$517
	30	60	29	28	8	LK-CBF-HR29-3060	\$616

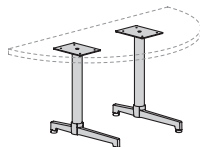





Features:

- bases include all necessary field assembly hardware

Options:

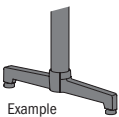
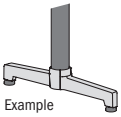
- specify metal finish, see below for options and two-tone capabilities
- specify Glide (G) or Caster(C) - choice of Black(BL) or White/Grey (WG) Caster; add \$43 list for casters

To Order Specify

① Model #	② Feet & Post Finish	Dual Finish		③ Glides or Casters		
Lok (LK)	See Feet & Post Finish Options  <p>Example</p>	2a Feet Finish See Feet Finish Options	2b Post Finish See Post Finish Options  <p>Example</p>	G Glides  Standard (no upcharge)	C Casters - BL Black  +\$40	- WG White w/Grey Wheels  +\$40

LK-TBF-TT29-3072					
LK	TBF	TT	29	3072	
LOK	T-Base Fixed	Rectangular Top Shape	Height	Used on 30" x 72" Tops	

Description	D	W	H	CTN WT	CU FT	① Model	List Price
Adjustable T Base for Half Round Top	24	48	29	23	5	LK-TBA-HR29-2448	\$645
	30	60	29	28	8	LK-TBA-HR29-3060	\$735

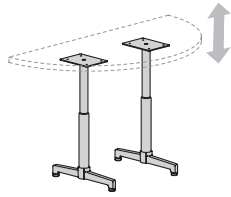

Features:

- pin adjustment base provides range of 26"-34"
- ADA Compliant
- bases include all necessary field assembly hardware

Options:

- specify metal finish, see below for options and two-tone capabilities

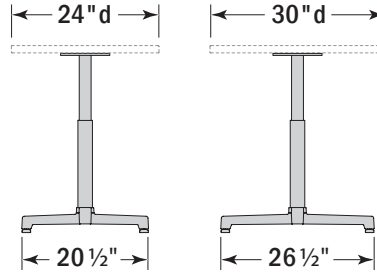

Description	D	W	H	CTN WT	CU FT	① Model	List Price
Cantilever Adjustable T-Base for Half Round Top	24	48	29	23	5	LK-CBA-HR29-2448	\$631
	30	60	29	28	8	LK-CBA-HR29-3060	\$733

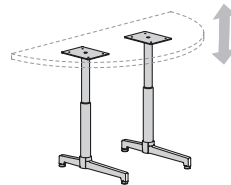

Features:

- pin adjustment base provides range of 26"-34"
- ADA Compliant
- bases include all necessary field assembly hardware

Options:

- specify metal finish, see below for options and two-tone capabilities

To Order Specify

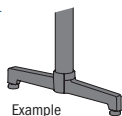
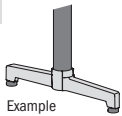
① Model #	② Feet & Post Finish	Dual Finish	
Lok (LK)	See Feet & Post Finish Options  Example	2a Feet Finish See Feet Finish Options	2b Post Finish See Post Finish Options  Example

LK-TBF-TT29-3072					
LK	TBA	TT	29	3072	
LOK	T-Base Adjustable	Rectangular Top Shape	Height	Used on 30" x 72" Tops	

Description	D	W	H	CTN WT	CU FT	1 Model	List Price
Tilt T Base for Half Round Top	24	48	29	28	6	LK-TBT-HR29-2448	\$919
	30	60	29	30	9	LK-TBT-HR29-3060	\$1,079

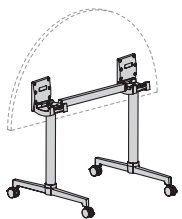

Features:

- base nests in offset position when top is tilted
- bases include all necessary field assembly hardware

Options:

- specify metal finish, see below for options and two-tone capabilities

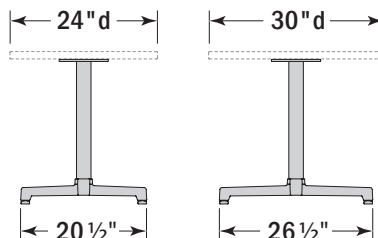

Description	D	W	H	CTN WT	CU FT	1 Model	List Price
Inline Tilt T-Base for Half Round Top	24	48	29	28	6	LK-IBT-HR29-2448	\$919
	30	60	29	30	9	LK-IBT-HR29-3060	\$1,079

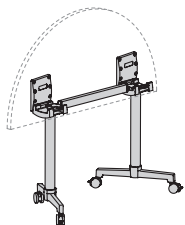



Features:

- base nests in inline position when top is tilted
- bases include all necessary field assembly hardware

Options:

- specify metal finish, see below for options and two-tone capabilities
- specify Black (BL) or White/Grey (WG) Caster

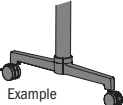
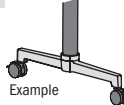
To Order Specify

1 Model #	2 Feet & Post Finish	Dual Finish		3 Casters
Lok (LK)	See Feet & Post Finish Options  Example	2a Feet Finish See Feet Finish Options	2b Post Finish See Post Finish Options  Example	C Casters - Standard (no upcharge) - BL Black - WG White w/ Grey Wheels  

LK-TBF-TT29-3072					
LK	TBF	TT	29	3072	
LOK	T-Base Fixed	Rectangular Top Shape	Height	Used on 30" x 72" Tops	

Description	D	W	H	CTN WT	CU FT	① Model	List Price
Cantilever Tilt T-Base for Half Round Top	24	48	29	28	6	LK-CBT-HR29-2448	\$921
	30	60	29	30	9	LK-CBT-HR29-3060	\$1,075

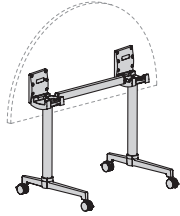

Features:



- bases include all necessary field assembly hardware
- specify metal finish, see below for options and two-tone capabilities

Options:

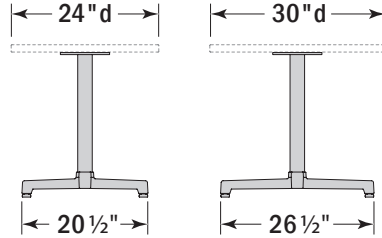
- specify Black (BL) or White/Grey (WG) Caster

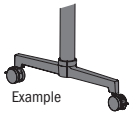
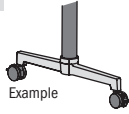

To Order Specify

① Model #	② Feet & Post Finish	Dual Finish		③ Casters
Lok (LK)	See Feet & Post Finish Options 	2a Feet Finish See Feet Finish Options	2b Post Finish See Post Finish Options 	C Casters - Standard (no upcharge) - BL Black - WG White w/Grey Wheels 

LK-TBF-TT29-3072					
LK	TBA	TT	29	3072	
LOK	T-Base Adjustable	Rectangular Top Shape	Height	Used on 30" x 72" Tops	

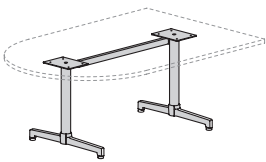
Description	D	W	H	CTN WT	CU FT	① Model	List Price
	30	60	29	28	8	LK-TBF-BU29-3060	\$618
	36	60	29	29	8	LK-TBF-BU29-3660	\$656
	30	66	29	28	8	LK-TBF-BU29-3066	\$618
	36	66	29	29	8	LK-TBF-BU29-3666	\$656
	30	72	29	29	8	LK-TBF-BU29-3072	\$630
	36	72	29	29	8	LK-TBF-BU29-3672	\$667
	48	72	29	29	8	LK-TBF-BU29-4872	\$667

Features:

- bases include all necessary top support and field assembly hardware

Options:

- specify metal finish, see below for options and two-tone capabilities
- specify Glide (G) or Caster(C) - choice of Black(BL) or White/Grey (WG) Caster; add \$43 list for casters

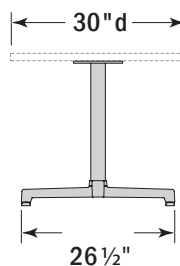

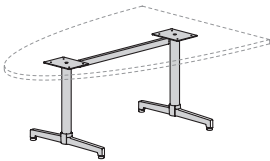
Description	D	W	H	CTN WT	CU FT	① Model	List Price
	30	60	29	28	8	LK-TBF-HV29-3060	\$618
	36	60	29	29	8	LK-TBF-HV29-3660	\$656
	30	66	29	28	8	LK-TBF-HV29-3066	\$618
	36	66	29	29	8	LK-TBF-HV29-3666	\$656
	30	72	29	29	8	LK-TBF-HV29-3072	\$630
	36	72	29	29	8	LK-TBF-HV29-3672	\$656
	48	72	29	29	8	LK-TBF-HV29-4872	\$656

Features:



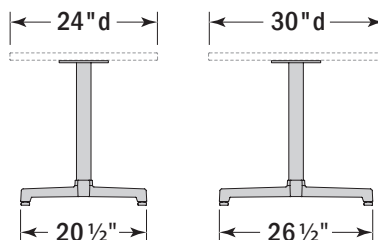

- specify metal finish, see below for options and two-tone capabilities

Options:

- specify metal finish, see below for options and two-tone capabilities
- specify Glide (G) or Caster(C) - choice of Black(BL) or White/Grey (WG) Caster; add \$43 list for casters

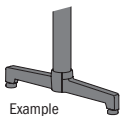
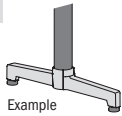

To Order Specify

① Model #	② Feet & Post Finish	Dual Finish	③ Glides or Casters
Lok (LK)	See Feet & Post Finish Options 	2a) Feet Finish See Feet Finish Options 2b) Post Finish See Post Finish Options 	G Glides  Standard (no upcharge) C Casters - BL Black +\$40  - WG White w/Grey Wheels +\$40 

LK-TBF-TT29-3072					
LK	TBF	TT	29	3072	
LOK	T-Base Fixed	Rectangular Top Shape	Height	Used on 30" x 72" Tops	

Description	D	W	H	CTN WT	CU FT	① Model	List Price
Fixed T Base for Huddle Top	30	72	29	45	9	LK-TBF-HU29-3072	\$1,028
	36	84	29	45	9	LK-TBF-HU29-3684	\$1,028

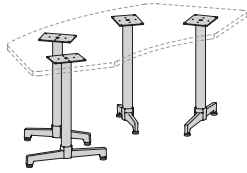

Features:

- bases include all necessary top support and field assembly hardware

Options:

- specify metal finish, see below for options and two-tone capabilities
- specify Glide (G) or Caster(C) - choice of Black(BL) or White/Grey (WG) Caster; add \$84 list for casters

Fixed T Base for One-twenty Top	42	72	29	33	7	LK-TBF-YG29-4272	\$747
	45	84	29	33	7	LK-TBF-YG29-4584	\$747

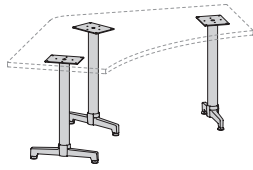

Features:

- bases include all necessary top support and field assembly hardware

Options:

- specify metal finish, see below for options and two-tone capabilities
- specify Glide (G) or Caster(C) - choice of Black(BL) or White/Grey (WG) Caster; add \$63 list for casters

Fixed T Base for Intersect Top	24	60	29	35	8	LK-TBF-IN29-2460	\$788
	30	60	29	35	8	LK-TBF-IN29-3060	\$788

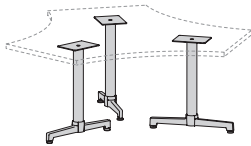

Features:

- bases include all necessary top support and field assembly hardware

Options:

- specify metal finish, see below for options and two-tone capabilities
- specify Glide (G) or Caster(C) - choice of Black(BL) or White/Grey (WG) Caster; add \$63 list for casters

To Order Specify

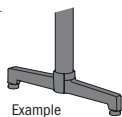
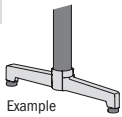
① Model #	② Feet & Post Finish	Dual Finish	
Lok (LK)	See Feet & Post Finish Options  <p>Example</p>	2a Feet Finish See Feet Finish Options	2b Post Finish See Post Finish Options  <p>Example</p>

LK-TBF-TT29-3072					
LK	TBA	TT	29	3072	
LOK	T-Base Adjustable	Rectangular Top Shape	Height	Used on 30" x 72" Tops	

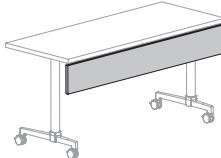
Description	D	W	H	CTN WT	CU FT	① Model	TFL	Standard	Graded In
								HPL 1	HPL 2
 Fixed Laminate Modesty Panel	¾	26	8	10	2	LK-MPF-26T	\$166		
	¾	26	8	10	2	LK-MPF-26H		\$247	\$254
	¾	30	8	10	2	LK-MPF-30T	\$168		
	¾	30	8	10	2	LK-MPF-30H		\$248	\$256
	¾	36	8	10	2	LK-MPF-36T	\$171		
	¾	36	8	10	2	LK-MPF-36H		\$250	\$259
	¾	42	8	10	3	LK-MPF-42T	\$177		
	¾	42	8	10	3	LK-MPF-42H		\$263	\$274
	¾	48	8	10	3	LK-MPF-48T	\$180		
	¾	48	8	10	3	LK-MPF-48H		\$265	\$277
	¾	60	8	11	3	LK-MPF-60T	\$202		
	¾	60	8	11	3	LK-MPF-60H		\$299	\$313
	¾	66	8	12	3	LK-MPF-66T	\$208		
	¾	66	8	12	3	LK-MPF-66H		\$307	\$323
	¾	72	8	12	4	LK-MPF-72T	\$211		
	¾	72	8	12	4	LK-MPF-72H		\$317	\$331
	¾	84	8	14	4	LK-MPF-84T	\$220		
	¾	84	8	14	4	LK-MPF-84H		\$335	\$353
	¾	96	8	15	5	LK-MPF-96T	\$227		
	¾	96	8	15	5	LK-MPF-96H		\$352	\$373

Features:

- not intended to be used on a table with tilt bases.

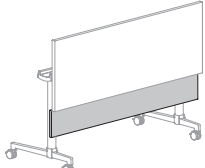
Description	D	W	H	CTN WT	CU FT	① Model	TFL	Standard	Graded In
								HPL 1	HPL 2
 Hinged Laminate Modesty Panel	¾	26	8	10	2	LK-MPH-26T	\$206		
	¾	26	8	10	2	LK-MPH-26H		\$284	\$292
	¾	30	8	10	2	LK-MPH-30T	\$208		
	¾	30	8	10	2	LK-MPH-30H		\$285	\$293
	¾	36	8	10	2	LK-MPH-36T	\$209		
	¾	36	8	10	2	LK-MPH-36H		\$287	\$296
	¾	48	8	10	3	LK-MPH-48T	\$217		
	¾	48	8	10	3	LK-MPH-48H		\$303	\$315
	¾	60	8	11	3	LK-MPH-60T	\$252		
	¾	60	8	11	3	LK-MPH-60H		\$349	\$362
	¾	66	8	12	3	LK-MPH-66T	\$257		
	¾	66	8	12	3	LK-MPH-66H		\$358	\$371
	¾	72	8	12	4	LK-MPH-72T	\$261		
	¾	72	8	12	4	LK-MPH-72H		\$366	\$383
	¾	84	8	14	4	LK-MPH-84T	\$269		
	¾	84	8	14	4	LK-MPH-84H		\$385	\$403
	¾	96	8	15	5	LK-MPH-96T	\$278		
	¾	96	8	15	5	LK-MPH-96H		\$403	\$425

Features:

- not intended to be used on a table with fixed bases.
- magnetic hinge holds modesty panel in vertical position
- magnetic hinge releases for self-storage when table is tilted

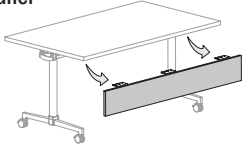
Description	D	W	H	CTN WT	CU FT	① Model	TFL	Standard	Graded In
								HPL 1	HPL 2
Removable Laminate Modesty Panel 	¾	26	8	10	2	LK-MPR-26T	\$206		
	¾	26	8	10	2	LK-MPR-26H		\$285	\$293
	¾	30	8	10	2	LK-MPR-30T	\$208		
	¾	30	8	10	2	LK-MPR-30H		\$286	\$294
	¾	36	8	10	2	LK-MPR-36T	\$210		
	¾	36	8	10	2	LK-MPR-36H		\$288	\$298
	¾	42	8	10	3	LK-MPR-42T	\$216		
	¾	42	8	10	3	LK-MPR-42H		\$302	\$314
	¾	48	8	10	3	LK-MPR-48T	\$218		
	¾	48	8	10	3	LK-MPR-48H		\$304	\$316
	¾	60	8	11	3	LK-MPR-60T	\$261		
	¾	60	8	11	3	LK-MPR-60H		\$357	\$369
	¾	66	8	12	3	LK-MPR-66T	\$265		
	¾	66	8	12	3	LK-MPR-66H		\$365	\$381
	¾	72	8	12	4	LK-MPR-72T	\$269		
	¾	72	8	12	4	LK-MPR-72H		\$374	\$391
	¾	84	8	14	4	LK-MPR-84T	\$278		
	¾	84	8	14	4	LK-MPR-84H		\$393	\$411
	¾	96	8	15	5	LK-MPR-96T	\$285		
	¾	96	8	15	5	LK-MPR-96H		\$409	\$432

Features:

- when selecting removable modesty panels on a tilt training table, modesty must be removed prior to tilting

To Order Specify

① Model #	②a Laminate Selection	②b PVC Edge Color
Model (LK)	See Laminate Selection	See PVC Edge Color Options

Model Number Breakdown

LK-MPF-48H				
LK	MPF	48	H	
LOK	Modesty Panel Fixed	48" Wide	HPL Laminate	

LOK - TRAINING

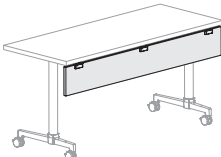
Description	D	W	H	CTN WT	CU FT	① Model	List Price
	¼	26	8	10	2	LK-MPF-26A	\$316
	¼	30	8	10	2	LK-MPF-30A	\$317
	¼	36	8	10	2	LK-MPF-36A	\$319
	¼	42	8	10	3	LK-MPF-42A	\$354
	¼	48	8	10	3	LK-MPF-48A	\$357
	¼	60	8	11	3	LK-MPF-60A	\$437
	¼	66	8	12	3	LK-MPF-66A	\$467
	¼	72	8	12	4	LK-MPF-72A	\$493
	¼	84	8	14	4	LK-MPF-84A	\$543
	¼	96	8	15	5	LK-MPF-96A	\$594

Features:

- not intended to be used on a table with tilt bases.

Options:

- specify trim cap; Matte Black (MBK), Pewter (PEW), Arctic Silver (ASL), Soft Nickel (SNK)

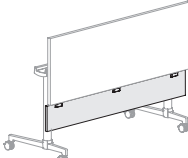
Description	D	W	H	CTN WT	CU FT	① Model	List Price
	¼	26	8	10	2	LK-MPH-26A	\$336
	¼	30	8	10	2	LK-MPH-30A	\$337
	¼	36	8	10	2	LK-MPH-36A	\$340
	¼	48	8	10	3	LK-MPH-48A	\$392
	¼	60	8	11	3	LK-MPH-60A	\$490
	¼	66	8	12	3	LK-MPH-66A	\$523
	¼	72	8	12	4	LK-MPH-72A	\$544
	¼	84	8	14	4	LK-MPH-84A	\$596
	¼	96	8	15	5	LK-MPH-96A	\$646

Features:

- not intended to be used on a table with fixed bases.
- magnetic hinge holds modesty panel in vertical position

Options:

- specify trim cap; Matte Black (MBK), Pewter (PEW), Arctic Silver (ASL), Soft Nickel (SNK)

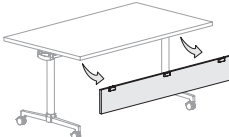
Description	D	W	H	CTN WT	CU FT	① Model	List Price
	¼	26	8	10	2	LK-MPR-26A	\$354
	¼	30	8	10	2	LK-MPR-30A	\$356
	¼	36	8	10	2	LK-MPR-36A	\$358
	¼	42	8	10	3	LK-MPR-42A	\$392
	¼	48	8	10	3	LK-MPR-48A	\$395
	¼	60	8	11	3	LK-MPR-60A	\$495
	¼	66	8	12	3	LK-MPR-66A	\$525
	¼	72	8	12	4	LK-MPR-72A	\$549
	¼	84	8	14	4	LK-MPR-84A	\$602
	¼	96	8	15	5	LK-MPR-96A	\$651

Features:

- when selecting removable modesty panels on a tilt training table, modesty must be removed prior to tilting

Options:

- specify trim cap; Matte Black (MBK), Pewter (PEW), Arctic Silver (ASL), Soft Nickel (SNK)

To Order Specify

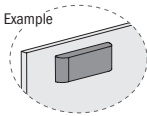
① Model #	② Trim Cap Finish
Lok (LK)	See Trim Cap Finish Options 

Model Number Breakdown

LK-MPF-48A				
LK	MPF	48	A	
LOK	Modesty Panel Fixed	48" Wide	Acrylic	

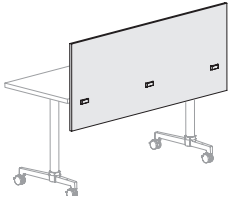
Description	D	W	H	CTN WT	CU FT	① Model	List Price
 Acoustic Privacy Screen	½	20	23 ¾	10	2	LK-PSP-2024P	\$401
	½	24	23 ¾	10	2	LK-PSP-2424P	\$445
	½	30	23 ¾	10	2	LK-PSP-3024P	\$521
	½	36	23 ¾	10	4	LK-PSP-3624P	\$528
	½	42	23 ¾	10	4	LK-PSP-4224P	\$685
	½	48	23 ¾	10	5	LK-PSP-4824P	\$692
	½	60	23 ¾	10	6	LK-PSP-6024P	\$1,179
	½	66	23 ¾	10	7	LK-PSP-6624P	\$1,182
	½	72	23 ¾	10	7	LK-PSP-7224P	\$1,187
	½	84	23 ¾	10	8	LK-PSP-8424P	\$1,195
½	96	23 ¾	10	9	LK-PSP-9624P	\$1,203	

Features:

- when adding privacy screen on tilting training table, privacy screen must be removed prior to tilting
- acoustic privacy screen can only be installed on straight edge of tables
- 13 ¾" height above surface

Options:

- specify Ash Grey (ASH) or Silver Grey (SIL)

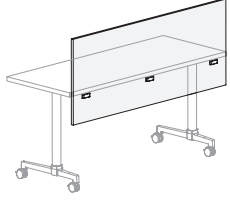
Description	D	W	H	CTN WT	CU FT	Model	List Price
 Frosted Acrylic Privacy Screen	¼	20	23 ¾	10	3	LK-PSP-2024A	\$387
	¼	24	23 ¾	10	3	LK-PSP-2424A	\$425
	¼	30	23 ¾	10	3	LK-PSP-3024A	\$482
	¼	36	23 ¾	10	3	LK-PSP-3624A	\$539
	¼	42	23 ¾	10	4	LK-PSP-4224A	\$614
	¼	48	23 ¾	10	5	LK-PSP-4824A	\$655
	¼	60	23 ¾	10	6	LK-PSP-6024A	\$805
	¼	66	23 ¾	10	7	LK-PSP-6624A	\$861
	¼	72	23 ¾	10	7	LK-PSP-7224A	\$919
	¼	84	23 ¾	10	8	LK-PSP-8424A	\$1,036
¼	96	23 ¾	10	9	LK-PSP-9624A	\$1,154	

Features:

- when adding privacy screen on tilting training table, privacy screen must be removed prior to tilting
- acrylic privacy screen can be installed on rectangular, crescent or lecture tables
- 13 ¾" height above surface

Options:

- specify trim cap; Matte Black (MBK), Pewter (PEW), Arctic Silver (ASL)

Model Number Breakdown

LK-PSP-4824A					
LK	PSP	48	24	A	
LOK	Privacy Screen Panel	48" Wide	24" Height	Acrylic	

Description	D	W	H	CTN WT	CU FT	① Model	List Price
Acoustic Portable Slide On Screen	1	24	21½	10	2	GP-PSO-2422P	\$814
	1	28	29½	14	3	GP-PSO-2830P	\$1,074

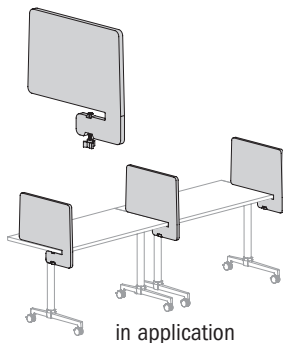

Features:

- works with any surface material
- works in any location, with the exception of where tilt release paddle is located on tilting tables
- GP-PSO-2422P - 16" height above surface; GP-PSO-2830P - 24" height above surface
- GP-PSO-2830P - not for use with surfaces 20" depth

Options:

- Specify Ash Grey (ASH) or Silver Grey (SIL)

Markerboard Portable Slide On Screen	1	28	29½	26	3	GP-PSO-2830MB	\$937
--------------------------------------	---	----	-----	----	---	---------------	-------

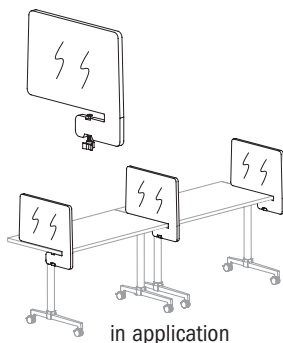

Features:

- works with any surface material
- works in any location, with the exception of where tilt release paddle is located on tilting tables
- not for use with surfaces 20" depth
- white marker laminate surfaces with white PVC edges
- 24" height above surface

Magnetic Markerboard Portable Slide On Screen	1	24	21½	10	2	GP-PSO-2422MMB	\$1,074
	1	28	29½	14	3	GP-PSO-2830MMB	\$1,583

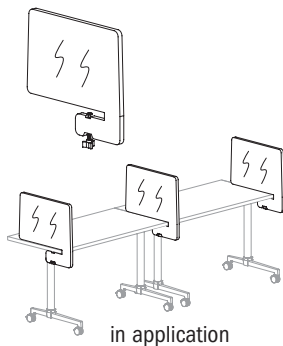

Features:

- works with any surface material
- works in any location, with the exception of where tilt release paddle is located on tilting tables
- GP-PSO-2422MMB - 16" height above surface; GP-PSO-2830MMB - 24" height above surface
- GP-PSO-2830MMB - not for use with surfaces 20" depth
- white magnetic marker laminate surfaces with white PVC edges

Model Number Breakdown

GP-PSO-2830MB						
GP	PSO	28	30	MB		
General Product	Portable Screen On	28" Wide	30" Height	Markerboard		

Description	D	W	H	CTN WT	CU FT	❶ Model	List Price
HPL Portable Slide On Screen	1	28	29 1/2	26	3	GP-PSO-2830H	\$988

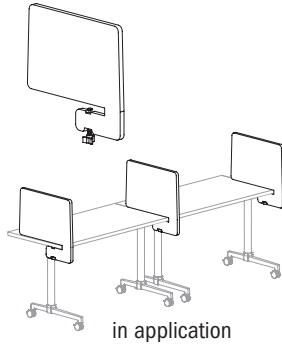

Features:

- works with any surface material
- works in any location, with the exception of where tilt release paddle is located on tilting tables
- 24" height above surface
- not for use with surfaces 20" depth

Options:

- specify standard JSI laminates with matching PVC edges, [see page 5](#)

Model Number Breakdown

GP-PSO-2830H					
GP	PSO	28	30	H	
General Product	Portable Screen On	28" Wide	30" Height	HPL	

LOK - TRAINING

Description	D	W	H	CTN WT	CU FT	① Model	TFL	Standard HPL 1
Rounded Arc Rectangular	26	66	42	51	38	LK-29IRL0-2666RT	\$2,298	\$2,462
Instructor Mobile Station Left with T Base	26	66	42	51	38	LK-29IRRO-2666RT	\$2,298	\$2,462
	26	66	42	51	38	LK-29IRL7-2666RT	\$2,454	\$2,617
	26	66	42	51	38	LK-29IRR7-2666RT	\$2,454	\$2,617
	26	72	42	56	41	LK-29IRL0-2672RT	\$2,311	\$2,484
	26	72	42	56	41	LK-29IRRO-2672RT	\$2,311	\$2,484
	26	72	42	56	41	LK-29IRL7-2672RT	\$2,466	\$2,639
	26	72	42	56	41	LK-29IRR7-2672RT	\$2,466	\$2,639

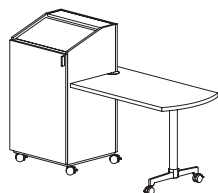
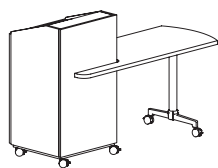

LK-29IRL7-2666RT
(door unit, left)

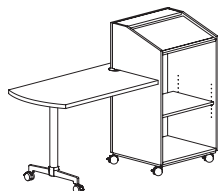

LK-29IRRO-2666RT
(open unit, right)

Features:

- price reflects complete station
- ships KD in multiple cartons
- one adjustable shelf in podium
- cable routing opening at back of podium slanted surface
- wire access grommets in surface of top, as well as side and bottom panel of podium
- hand of model dictates what side the podium is located from user side
- models ending in OT have open compartment, models ending in 7T have a door.
- table surface is at 29" high
- contact customer service for graded in HPL on worksurface pricing
- podium is always TFL

Options:

- order 48" fixed or removable modesty panel separately
- specify Podium grommet; None (GN) or tablet and cup holder grommets (GY) add \$94 list
- specify power option; see below

**Laminate Tops
"LKT" Models**

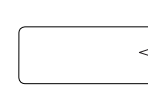

Eased Edge (R3)

To Order Specify

① Model #	②a Laminate Selection	②b PVC Edge Color	③ Grommet
Model (LK)	See Laminate Selection	See PVC Edge Color Options	GN No Grommet
			GY Tablet and Cup Holder Grommet
			④ Electrical
			N No Cutout
			CTEC23-CO EC23 - Cut Out Center of Top
			CTEC24-CO EC24 - Cut Out Center of Top
			⑤ Caster
			C Caster
			- BL Black Caster
			- WG White Caster w/ Grey Wheels
			⑥ Metal Finish
			See Metal Finish Color Options

Model Number Breakdown

LK-29IRL0-2672RT									
LK	29	IR	L	0	26	72	R	T	
LOK	Height	Rectangular Instructor Top	Left	Open Compartment	Depth	Wide	Rounded Arc	Laminate	

Description	D	W	H	CTN WT	CU FT	① Model	TFL	Standard HPL 1
Interactive Instructor Mobile Station Left with T Base	31	66	42	52	44	LK-29IIL0-3166T	\$2,382	\$2,523
	31	66	42	52	44	LK-29IIR0-3166T	\$2,382	\$2,523
	31	66	42	52	44	LK-29IIL7-3166T	\$2,537	\$2,678
	31	66	42	52	44	LK-29IIR7-3166T	\$2,537	\$2,678
	31	72	42	57	48	LK-29IIL0-3172T	\$2,395	\$2,549
	31	72	42	57	48	LK-29IIR0-3172T	\$2,395	\$2,549
	31	72	42	57	48	LK-29IIL7-3172T	\$2,551	\$2,703
	31	72	42	57	48	LK-29IIR7-3172T	\$2,551	\$2,703

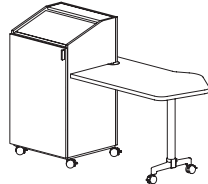
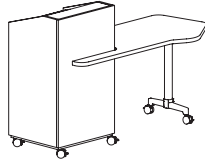

LK-29IIL7-3166T
(door unit, left)

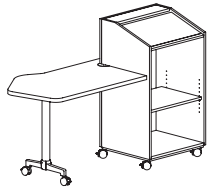

LK-29IIR0-3166T
(open unit, right)

Features:

- price reflects complete station
- ships KD in multiple cartons
- one adjustable shelf in podium
- cable routing opening at back of podium slanted surface
- wire access grommets in surface of top, as well as side and bottom panel of podium
- hand of model dictates what side the podium is located from user side
- models ending in OT have open compartment, models ending in 7T have a door.
- table surface is at 29" high
- contact customer service for graded in HPL on worksurface pricing
- podium is always TFL

Options:

- order 48" fixed or removable modesty panel separately
- specify Podium grommet; None (GN) or tablet and cup holder grommets (GY) add \$94 list
- specify power option; see below

**Laminate Tops
"LKT" Models**

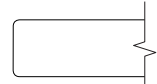

Eased Edge (R3)

To Order Specify

① Model #	②a Laminate Selection	②b PVC Edge Color	③ Grommet
Model (LK)	See Laminate Selection	See PVC Edge Color Options	④ Electrical GN No Grommet GY Tablet and Cup Holder Grommet N No Cutout CTEC23-CO EC23 - Cut Out Center of Top CTEC24-CO EC24 - Cut Out Center of Top ⑤ Caster C Caster - BL Black Caster - WG White Caster w/Grey Wheels ⑥ Metal Finish See Metal Finish Color Options

Model Number Breakdown

LK-29IIL0-3172T							
LK	29	II	L	7	26	72	T
LOK	Height	Interactive Instructor Top	Left	Door Unit	Depth	Wide	Laminate

Description	D	W	H	CTN WT	CU FT	① Model	List Price
Mobile Podium Open	22	24	42	18	19	LK-PDO-2224	\$1,558
	22	24	42	18	19	LK-PDL-2224	\$1,713
	22	24	42	18	19	LK-PDR-2224	\$1,713

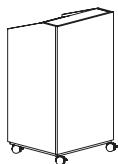

Features:

- one adjustable shelf
- wire access grommet in bottom panel
- cable routing opening at back of slanted surface

Options:

- specify grommet; None (GN) or tablet and cup holder grommets (GY) add \$94 list
- specify caster color option, Black (BL) or White with Grey Wheels (WG)

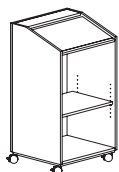

LK-PDO-2224
(open unit)

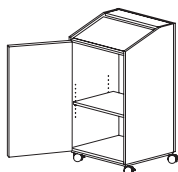

LK-PDR-2224
(door unit, right)

LOK - TRAINING

Description	D	W	H	CTN WT	CU FT	① Model	TFL	Standard	Graded In
								HPL 1	HPL 2
Adjustable Mobile Stand	22	24	29	36	14	LK-29ISA-2224T	\$1,769	\$1,872	\$1,885

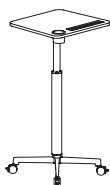

Features:

- pneumatic height adjustment range 29" - 41"

Options:

- specify caster color option, Black (BL) or White with Grey Wheels (WG)
- specify grommet; None (GN) or tablet and cup holder grommets (GY) add \$94 list

To Order Specify

① Model #	② Chasis	③ Grommet	④ Caster	⑤ Metal Finish
Model (LK)	See Laminate Selection	GN No Grommet GY Tablet and Cup Holder Grommet	C Caster - BL Black Caster - WG White Caster w/Grey Wheels	See Metal Finish Color Options

Model Number Breakdown

LK-PDL-2224					
LK	PD	L	22	24	
Lok	Podium	Left	22" Depth	24" Wide	

Description	D	W	H	CTN WT	CU FT	① Model	List Price
Marker Board Mobile Screen	27	36	72	75	13	LKB-MS-3672M	\$1,718
	27	48	72	95	16	LKB-MS-4872M	\$1,950

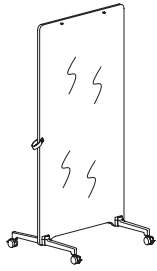

Features:

- marker board HPL on both surfaces
- capable for hanging flip charts on both sides

Options:

- specify caster color option, Black (BL) or White caster with Grey (WG)

Mobile Laminate Screen	27	36	72	75	13	LKB-MS-3672T	\$1,130
	27	48	72	95	16	LKB-MS-4872T	\$1,189

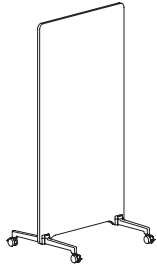

Features:

- laminate on both surfaces, [see page 5](#)

Options:

- specify caster color option, Black (BL) or White caster with Grey (WG)

Fixed Laminate Screen	27	36	72	75	13	LKB-FS-3672T	\$1,013
	27	48	72	95	16	LKB-FS-4872T	\$1,079

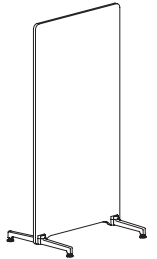

Features:

- laminate on both surfaces, [see page 5](#)
- black leveling glides

Model Number Breakdown

LKB-MS-3672M						
LKB	MS	36	72	M		
Lok	Mobile Screen	36" Wide	72" Height	Markerboard		

ECONO Power

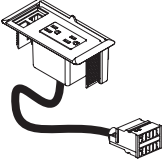
Description	D	W	H	CTN WT	CU FT	① Model	List Price
	36			4	1	EC-E-CT1-36	\$274
	48			4	1	EC-E-CT1-48	\$279
	60			4	1	EC-E-CT1-60	\$281
	66			4	1	EC-E-CT1-66	\$285
	72			5	1	EC-E-CT1-72	\$287
	84			5	1	EC-E-CT1-84	\$299
	96			5	1	EC-E-CT1-96	\$301

cables included:
1 male-to-male



Features:

- (1) econo electrical unit to be placed in top of surface
- use in conjunction with other econo electrical items
- table link bracket MUST be used in conjunction with electrical to meet code requirements
- data jack openings only accepts Type 2 jacks - two .58 x .76 hole openings (customer supplied)
- must order power infeed separately

	66			7	1	EC-E-LRT2-66	\$545
	72			7	1	EC-E-LRT2-72	\$545
	84			8	1	EC-E-LRT2-84	\$545
	96			8	1	EC-E-LRT2-96	\$549

cables included:
2 male-to-male

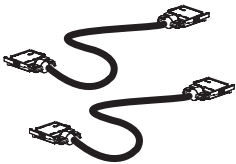

Features:

- (2) econo electrical unit to be placed in top of surface
- use in conjunction with other econo electrical items
- data jack openings accepts Type 2 jacks - two .58 x .76 hole openings (customer supplied)
- must order power infeed separately

Options:

- specify color black (BL) or grey (SG)

3 Prong Plug - 110 Power Smart-box Infeed for Econo System				1	1	EC-PI-E-72A	\$535
--	--	--	--	---	---	-------------	-------

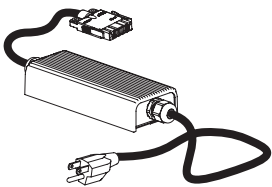

Features:

- 72" plug power infeed
- 20 amps/110 volts max
- 3 prong plug - 15 amp adapter plug
- single circuit use only
- use in conjunction with other econo electrical items

Electrical Jumper for Econo System	84			3	1	EC-E-J-84	\$129
------------------------------------	----	--	--	---	---	-----------	-------



Features:

- use to jump power around a corner configuration
- one male and one female H-block cable end

male

female

Data Jacks for ECONO

Description	D	W	H	CTN WT	CU FT	① Model	List Price
Telecom Phone Jack - Type 2				1	1	TCP201	\$70

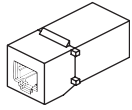

- Features:**
- RJ-11 phone jack
 - for use with Econo system

Telecom Data Jack - Type 2				1	1	TCP202	\$92
----------------------------	--	--	--	---	---	--------	------

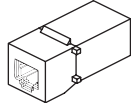

- Features:**
- CAT6-RJ45 data jack
 - for use with Econo system

TCP201 and TCP202 telecom jacks to be used with ECONO system

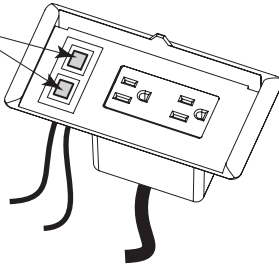

Corded Power

Description	D	W	H	CTN WT	CU FT	① Model	List Price
Moire Power Unit	3 3/8	3 3/8	2	5	1	EC23	\$496

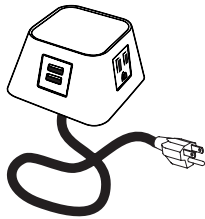

- Features:**
- three 110 outlets
 - dual USB-A charging ports
 - 72" 3-prong - 15amp plug power feed
 - 15amp/110 volt

- Options:**
- specify Black(BL) or White(WH)

Node Power Unit	3 3/8	3 3/8	3/8	5	1	EC24	\$396
-----------------	-------	-------	-----	---	---	------	-------

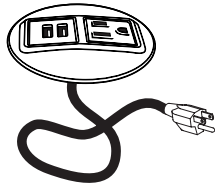

- Features:**
- one 110 outlet
 - dual USB-A charging ports
 - 72" 3-prong - 15amp plug power feed
 - 15amp/110 volt

- Options:**
- specify Black(BL) or White(WH)

Power Strip	1 1/2	1 7/8	8	3	1	GP9ACP1-0212	\$96
-------------	-------	-------	---	---	---	--------------	------

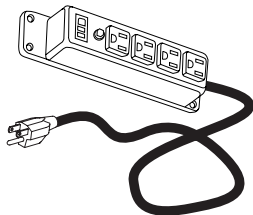

- Features:**
- power surge with 10" cord
 - four electrical outlets
 - includes switch
 - field installed
 - use in conjunction with other econo electrical items

LINK Power

Description	D	W	H	CTN WT	CU FT	① Model	List Price
Electrical CT1 for Link	36			4	1	EC-L-CT1-36	\$606
	48			4	1	EC-L-CT1-48	\$616
	60			4	1	EC-L-CT1-60	\$629
	66			4	1	EC-L-CT1-66	\$634
	72			5	1	EC-L-CT1-72	\$640
	84			5	1	EC-L-CT1-84	\$652
	96			5	1	EC-L-CT1-96	\$665

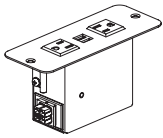

cables included:
1 female-to-female
1 male-to-female

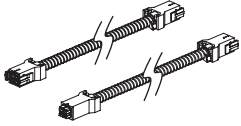

Features:

- (1) link electrical unit to be placed in top of surface
- use in conjunction with other link electrical items
- table link bracket MUST be used in conjunction with electrical to meet code requirements

Options:

- specify circuit (C1 or C2); specify color black (BL) or white (WH)
- must order power infeed separately

Electrical LRT2 for Link	66			7	1	EC-L-LRT2-66	\$1,111
	72			7	1	EC-L-LRT2-72	\$1,106
	84			8	1	EC-L-LRT2-84	\$1,117
	96			8	1	EC-L-LRT2-96	\$1,129

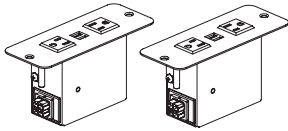

cables included:
2 female-to-female
1 male-to-female

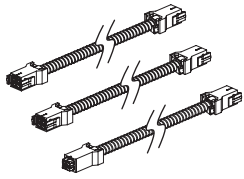

Features:

- (2) link electrical unit to be placed in top of surface
- use in conjunction with other link electrical items
- circuit 1 - 8 units can be connected on 3 prong infeed
- circuit 1 & 2 - 16 units (8) circuit 1 & (8) circuit 2 on hardwire or quick disconnect infeed options

Options:

- specify circuit (C1 or C2); specify color black (BL) or white (WH)
- must order power infeed separately

3 Prong Plug - 110 Power Infeed for Link System	72			1	1	EC-PI-L-72-A	\$280
---	----	--	--	---	---	--------------	-------

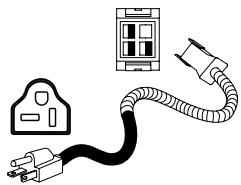

plug included:
15 amp adapter

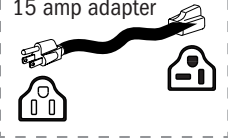

Features:

- 72" plug power infeed
- 20 amps/110 volts max
- 3 prong plug - 15 amp adapter plug
- single circuit use only
- use in conjunction with other link electrical items

Quick Disconnect Power Infeed for Link System				1	1	EC-PI-L-72-QD	\$234
---	--	--	--	---	---	---------------	-------

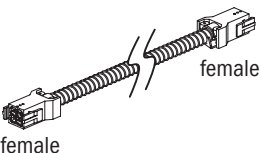

Features:

- must be used with QD1
- 72" modular power infeed
- 20 amps/120 volts max
- works for both single or double circuit
- use in conjunction with other link electrical items

LINK Power

Description	D	W	H	CTN WT	CU FT	❶ Model	List Price
Quick Disconnect Wall Outlet for Link System				1	1	EC-L-QD1	\$120

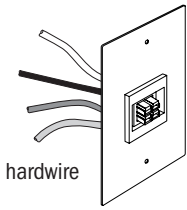

Features:

- must be used with MP72
- works for both single or double circuit
- 20 amps/120 volts max
- electrical contractor responsible for connection to building power source
- use in conjunction with other link electrical items

Hardwire Power Infeed for Link System	72			1	1	EC-PI-L-72-H	\$182
---------------------------------------	----	--	--	---	---	--------------	-------

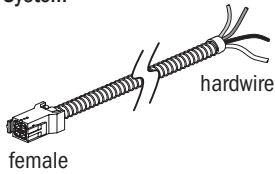

Features:

- 72" hardwire power infeed
- 20 amps/120 volts max
- single or two circuit
- electrical contractor responsible for connection to building power source
- use in conjunction with other link electrical items

Electrical Jumper for Link System	12			2	1	EC-L-J-12	\$116
-----------------------------------	----	--	--	---	---	-----------	-------

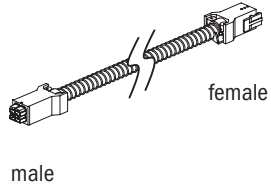

Features:

- use to jump power around a corner configuration
- use with Link EC-L-3W 3 way electrical connector when additional cable is required
- one male and one female cable end

3 way electrical connector for Link System				1	1	EC-L-3W	\$186
--	--	--	--	---	---	---------	-------

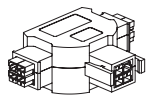

Features:

- branches power for infeed or T-connection
- two male and one female connector plugs
- may require repositioning of jumper cables

Wire Management

Description	D	W	H	CTN WT	CU FT	① Model	List Price
Vertical Wire Manager	2	2 ¼	17	1	1	AVL17	\$83
	2	2 ¼	22	1	1	AVL20	\$88
	2	2 ¼	25	1	1	AVL25	\$108

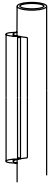

Features:

- field installed
- use AVL17 for 29" h tables
- use AVL20 for 36" h tables
- use AVL25 for 42" h tables

Options:

- specify plastic color, Black (B) or Silver (S)

Flexible Vertical Wire Manager	1 ½	1 ½	45	4	1	45VWM	\$135
--------------------------------	-----	-----	----	---	---	-------	-------



Features:

- black plastic
- field installed to bottom of table top, with screws provided
- wire manager is 1 ½" diameter
- weighted base is 4" diameter
- length can be adjusted by removing individual discs as required

Wire Management Velcro Straps	1 ¾	3 ½	¼	1	1	04WVS	\$58
-------------------------------	-----	-----	---	---	---	-------	------



Features:

- black, set of 4
- field installed to bottom of table top, with adhesive tape provided

Cable Management Clips	2 ⅝	3 ¾	1 ⅝	1	1	0304CMC	\$56
------------------------	-----	-----	-----	---	---	---------	------

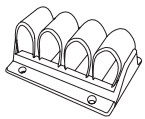

Features:

- black plastic
- installed to bottom of table top
- four retention loops

Wire Manager Trough	2 ½	12	2 ½	2	1	12WCT	\$123
	2 ½	24	2 ½	3	1	24WCT	\$143
	2 ½	36	2 ½	4	1	36WCT	\$157

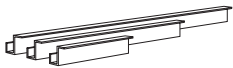

Features:

- black plastic
- field installed to bottom of table top, with screws provided

Wire Management Tray	7 ½	25	3	4	1	GP9WMT1-0825	\$191
	7 ½	35	3	6	1	GP9WMT1-0835	\$235
	7 ½	45	3	8	2	GP9WMT1-0845	\$279

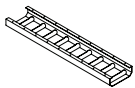

Features:

- silver powder-coated finish
- four hanging brackets (CI2C00)

Description	D	W	H	CTN WT	CU FT	① Model	List Price
Table Link Bracket	2 ¾	3	7	1	1	LKB03TBL-LINK	\$62

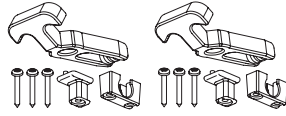

Features:

- includes set of 2 brackets with attachment hardware
- can be installed on ends and approach edges of tables
- field installed
- MUST be used tables specifying electrical

Screen Link Bracket	1 ¾	2 ¾	1 ½	1	1	LKB03SCN-LINK	\$75
---------------------	-----	-----	-----	---	---	---------------	------

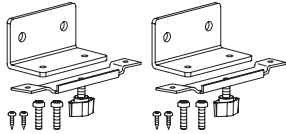

Features:

- links two tables along one edge with screen between tables
- set of 2 with attachment hardware
- field installed

Floor Mount Glide	3	2 ¼	½	1	1	LKB38-16ANCHOR	\$41
-------------------	---	-----	---	---	---	----------------	------

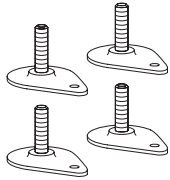

Features:

- field installed glides for mounting table base to floor
- ¼" diameter hole in the glide for mounting
- set of 4
- replaces standard leveling glide
- note: floor mounting hardware to be supplied by installer

Single Monitor Arm	4	11	10	9	1	GP5901MA	\$709
--------------------	---	----	----	---	---	----------	-------

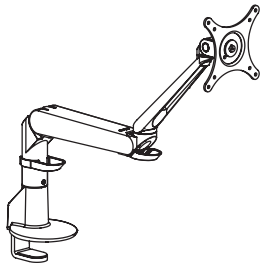

Features:

- one-touch reposition monitor adjustment
- tension adjustment at each joint
- flat panel mount rotates for portrait or landscape viewing
- edge mount installation from above surface
- cable management routes cables below monitor arm
- quick install VESA mount adapter

Options:

- specify Black (B) or Silver (S)

Accessories/ Keyboard/ Tasklights

For an additional list of electrical units, grommets, keyboards, wire management, monitor arms & telecom jacks, please see our [accessories price list](#)

Contact your customer service representative for specific questions regarding which units can be used with Lok Training.

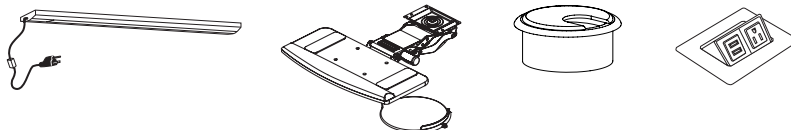

Page left intentionally blank



Training



Teamwork



Conference



Lounge

LOK - TEAMWORK

Lok - Teamwork

Product Information

Teamwork Overview 86
 Tables Shapes & Sizes 88-91
 Laminate Specifications 92
 Veneer Specifications 93
 Base Styles - Features 94
 Electrical Planning - Options 95

Pricing Pages

Teamwork Tables at Working Height . . . 96-129
 Teamwork Tables at Counter Height . . 130-133
 Teamwork Tables at Bar Height 134-167
 Electrical 168-169

Teamwork - Overview



rectangular
29"H - Pages 68, 72
36"H - Pages 116, 120
42"H - Pages 164, 168



rounded rectangular
29"H - Pages 70, 74
36"H - Pages 118, 122
42"H - Pages 166, 170



arc rectangular
29"H - Pages 76
36"H - Pages 124
42"H - Pages 172



rounded arc rectangular
29"H - Pages 78
36"H - Pages 126
42"H - Pages 174



racetrack
29"H - Pages 80
36"H - Pages 128
42"H - Pages 176

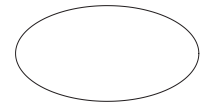

oval
29"H - Pages 82
36"H - Pages 130
42"H - Pages 178

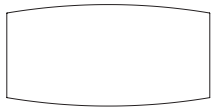

boat
29"H - Pages 84
36"H - Pages 132
42"H - Pages 180

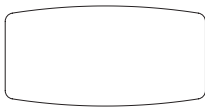

rounded boat
29"H - Pages 86
36"H - Pages 134
42"H - Pages 182

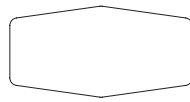

rounded double chevron
29"H - Pages 88
36"H - Pages 136
42"H - Pages 184

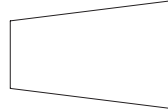

taper
29"H - Pages 90
36"H - Pages 138
42"H - Pages 186

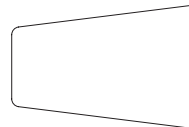

rounded taper
29"H - Pages 92
36"H - Pages 138
42"H - Pages 184

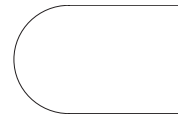

bullet
29"H - Pages 94
36"H - Pages 142
42"H - Pages 190

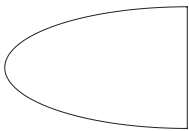

hive
29"H - Pages 96
36"H - Pages 144
42"H - Pages 192

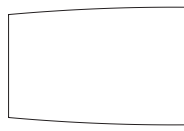

wedge
29"H - Pages 112
36"H - Pages 160
42"H - Pages 208

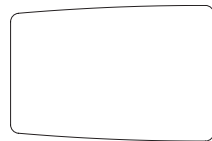

rounded wedge
29"H - Pages 114
36"H - Pages 162
42"H - Pages 210

Teamwork - Top Shapes

Lok offers 24 teamwork table top shapes. Tables are available in 29", 36" or 42" high and in laminate or veneer. Compatible bases are: T Base or X Base



rectangular

29"h

- 36" x 60" Seats 4
- 36" x 66" Seats 6
- 36" x 72" Seats 6
- 42" x 72" Seats 6
- 48" x 72" Seats 6

36"h

- 36" x 60" Seats 4
- 36" x 66" Seats 6
- 36" x 72" Seats 6
- 42" x 72" Seats 6
- 48" x 72" Seats 6

42"h

- 36" x 60" Seats 4
- 36" x 66" Seats 6
- 36" x 72" Seats 6
- 42" x 72" Seats 6
- 48" x 72" Seats 6



rounded rectangular

29"h

- 36" x 60" Seats 4
- 36" x 66" Seats 6
- 36" x 72" Seats 6
- 42" x 72" Seats 6
- 48" x 72" Seats 6

36"h

- 36" x 60" Seats 4
- 36" x 66" Seats 6
- 36" x 72" Seats 6
- 42" x 72" Seats 6
- 48" x 72" Seats 6

42"h

- 36" x 60" Seats 4
- 36" x 66" Seats 6
- 36" x 72" Seats 6
- 42" x 72" Seats 6
- 48" x 72" Seats 6



arc rectangular

29"h

- 36" x 60" Seats 4
- 36" x 66" Seats 6
- 36" x 72" Seats 6
- 42" x 72" Seats 6
- 48" x 72" Seats 6

36"h

- 36" x 60" Seats 4
- 36" x 66" Seats 6
- 36" x 72" Seats 6
- 42" x 72" Seats 6
- 48" x 72" Seats 6

42"h

- 36" x 60" Seats 4
- 36" x 66" Seats 6
- 36" x 72" Seats 6
- 42" x 72" Seats 6
- 48" x 72" Seats 6



rounded arc rectangular

29"h

- 36" x 60" Seats 4
- 36" x 66" Seats 6
- 36" x 72" Seats 6
- 42" x 72" Seats 6
- 48" x 72" Seats 6

36"h

- 36" x 60" Seats 4
- 36" x 66" Seats 6
- 36" x 72" Seats 6
- 42" x 72" Seats 6
- 48" x 72" Seats 6

42"h

- 36" x 60" Seats 4
- 36" x 66" Seats 6
- 36" x 72" Seats 6
- 42" x 72" Seats 6
- 48" x 72" Seats 6



racetrack

29"h

- 36" x 60" Seats 4
- 36" x 66" Seats 6
- 36" x 72" Seats 6
- 42" x 72" Seats 6
- 48" x 72" Seats 6

36"h

- 36" x 60" Seats 4
- 36" x 66" Seats 6
- 36" x 72" Seats 6
- 42" x 72" Seats 6
- 48" x 72" Seats 6

42"h

- 36" x 60" Seats 4
- 36" x 66" Seats 6
- 36" x 72" Seats 6
- 42" x 72" Seats 6
- 48" x 72" Seats 6

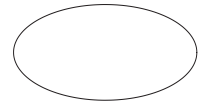

oval

29"h

- 36" x 72" Seats 6

36"h

- 36" x 72" Seats 6

42"h

- 36" x 72" Seats 6

LOK - TEAMWORK

Teamwork - Top Shapes

Lok offers 24 teamwork table top shapes. Tables are available in 29", 36" or 42" high and in laminate or veneer. Compatible bases are: T Base or X Base

LOK - TEAMWORK

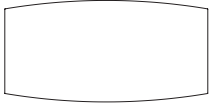

boat
29"h
36" x 60" Seats 4
36" x 66" Seats 6
36" x 72" Seats 6
42" x 72" Seats 6
48" x 72" Seats 6

36"h
36" x 60" Seats 4
36" x 66" Seats 6
36" x 72" Seats 6
42" x 72" Seats 6
48" x 72" Seats 6

42"h
36" x 60" Seats 4
36" x 66" Seats 6
36" x 72" Seats 6
42" x 72" Seats 6
48" x 72" Seats 6

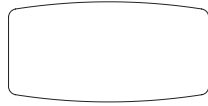

rounded boat
29"h
36" x 60" Seats 4
36" x 66" Seats 6
36" x 72" Seats 6
42" x 72" Seats 6
48" x 72" Seats 6

36"h
36" x 60" Seats 4
36" x 66" Seats 6
36" x 72" Seats 6
42" x 72" Seats 6
48" x 72" Seats 6

42"h
36" x 60" Seats 4
36" x 66" Seats 6
36" x 72" Seats 6
42" x 72" Seats 6
48" x 72" Seats 6

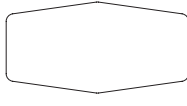

rounded double chevron
29"h
36" x 60" Seats 4
36" x 72" Seats 6
42" x 72" Seats 6
48" x 72" Seats 6

36"h
36" x 60" Seats 4
36" x 72" Seats 6
42" x 72" Seats 6
48" x 72" Seats 6

42"h
36" x 60" Seats 4
36" x 72" Seats 6
42" x 72" Seats 6
48" x 72" Seats 6

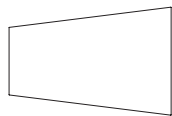

taper
29"h
48" x 72" Seats 6

36"h
48" x 72" Seats 6

42"h
48" x 72" Seats 6

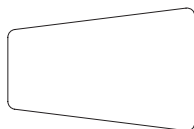

rounded taper
29"h
48" x 72" Seats 6

36"h
48" x 72" Seats 6

42"h
48" x 72" Seats 6

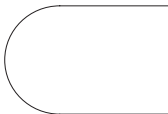

bullet
29"h
48" x 72" Seats 6

36"h
48" x 72" Seats 6

42"h
48" x 72" Seats 6

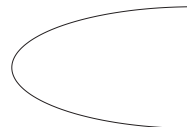

hive
29"h
48" x 72" Seats 6

36"h
48" x 72" Seats 6

42"h
48" x 72" Seats 6

Teamwork - Top Shapes cont.

Lok offers 24 teamwork table top shapes. Tables are available in 29", 36" or 42" high and in laminate or veneer. Compatible bases are: T Base or X Base

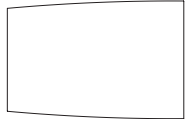

wedge

29"h

48" x 72" Seats 6

36"h

48" x 72" Seats 6

42"h

48" x 72" Seats 6

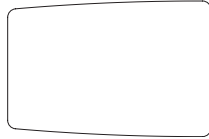

rounded wedge

29"h

48" x 72" Seats 6

36"h

48" x 72" Seats 6

42"h

48" x 72" Seats 6

Teamwork - Materials

Laminate Tops

HPL tops are 1 3/16" thick, 3 ply balanced construction. The laminate face is horizontal grade high pressure laminate. Particle board core and a phenolic backer sheet complete the balanced construction.

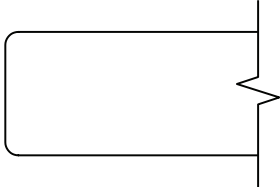

Eased Edge (R3)
PVC

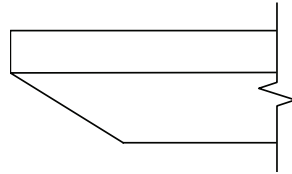

Reverse Bevel (K9)
PVC on painted top of painted MDF

Standard PVC Edge Colors

JSI supports 26 standard PVC edge colors listed below. These coordinate with our Standard (Tier1) Laminates.

When selecting a Standard (Tier 1) Laminate, the coordinating PVC edge color is automatically applied. When selecting a Graded-In Laminate (Tier 2), you will be prompted to choose one these 26 PVC edge colors to be applied to the edge.

ALB Alabaster	MES Mesa
BEL Belair	MIN Mineral
BLK Black	MCH Mocha
BRK Brickdust	OBK Outback
BBL Bridal Blanco	PIL Pilsner
CSK Cask	PIN Pinnacle Walnut
CLY Clay	SHD Shadow
DWH Designer White	SLG Slate Grey
EGR Egret	UMB Umber
FAW Fawn	VAL Valley
FLN Flint	WAL Walnut Heights
FLO Florence Walnut	WEA Weathered Ash
LOF Loft	ZEN Zen Grey

Standard Laminates

JSI Standard Laminate program consists of 26 solid and wood grain patterns, and establish our Tier 1 laminate pricing. Each has a coordinating PVC edge color that is automatically used with the Standard Laminates.

Wood Grain Laminate

BEL Belair	MIN Mineral
BRK Brickdust	MCH Mocha
CSK Cask	OBK Outback
CLY Clay	PIL Pilsner
EGR Egret	PIN Pinnacle Walnut
FAW Fawn	UMB Umber
FLN Flint	VAL Valley
FLO Florence Walnut	WLH Walnut Heights
LOF Loft	WEA Weathered Ash
MES Mesa	

Solid Laminate

ALB Alabaster
BLK Black
BBL Bridal Blanco
DWH Designer White
SHD Shadow
SLG Slate Grey
ZEN Zen Grey

Teamwork - Materials cont.

Veneer Tops

Tops are 1 3/16" thick, 5-ply balanced construction with particle board core. Standard Tier 1 Essentials veneer is book matched for cherry, maple, walnut and black oak veneer. Standard Tier 2 veneer is Artisan.

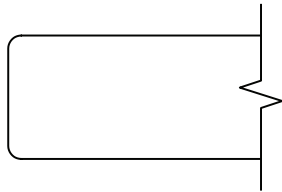

Eased Edge (R3)
Internal Lumber Band

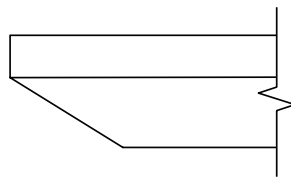

Reverse Bevel (K9)
Veneer Band on Stained MDF

Finish - Stain/Colors

ESS Essentials Veneer Collection

BRK Brickdust	MIN Mineral
CSK Cask	MCH Mocha
CLY Clay	OBK Outback
FAW Fawn	PIL Pilsner
FLX Flax	SIE Sienna
FLN Flint	TRF Truffle
LOF Loft	UMB Umber
MES Mesa	VAL Valley

ART Artisan Veneer Collection

BAR Barrel	RAV Raven
BUF Buff	RYE Rye
CND Cinder	SAB Sable
EGR Egret	SAD Saddle

Protective Top Coat

DuraTex™ offers exceptional hardness along with abrasion and impact resistance, it has been formulated to eliminate hazardous and harmful gases that are normally associated with wood finish.

DuraTex™ Features

Safety - Significantly reduces hazardous formaldehyde emissions which help improve the quality of the of the indoor air we breathe.

Quality - Developed to be tough and durable with special attention to appearance. The DuraTex™ finish preserves the natural beauty of wood.

Durability - Designed to meet a wide range of demanding performance and environmental standards to withstand even the highest wear and tear.

Finish Sheen

All veneer finishes are standard in 35-sheen, with the exception of Raven. Raven is only offered in 15-sheen. All other finishes can have their sheen modified with a 15% upcharge added to the list price of each item.

Custom/Special Finishes

JSI, upon request, will accommodate special finishes. A written request is required to proceed with custom finish orders. A sample reference is required for first-time matches and must be included with the written request.

There is a one-time charge of **\$384 list per order** for any non-standard wood finish.

Orders will be entered noting the special finish. A sample match will be provided to the customer. Written approval is needed before the finish process can be started. Delays in approval may have an impact on lead times.

Every effort will be made to create the requested match; however, an acceptable match may not be possible because of natural variations of wood. These natural variations can also cause minor differences in the final finish product.

Use standard pricing and option pricing for each line item with a special finish, unless additional modifications have been specified. For items available in both Essential and Artisan veneers, apply the Essentials pricing.

Teamwork - Base Styles

Lok provides a choice selection of bases in both function and aesthetics to serve a variety of needs. The teamwork offering includes: T-base and X-base

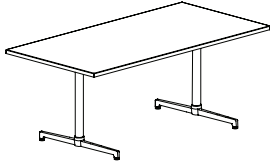

T-Base

- available in 29" with options of glide or caster
- available in 36"h and 42"h only in glides
- compatible with the following top shapes: arc rectangular, boat, boomerang, bullet, double chevron, hive, home base, huddle, intersect, one-twenty, racetrack, rectangular, taper, wedge
- base finish - select single metal finish or two-tone metal finish. See options listed below.

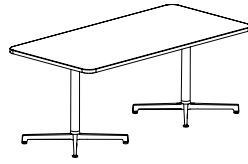

X-Base

- available in 16", 29"h, 36"h or 42"h only in glides.
- compatible with the following top shapes: rectangular, round, square, squircle
- base finish - select single metal finish or two-tone metal finish. See options listed below.

Single Metal Finish

- ABZ** Aged Bronze Feet & Post
- ASL** Arctic Silver Feet & Post
- GLD** Gold Feet & Post
- PEW** Pewter Feet & Post
- MBK** Matte Black Feet & Post
- SBZ** Soft Bronze Feet & Post
- SNK** Soft Nickel Feet & Post

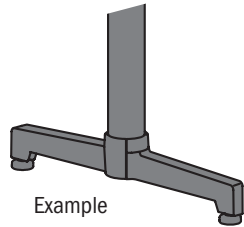

Example

Two - Tone Metal Finish

Two-Tone Aesthetics can be achieved by specifying Polished Aluminum on the foot and a contrasting finish on the post

Polished Aluminum Feet

- ABZ** Aged Bronze Post
- ASL** Arctic Silver Post
- GLD** Gold Post
- PEW** Pewter Post
- MBK** Matte Black Post
- SBZ** Soft Bronze Post
- SNK** Soft Nickel Post

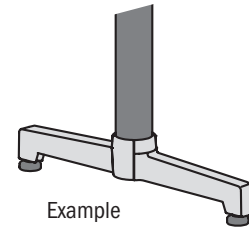

Example

Power/Charging Options

Lok offers the ability to place power and charging options in the center of select tables. Select your choice of EC23 or EC24, available in black and white.

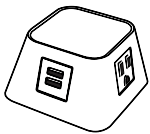

Moire - EC23

- Three 110 outlets
- Dual USB port with 72" power cord
- Black (B) or White (W)

select CTEC23 for cutout in worksurfaces



Node - EC24

- One 110 outlet
- Dual USB port with 72" power cord
- Black (B) or White (W)

select CTEC24 for cutout in worksurfaces

Cut outs are located in the center of each table. See below for representation or location.

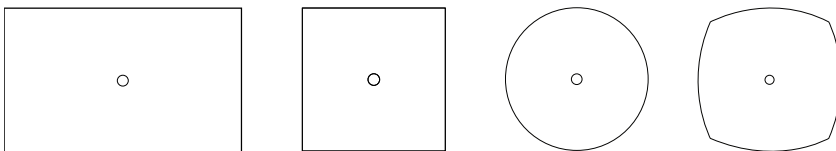

Teamwork - Electrical

Electrical Overview

Lok provides several packages to choose from for your electrical needs. Choose solutions for top surface power, underneath outlets, wireless charging, or a combination.

Specifying an electrical package eliminates your need to calculate additional components, as all units and necessary jumpers will ship with your table. You will only need to determine which power in-feed best suits your needs and order separately.

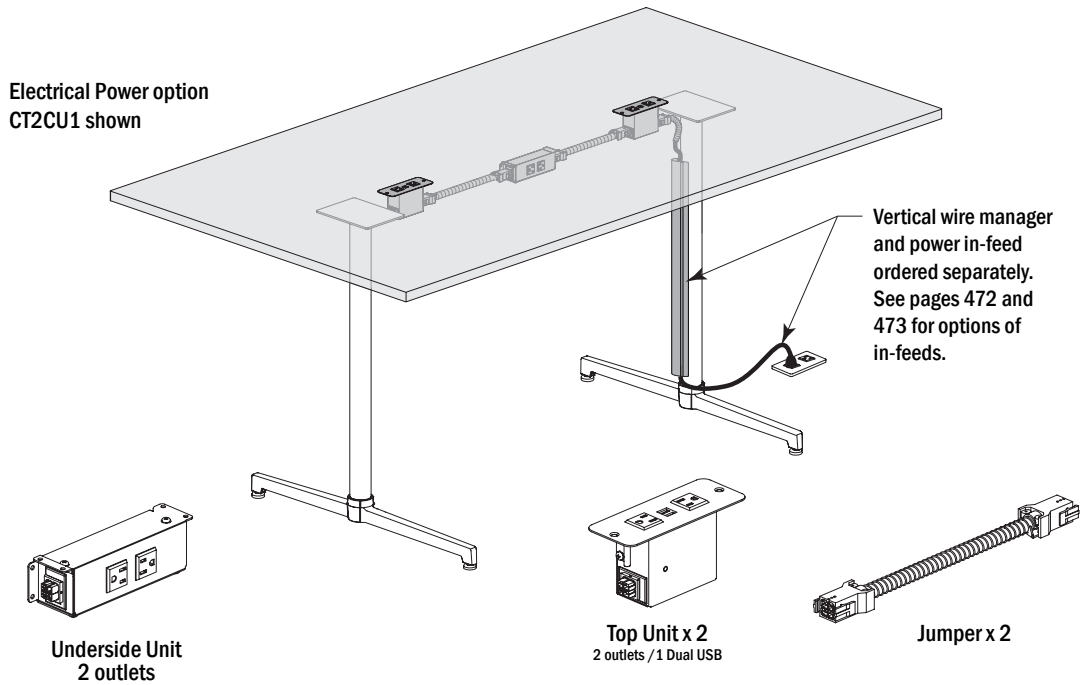

LOK - TEAMWORK

Electrical

Power and Charging Packages are measured and located out from the center of the table. Shown on rectangular tops, these dimensions are the same from center regardless of table shape (ie huddle, boomerang, etc.). Power in-feed is specified separately to support building electrical connection.

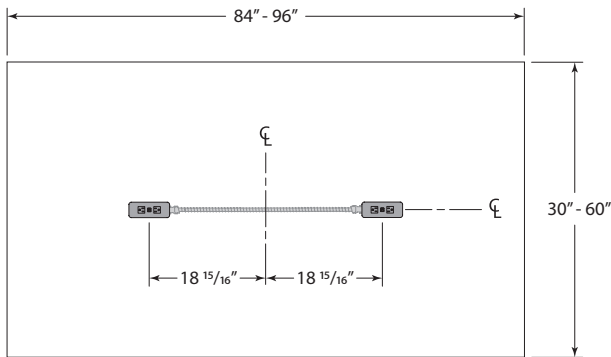

CT2 - Dual Power Top of Surface

Description

Rectangular Table with T Base at Working Height

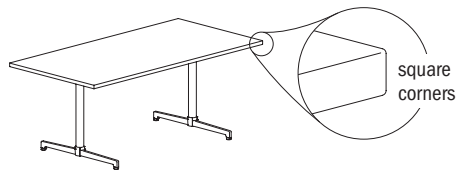

Laminate Tables "LKT" Models

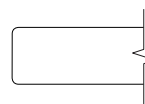

Eased Edge (R3)

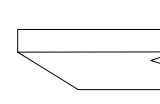

Reverse Bevel Edge (K9)

LAMINATE	D	W	H	CTN WT	CU FT	Model	Standard Tier 1	Graded In Tier 2	Standard Tier 1	Graded In Tier 2
	48	72	29	148	71	LKT4872-29TTT	\$2,145	\$2,191	\$2,682	\$2,727
	42	72	29	143	63	LKT4272-29TTT	\$2,042	\$2,081	\$2,565	\$2,604
	36	72	29	132	56	LKT3672-29TTT	\$1,864	\$1,935	\$2,333	\$2,403
	36	66	29	123	51	LKT3666-29TTT	\$1,797	\$1,864	\$2,266	\$2,333
	36	60	29	115	46	LKT3660-29TTT	\$1,718	\$1,781	\$2,185	\$2,248

Features:

- price reflects complete table - top and base
- ships KD in multiple cartons

Options:

- specify power/charging option, see below for options and upcharges
- specify glide (G) or caster (C) -choice of black (BL) or white/grey casters (WG)



top shape

LOK - TEAMWORK

To Order Specify

1 Laminate Model #	2 Edge Detail	3 Laminate Selection	3a PVC Edge Color	4 Electrical
Laminate (LKT)	See Edge Detail Options	See Laminate Selection	See PVC Edge Color Options	N None CT2 Dual Power Center Top (See chart on next page) CU1 Single Power Underside 5 Foot/Caster G Glide C Caster - BL Black Caster - WG White Caster w/Grey Wheels 6 Metal Finish See Metal Finish Color Options

Model Number Breakdown

LKT4872-29TTT					
LK	T	4872	29	TT	T
LOK	Laminate	48" x 72"	Height	Rectangular Top Shape	T base

Description

Rectangular Table with T Base
at Working Height
(continued)

Veneer Tables
"LKV" Models

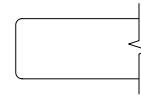

Eased Edge (R3)

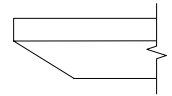

Reverse Bevel Edge (K9)

VENEER	D	W	H	CTN WT	CU FT	① Model	Essentials	Artisan	Essentials	Artisan
		48	72	29	148	71	LKV4872-29TTT	\$2,472	\$2,711	\$2,732
	42	72	29	143	63	LKV4272-29TTT	\$2,360	\$2,574	\$2,612	\$2,804
	36	72	29	132	56	LKV3672-29TTT	\$2,177	\$2,384	\$2,357	\$2,560
	36	66	29	123	51	LKV3666-29TTT	\$2,132	\$2,323	\$2,307	\$2,494
	36	60	29	115	46	LKV3660-29TTT	\$2,068	\$2,247	\$2,237	\$2,413

LOK - TEAMWORK

Electrical Options and Upcharges

CT2	
Dual Power Center Top - Black	CT2BL - add \$1,481
Dual Power Center Top - White	CT2WH - add \$1,481
CU1	
Single Power Underside - Black	CU11C - add \$576
Single Power Underside with Wireless Charging - Black	CU11CW - add \$1,379

Note: Order power infeed that best fits application

To Order, Specify:

① Veneer Model #	② Edge Detail	③ Wood Collection	④ Top Wood Finish	⑤ Electrical	⑥ Base - Foot/Caster	⑦ Metal Color
Veneer (LKV)	See Edge Detail Options	Essentials	See Essentials Top Wood Finish Options	N None CT2 Dual Power Center Top CU1 Single Power Underside (See chart above)	G Glide C Caster - BL Black Caster - WG White Caster with Grey Wheels	See Metal Finish Color Options
		Artisan	④ Top Wood Finish See Artisan Top Wood Finish Options			

Description

Rounded Rectangular Table with T Base at Working Height

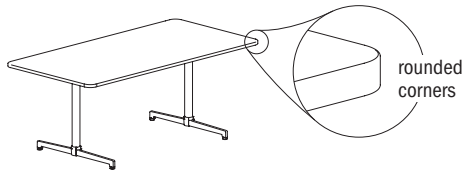

Laminate Tables
"LKT" Models

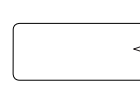

Eased Edge (R3)

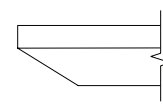

Reverse Bevel Edge (K9)

D	W	H	CTN WT	CU FT	Model	Eased Edge (R3)		Reverse Bevel Edge (K9)	
						Standard Tier 1	Graded In Tier 2	Standard Tier 1	Graded In Tier 2
48	72	29	148	71	LKT4872-29TTRT	\$2,208	\$2,253	\$2,743	\$2,791
42	72	29	143	63	LKT4272-29TTRT	\$2,101	\$2,139	\$2,624	\$2,665
36	72	29	132	56	LKT3672-29TTRT	\$1,966	\$2,039	\$2,435	\$2,506
36	66	29	123	51	LKT3666-29TTRT	\$1,905	\$1,973	\$2,375	\$2,443
36	60	29	115	46	LKT3660-29TTRT	\$1,833	\$1,897	\$2,303	\$2,368

Features:

- price reflects complete table - top and base
- ships KD in multiple cartons

Options:

- specify power/charging option, see below for options and upcharges
- specify glide (G) or caster (C) -choice of black (BL) or white/grey casters (WG)



top shape

LOK - TEAMWORK

To Order Specify

1 Laminate Model #	2 Edge Detail	3 Laminate Selection	3a PVC Edge Color	4 Electrical
Laminate (LKT)	See Edge Detail Options	See Laminate Selection	See PVC Edge Color Options	N None CT2 Dual Power Center Top (See chart on next page) CU1 Single Power Underside 5 Foot/Caster G Glide C Caster - BL Black Caster - WG White Caster w/Grey Wheels 6 Metal Finish See Metal Finish Color Options

Model Number Breakdown

LKT4872-29TTRT						
LK	T	4872	29	TT	R	T
LOK	Laminate	48" x 72"	Height	Rectangular Top Shape	Rounded Corner	T base

Description

Rounded Rectangular Table with T Base at Working Height (continued)

Veneer Tables "LKV" Models

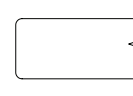

Eased Edge (R3)

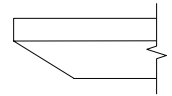

Reverse Bevel Edge (K9)

D	W	H	CTN WT	CU FT	Model	Eased Edge (R3)		Reverse Bevel Edge (K9)	
						Essentials	Artisan	Essentials	Artisan
48	72	29	148	71	LKV4872-29TTRT	\$2,536	\$2,775	\$2,796	\$3,016
42	72	29	143	63	LKV4272-29TTRT	\$2,421	\$2,633	\$2,669	\$2,863
36	72	29	132	56	LKV3672-29TTRT	\$2,340	\$2,557	\$2,428	\$2,634
36	66	29	123	51	LKV3666-29TTRT	\$2,291	\$2,494	\$2,378	\$2,566
36	60	29	115	46	LKV3660-29TTRT	\$2,223	\$2,413	\$2,306	\$2,481

VENEER

LOK - TEAMWORK

Electrical Options and Upcharges

CT2	
Dual Power Center Top - Black	CT2BL - add \$1,481
Dual Power Center Top - White	CT2WH - add \$1,481
CU1	
Single Power Underside - Black	CU11C - add \$576
Single Power Underside with Wireless Charging - Black	CU11CW - add \$1,379

Note: Order power infeed that best fits application

To Order, Specify:

1 Veneer Model #	2 Edge Detail	3 Wood Collection	4 Top Wood Finish	5 Electrical	6 Base - Foot/Caster	7 Metal Color
Veneer (LKV)	See Edge Detail Options	Essentials	See Essentials Top Wood Finish Options	N None CT2 Dual Power Center Top CU1 Single Power Underside (See chart above)	G Glide C Caster - BL Black Caster - WG White Caster with Grey Wheels	See Metal Finish Color Options
		Artisan	4 Top Wood Finish See Artisan Top Wood Finish Options			

Description

Rectangular Table with X Base at Working Height

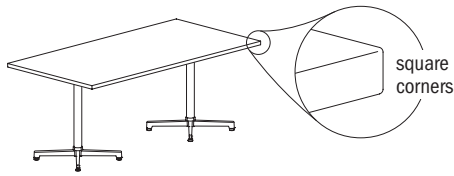

Laminate Tables "LKT" Models

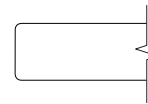

Eased Edge (R3)

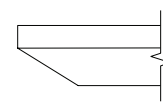

Reverse Bevel Edge (K9)

LAMINATE	D	W	H	CTN WT	CU FT	Model	Standard Tier 1	Graded In Tier 2	Standard Tier 1	Graded In Tier 2
		48	72	29	163	71	LKT4872-29TTX	\$2,768	\$2,813	\$3,305
	42	72	29	147	63	LKT4272-29TTX	\$2,665	\$2,705	\$3,189	\$3,230
	36	72	29	130	55	LKT3672-29TTX	\$2,439	\$2,511	\$2,907	\$2,978

Features:

- price reflects complete table - top and base
- ships KD in multiple cartons

Options:

- specify power/charging option, see below for options and upcharges



top shape

LOK - TEAMWORK

To Order Specify

1 Laminates Model #	2 Edge Detail	3 Laminates Selection	3a PVC Edge Color	4 Electrical
Laminates (LKT)	See Edge Detail Options	See Laminates Selection	See PVC Edge Color Options	N None CT2 Dual Power Center Top (See chart on next page) CU1 Single Power Underside 5 Metal Finish See Metal Finish Color Options

Model Number Breakdown

LKT4872-29TTX					
LK	T	4872	29	TT	X
LOK	Laminates	48" x 72"	Height	Rectangular Top Shape	X base

Description

Rectangular Table with X Base
at Working Height
(continued)

Veneer Tables
"LKV" Models

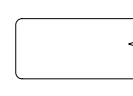

Eased Edge (R3)

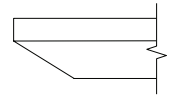

Reverse Bevel Edge (K9)

VENEER	D	W	H	CTN WT	CU FT	① Model	Essentials	Artisan	Essentials	Artisan
	48	72	29	163	71	LKV4872-29TTX	\$3,098	\$3,336	\$3,356	\$3,577
42	72	29	147	63	LKV4272-29TTX	\$2,985	\$3,196	\$3,235	\$3,429	
36	72	29	130	55	LKV3672-29TTX	\$2,754	\$2,962	\$2,934	\$3,136	

LOK - TEAMWORK

Electrical Options and Upcharges

CT2	
Dual Power Center Top - Black	CT2BL - add \$1,481
Dual Power Center Top - White	CT2WH - add \$1,481
CU1	
Single Power Underside - Black	CU11C - add \$576
Single Power Underside with Wireless Charging - Black	CU11CW - add \$1,379

Note: Order power infeed that best fits application

To Order, Specify:

① Veneer Model #	② Edge Detail	③ Wood Collection	④ Top Wood Finish	⑤ Electrical	⑥ Metal Color
Veneer (LKV)	See Edge Detail Options	Essentials	See Essentials Top Wood Finish Options	N None CT2 Dual Power Center Top CU1 Single Power Underside (See chart above)	See Metal Finish Color Options
		Artisan	④ Top Wood Finish See Artisan Top Wood Finish Options		

Description

Rounded Rectangular Table with X Base at Working Height

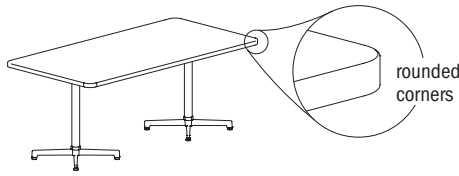

Laminate Tables
"LKT" Models

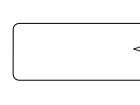

Eased Edge (R3)

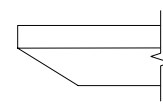

Reverse Bevel Edge (K9)

LAMINATE	D	W	H	CTN WT	CU FT	1 Model	Standard Tier 1	Graded In Tier 2	Standard Tier 1	Graded In Tier 2
		48	72	29	163	71	LKT4872-29TTRX	\$2,832	\$2,877	\$3,367
	42	72	29	147	63	LKT4272-29TTRX	\$2,723	\$2,763	\$3,247	\$3,286
	36	72	29	125	55	LKT3672-29TTRX	\$2,543	\$2,614	\$3,011	\$3,081

Features:

- price reflects complete table - top and base
- ships KD in multiple cartons

Options:

- specify power/charging option, see below for options and upcharges



top shape

LOK - TEAMWORK

To Order Specify

1 Laminates Model #	2 Edge Detail	3 Laminates Selection	3a PVC Edge Color	4 Electrical
Laminates (LKT)	See Edge Detail Options	See Laminates Selection	See PVC Edge Color Options	N None CT2 Dual Power Center Top (See chart on next page) CU1 Single Power Underside 5 Metal Finish See Metal Finish Color Options

Model Number Breakdown

LKT4872-29TTRX						
LK	T	4872	29	TT	R	X
LOK	Laminates	48" x 72"	Height	Rectangular Top Shape	Rounded Corner	X base

Description

Rounded Rectangular Table with X Base at Working Height (continued)

Veneer Tables "LKV" Models

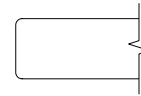

Eased Edge (R3)

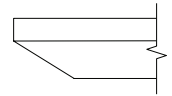

Reverse Bevel Edge (K9)

VENEER	D	W	H	CTN WT	CU FT	① Model	Essentials	Artisan	Essentials	Artisan
	48	72	29	163	71	LKV4872-29TTRX	\$3,157	\$3,397	\$3,419	\$3,641
42	72	29	147	63	LKV4272-29TTRX	\$3,044	\$3,256	\$3,293	\$3,487	
36	72	29	130	55	LKV3672-29TTRX	\$2,950	\$3,168	\$3,041	\$3,245	

LOK - TEAMWORK

Electrical Options and Upcharges

CT2	
Dual Power Center Top - Black	CT2BL - add \$1,481
Dual Power Center Top - White	CT2WH - add \$1,481
CU1	
Single Power Underside - Black	CU11C - add \$576
Single Power Underside with Wireless Charging - Black	CU11CW - add \$1,379

Note: Order power infeed that best fits application

To Order, Specify:

① Veneer Model #	② Edge Detail	③ Wood Collection	④ Top Wood Finish	⑤ Electrical	⑥ Metal Color
Veneer (LKV)	See Edge Detail Options	Essentials	See Essentials Top Wood Finish Options	N None CT2 Dual Power Center Top CU1 Single Power Underside (See chart above)	See Metal Finish Color Options
		Artisan	④ Top Wood Finish See Artisan Top Wood Finish Options		

Description

Arc Rectangular Table with T Base at Working Height

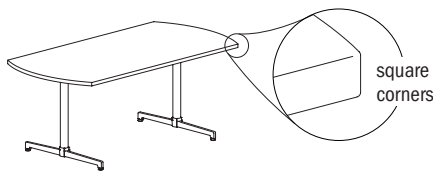

Laminate Tables
"LKT" Models

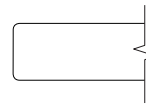

Eased Edge (R3)

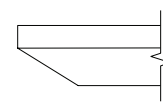

Reverse Bevel Edge (K9)

D	W	H	CTN WT	CU FT	Model	Eased Edge (R3)		Reverse Bevel Edge (K9)	
						Standard Tier 1	Graded In Tier 2	Standard Tier 1	Graded In Tier 2
48	72	29	148	71	LKT4872-29ART	\$2,104	\$2,147	\$2,614	\$2,657
42	72	29	140	63	LKT4272-29ART	\$2,002	\$2,039	\$2,500	\$2,537
36	72	29	128	56	LKT3672-29ART	\$1,873	\$1,940	\$2,319	\$2,388
36	66	29	119	51	LKT3666-29ART	\$1,815	\$1,877	\$2,262	\$2,326
36	60	29	110	46	LKT3660-29ART	\$1,748	\$1,806	\$2,193	\$2,253

LAMINATE

Features:

- price reflects complete table - top and base
- ships KD in multiple cartons

Options:

- specify power/charging option, see below for options and upcharges
- specify glide (G) or caster (C) -choice of black (BL) or white/grey casters (WG)



top shape

LOK - TEAMWORK

To Order Specify

1 Laminate Model #	2 Edge Detail	3 Laminate Selection	3a PVC Edge Color	4 Electrical
Laminate (LKT)	See Edge Detail Options	See Laminate Selection	See PVC Edge Color Options	N None CT2 Dual Power Center Top (See chart on next page) CU1 Single Power Underside 5 Foot/Caster G Glide C Caster - BL Black Caster - WG White Caster w/Grey Wheels 6 Metal Finish See Metal Finish Color Options

Model Number Breakdown

LKT4872-29ART					
LK	T	4872	29	AR	T
LOK	Laminate	48" x 72"	Height	Arc Rectangular Top Shape	T base

Description

Arc Rectangular Table with T Base at Working Height (continued)

Veneer Tables "LKV" Models

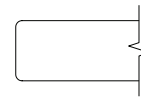

Eased Edge (R3)

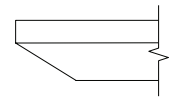

Reverse Bevel Edge (K9)

VENEER	D	W	H	CTN WT	CU FT	① Model	Eased Edge (R3)		Reverse Bevel Edge (K9)	
							Essentials	Artisan	Essentials	Artisan
	48	72	29	148	71	LKV4872-29ART	\$2,694	\$2,909	\$2,937	\$3,129
	42	72	29	140	63	LKV4272-29ART	\$2,584	\$2,793	\$2,819	\$3,001
	36	72	29	128	56	LKV3672-29ART	\$2,476	\$2,671	\$2,696	\$2,872
	36	66	29	119	51	LKV3666-29ART	\$2,387	\$2,577	\$2,601	\$2,769
	36	60	29	110	46	LKV3660-29ART	\$2,333	\$2,519	\$2,543	\$2,707

LOK - TEAMWORK

Electrical Options and Upcharges

CT2	
Dual Power Center Top - Black	CT2BL - add \$1,481
Dual Power Center Top - White	CT2WH - add \$1,481
CU1	
Single Power Underside - Black	CU11C - add \$576
Single Power Underside with Wireless Charging - Black	CU11CW - add \$1,379

Note: Order power infeed that best fits application

To Order, Specify:

① Veneer Model #	② Edge Detail	③ Wood Collection	④ Top Wood Finish	⑤ Electrical	⑥ Base - Foot/Caster	⑦ Metal Color
Veneer (LKV)	See Edge Detail Options	Essentials	See Essentials Top Wood Finish Options	N None CT2 Dual Power Center Top CU1 Single Power Underside (See chart above)	G Glide C Caster - BL Black Caster - WG White Caster with Grey Wheels	See Metal Finish Color Options
		Artisan	④ Top Wood Finish See Artisan Top Wood Finish Options			

Description

Rounded Arc Rectangular Table with T Base at Working Height

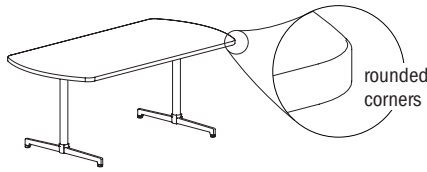

Laminate Tables
"LKT" Models

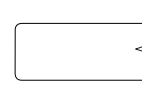

Eased Edge (R3)

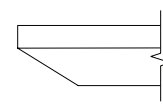

Reverse Bevel Edge (K9)

D	W	H	CTN WT	CU FT	Model	Eased Edge (R3)		Reverse Bevel Edge (K9)	
						Standard Tier 1	Graded In Tier 2	Standard Tier 1	Graded In Tier 2
48	72	29	148	71	LKT4872-29ARRT	\$2,104	\$2,147	\$2,614	\$2,657
42	72	29	140	63	LKT4272-29ARRT	\$2,002	\$2,039	\$2,500	\$2,537
36	72	29	128	56	LKT3672-29ARRT	\$1,873	\$1,940	\$2,319	\$2,388
36	66	29	119	51	LKT3666-29ARRT	\$1,815	\$1,877	\$2,262	\$2,326
36	60	29	110	46	LKT3660-29ARRT	\$1,748	\$1,806	\$2,193	\$2,253

LAMINATE

Features:

- price reflects complete table - top and base
- ships KD in multiple cartons

Options:

- specify power/charging option, see below for options and upcharges
- specify glide (G) or caster (C) -choice of black (BL) or white/grey casters (WG)

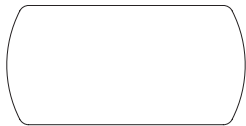

top shape

LOK - TEAMWORK

To Order Specify

1 Laminate Model #	2 Edge Detail	3 Laminate Selection	3a PVC Edge Color	4 Electrical
Laminate (LKT)	See Edge Detail Options	See Laminate Selection	See PVC Edge Color Options	N None CT2 Dual Power Center Top (See chart on next page) CU1 Single Power Underside 5 Foot/Caster G Glide C Caster - BL Black Caster - WG White Caster w/Grey Wheels 6 Metal Finish See Metal Finish Color Options

Model Number Breakdown

LKT4872-29ARRT						
LK	T	4872	29	AR	R	T
LOK	Laminate	48" x 72"	Height	Arc Rectangular Top Shape	Rounded Corner	T base

Description

Rounded Arc Rectangular Table with T Base at Working Height (continued)

Veneer Tables "LKV" Models

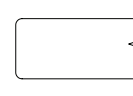

Eased Edge (R3)

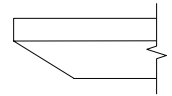

Reverse Bevel Edge (K9)

D	W	H	CTN WT	CU FT	Model	Eased Edge (R3)		Reverse Bevel Edge (K9)	
						Essentials	Artisan	Essentials	Artisan
48	72	29	148	71	LKV4872-29ARRT	\$2,694	\$2,909	\$2,937	\$3,129
42	72	29	140	63	LKV4272-29ARRT	\$2,584	\$2,793	\$2,819	\$3,001
36	72	29	128	56	LKV3672-29ARRT	\$2,476	\$2,671	\$2,696	\$2,872
36	66	29	119	51	LKV3666-29ARRT	\$2,387	\$2,577	\$2,601	\$2,769
36	60	29	110	46	LKV3660-29ARRT	\$2,333	\$2,519	\$2,543	\$2,707

VENEER

LOK - TEAMWORK

Electrical Options and Upcharges

CT2	
Dual Power Center Top - Black	CT2BL - add \$1,481
Dual Power Center Top - White	CT2WH - add \$1,481
CU1	
Single Power Underside - Black	CU11C - add \$576
Single Power Underside with Wireless Charging - Black	CU11CW - add \$1,379

Note: Order power infeed that best fits application

To Order, Specify:

1 Veneer Model #	2 Edge Detail	3 Wood Collection	4 Top Wood Finish	5 Electrical	6 Base - Foot/Caster	7 Metal Color
Veneer (LKV)	See Edge Detail Options	Essentials	See Essentials Top Wood Finish Options	N None CT2 Dual Power Center Top CU1 Single Power Underside (See chart above)	G Glide C Caster - BL Black Caster - WG White Caster with Grey Wheels	See Metal Finish Color Options
		Artisan	4 Top Wood Finish See Artisan Top Wood Finish Options			

Description

Racetrack Table with T Base at Working Height

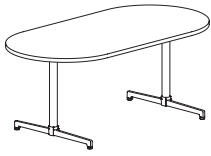

Laminate Tables
"LKT" Models

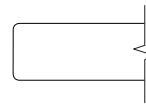

Eased Edge (R3)

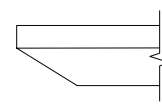

Reverse Bevel Edge (K9)

D	W	H	CTN WT	CU FT	Model	Eased Edge (R3)		Reverse Bevel Edge (K9)	
						Standard Tier 1	Graded In Tier 2	Standard Tier 1	Graded In Tier 2
48	72	29	135	71	LKT4872-29RKT	\$2,104	\$2,147	\$2,614	\$2,657
42	72	29	133	63	LKT4272-29RKT	\$2,002	\$2,039	\$2,500	\$2,537
36	72	29	122	56	LKT3672-29RKT	\$1,873	\$1,940	\$2,319	\$2,388
36	66	29	113	51	LKT3666-29RKT	\$1,815	\$1,877	\$2,262	\$2,326
36	60	29	104	46	LKT3660-29RKT	\$1,748	\$1,806	\$2,193	\$2,253

LAMINATE

Features:

- price reflects complete table - top and base
- ships KD in multiple cartons

Options:

- specify power/charging option, see below for options and upcharges
- specify glide (G) or caster (C) -choice of black (BL) or white/grey casters (WG)

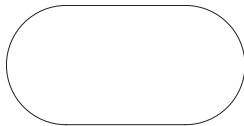

top shape

LOK - TEAMWORK

To Order Specify

1 Laminate Model #	2 Edge Detail	3 Laminate Selection	3a PVC Edge Color	4 Electrical
Laminate (LKT)	See Edge Detail Options	See Laminate Selection	See PVC Edge Color Options	N None CT2 Dual Power Center Top (See chart on next page) CU1 Single Power Underside 5 Foot/Caster G Glide C Caster - BL Black Caster - WG White Caster w/Grey Wheels 6 Metal Finish See Metal Finish Color Options

Model Number Breakdown

LKT4872-29RKT					
LK	T	4872	29	RK	T
LOK	Laminate	48" x 72"	Height	Racetrack Top Shape	T base

Description

Racetrack Table with T Base
at Working Height
(continued)

Veneer Tables
"LKV" Models

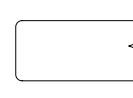

Eased Edge (R3)

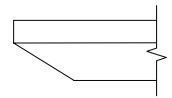

Reverse Bevel Edge (K9)

D	W	H	CTN WT	CU FT	① Model	Eased Edge (R3)		Reverse Bevel Edge (K9)	
						Essentials	Artisan	Essentials	Artisan
48	72	29	135	71	LKV4872-29RKT	\$2,694	\$2,909	\$2,937	\$3,129
42	72	29	133	63	LKV4272-29RKT	\$2,584	\$2,793	\$2,819	\$3,001
36	72	29	122	56	LKV3672-29RKT	\$2,476	\$2,671	\$2,696	\$2,872
36	66	29	113	51	LKV3666-29RKT	\$2,387	\$2,577	\$2,601	\$2,769
36	60	29	104	46	LKV3660-29RKT	\$2,257	\$2,436	\$2,460	\$2,618

VENEER

LOK - TEAMWORK

Electrical Options and Upcharges

CT2	
Dual Power Center Top - Black	CT2BL - add \$1,481
Dual Power Center Top - White	CT2WH - add \$1,481
CU1	
Single Power Underside - Black	CU11C - add \$576
Single Power Underside with Wireless Charging - Black	CU11CW - add \$1,379

Note: Order power infeed that best fits application

To Order, Specify:

① Veneer Model #	② Edge Detail	③ Wood Collection	④ Top Wood Finish	⑤ Electrical	⑥ Base - Foot/Caster	⑦ Metal Color
Veneer (LKV)	See Edge Detail Options	Essentials	See Essentials Top Wood Finish Options	N None CT2 Dual Power Center Top CU1 Single Power Underside (See chart above)	G Glide C Caster - BL Black Caster - WG White Caster with Grey Wheels	See Metal Finish Color Options
		Artisan	④ Top Wood Finish See Artisan Top Wood Finish Options			

Description

Oval Table with T Base at Working Height

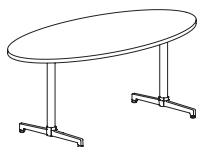

Laminate Tables
"LKT" Models

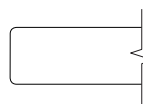

Eased Edge (R3)

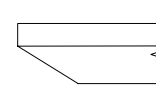

Reverse Bevel Edge (K9)

LAMI	D	W	H	CTN WT	CU FT	Model	Standard Tier 1	Graded In Tier 2	Standard Tier 1	Graded In Tier 2
		36	72	29	110	56	LKT3672-290VT	\$1,873	\$1,940	\$2,319

Features:

- price reflects complete table - top and base
- ships KD in multiple cartons

Options:

- specify power option and or charging option, see below for options and upcharges
- specify glide (always black) or caster; Black (BL) or White with Grey Wheels (WG)

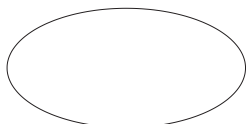

top shape

LOK - TEAMWORK

To Order Specify

1 Laminate Model #	2 Edge Detail	3 Laminate Selection	3a PVC Edge Color	4 Electrical
Laminate (LKT)	See Edge Detail Options	See Laminate Selection	See PVC Edge Color Options	N None CT2 Dual Power Center Top (See chart on next page) CU1 Single Power Underside 5 Foot/Caster G Glide C Caster - BL Black Caster - WG White Caster w/Grey Wheels 6 Metal Finish See Metal Finish Color Options

Model Number Breakdown

LKT3672-290VT					
LK	T	3672	29	OV	T
LOK	Laminate	36" x 72"	Height	Oval Top Shape	T base

Description

Oval Table with T Base at Working Height (continued)

Veneer Tables "LKV" Models

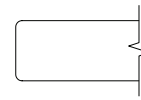

Eased Edge (R3)

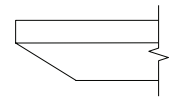

Reverse Bevel Edge (K9)

VEN.	D	W	H	CTN WT	CU FT	① Model	Essentials		Artisan	
							Essentials	Artisan	Essentials	Artisan
	36	72	29	110	56	LKV3672-29OVT	\$2,317	\$2,502	\$2,526	\$2,689

LOK - TEAMWORK

Electrical Options and Upcharges

CT2	
Dual Power Center Top - Black	CT2BL - add \$1,481
Dual Power Center Top - White	CT2WH - add \$1,481
CU1	
Single Power Underside - Black	CU11C - add \$576
Single Power Underside with Wireless Charging - Black	CU11CW - add \$1,379

Note: Order power infeed that best fits application

To Order, Specify:

① Veneer Model #	② Edge Detail	③ Wood Collection	④ Top Wood Finish	⑤ Electrical	⑥ Base - Foot/Caster	⑦ Metal Color
Veneer (LKV)	See Edge Detail Options	Essentials	See Essentials Top Wood Finish Options	N None CT2 Dual Power Center Top CU1 Single Power Underside (See chart above)	G Glide C Caster - BL Black Caster - WG White Caster with Grey Wheels	See Metal Finish Color Options
		Artisan	④ Top Wood Finish See Artisan Top Wood Finish Options			

Description

Boat Table with T Base at Working Height

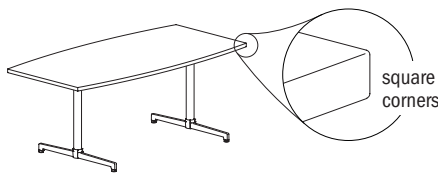

Laminate Tables "LKT" Models

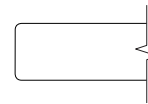

Eased Edge (R3)

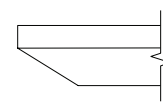

Reverse Bevel Edge (K9)

LAMINATE	D	W	H	CTN WT	CU FT	Model	Standard Tier 1	Graded In Tier 2	Standard Tier 1	Graded In Tier 2
		48	72	29	145	71	LKT4872-29BTT	\$2,104	\$2,147	\$2,614
	42	72	29	142	63	LKT4272-29BTT	\$2,002	\$2,039	\$2,500	\$2,537
	36	72	29	128	56	LKT3672-29BTT	\$1,873	\$1,940	\$2,319	\$2,388
	36	66	29	119	51	LKT3666-29BTT	\$1,815	\$1,877	\$2,262	\$2,326
	36	60	29	111	46	LKT3660-29BTT	\$1,748	\$1,806	\$2,193	\$2,253

Features:

- price reflects complete table - top and base
- ships KD in multiple cartons

Options:

- specify power/charging option, see below for options and upcharges
- specify glide (G) or caster (C) -choice of black (BL) or white/grey casters (WG)

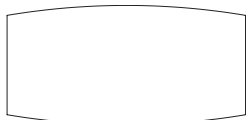

top shape

LOK - TEAMWORK

To Order Specify

1 Laminate Model #	2 Edge Detail	3 Laminate Selection	3a PVC Edge Color	4 Electrical
Laminate (LKT)	See Edge Detail Options	See Laminate Selection	See PVC Edge Color Options	N None CT2 Dual Power Center Top (See chart on next page) CU1 Single Power Underside 5 Foot/Caster G Glide C Caster - BL Black Caster - WG White Caster w/Grey Wheels 6 Metal Finish See Metal Finish Color Options

Model Number Breakdown

LKT4872-29BTT					
LK	T	4872	29	BT	T
LOK	Laminate	48" x 72"	Height	Boat Top Shape	T base

Description

Boat Table with T Base at Working Height (continued)

Veneer Tables "LKV" Models

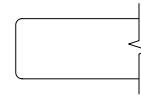

Eased Edge (R3)

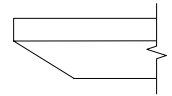

Reverse Bevel Edge (K9)

D	W	H	CTN WT	CU FT	Model	Eased Edge (R3)		Reverse Bevel Edge (K9)	
						Essentials	Artisan	Essentials	Artisan
48	72	29	145	71	LKV4872-29BTT	\$2,694	\$2,909	\$2,937	\$3,129
42	72	29	145	71	LKV4272-29BTT	\$2,584	\$2,793	\$2,819	\$3,001
36	72	29	142	63	LKV3672-29BTT	\$2,476	\$2,671	\$2,696	\$2,872
36	66	29	128	56	LKV3666-29BTT	\$2,387	\$2,577	\$2,601	\$2,769
36	60	29	119	46	LKV3660-29BTT	\$2,333	\$2,519	\$2,543	\$2,707

VENEER

LOK - TEAMWORK

Electrical Options and Upcharges

CT2	
Dual Power Center Top - Black	CT2BL - add \$1,481
Dual Power Center Top - White	CT2WH - add \$1,481
CU1	
Single Power Underside - Black	CU11C - add \$576
Single Power Underside with Wireless Charging - Black	CU11CW - add \$1,379

Note: Order power infeed that best fits application

To Order, Specify:

1 Veneer Model #	2 Edge Detail	3 Wood Collection	4 Top Wood Finish	5 Electrical	6 Base - Foot/Caster	7 Metal Color
Veneer (LKV)	See Edge Detail Options	Essentials	See Essentials Top Wood Finish Options	N None CT2 Dual Power Center Top CU1 Single Power Underside (See chart above)	G Glide C Caster - BL Black Caster - WG White Caster with Grey Wheels	See Metal Finish Color Options
		Artisan	4 Top Wood Finish See Artisan Top Wood Finish Options			

Description

Rounded Boat Table with T Base at Working Height

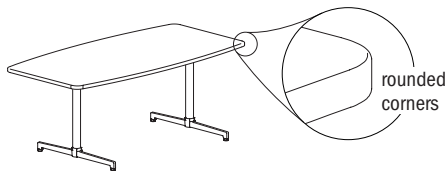

Laminate Tables "LKT" Models

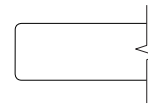

Eased Edge (R3)

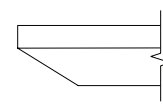

Reverse Bevel Edge (K9)

LAMINATE	D	W	H	CTN WT	CU FT	Model	Standard Tier 1	Graded In Tier 2	Standard Tier 1	Graded In Tier 2
		48	72	29	145	71	LKT4872-29BTRT	\$2,104	\$2,147	\$2,614
	42	72	29	142	63	LKT4272-29BTRT	\$2,002	\$2,039	\$2,500	\$2,537
	36	72	29	128	56	LKT3672-29BTRT	\$1,873	\$1,940	\$2,319	\$2,388
	36	66	29	119	51	LKT3666-29BTRT	\$1,815	\$1,877	\$2,262	\$2,326
	36	60	29	111	46	LKT3660-29BTRT	\$1,748	\$1,806	\$2,193	\$2,253

Features:

- price reflects complete table - top and base
- ships KD in multiple cartons



top shape

Options:

- specify power/charging option, see below for options and upcharges
- specify glide (G) or caster (C) - choice of black (BL) or white/grey casters (WG)

LOK - TEAMWORK

To Order Specify

1 Laminate Model #	2 Edge Detail	3 Laminate Selection	3a PVC Edge Color	4 Electrical
Laminate (LKT)	See Edge Detail Options	See Laminate Selection	See PVC Edge Color Options	N None CT2 Dual Power Center Top (See chart on next page) CU1 Single Power Underside 5 Foot/Caster G Glide C Caster - BL Black Caster - WG White Caster w/Grey Wheels 6 Metal Finish See Metal Finish Color Options

Model Number Breakdown

LKT4872-29BTRT						
LK	T	4872	29	BT	R	T
LOK	Laminate	48" x 72"	Height	Boat Top Shape	Rounded Corner	T base

Description

Rounded Boat Table with T Base at Working Height (continued)

Veneer Tables "LKV" Models

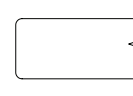

Eased Edge (R3)

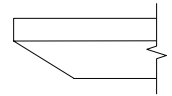

Reverse Bevel Edge (K9)

VENEER	D	W	H	CTN WT	CU FT	Model	Essentials	Artisan	Essentials	Artisan
		48	72	29	145	71	LKV4872-29BTRT	\$2,694	\$2,909	\$2,937
	42	72	29	142	63	LKV4272-29BTRT	\$2,584	\$2,793	\$2,819	\$3,001
	36	72	29	128	56	LKV3672-29BTRT	\$2,476	\$2,671	\$2,696	\$2,872
	36	66	29	119	51	LKV3666-29BTRT	\$2,387	\$2,577	\$2,601	\$2,769
	36	60	29	111	46	LKV3660-29BTRT	\$2,333	\$2,519	\$2,543	\$2,707

LOK - TEAMWORK

Electrical Options and Upcharges

CT2	
Dual Power Center Top - Black	CT2BL - add \$1,481
Dual Power Center Top - White	CT2WH - add \$1,481
CU1	
Single Power Underside - Black	CU11C - add \$576
Single Power Underside with Wireless Charging - Black	CU11CW - add \$1,379

Note: Order power infeed that best fits application

To Order, Specify:

1 Veneer Model #	2 Edge Detail	3 Wood Collection	4 Top Wood Finish	5 Electrical	6 Base - Foot/Caster	7 Metal Color
Veneer (LKV)	See Edge Detail Options	Essentials	See Essentials Top Wood Finish Options	N None CT2 Dual Power Center Top CU1 Single Power Underside (See chart above)	G Glide C Caster - BL Black Caster - WG White Caster with Grey Wheels	See Metal Finish Color Options
		Artisan	4 Top Wood Finish See Artisan Top Wood Finish Options			

Description

Rounded Double Chevron Table with T Base at Working Height

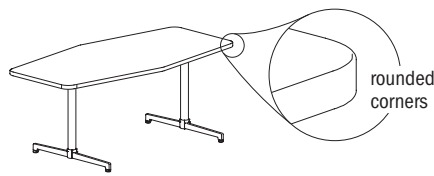

Laminate Tables
"LKT" Models

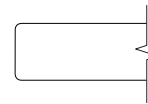

Eased Edge (R3)

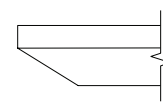

Reverse Bevel Edge (K9)

LAMINATE

D	W	H	CTN WT	CU FT	Model	Eased Edge (R3)		Reverse Bevel Edge (K9)	
						Standard Tier 1	Graded In Tier 2	Standard Tier 1	Graded In Tier 2
48	72	29	148	71	LKT4872-29DCRT	\$2,104	\$2,147	\$2,614	\$2,657
48	60	29	138	60	LKT4860-29DCRT	\$1,859	\$1,896	\$2,355	\$2,393
42	72	29	133	63	LKT4272-29DCRT	\$2,002	\$2,039	\$2,500	\$2,537
42	60	29	123	52	LKT4260-29DCRT	\$1,771	\$1,802	\$2,262	\$2,293
36	72	29	107	56	LKT3672-29DCRT	\$1,873	\$1,940	\$2,319	\$2,388
36	60	29	101	46	LKT3660-29DCRT	\$1,723	\$1,751	\$2,205	\$2,233

Features:

- price reflects complete table - top and base
- ships KD in multiple cartons

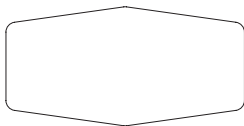

top shape

Options:

- specify power/charging option, see below for options and upcharges
- specify glide (G) or caster (C) - choice of black (BL) or white/grey casters (WG)

LOK - TEAMWORK

To Order Specify

1 Laminate Model #	2 Edge Detail	3 Laminate Selection	3a PVC Edge Color	4 Electrical
Laminate (LKT)	See Edge Detail Options	See Laminate Selection	See PVC Edge Color Options	N None CT2 Dual Power Center Top (See chart on next page) CU1 Single Power Underside 5 Foot/Caster G Glide C Caster - BL Black Caster - WG White Caster w/Grey Wheels 6 Metal Finish See Metal Finish Color Options

Model Number Breakdown

LKT4872-29DCRT						
LK	T	4872	29	DC	R	T
LOK	Laminate	48" x 72"	Height	Double Chevron Top Shape	Rounded Corner	T base

Description

Rounded Double Chevron Table with T Base
at Working Height
(continued)

Veneer Tables
"LKV" Models

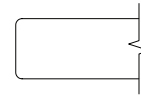

Eased Edge (R3)

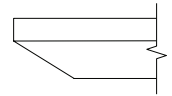

Reverse Bevel Edge (K9)

D	W	H	CTN WT	CU FT	① Model	Eased Edge (R3)		Reverse Bevel Edge (K9)	
						Essentials	Artisan	Essentials	Artisan
48	72	29	148	71	LKV4872-29DCRT	\$2,694	\$2,909	\$2,937	\$3,129
48	60	29	138	60	LKV4860-29DCRT	\$2,443	\$2,638	\$2,663	\$2,835
42	72	29	133	63	LKV4272-29DCRT	\$2,584	\$2,793	\$2,819	\$3,001
42	60	29	123	52	LKV4260-29DCRT	\$2,349	\$2,537	\$2,561	\$2,727
36	72	29	107	56	LKV3672-29DCRT	\$2,317	\$2,502	\$2,526	\$2,689
36	60	29	101	46	LKV3660-29DCRT	\$2,174	\$2,348	\$2,372	\$2,524

VENEER

LOK - TEAMWORK

Electrical Options and Upcharges

CT2	
Dual Power Center Top - Black	CT2BL - add \$1,481
Dual Power Center Top - White	CT2WH - add \$1,481
CU1	
Single Power Underside - Black	CU11C - add \$576
Single Power Underside with Wireless Charging - Black	CU11CW - add \$1,379

Note: Order power infeed that best fits application

To Order, Specify:

① Veneer Model #	② Edge Detail	③ Wood Collection	④ Top Wood Finish	⑤ Electrical	⑥ Base - Foot/Caster	⑦ Metal Color
Veneer (LKV)	See Edge Detail Options	Essentials	See Essentials Top Wood Finish Options	N None CT2 Dual Power Center Top CU1 Single Power Underside (See chart above)	G Glide C Caster - BL Black Caster - WG White Caster with Grey Wheels	See Metal Finish Color Options
		Artisan	④ Top Wood Finish See Artisan Top Wood Finish Options			

Description

Taper Table with T Base at Working Height

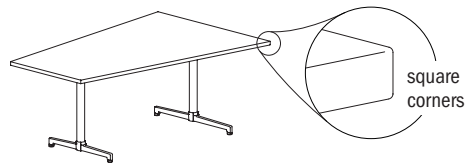

Laminate Tables "LKT" Models

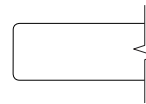

Eased Edge (R3)

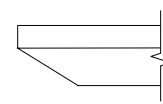

Reverse Bevel Edge (K9)

LAMI	D	W	H	CTN WT	CU FT	Model	Standard Tier 1	Graded In Tier 2	Standard Tier 1	Graded In Tier 2
		48	72	29	140	71	LKT4872-29TPT	\$2,614	\$2,658	\$3,124

Features:

- price reflects complete table - top and base
- ships KD in multiple cartons

Options:

- specify power/charging option, see below for options and upcharges
- specify glide (G) or caster (C) - choice of black (BL) or white/grey casters (WG)

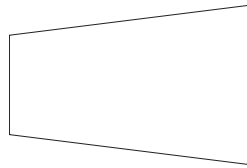

top shape

LOK - TEAMWORK

To Order Specify

1 Laminate Model #	2 Edge Detail	3 Laminate Selection	3a PVC Edge Color	4 Electrical
Laminate (LKT)	See Edge Detail Options	See Laminate Selection	See PVC Edge Color Options	N None CT2 Dual Power Center Top (See chart on next page) CU1 Single Power Underside 5 Foot/Caster G Glide C Caster - BL Black Caster - WG White Caster w/Grey Wheels 6 Metal Finish See Metal Finish Color Options

Model Number Breakdown

LKT4872-29TPT					
LK	T	4872	29	TP	T
LOK	Laminate	48" x 72"	Height	Taper Top Shape	T base

Description

Taper Table with T Base at Working Height (continued)

Veneer Tables "LKV" Models

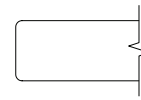

Eased Edge (R3)

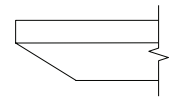

Reverse Bevel Edge (K9)

VEN.	D	W	H	CTN WT	CU FT	① Model	Eased Edge (R3)		Reverse Bevel Edge (K9)	
							Essentials	Artisan	Essentials	Artisan
	48	72	29	140	71	LKV4872-29TPT	\$3,207	\$3,461	\$3,495	\$3,722

LOK - TEAMWORK

Electrical Options and Upcharges

CT2	
Dual Power Center Top - Black	CT2BL - add \$1,481
Dual Power Center Top - White	CT2WH - add \$1,481
CU1	
Single Power Underside - Black	CU11C - add \$576
Single Power Underside with Wireless Charging - Black	CU11CW - add \$1,379

Note: Order power infeed that best fits application

To Order, Specify:

① Veneer Model #	② Edge Detail	③ Wood Collection	④ Top Wood Finish	⑤ Electrical	⑥ Base - Foot/Caster	⑦ Metal Color
Veneer (LKV)	See Edge Detail Options	Essentials	See Essentials Top Wood Finish Options	N None CT2 Dual Power Center Top CU1 Single Power Underside (See chart above)	G Glide C Caster - BL Black Caster - WG White Caster with Grey Wheels	See Metal Finish Color Options
		Artisan	④ Top Wood Finish See Artisan Top Wood Finish Options			

Description

Rounded Taper Table with T Base at Working Height

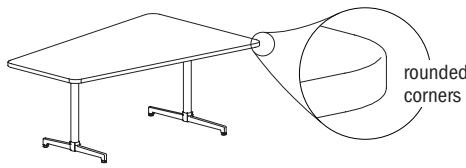

Laminate Tables "LKT" Models

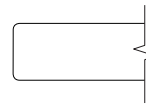

Eased Edge (R3)

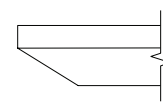

Reverse Bevel Edge (K9)

LAMI	D	W	H	CTN WT	CU FT	Model	Standard Tier 1	Graded In Tier 2	Standard Tier 1	Graded In Tier 2
		48	72	29	140	71	LKT4872-29TPRT	\$2,614	\$2,658	\$3,124

Features:

- price reflects complete table - top and base
- ships KD in multiple cartons

Options:

- specify power/charging option, see below for options and upcharges
- specify glide (G) or caster (C) -choice of black (BL) or white/grey casters (WG)

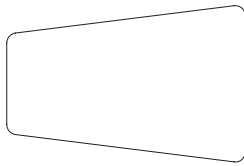

top shape

LOK - TEAMWORK

To Order Specify

1 Laminate Model #	2 Edge Detail	3 Laminate Selection	3a PVC Edge Color	4 Electrical
Laminate (LKT)	See Edge Detail Options	See Laminate Selection	See PVC Edge Color Options	N None CT2 Dual Power Center Top (See chart on next page) CU1 Single Power Underside 5 Foot/Caster G Glide C Caster - BL Black Caster - WG White Caster w/Grey Wheels 6 Metal Finish See Metal Finish Color Options

Model Number Breakdown

LKT4872-29TPRT						
LK	T	4872	29	TP	R	T
LOK	Laminate	48" x 72"	Height	Taper Top Shape	Rounded Corner	T base

Description

Rounded Taper Table with T Base at Working Height (continued)

Veneer Tables "LKV" Models

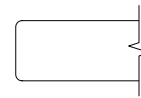

Eased Edge (R3)

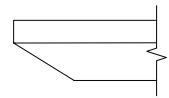

Reverse Bevel Edge (K9)

VEN.	D	W	H	CTN WT	CU FT	① Model	Essentials		Artisan	
							Essentials	Artisan	Essentials	Artisan
	48	72	29	140	71	LKV4872-29TPRT	\$3,207	\$3,461	\$3,495	\$3,722

LOK - TEAMWORK

Electrical Options and Upcharges

CT2	
Dual Power Center Top - Black	CT2BL - add \$1,481
Dual Power Center Top - White	CT2WH - add \$1,481
CU1	
Single Power Underside - Black	CU11C - add \$576
Single Power Underside with Wireless Charging - Black	CU11CW - add \$1,379

Note: Order power infeed that best fits application

To Order, Specify:

① Veneer Model #	② Edge Detail	③ Wood Collection	④ Top Wood Finish	⑤ Electrical	⑥ Base - Foot/Caster	⑦ Metal Color
Veneer (LKV)	See Edge Detail Options	Essentials	See Essentials Top Wood Finish Options	N None CT2 Dual Power Center Top CU1 Single Power Underside (See chart above)	G Glide C Caster - BL Black Caster - WG White Caster with Grey Wheels	See Metal Finish Color Options
		Artisan	④ Top Wood Finish See Artisan Top Wood Finish Options			

Description

Wedge Table with T Base
at Working Height

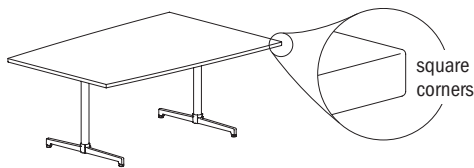

Laminate Tables
"LKT" Models

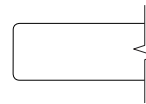

Eased Edge (R3)

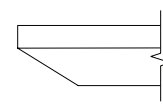

Reverse Bevel Edge (K9)

LAMI	D	W	H	CTN WT	CU FT	Model	Standard Tier 1	Graded In Tier 2	Standard Tier 1	Graded In Tier 2
		48	72	29	127	71	LKT4872-29WDT	\$2,928	\$2,972	\$3,438

Features:

- price reflects complete table - top and base
- ships KD in multiple cartons

Options:

- specify power/charging option, see below for options and upcharges
- specify glide (G) or caster (C) - choice of black (BL) or white/grey casters (WG)

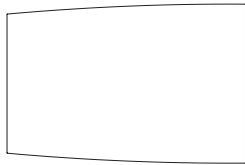

top shape

LOK - TEAMWORK

To Order Specify

1 Laminate Model #	2 Edge Detail	3 Laminate Selection	3a PVC Edge Color	4 Electrical
Laminate (LKT)	See Edge Detail Options	See Laminate Selection	See PVC Edge Color Options	N None CT2 Dual Power Center Top (See chart on next page) CU1 Single Power Underside 5 Foot/Caster G Glide C Caster - BL Black Caster - WG White Caster w/Grey Wheels 6 Metal Finish See Metal Finish Color Options

Model Number Breakdown

LKT4872-29WDT					
LK	T	4872	29	WD	T
LOK	Laminate	48" x 72"	Height	Wedge Top Shape	T base

Description

Wedge Table with T Base
at Working Height
(continued)

Veneer Tables
"LKV" Models

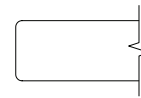

Eased Edge (R3)

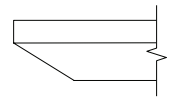

Reverse Bevel Edge (K9)

VEN.	D	W	H	CTN WT	CU FT	① Model	Eased Edge (R3)		Reverse Bevel Edge (K9)	
							Essentials	Artisan	Essentials	Artisan
	48	72	29	124	71	LKV4872-29WDT	\$3,521	\$3,800	\$3,834	\$4,084

LOK - TEAMWORK

Electrical Options and Upcharges

CT2	
Dual Power Center Top - Black	CT2BL - add \$1,481
Dual Power Center Top - White	CT2WH - add \$1,481
CU1	
Single Power Underside - Black	CU11C - add \$576
Single Power Underside with Wireless Charging - Black	CU11CW - add \$1,379

Note: Order power infeed that best fits application

To Order, Specify:

① Veneer Model #	② Edge Detail	③ Wood Collection	④ Top Wood Finish	⑤ Electrical	⑥ Base - Foot/Caster	⑦ Metal Color
Veneer (LKV)	See Edge Detail Options	Essentials	See Essentials Top Wood Finish Options	N None CT2 Dual Power Center Top CU1 Single Power Underside (See chart above)	G Glide C Caster - BL Black Caster - WG White Caster with Grey Wheels	See Metal Finish Color Options
		Artisan	④ Top Wood Finish See Artisan Top Wood Finish Options			

Description

Wedge Table with T Base
at Working Height

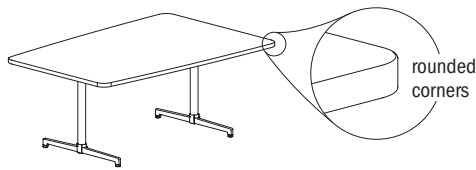

Laminate Tables
"LKT" Models

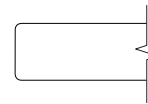

Eased Edge (R3)

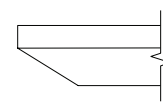

Reverse Bevel Edge (K9)

LAMI	D	W	H	CTN WT	CU FT	Model	Standard Tier 1	Graded In Tier 2	Standard Tier 1	Graded In Tier 2
		48	72	29	156	71	LKT4872-29WDRT	\$2,104	\$2,147	\$2,614

Features:

- price reflects complete table - top and base
- ships KD in multiple cartons

Options:

- specify power/charging option, see below for options and upcharges
- specify glide (G) or caster (C) - choice of black (BL) or white/grey casters (WG)

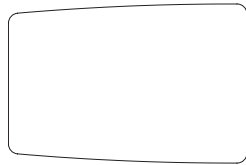

top shape

LOK - TEAMWORK

To Order Specify

1 Laminate Model #	2 Edge Detail	3 Laminate Selection	3a PVC Edge Color	4 Electrical
Laminate (LKT)	See Edge Detail Options	See Laminate Selection	See PVC Edge Color Options	N None CT2 Dual Power Center Top (See chart on next page) CU1 Single Power Underside 5 Foot/Caster G Glide C Caster - BL Black Caster - WG White Caster w/Grey Wheels 6 Metal Finish See Metal Finish Color Options

Model Number Breakdown

LKT4872-29WDRT						
LK	T	4872	29	WD	R	T
LOK	Laminate	48" x 72"	Height	Wedge Top Shape	Rounded Corner	T base

Description

Wedge Table with T Base
at Working Height
(continued)

Veneer Tables
"LKV" Models

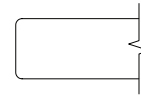

Eased Edge (R3)

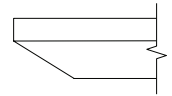

Reverse Bevel Edge (K9)

VEN.	D	W	H	CTN WT	CU FT	① Model	Eased Edge (R3)		Reverse Bevel Edge (K9)	
							Essentials	Artisan	Essentials	Artisan
	48	72	29	156	71	LKV4872-29WDRT	\$2,694	\$2,909	\$2,937	\$3,129

LOK - TEAMWORK

Electrical Options and Upcharges

CT2	
Dual Power Center Top - Black	CT2BL - add \$1,481
Dual Power Center Top - White	CT2WH - add \$1,481
CU1	
Single Power Underside - Black	CU11C - add \$576
Single Power Underside with Wireless Charging - Black	CU11CW - add \$1,379

Note: Order power infeed that best fits application

To Order, Specify:

① Veneer Model #	② Edge Detail	③ Wood Collection	④ Top Wood Finish	⑤ Electrical	⑥ Base - Foot/Caster	⑦ Metal Color
Veneer (LKV)	See Edge Detail Options	Essentials	See Essentials Top Wood Finish Options	N None CT2 Dual Power Center Top CU1 Single Power Underside (See chart above)	G Glide C Caster - BL Black Caster - WG White Caster with Grey Wheels	See Metal Finish Color Options
		Artisan	④ Top Wood Finish See Artisan Top Wood Finish Options			

Description

Bullet Table with T Base at Working Height

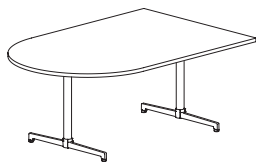

Laminate Tables "LKT" Models

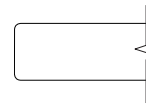

Eased Edge (R3)

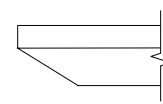

Reverse Bevel Edge (K9)

LAMI	D	W	H	CTN WT	CU FT	Model	Standard Tier 1	Graded In Tier 2	Standard Tier 1	Graded In Tier 2
		48	72	29	153	71	LKT4872-29BUT	\$2,104	\$2,147	\$2,614

Features:

- price reflects complete table - top and base
- ships KD in multiple cartons

Options:

- specify power/charging option, see below for options and upcharges
- specify glide (G) or caster (C) - choice of black (BL) or white/grey casters (WG)

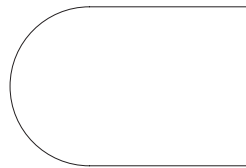

top shape

LOK - TEAMWORK

To Order Specify

1 Laminate Model #	2 Edge Detail	3 Laminate Selection	3a PVC Edge Color	4 Electrical
Laminate (LKT)	See Edge Detail Options	See Laminate Selection	See PVC Edge Color Options	N None CT2 Dual Power Center Top (See chart on next page) CU1 Single Power Underside 5 Foot/Caster G Glide C Caster - BL Black Caster - WG White Caster w/Grey Wheels 6 Metal Finish See Metal Finish Color Options

Model Number Breakdown

LKT4872-29BUT					
LK	T	4872	29	BU	T
LOK	Laminate	48" x 72"	Height	Bullet Top Shape	T base

Description

Bullet Table with T Base
at Working Height
(continued)

Veneer Tables
"LKV" Models

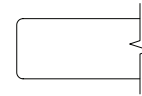

Eased Edge (R3)

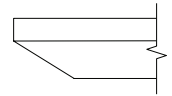

Reverse Bevel Edge (K9)

VEN.	D	W	H	CTN WT	CU FT	① Model	Eased Edge (R3)		Reverse Bevel Edge (K9)	
							Essentials	Artisan	Essentials	Artisan
	48	72	29	153	71	LKV4872-29BUT	\$2,694	\$2,909	\$2,937	\$3,129

LOK - TEAMWORK

Electrical Options and Upcharges

CT2	
Dual Power Center Top - Black	CT2BL - add \$1,481
Dual Power Center Top - White	CT2WH - add \$1,481
CU1	
Single Power Underside - Black	CU11C - add \$576
Single Power Underside with Wireless Charging - Black	CU11CW - add \$1,379

Note: Order power infeed that best fits application

To Order, Specify:

① Veneer Model #	② Edge Detail	③ Wood Collection	④ Top Wood Finish	⑤ Electrical	⑥ Base - Foot/Caster	⑦ Metal Color
Veneer (LKV)	See Edge Detail Options	Essentials	See Essentials Top Wood Finish Options	N None CT2 Dual Power Center Top CU1 Single Power Underside (See chart above)	G Glide C Caster - BL Black Caster - WG White Caster with Grey Wheels	See Metal Finish Color Options
		Artisan	④ Top Wood Finish See Artisan Top Wood Finish Options			

Description

Hive Table with T Base at Working Height

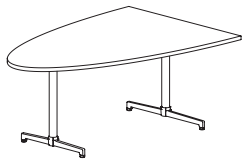

Laminate Tables
"LKT" Models

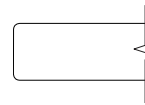

Eased Edge (R3)

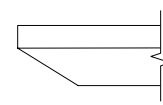

Reverse Bevel Edge (K9)

LAMI	D	W	H	CTN WT	CU FT	Model	Standard Tier 1	Graded In Tier 2	Standard Tier 1	Graded In Tier 2
		48	72	29	135	71	LKT4872-29HVT	\$2,104	\$2,147	\$2,614

Features:

- price reflects complete table - top and base
- ships KD in multiple cartons

Options:

- specify power/charging option, see below for options and upcharges
- specify glide (G) or caster (C) - choice of black (BL) or white/grey casters (WG)

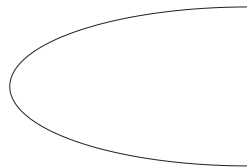

top shape

LOK - TEAMWORK

To Order Specify

1 Laminate Model #	2 Edge Detail	3 Laminate Selection	3a PVC Edge Color	4 Electrical
Laminate (LKT)	See Edge Detail Options	See Laminate Selection	See PVC Edge Color Options	N None CT2 Dual Power Center Top (See chart on next page) CU1 Single Power Underside 5 Foot/Caster G Glide C Caster - BL Black Caster - WG White Caster w/Grey Wheels 6 Metal Finish See Metal Finish Color Options

Model Number Breakdown

LKT4872-29HVT					
LK	T	4872	29	HV	T
LOK	Laminate	48" x 72"	Height	Hive Top Shape	T base

Description

Hive Table with T Base at Working Height (continued)

Veneer Tables "LKV" Models

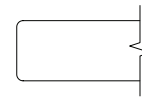

Eased Edge (R3)

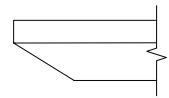

Reverse Bevel Edge (K9)

VEN.	D	W	H	CTN WT	CU FT	① Model	Essentials		Artisan	
							Essentials	Artisan	Essentials	Artisan
	48	72	29	135	71	LKV4872-29HVT	\$2,694	\$2,909	\$2,937	\$3,129

LOK - TEAMWORK

Electrical Options and Upcharges

CT2	
Dual Power Center Top - Black	CT2BL - add \$1,481
Dual Power Center Top - White	CT2WH - add \$1,481
CU1	
Single Power Underside - Black	CU11C - add \$576
Single Power Underside with Wireless Charging - Black	CU11CW - add \$1,379

Note: Order power infeed that best fits application

To Order, Specify:

① Veneer Model #	② Edge Detail	③ Wood Collection	④ Top Wood Finish	⑤ Electrical	⑥ Base - Foot/Caster	⑦ Metal Color
Veneer (LKV)	See Edge Detail Options	Essentials	See Essentials Top Wood Finish Options	N None CT2 Dual Power Center Top CU1 Single Power Underside (See chart above)	G Glide C Caster - BL Black Caster - WG White Caster with Grey Wheels	See Metal Finish Color Options
		Artisan	④ Top Wood Finish See Artisan Top Wood Finish Options			

Description

Rectangular Table with T Base at Counter Height

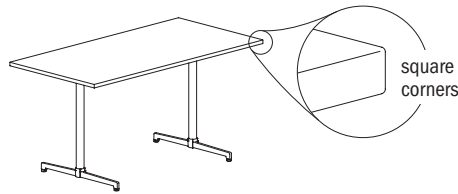

Laminate Tables
"LKT" Models

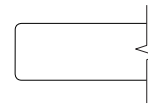

Eased Edge (R3)

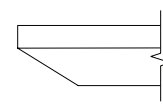

Reverse Bevel Edge (K9)

LAMINATE	D	W	H	CTN WT	CU FT	Model	Standard Tier 1	Graded In Tier 2	Standard Tier 1	Graded In Tier 2
		48	72	36	144	87	LKT4872-36TTT	\$2,326	\$2,374	\$2,862
	42	72	36	146	77	LKT4272-36TTT	\$2,222	\$2,263	\$2,749	\$2,788
	36	72	36	135	66	LKT3672-36TTT	\$2,012	\$2,082	\$2,481	\$2,553
	36	66	36	126	62	LKT3666-36TTT	\$1,950	\$2,012	\$2,415	\$2,481
	36	60	36	135	57	LKT3660-36TTT	\$1,866	\$1,929	\$2,337	\$2,396

Features:

- price reflects complete table - top and base
- ships KD in multiple cartons
- model includes adjustable glide

Options:

- specify power option and or charging option, see below for options and upcharges

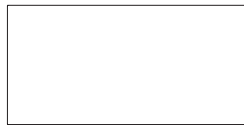

top shape

LOK - TEAMWORK

To Order Specify

1 Laminate Model #	2 Edge Detail	3 Laminate Selection	3a PVC Edge Color	4 Electrical
Laminate (LKT)	See Edge Detail Options	See Laminate Selection	See PVC Edge Color Options	N None CT2 Dual Power Center Top (See chart on next page) CU1 Single Power Underside 5 Metal Finish See Metal Finish Color Options

Model Number Breakdown

LKT4872-36TTT					
LK	T	4872	36	TT	T
LOK	Laminate	48" x 72"	Height	Rectangular Top Shape	T base

Description

Rectangular Table with T Base at Counter Height
(continued)

Veneer Tables
"LKV" Models

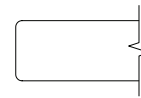

Eased Edge (R3)

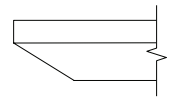

Reverse Bevel Edge (K9)

VENEER	D	W	H	CTN WT	CU FT	① Model	Essentials	Artisan	Essentials	Artisan
		48	72	36	140	87	LKV4872-36TTT	\$2,655	\$2,896	\$2,913
	42	72	36	146	77	LKV4272-36TTT	\$2,545	\$2,756	\$2,794	\$2,986
	36	72	36	135	66	LKV3672-36TTT	\$2,325	\$2,531	\$2,506	\$2,708
	36	66	36	126	62	LKV3666-36TTT	\$2,280	\$2,472	\$2,455	\$2,643
	36	60	36	135	57	LKV3660-36TTT	\$2,217	\$2,396	\$2,385	\$2,560

LOK - TEAMWORK

Electrical Options and Upcharges

CT2	
Dual Power Center Top - Black	CT2BL - add \$1,481
Dual Power Center Top - White	CT2WH - add \$1,481
CU1	
Single Power Underside - Black	CU11C - add \$576
Single Power Underside with Wireless Charging - Black	CU11CW - add \$1,379

Note: Order power infeed that best fits application

To Order, Specify:

① Veneer Model #	② Edge Detail	③ Wood Collection	④ Top Wood Finish	⑤ Electrical	⑥ Metal Color
Veneer (LKV)	See Edge Detail Options	Essentials	See Essentials Top Wood Finish Options	N None CT2 Dual Power Center Top CU1 Single Power Underside (See chart above)	See Metal Finish Color Options
		Artisan	④ Top Wood Finish See Artisan Top Wood Finish Options		

Description

Rounded Rectangular Table with T Base at Counter Height

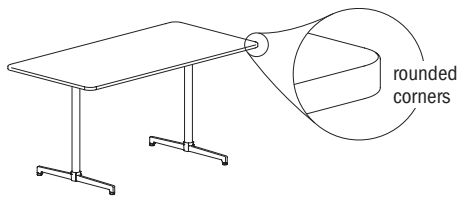

Laminate Tables
"LKT" Models

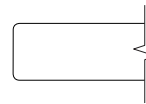

Eased Edge (R3)

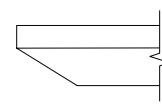

Reverse Bevel Edge (K9)

D	W	H	CTN WT	CU FT	❶ Model	Eased Edge (R3)		Reverse Bevel Edge (K9)	
						Standard Tier 1	Graded In Tier 2	Standard Tier 1	Graded In Tier 2
48	72	36	144	87	LKT4872-36TTRT	\$2,389	\$2,436	\$2,926	\$2,972
42	72	36	136	77	LKT4272-36TTRT	\$2,281	\$2,321	\$2,805	\$2,846
36	72	36	135	66	LKT3672-36TTRT	\$2,115	\$2,185	\$2,583	\$2,656
36	66	36	126	62	LKT3666-36TTRT	\$2,053	\$2,120	\$2,524	\$2,592
36	60	36	135	57	LKT3660-36TTRT	\$1,980	\$2,045	\$2,450	\$2,515

LAMINATE

Features:

- price reflects complete table - top and base
- ships KD in multiple cartons
- model includes adjustable glide

Options:

- specify power option and or charging option, see below for options and upcharges

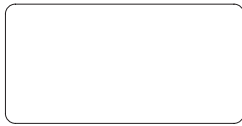

top shape

LOK - TEAMWORK

To Order Specify

❶ Laminate Model #	❷ Edge Detail	❸ Laminate Selection	❹ PVC Edge Color	❺ Electrical
Laminate (LKT)	See Edge Detail Options	See Laminate Selection	See PVC Edge Color Options	N None CT2 Dual Power Center Top (See chart on next page) CU1 Single Power Underside ❻ Metal Finish See Metal Finish Color Options

Model Number Breakdown

LKT4872-36TTRT						
LK	T	4872	36	TT	R	T
LOK	Laminate	48" x 72"	Height	Rectangular Top Shape	Rounded Corner	T base

Description

Rounded Rectangular Table with T Base at Counter Height (continued)

Veneer Tables "LKV" Models

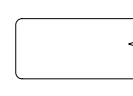

Eased Edge (R3)

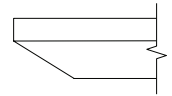

Reverse Bevel Edge (K9)

VENEER	D	W	H	CTN WT	CU FT	① Model	Essentials	Artisan	Essentials	Artisan
		48	72	36	144	87	LKV4872-36TTRT	\$2,719	\$2,959	\$2,977
	42	72	36	146	77	LKV4272-36TTRT	\$2,602	\$2,813	\$2,854	\$3,046
	36	72	36	135	66	LKV3672-36TTRT	\$2,488	\$2,706	\$2,579	\$2,785
	36	66	36	126	62	LKV3666-36TTRT	\$2,394	\$2,564	\$2,628	\$2,780
	36	60	36	135	57	LKV3660-36TTRT	\$2,374	\$2,560	\$2,454	\$2,630

LOK - TEAMWORK

Electrical Options and Upcharges

CT2	
Dual Power Center Top - Black	CT2BL - add \$1,481
Dual Power Center Top - White	CT2WH - add \$1,481
CU1	
Single Power Underside - Black	CU11C - add \$576
Single Power Underside with Wireless Charging - Black	CU11CW - add \$1,379

Note: Order power infeed that best fits application

To Order, Specify:

① Veneer Model #	② Edge Detail	③ Wood Collection	④ Top Wood Finish	⑤ Electrical	⑥ Metal Color
Veneer (LKV)	See Edge Detail Options	Essentials	See Essentials Top Wood Finish Options	N None CT2 Dual Power Center Top CU1 Single Power Underside (See chart above)	See Metal Finish Color Options
		Artisan	④ Top Wood Finish See Artisan Top Wood Finish Options		

Description

Rectangular Table with X Base at Counter Height

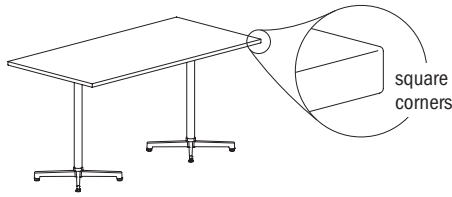

Laminate Tables
"LKT" Models

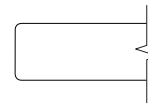

Eased Edge (R3)

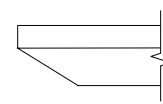

Reverse Bevel Edge (K9)

LAMINATE	D	W	H	CTN WT	CU FT	1 Model	Standard Tier 1	Graded In Tier 2	Standard Tier 1	Graded In Tier 2
		48	72	36	165	87	LKT4872-36TTX	\$2,854	\$2,899	\$3,388
	42	72	36	150	77	LKT4272-36TTX	\$2,749	\$2,788	\$3,273	\$3,312
	36	72	36	133	67	LKT3672-36TTX	\$2,589	\$2,658	\$3,057	\$3,128

Features:

- price reflects complete table - top and base
- ships KD in multiple cartons
- model includes adjustable glide

Options:

- specify power option and or charging option, see below for options and upcharges

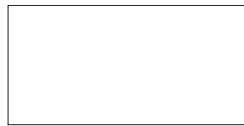

top shape

LOK - TEAMWORK

To Order Specify

1 Laminite Model #	2 Edge Detail	3 Laminite Selection	3a PVC Edge Color	4 Electrical
Laminite (LKT)	See Edge Detail Options	See Laminite Selection	See PVC Edge Color Options	N None CT2 Dual Power Center Top (See chart on next page) CU1 Single Power Underside 5 Metal Finish See Metal Finish Color Options

Model Number Breakdown

LKT4872-36TTX					
LK	T	4872	36	TT	X
LOK	Laminite	48" x 72"	Height	Rectangular Top Shape	X base

Description

Rectangular Table with X Base at Counter Height
(continued)

Veneer Tables
"LKV" Models

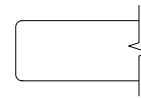

Eased Edge (R3)

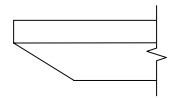

Reverse Bevel Edge (K9)

VENEER	D	W	H	CTN WT	CU FT	① Model	Essentials	Artisan	Essentials	Artisan
		48	72	36	165	87	LKV4872-36TTX	\$3,180	\$3,419	\$3,440
	42	72	36	150	77	LKV4272-36TTX	\$3,069	\$3,281	\$3,318	\$3,514
	36	72	36	133	67	LKV3672-36TTX	\$2,901	\$3,108	\$3,081	\$3,283

LOK - TEAMWORK

Electrical Options and Upcharges

CT2	
Dual Power Center Top - Black	CT2BL - add \$1,481
Dual Power Center Top - White	CT2WH - add \$1,481
CU1	
Single Power Underside - Black	CU11C - add \$576
Single Power Underside with Wireless Charging - Black	CU11CW - add \$1,379

Note: Order power infeed that best fits application

To Order, Specify:

① Veneer Model #	② Edge Detail	③ Wood Collection	④ Top Wood Finish	⑤ Electrical	⑥ Metal Color
Veneer (LKV)	See Edge Detail Options	Essentials	See Essentials Top Wood Finish Options	N None CT2 Dual Power Center Top CU1 Single Power Underside (See chart above)	See Metal Finish Color Options
		Artisan	④ Top Wood Finish See Artisan Top Wood Finish Options		

Description

Rounded Rectangular Table with X Base at Counter Height

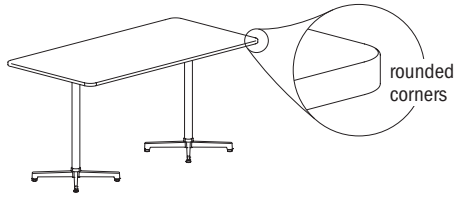

Laminate Tables
"LKT" Models

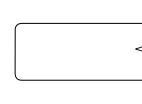

Eased Edge (R3)

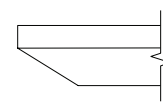

Reverse Bevel Edge (K9)

LAMINATE	D	W	H	CTN WT	CU FT	1 Model	Standard Tier 1	Graded In Tier 2	Standard Tier 1	Graded In Tier 2
		48	72	36	165	87	LKT4872-36TTRX	\$2,913	\$2,963	\$3,451
	42	72	36	150	77	LKT4272-36TTRX	\$2,666	\$2,706	\$3,190	\$3,231
	36	72	36	133	67	LKT3672-36TTRX	\$2,690	\$2,762	\$3,157	\$3,232

Features:

- price reflects complete table - top and base
- ships KD in multiple cartons
- model includes adjustable glide

Options:

- specify power option and or charging option, see below for options and upcharges



top shape

LOK - TEAMWORK

To Order Specify

1 Laminate Model #	2 Edge Detail	3 Laminate Selection	3a PVC Edge Color	4 Electrical
Laminate (LKT)	See Edge Detail Options	See Laminate Selection	See PVC Edge Color Options	N None CT2 Dual Power Center Top (See chart on next page) CU1 Single Power Underside 5 Metal Finish See Metal Finish Color Options

Model Number Breakdown

LKT4872-36TTRX						
LK	T	4872	36	TT	R	X
LOK	Laminate	48" x 72"	Height	Rectangular Top Shape	Rounded Corner	X base

Description

Rounded Rectangular Table with X Base at Counter Height (continued)

Veneer Tables
"LKV" Models

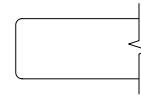

Eased Edge (R3)

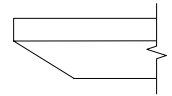

Reverse Bevel Edge (K9)

VENEER	D	W	H	CTN WT	CU FT	① Model	Essentials	Artisan	Essentials	Artisan
		48	72	36	165	87	LKV4872-36TTRX	\$3,243	\$3,484	\$3,501
	42	72	36	150	77	LKV4272-36TTRX	\$2,986	\$3,200	\$3,236	\$3,430
	36	72	36	133	67	LKV3672-36TTRX	\$3,101	\$3,317	\$3,190	\$3,394

LOK - TEAMWORK

Electrical Options and Upcharges

CT2	
Dual Power Center Top - Black	CT2BL - add \$1,481
Dual Power Center Top - White	CT2WH - add \$1,481
CU1	
Single Power Underside - Black	CU11C - add \$576
Single Power Underside with Wireless Charging - Black	CU11CW - add \$1,379

Note: Order power infeed that best fits application

To Order, Specify:

① Veneer Model #	② Edge Detail	③ Wood Collection	④ Top Wood Finish	⑤ Electrical	⑥ Metal Color
Veneer (LKV)	See Edge Detail Options	Essentials	See Essentials Top Wood Finish Options	N None CT2 Dual Power Center Top CU1 Single Power Underside (See chart above)	See Metal Finish Color Options
		Artisan	④ Top Wood Finish See Artisan Top Wood Finish Options		

Description

Arc Rectangular Table with T Base at Counter Height

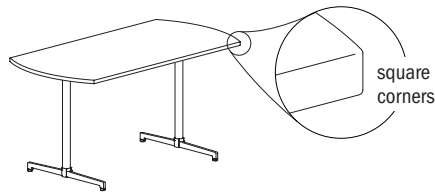

Laminate Tables
"LKT" Models

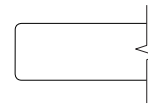

Eased Edge (R3)

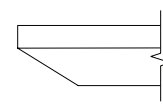

Reverse Bevel Edge (K9)

D	W	H	CTN WT	CU FT	① Model	Eased Edge (R3)		Reverse Bevel Edge (K9)	
						Standard Tier 1	Graded In Tier 2	Standard Tier 1	Graded In Tier 2
48	72	36	153	87	LKT4872-36ART	\$2,276	\$2,321	\$2,787	\$2,832
42	72	36	140	78	LKT4272-36ART	\$2,173	\$2,212	\$2,672	\$2,711
36	72	36	131	66	LKT3672-36ART	\$2,014	\$2,083	\$2,461	\$2,529
36	66	36	122	62	LKT3666-36ART	\$1,956	\$2,020	\$2,403	\$2,467
36	60	36	131	57	LKT3660-36ART	\$1,888	\$1,950	\$2,336	\$2,395

LAMINATE

Features:

- price reflects complete table - top and base
- ships KD in multiple cartons
- model includes adjustable glide

Options:

- specify power option and or charging option, see below for options and upcharges

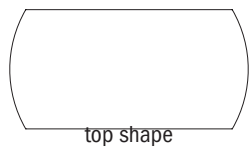

LOK - TEAMWORK

To Order Specify

① Laminate Model #	② Edge Detail	③ Laminate Selection	④ PVC Edge Color	⑤ Electrical
Laminate (LKT)	See Edge Detail Options	See Laminate Selection	See PVC Edge Color Options	N None CT2 Dual Power Center Top (See chart on next page) CU1 Single Power Underside ⑤ Metal Finish See Metal Finish Color Options

Model Number Breakdown

LKT4872-36ART					
LK	T	4872	36	AR	T
LOK	Laminate	48" x 72"	Height	Arc Rectangular Top Shape	T base

Description

Arc Rectangular Table with T Base at Counter Height
(continued)

Veneer Tables
"LKV" Models

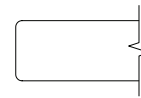

Eased Edge (R3)

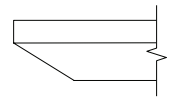

Reverse Bevel Edge (K9)

D	W	H	CTN WT	CU FT	① Model	Eased Edge (R3)		Reverse Bevel Edge (K9)	
						Essentials	Artisan	Essentials	Artisan
48	72	36	153	87	LKV4872-36ART	\$2,868	\$3,098	\$3,124	\$3,328
42	72	36	140	78	LKV4272-36ART	\$2,759	\$2,978	\$3,008	\$3,202
36	72	36	131	66	LKV3672-36ART	\$2,648	\$2,860	\$2,888	\$3,075
36	66	36	122	62	LKV3666-36ART	\$2,560	\$2,765	\$2,792	\$2,972
36	60	36	131	57	LKV3660-36ART	\$2,503	\$2,705	\$2,729	\$2,906

VENEER

LOK - TEAMWORK

Electrical Options and Upcharges

CT2	
Dual Power Center Top - Black	CT2BL - add \$1,481
Dual Power Center Top - White	CT2WH - add \$1,481
CU1	
Single Power Underside - Black	CU11C - add \$576
Single Power Underside with Wireless Charging - Black	CU11CW - add \$1,379

Note: Order power infeed that best fits application

To Order, Specify:

① Veneer Model #	② Edge Detail	③ Wood Collection	④ Top Wood Finish	⑤ Electrical	⑥ Metal Color
Veneer (LKV)	See Edge Detail Options	Essentials	See Essentials Top Wood Finish Options	N None CT2 Dual Power Center Top CU1 Single Power Underside (See chart above)	See Metal Finish Color Options
		Artisan	④ Top Wood Finish See Artisan Top Wood Finish Options		

Description

Rounded Arc Rectangular Table with T Base at Counter Height

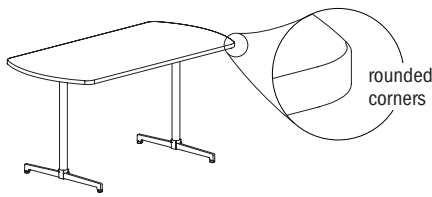

Laminate Tables "LKT" Models

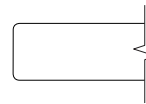

Eased Edge (R3)

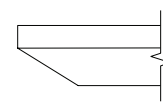

Reverse Bevel Edge (K9)

D	W	H	CTN WT	CU FT	Model	Eased Edge (R3)		Reverse Bevel Edge (K9)	
						Standard Tier 1	Graded In Tier 2	Standard Tier 1	Graded In Tier 2
48	72	36	153	87	LKT4872-36ARRT	\$2,276	\$2,321	\$2,787	\$2,832
42	72	36	140	78	LKT4272-36ARRT	\$2,173	\$2,212	\$2,672	\$2,711
36	72	36	131	66	LKT3672-36ARRT	\$2,014	\$2,083	\$2,461	\$2,529
36	66	36	122	62	LKT3666-36ARRT	\$1,956	\$2,020	\$2,403	\$2,467
36	60	36	131	57	LKT3660-36ARRT	\$1,888	\$1,950	\$2,336	\$2,395

LAMINATE

Features:

- price reflects complete table - top and base
- ships KD in multiple cartons
- model includes adjustable glide

Options:

- specify power option and or charging option, see below for options and upcharges

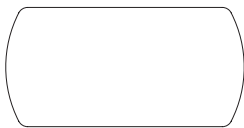

top shape

LOK - TEAMWORK

To Order Specify

1 Laminate Model #	2 Edge Detail	3 Laminate Selection	3a PVC Edge Color	4 Electrical
Laminate (LKT)	See Edge Detail Options	See Laminate Selection	See PVC Edge Color Options	N None CT2 Dual Power Center Top (See chart on next page) CU1 Single Power Underside 5 Metal Finish See Metal Finish Color Options

Model Number Breakdown

LKT4872-36ARRT						
LK	T	4872	36	AR	R	T
LOK	Laminate	48" x 72"	Height	Arc Rectangular Top Shape	Rounded Corner	T base

Description

Rounded Arc Rectangular Table with T Base
at Counter Height (continued)

Veneer Tables
"LKV" Models

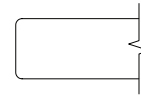

Eased Edge (R3)

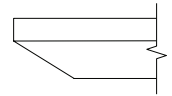

Reverse Bevel Edge (K9)

VENEER	D	W	H	CTN WT	CU FT	① Model	Essentials	Artisan	Essentials	Artisan
		48	72	36	153	87	LKV4872-36ARRT	\$2,868	\$3,098	\$3,124
	42	72	36	140	78	LKV4272-36ARRT	\$2,759	\$2,978	\$3,008	\$3,202
	36	72	36	131	66	LKV3672-36ARRT	\$2,648	\$2,860	\$2,888	\$3,075
	36	66	36	122	62	LKV3666-36ARRT	\$2,560	\$2,765	\$2,792	\$2,972
	36	60	36	131	57	LKV3660-36ARRT	\$2,503	\$2,705	\$2,729	\$2,906

LOK - TEAMWORK

Electrical Options and Upcharges

CT2	
Dual Power Center Top - Black	CT2BL - add \$1,481
Dual Power Center Top - White	CT2WH - add \$1,481
CU1	
Single Power Underside - Black	CU11C - add \$576
Single Power Underside with Wireless Charging - Black	CU11CW - add \$1,379

Note: Order power infeed that best fits application

To Order, Specify:

① Veneer Model #	② Edge Detail	③ Wood Collection	④ Top Wood Finish	⑤ Electrical	⑥ Metal Color
Veneer (LKV)	See Edge Detail Options	Essentials	See Essentials Top Wood Finish Options	N None CT2 Dual Power Center Top CU1 Single Power Underside (See chart above)	See Metal Finish Color Options
		Artisan	④ Top Wood Finish See Artisan Top Wood Finish Options		

Description

Racetrack Table with T Base at Counter Height

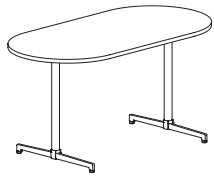

Laminate Tables
"LKT" Models

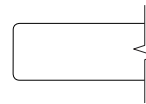

Eased Edge (R3)

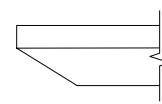

Reverse Bevel Edge (K9)

LAMINATE	D	W	H	CTN WT	CU FT	1 Model	Standard Tier 1	Graded In Tier 2	Standard Tier 1	Graded In Tier 2
		42	72	36	136	77	LKT4272-36RKT	\$2,173	\$2,212	\$2,672
	36	72	36	125	66	LKT3672-36RKT	\$2,014	\$2,083	\$2,461	\$2,529
	36	66	36	117	62	LKT3666-36RKT	\$1,956	\$2,020	\$2,403	\$2,467
	36	60	36	125	57	LKT3660-36RKT	\$1,888	\$1,950	\$2,336	\$2,395

Features:

- price reflects complete table - top and base
- ships KD in multiple cartons
- model includes adjustable glide

Options:

- specify power option and or charging option, see below for options and upcharges



top shape

LOK - TEAMWORK

To Order Specify

1 Laminate Model #	2 Edge Detail	3 Laminate Selection	3a PVC Edge Color	4 Electrical
Laminate (LKT)	See Edge Detail Options	See Laminate Selection	See PVC Edge Color Options	N None CT2 Dual Power Center Top (See chart on next page) CU1 Single Power Underside 5 Metal Finish See Metal Finish Color Options

Model Number Breakdown

LKT4272-36RKT					
LK	T	4272	36	RK	T
LOK	Laminate	42" x 72"	Height	Racetrack Top Shape	T base

Description

Racetrack Table with T Base at Counter Height
(continued)

Veneer Tables
"LKV" Models

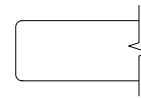

Eased Edge (R3)

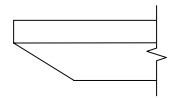

Reverse Bevel Edge (K9)

VENEER	D	W	H	CTN WT	CU FT	① Model	Essentials	Artisan	Essentials	Artisan
		48	72	36	144	87	LKV4872-36RKT	\$2,868	\$3,098	\$3,124
	36	72	36	125	66	LKV3672-36RKT	\$2,648	\$2,860	\$2,888	\$3,075
	36	66	36	117	62	LKV3666-36RKT	\$2,560	\$2,765	\$2,792	\$2,972
	36	60	36	125	57	LKV3660-36RKT	\$2,503	\$2,705	\$2,729	\$2,906

LOK - TEAMWORK

Electrical Options and Upcharges

CT2	
Dual Power Center Top - Black	CT2BL - add \$1,481
Dual Power Center Top - White	CT2WH - add \$1,481
CU1	
Single Power Underside - Black	CU11C - add \$576
Single Power Underside with Wireless Charging - Black	CU11CW - add \$1,379

Note: Order power infeed that best fits application

To Order, Specify:

① Veneer Model #	② Edge Detail	③ Wood Collection	④ Top Wood Finish	⑤ Electrical	⑥ Metal Color
Veneer (LKV)	See Edge Detail Options	Essentials	See Essentials Top Wood Finish Options	N None CT2 Dual Power Center Top CU1 Single Power Underside (See chart above)	See Metal Finish Color Options
		Artisan	④ Top Wood Finish See Artisan Top Wood Finish Options		

Description

Oval Table with T Base at Counter Height

Laminate Tables
"LKT" Models

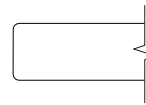

Eased Edge (R3)

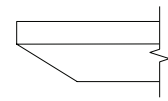

Reverse Bevel Edge (K9)

LAMI	D	W	H	CTN WT	CU FT	1 Model	Standard Tier 1	Graded In Tier 2	Standard Tier 1	Graded In Tier 2
		36	72	36	113	67	LKT3672-360VT	\$2,014	\$2,083	\$2,461

Features:

- price reflects complete table - top and base
- ships KD in multiple cartons
- model includes adjustable glide

Options:

- specify power option and or charging option, see below for options and upcharges

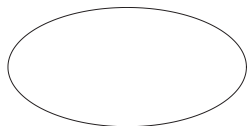

top shape

LOK - TEAMWORK

To Order Specify

1 Laminate Model #	2 Edge Detail	3 Laminate Selection	3a PVC Edge Color	4 Electrical
Laminate (LKT)	See Edge Detail Options	See Laminate Selection	See PVC Edge Color Options	N None CT2 Dual Power Center Top (See chart on next page) CU1 Single Power Underside 5 Metal Finish See Metal Finish Color Options

Model Number Breakdown

LKT3672-360VT					
LK	T	3672	36	OV	T
LOK	Laminate	36" x 72"	Height	Oval Top Shape	T base

Description

Oval Table with T Base at Counter Height
(continued)

Veneer Tables
"LKV" Models

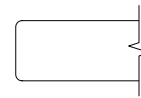

Eased Edge (R3)

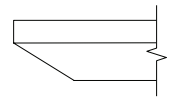

Reverse Bevel Edge (K9)

VEN.	D	W	H	CTN WT	CU FT	① Model	Eased Edge (R3)		Reverse Bevel Edge (K9)	
							Essentials	Artisan	Essentials	Artisan
	36	72	36	113	67	LKV3672-360VT	\$2,488	\$2,688	\$2,711	\$2,889

LOK - TEAMWORK

Electrical Options and Upcharges

CT2	
Dual Power Center Top - Black	CT2BL - add \$1,481
Dual Power Center Top - White	CT2WH - add \$1,481
CU1	
Single Power Underside - Black	CU11C - add \$576
Single Power Underside with Wireless Charging - Black	CU11CW - add \$1,379

Note: Order power infeed that best fits application

To Order, Specify:

① Veneer Model #	② Edge Detail	③ Wood Collection	④ Top Wood Finish	⑤ Electrical	⑥ Metal Color
Veneer (LKV)	See Edge Detail Options	Essentials	See Essentials Top Wood Finish Options	N None CT2 Dual Power Center Top CU1 Single Power Underside (See chart above)	See Metal Finish Color Options
		Artisan	④ Top Wood Finish See Artisan Top Wood Finish Options		

Description

Boat Table with T Base at Counter Height

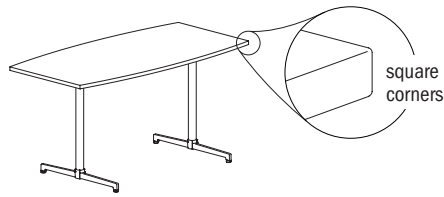

Laminate Tables
"LKT" Models

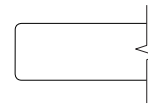

Eased Edge (R3)

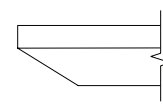

Reverse Bevel Edge (K9)

D	W	H	CTN WT	CU FT	Model	Eased Edge (R3)		Reverse Bevel Edge (K9)	
						Standard Tier 1	Graded In Tier 2	Standard Tier 1	Graded In Tier 2
48	72	36	156	87	LKT4872-36BTT	\$2,276	\$2,321	\$2,787	\$2,832
42	72	36	107	87	LKT4272-36BTT	\$2,173	\$2,212	\$2,672	\$2,711
36	72	36	130	66	LKT3672-36BTT	\$2,014	\$2,083	\$2,461	\$2,529
36	66	36	122	62	LKT3666-36BTT	\$1,956	\$2,020	\$2,403	\$2,467
36	60	36	130	57	LKT3660-36BTT	\$1,888	\$1,950	\$2,336	\$2,395

LAMINATE

Features:

- price reflects complete table - top and base
- ships KD in multiple cartons
- model includes adjustable glide

Options:

- specify power option and or charging option, see below for options and upcharges



top shape

LOK - TEAMWORK

To Order Specify

1 Laminate Model #	2 Edge Detail	3 Laminate Selection	3a PVC Edge Color	4 Electrical
Laminate (LKT)	See Edge Detail Options	See Laminate Selection	See PVC Edge Color Options	N None CT2 Dual Power Center Top (See chart on next page) CU1 Single Power Underside 5 Metal Finish See Metal Finish Color Options

Model Number Breakdown

LKT4872-36BTT					
LK	T	4872	36	BT	T
LOK	Laminate	48" x 72"	Height	Boat Top Shape	T base

Description

Boat Table with T Base at Counter Height
(continued)

Veneer Tables
"LKV" Models

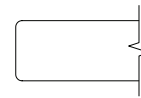

Eased Edge (R3)

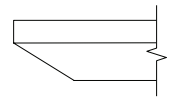

Reverse Bevel Edge (K9)

D	W	H	CTN WT	CU FT	① Model	Eased Edge (R3)		Reverse Bevel Edge (K9)	
						Essentials	Artisan	Essentials	Artisan
48	72	36	156	87	LKV4872-36BTT	\$2,868	\$3,098	\$3,124	\$3,328
42	72	36	143	78	LKV4272-36BTT	\$2,759	\$2,978	\$3,008	\$3,202
36	72	36	130	66	LKV3672-36BTT	\$2,648	\$2,860	\$2,888	\$3,075
36	66	36	122	62	LKV3666-36BTT	\$2,560	\$2,765	\$2,792	\$2,972
36	60	36	130	57	LKV3660-36BTT	\$2,503	\$2,705	\$2,729	\$2,906

VENEER

LOK - TEAMWORK

Electrical Options and Upcharges

CT2	
Dual Power Center Top - Black	CT2BL - add \$1,481
Dual Power Center Top - White	CT2WH - add \$1,481
CU1	
Single Power Underside - Black	CU11C - add \$576
Single Power Underside with Wireless Charging - Black	CU11CW - add \$1,379

Note: Order power infeed that best fits application

To Order, Specify:

① Veneer Model #	② Edge Detail	③ Wood Collection	④ Top Wood Finish	⑤ Electrical	⑥ Metal Color
Veneer (LKV)	See Edge Detail Options	Essentials	See Essentials Top Wood Finish Options	N None CT2 Dual Power Center Top CU1 Single Power Underside (See chart above)	See Metal Finish Color Options
		Artisan	④ Top Wood Finish See Artisan Top Wood Finish Options		

Description

Rounded Boat Table with T Base at Counter Height

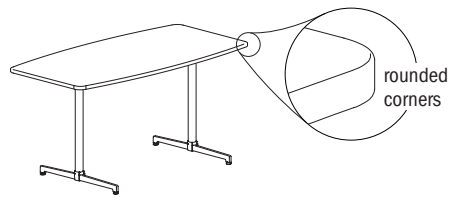

Laminate Tables
"LKT" Models

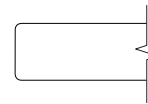

Eased Edge (R3)

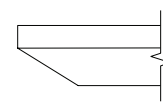

Reverse Bevel Edge (K9)

D	W	H	CTN WT	CU FT	① Model	Eased Edge (R3)		Reverse Bevel Edge (K9)	
						Standard Tier 1	Graded In Tier 2	Standard Tier 1	Graded In Tier 2
48	72	36	156	87	LKT4872-36BTRT	\$2,276	\$2,321	\$2,787	\$2,832
42	72	36	143	78	LKT4272-36BTRT	\$2,173	\$2,212	\$2,672	\$2,711
36	72	36	130	66	LKT3672-36BTRT	\$2,014	\$2,083	\$2,461	\$2,529
36	66	36	122	62	LKT3666-36BTRT	\$1,956	\$2,020	\$2,403	\$2,467
36	60	36	130	57	LKT3660-36BTRT	\$1,888	\$1,950	\$2,336	\$2,395

LAMINATE

Features:

- price reflects complete table - top and base
- ships KD in multiple cartons
- model includes adjustable glide

Options:

- specify power option and or charging option, see below for options and upcharges



top shape

LOK - TEAMWORK

To Order Specify

① Laminate Model #	② Edge Detail	③ Laminate Selection	④ PVC Edge Color	⑤ Electrical
Laminate (LKT)	See Edge Detail Options	See Laminate Selection	See PVC Edge Color Options	N None CT2 Dual Power Center Top (See chart on next page) CU1 Single Power Underside ⑤ Metal Finish See Metal Finish Color Options

Model Number Breakdown

LKT3048-29TTT						
LK	T	4872	36	BT	R	T
LOK	Laminate	48" x 72"	Height	Boat Top Shape	Rounded Corner	T base

Description

Rounded Boat Table with T Base at Counter Height
(continued)

Veneer Tables
"LKV" Models

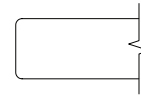

Eased Edge (R3)

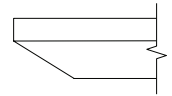

Reverse Bevel Edge (K9)

VENEER	D	W	H	CTN WT	CU FT	① Model	Essentials	Artisan	Essentials	Artisan
		48	72	36	156	87	LKV4872-36BTRT	\$2,868	\$3,098	\$3,124
	42	72	36	143	78	LKV4272-36BTRT	\$2,759	\$2,978	\$3,008	\$3,202
	36	72	36	130	66	LKV3672-36BTRT	\$2,648	\$2,860	\$2,888	\$3,075
	36	66	36	122	62	LKV3666-36BTRT	\$2,560	\$2,765	\$2,792	\$2,972
	36	60	36	130	57	LKV3660-36BTRT	\$2,503	\$2,705	\$2,729	\$2,906

LOK - TEAMWORK

Electrical Options and Upcharges

CT2	
Dual Power Center Top - Black	CT2BL - add \$1,481
Dual Power Center Top - White	CT2WH - add \$1,481
CU1	
Single Power Underside - Black	CU11C - add \$576
Single Power Underside with Wireless Charging - Black	CU11CW - add \$1,379

Note: Order power infeed that best fits application

To Order, Specify:

① Veneer Model #	② Edge Detail	③ Wood Collection	④ Top Wood Finish	⑤ Electrical	⑥ Metal Color
Veneer (LKV)	See Edge Detail Options	Essentials	See Essentials Top Wood Finish Options	N None CT2 Dual Power Center Top CU1 Single Power Underside (See chart above)	See Metal Finish Color Options
		Artisan	④ Top Wood Finish See Artisan Top Wood Finish Options		

Description

Rounded Double Chevron Table with T Base at Counter Height

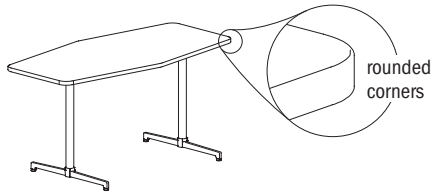

Laminate Tables "LKT" Models

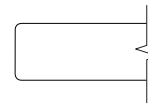

Eased Edge (R3)

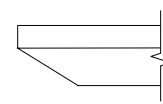

Reverse Bevel Edge (K9)

LAMINATE

D	W	H	CTN WT	CU FT	Model	Eased Edge (R3)		Reverse Bevel Edge (K9)	
						Standard Tier 1	Graded In Tier 2	Standard Tier 1	Graded In Tier 2
48	72	36	150	87	LKT4872-36DCRT	\$2,276	\$2,321	\$2,787	\$2,832
48	60	36	131	74	LKT4860-36DCRT	\$2,106	\$2,142	\$2,603	\$2,640
42	72	36	136	77	LKT4272-36DCRT	\$2,173	\$2,212	\$2,672	\$2,711
42	60	36	119	65	LKT4260-36DCRT	\$2,019	\$2,051	\$2,509	\$2,542
36	72	36	122	66	LKT3672-36DCRT	\$2,014	\$2,083	\$2,461	\$2,529
36	60	36	122	57	LKT3660-36DCRT	\$1,888	\$1,950	\$2,336	\$2,395

Features:

- price reflects complete table - top and base
- ships KD in multiple cartons
- model includes adjustable glide

Options:

- specify power option and or charging option, see below for options and upcharges

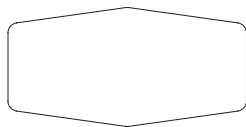

top shape

LOK - TEAMWORK

To Order Specify

1 Laminate Model #	2 Edge Detail	3 Laminate Selection	3a PVC Edge Color	4 Electrical
Laminate (LKT)	See Edge Detail Options	See Laminate Selection	See PVC Edge Color Options	N None CT2 Dual Power Center Top (See chart on next page) CU1 Single Power Underside 5 Metal Finish See Metal Finish Color Options

Model Number Breakdown

LKT4872-36DCRT						
LK	T	4872	36	DC	R	T
LOK	Laminate	48" x 72"	Height	Double Chevron Top Shape	Rounded Corner	T base

Description

Rounded Double Chevron Table with T Base at Counter Height (continued)

Veneer Tables
"LKV" Models

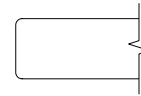

Eased Edge (R3)

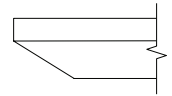

Reverse Bevel Edge (K9)

D	W	H	CTN WT	CU FT	① Model	Eased Edge (R3)		Reverse Bevel Edge (K9)		
						Essentials	Artisan	Essentials	Artisan	
48	72	36	150	87	LKV4872-36DCRT	\$2,868	\$3,098	\$3,124	\$3,328	
48	60	36	131	74	LKV4860-36DCRT	\$2,689	\$2,903	\$2,932	\$3,120	
VENEER	42	72	36	136	77	LKV4272-36DCRT	\$2,759	\$2,978	\$3,008	\$3,202
	42	60	36	119	65	LKV4260-36DCRT	\$2,598	\$2,804	\$2,832	\$3,014
	36	72	36	122	66	LKV3672-36DCRT	\$2,612	\$2,821	\$2,846	\$3,031
	36	60	36	122	57	LKV3660-36DCRT	\$2,466	\$2,665	\$2,689	\$2,863

LOK - TEAMWORK

Electrical Options and Upcharges

CT2	
Dual Power Center Top - Black	CT2BL - add \$1,481
Dual Power Center Top - White	CT2WH - add \$1,481
CU1	
Single Power Underside - Black	CU11C - add \$576
Single Power Underside with Wireless Charging - Black	CU11CW - add \$1,379

Note: Order power infeed that best fits application

To Order, Specify:

① Veneer Model #	② Edge Detail	③ Wood Collection	④ Top Wood Finish	⑤ Electrical	⑥ Metal Color
Veneer (LKV)	See Edge Detail Options	Essentials	See Essentials Top Wood Finish Options	N None CT2 Dual Power Center Top CU1 Single Power Underside (See chart above)	See Metal Finish Color Options
		Artisan	④ Top Wood Finish See Artisan Top Wood Finish Options		

Description

Taper Table with T Base at Counter Height

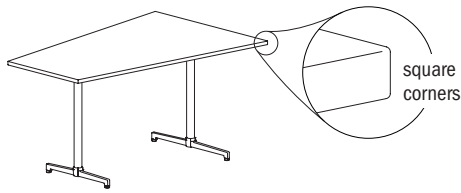

Laminate Tables
"LKT" Models

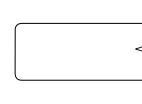

Eased Edge (R3)

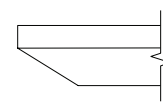

Reverse Bevel Edge (K9)

LAMI	D	W	H	CTN WT	CU FT	1 Model	Standard Tier 1	Graded In Tier 2	Standard Tier 1	Graded In Tier 2
		48	72	36	140	87	LKT4872-36TPT	\$2,287	\$2,333	\$2,797

Features:

- price reflects complete table - top and base
- ships KD in multiple cartons
- model includes adjustable glide

Options:

- specify power option and or charging option, see below for options and upcharges

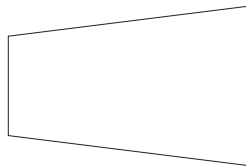

top shape

LOK - TEAMWORK

To Order Specify

1 Laminate Model #	2 Edge Detail	3 Laminate Selection	3a PVC Edge Color	4 Electrical
Laminate (LKT)	See Edge Detail Options	See Laminate Selection	See PVC Edge Color Options	N None CT2 Dual Power Center Top (See chart on next page) CU1 Single Power Underside 5 Metal Finish See Metal Finish Color Options

Model Number Breakdown

LKT4872-36TPT					
LK	T	4872	36	TP	T
LOK	Laminate	48" x 72"	Height	Taper Top Shape	T base

Description

Taper Table with T Base at Counter Height
(continued)

Veneer Tables
"LKV" Models

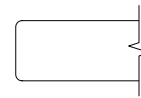

Eased Edge (R3)

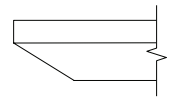

Reverse Bevel Edge (K9)

VEN.	D	W	H	CTN WT	CU FT	① Model	Eased Edge (R3)		Reverse Bevel Edge (K9)	
							Essentials	Artisan	Essentials	Artisan
	48	72	36	140	87	LKV4872-36TPT	\$2,878	\$3,110	\$3,139	\$3,343

LOK - TEAMWORK

Electrical Options and Upcharges

CT2	
Dual Power Center Top - Black	CT2BL - add \$1,481
Dual Power Center Top - White	CT2WH - add \$1,481
CU1	
Single Power Underside - Black	CU11C - add \$576
Single Power Underside with Wireless Charging - Black	CU11CW - add \$1,379

Note: Order power infeed that best fits application

To Order, Specify:

① Veneer Model #	② Edge Detail	③ Wood Collection	④ Top Wood Finish	⑤ Electrical	⑥ Metal Color
Veneer (LKV)	See Edge Detail Options	Essentials	See Essentials Top Wood Finish Options	N None CT2 Dual Power Center Top CU1 Single Power Underside (See chart above)	See Metal Finish Color Options
		Artisan	④ Top Wood Finish See Artisan Top Wood Finish Options		

Description

Rounded Taper Table with T Base at Counter Height

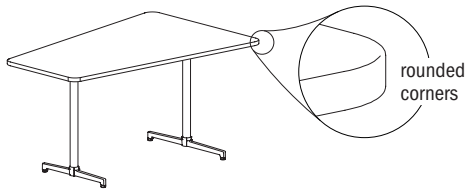

Laminate Tables
"LKT" Models

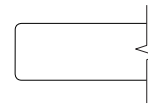

Eased Edge (R3)

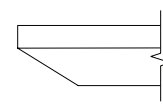

Reverse Bevel Edge (K9)

LAMI	D	W	H	CTN WT	CU FT	1 Model	Standard Tier 1	Graded In Tier 2	Standard Tier 1	Graded In Tier 2
		48	72	36	140	87	LKT4872-36TPRT	\$2,287	\$2,333	\$2,797

Features:

- price reflects complete table - top and base
- ships KD in multiple cartons
- model includes adjustable glide

Options:

- specify power option and or charging option, see below for options and upcharges

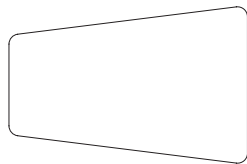

top shape

LOK - TEAMWORK

To Order Specify

1 Laminate Model #	2 Edge Detail	3 Laminate Selection	3a PVC Edge Color	4 Electrical
Laminate (LKT)	See Edge Detail Options	See Laminate Selection	See PVC Edge Color Options	N None CT2 Dual Power Center Top (See chart on next page) CU1 Single Power Underside 5 Metal Finish See Metal Finish Color Options

Model Number Breakdown

LKT4872-36TPRT						
LK	T	4872	36	TP	R	T
LOK	Laminate	48" x 72"	Height	Taper Top Shape	Rounded Corner	T base

Description

Rounded Taper Table with T Base at Counter Height
(continued)

Veneer Tables
"LKV" Models

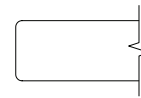

Eased Edge (R3)

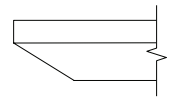

Reverse Bevel Edge (K9)

VEN.	D	W	H	CTN WT	CU FT	① Model	Essentials		Artisan	
							Essentials	Artisan	Essentials	Artisan
	48	72	36	140	87	LKV4872-36TPRT	\$2,878	\$3,110	\$3,139	\$3,343

LOK - TEAMWORK

Electrical Options and Upcharges

CT2	
Dual Power Center Top - Black	CT2BL - add \$1,481
Dual Power Center Top - White	CT2WH - add \$1,481
CU1	
Single Power Underside - Black	CU11C - add \$576
Single Power Underside with Wireless Charging - Black	CU11CW - add \$1,379

Note: Order power infeed that best fits application

To Order, Specify:

① Veneer Model #	② Edge Detail	③ Wood Collection	④ Top Wood Finish	⑤ Electrical	⑥ Metal Color
Veneer (LKV)	See Edge Detail Options	Essentials	See Essentials Top Wood Finish Options	N None CT2 Dual Power Center Top CU1 Single Power Underside (See chart above)	See Metal Finish Color Options
		Artisan	④ Top Wood Finish See Artisan Top Wood Finish Options		

Description

Bullet Table with T Base at Counter Height

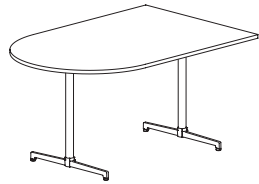

Laminate Tables
"LKT" Models

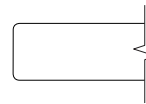

Eased Edge (R3)

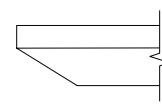

Reverse Bevel Edge (K9)

LAMI	D	W	H	CTN WT	CU FT	1 Model	Standard Tier 1	Graded In Tier 2	Standard Tier 1	Graded In Tier 2
		48	72	36	154	87	LKT4872-36BUT	\$2,276	\$2,321	\$2,787

Features:

- price reflects complete table - top and base
- ships KD in multiple cartons
- model includes adjustable glide

Options:

- specify power option and or charging option, see below for options and upcharges

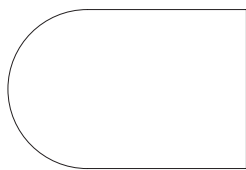

top shape

LOK - TEAMWORK

To Order Specify

1 Laminate Model #	2 Edge Detail	3 Laminate Selection	3a PVC Edge Color	4 Electrical
Laminate (LKT)	See Edge Detail Options	See Laminate Selection	See PVC Edge Color Options	N None CT2 Dual Power Center Top (See chart on next page) CU1 Single Power Underside 5 Metal Finish See Metal Finish Color Options

Model Number Breakdown

LKT4872-36BUT					
LK	T	4872	36	BU	T
LOK	Laminate	48" x 72"	Height	Bullet Top Shape	T base

Description

Bullet Table with T Base at Counter Height
(continued)

Veneer Tables
"LKV" Models

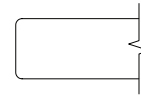

Eased Edge (R3)

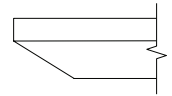

Reverse Bevel Edge (K9)

VEN.	D	W	H	CTN WT	CU FT	① Model	Eased Edge (R3)		Reverse Bevel Edge (K9)	
							Essentials	Artisan	Essentials	Artisan
	48	72	36	154	87	LKV4872-36BUT	\$2,868	\$3,098	\$3,124	\$3,328

LOK - TEAMWORK

Electrical Options and Upcharges

CT2	
Dual Power Center Top - Black	CT2BL - add \$1,481
Dual Power Center Top - White	CT2WH - add \$1,481
CU1	
Single Power Underside - Black	CU11C - add \$576
Single Power Underside with Wireless Charging - Black	CU11CW - add \$1,379

Note: Order power infeed that best fits application

To Order, Specify:

① Veneer Model #	② Edge Detail	③ Wood Collection	④ Top Wood Finish	⑤ Electrical	⑥ Metal Color
Veneer (LKV)	See Edge Detail Options	Essentials	See Essentials Top Wood Finish Options	N None CT2 Dual Power Center Top CU1 Single Power Underside (See chart above)	See Metal Finish Color Options
		Artisan	④ Top Wood Finish See Artisan Top Wood Finish Options		

Description

Hive Table with T Base at Counter Height

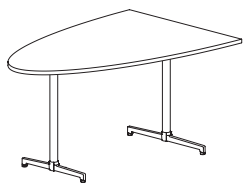

Laminate Tables
"LKT" Models

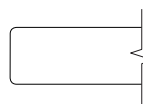

Eased Edge (R3)

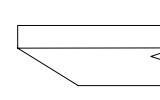

Reverse Bevel Edge (K9)

LAMI	D	W	H	CTN WT	CU FT	1 Model	Standard Tier 1	Graded In Tier 2	Standard Tier 1	Graded In Tier 2
		48	72	36	135	87	LKT4872-36HVT	\$2,276	\$2,321	\$2,787

Features:

- price reflects complete table - top and base
- ships KD in multiple cartons
- model includes adjustable glide

Options:

- specify power option and or charging option, see below for options and upcharges

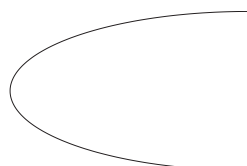

top shape

LOK - TEAMWORK

To Order Specify

1 Laminate Model #	2 Edge Detail	3 Laminate Selection	3a PVC Edge Color	4 Electrical
Laminate (LKT)	See Edge Detail Options	See Laminate Selection	See PVC Edge Color Options	N None CT2 Dual Power Center Top (See chart on next page) CU1 Single Power Underside 5 Metal Finish See Metal Finish Color Options

Model Number Breakdown

LKT4872-36HVT					
LK	T	4872	36	HV	T
LOK	Laminate	48" x 72"	Height	Hive Top Shape	T base

Description

Hive Table with T Base at Counter Height
(continued)

Veneer Tables
"LKV" Models

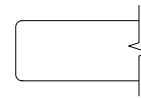

Eased Edge (R3)

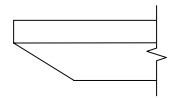

Reverse Bevel Edge (K9)

VEN.	D	W	H	CTN WT	CU FT	① Model	Essentials		Artisan	
	48	72	36	135	87	LKV4872-36HVT	\$2,868		\$3,098	
									\$3,124	\$3,328

LOK - TEAMWORK

Electrical Options and Upcharges

CT2	
Dual Power Center Top - Black	CT2BL - add \$1,481
Dual Power Center Top - White	CT2WH - add \$1,481
CU1	
Single Power Underside - Black	CU11C - add \$576
Single Power Underside with Wireless Charging - Black	CU11CW - add \$1,379

Note: Order power infeed that best fits application

To Order, Specify:

① Veneer Model #	② Edge Detail	③ Wood Collection	④ Top Wood Finish	⑤ Electrical	⑥ Metal Color
Veneer (LKV)	See Edge Detail Options	Essentials	See Essentials Top Wood Finish Options	N None CT2 Dual Power Center Top CU1 Single Power Underside (See chart above)	See Metal Finish Color Options
		Artisan	④ Top Wood Finish See Artisan Top Wood Finish Options		

Description

Intersect Table with T Base at Counter Height



Laminate Tables
"LKT" Models

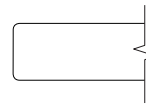

Eased Edge (R3)

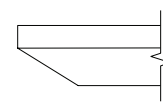

Reverse Bevel Edge (K9)

LAMINATE	D	W	H	CTN WT	CU FT	1 Model	Standard Tier 1	Graded In Tier 2	Standard Tier 1	Graded In Tier 2
		30	60	36	118	48	LKT3060-36INT	\$2,040	\$2,063	\$2,512
	24	60	36	113	40	LKT2460-36INT	\$1,994	\$2,012	\$2,456	\$2,476

Features:

- price reflects complete table - top and base
- ships KD in multiple cartons
- model includes adjustable glide

Options:

- specify power option; None (N), add \$663 for EC23 (CTEC23), add \$549 for EC24 (CTEC24)

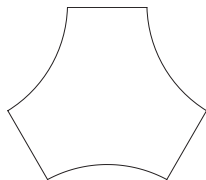

top shape

LOK - TEAMWORK

To Order Specify

Laminate Model #	2 Edge Detail	3 Laminate Selection	3a PVC Edge Color	4 Electrical
Laminate (LKT)	See Edge Detail Options	See Laminate Selection	See PVC Edge Color Options	N None CTEC23 Power Center Top (See chart on next page) CTEC24 Power Center Top 5 Metal Finish See Metal Finish Color Options

Model Number Breakdown

LKT3060-36INT					
LK	T	3060	36	IN	T
LOK	Laminate	30" x 60"	Height	Intersect Top Shape	T base

Description

Intersect Table with T Base at Counter Height
(continued)

Veneer Tables
"LKV" Models

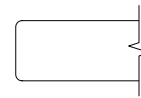

Eased Edge (R3)

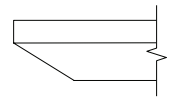

Reverse Bevel Edge (K9)

VENEER	D	W	H	CTN WT	CU FT	① Model	Essentials	Artisan	Essentials	Artisan
	30	60	36	118	48	LKV3060-36INT	\$2,605	\$2,813	\$2,839	\$3,024
24	60	36	113	40	LKV2460-36INT	\$2,560	\$2,765	\$2,792	\$2,972	

LOK - TEAMWORK

Electrical Options and Upcharges

CTEC23	
EC23 Power Center Top - Black	CTEC23BL - add \$663
EC23 Power Center Top - White	CTEC23WH - add \$663
CTEC24	
EC24 Power Center Top - Black	CTEC43BL - add \$549
EC24 Power Center Top - White	CTEC43WH - add \$549

Note: Order power infeed that best fits application

To Order, Specify:

① Veneer Model #	② Edge Detail	③ Wood Collection	④ Top Wood Finish	⑤ Electrical	⑥ Metal Color
Veneer (LKV)	See Edge Detail Options	Essentials	See Essentials Top Wood Finish Options	N None CTEC23 Power Center Top CTEC24 Power Center Top (See chart above)	See Metal Finish Color Options
		Artisan	④ Top Wood Finish See Artisan Top Wood Finish Options		

Description

Huddle Table with T Base at Counter Height

Laminate Tables
"LKT" Models

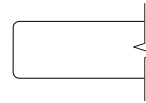

Eased Edge (R3)

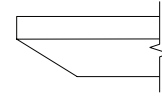

Reverse Bevel Edge (K9)

LAMINATE	D	W	H	CTN WT	CU FT	Model	Standard Tier 1	Graded In Tier 2	Standard Tier 1	Graded In Tier 2
		36	84	36	143	78	LKT3684-36HUT	\$3,129	\$3,172	\$3,683
	30	72	36	116	56	LKT3072-36HUT	\$2,429	\$2,459	\$2,909	\$2,937

Features:

- price reflects complete table - top and base
- ships KD in multiple cartons
- model includes adjustable glide

Options:

- specify power option; None (N), add \$663 for EC23 (CTEC23), add \$549 for EC24 (CTEC24)

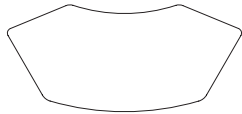

top shape

LOK - TEAMWORK

To Order Specify

1 Laminite Model #	2 Edge Detail	3 Laminite Selection	3a PVC Edge Color	4 Electrical
Laminite (LKT)	See Edge Detail Options	See Laminite Selection	See PVC Edge Color Options	N None CTEC23 Power Center Top (See chart on next page) CTEC24 Power Center Top 5 Metal Finish See Metal Finish Color Options

Model Number Breakdown

LKT3684-36HUT					
LK	T	3684	36	HU	T
LOK	Laminite	36" x 84"	Height	Huddle Top Shape	T base

Description

Huddle Table with T Base at Counter Height
(continued)

Veneer Tables
"LKV" Models

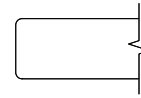

Eased Edge (R3)

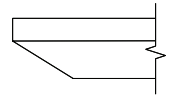

Reverse Bevel Edge (K9)

VENEER	D	W	H	CTN WT	CU FT	① Model	Essentials	Artisan	Essentials	Artisan
	36	84	36	143	78	LKV3684-36HUT	\$3,529	\$3,814	\$3,849	\$4,097
30	72	36	116	56	LKV3072-36HUT	\$3,002	\$3,242	\$3,273	\$3,485	

LOK - TEAMWORK

Electrical Options and Upcharges

CTEC23	
EC23 Power Center Top - Black	CTEC23BL - add \$663
EC23 Power Center Top - White	CTEC23WH - add \$663
CTEC24	
EC24 Power Center Top - Black	CTEC43BL - add \$549
EC24 Power Center Top - White	CTEC43WH - add \$549

Note: Order power infeed that best fits application

To Order, Specify:

① Veneer Model #	② Edge Detail	③ Wood Collection	④ Top Wood Finish	⑤ Electrical	⑥ Metal Color
Veneer (LKV)	See Edge Detail Options	Essentials	See Essentials Top Wood Finish Options	N None CTEC23 Power Center Top CTEC24 Power Center Top (See chart above)	See Metal Finish Color Options
		Artisan	④ Top Wood Finish See Artisan Top Wood Finish Options		

Description

One-Twenty Table with T Base at Counter Height

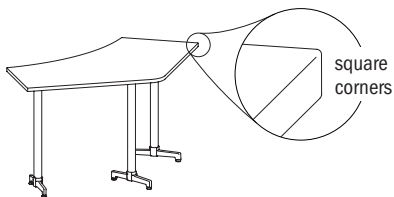

Laminate Tables "LKT" Models

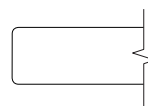

Eased Edge (R3)

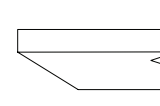

Reverse Bevel Edge (K9)

LAMINATE	D	W	H	CTN WT	CU FT	1 Model	Standard Tier 1	Graded In Tier 2	Standard Tier 1	Graded In Tier 2
		45	84	36	118	94	LKT4584-36YGT	\$3,001	\$3,051	\$3,522
	42	73	36	107	78	LKT4273-36YGT	\$2,600	\$2,638	\$3,101	\$3,139

Features:

- price reflects complete table - top and base
- ships KD in multiple cartons
- model includes adjustable glide

Options:

- specify power option and or charging option, see below for options and upcharges

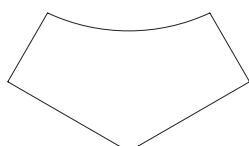

top shape

LOK - TEAMWORK

To Order Specify

1 Laminite Model #	2 Edge Detail	3 Laminite Selection	4 PVC Edge Color	5 Electrical
Laminite (LKT)	See Edge Detail Options	See Laminite Selection	See PVC Edge Color Options	<p>N None</p> <p>CT1 Single Power Center Top</p> <p>CU1 Single Power Underside</p> <p>CT1U1 Single Power Center Top</p> <p>LRT2 Dual Power Left/Right</p> <p>LRT2CU1 Dual Power Left/Right Top w/Underside</p> <p>(See chart on next page)</p>
				<p>5 Metal Finish</p> <p>See Metal Finish Color Options</p>

Model Number Breakdown

LKT4584-36YGT					
LK	T	4584	36	YG	T
LOK	Laminite	45" x 84"	Height	One-Twenty Top Shape	T base

Description

One-Twenty Table with T Base at Counter Height
(continued)

Veneer Tables
"LKV" Models

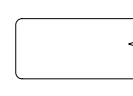

Eased Edge (R3)

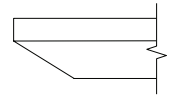

Reverse Bevel Edge (K9)

VENEER	D	W	H	CTN WT	CU FT	① Model	Essentials	Artisan	Essentials	Artisan
	45	84	36	118	94	LKV4584-36YGT	\$3,407	\$3,679	\$3,713	\$3,952
42	73	36	107	78	LKV4273-36YGT	\$3,187	\$3,442	\$3,473	\$3,699	

Electrical Options and Upcharges

	73 - 84 wide	
	Circuit 1	Circuit 2
CT1		
Single Power Center Top - Black	CT11CBL - add \$685	CT12CBL - add \$685
Single Power Center Top - White	CT11CWH - add \$685	CT12CWH - add \$685
CU1		
Single Power Underside - Black	CU11C - add \$712	CU12C - add \$712
Single Power Underside with Wireless Charging - Black	CU11CW - add \$1,540	CU12CW - add \$1,540
CT1U1		
Single Power Center Top - Black with Underside	CT1U1-1CBL - add \$1,336	CT1U1-2CBL - add \$1,336
Single Power Center Top - White with Underside	CT1U1-1CWH - add \$1,336	CT1U1-2CWH - add \$1,336
Single Power Center Top - Black with Wireless Charging	CT1U1-1CWBL - add \$2,138	CT1U1-2CWBL - add \$2,138
Single Power Center Top - White with Wireless Charging	CT1U1-1CWHW - add \$2,138	CT1U1-2CWHW - add \$2,138
LRT2CU1		
Dual Power Left/Right Top with Underside - Black	LRT2CU1-1CBL - add \$2,489	LRT2CU1-2CBL - add \$2,489
Dual Power Left/Right Top with Underside - White	LRT2CU1-1CWH - add \$2,489	LRT2CU1-2CWH - add \$2,489
Dual Power Left/Right Top - Black with Underside & Wireless Charging	LRT2CU1-1CWBL - add \$3,292	LRT2CU1-2CWBL - add \$3,292
Dual Power Left/Right Top - White with Underside & Wireless Charging	LRT2CU1-1CWHW - add \$3,292	LRT2CU1-2CWHW - add \$3,292
LRT2		
Dual Power Left/Right Top - Black	LRT2-1CBL - add \$1,209	LRT2-2CBL - add \$1,209
Dual Power Left/Right Top - White	LRT2-1CWH - add \$1,209	LRT2-2CWH - add \$1,209

LOK - TEAMWORK

Note: Order power infeed that best fits application

To Order, Specify:

① Veneer Model #	② Edge Detail	③ Wood Collection	④ Top Wood Finish	⑤ Electrical	⑥ Metal Color
Veneer (LKV)	See Edge Detail Options	Essentials	See Essentials Top Wood Finish Options	N None CT1 Single Power Center Top CU1 Single Power Underside CT1U1 Single Power Center Top LRT2 Dual Power Left/Right LRT2CU1 Dual Power Left/Right Top with Underside (See chart above)	See Metal Finish Color Options
			Artisan		

Description

Rounded One-Twenty Table with T Base at Counter Height

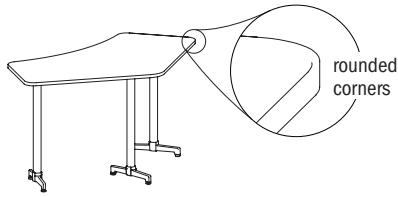

Laminate Tables "LKT" Models

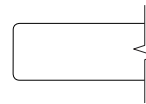

Eased Edge (R3)

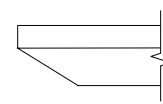

Reverse Bevel Edge (K9)

LAMINATE	D	W	H	CTN WT	CU FT	1 Model	Standard Tier 1	Graded In Tier 2	Standard Tier 1	Graded In Tier 2
		45	84	36	118	94	LKT4584-36YGRT	\$3,001	\$3,051	\$3,522
	42	73	36	107	78	LKT4273-36YGRT	\$2,600	\$2,638	\$3,101	\$3,139

Features:

- price reflects complete table - top and base
- ships KD in multiple cartons
- model includes adjustable glide

Options:

- specify power option and or charging option, see below for options and upcharges

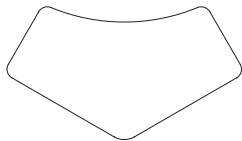

top shape

LOK - TEAMWORK

To Order Specify

1 Laminite Model #	2 Edge Detail	3 Laminite Selection	3a PVC Edge Color	4 Electrical
Laminite (LKT)	See Edge Detail Options	See Laminite Selection	See PVC Edge Color Options	N None CT2 Dual Power Center Top (See chart on next page) CU1 Single Power Underside 5 Metal Finish See Metal Finish Color Options

Model Number Breakdown

LKT4584-36YGRT						
LK	T	4584	36	YG	R	T
LOK	Laminite	45" x 84"	Height	One-Twenty Top Shape	Rounded Corner	T base

Description

Rounded One-twenty Table with T Base at Counter Height (continued)

Veneer Tables "LKV" Models

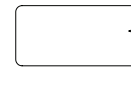

Eased Edge (R3)

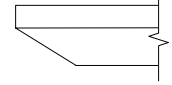

Reverse Bevel Edge (K9)

VENEER	D	W	H	CTN WT	CU FT	Model	Essentials	Artisan	Essentials	Artisan
	45	84	36	118	94	LKV4584-36YGRT	\$3,407	\$3,679	\$3,713	\$3,952
42	73	36	107	78	LKV4273-36YGRT	\$3,187	\$3,442	\$3,473	\$3,699	

Electrical Options and Upcharges

	73 - 84 wide	
	Circuit 1	Circuit 2
CT1		
Single Power Center Top - Black	CT11CBL - add \$685	CT12CBL - add \$685
Single Power Center Top - White	CT11CWH - add \$685	CT12CWH - add \$685
CU1		
Single Power Underside - Black	CU11C - add \$712	CU12C - add \$712
Single Power Underside with Wireless Charging - Black	CU11CW - add \$1,540	CU12CW - add \$1,540
CT1U1		
Single Power Center Top - Black with Underside	CT1U1-1CBL - add \$1,336	CT1U1-2CBL - add \$1,336
Single Power Center Top - White with Underside	CT1U1-1CWH - add \$1,336	CT1U1-2CWH - add \$1,336
Single Power Center Top - Black with Wireless Charging	CT1U1-1CWBL - add \$2,138	CT1U1-2CWBL - add \$2,138
Single Power Center Top - White with Wireless Charging	CT1U1-1CWHW - add \$2,138	CT1U1-2CWHW - add \$2,138
LRT2CU1		
Dual Power Left/Right Top with Underside - Black	LRT2CU1-1CBL - add \$2,489	LRT2CU1-2CBL - add \$2,489
Dual Power Left/Right Top with Underside - White	LRT2CU1-1CWH - add \$2,489	LRT2CU1-2CWH - add \$2,489
Dual Power Left/Right Top - Black with Underside & Wireless Charging	LRT2CU1-1CWBL - add \$3,292	LRT2CU1-2CWBL - add \$3,292
Dual Power Left/Right Top - White with Underside & Wireless Charging	LRT2CU1-1CWHW - add \$3,292	LRT2CU1-2CWHW - add \$3,292
LRT2		
Dual Power Left/Right Top - Black	LRT2-1CBL - add \$1,209	LRT2-2CBL - add \$1,209
Dual Power Left/Right Top - White	LRT2-1CWH - add \$1,209	LRT2-2CWH - add \$1,209

LOK - TEAMWORK

Note: Order power infeed that best fits application

To Order, Specify:

1 Veneer Model #	2 Edge Detail	3 Wood Collection	4 Top Wood Finish	5 Electrical	6 Metal Color
Veneer (LKV)	See Edge Detail Options	Essentials	See Essentials Top Wood Finish Options	N None CT1 Single Power Center Top CU1 Single Power Underside CT1U1 Single Power Center Top LRT2 Dual Power Left/Right LRT2CU1 Dual Power Left/Right Top with Underside (See chart above)	See Metal Finish Color Options
		Artisan	4 Top Wood Finish See Artisan Top Wood Finish Options		

Description

Home Base Table with X Base at Counter Height



Laminate Tables
"LKT" Models

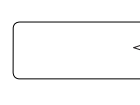

Eased Edge (R3)

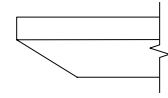

Reverse Bevel Edge (K9)

LAMINATE	D	W	H	CTN WT	CU FT	① Model	Standard Tier 1	Graded In Tier 2	Standard Tier 1	Graded In Tier 2
		30	36	36	75	30	LKT3036-36HBX	\$1,438	\$1,473	\$1,896
	24	30	36	59	21	LKT2430-36HBX	\$1,223	\$1,234	\$1,677	\$1,690

Features:

- price reflects complete table - top and base
- ships KD in multiple cartons
- model includes adjustable glide

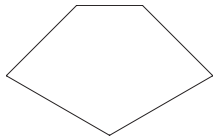

top shape

LOK - TEAMWORK

To Order Specify

① Laminate Model #	② Edge Detail	③ Laminate Selection	④ PVC Edge Color	⑤ Metal Finish
Laminate (LKT)	See Edge Detail Options	See Laminate Selection	See PVC Edge Color Options	See Metal Finish Color Options

Model Number Breakdown

LKT3036-36HBX					
LK	T	3036	36	HB	X
LOK	Laminate	30" x 36"	Height	Home Base Top Shape	X base

133.35 Lok

Description

Home Base Table with X Base at Counter Height
(continued)

Veneer Tables
"LKV" Models

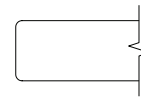

Eased Edge (R3)

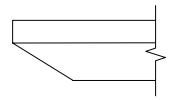

Reverse Bevel Edge (K9)

VENEER	D	W	H	CTN WT	CU FT	① Model	Eased Edge (R3)		Reverse Bevel Edge (K9)	
							Essentials	Artisan	Essentials	Artisan
	30	36	36	75	30	LKV3036-36HBX	\$1,883	\$2,036	\$2,051	\$2,184
	24	30	36	59	21	LKV2430-36HBX	\$1,769	\$1,910	\$1,929	\$2,053

LOK-TEAMWORK

To Order, Specify:

① Veneer Model #	② Edge Detail	③ Wood Collection	④ Top Wood Finish	⑤ Metal Color
Veneer (LKV)	See Edge Detail Options	Essentials	See Essentials Top Wood Finish Options	See Metal Finish Color Options
		Artisan	④ Top Wood Finish See Artisan Top Wood Finish Options	

Description

Boomerang Table - Left with T Base at Counter Height

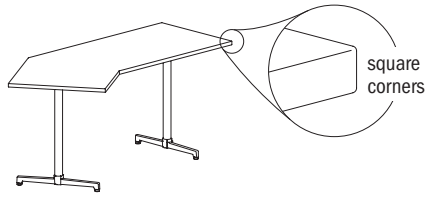

Laminate Tables "LKT" Models

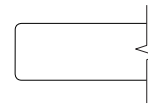

Eased Edge (R3)

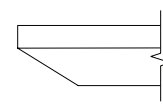

Reverse Bevel Edge (K9)

LAMINATE	D	W	H	CTN WT	CU FT	Model	Standard Tier 1	Graded In Tier 2	Standard Tier 1	Graded In Tier 2
		36	84	36	139	78	LKT3684-36BMLT	\$2,594	\$2,636	\$3,149
	36	84	36	139	78	LKT3684-36BMRT	\$2,594	\$2,636	\$3,149	\$3,191
	30	84	36	121	66	LKT3084-36BMLT	\$2,219	\$2,250	\$2,705	\$2,736
	30	84	36	121	66	LKT3084-36BMRT	\$2,219	\$2,250	\$2,705	\$2,736

Features:

- price reflects complete table - top and base
- ships KD in multiple cartons
- model includes adjustable glide

Options:

- specify power option and or charging option, see below for options and upcharges

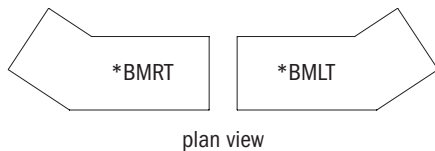

plan view

LOK - TEAMWORK

To Order Specify

1 Laminate Model #	2 Edge Detail	3 Laminate Selection	3a PVC Edge Color	4 Electrical
Laminate (LKT)	See Edge Detail Options	See Laminate Selection	See PVC Edge Color Options	<p>4 Electrical</p> <p>N None CT1U1 Single Power Center Top CT1 Single Power Center Top LRT2 Dual Power Left/Right CU1 Single Power Underside LRT2CU1 Dual Power Left/Right Top w/Underside (See chart on next page)</p> <p>5 Metal Finish</p> <p>See Metal Finish Color Options.</p>

Model Number Breakdown

LKT3684-36BMLT					
LK	T	3684	36	BML	T
LOK	Laminate	36" x 84"	Height	Boomerang Left Top Shape	T base

Description

Boomerang Table - Left with T Base
at Counter Height (continued)

Veneer Tables
"LKV" Models

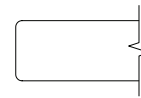

Eased Edge (R3)

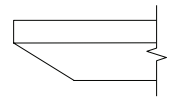

Reverse Bevel Edge (K9)

VENEER	D	W	H	CTN WT	CU FT	① Model	Essentials	Artisan	Essentials	Artisan
		36	84	36	139	78	LKV3684-36BMLT	\$3,306	\$3,568	\$3,602
	36	84	36	139	78	LKV3684-36BMRT	\$3,306	\$3,568	\$3,602	\$3,834
	30	84	36	121	66	LKV3084-36BMLT	\$2,895	\$3,123	\$3,152	\$3,356
	30	84	36	121	66	LKV3084-36BMRT	\$2,895	\$3,123	\$3,152	\$3,356

Electrical Options and Upcharges

	73 - 84 wide	
	Circuit 1	Circuit 2
CT1		
Single Power Center Top - Black	CT11CBL - add \$685	CT12CBL - add \$685
Single Power Center Top - White	CT11CWH - add \$685	CT12CWH - add \$685
CU1		
Single Power Underside - Black	CU11C - add \$712	CU12C - add \$712
Single Power Underside with Wireless Charging - Black	CU11CW - add \$1,540	CU12CW - add \$1,540
CT1U1		
Single Power Center Top - Black with Underside	CT1U1-1CBL - add \$1,336	CT1U1-2CBL - add \$1,336
Single Power Center Top - White with Underside	CT1U1-1CWH - add \$1,336	CT1U1-2CWH - add \$1,336
Single Power Center Top - Black with Wireless Charging	CT1U1-1CWBL - add \$2,138	CT1U1-2CWBL - add \$2,138
Single Power Center Top - White with Wireless Charging	CT1U1-1CWHW - add \$2,138	CT1U1-2CWHW - add \$2,138
LRT2CU1		
Dual Power Left/Right Top with Underside - Black	LRT2CU1-1CBL - add \$2,489	LRT2CU1-2CBL - add \$2,489
Dual Power Left/Right Top with Underside - White	LRT2CU1-1CWH - add \$2,489	LRT2CU1-2CWH - add \$2,489
Dual Power Left/Right Top - Black with Underside & Wireless Charging	LRT2CU1-1CWBL - add \$3,292	LRT2CU1-2CWBL - add \$3,292
Dual Power Left/Right Top - White with Underside & Wireless Charging	LRT2CU1-1CWHW - add \$3,292	LRT2CU1-2CWHW - add \$3,292
LRT2		
Dual Power Left/Right Top - Black	LRT2-1CBL - add \$1,209	LRT2-2CBL - add \$1,209
Dual Power Left/Right Top - White	LRT2-1CWH - add \$1,209	LRT2-2CWH - add \$1,209

LOK - TEAMWORK

Note: Order power infeed that best fits application

To Order, Specify:

① Veneer Model #	② Edge Detail	③ Wood Collection	④ Top Wood Finish	⑤ Electrical	⑥ Metal Color
Veneer (LKV)	See Edge Detail Options	Essentials	See Essentials Top Wood Finish Options	N None CT1 Single Power Center Top CU1 Single Power Underside CT1U1 Single Power Center Top LRT2 Dual Power Left/Right LRT2CU1 Dual Power Left/Right Top with Underside (See chart above)	See Metal Finish Color Options
			Artisan		

Description

Rounded Boomerang Table - Left with T Base at Counter Height

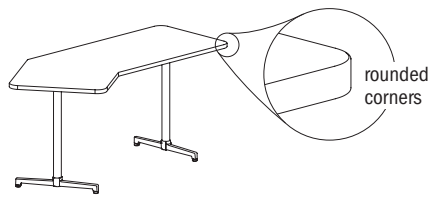

Laminate Tables "LKT" Models

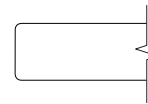

Eased Edge (R3)

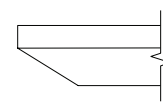

Reverse Bevel Edge (K9)

LAMINATE	D	W	H	CTN WT	CU FT	1 Model	Standard Tier 1	Graded In Tier 2	Standard Tier 1	Graded In Tier 2
		36	84	36	101	78	LKT3684-36BMLRT	\$2,594	\$2,636	\$3,149
	36	84	36	139	78	LKT3684-36BMRRT	\$2,594	\$2,636	\$3,149	\$3,191
	30	84	36	121	66	LKT3084-36BMLRT	\$2,219	\$2,250	\$2,705	\$2,736
	30	84	36	121	66	LKT3084-36BMRRT	\$2,219	\$2,250	\$2,705	\$2,736

Features:

- price reflects complete table - top and base
- ships KD in multiple cartons
- model includes adjustable glide

Options:

- specify power option and or charging option, see below for options and upcharges



top shape

LOK - TEAMWORK

To Order Specify

1 Laminate Model #	2 Edge Detail	3 Laminate Selection	3a PVC Edge Color	4 Electrical
Laminate (LKT)	See Edge Detail Options	See Laminate Selection	See PVC Edge Color Options	<p>4 Electrical</p> <p>N None CT1U1 Single Power Center Top CT1 Single Power Center Top LRT2 Dual Power Left/Right CU1 Single Power Underside LRT2CU1 Dual Power Left/Right Top w/Underside (See chart on next page)</p> <p>5 Metal Finish</p> <p>See Metal Finish Color Options</p>

Model Number Breakdown

LKT3684-36BMLRT						
LK	T	3684	36	BML	R	T
LOK	Laminate	36" x 84"	Height	Boomerang Left Top Shape	Rounded Corner	T base

Description

Rounded Boomerang Table - Left with T Base at Counter Height (continued)

Veneer Tables
"LKV" Models

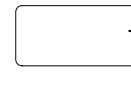

Eased Edge (R3)

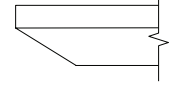

Reverse Bevel Edge (K9)

VENEER	D	W	H	CTN WT	CU FT	① Model	Essentials	Artisan	Essentials	Artisan
		36	84	36	143	78	LKV3684-36BMLRT	\$3,306	\$3,568	\$3,602
	36	84	36	139	78	LKV3684-36BMRRT	\$3,306	\$3,568	\$3,602	\$3,834
	30	84	36	101	66	LKV3084-36BMLRT	\$2,895	\$3,123	\$3,152	\$3,356
	30	84	36	121	66	LKV3084-36BMRRT	\$2,895	\$3,123	\$3,152	\$3,356

Electrical Options and Upcharges

	73 - 84 wide	
	Circuit 1	Circuit 2
CT1		
Single Power Center Top - Black	CT11CBL - add \$685	CT12CBL - add \$685
Single Power Center Top - White	CT11CWH - add \$685	CT12CWH - add \$685
CU1		
Single Power Underside - Black	CU11C - add \$712	CU12C - add \$712
Single Power Underside with Wireless Charging - Black	CU11CW - add \$1,540	CU12CW - add \$1,540
CT1U1		
Single Power Center Top - Black with Underside	CT1U1-1CBL - add \$1,336	CT1U1-2CBL - add \$1,336
Single Power Center Top - White with Underside	CT1U1-1CWH - add \$1,336	CT1U1-2CWH - add \$1,336
Single Power Center Top - Black with Wireless Charging	CT1U1-1CWBL - add \$2,138	CT1U1-2CWBL - add \$2,138
Single Power Center Top - White with Wireless Charging	CT1U1-1CWHW - add \$2,138	CT1U1-2CWHW - add \$2,138
LRT2CU1		
Dual Power Left/Right Top with Underside - Black	LRT2CU1-1CBL - add \$2,489	LRT2CU1-2CBL - add \$2,489
Dual Power Left/Right Top with Underside - White	LRT2CU1-1CWH - add \$2,489	LRT2CU1-2CWH - add \$2,489
Dual Power Left/Right Top - Black with Underside & Wireless Charging	LRT2CU1-1CWBL - add \$3,292	LRT2CU1-2CWBL - add \$3,292
Dual Power Left/Right Top - White with Underside & Wireless Charging	LRT2CU1-1CWHW - add \$3,292	LRT2CU1-2CWHW - add \$3,292
LRT2		
Dual Power Left/Right Top - Black	LRT2-1CBL - add \$1,209	LRT2-2CBL - add \$1,209
Dual Power Left/Right Top - White	LRT2-1CWH - add \$1,209	LRT2-2CWH - add \$1,209

LOK - TEAMWORK

Note: Order power infeed that best fits application

To Order, Specify:

① Veneer Model #	② Edge Detail	③ Wood Collection	④ Top Wood Finish	⑤ Electrical	⑥ Metal Color
Veneer (LKV)	See Edge Detail Options	Essentials	See Essentials Top Wood Finish Options	N None CT1 Single Power Center Top CU1 Single Power Underside CT1U1 Single Power Center Top LRT2 Dual Power Left/Right LRT2CU1 Dual Power Left/Right with Underside (See chart above)	See Metal Finish Color Options
			Artisan		

Description

Wedge Table with T Base at Counter Height

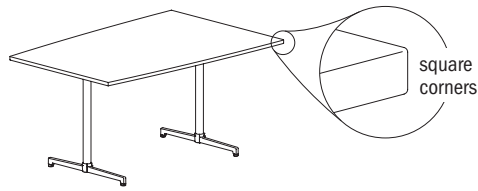

Laminate Tables
"LKT" Models

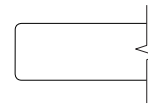

Eased Edge (R3)

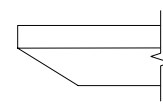

Reverse Bevel Edge (K9)

LAMI	D	W	H	CTN WT	CU FT	1 Model	Standard Tier 1	Graded In Tier 2	Standard Tier 1	Graded In Tier 2
		48	72	36	156	87	LKT4872-36WDT	\$2,276	\$2,321	\$2,787

Features:

- price reflects complete table - top and base
- ships KD in multiple cartons
- model includes adjustable glide

Options:

- specify power option and or charging option, see below for options and upcharges

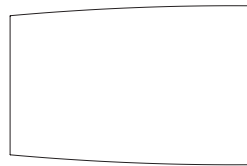

top shape

LOK - TEAMWORK

To Order Specify

1 Laminate Model #	2 Edge Detail	3 Laminate Selection	3a PVC Edge Color	4 Electrical
Laminate (LKT)	See Edge Detail Options	See Laminate Selection	See PVC Edge Color Options	N None CT2 Dual Power Center Top (See chart on next page) CU1 Single Power Underside 5 Metal Finish See Metal Finish Color Options

Model Number Breakdown

LKT4872-36WDT					
LK	T	4872	36	WD	T
LOK	Laminate	48" x 72"	Height	Wedge Top Shape	T base

Description

Wedge Table with T Base at Counter Height
(continued)

Veneer Tables
"LKV" Models

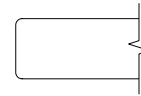

Eased Edge (R3)

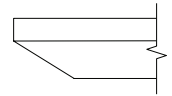

Reverse Bevel Edge (K9)

VEN.	D	W	H	CTN WT	CU FT	① Model	Eased Edge (R3)		Reverse Bevel Edge (K9)	
							Essentials	Artisan	Essentials	Artisan
	48	72	36	156	87	LKV4872-36WDT	\$2,868	\$3,098	\$3,124	\$3,328

LOK - TEAMWORK

Electrical Options and Upcharges

CT2	
Dual Power Center Top - Black	CT2BL - add \$1,481
Dual Power Center Top - White	CT2WH - add \$1,481
CU1	
Single Power Underside - Black	CU11C - add \$576
Single Power Underside with Wireless Charging - Black	CU11CW - add \$1,379

Note: Order power infeed that best fits application

To Order, Specify:

① Veneer Model #	② Edge Detail	③ Wood Collection	④ Top Wood Finish	⑤ Electrical	⑥ Metal Color
Veneer (LKV)	See Edge Detail Options	Essentials	See Essentials Top Wood Finish Options	N None CT2 Dual Power Center Top CU1 Single Power Underside (See chart above)	See Metal Finish Color Options
		Artisan	④ Top Wood Finish See Artisan Top Wood Finish Options		

Description

Rounded Wedge Table with T Base at Counter Height

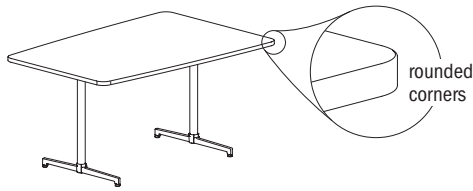

Laminate Tables
"LKT" Models

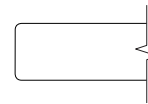

Eased Edge (R3)

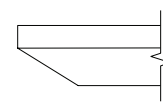

Reverse Bevel Edge (K9)

LAMI	D	W	H	CTN WT	CU FT	1 Model	Standard Tier 1	Graded In Tier 2	Standard Tier 1	Graded In Tier 2
		48	72	36	156	87	LKT4872-36WDRT	\$2,276	\$2,321	\$2,787

Features:

- price reflects complete table - top and base
- ships KD in multiple cartons
- model includes adjustable glide

Options:

- specify power option and or charging option, see below for options and upcharges

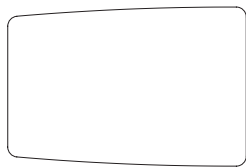

top shape

LOK - TEAMWORK

To Order Specify

1 Laminate Model #	2 Edge Detail	3 Laminate Selection	3a PVC Edge Color	4 Electrical
Laminate (LKT)	See Edge Detail Options	See Laminate Selection	See PVC Edge Color Options	N None CT2 Dual Power Center Top (See chart on next page) CU1 Single Power Underside 5 Metal Finish See Metal Finish Color Options

Model Number Breakdown

LKT4872-36WDRT						
LK	T	4872	36	WD	R	T
LOK	Laminate	48" x 72"	Height	Wedge Top Shape	Rounded Corner	T base

Description

Rounded Wedge Table with T Base at Counter Height
(continued)

Veneer Tables
"LKV" Models

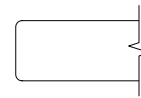

Eased Edge (R3)

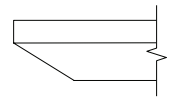

Reverse Bevel Edge (K9)

VEN.	D	W	H	CTN WT	CU FT	① Model	Essentials		Artisan	
							Essentials	Artisan	Essentials	Artisan
	48	72	36	156	87	LKV4872-36WDRT	\$2,868	\$3,098	\$3,124	\$3,328

LOK - TEAMWORK

Electrical Options and Upcharges

CT2	
Dual Power Center Top - Black	CT2BL - add \$1,481
Dual Power Center Top - White	CT2WH - add \$1,481
CU1	
Single Power Underside - Black	CU11C - add \$576
Single Power Underside with Wireless Charging - Black	CU11CW - add \$1,379

Note: Order power infeed that best fits application

To Order, Specify:

① Veneer Model #	② Edge Detail	③ Wood Collection	④ Top Wood Finish	⑤ Electrical	⑥ Metal Color
Veneer (LKV)	See Edge Detail Options	Essentials	See Essentials Top Wood Finish Options	N None CT2 Dual Power Center Top CU1 Single Power Underside (See chart above)	See Metal Finish Color Options
		Artisan	④ Top Wood Finish See Artisan Top Wood Finish Options		

Description

Rectangular Table with T Base at Bar Height

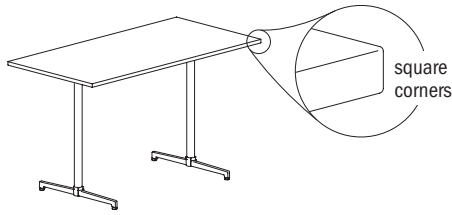

Laminate Tables
"LKT" Models

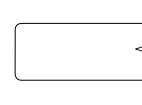

Eased Edge (R3)

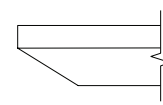

Reverse Bevel Edge (K9)

D	W	H	CTN WT	CU FT	Model	Eased Edge (R3)		Reverse Bevel Edge (K9)	
						Standard Tier 1	Graded In Tier 2	Standard Tier 1	Graded In Tier 2
48	72	42	164	101	LKT4872-42TTT	\$2,347	\$2,391	\$2,881	\$2,928
42	72	42	149	89	LKT4272-42TTT	\$2,243	\$2,283	\$2,767	\$2,807
36	72	42	139	77	LKT3672-42TTT	\$2,028	\$2,098	\$2,498	\$2,567
36	66	42	129	72	LKT3666-42TTT	\$1,963	\$2,028	\$2,429	\$2,498
36	60	42	121	66	LKT3660-42TTT	\$1,883	\$1,942	\$2,351	\$2,414

LAMINATE

Features:

- price reflects complete table - top and base
- ships KD in multiple cartons
- model includes adjustable glide

Options:

- specify power/charging option, see below for options and upcharges

LOK - TEAMWORK

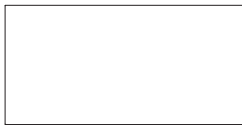

top shape

To Order Specify

1 Laminate Model #	2 Edge Detail	3 Laminate Selection	3a PVC Edge Color	4 Electrical
Laminate (LKT)	See Edge Detail Options	See Laminate Selection	See PVC Edge Color Options	N None CT2 Dual Power Center Top (See chart on next page) CU1 Single Power Underside 5 Metal Finish See Metal Finish Color Options

Model Number Breakdown

LKT4872-42TTT					
LK	T	4872	42	TT	T
LOK	Laminate	48" x 72"	Height	Rectangular Top Shape	T base

Description

Rectangular Table with T Base at Bar Height
(continued)

Veneer Tables
"LKV" Models

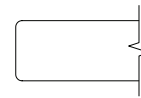

Eased Edge (R3)

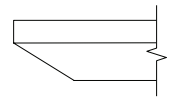

Reverse Bevel Edge (K9)

D	W	H	CTN WT	CU FT	① Model	Eased Edge (R3)		Reverse Bevel Edge (K9)	
						Essentials	Artisan	Essentials	Artisan
48	72	42	140	101	LKV4872-42TTT	\$2,675	\$2,912	\$2,935	\$3,154
42	72	42	149	89	LKV4272-42TTT	\$2,564	\$2,774	\$2,811	\$3,008
36	72	42	139	77	LKV3672-42TTT	\$2,341	\$2,549	\$2,523	\$2,724
36	66	42	129	72	LKV3666-42TTT	\$2,295	\$2,488	\$2,470	\$2,658
36	60	42	121	66	LKV3660-42TTT	\$2,234	\$2,414	\$2,400	\$2,575

VENEER

LOK - TEAMWORK

Electrical Options and Upcharges

CT2	
Dual Power Center Top - Black	CT2BL - add \$1,481
Dual Power Center Top - White	CT2WH - add \$1,481
CU1	
Single Power Underside - Black	CU11C - add \$576
Single Power Underside with Wireless Charging - Black	CU11CW - add \$1,379

Note: Order power infeed that best fits application

To Order, Specify:

① Veneer Model #	② Edge Detail	③ Wood Collection	④ Top Wood Finish	⑤ Electrical	⑥ Metal Color
Veneer (LKV)	See Edge Detail Options	Essentials	See Essentials Top Wood Finish Options	N None CT2 Dual Power Center Top CU1 Single Power Underside (See chart above)	See Metal Finish Color Options
		Artisan	④ Top Wood Finish See Artisan Top Wood Finish Options		

Description

Rounded Rectangular Table with T Base at Bar Height

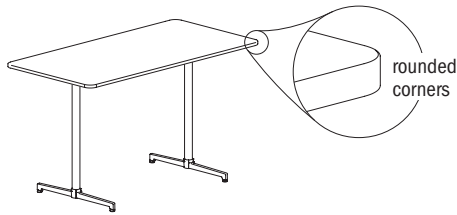

Laminate Tables
"LKT" Models

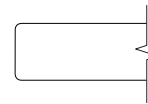

Eased Edge (R3)

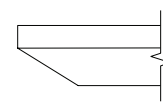

Reverse Bevel Edge (K9)

D	W	H	CTN WT	CU FT	Model	Eased Edge (R3)		Reverse Bevel Edge (K9)	
						Standard Tier 1	Graded In Tier 2	Standard Tier 1	Graded In Tier 2
48	72	42	164	101	LKT4872-42TTRT	\$2,411	\$2,456	\$2,944	\$2,991
42	72	42	149	89	LKT4272-42TTRT	\$2,302	\$2,341	\$2,825	\$2,866
36	72	42	139	77	LKT3672-42TTRT	\$2,193	\$2,227	\$2,707	\$2,741
36	66	42	129	72	LKT3666-42TTRT	\$2,105	\$2,136	\$2,616	\$2,647
36	60	42	121	66	LKT3660-42TTRT	\$2,048	\$2,077	\$2,554	\$2,582

LAMINATE

Features:

- price reflects complete table - top and base
- ships KD in multiple cartons
- model includes adjustable glide

Options:

- specify power/charging option, see below for options and upcharges

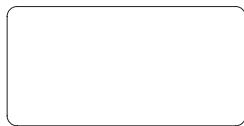

top shape

LOK - TEAMWORK

To Order Specify

1 Laminate Model #	2 Edge Detail	3 Laminate Selection	3a PVC Edge Color	4 Electrical
Laminate (LKT)	See Edge Detail Options	See Laminate Selection	See PVC Edge Color Options	N None CT2 Dual Power Center Top (See chart on next page) CU1 Single Power Underside 5 Metal Finish See Metal Finish Color Options

Model Number Breakdown

LKT4872-42TTRT						
LK	T	4872	42	TT	R	T
LOK	Laminate	48" x 72"	Height	Rectangular Top Shape	Rounded Corner	T base

Description

Rounded Rectangular Table with T Base at Bar Height
(continued)

Veneer Tables
"LKV" Models

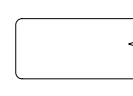

Eased Edge (R3)

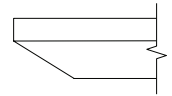

Reverse Bevel Edge (K9)

VENEER	D	W	H	CTN WT	CU FT	① Model	Essentials	Artisan	Essentials	Artisan
		48	72	42	164	101	LKV4872-42TTRT	\$2,736	\$2,976	\$2,998
	42	72	42	149	89	LKV4272-42TTRT	\$2,622	\$2,834	\$2,870	\$3,065
	36	72	42	139	77	LKV3672-42TTRT	\$2,505	\$2,722	\$2,594	\$2,799
	36	66	42	129	72	LKV3666-42TTRT	\$2,415	\$2,583	\$2,646	\$2,800
	36	60	42	121	66	LKV3660-42TTRT	\$2,388	\$2,575	\$2,467	\$2,645

LOK - TEAMWORK

Electrical Options and Upcharges

CT2	
Dual Power Center Top - Black	CT2BL - add \$1,481
Dual Power Center Top - White	CT2WH - add \$1,481
CU1	
Single Power Underside - Black	CU11C - add \$576
Single Power Underside with Wireless Charging - Black	CU11CW - add \$1,379

Note: Order power infeed that best fits application

To Order, Specify:

① Veneer Model #	② Edge Detail	③ Wood Collection	④ Top Wood Finish	⑤ Electrical	⑥ Metal Color
Veneer (LKV)	See Edge Detail Options	Essentials	See Essentials Top Wood Finish Options	N None CT2 Dual Power Center Top CU1 Single Power Underside (See chart above)	See Metal Finish Color Options
		Artisan	④ Top Wood Finish See Artisan Top Wood Finish Options		

Description

Rectangular Table with X Base at Bar Height

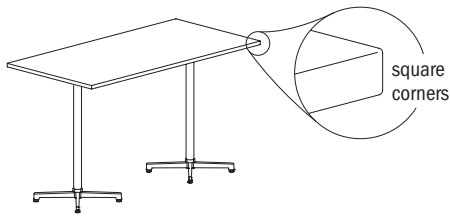

Laminate Tables
"LKT" Models

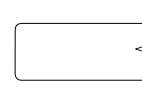

Eased Edge (R3)

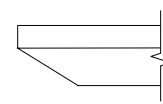

Reverse Bevel Edge (K9)

LAMINATE	D	W	H	CTN WT	CU FT	1 Model	Standard Tier 1	Graded In Tier 2	Standard Tier 1	Graded In Tier 2
		48	72	42	169	101	LKT4872-42TTX	\$2,861	\$2,907	\$3,395
	42	72	42	153	90	LKT4272-42TTX	\$2,757	\$2,797	\$3,281	\$3,321
	36	72	42	136	78	LKT3672-42TTX	\$2,603	\$2,675	\$3,074	\$3,144

Features:

- price reflects complete table - top and base
- ships KD in multiple cartons
- model includes adjustable glide

Options:

- specify power/charging option, see below for options and upcharges

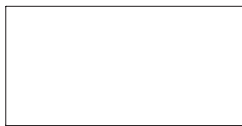

top shape

LOK - TEAMWORK

To Order Specify

1 Laminates Model #	2 Edge Detail	3 Laminates Selection	3a PVC Edge Color	4 Electrical
Laminates (LKT)	See Edge Detail Options	See Laminates Selection	See PVC Edge Color Options	N None CT2 Dual Power Center Top (See chart on next page) CU1 Single Power Underside 5 Metal Finish See Metal Finish Color Options

Model Number Breakdown

LKT4872-42TTX					
LK	T	4872	42	TT	X
LOK	Laminates	48" x 72"	Height	Rectangular Top Shape	X base

Description

Rectangular Table with X Base at Bar Height
(continued)

Veneer Tables
"LKV" Models

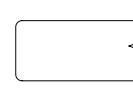

Eased Edge (R3)

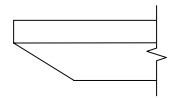

Reverse Bevel Edge (K9)

D	W	H	CTN WT	CU FT	① Model	Eased Edge (R3)		Reverse Bevel Edge (K9)	
						Essentials	Artisan	Essentials	Artisan
48	72	42	169	101	LKV4872-42TTX	\$3,189	\$3,429	\$3,450	\$3,671
42	72	42	153	90	LKV4272-42TTX	\$3,078	\$3,289	\$3,327	\$3,522
36	72	42	136	78	LKV3672-42TTX	\$2,918	\$3,123	\$3,099	\$3,300

VENEER

LOK - TEAMWORK

Electrical Options and Upcharges

CT2	
Dual Power Center Top - Black	CT2BL - add \$1,481
Dual Power Center Top - White	CT2WH - add \$1,481
CU1	
Single Power Underside - Black	CU11C - add \$576
Single Power Underside with Wireless Charging - Black	CU11CW - add \$1,379

Note: Order power infeed that best fits application

To Order, Specify:

① Veneer Model #	② Edge Detail	③ Wood Collection	④ Top Wood Finish	⑤ Electrical	⑥ Metal Color
Veneer (LKV)	See Edge Detail Options	Essentials	See Essentials Top Wood Finish Options	N None CT2 Dual Power Center Top CU1 Single Power Underside (See chart above)	See Metal Finish Color Options
		Artisan	④ Top Wood Finish See Artisan Top Wood Finish Options		

Description

Rectangular Table with X Base at Bar Height

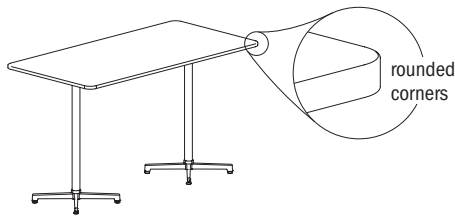

Laminate Tables
"LKT" Models

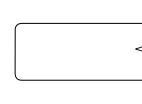

Eased Edge (R3)

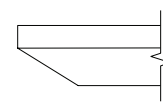

Reverse Bevel Edge (K9)

LAMINATE	D	W	H	CTN WT	CU FT	1 Model	Standard Tier 1	Graded In Tier 2	Standard Tier 1	Graded In Tier 2
		48	72	42	169	101	LKT4872-42TTRX	\$2,861	\$2,907	\$3,395
	42	72	42	153	90	LKT4272-42TTRX	\$2,757	\$2,797	\$3,281	\$3,321
	36	72	42	136	78	LKT3672-42TTRX	\$2,706	\$2,778	\$3,175	\$3,251

Features:

- price reflects complete table - top and base
- ships KD in multiple cartons
- model includes adjustable glide

Options:

- specify power/charging option, see below for options and upcharges



top shape

LOK - TEAMWORK

To Order Specify

1 Laminate Model #	2 Edge Detail	3 Laminate Selection	3a PVC Edge Color	4 Electrical
Laminate (LKT)	See Edge Detail Options	See Laminate Selection	See PVC Edge Color Options	N None CT2 Dual Power Center Top (See chart on next page) CU1 Single Power Underside 5 Metal Finish See Metal Finish Color Options

Model Number Breakdown

LKT4872-42TTRX						
LK	T	4872	42	TT	R	X
LK	Laminate	48" x 72"	Height	Rectangular Top Shape	Rounded Corner	X base

Description

Rectangular Table with X Base at Bar Height
(continued)

Veneer Tables
"LKV" Models

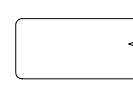

Eased Edge (R3)

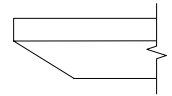

Reverse Bevel Edge (K9)

VENEER	D	W	H	CTN WT	CU FT	① Model	Essentials	Artisan	Essentials	Artisan
		48	72	42	169	101	LKV4872-42TTRX	\$3,189	\$3,429	\$3,450
	42	72	42	153	90	LKV4272-42TTRX	\$3,116	\$3,333	\$3,327	\$3,522
	36	72	42	136	78	LKV3672-42TTRX	\$3,078	\$3,289	\$3,206	\$3,411

LOK - TEAMWORK

Electrical Options and Upcharges

CT2	
Dual Power Center Top - Black	CT2BL - add \$1,481
Dual Power Center Top - White	CT2WH - add \$1,481
CU1	
Single Power Underside - Black	CU11C - add \$576
Single Power Underside with Wireless Charging - Black	CU11CW - add \$1,379

Note: Order power infeed that best fits application

To Order, Specify:

① Veneer Model #	② Edge Detail	③ Wood Collection	④ Top Wood Finish	⑤ Electrical	⑥ Metal Color
Veneer (LKV)	See Edge Detail Options	Essentials	See Essentials Top Wood Finish Options	N None CT2 Dual Power Center Top CU1 Single Power Underside (See chart above)	See Metal Finish Color Options
		Artisan	④ Top Wood Finish See Artisan Top Wood Finish Options		

Description

Arc Rectangular Table with T Base at Bar Height

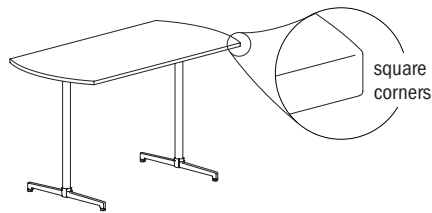

Laminate Tables
"LKT" Models

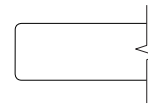

Eased Edge (R3)

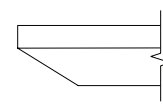

Reverse Bevel Edge (K9)

D	W	H	CTN WT	CU FT	① Model	Eased Edge (R3)		Reverse Bevel Edge (K9)	
						Standard Tier 1	Graded In Tier 2	Standard Tier 1	Graded In Tier 2
48	72	42	155	101	LKT4872-42ART	\$2,295	\$2,340	\$2,804	\$2,848
42	72	42	143	89	LKT4272-42ART	\$2,191	\$2,230	\$2,691	\$2,730
36	72	42	134	77	LKT3672-42ART	\$2,089	\$2,120	\$2,580	\$2,612
36	66	42	125	72	LKT3666-42ART	\$2,006	\$2,037	\$2,491	\$2,523
36	60	42	116	66	LKT3660-42ART	\$1,952	\$1,978	\$2,432	\$2,460

LAMINATE

Features:

- price reflects complete table - top and base
- ships KD in multiple cartons
- model includes adjustable glide

Options:

- specify power/charging option, see below for options and upcharges

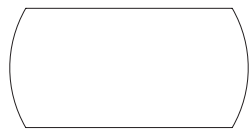

top shape

LOK - TEAMWORK

To Order Specify

① Laminate Model #	② Edge Detail	③ Laminate Selection	④ PVC Edge Color	⑤ Electrical
Laminate (LKT)	See Edge Detail Options	See Laminate Selection	See PVC Edge Color Options	N None CT2 Dual Power Center Top (See chart on next page) CU1 Single Power Underside ⑤ Metal Finish See Metal Finish Color Options

Model Number Breakdown

LKT4872-42ART					
LK	T	4872	42	AR	T
LOK	Laminate	48" x 72"	Height	Arc Rectangular Top Shape	T base

Description

Arc Rectangular Table with T Base at Bar Height
(continued)

Veneer Tables
"LKV" Models

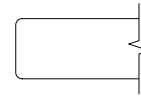

Eased Edge (R3)

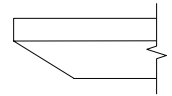

Reverse Bevel Edge (K9)

VENEER	D	W	H	CTN WT	CU FT	① Model	Essentials	Artisan	Essentials	Artisan
		48	72	42	155	101	LKV4872-42ART	\$2,888	\$3,117	\$3,146
	42	72	42	143	89	LKV4272-42ART	\$2,777	\$2,999	\$3,028	\$3,223
	36	72	42	134	77	LKV3672-42ART	\$2,667	\$2,880	\$2,906	\$3,097
	36	66	42	125	72	LKV3666-42ART	\$2,580	\$2,786	\$2,811	\$2,995
	36	60	42	116	66	LKV3660-42ART	\$2,244	\$2,391	\$2,460	\$2,594

LOK - TEAMWORK

Electrical Options and Upcharges

CT2	
Dual Power Center Top - Black	CT2BL - add \$1,481
Dual Power Center Top - White	CT2WH - add \$1,481
CU1	
Single Power Underside - Black	CU11C - add \$576
Single Power Underside with Wireless Charging - Black	CU11CW - add \$1,379

Note: Order power infeed that best fits application

To Order, Specify:

① Veneer Model #	② Edge Detail	③ Wood Collection	④ Top Wood Finish	⑤ Electrical	⑥ Metal Color
Veneer (LKV)	See Edge Detail Options	Essentials	See Essentials Top Wood Finish Options	N None CT2 Dual Power Center Top CU1 Single Power Underside (See chart above)	See Metal Finish Color Options
		Artisan	④ Top Wood Finish See Artisan Top Wood Finish Options		

Description

Rounded Arc Rectangular Table with T Base at Bar Height

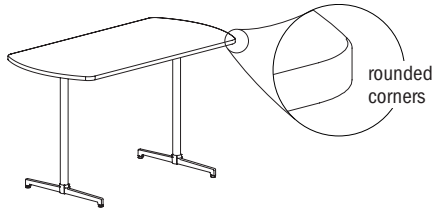

Laminate Tables
"LKT" Models

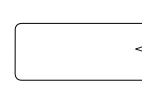

Eased Edge (R3)

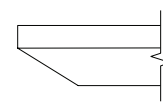

Reverse Bevel Edge (K9)

D	W	H	CTN WT	CU FT	① Model	Eased Edge (R3)		Reverse Bevel Edge (K9)	
						Standard Tier 1	Graded In Tier 2	Standard Tier 1	Graded In Tier 2
48	72	42	155	101	LKT4872-42ARRT	\$2,295	\$2,340	\$2,804	\$2,848
42	72	42	143	89	LKT4272-42ARRT	\$2,191	\$2,230	\$2,691	\$2,730
36	72	42	134	77	LKT3672-42ARRT	\$2,089	\$2,120	\$2,580	\$2,612
36	66	42	125	72	LKT3666-42ARRT	\$2,006	\$2,037	\$2,491	\$2,523
36	60	42	116	66	LKT3660-42ARRT	\$1,952	\$1,978	\$2,432	\$2,460

LAMINATE

Features:

- price reflects complete table - top and base
- ships KD in multiple cartons
- model includes adjustable glide

Options:

- specify power/charging option, see below for options and upcharges



top shape

LOK - TEAMWORK

To Order Specify

① Laminate Model #	② Edge Detail	③ Laminate Selection	④ PVC Edge Color	⑤ Electrical
Laminate (LKT)	See Edge Detail Options	See Laminate Selection	See PVC Edge Color Options	N None CT2 Dual Power Center Top (See chart on next page) CU1 Single Power Underside ⑤ Metal Finish See Metal Finish Color Options

Model Number Breakdown

LKT4872-42ARRT						
LK	T	4872	42	AR	R	T
LOK	Laminate	48" x 72"	Height	Arc Rectangular Top Shape	Rounded Corner	T base

Description

Rounded Arc Rectangular Table with T Base at Bar Height (continued)

Veneer Tables "LKV" Models

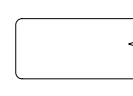

Eased Edge (R3)

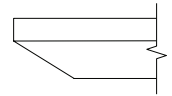

Reverse Bevel Edge (K9)

D	W	H	CTN WT	CU FT	Model	Eased Edge (R3)		Reverse Bevel Edge (K9)	
						Essentials	Artisan	Essentials	Artisan
48	72	42	155	101	LKV4872-42ARRT	\$2,607	\$2,836	\$2,857	\$3,066
42	72	42	143	89	LKV4272-42ARRT	\$2,499	\$2,700	\$2,735	\$2,922
36	72	42	134	77	LKV3672-42ARRT	\$2,388	\$2,562	\$2,614	\$2,773
36	66	42	125	72	LKV3666-42ARRT	\$2,300	\$2,461	\$2,522	\$2,668
36	60	42	116	66	LKV3660-42ARRT	\$2,244	\$2,391	\$2,460	\$2,594

VENEER

LOK - TEAMWORK

Electrical Options and Upcharges

CT2	
Dual Power Center Top - Black	CT2BL - add \$1,481
Dual Power Center Top - White	CT2WH - add \$1,481
CU1	
Single Power Underside - Black	CU11C - add \$576
Single Power Underside with Wireless Charging - Black	CU11CW - add \$1,379

Note: Order power infeed that best fits application

To Order, Specify:

1 Veneer Model #	2 Edge Detail	3 Wood Collection	4 Top Wood Finish	5 Electrical	6 Metal Color
Veneer (LKV)	See Edge Detail Options	Essentials	See Essentials Top Wood Finish Options	N None CT2 Dual Power Center Top CU1 Single Power Underside (See chart above)	See Metal Finish Color Options
		Artisan	4 Top Wood Finish See Artisan Top Wood Finish Options		

Description

Racetrack Table with T Base at Bar Height



Laminate Tables
"LKT" Models

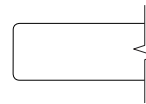

Eased Edge (R3)

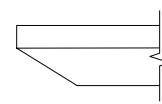

Reverse Bevel Edge (K9)

LAMINATE	D	W	H	CTN WT	CU FT	1 Model	Standard Tier 1	Graded In Tier 2	Standard Tier 1	Graded In Tier 2
		42	72	42	136	89	LKT4272-42RKT	\$2,191	\$2,230	\$2,691
	36	72	42	129	77	LKT3672-42RKT	\$2,089	\$2,120	\$2,580	\$2,612
	36	66	42	120	72	LKT3666-42RKT	\$2,006	\$2,037	\$2,491	\$2,523
	36	60	42	110	66	LKT3660-42RKT	\$1,952	\$1,978	\$2,432	\$2,460

Features:

- price reflects complete table - top and base
- ships KD in multiple cartons
- model includes adjustable glide

Options:

- specify power/charging option, see below for options and upcharges



top shape

LOK - TEAMWORK

To Order Specify

1 Laminate Model #	2 Edge Detail	3 Laminate Selection	3a PVC Edge Color	4 Electrical
Laminate (LKT)	See Edge Detail Options	See Laminate Selection	See PVC Edge Color Options	N None CT2 Dual Power Center Top (See chart on next page) CU1 Single Power Underside 5 Metal Finish See Metal Finish Color Options

Model Number Breakdown

LKT4872-42RKT					
LK	T	4872	42	RK	T
LOK	Laminate	48" x 72"	Height	Racetrack Top Shape	T base

Description

Racetrack Table with
T Base at Bar Height
(continued)

Veneer Tables
"LKV" Models

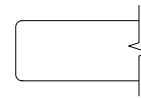

Eased Edge (R3)

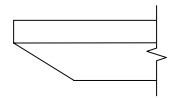

Reverse Bevel Edge (K9)

VENEER	D	W	H	CTN WT	CU FT	① Model	Essentials	Artisan	Essentials	Artisan
		48	72	42	147	101	LKV4872-42RKT	\$2,888	\$3,117	\$3,146
	36	72	42	129	77	LKV3672-42RKT	\$2,667	\$2,880	\$2,906	\$3,097
	36	66	42	120	72	LKV3666-42RKT	\$2,580	\$2,786	\$2,811	\$2,995
	36	60	42	110	66	LKV3660-42RKT	\$2,524	\$2,726	\$2,752	\$2,929

LOK - TEAMWORK

Electrical Options and Upcharges

CT2	
Dual Power Center Top - Black	CT2BL - add \$1,481
Dual Power Center Top - White	CT2WH - add \$1,481
CU1	
Single Power Underside - Black	CU11C - add \$576
Single Power Underside with Wireless Charging - Black	CU11CW - add \$1,379

Note: Order power infeed that best fits application

To Order, Specify:

① Veneer Model #	② Edge Detail	③ Wood Collection	④ Top Wood Finish	⑤ Electrical	⑥ Metal Color
Veneer (LKV)	See Edge Detail Options	Essentials	See Essentials Top Wood Finish Options	N None CT2 Dual Power Center Top CU1 Single Power Underside (See chart above)	See Metal Finish Color Options
		Artisan	④ Top Wood Finish See Artisan Top Wood Finish Options		

Description

Oval Table with T Base at Bar Height



Laminate Tables "LKT" Models

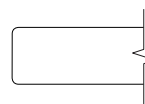

Eased Edge (R3)

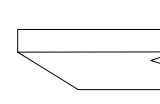

Reverse Bevel Edge (K9)

LAMI	D	W	H	CTN WT	CU FT	Model	Standard Tier 1	Graded In Tier 2	Standard Tier 1	Graded In Tier 2
		36	72	42	119	77	LKT3672-420VT	\$2,089	\$2,120	\$2,580

Features:

- price reflects complete table - top and base
- ships KD in multiple cartons
- model includes adjustable glide

Options:

- specify power/charging option, see below for options and upcharges

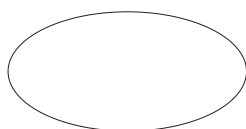

top shape

LOK - TEAMWORK

To Order Specify

1 Laminate Model #	2 Edge Detail	3 Laminate Selection	3a PVC Edge Color	4 Electrical
Laminate (LKT)	See Edge Detail Options	See Laminate Selection	See PVC Edge Color Options	N None CT2 Dual Power Center Top (See chart on next page) CU1 Single Power Underside 5 Metal Finish See Metal Finish Color Options

Model Number Breakdown

LKT4272-42RKT					
LK	T	4272	42	OV	T
LOK	Laminate	42" x 72"	Height	Oval Top Shape	T base

Description

Oval Table with T Base at Bar Height (continued)

Veneer Tables "LKV" Models

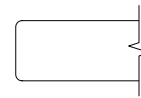

Eased Edge (R3)

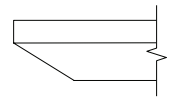

Reverse Bevel Edge (K9)

VEN.	D	W	H	CTN WT	CU FT	① Model	Eased Edge (R3)		Reverse Bevel Edge (K9)	
							Essentials	Artisan	Essentials	Artisan
	36	72	42	119	77	LKV3672-42OVT	\$2,646	\$2,858	\$2,884	\$3,072

LOK - TEAMWORK

Electrical Options and Upcharges

CT2	
Dual Power Center Top - Black	CT2BL - add \$1,481
Dual Power Center Top - White	CT2WH - add \$1,481
CU1	
Single Power Underside - Black	CU11C - add \$576
Single Power Underside with Wireless Charging - Black	CU11CW - add \$1,379

Note: Order power infeed that best fits application

To Order, Specify:

① Veneer Model #	② Edge Detail	③ Wood Collection	④ Top Wood Finish	⑤ Electrical	⑥ Metal Color
Veneer (LKV)	See Edge Detail Options	Essentials	See Essentials Top Wood Finish Options	N None CT2 Dual Power Center Top CU1 Single Power Underside (See chart above)	See Metal Finish Color Options
		Artisan	④ Top Wood Finish See Artisan Top Wood Finish Options		

Description

Boat Table with T Base
at Bar Height

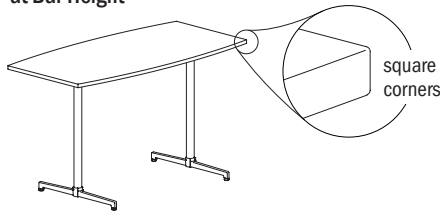

Laminate Tables
"LKT" Models

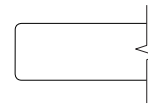

Eased Edge (R3)

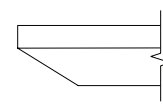

Reverse Bevel Edge (K9)

D	W	H	CTN WT	CU FT	Model	Eased Edge (R3)		Reverse Bevel Edge (K9)	
						Standard Tier 1	Graded In Tier 2	Standard Tier 1	Graded In Tier 2
48	72	42	159	101	LKT4872-42BTT	\$2,295	\$2,340	\$2,804	\$2,848
42	72	42	144	89	LKT4272-42BTT	\$2,191	\$2,230	\$2,691	\$2,730
36	72	42	133	77	LKT3672-42BTT	\$2,089	\$2,120	\$2,580	\$2,612
36	66	42	125	72	LKT3666-42BTT	\$2,006	\$2,037	\$2,491	\$2,523
36	60	42	117	66	LKT3660-42BTT	\$1,952	\$1,978	\$2,432	\$2,460

LAMINATE

Features:

- price reflects complete table - top and base
- ships KD in multiple cartons
- model includes adjustable glide

Options:

- specify power/charging option, see below for options and upcharges



top shape

LOK - TEAMWORK

To Order Specify

1 Laminate Model #	2 Edge Detail	3 Laminate Selection	3a PVC Edge Color	4 Electrical
Laminate (LKT)	See Edge Detail Options	See Laminate Selection	See PVC Edge Color Options	N None CT2 Dual Power Center Top (See chart on next page) CU1 Single Power Underside 5 Metal Finish See Metal Finish Color Options

Model Number Breakdown

LKT4872-42BTT					
LK	T	4872	42	BT	T
LOK	Laminate	48" x 72"	Height	Boat Top Shape	T base

Description

Boat Table with T Base
at Bar Height
(continued)

Veneer Tables
"LKV" Models

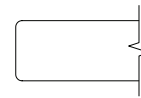

Eased Edge (R3)

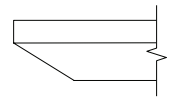

Reverse Bevel Edge (K9)

VENEER	D	W	H	CTN WT	CU FT	① Model	Essentials	Artisan	Essentials	Artisan
		48	72	42	159	101	LKV4872-42BTT	\$2,888	\$3,117	\$3,146
	42	72	42	144	89	LKV4272-42BTT	\$2,777	\$2,999	\$3,028	\$3,223
	36	72	42	133	77	LKV3672-42BTT	\$2,667	\$2,880	\$2,906	\$3,097
	36	66	42	125	72	LKV3666-42BTT	\$2,580	\$2,786	\$2,811	\$2,995
	36	60	42	117	66	LKV3660-42BTT	\$2,524	\$2,726	\$2,752	\$2,929

LOK - TEAMWORK

Electrical Options and Upcharges

CT2	
Dual Power Center Top - Black	CT2BL - add \$1,481
Dual Power Center Top - White	CT2WH - add \$1,481
CU1	
Single Power Underside - Black	CU11C - add \$576
Single Power Underside with Wireless Charging - Black	CU11CW - add \$1,379

Note: Order power infeed that best fits application

To Order, Specify:

① Veneer Model #	② Edge Detail	③ Wood Collection	④ Top Wood Finish	⑤ Electrical	⑥ Metal Color
Veneer (LKV)	See Edge Detail Options	Essentials	See Essentials Top Wood Finish Options	N None CT2 Dual Power Center Top CU1 Single Power Underside (See chart above)	See Metal Finish Color Options
		Artisan	④ Top Wood Finish See Artisan Top Wood Finish Options		

Description

Rounded Boat Table with T Base at Bar Height

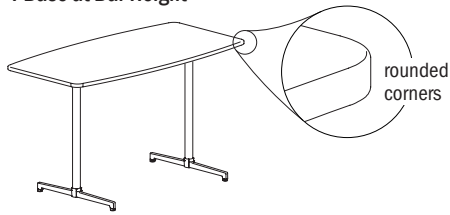

Laminate Tables "LKT" Models

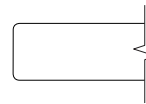

Eased Edge (R3)

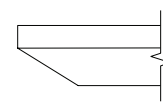

Reverse Bevel Edge (K9)

D	W	H	CTN WT	CU FT	Model	Eased Edge (R3)		Reverse Bevel Edge (K9)	
						Standard Tier 1	Graded In Tier 2	Standard Tier 1	Graded In Tier 2
48	72	42	159	101	LKT4872-42BTRT	\$2,295	\$2,340	\$2,804	\$2,848
42	72	42	144	89	LKT4272-42BTRT	\$2,191	\$2,230	\$2,691	\$2,730
36	72	42	133	77	LKT3672-42BTRT	\$2,089	\$2,120	\$2,580	\$2,612
36	66	42	125	72	LKT3666-42BTRT	\$2,006	\$2,037	\$2,491	\$2,523
36	60	42	117	66	LKT3660-42BTRT	\$1,952	\$1,978	\$2,432	\$2,460

Features:

- price reflects complete table - top and base
- ships KD in multiple cartons
- model includes adjustable glide

Options:

- specify power/charging option, see below for options and upcharges



top shape

LOK - TEAMWORK

To Order Specify

1 Laminate Model #	2 Edge Detail	3 Laminate Selection	3a PVC Edge Color	4 Electrical
Laminate (LKT)	See Edge Detail Options	See Laminate Selection	See PVC Edge Color Options	N None CT2 Dual Power Center Top (See chart on next page) CU1 Single Power Underside 5 Metal Finish See Metal Finish Color Options

Model Number Breakdown

LKT4872-42BTRT						
LK	T	4872	42	BT	R	T
LOK	Laminate	48" x 72"	Height	Boat Top Shape	Rounded Corner	T base

Description

Rounded Boat Table with T Base at Bar Height (continued)

Veneer Tables "LKV" Models

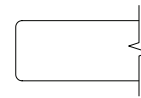

Eased Edge (R3)

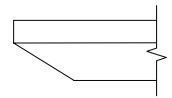

Reverse Bevel Edge (K9)

VENEER	D	W	H	CTN WT	CU FT	Model	Essentials	Artisan	Essentials	Artisan
		48	72	42	159	101	LKV4872-42BTRT	\$2,888	\$3,117	\$3,146
	42	72	42	144	89	LKV4272-42BTRT	\$2,777	\$2,999	\$3,028	\$3,223
	36	72	42	133	77	LKV3672-42BTRT	\$2,667	\$2,880	\$2,906	\$3,097
	36	66	42	125	72	LKV3666-42BTRT	\$2,580	\$2,786	\$2,811	\$2,995
	36	60	42	117	66	LKV3660-42BTRT	\$2,524	\$2,726	\$2,752	\$2,929

LOK - TEAMWORK

Electrical Options and Upcharges

CT2	
Dual Power Center Top - Black	CT2BL - add \$1,481
Dual Power Center Top - White	CT2WH - add \$1,481
CU1	
Single Power Underside - Black	CU11C - add \$576
Single Power Underside with Wireless Charging - Black	CU11CW - add \$1,379

Note: Order power infeed that best fits application

To Order, Specify:

1 Veneer Model #	2 Edge Detail	3 Wood Collection	4 Top Wood Finish	5 Electrical	6 Metal Color
Veneer (LKV)	See Edge Detail Options	Essentials	See Essentials Top Wood Finish Options	N None CT2 Dual Power Center Top CU1 Single Power Underside (See chart above)	See Metal Finish Color Options
		Artisan	4 Top Wood Finish See Artisan Top Wood Finish Options		

Description

Rounded Double Chevron Table with T Base at Bar Height

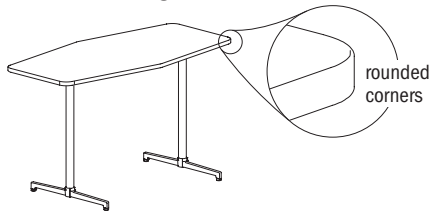

Laminate Tables "LKT" Models

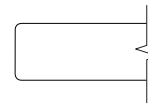

Eased Edge (R3)

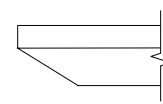

Reverse Bevel Edge (K9)

LAMINATE

D	W	H	CTN WT	CU FT	Model	Eased Edge (R3)		Reverse Bevel Edge (K9)	
						Standard Tier 1	Graded In Tier 2	Standard Tier 1	Graded In Tier 2
48	72	42	153	101	LKT4872-42DCRT	\$2,295	\$2,340	\$2,804	\$2,848
48	60	42	135	85	LKT4860-42DCRT	\$2,126	\$2,163	\$2,622	\$2,659
42	72	42	137	89	LKT4272-42DCRT	\$2,191	\$2,230	\$2,691	\$2,730
42	60	42	121	75	LKT4260-42DCRT	\$2,039	\$2,069	\$2,527	\$2,558
36	72	42	125	77	LKT3672-42DCRT	\$2,089	\$2,120	\$2,580	\$2,612
36	60	42	111	66	LKT3660-42DCRT	\$1,952	\$1,978	\$2,432	\$2,460

Features:

- price reflects complete table - top and base
- ships KD in multiple cartons
- model includes adjustable glide

Options:

- specify power/charging option, see below for options and upcharges

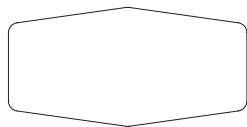

top shape

LOK - TEAMWORK

To Order Specify

1 Laminate Model #	2 Edge Detail	3 Laminate Selection	3a PVC Edge Color	4 Electrical
Laminate (LKT)	See Edge Detail Options	See Laminate Selection	See PVC Edge Color Options	N None CT2 Dual Power Center Top (See chart on next page) CU1 Single Power Underside 5 Metal Finish See Metal Finish Color Options

Model Number Breakdown

LKT4872-42DCRT						
LK	T	4872	42	DC	R	T
LOK	Laminate	48" x 72"	Height	Double Chevron Top Shape	Rounded Corner	T base

Description

Rounded Double Chevron Table with
T Base at Bar Height
(continued)

Veneer Tables
"LKV" Models

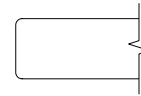

Eased Edge (R3)

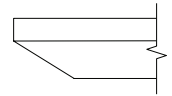

Reverse Bevel Edge (K9)

D	W	H	CTN WT	CU FT	① Model	Eased Edge (R3)		Reverse Bevel Edge (K9)	
						Essentials	Artisan	Essentials	Artisan
48	72	42	153	101	LKV4872-42DCRT	\$2,888	\$3,117	\$3,146	\$3,350
48	60	42	135	85	LKV4860-42DCRT	\$2,708	\$2,926	\$2,950	\$3,144
42	72	42	137	89	LKV4272-42DCRT	\$2,777	\$2,999	\$3,028	\$3,223
42	60	42	121	75	LKV4260-42DCRT	\$2,616	\$2,825	\$2,854	\$3,037
36	72	42	125	77	LKV3672-42DCRT	\$2,727	\$2,944	\$2,972	\$3,165
36	60	42	111	66	LKV3660-42DCRT	\$2,546	\$2,750	\$2,774	\$2,952

VENEER

LOK - TEAMWORK

Electrical Options and Upcharges

CT2	
Dual Power Center Top - Black	CT2BL - add \$1,481
Dual Power Center Top - White	CT2WH - add \$1,481
CU1	
Single Power Underside - Black	CU11C - add \$576
Single Power Underside with Wireless Charging - Black	CU11CW - add \$1,379

Note: Order power infeed that best fits application

To Order, Specify:

① Veneer Model #	② Edge Detail	③ Wood Collection	④ Top Wood Finish	⑤ Electrical	⑥ Metal Color
Veneer (LKV)	See Edge Detail Options	Essentials	See Essentials Top Wood Finish Options	N None CT2 Dual Power Center Top CU1 Single Power Underside (See chart above)	See Metal Finish Color Options
		Artisan	④ Top Wood Finish See Artisan Top Wood Finish Options		

Description

Taper Table with T Base at Bar Height

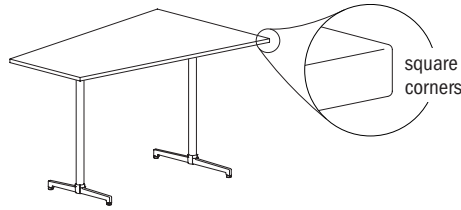

Laminate Tables "LKT" Models

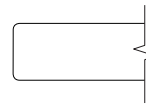

Eased Edge (R3)

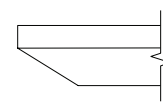

Reverse Bevel Edge (K9)

LAMI	D	W	H	CTN WT	CU FT	Model	Standard Tier 1	Graded In Tier 2	Standard Tier 1	Graded In Tier 2
		48	72	42	140	101	LKT4872-42TPT	\$2,307	\$2,349	\$2,817

Features:

- price reflects complete table - top and base
- ships KD in multiple cartons
- model includes adjustable glide

Options:

- specify power/charging option, see below for options and upcharges

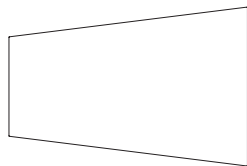

top shape

LOK - TEAMWORK

To Order Specify

1 Laminate Model #	2 Edge Detail	3 Laminate Selection	3a PVC Edge Color	4 Electrical
Laminate (LKT)	See Edge Detail Options	See Laminate Selection	See PVC Edge Color Options	N None CT2 Dual Power Center Top (See chart on next page) CU1 Single Power Underside 5 Metal Finish See Metal Finish Color Options

Model Number Breakdown

LKT4872-42TPT					
LK	T	4872	42	TP	T
LOK	Laminate	48" x 72"	Height	Taper Top Shape	T base

Description

Taper Table with T Base
at Bar Height
(continued)

Veneer Tables
"LKV" Models

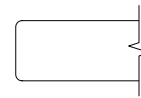

Eased Edge (R3)

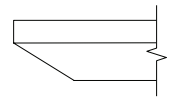

Reverse Bevel Edge (K9)

VEN.	D	W	H	CTN WT	CU FT	① Model	Essentials		Artisan	
							Essentials	Artisan	Essentials	Artisan
	48	72	42	140	101	LKV4872-42TPT	\$2,898	\$3,129	\$3,156	\$3,363

LOK - TEAMWORK

Electrical Options and Upcharges

CT2	
Dual Power Center Top - Black	CT2BL - add \$1,481
Dual Power Center Top - White	CT2WH - add \$1,481
CU1	
Single Power Underside - Black	CU11C - add \$576
Single Power Underside with Wireless Charging - Black	CU11CW - add \$1,379

Note: Order power infeed that best fits application

To Order, Specify:

① Veneer Model #	② Edge Detail	③ Wood Collection	④ Top Wood Finish	⑤ Electrical	⑥ Metal Color
Veneer (LKV)	See Edge Detail Options	Essentials	See Essentials Top Wood Finish Options	N None CT2 Dual Power Center Top CU1 Single Power Underside (See chart above)	See Metal Finish Color Options
		Artisan	④ Top Wood Finish See Artisan Top Wood Finish Options		

Description

Rounded Taper Table with T Base at Bar Height

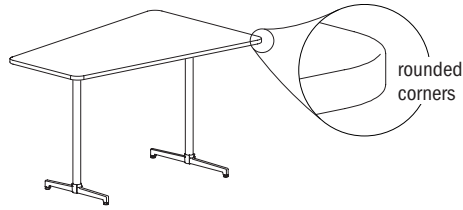

Laminate Tables "LKT" Models

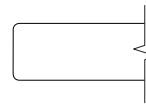

Eased Edge (R3)

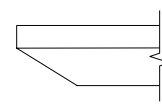

Reverse Bevel Edge (K9)

LAMI	D	W	H	CTN WT	CU FT	Model	Standard Tier 1	Graded In Tier 2	Standard Tier 1	Graded In Tier 2
		48	72	42	140	101	LKT4872-42TPRT	\$2,307	\$2,349	\$2,817

Features:

- price reflects complete table - top and base
- ships KD in multiple cartons
- model includes adjustable glide

Options:

- specify power/charging option, see below for options and upcharges

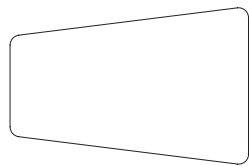

top shape

LOK - TEAMWORK

To Order Specify

1 Laminate Model #	2 Edge Detail	3 Laminate Selection	3a PVC Edge Color	4 Electrical
Laminate (LKT)	See Edge Detail Options	See Laminate Selection	See PVC Edge Color Options	N None CT2 Dual Power Center Top (See chart on next page) CU1 Single Power Underside 5 Metal Finish See Metal Finish Color Options

Model Number Breakdown

LKT4872-42TPRT						
LK	T	4872	42	TP	R	T
LOK	Laminate	48" x 72"	Height	Taper Top Shape	Rounded Corner	T base

Description

Rounded Taper Table with T Base
at Bar Height
(continued)

Veneer Tables
"LKV" Models

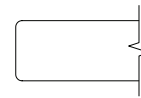

Eased Edge (R3)

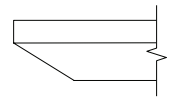

Reverse Bevel Edge (K9)

VEN.	D	W	H	CTN WT	CU FT	① Model	Essentials		Artisan	
							Essentials	Artisan	Essentials	Artisan
	48	72	42	140	101	LKV4872-42TPRT	\$2,898	\$3,129	\$3,156	\$3,363

LOK - TEAMWORK

Electrical Options and Upcharges

CT2	
Dual Power Center Top - Black	CT2BL - add \$1,481
Dual Power Center Top - White	CT2WH - add \$1,481
CU1	
Single Power Underside - Black	CU11C - add \$576
Single Power Underside with Wireless Charging - Black	CU11CW - add \$1,379

Note: Order power infeed that best fits application

To Order, Specify:

① Veneer Model #	② Edge Detail	③ Wood Collection	④ Top Wood Finish	⑤ Electrical	⑥ Metal Color
Veneer (LKV)	See Edge Detail Options	Essentials	See Essentials Top Wood Finish Options	N None CT2 Dual Power Center Top CU1 Single Power Underside (See chart above)	See Metal Finish Color Options
		Artisan	④ Top Wood Finish See Artisan Top Wood Finish Options		

Description

Bullet Table with T Base at Bar Height

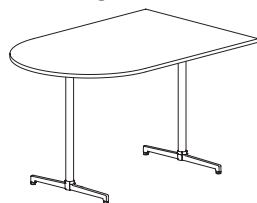

Laminate Tables "LKT" Models

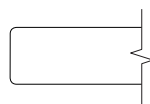

Eased Edge (R3)

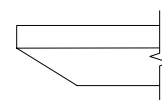

Reverse Bevel Edge (K9)

LAMI	D	W	H	CTN WT	CU FT	Model	Standard Tier 1	Graded In Tier 2	Standard Tier 1	Graded In Tier 2
		48	72	42	156	101	LKT4872-42BUT	\$2,295	\$2,340	\$2,804

Features:

- price reflects complete table - top and base
- ships KD in multiple cartons
- model includes adjustable glide

Options:

- specify power/charging option, see below for options and upcharges

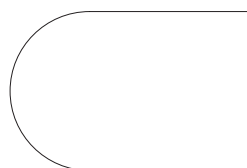

top shape

LOK - TEAMWORK

To Order Specify

1 Laminate Model #	2 Edge Detail	3 Laminate Selection	3a PVC Edge Color	4 Electrical
Laminate (LKT)	See Edge Detail Options	See Laminate Selection	See PVC Edge Color Options	N None CT2 Dual Power Center Top (See chart on next page) CU1 Single Power Underside 5 Metal Finish See Metal Finish Color Options

Model Number Breakdown

LKT4872-42BUT					
LK	T	4872	42	BU	T
LOK	Laminate	48" x 72"	Height	Bullet Top Shape	T base

Description

Bullet Table with T Base
at Bar Height
(continued)

Veneer Tables
"LKV" Models

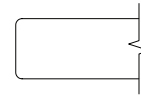

Eased Edge (R3)

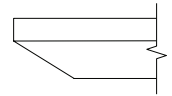

Reverse Bevel Edge (K9)

VEN.	D	W	H	CTN WT	CU FT	① Model	Essentials		Artisan	
	48	72	42	156	101	LKV4872-42BUT	\$2,888		\$3,117	
									\$3,146	\$3,350

LOK - TEAMWORK

Electrical Options and Upcharges

CT2	
Dual Power Center Top - Black	CT2BL - add \$1,481
Dual Power Center Top - White	CT2WH - add \$1,481
CU1	
Single Power Underside - Black	CU11C - add \$576
Single Power Underside with Wireless Charging - Black	CU11CW - add \$1,379

Note: Order power infeed that best fits application

To Order, Specify:

① Veneer Model #	② Edge Detail	③ Wood Collection	④ Top Wood Finish	⑤ Electrical	⑥ Metal Color
Veneer (LKV)	See Edge Detail Options	Essentials	See Essentials Top Wood Finish Options	N None CT2 Dual Power Center Top CU1 Single Power Underside (See chart above)	See Metal Finish Color Options
		Artisan	④ Top Wood Finish See Artisan Top Wood Finish Options		

Description

Hive Table with T Base at Bar Height

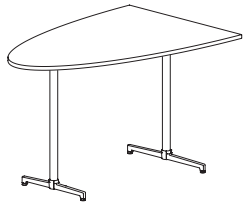

Laminate Tables "LKT" Models

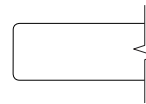

Eased Edge (R3)

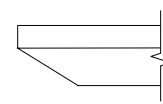

Reverse Bevel Edge (K9)

LAMI	D	W	H	CTN WT	CU FT	Model	Standard Tier 1	Graded In Tier 2	Standard Tier 1	Graded In Tier 2
		48	72	42	138	101	LKT4872-42HVT	\$2,295	\$2,340	\$2,804

Features:

- price reflects complete table - top and base
- ships KD in multiple cartons
- model includes adjustable glide

Options:

- specify power/charging option, see below for options and upcharges

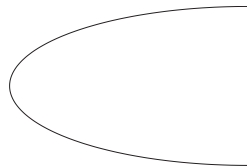

top shape

LOK - TEAMWORK

To Order Specify

1 Laminate Model #	2 Edge Detail	3 Laminate Selection	3a PVC Edge Color	4 Electrical
Laminate (LKT)	See Edge Detail Options	See Laminate Selection	See PVC Edge Color Options	N None CT2 Dual Power Center Top (See chart on next page) CU1 Single Power Underside 5 Metal Finish See Metal Finish Color Options

Model Number Breakdown

LKT4872-42HVT					
LK	T	4872	42	HV	T
LOK	Laminate	48" x 72"	Height	Hive Top Shape	T base

Description

Hive Table with T Base
at Bar Height
(continued)

Veneer Tables
"LKV" Models

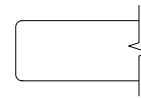

Eased Edge (R3)

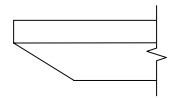

Reverse Bevel Edge (K9)

VEN.	D	W	H	CTN WT	CU FT	① Model	Essentials		Artisan	
							Essentials	Artisan	Essentials	Artisan
	48	72	42	138	101	LKV4872-42HVT	\$2,888	\$3,117	\$3,146	\$3,350

LOK - TEAMWORK

Electrical Options and Upcharges

CT2	
Dual Power Center Top - Black	CT2BL - add \$1,481
Dual Power Center Top - White	CT2WH - add \$1,481
CU1	
Single Power Underside - Black	CU11C - add \$576
Single Power Underside with Wireless Charging - Black	CU11CW - add \$1,379

Note: Order power infeed that best fits application

To Order, Specify:

① Veneer Model #	② Edge Detail	③ Wood Collection	④ Top Wood Finish	⑤ Electrical	⑥ Metal Color
Veneer (LKV)	See Edge Detail Options	Essentials	See Essentials Top Wood Finish Options	N None CT2 Dual Power Center Top CU1 Single Power Underside (See chart above)	See Metal Finish Color Options
		Artisan	④ Top Wood Finish See Artisan Top Wood Finish Options		

Description

Wedge Table with T Base
at Bar Height

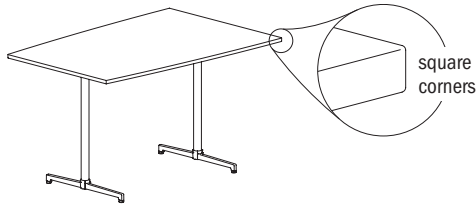

Laminate Tables
"LKT" Models

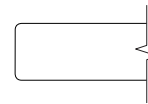

Eased Edge (R3)

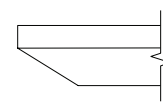

Reverse Bevel Edge (K9)

LAMI	D	W	H	CTN WT	CU FT	1 Model	Standard Tier 1	Graded In Tier 2	Standard Tier 1	Graded In Tier 2
		48	72	42	160	101	LKT4872-42WDT	\$2,295	\$2,340	\$2,804

Features:

- price reflects complete table - top and base
- ships KD in multiple cartons
- model includes adjustable glide

Options:

- specify power/charging option, see below for options and upcharges

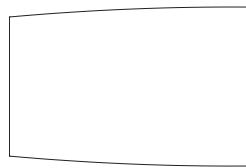

top shape

LOK - TEAMWORK

To Order Specify

1 Laminate Model #	2 Edge Detail	3 Laminate Selection	3a PVC Edge Color	4 Electrical
Laminate (LKT)	See Edge Detail Options	See Laminate Selection	See PVC Edge Color Options	N None CT2 Dual Power Center Top (See chart on next page) CU1 Single Power Underside 5 Metal Finish See Metal Finish Color Options

Model Number Breakdown

LKT4872-42WDT					
LK	T	4872	42	WD	T
LOK	Laminate	48" x 72"	Height	Wedge Top Shape	T base

Description

Wedge Table with T Base
at Bar Height
(continued)

Veneer Tables
"LKV" Models

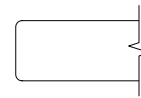

Eased Edge (R3)

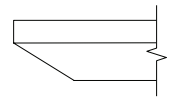

Reverse Bevel Edge (K9)

VEN.	D	W	H	CTN WT	CU FT	① Model	Eased Edge (R3)		Reverse Bevel Edge (K9)	
							Essentials	Artisan	Essentials	Artisan
	48	72	42	160	101	LKV4872-42WDT	\$2,888	\$3,117	\$3,146	\$3,350

LOK - TEAMWORK

Electrical Options and Upcharges

CT2	
Dual Power Center Top - Black	CT2BL - add \$1,481
Dual Power Center Top - White	CT2WH - add \$1,481
CU1	
Single Power Underside - Black	CU11C - add \$576
Single Power Underside with Wireless Charging - Black	CU11CW - add \$1,379

Note: Order power infeed that best fits application

To Order, Specify:

① Veneer Model #	② Edge Detail	③ Wood Collection	④ Top Wood Finish	⑤ Electrical	⑥ Metal Color
Veneer (LKV)	See Edge Detail Options	Essentials	See Essentials Top Wood Finish Options	N None CT2 Dual Power Center Top CU1 Single Power Underside (See chart above)	See Metal Finish Color Options
		Artisan	④ Top Wood Finish See Artisan Top Wood Finish Options		

Description

Rounded Wedge Table with T Base at Bar Height

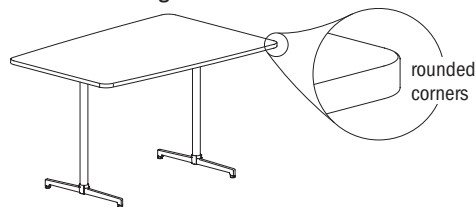

Laminate Tables "LKT" Models

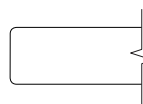

Eased Edge (R3)

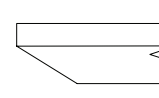

Reverse Bevel Edge (K9)

LAMI	D	W	H	CTN WT	CU FT	Model	Standard Tier 1	Graded In Tier 2	Standard Tier 1	Graded In Tier 2
		48	72	42	160	101	LKT4872-42WDRT	\$2,295	\$2,340	\$2,804

Features:

- price reflects complete table - top and base
- ships KD in multiple cartons
- model includes adjustable glide

Options:

- specify power/charging option, see below for options and upcharges



top shape

LOK - TEAMWORK

To Order Specify

1 Laminate Model #	2 Edge Detail	3 Laminate Selection	3a PVC Edge Color	4 Electrical
Laminate (LKT)	See Edge Detail Options	See Laminate Selection	See PVC Edge Color Options	N None CT2 Dual Power Center Top (See chart on next page) CU1 Single Power Underside 5 Metal Finish See Metal Finish Color Options

Model Number Breakdown

LKT4872-42WDRT						
LK	T	4872	42	WD	R	T
LOK	Laminate	48" x 72"	Height	Wedge Top Shape	Rounded Corner	T base

Description

Rounded Wedge Table with
T Base at Bar Height
(continued)

Veneer Tables
"LKV" Models

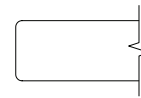

Eased Edge (R3)

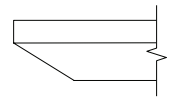

Reverse Bevel Edge (K9)

VEN.	D	W	H	CTN WT	CU FT	① Model	Eased Edge (R3)		Reverse Bevel Edge (K9)	
							Essentials	Artisan	Essentials	Artisan
	48	72	42	160	101	LKV4872-42WDRT	\$2,888	\$3,117	\$3,146	\$3,350

LOK - TEAMWORK

Electrical Options and Upcharges

CT2	
Dual Power Center Top - Black	CT2BL - add \$1,481
Dual Power Center Top - White	CT2WH - add \$1,481
CU1	
Single Power Underside - Black	CU11C - add \$576
Single Power Underside with Wireless Charging - Black	CU11CW - add \$1,379

Note: Order power infeed that best fits application

To Order, Specify:

① Veneer Model #	② Edge Detail	③ Wood Collection	④ Top Wood Finish	⑤ Electrical	⑥ Metal Color
Veneer (LKV)	See Edge Detail Options	Essentials	See Essentials Top Wood Finish Options	N None CT2 Dual Power Center Top CU1 Single Power Underside (See chart above)	See Metal Finish Color Options
		Artisan	④ Top Wood Finish See Artisan Top Wood Finish Options		

Description	D	W	H	CTN WT	CU FT	① Model	List Price
3 Prong Plug - 110 Power Infeed				1	1	AP72	\$332

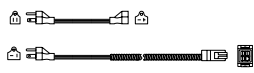

Features:

- 72" plug power infeed
- 20 amps/110 volts max
- 3 prong plug - 15 amp adapter plug included
- single circuit use only

Hardwire Power Infeed				1	1	HP72	\$270
------------------------------	--	--	--	---	---	------	-------



Features:

- 72" hardwire power infeed
- 20 amps/120 volts max
- single or double circuit
- electrical contractor responsible for connection to building power source

Quick Disconnect Power Infeed				1	1	MP72	\$249
--------------------------------------	--	--	--	---	---	------	-------



Features:

- must be used with QD1
- 72" modular power infeed
- 20 amps/120 volts max
- single or double circuit

Quick Disconnect Wall Outlet				1	1	QD1	\$127
-------------------------------------	--	--	--	---	---	-----	-------

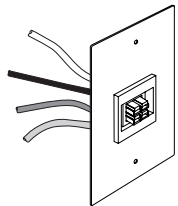

Features:

- must be used with MP72
- works for both single or double circuit
- 20 amps/120 volts max
- electrical contractor responsible for connection to building power source

Vertical Wire Manager	½	2 ¼	33	1	1	AVL33	\$143
	½	2 ¼	25	1	1	AVL25	\$108
	½	2 ¼	22	1	1	AVL20	\$88
	½	2 ¼	17	1	1	AVL17	\$83

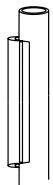

Features:

- field installed
- use AVL33 for 42"h tables with disk base
- use AVL25 for 42"h tables
- use AVL20 for 36"h tables
- use AVL17 for 29"h tables

Options:

- specify plastic color, Black (B) or Silver (S)

Flexible Vertical Wire Manager	1 ½	1 ½	45	4	1	45VWM	\$135
---------------------------------------	-----	-----	----	---	---	-------	-------



Features:

- black plastic
- field installed to bottom of table top, with screws provided
- wire manager is 1 ½" diameter
- weighted base is 4" diameter
- length can be adjusted by removing individual discs as required

Description	D	W	H	CTN WT	CU FT	① Model	List Price
Power Strip	1 ½	1 7/8	8	3	1	GP9ACP1-0212	\$96

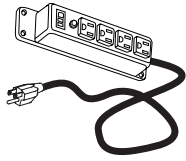

- Features:**
- power surge with 10" cord
 - four electrical outlets
 - includes switch
 - field installed

Wire Management Velcro Straps	1 ¾	3 ½	¼	1	1	04WVS	\$58
--------------------------------------	-----	-----	---	---	---	-------	------

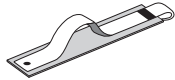

- Features:**
- black, set of 4
 - field installed to bottom of table top, with adhesive tape provided

Cable Management Clips	2 5/8	3 ¾	1 5/8	1	1	0304CMC	\$56
-------------------------------	-------	-----	-------	---	---	---------	------

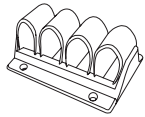

- Features:**
- black plastic
 - installed to bottom of table top
 - four retention loops

Floor Mount Glide	3	2 ¼	½	1	1	LKB516-18ANCHOR	\$43
--------------------------	---	-----	---	---	---	-----------------	------

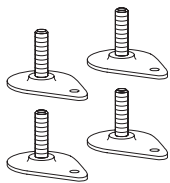

- Features:**
- field installed glides for mounting table base to floor
 - ¼" diameter hole in the glide for mounting
 - set of 4
 - table can be leveled before attached to floor
 - floor attachment hardware provided by installer
 - glide threads 3/8"-16

Single Monitor Arm	4	11	10	9	1	GP5901MA	\$709
---------------------------	---	----	----	---	---	----------	-------

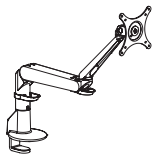

- Features:**
- one-touch reposition monitor adjustment
 - tension adjustment at each joint
 - flat panel mount rotates for portrait or landscape viewing
 - edge mount installation from above surface
 - cable management routes cables below monitor arm
 - specify Black (B) or Silver (S)
 - quick install VESA mount adapter

Wire Management Tray	7 ½	45	3	8	2	GP9WMT1-0845	\$279
	7 ½	35	3	6	1	GP9WMT1-0835	\$235
	7 ½	25	3	4	1	GP9WMT1-0825	\$191

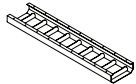

- Features:**
- silver powder-coated finish
 - four hanging brackets (CI2C00)

Wire Manager Trough	2 ½	36	2 ½	4	1	36WCT	\$157
	2 ½	24	2 ½	3	1	24WCT	\$143
	2 ½	12	2 ½	2	1	12WCT	\$123

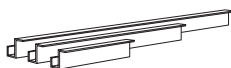

- Features:**
- black plastic
 - field installed to bottom of table top, with screws provided

Accessories/ Keyboard/ Tasklights

For an additional list of electrical units, grommets, keyboards, wire management, monitor arms & telecom jacks, please see our [accessories price list](#)

Contact your customer service representative for specific questions regarding which units can be used with Lok Teamwork.

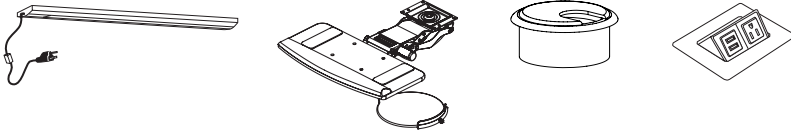

Conference - Table of Contents



Training



Teamwork



Conference



Lounge

Lok - Conference

Product Information

Conference Overview 170
 Tables Shapes & Sizes 176-177
 Laminate Specifications 173
 Veneer Specifications 174
 Solid Surface Specifications 174
 Base Styles - Features 178
 Electrical Planning - Options 179-181

Pricing Pages

Conference Tables at Working Height . 182-295
 Conference Tables at Counter Height . 296-349
 Conference Tables at Bar Height . . . 350-403
 Credenzas 404-407
 Electrical 408-409

Conference - Overview



rectangular
 29"H - Pages 222, 224, 226,
 234, 236, 238
 36"H - Pages 334, 338
 42"H - Pages 386, 390



rounded rectangular
 29"H - Pages 228, 230, 232,
 240, 242, 244
 36"H - Pages 336, 340
 42"H - Pages 388, 392

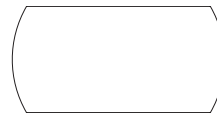

arc rectangular
 29"H - Pages 246, 248, 250
 258, 260, 262
 36"H - Pages 342, 346
 42"H - Pages 394, 398



rounded arc rectangular
 29"H - Pages 252, 254, 256
 264, 266, 268
 36"H - Pages 344, 348
 42"H - Pages 396, 400

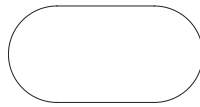

racetrack
 29"H - Pages 270, 272, 274
 36"H - Pages 350
 42"H - Pages 402

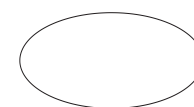

oval
 29"H - Pages 276, 278
 36"H - Pages 352
 42"H - Pages 404

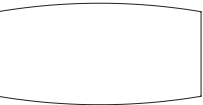

boat
 29"H - Pages 280, 282, 284
 292, 294, 296
 36"H - Pages 354, 356
 42"H - Pages 406, 408

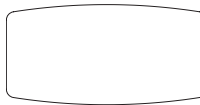

rounded boat
 29"H - Pages 286, 288, 290

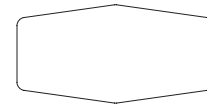

rounded double chevron
 29"H - Pages 298, 300
 36"H - Pages 358, 360
 42"H - Pages 410, 412

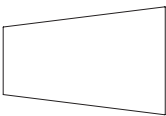

taper
 29"H - Pages 302, 304, 310, 312
 36"H - Pages 362, 366
 42"H - Pages 414, 418

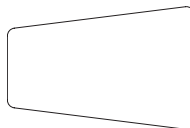

rounded taper
 29"H - Pages 306, 308, 314, 316
 36"H - Pages 364, 368
 42"H - Pages 416, 420

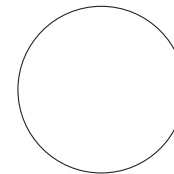

round
 29"H - Pages 318, 320
 36"H - Pages 370, 372
 42"H - Pages 422, 424

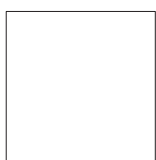

square
 29"H - Pages 322, 326
 36"H - Pages 374, 378
 42"H - Pages 426, 430

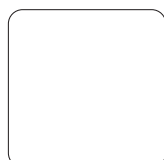

rounded square
 29"H - Pages 324, 328
 36"H - Pages 376, 378
 42"H - Pages 428, 432

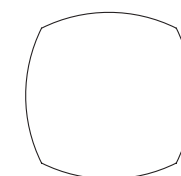

squircle
 29"H - Pages 330, 332
 36"H - Pages 382, 384
 42"H - Pages 434, 436

Conference - Materials

Laminate Tops

Lok conference table worksurfaces are offered in HPL (High Pressure Laminate) The tops are 1 3/16" thick, 3 ply balanced construction. Particle board core and a phenolic backer sheet complete the balanced construction.

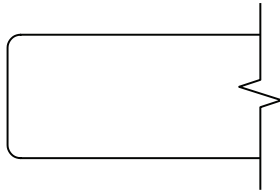

Eased Edge (R3)
PVC

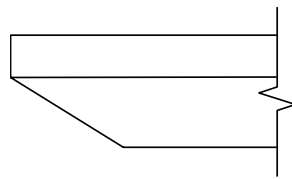

Reverse Bevel (K9)
PVC on painted top of painted MDF

Standard PVC Edge Colors

JSI supports 26 standard PVC edge colors listed below. These coordinate with our Standard (Tier1) Laminates.

When selecting a Standard (Tier 1) Laminate, the coordinating PVC edge color is automatically applied. When selecting a Graded-In Laminate (Tier 2 or 3), you will be prompted to choose one these 26 PVC edge colors to be applied to the edge.

ALB Alabaster	MES Mesa
BEL Belair	MIN Mineral
BLK Black	MCH Mocha
BRK Brickdust	OBK Outback
BBL Bridal Blanco	PIL Pilsner
CSK Cask	PIN Pinnacle Walnut
CLY Clay	SHD Shadow
DWH Designer White	SLG Slate Grey
EGR Egret	UMB Umber
FAW Fawn	VAL Valley
FLN Flint	WAL Walnut Heights
FLO Florence Walnut	WEA Weathered Ash
LOF Loft	ZEN Zen Grey

Standard Laminates

JSI Standard Laminate program consists of 26 solid and wood grain patterns, and establish our Tier 1 laminate pricing. Each has a coordinating PVC edge color that is automatically used with the Standard Laminates.

Wood Grain Laminate

BEL Belair	MIN Mineral
BRK Brickdust	MCH Mocha
CSK Cask	OBK Outback
CLY Clay	PIL Pilsner
EGR Egret	PIN Pinnacle Walnut
FAW Fawn	UMB Umber
FLN Flint	VAL Valley
FLO Florence Walnut	WAL Walnut Heights
LOF Loft	WEA Weathered Ash
MES Mesa	

Solid Laminate

ALB Alabaster
BLK Black
BBL Bridal Blanco
DWH Designer White
SHD Shadow
SLG Slate Grey
ZEN Zen Grey

Conference - Materials

Veneer Tops

Tops are 1 3/8" thick, 5 ply balanced construction with particle board core. Standard Tier 1 veneer is essentials, book matched for cherry, maple, walnut and black oak veneer. Standard Tier 2 veneer is artisan.



Eased Edge (R3)
Internal Lumber Band

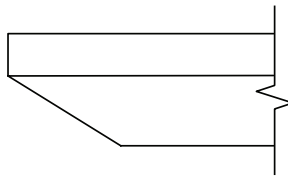

Reverse Bevel (K9)
Veneer Band on Stained MDF

Finish - Stain/Colors

ESS Essentials Veneer Collection

BRK	Brickdust	MIN	Mineral
CSK	Cask	MCH	Mocha
CLY	Clay	OBK	Outback
FAW	Fawn	PIL	Pilsner
FLX	Flax	SIE	Sienna
FLN	Flint	TRF	Truffle
LOF	Loft	UMB	Umber
MES	Mesa	VAL	Valley

ART Artisan Veneer Collection

BAR	Barrel	RAV	Raven
BUF	Buff	RYE	Rye
CND	Cinder	SAB	Sable
EGR	Egret	SAD	Saddle

Protective Top Coat

DuraTex™ offers exceptional hardness along with abrasion and impact resistance, it has been formulated to eliminate hazardous and harmful gases that are normally associated with wood finish.

DuraTex™ Features

Safety - Significantly reduces hazardous formaldehyde emissions which help improve the quality of the of the indoor air we breathe.
Quality - Developed to be tough and durable with special attention to appearance. The DuraTex™ finish preserves the natural beauty of wood.
Durability - Designed to meet a wide range of demanding performance and environmental standards to withstand even the highest wear and tear.

Finish Sheen

All veneer finishes are standard in 35-sheen, with the exception of Raven. Raven is only offered in 15-sheen. All other finishes can have their sheen modified with a 15% upcharge added to the list price of each item.

Custom/Special Finishes

JSI, upon request, will accommodate special finishes. A written request is required to proceed with custom finish orders. A sample reference is required for first-time matches and must be included with the written request.

There is a one-time charge of **\$384 list per order** for any non-standard wood finish.

Orders will be entered noting the special finish. A sample match will be provided to the customer. Written approval is needed before the finish process can be started. Delays in approval may have an impact on lead times.

Every effort will be made to create the requested match; however, an acceptable match may not be possible because of natural variations of wood. These natural variations can also cause minor differences in the final finish product.

Use standard pricing and option pricing for each line item with a special finish, unless additional modifications have been specified. For items available in both Essential and Artisan veneers, apply the Essentials pricing.

Solid Surface Tops

Tops are 1 3/8" thick constructed of 1/2" thick Solid Surface on top of a 1/4" MDF sub top. Sub top has an under cut bevel profile and is painted in a coordinated color to match the Solid Surface.

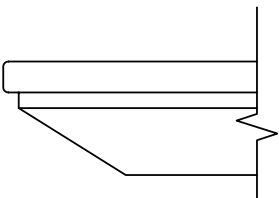

Reverse Bevel Edge (K7)
Solid Surface over painted MDF

Standard Solid Surface

ONX	Black Onyx Mirage
DWH	Designer White
HST	Hot Stone
SOG	Soothing Grey

Conference - Top Shapes

Lok offers 16 conference table top shapes. Tables are available in 29", 36" or 42" high and in laminate, veneer or solid surface. Compatible bases are: X Base, X4 Base, or Y Base.



rectangular

29"h

- 36" x 84" Seats 6
- 36" x 96" Seats 8
- 42" x 84" Seats 6
- 42" x 96" Seats 8
- 48" x 84" Seats 6
- 48" x 96" Seats 8
- 48" x 108" Seats 8
- 48" x 120" Seats 8
- 48" x 144" Seats 12
- 48" x 168" Seats 14
- 48" x 192" Seats 16
- 48" x 216" Seats 18
- 48" x 240" Seats 20
- 54" x 120" Seats 8
- 54" x 144" Seats 12
- 54" x 168" Seats 14
- 54" x 192" Seats 16
- 54" x 216" Seats 18
- 54" x 240" Seats 20
- 60" x 120" Seats 8
- 60" x 144" Seats 12
- 60" x 168" Seats 14
- 60" x 192" Seats 16
- 60" x 216" Seats 18
- 60" x 240" Seats 20

36"h

- 36" x 84" Seats 6
- 36" x 96" Seats 8
- 42" x 84" Seats 6
- 42" x 96" Seats 8
- 48" x 84" Seats 6
- 48" x 96" Seats 8

42"h

- 36" x 84" Seats 6
- 36" x 96" Seats 8
- 42" x 84" Seats 6
- 42" x 96" Seats 8
- 48" x 84" Seats 6
- 48" x 96" Seats 8



rounded rectangular

29"h

- 36" x 84" Seats 6
- 36" x 96" Seats 8
- 42" x 84" Seats 6
- 42" x 96" Seats 8
- 48" x 84" Seats 6
- 48" x 96" Seats 8
- 48" x 108" Seats 8
- 48" x 120" Seats 8
- 48" x 144" Seats 12
- 48" x 168" Seats 14
- 48" x 192" Seats 16
- 48" x 216" Seats 18
- 48" x 240" Seats 20
- 54" x 120" Seats 8
- 54" x 144" Seats 12
- 54" x 168" Seats 14
- 54" x 192" Seats 16
- 54" x 216" Seats 18
- 54" x 240" Seats 20
- 60" x 120" Seats 8
- 60" x 144" Seats 12
- 60" x 168" Seats 14
- 60" x 192" Seats 16
- 60" x 216" Seats 18
- 60" x 240" Seats 20

36"h

- 36" x 84" Seats 6
- 36" x 96" Seats 8
- 42" x 84" Seats 6
- 42" x 96" Seats 8
- 48" x 84" Seats 6
- 48" x 96" Seats 8

42"h

- 36" x 84" Seats 6
- 36" x 96" Seats 8
- 42" x 84" Seats 6
- 42" x 96" Seats 8
- 48" x 84" Seats 6
- 48" x 96" Seats 8



arc rectangular

29"h

- 36" x 84" Seats 6
- 36" x 96" Seats 8
- 42" x 84" Seats 6
- 42" x 96" Seats 8
- 48" x 84" Seats 6
- 48" x 96" Seats 8
- 48" x 108" Seats 8
- 48" x 120" Seats 8
- 48" x 144" Seats 12
- 48" x 168" Seats 14
- 48" x 192" Seats 16
- 48" x 216" Seats 18
- 48" x 240" Seats 20
- 54" x 120" Seats 8
- 54" x 144" Seats 12
- 54" x 168" Seats 14
- 54" x 192" Seats 16
- 54" x 216" Seats 18
- 54" x 240" Seats 20
- 60" x 120" Seats 8
- 60" x 144" Seats 12
- 60" x 168" Seats 14
- 60" x 192" Seats 16
- 60" x 216" Seats 18
- 60" x 240" Seats 20

36"h

- 36" x 84" Seats 6
- 36" x 96" Seats 8
- 42" x 84" Seats 6
- 42" x 96" Seats 8
- 48" x 84" Seats 6
- 48" x 96" Seats 8

42"h

- 36" x 84" Seats 6
- 36" x 96" Seats 8
- 42" x 84" Seats 6
- 42" x 96" Seats 8
- 48" x 84" Seats 6
- 48" x 96" Seats 8



rounded arc rectangular

29"h

- 36" x 84" Seats 6
- 36" x 96" Seats 8
- 42" x 84" Seats 6
- 42" x 96" Seats 8
- 48" x 84" Seats 6
- 48" x 96" Seats 8
- 48" x 108" Seats 8
- 48" x 120" Seats 8
- 48" x 144" Seats 12
- 48" x 168" Seats 14
- 48" x 192" Seats 16
- 48" x 216" Seats 18
- 48" x 240" Seats 20
- 54" x 120" Seats 8
- 54" x 144" Seats 12
- 54" x 168" Seats 14
- 54" x 192" Seats 16
- 54" x 216" Seats 18
- 54" x 240" Seats 20
- 60" x 120" Seats 8
- 60" x 144" Seats 12
- 60" x 168" Seats 14
- 60" x 192" Seats 16
- 60" x 216" Seats 18
- 60" x 240" Seats 20

36"h

- 36" x 84" Seats 6
- 36" x 96" Seats 8
- 42" x 84" Seats 6
- 42" x 96" Seats 8
- 48" x 84" Seats 6
- 48" x 96" Seats 8

42"h

- 36" x 84" Seats 6
- 36" x 96" Seats 8
- 42" x 84" Seats 6
- 42" x 96" Seats 8
- 48" x 84" Seats 6
- 48" x 96" Seats 8



racetrack

29"h

- 36" x 84" Seats 6
- 36" x 96" Seats 8
- 42" x 84" Seats 6
- 42" x 96" Seats 8
- 48" x 84" Seats 6
- 48" x 96" Seats 8
- 48" x 108" Seats 8
- 48" x 120" Seats 8
- 48" x 144" Seats 12
- 48" x 168" Seats 14
- 48" x 192" Seats 16
- 48" x 216" Seats 18
- 48" x 240" Seats 20
- 54" x 120" Seats 8
- 54" x 144" Seats 12
- 54" x 168" Seats 14
- 54" x 192" Seats 16
- 54" x 216" Seats 18
- 54" x 240" Seats 20
- 60" x 120" Seats 8
- 60" x 144" Seats 12
- 60" x 168" Seats 14
- 60" x 192" Seats 16
- 60" x 216" Seats 18
- 60" x 240" Seats 20

36"h

- 36" x 84" Seats 6
- 36" x 96" Seats 8
- 42" x 84" Seats 6
- 42" x 96" Seats 8
- 48" x 84" Seats 6
- 48" x 96" Seats 8

42"h

- 36" x 84" Seats 6
- 36" x 96" Seats 8
- 42" x 84" Seats 6
- 42" x 96" Seats 8
- 48" x 84" Seats 6
- 48" x 96" Seats 8



oval

29"h

- 42" x 84" Seats 6
- 48" x 96" Seats 8
- 54" x 108" Seats 8
- 60" x 120" Seats 10

36"h

- 42" x 84" Seats 6
- 48" x 96" Seats 8

42"h

- 42" x 84" Seats 6
- 48" x 96" Seats 8

Conference - Top Shapes

Lok offers 15 conference table top shapes. Tables are available in 29", 36" or 42" high and in laminate, veneer or solid surface. Compatible bases are: X Base, X4 Base, or Y Base.

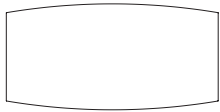

boat

29"h

- 36" x 84" Seats 6
- 36" x 96" Seats 8
- 42" x 84" Seats 6
- 42" x 96" Seats 8
- 48" x 84" Seats 6
- 48" x 96" Seats 8
- 48" x 108" Seats 8
- 48" x 120" Seats 8
- 48" x 144" Seats 12
- 48" x 168" Seats 14
- 48" x 192" Seats 16
- 48" x 216" Seats 18
- 48" x 240" Seats 20
- 54" x 120" Seats 8
- 54" x 144" Seats 12
- 54" x 168" Seats 14
- 54" x 192" Seats 16
- 54" x 216" Seats 18
- 54" x 240" Seats 20
- 60" x 120" Seats 8
- 60" x 144" Seats 12
- 60" x 168" Seats 14
- 60" x 192" Seats 16
- 60" x 216" Seats 18
- 60" x 240" Seats 20

36"h

- 36" x 84" Seats 6
- 36" x 96" Seats 8
- 42" x 84" Seats 6
- 42" x 96" Seats 8
- 48" x 84" Seats 6
- 48" x 96" Seats 8

42"h

- 36" x 84" Seats 6
- 36" x 96" Seats 8
- 42" x 84" Seats 6
- 42" x 96" Seats 8
- 48" x 84" Seats 6
- 48" x 96" Seats 8

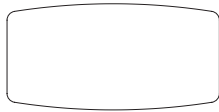

rounded boat

29"h

- 36" x 84" Seats 6
- 36" x 96" Seats 8
- 42" x 84" Seats 6
- 42" x 96" Seats 8
- 48" x 84" Seats 6
- 48" x 96" Seats 8
- 48" x 108" Seats 8
- 48" x 120" Seats 8
- 48" x 144" Seats 12
- 48" x 168" Seats 14
- 48" x 192" Seats 16
- 48" x 216" Seats 18
- 48" x 240" Seats 20
- 54" x 120" Seats 8
- 54" x 144" Seats 12
- 54" x 168" Seats 14
- 54" x 192" Seats 16
- 54" x 216" Seats 18
- 54" x 240" Seats 20
- 60" x 120" Seats 8
- 60" x 144" Seats 12
- 60" x 168" Seats 14
- 60" x 192" Seats 16
- 60" x 216" Seats 18
- 60" x 240" Seats 20

36"h

- 36" x 84" Seats 6
- 36" x 96" Seats 8
- 42" x 84" Seats 6
- 42" x 96" Seats 8
- 48" x 84" Seats 6
- 48" x 96" Seats 8

42"h

- 36" x 84" Seats 6
- 36" x 96" Seats 8
- 42" x 84" Seats 6
- 42" x 96" Seats 8
- 48" x 84" Seats 6
- 48" x 96" Seats 8

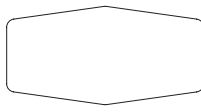

rounded double chevron

29"h

- 36" x 84" Seats 6
- 36" x 96" Seats 8
- 42" x 84" Seats 6
- 42" x 96" Seats 8
- 48" x 84" Seats 6
- 48" x 96" Seats 8

36"h

- 36" x 84" Seats 6
- 36" x 96" Seats 8
- 42" x 84" Seats 6
- 42" x 96" Seats 8
- 48" x 84" Seats 6
- 48" x 96" Seats 8

42"h

- 36" x 84" Seats 6
- 36" x 96" Seats 8
- 42" x 84" Seats 6
- 42" x 96" Seats 8
- 48" x 84" Seats 6
- 48" x 96" Seats 8

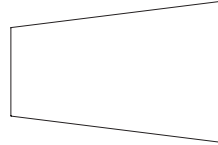

taper

29"h

- 54" x 96" Seats 8
- 60" x 120" Seats 10

36"h

- 54" x 96" Seats 8

42"h

- 54" x 96" Seats 8

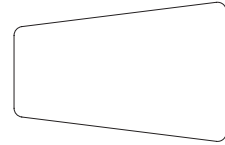

rounded taper

29"h

- 54" x 96" Seats 8
- 60" x 120" Seats 10

36"h

- 54" x 96" Seats 8

42"h

- 54" x 96" Seats 8

Lok - Top Shapes

Lok offers 15 conference table top shapes. Tables are available in 29", 36" or 42" high and in laminate, veneer or solid surface. Compatible bases are: X Base, X4 Base, or Y Base.

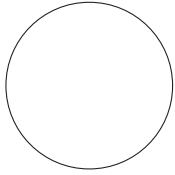

round

29"h

30"	Seats 3
36"	Seats 4
42"	Seats 4
48"	Seats 4
54"	Seats 6
60"	Seats 8

36"h

30"	Seats 3
36"	Seats 4
42"	Seats 4
48"	Seats 4
54"	Seats 6
60"	Seats 8

42"h

30"	Seats 3
36"	Seats 4
42"	Seats 4
48"	Seats 4
54"	Seats 6
60"	Seats 8



square

29"h

30" x 30"	Seats 4
36" x 36"	Seats 4
42" x 42"	Seats 4
48" x 48"	Seats 4
54" x 54"	Seats 6
60" x 60"	Seats 8

36"h

30" x 30"	Seats 4
36" x 36"	Seats 4
42" x 42"	Seats 4
48" x 48"	Seats 4
54" x 54"	Seats 6
60" x 60"	Seats 8

42"h

30" x 30"	Seats 4
36" x 36"	Seats 4
42" x 42"	Seats 4
48" x 48"	Seats 4
54" x 54"	Seats 6
60" x 60"	Seats 8

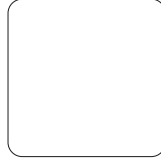

rounded square

29"h

30" x 30"	Seats 4
36" x 36"	Seats 4
42" x 42"	Seats 4
48" x 48"	Seats 4
54" x 54"	Seats 6
60" x 60"	Seats 8

36"h

30" x 30"	Seats 4
36" x 36"	Seats 4
42" x 42"	Seats 4
48" x 48"	Seats 4
54" x 54"	Seats 6
60" x 60"	Seats 8

42"h

30" x 30"	Seats 4
36" x 36"	Seats 4
42" x 42"	Seats 4
48" x 48"	Seats 4
54" x 54"	Seats 6
60" x 60"	Seats 8

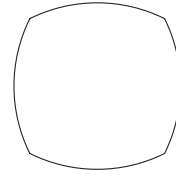

squircle

29"h

30" x 30"	Seats 4
36" x 36"	Seats 4
42" x 42"	Seats 4
48" x 48"	Seats 4
54" x 54"	Seats 6
60" x 60"	Seats 8

36"h

30" x 30"	Seats 4
36" x 36"	Seats 4
42" x 42"	Seats 4
48" x 48"	Seats 4
54" x 54"	Seats 6
60" x 60"	Seats 8

42"h

30" x 30"	Seats 4
36" x 36"	Seats 4
42" x 42"	Seats 4
48" x 48"	Seats 4
54" x 54"	Seats 6
60" x 60"	Seats 8

Conference - Base Styles

Lok provides a choice selection of bases in both function and aesthetics to serve a variety of needs. The conferencing offering includes: X-Base, Y Base and X4 base.

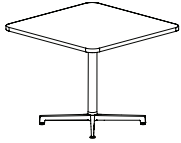

X-Base

- available 29"h, 36"h or 42"h only in glides.
- compatible with the following top shapes: round, square or squircle
- base finish - select single metal finish or two-tone metal finish. See options listed below.
- power access version, with integrated wire management available with an upcharge

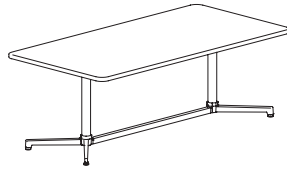

Y Base

- available in 29"h, 36"h or 42"h only in glides.
- compatible with the following top shapes: arc rectangular, boat, double chevron, oval, racetrack, rectangular, round, square and taper
- base finish - select single metal finish or two-tone metal finish. See options listed below.

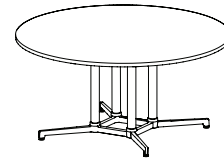

X4 Base

- available in 29"h, 36"h or 42"h only in glides
- compatible with the following top shapes: round, square, and squircle
- base finish - select single metal finish or two-tone metal finish. See options listed below.

Single Metal Finish

- ABZ** Aged Bronze Feet & Post
- ASL** Arctic Silver Feet & Post
- GLD** Gold Feet & Post
- PEW** Pewter Feet & Post
- MBK** Matte Black Feet & Post
- SBZ** Soft Bronze Feet & Post
- SNK** Soft Nickel Feet & Post

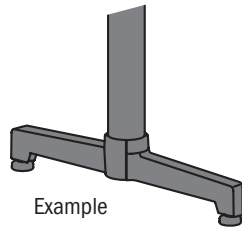

Two - Tone Metal Finish

Two - Tone Aesthetics can be achieved by specifying Polished Aluminum on the foot and a contrasting finish on the post

Polished Aluminum Feet

- ABZ** Aged Bronze Post
- ASL** Arctic Silver Post
- GLD** Gold Post
- PEW** Pewter Post
- MBK** Matte Black Post
- SBZ** Soft Bronze Post
- SNK** Soft Nickel Post

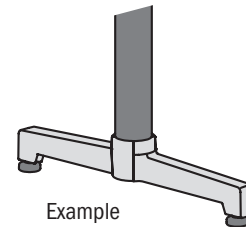

Power/Charging Options

Lok offers the ability to place power and charging options in the center of select tables. Select your choice of EC23 or EC24, available in black and white.



Moire - EC23

- Three 110 outlets
- Dual USB port with 72" power cord
- Black (B) or White (W)

select CTEC23 for cutout in worksurfaces



Node - EC24

- One 110 outlet
- Dual USB port with 72" power cord
- Black (B) or White (W)

select CTEC24 for cutout in worksurfaces

Cut outs are located in the center of each table. See below for representation or location.

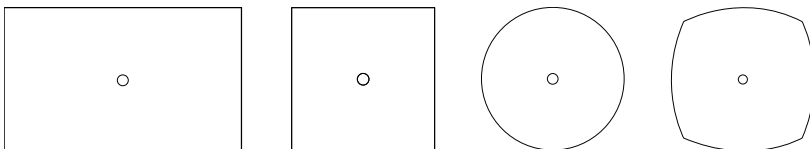

Lok Product Information

Electrical Overview

Lok provides several packages to choose from for your electrical needs. Choose solutions for top surface power, underneath outlets, wireless charging, or a combination.

Specifying an electrical package eliminates your need to calculate additional components, as all units and necessary jumpers will ship with your table. You will only need to determine which power in-feed best suits your needs and order separately.

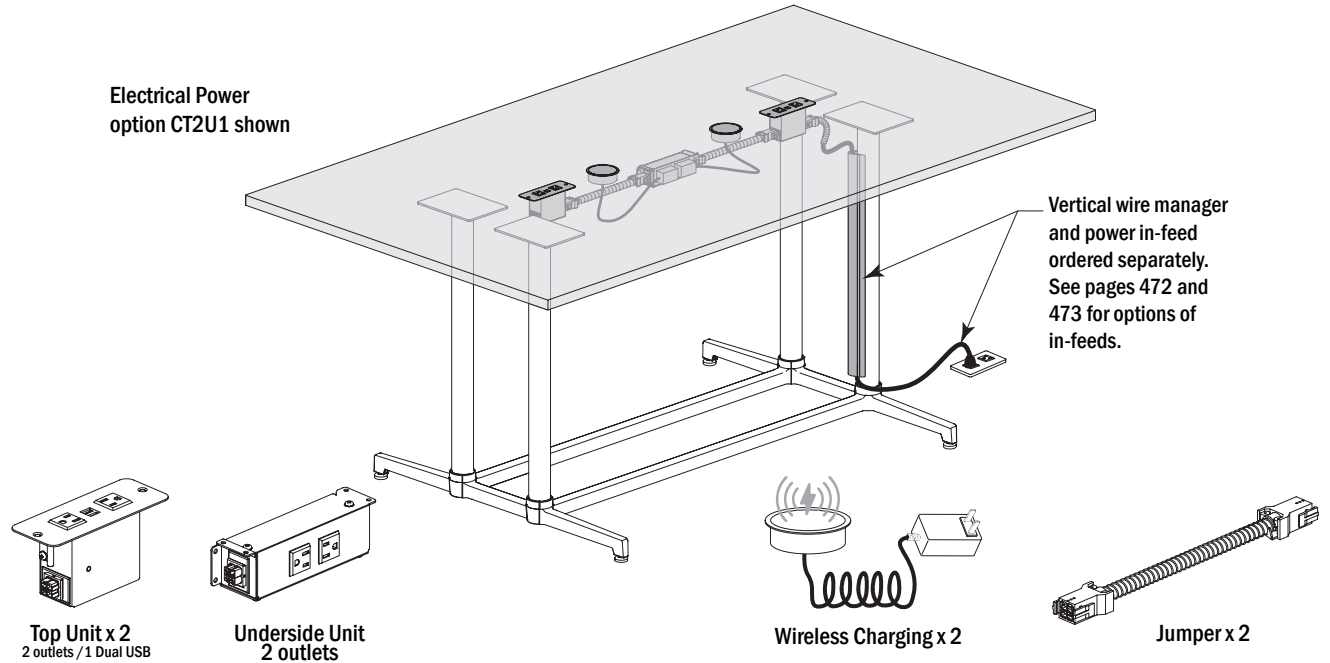

Electrical - 1 Piece Tops

Power and Charging Packages are measured and located out from the center of the table. Shown on rectangular tops, these dimensions are the same from center regardless of table shape (ie chevron, boat, etc.). Power in-feed is specified separately to support building electrical connection.

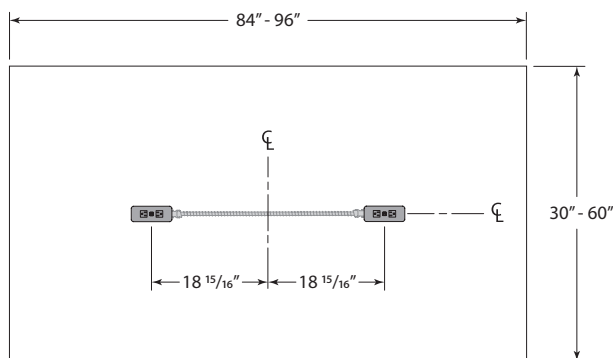
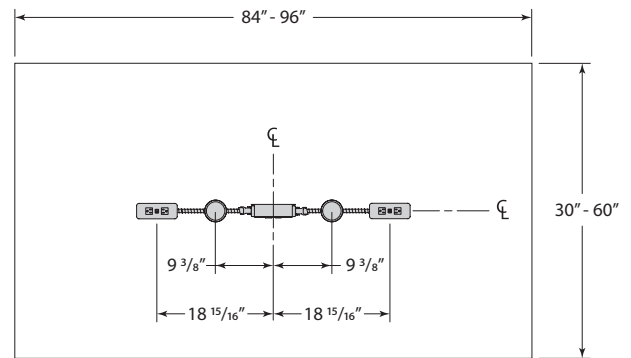
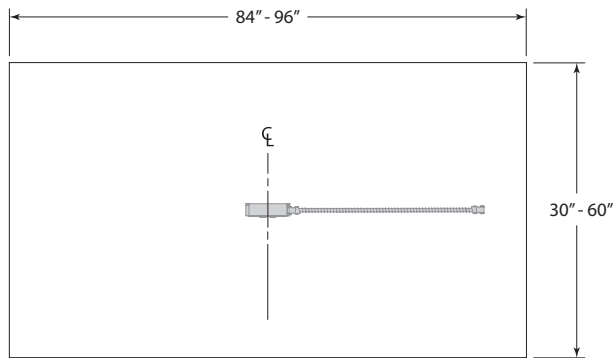

Conference - Electrical

Electrical - 2 Piece Tops

Power and Charging Packages are measured and located out from the center of the table. Shown on rectangular tops, these dimensions are the same from center regardless of table shape (ie chevron, boat, etc.). Power in-feed is specified separately to support building electrical connection.

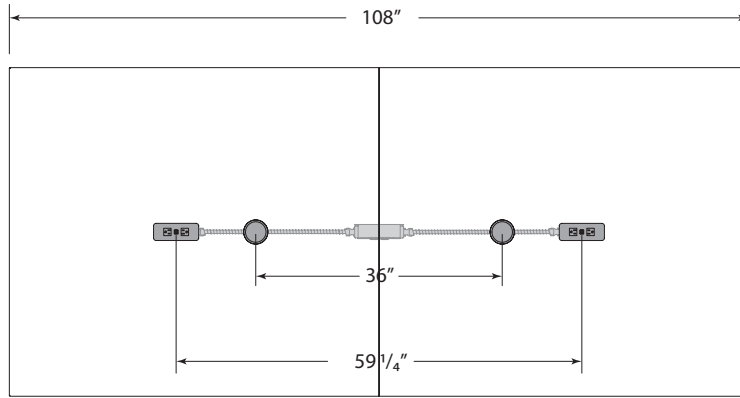

CT2 - Dual Power Top with Underside and Two Wireless Charging

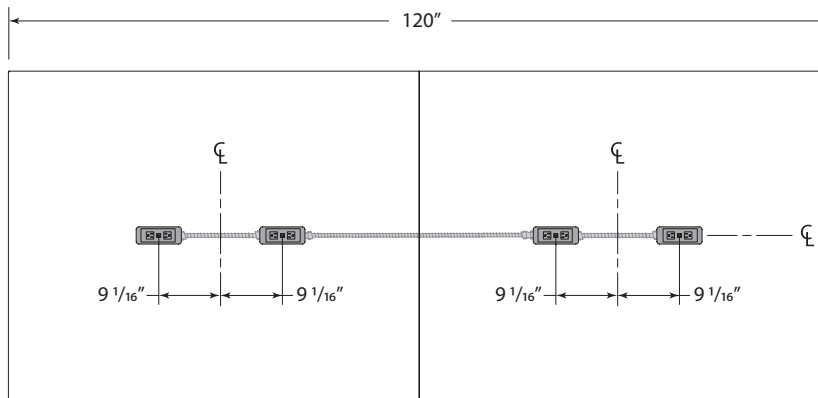

CT4 - Four Power Top

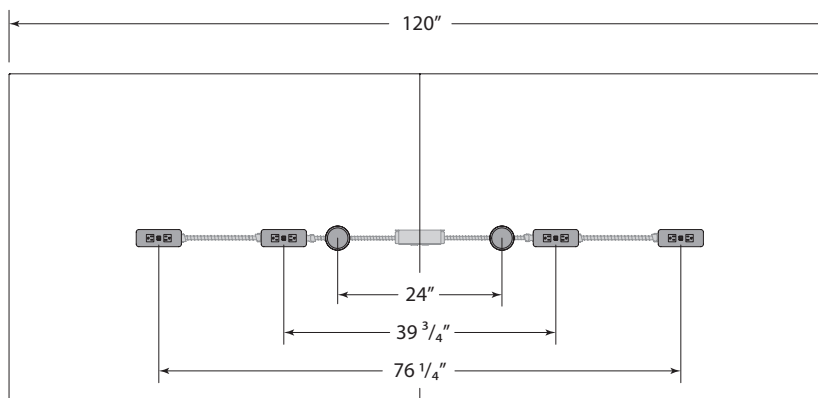

CT4 - Four Power Top with Underside and Two Wireless Charging

Conference - Electrical

Electrical - 3 Piece Tops

Power and Charging Packages are measured and located out from the center of the table. Shown on rectangular tops, these dimensions are the same from center regardless of table shape (ie chevron, boat, etc.). Power in-feed is specified separately to support building electrical connection.

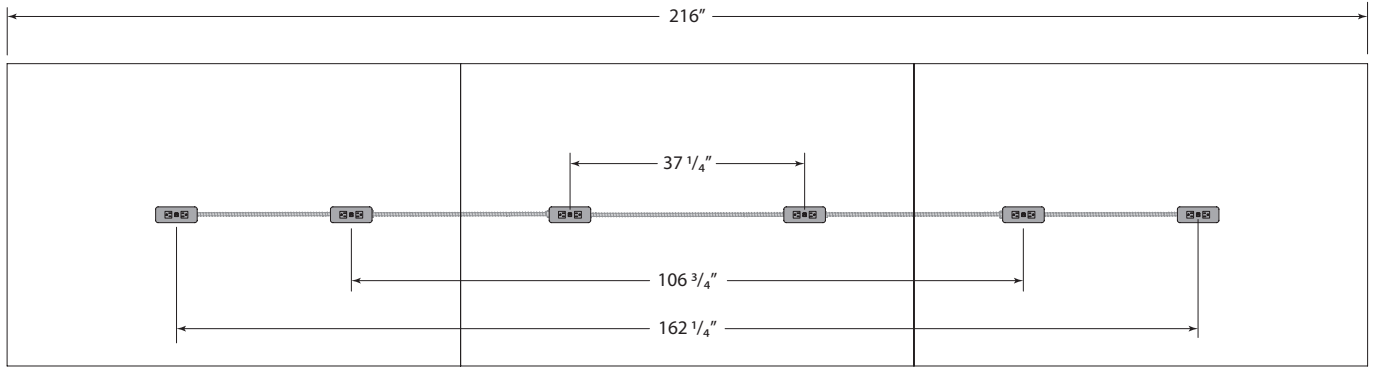

CT6 - Six Power Top

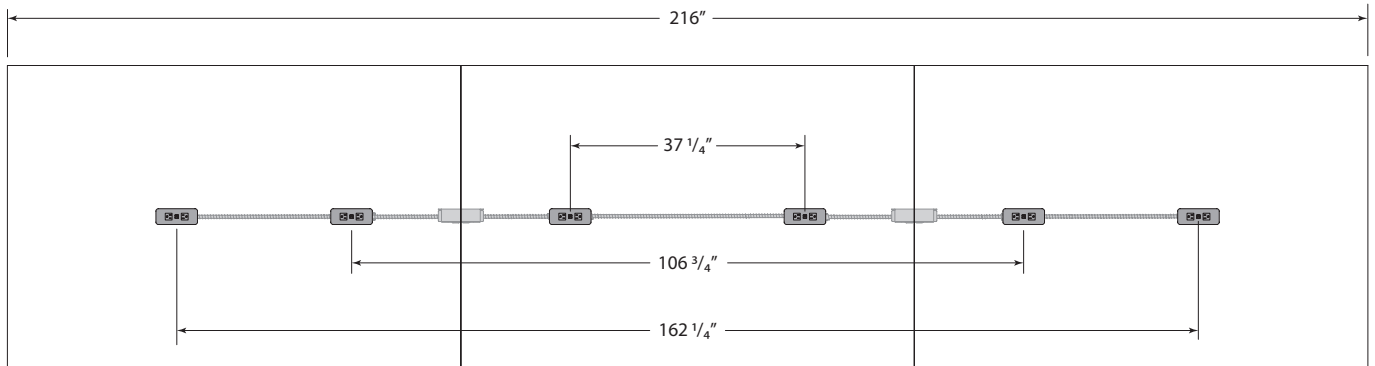

CT6 - Six Power Top

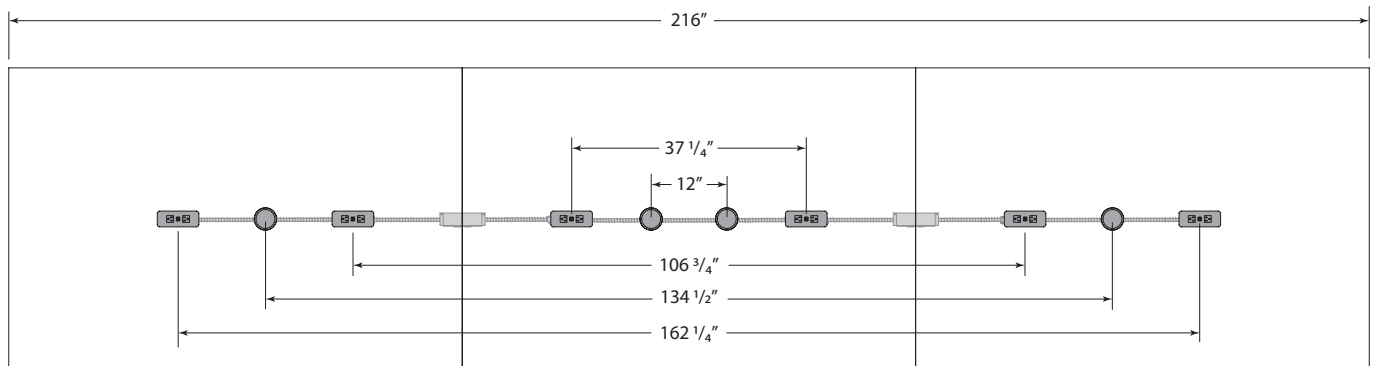

CT6 - Six Power Top with Dual Underside and Four Wireless Charging

LOK - CONFERENCE

Description

Rectangular 3pc Table with T Base at Working Height

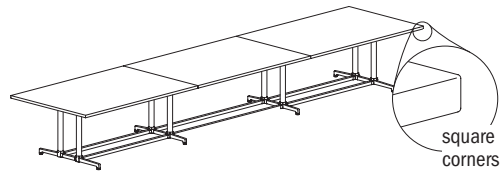

Laminate Tables "LKT" Models

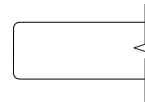

Eased Edge (R3)

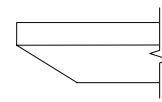

Reverse Bevel Edge (K9)

D	W	H	CTN WT	CU FT	Model	Eased Edge (R3)		Reverse Bevel Edge (K9)	
						Standard Tier 1	Graded In Tier 2	Standard Tier 1	Graded In Tier 2
60	240	29	653	281	LKT60240-29TTT	\$10,074	\$10,239	\$10,775	\$10,938
60	216	29	598	253	LKT60216-29TTT	\$8,452	\$8,599	\$9,120	\$9,267
54	240	29	603	254	LKT54240-29TTT	\$8,105	\$8,253	\$8,769	\$8,917
54	216	29	453	229	LKT54216-29TTT	\$7,627	\$7,761	\$8,264	\$8,397
48	240	29	551	228	LKT48240-29TTT	\$7,729	\$7,861	\$8,358	\$8,489
48	216	29	553	206	LKT48216-29TTT	\$7,281	\$7,400	\$7,886	\$8,005

Features:

- price reflects complete table - top and base
- ships KD in multiple cartons
- three piece top
- model includes adjustable glide

Options:

- specify power/charging option, see below for options and upcharges



top shape

LOK - CONFERENCE

To Order Specify

1 Laminate Model #	2 Edge Detail	3 Laminate Selection	4 PVC Edge Color	5 Electrical	6 Metal Color
Laminate (LKT)	See Edge Detail Options	See Laminate Selection	See PVC Edge Color Options	N None CT6 Six Power Center Top CU2 Dual Power Underside CT6U2 Six Power Center Top with Underside (See chart on next page)	See Metal Finish Color Options

Model Number Breakdown

LKT60240-29TTT					
LK	T	60240	29	TT	T
LOK	Laminate	60" x 240"	Height	Rectangular Top Shape	T base

Description

Rectangular 3pc Table with T Base at Working Height (continued)

Veneer Tables "LKV" Models

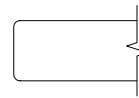

Eased Edge (R3)

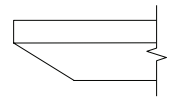

Reverse Bevel Edge (K9)

VENEER	D	W	H	CTN WT	CU FT	Model	Essentials	Artisan	Essentials	Artisan
		60	240	29	653	281	LKV60240-29TTT	\$15,681	\$16,935	\$17,090
	60	216	29	598	253	LKV60216-29TTT	\$13,793	\$14,895	\$15,034	\$16,012
	54	240	29	603	254	LKV54240-29TTT	\$13,265	\$14,363	\$13,904	\$14,947
	54	216	29	603	254	LKV54216-29TTT	\$12,317	\$13,289	\$12,904	\$13,828
	48	240	29	324	130	LKV48240-29TTT	\$11,451	\$12,418	\$12,029	\$12,943
	48	216	29	551	228	LKV48216-29TTT	\$11,579	\$12,434	\$12,111	\$12,920

Electrical Options and Upcharges

	216 - 240 wide
CT6	
Six Power Center Top - Black	CT6BL - add \$4,137
Six Power Center Top - White	CT6WH - add \$4,137
CU2	
Dual Power Underside - Black	CU2-1C - add \$1,084
Dual Power Underside with 4 Wireless Charging - Black	CU2-1CW - add \$2,740
CT6U2	
Six Power Center Top - Black with Dual Underside	CT6U2-BL - add \$4,805
Six Power Center Top - White with Dual Underside	CT6U2-WH - add \$4,805
Six Power Center Top - Black Dual Underside with 4 Wireless Charging	CT6U2-BLW2 - add \$6,410
Six Power Center Top - White Dual Underside with 4 Wireless Charging	CT6U2-WHW2 - add \$6,410

Note: Order power infeed that best fits application

To Order Specify

1 Veneer Model #	2 Edge Detail	3 Wood Collection	4 Wood Finish	5 Electrical	6 Metal Color
Veneer (LKV)	See Edge Detail Options	Essentials	See Essentials Wood Finish Options	N None CT6 Six Power Center Top CU2 Dual Power Underside CT6U2 Six Power Center Top with Underside (See chart above)	See Metal Finish Color Options
		Artisan	4 Wood Finish See Artisan Wood Finish Options		

LOK - CONFERENCE

Description

Rectangular 2pc Table with T Base at Working Height

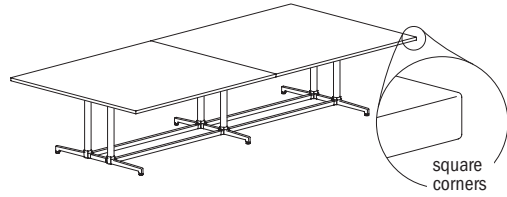

Laminate Tables "LKT" Models

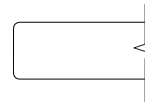

Eased Edge (R3)

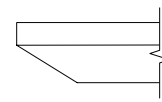

Reverse Bevel Edge (K9)

	D	W	H	CTN WT	CU FT	Model	Eased Edge (R3)		Reverse Bevel Edge (K9)	
							Standard Tier 1	Graded In Tier 2	Standard Tier 1	Graded In Tier 2
LAMINATE	60	192	29	513	226	LKT60192-29TTT	\$7,134	\$7,267	\$7,769	\$7,901
	60	168	29	460	198	LKT60168-29TTT	\$6,670	\$6,786	\$7,274	\$7,390
	60	144	29	405	169	LKT60144-29TTT	\$6,168	\$6,266	\$6,743	\$6,840
	60	120	29	350	143	LKT60120-29TTT	\$5,361	\$5,442	\$5,903	\$5,988
	54	192	29	472	204	LKT54192-29TTT	\$6,675	\$6,793	\$7,283	\$7,401
	54	168	29	389	178	LKT54168-29TTT	\$6,048	\$6,150	\$6,629	\$6,733
	54	144	29	375	154	LKT54144-29TTT	\$5,573	\$5,662	\$6,128	\$6,218
	54	120	29	324	130	LKT54120-29TTT	\$5,043	\$5,118	\$5,570	\$5,644
	48	192	29	432	183	LKT48192-29TTT	\$5,820	\$5,926	\$6,401	\$6,507
	48	168	29	389	161	LKT48168-29TTT	\$5,414	\$5,507	\$5,970	\$6,064
	48	144	29	344	139	LKT48144-29TTT	\$4,967	\$5,047	\$5,503	\$5,582
	48	120	29	298	116	LKT48120-29TTT	\$4,466	\$4,532	\$4,977	\$5,043
	48	108	29	275	105	LKT48108-29TTT	\$3,774	\$3,833	\$4,274	\$4,333

Features:

- price reflects complete table - top and base
- ships KD in multiple cartons
- two piece top
- model includes adjustable glide

· specify power/charging option, see below for options and upcharges

LOK - CONFERENCE



top shape

To Order Specify

1 Laminate Model #	2 Edge Detail	3 Laminate Selection	3a PVC Edge Color	4 Electrical	5 Metal Color
Laminate (LKT)	See Edge Detail Options	See Laminate Selection	See PVC Edge Color Options	N None CT2 Dual Power Center Top CU2 Dual Power Underside CT2U1 Dual Power Center Top with Underside CT4U2 Four Power Center Top with Underside CT4 Four Power Center Top (See chart on next page)	See Metal Finish Color Options

Model Number Breakdown

LKT60192-29TTT					
LK	T	60192	29	TT	T
LOK	Laminate	60" x 192"	Height	Rectangular Top Shape	T base

Description

Rectangular 2pc Table with T Base at Working Height (continued)

Veneer Tables "LKV" Models

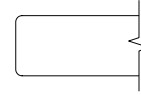

Eased Edge (R3)

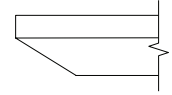

Reverse Bevel Edge (K9)

D	W	H	CTN WT	CU FT	Model	Eased Edge (R3)		Reverse Bevel Edge (K9)	
						Essentials	Artisan	Essentials	Artisan
60	192	29	513	226	LKV60192-29TTT	\$10,923	\$11,797	\$11,906	\$12,680
60	168	29	460	198	LKV60168-29TTT	\$10,056	\$10,860	\$10,959	\$11,671
60	144	29	460	198	LKV60144-29TTT	\$9,157	\$9,890	\$9,983	\$10,630
60	120	29	405	169	LKV60120-29TTT	\$8,084	\$8,731	\$8,812	\$9,385
54	192	29	453	204	LKV54192-29TTT	\$9,994	\$10,794	\$10,892	\$11,601
54	168	29	472	204	LKV54168-29TTT	\$10,225	\$11,042	\$11,143	\$11,869
54	144	29	389	178	LKV54144-29TTT	\$8,311	\$8,974	\$9,058	\$9,645
54	120	29	375	154	LKV54120-29TTT	\$7,423	\$8,016	\$8,090	\$8,615
48	192	29	553	206	LKV48192-29TTT	\$10,025	\$10,776	\$10,515	\$11,222
48	168	29	432	183	LKV48168-29TTT	\$8,231	\$8,880	\$8,678	\$9,287
48	144	29	389	161	LKV48144-29TTT	\$7,458	\$8,005	\$7,865	\$8,377
48	120	29	344	139	LKV48120-29TTT	\$6,634	\$7,081	\$6,997	\$7,416
48	108	29	298	116	LKV48108-29TTT	\$5,438	\$5,869	\$5,926	\$6,310

Electrical Options and Upcharges

CT2	108 wide	120 - 192 wide
Dual Power Center Top - Black	CT2BL - add \$1,535	n/a
Dual Power Center Top - White	CT2WH - add \$1,535	n/a
CU1		
Single Power Underside - Black	CU1-1C - add \$610	CU1-1C - add \$709
Single Power Underside with Wireless Charging - Black	CU1-1CW - add \$1,413	CU1-1CW - add \$1,484
CT2U1		
Dual Power Center Top - Black with Underside	CT2U1-BL - add \$1,868	n/a
Dual Power Center Top - White with Underside	CT2U1-WH - add \$1,868	n/a
Dual Power Center Top - Black with Wireless Charging	CT2U1-BLW2 - add \$2,670	n/a
Dual Power Center Top - White with Wireless Charging	CT2U1-WHW2 - add \$2,670	n/a

CT4U1	108 wide	120 - 192 wide
Four Power Center Top with Single Underside - Black	n/a	CT4U1-BL - add \$3,265
Four Power Center Top with Single Underside - White	n/a	CT4U1-WH - add \$3,265
Four Power Center Top - Black with Underside & Wireless Charging	n/a	CT4U1-BLW2 - add \$4,046
Four Power Center Top - White with Underside & Wireless Charging	n/a	CT4U1-WHW2 - add \$4,046
CT4		
Four Power Center Top - Black	n/a	CT4BL - add \$2,859
Four Power Center Top - White	n/a	CT4WH - add \$2,859

Note: Order power infeed that best fits application

To Order Specify

1 Veneer Model #	2 Edge Detail	3 Wood Collection	4 Wood Finish	5 Electrical	6 Metal Color
Veneer (LKV)	See Edge Detail Options	Essentials	See Essentials Wood Finish Options	N None CT2 Dual Power Center Top CU2 Dual Power Underside CT2U1 Dual Power Center Top with Underside CT4U2 Four Power Center Top with Underside CT4 Four Power Center Top	See Metal Finish Color Options
		Artisan	4 Wood Finish See Artisan Wood Finish Options		

LOK - CONFERENCE

Description

Rectangular Table with T Base at Working Height

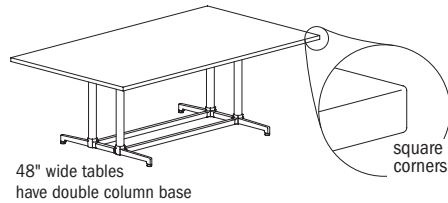

48" wide tables have double column base

D	W	H	CTN WT	CU FT	Model
48	96	29	204	105	LKT4896-29TTT
48	84	29	204	83	LKT4884-29TTT
42	96	29	183	73	LKT4296-29TTT
42	84	29	164	72	LKT4284-29TTT
36	96	29	162	72	LKT3696-29TTT
36	84	29	151	64	LKT3684-29TTT

LAMINATE

Laminate Tables "LKT" Models

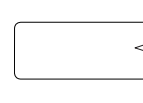

Eased Edge (R3)

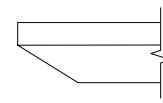

Reverse Bevel Edge (K9)

Eased Edge (R3)		Reverse Bevel Edge (K9)	
Standard Tier 1	Graded In Tier 2	Standard Tier 1	Graded In Tier 2
\$3,163	\$3,217	\$3,650	\$3,702
\$2,817	\$2,862	\$3,290	\$3,337
\$2,880	\$2,928	\$3,354	\$3,401
\$2,369	\$2,410	\$2,832	\$2,872
\$2,418	\$2,459	\$2,878	\$2,920
\$2,168	\$2,203	\$2,619	\$2,655

Features:

- price reflects complete table - top and base
- ships KD in multiple cartons
- one piece top
- model includes adjustable glide

Options:

- specify power/charging option, see below for options and upcharges

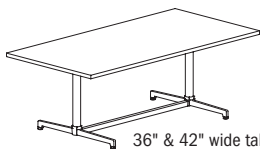

36" & 42" wide tables have single column base



top shape

LOK - CONFERENCE

To Order Specify

1 Laminate Model #	2 Edge Detail	3 Laminate Selection	3a PVC Edge Color	4 Electrical	5 Metal Color
Laminate (LKT)	See Edge Detail Options	See Laminate Selection	See PVC Edge Color Options	N None CT2 Dual Power Center Top CU2 Dual Power Underside CT2U1 Dual Power Center Top with Underside (See chart on next page)	See Metal Finish Color Options

Model Number Breakdown

LKT4896-29TTT					
LK	T	4896	29	TT	T
LOK	Laminate	48" x 96"	Height	Rectangular Top Shape	T base

Description

Rectangular Table with T Base
at Working Height
(continued)

Veneer Tables
"LKV" Models

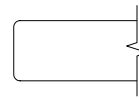

Eased Edge (R3)

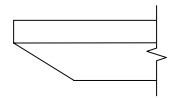

Reverse Bevel Edge (K9)

VENEER	D	W	H	CTN WT	CU FT	① Model	Essentials	Artisan	Essentials	Artisan
		48	96	29	275	105	LKV4896-29TTT	\$4,428	\$4,778	\$4,747
	48	84	29	204	94	LKV4884-29TTT	\$4,026	\$4,328	\$4,324	\$4,602
	42	96	29	183	83	LKV4296-29TTT	\$4,831	\$5,220	\$5,266	\$5,607
	42	84	29	164	73	LKV4284-29TTT	\$3,677	\$3,970	\$4,007	\$4,268
	36	96	29	162	72	LKV3696-29TTT	\$3,270	\$3,529	\$3,563	\$3,793
	36	84	29	145	72	LKV3684-29TTT	\$3,065	\$3,310	\$3,343	\$3,559

Electrical Options and Upcharges

CT2	84 - 96 wide
Dual Power Center Top - Black	CT2BL - add \$1,535
Dual Power Center Top - White	CT2WH - add \$1,535
CU1	
Single Power Underside - Black	CU1-1C - add \$610
Single Power Underside with Wireless Charging - Black	CU1-1CW - add \$1,413
CT2U1	
Dual Power Center Top - Black with Single Underside	CT2U1-BL - add \$1,904
Dual Power Center Top - White with Single Underside	CT2U1-WH - add \$1,904
Dual Power Center Top - Black with Wireless Charging	CT2U1-BLW2 - add \$2,670
Dual Power Center Top - White with Wireless Charging	CT2U1-WHW2 - add \$2,670

Note: Order power infed that best fits application

To Order Specify

① Veneer Model #	② Edge Detail	③ Wood Collection	④ Wood Finish	⑤ Electrical	⑥ Metal Color
Veneer (LKV)	See Edge Detail Options	Essentials	See Essentials Wood Finish Options	N None CT2 Dual Power Center Top CU2 Dual Power Underside CT2U1 Dual Power Center Top with Underside (See chart above)	See Metal Finish Color Options
		Artisan	④ Wood Finish See Artisan Wood Finish Options		

Description

Rounded Rectangular 3pc Table with T Base at Working Height

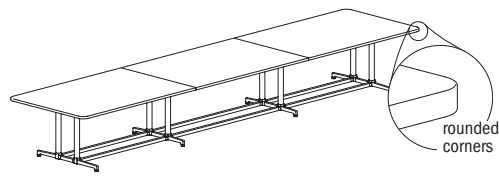

Laminate Tables "LKT" Models

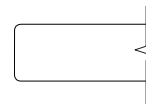

Eased Edge (R3)

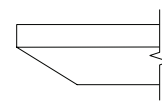

Reverse Bevel Edge (K9)

LAMINATE	D	W	H	CTN WT	CU FT	Model	Standard Tier 1	Graded In Tier 2	Standard Tier 1	Graded In Tier 2
		60	240	29	653	281	LKT60240-29TTRT	\$10,259	\$10,426	\$10,959
	60	216	29	598	253	LKT60216-29TTRT	\$8,745	\$8,892	\$9,414	\$9,563
	54	240	29	603	254	LKT54240-29TTRT	\$8,276	\$8,423	\$8,940	\$9,088
	54	216	29	453	229	LKT54216-29TTRT	\$7,782	\$7,917	\$8,422	\$8,554
	48	240	29	551	228	LKT48240-29TTRT	\$7,883	\$8,016	\$8,513	\$8,644
	48	216	29	553	206	LKT48216-29TTRT	\$6,974	\$7,093	\$7,581	\$7,700

Features:

- price reflects complete table - top and base
- ships KD in multiple cartons
- three piece top
- model includes adjustable glide

Options:

- specify power/charging option, see below for options and upcharges



top shape

LOK - CONFERENCE

To Order Specify

1 Laminate Model #	2 Edge Detail	3 Laminate Selection	3a PVC Edge Color	4 Electrical	5 Metal Color
Laminate (LKT)	See Edge Detail Options	See Laminate Selection	See PVC Edge Color Options	N None CT6 Six Power Center Top CU2 Dual Power Underside CT6U2 Six Power Center Top with Underside (See chart on next page)	See Metal Finish Color Options

Model Number Breakdown

LKT60240-29TTRT						
LK	T	60240	29	TT	R	T
LOK	Laminate	60" x 240"	Height	Rectangular Top Shape	Rounded Corner	T base

Description

Rounded Rectangular 3pc Table with T Base at Working Height (continued)

Veneer Tables "LKV" Models

Solid Surface Tables "LKS" Models

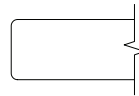

Eased Edge (R3)

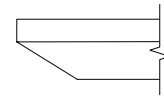

Reverse Bevel Edge (K9)

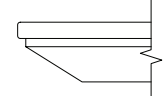

Reverse Bevel Edge (S7)

	D	W	H	CTN WT	CU FT	① Model	Veneer		Solid Surface		
							Essentials	Artisan	Essentials	Artisan	Standard
VENEER	60	240	29	653	281	LKV60240-29TTRT	\$15,957	\$17,234	\$17,393	\$18,524	--
	60	216	29	598	253	LKV60216-29TTRT	\$14,046	\$15,169	\$15,309	\$16,305	--
	54	240	29	603	254	LKV54240-29TTRT	\$13,519	\$14,614	\$14,156	\$15,197	--
	54	216	29	453	229	LKV54216-29TTRT	\$12,545	\$13,519	\$13,130	\$14,053	--
	48	240	29	551	228	LKV48240-29TTRT	\$12,683	\$13,649	\$13,263	\$14,175	--
	48	216	29	553	206	LKV48216-29TTRT	\$11,140	\$11,998	\$11,675	\$12,484	--
SOLID SURFACE	60	240	29	653	281	LKS60240-29TTRT	--	--	--	--	\$35,826
	60	216	29	598	253	LKS60216-29TTRT	--	--	--	--	\$32,381
	54	240	29	603	254	LKS54240-29TTRT	--	--	--	--	\$32,600
	54	216	29	453	229	LKS54216-29TTRT	--	--	--	--	\$29,499
	48	240	29	551	228	LKS48240-29TTRT	--	--	--	--	\$29,441
	48	216	29	553	206	LKS48216-29TTRT	--	--	--	--	\$26,032

Electrical Options and Upcharges

	216 - 240 wide
CT6	
Six Power Center Top - Black	CT6BL - add \$4,137
Six Power Center Top - White	CT6WH - add \$4,137
CU2	
Dual Power Underside - Black	CU2-1C - add \$1,084
Dual Power Underside with 4 Wireless Charging - Black	CU2-1CW - add \$2,740
CT6U2	
Six Power Center Top - Black with Dual Underside	CT6U2-BL - add \$4,805
Six Power Center Top - White with Dual Underside	CT6U2-WH - add \$4,805
Six Power Center Top - Black Dual Underside with 4 Wireless Charging	CT6U2-BLW2 - add \$6,410
Six Power Center Top - White Dual Underside with 4 Wireless Charging	CT6U2-WHW2 - add \$6,410

To Order Specify

Note: Order power infeed that best fits application, see page 408.

① Veneer Model #	② Edge Detail	③ Wood Collection	④ Wood Finish	⑤ Electrical	⑥ Metal Color
Veneer (LKV)	See Edge Detail Options	Essentials	See Essentials Wood Finish Options	N None CT6 Six Power Center Top CU2 Dual Power Underside CT6U2 Six Power Center Top with Underside (See chart above)	See Metal Finish Color Options
		Artisan	④ Wood Finish See Artisan Wood Finish Options		

① Solid Surface Model #	② Top Surface Selection	③ Electrical	④ Metal Color
Solid Surface (LKS)	See Solid Surface Top Surface Selection Options	N None CT6 Six Power Center Top CU2 Dual Power Underside CT6U2 Six Power Center Top with Underside (See chart above)	See Metal Finish Color Options

LOK - CONFERENCE

Description

Rounded Rectangular 2pc Table with T Base at Working Height

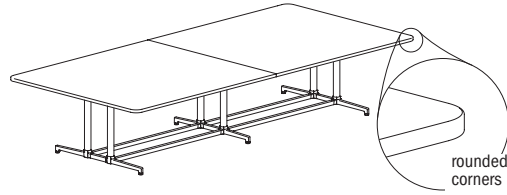

Laminate Tables "LKT" Models

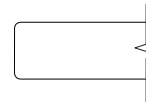

Eased Edge (R3)

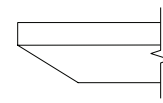

Reverse Bevel Edge (K9)

D	W	H	CTN WT	CU FT	Model	Eased Edge (R3)		Reverse Bevel Edge (K9)	
						Standard Tier 1	Graded In Tier 2	Standard Tier 1	Graded In Tier 2
60	192	29	513	226	LKT60192-29TTRT	\$7,146	\$7,280	\$7,781	\$7,913
60	168	29	460	198	LKT60168-29TTRT	\$6,669	\$6,784	\$7,273	\$7,389
60	144	29	405	169	LKT60144-29TTRT	\$6,153	\$6,251	\$6,728	\$6,826
60	120	29	350	143	LKT60120-29TTRT	\$5,455	\$5,537	\$6,000	\$6,082
54	192	29	472	204	LKT54192-29TTRT	\$6,800	\$6,920	\$7,408	\$7,527
54	168	29	389	178	LKT54168-29TTRT	\$6,159	\$6,264	\$6,743	\$6,845
54	144	29	375	154	LKT54144-29TTRT	\$5,674	\$5,764	\$6,230	\$6,319
54	120	29	324	130	LKT54120-29TTRT	\$5,083	\$5,157	\$5,608	\$5,683
48	192	29	432	183	LKT48192-29TTRT	\$5,933	\$6,039	\$6,515	\$6,620
48	168	29	389	161	LKT48168-29TTRT	\$5,516	\$5,608	\$6,073	\$6,166
48	144	29	344	139	LKT48144-29TTRT	\$5,060	\$5,139	\$5,594	\$5,674
48	120	29	298	116	LKT48120-29TTRT	\$4,547	\$4,613	\$5,058	\$5,125
48	108	29	275	105	LKT48108-29TTRT	\$3,852	\$3,910	\$4,349	\$4,409

LAMINATE

Features:

- price reflects complete table - top and base
- ships KD in multiple cartons
- two piece top
- model includes adjustable glide

Options:

- specify power/charging option, see below for options and upcharges

Electrical Options and Upcharges

	108 wide	120 - 192 wide
CT2		
Dual Power Center Top - Black	CT2BL - add \$1,535	n/a
Dual Power Center Top - White	CT2WH - add \$1,535	n/a
CU1		
Single Power Underside - Black	CU1-1C - add \$610	CU1-1C - add \$709
Single Power Underside with Wireless Charging - Black	CU1-1CW - add \$1,413	CU1-1CW - add \$1,484
CT2U1		
Dual Power Center Top - Black with Underside	CT2U1-BL - add \$1,868	n/a
Dual Power Center Top - White with Underside	CT2U1-WH - add \$1,868	n/a
Dual Power Center Top - Black with Wireless Charging	CT2U1-BLW2 - add \$2,670	n/a
Dual Power Center Top - White with Wireless Charging	CT2U1-WHW2 - add \$2,670	n/a

Note: Order power infeed that best fits application.

	108 wide	120 - 192 wide
CT4U1		
Four Power Center Top with Single Underside - Black	n/a	CT4U1-BL - add \$3,265
Four Power Center Top with Single Underside - White	n/a	CT4U1-WH - add \$3,265
Four Power Center Top - Black with Underside & Wireless Charging	n/a	CT4U1-BLW2 - add \$4,046
Four Power Center Top - White with Underside & Wireless Charging	n/a	CT4U1-WHW2 - add \$4,046
CT4		
Four Power Center Top - Black	n/a	CT4BL - add \$2,859
Four Power Center Top - White	n/a	CT4WH - add \$2,859

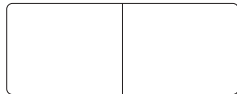

top shape

To Order Specify

1 Laminate Model #	2 Edge Detail	3 Laminate Selection	3a PVC Edge Color	4 Electrical	5 Metal Color
Laminate (LKT)	See Edge Detail Options	See Laminate Selection	See PVC Edge Color Options	N None CT2 Dual Power Center Top CU2 Dual Power Underside CT2U1 Dual Power Center Top with Underside CT4U2 Four Power Center Top with Underside CT4 Four Power Center Top (See chart above)	See Metal Finish Color Options

Model Number Breakdown

LKT60192-29TTRT						
LK	T	60192	29	TT	R	T
LOK	Laminate	60" x 192"	Height	Rectangular Top Shape	Rounded Corner	T base

LOK - CONFERENCE

Description

Rounded Rectangular 2pc Table with T Base at Working Height (continued)

Veneer Tables "LKV" Models Solid Surface Tables "LKS" Models

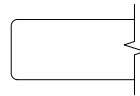

Eased Edge (R3)

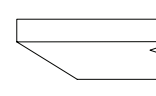

Reverse Bevel Edge (K9)

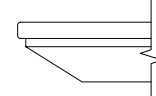

Reverse Bevel Edge (S7)

	D	W	H	CTN WT	CU FT	① Model	Veneer Tables "LKV" Models		Solid Surface Tables "LKS" Models			
							Essentials	Artisan	Essentials	Artisan	Standard	
VENEER	60	192	29	513	226	LKV60192-29TTRT	\$11,121	\$12,011	\$12,121	\$12,908	--	
	60	168	29	460	198	LKV60168-29TTRT	\$10,229	\$11,047	\$11,149	\$11,874	--	
	60	144	29	405	169	LKV60144-29TTRT	\$9,311	\$10,056	\$10,148	\$10,808	--	
	60	120	29	350	143	LKV60120-29TTRT	\$8,216	\$8,873	\$8,955	\$9,535	--	
	54	192	29	472	204	LKV54192-29TTRT	\$10,172	\$10,988	\$11,089	\$11,807	--	
	54	168	29	389	178	LKV54168-29TTRT	\$9,302	\$10,048	\$10,140	\$10,799	--	
	54	144	29	375	154	LKV54144-29TTRT	\$8,449	\$9,125	\$9,211	\$9,807	--	
	54	120	29	324	130	LKV54120-29TTRT	\$7,477	\$8,075	\$8,149	\$8,676	--	
	48	192	29	432	183	LKV48192-29TTRT	\$9,135	\$9,884	\$9,624	\$10,330	--	
	48	168	29	389	161	LKV48168-29TTRT	\$8,375	\$9,021	\$8,820	\$9,431	--	
	48	144	29	344	139	LKV48144-29TTRT	\$7,584	\$8,130	\$7,989	\$8,502	--	
	48	120	29	298	116	LKV48120-29TTRT	\$6,743	\$7,191	\$7,106	\$7,526	--	
	48	108	29	275	105	LKV48108-29TTRT	\$5,536	\$5,979	\$6,033	\$6,425	--	
	SOLID SURFACE	60	192	29	513	226	LKS60192-29TTRT	--	--	--	--	\$26,908
		60	168	29	460	198	LKS60168-29TTRT	--	--	--	--	\$23,776
		60	144	29	405	169	LKS60144-29TTRT	--	--	--	--	\$20,683
60		120	29	350	143	LKS60120-29TTRT	--	--	--	--	\$22,621	
54		192	29	472	204	LKS54192-29TTRT	--	--	--	--	\$24,361	
54		168	29	389	178	LKS54168-29TTRT	--	--	--	--	\$21,627	
54		144	29	375	154	LKS54144-29TTRT	--	--	--	--	\$18,846	
54		120	29	324	130	LKS54120-29TTRT	--	--	--	--	\$16,010	
48		192	29	432	183	LKS48192-29TTRT	--	--	--	--	\$22,028	
48		168	29	389	161	LKS48168-29TTRT	--	--	--	--	\$19,528	
48		144	29	344	139	LKS48144-29TTRT	--	--	--	--	\$17,049	
48		120	29	298	116	LKS48120-29TTRT	--	--	--	--	\$14,576	
48	108	29	275	105	LKS48108-29TTRT	--	--	--	--	\$13,315		

LOK- CONFERENCE

To Order Specify

① Veneer Model #	② Edge Detail	③ Wood Collection	④ Wood Finish	⑤ Electrical	⑥ Metal Color
Veneer (LKV)	See Edge Detail Options	Essentials	See Essentials Wood Finish Options	N None CT2 Dual Power Center Top CU2 Dual Power Underside CT2U1 Dual Power Center Top with Underside CT4U2 Four Power Center Top with Underside CT4 Four Power Center Top (See chart on previous page)	See Metal Finish Color Options
		Artisan	④ Wood Finish See Artisan Wood Finish Options		

① Solid Surface Model #	② Top Surface Selection	③ Electrical	④ Metal Color
Solid Surface (LKS)	See Solid Surface Top Surface Selection Options	N None CT2 Dual Power Center Top CU2 Dual Power Underside CT2U1 Dual Power Center Top with Underside CT4U2 Four Power Center Top with Underside CT4 Four Power Center Top (See chart on previous page)	See Metal Finish Color Options

Description

Rounded Rectangular Table with T Base at Working Height

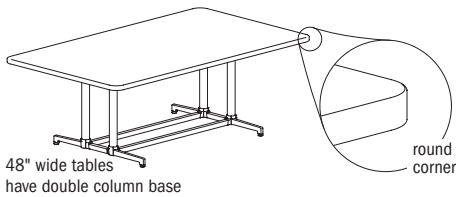

48" wide tables have double column base

D	W	H	CTN WT	CU FT	Model
48	96	29	204	105	LKT4896-29TTRT
48	84	29	183	83	LKT4884-29TTRT
42	96	29	164	73	LKT4296-29TTRT
42	84	29	162	72	LKT4284-29TTRT
36	96	29	145	72	LKT3696-29TTRT
36	84	29	151	64	LKT3684-29TTRT

LAMINATE

Laminate Tables "LKT" Models

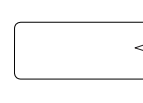

Eased Edge (R3)

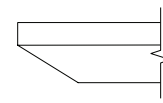

Reverse Bevel Edge (K9)

Eased Edge (R3)		Reverse Bevel Edge (K9)	
Standard Tier 1	Graded In Tier 2	Standard Tier 1	Graded In Tier 2
\$3,227	\$3,280	\$3,714	\$3,767
\$2,875	\$2,924	\$3,350	\$3,396
\$2,940	\$2,986	\$3,414	\$3,459
\$2,422	\$2,463	\$2,888	\$2,928
\$2,472	\$2,513	\$2,934	\$2,974
\$2,219	\$2,251	\$2,670	\$2,706

Features:

- price reflects complete table - top and base
- ships KD in multiple cartons
- one piece top
- model includes adjustable glide

Options:

- specify power/charging option, see below for options and upcharges

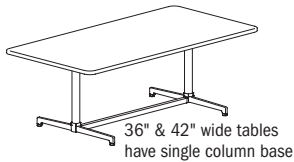

36" & 42" wide tables have single column base



top shape

LOK - CONFERENCE

To Order Specify

1 Laminates Model #	2 Edge Detail	3 Laminates Selection	3a PVC Edge Color	4 Electrical	5 Metal Color
Laminates (LKT)	See Edge Detail Options	See Laminates Selection	See PVC Edge Color Options	N None CT2 Dual Power Center Top CU2 Dual Power Underside CT2U1 Dual Power Center Top with Underside (See chart on next page)	See Metal Finish Color Options

Model Number Breakdown

LKT4896-29TTRT						
LK	T	4896	29	TT	R	T
LOK	Laminates	48" x 96"	Height	Rectangular Top Shape	Rounded Corner	T base

Description

Rounded Rectangular Table with T Base at Working Height (continued)

Veneer Tables "LKV" Models Solid Surface Tables "LKS" Models

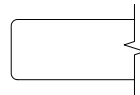

Eased Edge (R3)

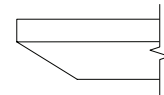

Reverse Bevel Edge (K9)

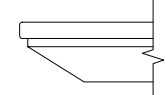

Reverse Bevel Edge (S7)

	D	W	H	CTN WT	CU FT	① Model	Veneer Tables "LKV" Models		Solid Surface Tables "LKS" Models		
							Essentials	Artisan	Essentials	Artisan	Standard
VENEER	48	96	29	204	105	LKV4896-29TTRT	\$4,496	\$4,846	\$4,817	\$5,138	--
	48	84	29	204	83	LKV4884-29TTRT	\$4,115	\$4,415	\$4,410	\$4,690	--
	42	96	29	183	83	LKV4296-29TTRT	\$4,394	\$4,747	\$4,789	\$5,100	--
	42	84	29	164	73	LKV4284-29TTRT	\$3,694	\$3,988	\$4,026	\$4,289	--
	36	96	29	162	72	LKV3696-29TTRT	\$3,345	\$3,611	\$3,644	\$3,882	--
	36	84	29	151	64	LKV3684-29TTRT	\$3,077	\$3,321	\$3,353	\$3,570	--
SOLID SURFACE	48	96	29	204	105	LKS4896-29TTRT	--	--	--	--	\$10,552
	48	84	29	183	83	LKS4884-29TTRT	--	--	--	--	\$9,368
	42	96	29	164	73	LKS4296-29TTRT	--	--	--	--	\$8,599
	42	84	29	162	72	LKS4284-29TTRT	--	--	--	--	\$7,579
	36	96	29	145	72	LKS3696-29TTRT	--	--	--	--	\$7,556
	36	84	29	151	64	LKS3684-29TTRT	--	--	--	--	\$6,810

Electrical Options and Upcharges

CT2	84 - 96 wide
Dual Power Center Top - Black	CT2BL - add \$1,535
Dual Power Center Top - White	CT2WH - add \$1,535
CU1	
Single Power Underside - Black	CU1-1C - add \$610
Single Power Underside with Wireless Charging - Black	CU1-1CW - add \$1,413
CT2U1	
Dual Power Center Top - Black with Single Underside	CT2U1-BL - add \$1,904
Dual Power Center Top - White with Single Underside	CT2U1-WH - add \$1,904
Dual Power Center Top - Black with Wireless Charging	CT2U1-BLW2 - add \$2,670
Dual Power Center Top - White with Wireless Charging	CT2U1-WHW2 - add \$2,670

Note: Order power infeed that best fits application

To Order Specify

① Veneer Model #	② Edge Detail	③ Wood Collection	④ Wood Finish	⑤ Electrical	⑥ Metal Color
Veneer (LKV)	See Edge Detail Options	Essentials	See Essentials Wood Finish Options	N None CT2 Dual Power Center Top CU2 Dual Power Underside CT2U1 Dual Power Center Top with Underside (See chart above)	See Metal Finish Color Options
		Artisan	④ Wood Finish See Artisan Wood Finish Options		

① Solid Surface Model #	② Top Surface Selection	③ Electrical	④ Metal Color
Solid Surface (LKS)	See Solid Surface Top Surface Selection Options	N None CT2 Dual Power Center Top CU2 Dual Power Underside CT2U1 Dual Power Center Top with Underside (See chart above)	See Metal Finish Color Options

LOK - CONFERENCE

Description

Rectangular Table 3pc with Y Base at Working Height

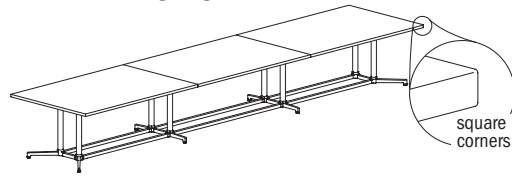

Laminate Tables "LKT" Models

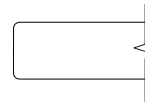

Eased Edge (R3)

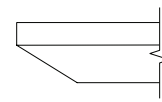

Reverse Bevel Edge (K9)

D	W	H	CTN WT	CU FT	Model	Eased Edge (R3)		Reverse Bevel Edge (K9)	
						Standard Tier 1	Graded In Tier 2	Standard Tier 1	Graded In Tier 2
60	240	29	653	281	LKT60240-29TTY	\$9,752	\$9,917	\$10,451	\$10,617
60	216	29	598	253	LKT60216-29TTY	\$8,112	\$8,259	\$8,778	\$8,928
54	240	29	584	254	LKT54240-29TTY	\$7,694	\$7,842	\$8,357	\$8,506
54	216	29	538	229	LKT54216-29TTY	\$6,873	\$7,006	\$7,510	\$7,642
48	240	29	545	228	LKT48240-29TTY	\$7,444	\$7,577	\$8,074	\$8,205
48	216	29	492	206	LKT48216-29TTY	\$6,513	\$6,631	\$7,118	\$7,237

Features:

- price reflects complete table - top and base
- ships KD in multiple cartons
- three piece top
- model includes adjustable glide

Options:

- specify power/charging option, see below for options and upcharges



top shape

LOK - CONFERENCE

To Order Specify

1 Laminate Model #	2 Edge Detail	3 Laminate Selection	4 PVC Edge Color	5 Electrical	6 Metal Color
Laminate (LKT)	See Edge Detail Options	See Laminate Selection	See PVC Edge Color Options	N None CT6 Six Power Center Top CU2 Dual Power Underside CT6U2 Six Power Center Top with Underside (See chart on next page)	See Metal Finish Color Options

Model Number Breakdown

LKT60240-29TTY					
LK	T	60240	29	TT	Y
LOK	Laminate	60" x 240"	Height	Rectangular Top Shape	Y base

Description

Rectangular Table 3pc with Y Base at Working Height (continued)

Veneer Tables "LKV" Models

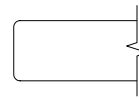

Eased Edge (R3)

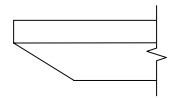

Reverse Bevel Edge (K9)

D	W	H	CTN WT	CU FT	Model	Eased Edge (R3)		Reverse Bevel Edge (K9)		
						Essentials	Artisan	Essentials	Artisan	
60	240	29	653	281	LKV60240-29TTY	\$15,196	\$16,411	\$16,564	\$17,640	
60	216	29	598	253	LKV60216-29TTY	\$13,292	\$14,356	\$14,491	\$15,429	
VENEER	54	240	29	584	254	LKV54240-29TTY	\$12,658	\$13,756	\$13,297	\$14,340
	54	216	29	538	229	LKV54216-29TTY	\$11,223	\$12,196	\$11,808	\$12,732
	48	240	29	545	228	LKV48240-29TTY	\$12,043	\$13,011	\$12,622	\$13,537
	48	216	29	492	206	LKV48216-29TTY	\$10,482	\$11,340	\$11,018	\$11,827

Electrical Options and Upcharges

	216 - 240 wide
CT6	
Six Power Center Top - Black	CT6BL - add \$4,137
Six Power Center Top - White	CT6WH - add \$4,137
CU2	
Dual Power Underside - Black	CU2-1C - add \$1,084
Dual Power Underside with 4 Wireless Charging - Black	CU2-1CW - add \$2,740
CT6U2	
Six Power Center Top - Black with Dual Underside	CT6U2-BL - add \$4,805
Six Power Center Top - White with Dual Underside	CT6U2-WH - add \$4,805
Six Power Center Top - Black Dual Underside with 4 Wireless Charging	CT6U2-BLW2 - add \$6,410
Six Power Center Top - White Dual Underside with 4 Wireless Charging	CT6U2-WHW2 - add \$6,410

Note: Order power infeed that best fits application

To Order Specify

1 Veneer Model #	2 Edge Detail	3 Wood Collection	4 Wood Finish	5 Electrical	6 Metal Color
Veneer (LKV)	See Edge Detail Options	Essentials	See Essentials Wood Finish Options	N None CT6 Six Power Center Top CU2 Dual Power Underside CT6U2 Six Power Center Top with Underside (See chart above)	See Metal Finish Color Options
		Artisan	4 Wood Finish See Artisan Wood Finish Options		

LOK - CONFERENCE

Description

Rectangular 2pc Table with Y Base at Working Height

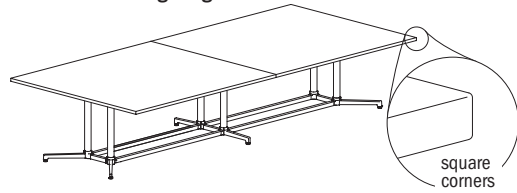

Laminate Tables "LKT" Models

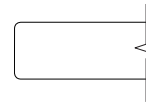

Eased Edge (R3)

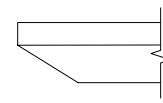

Reverse Bevel Edge (K9)

D	W	H	CTN WT	CU FT	Model	Eased Edge (R3)		Reverse Bevel Edge (K9)		
						Standard Tier 1	Graded In Tier 2	Standard Tier 1	Graded In Tier 2	
60	192	29	513	226	LKT60192-29TTY	\$6,939	\$7,070	\$7,575	\$7,705	
60	168	29	460	198	LKT60168-29TTY	\$6,458	\$6,576	\$7,065	\$7,180	
60	144	29	345	169	LKT60144-29TTY	\$5,897	\$5,996	\$6,474	\$6,571	
60	120	29	342	143	LKT60120-29TTY	\$5,203	\$5,287	\$5,749	\$5,828	
LAMINATE	54	192	29	462	204	LKT54192-29TTY	\$6,583	\$6,701	\$7,191	\$7,310
	54	168	29	368	178	LKT54168-29TTY	\$5,861	\$5,966	\$6,442	\$6,546
	54	144	29	365	154	LKT54144-29TTY	\$5,331	\$5,419	\$5,886	\$5,973
	54	120	29	316	130	LKT54120-29TTY	\$4,888	\$4,961	\$5,415	\$5,488
48	192	29	422	183	LKT48192-29TTY	\$6,409	\$6,516	\$6,990	\$7,095	
48	168	29	375	161	LKT48168-29TTY	\$5,186	\$5,276	\$5,743	\$5,835	
48	144	29	333	139	LKT48144-29TTY	\$4,806	\$4,887	\$5,341	\$5,419	
48	120	29	291	116	LKT48120-29TTY	\$4,346	\$4,411	\$4,856	\$4,923	
48	108	29	269	105	LKT48108-29TTY	\$3,868	\$3,926	\$4,367	\$4,426	

Features:

- price reflects complete table - top and base
- ships KD in multiple cartons
- two piece top
- model includes adjustable glide

Options:

- specify power/charging option, see below for options and upcharges

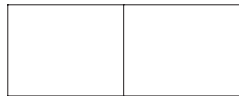

top shape

LOK - CONFERENCE

To Order Specify

1 Laminate Model #	2 Edge Detail	3 Laminate Selection	3a PVC Edge Color	4 Electrical	5 Metal Color
Laminate (LKT)	See Edge Detail Options	See Laminate Selection	See PVC Edge Color Options	N None CT2 Dual Power Center Top CU2 Dual Power Underside CT2U1 Dual Power Center Top with Underside CT4U2 Four Power Center Top with Underside CT4 Four Power Center Top (See chart on next page)	See Metal Finish Color Options

Model Number Breakdown

LKT60192-29TTY					
LK	T	60192	29	TT	Y
LOK	Laminate	60" x 192"	Height	Rectangular Top Shape	Y base

Description

Rectangular 2pc Table with Y Base at Working Height (continued)

Veneer Tables "LKV" Models

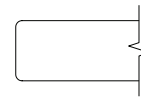

Eased Edge (R3)

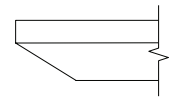

Reverse Bevel Edge (K9)

D	W	H	CTN WT	CU FT	Model	Eased Edge (R3)		Reverse Bevel Edge (K9)		
						Essentials	Artisan	Essentials	Artisan	
60	192	29	513	226	LKV60192-29TTY	\$10,640	\$11,491	\$11,597	\$12,351	
60	168	29	460	198	LKV60168-29TTY	\$9,754	\$10,535	\$10,632	\$11,322	
60	144	29	345	169	LKV60144-29TTY	\$8,778	\$9,481	\$9,569	\$10,189	
60	120	29	342	143	LKV60120-29TTY	\$7,871	\$8,499	\$8,577	\$9,135	
VENEER	54	192	29	462	204	LKV54192-29TTY	\$9,864	\$10,654	\$10,751	\$11,451
	54	168	29	368	178	LKV54168-29TTY	\$8,884	\$9,595	\$9,684	\$10,313
	54	144	29	365	154	LKV54144-29TTY	\$7,975	\$8,613	\$8,693	\$9,258
	54	120	29	316	130	LKV54120-29TTY	\$7,214	\$7,790	\$7,862	\$8,372
48	192	29	422	183	LKV48192-29TTY	\$9,801	\$10,549	\$10,290	\$10,996	
48	168	29	375	161	LKV48168-29TTY	\$7,919	\$8,564	\$8,365	\$8,973	
48	144	29	333	139	LKV48144-29TTY	\$7,243	\$7,787	\$7,649	\$8,158	
48	120	29	291	116	LKV48120-29TTY	\$6,476	\$6,924	\$6,839	\$7,258	
48	108	29	269	105	LKV48108-29TTY	\$5,557	\$6,002	\$6,059	\$6,451	

Electrical Options and Upcharges

CT4	120 - 192 wide
	Four Power Center Top - Black CT4BL - add \$3,265
	Four Power Center Top - White CT4WH - add \$3,265
CU1	Single Power Underside - Black CU1-1C - add \$709
	Single Power Underside with Wireless Charging - Black CU1-1CW - add \$1,484
	CT4U1
CT4U1	Four Power Center Top with Underside - Black CT4U1-BL - add \$3,265
	Four Power Center Top with Underside - White CT4U1-WH - add \$3,265
	Four Power Center Top - Black with Underside & 2 Wireless Charging CT4U1-BLW2 - add \$4,046
	Four Power Center Top - White with Underside & 2 Wireless Charging CT4U1-WHW2 - add \$4,046

Note: Order power infeed that best fits application, see page 408.

To Order Specify

1 Veneer Model #	2 Edge Detail	3 Wood Collection	4 Wood Finish	5 Electrical	6 Metal Color
Veneer (LKV)	See Edge Detail Options	Essentials	See Essentials Wood Finish Options	N None CT2 Dual Power Center Top CU2 Dual Power Underside CT2U1 Dual Power Center Top with Underside CT4U2 Four Power Center Top with Underside CT4 Four Power Center Top	See Metal Finish Color Options
		Artisan	4 Wood Finish See Artisan Wood Finish Options		

LOK - CONFERENCE

Description

Rectangular Table with Y Base at Working Height

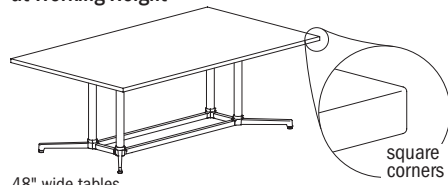

48" wide tables have double column base

D	W	H	CTN WT	CU FT	Model	Laminate Tables "LKT" Models			
						Eased Edge (R3)		Reverse Bevel Edge (K9)	
						Standard Tier 1	Graded In Tier 2	Standard Tier 1	Graded In Tier 2
48	96	29	225	105	LKT4896-29TTY	\$3,192	\$3,245	\$3,680	\$3,734
48	84	29	333	83	LKT4884-29TTY	\$2,799	\$2,844	\$3,276	\$3,320
42	96	29	174	83	LKT4296-29TTY	\$3,043	\$3,088	\$3,517	\$3,563
42	84	29	174	72	LKT4284-29TTY	\$2,545	\$2,584	\$3,009	\$3,048
36	96	29	152	72	LKT3696-29TTY	\$2,428	\$2,470	\$2,891	\$2,931
36	84	29	156	64	LKT3684-29TTY	\$2,220	\$2,255	\$2,672	\$2,707

LAMINATE

Features:

- price reflects complete table - top and base
- ships KD in multiple cartons
- one piece top
- model includes adjustable glide

Options:

- specify power/charging option, see below for options and upcharges

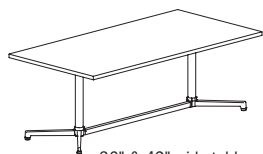

36" & 42" wide tables have single column base



top shape

LOK - CONFERENCE

To Order Specify

1 Laminate Model #	2 Edge Detail	3 Laminate Selection	3a PVC Edge Color	4 Electrical	5 Metal Color
Laminate (LKT)	See Edge Detail Options	See Laminate Selection	See PVC Edge Color Options	N None CT2 Dual Power Center Top CU2 Dual Power Underside CT2U1 Dual Power Center Top with Underside (See chart on next page)	See Metal Finish Color Options

Model Number Breakdown

LKT4896-29TTY					
LK	T	4896	29	TT	Y
LOK	Laminate	48" x 96"	Height	Rectangular Top Shape	Y base

Description

Rectangular Table with Y Base
at Working Height
(continued)

Veneer Tables
"LKV" Models

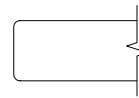

Eased Edge (R3)

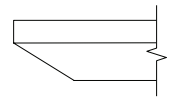

Reverse Bevel Edge (K9)

VENEER	D	W	H	CTN WT	CU FT	1 Model	Essentials	Artisan	Essentials	Artisan
		48	96	29	225	105	LKV4896-29TTY	\$4,454	\$4,801	\$4,772
	48	84	29	333	83	LKV4884-29TTY	\$4,019	\$4,319	\$4,316	\$4,595
	42	96	29	174	83	LKV4296-29TTY	\$4,524	\$4,887	\$4,930	\$5,251
	42	84	29	174	72	LKV4284-29TTY	\$3,843	\$4,150	\$4,188	\$4,459
	36	96	29	152	72	LKV3696-29TTY	\$3,290	\$3,554	\$3,587	\$3,819
	36	84	29	156	64	LKV3684-29TTY	\$3,078	\$3,323	\$3,355	\$3,573

Electrical Options and Upcharges

CT2	84 - 96 wide
Dual Power Center Top - Black	CT2BL - add \$1,535
Dual Power Center Top - White	CT2WH - add \$1,535
CU1	
Single Power Underside - Black	CU1-1C - add \$610
Single Power Underside with Wireless Charging - Black	CU1-1CW - add \$1,413
CT2U1	
Dual Power Center Top - Black with Single Underside	CT2U1-BL - add \$1,904
Dual Power Center Top - White with Single Underside	CT2U1-WH - add \$1,904
Dual Power Center Top - Black with Wireless Charging	CT2U1-BLW2 - add \$2,670
Dual Power Center Top - White with Wireless Charging	CT2U1-WHW2 - add \$2,670

Note: Order power infed that best fits application

To Order Specify

1 Veneer Model #	2 Edge Detail	3 Wood Collection	4 Wood Finish	5 Electrical	6 Metal Color
Veneer (LKV)	See Edge Detail Options	Essentials	See Essentials Wood Finish Options	N None CT2 Dual Power Center Top CU2 Dual Power Underside CT2U1 Dual Power Center Top with Underside (See chart above)	See Metal Finish Color Options
		Artisan	4 Wood Finish See Artisan Wood Finish Options		

Description

Rounded Rectangular 3pc Table with Y Base at Working Height

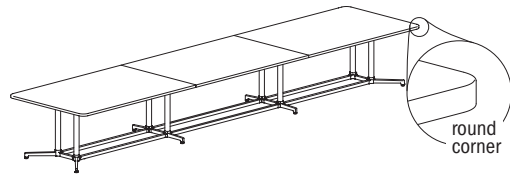

Laminate Tables
"LKT" Models

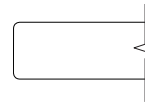

Eased Edge (R3)

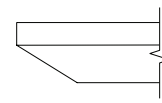

Reverse Bevel Edge (K9)

LAMINATE	D	W	H	CTN WT	CU FT	1 Model	Standard Tier 1	Graded In Tier 2	Standard Tier 1	Graded In Tier 2
	60	240	29	653	281	LKT60240-29TTRY	\$9,940	\$10,102	\$10,637	\$10,801
	60	216	29	598	253	LKT60216-29TTRY	\$8,404	\$8,554	\$9,073	\$9,222
54	240	29	584	254	LKT54240-29TTRY	\$7,864	\$8,011	\$8,527	\$8,675	
54	216	29	538	229	LKT54216-29TTRY	\$7,029	\$7,163	\$7,666	\$7,800	
48	240	29	545	228	LKT48240-29TTRY	\$7,598	\$7,732	\$8,227	\$8,359	
48	216	29	492	206	LKT48216-29TTRY	\$7,042	\$7,161	\$7,651	\$7,768	

Features:

- price reflects complete table - top and base
- ships KD in multiple cartons
- three piece top
- model includes adjustable glide

Options:

- specify power/charging option, see below for options and upcharges



top shape

LOK - CONFERENCE

To Order Specify

1 Laminate Model #	2 Edge Detail	3 Laminate Selection	3a PVC Edge Color	4 Electrical	5 Metal Color
Laminate (LKT)	See Edge Detail Options	See Laminate Selection	See PVC Edge Color Options	N None CT6 Six Power Center Top CU2 Dual Power Underside CT6U2 Six Power Center Top with Underside (See chart on next page)	See Metal Finish Color Options

Model Number Breakdown

LKT60240-29TTRY						
LK	T	60240	29	TT	R	Y
LOK	Laminate	60" x 240"	Height	Rectangular Top Shape	Rounded Corner	Y base

Description

Rounded Rectangular 3pc Table with Y Base at Working Height (continued)

Veneer Tables "LKV" Models

Solid Surface Tables "LKS" Models

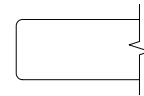

Eased Edge (R3)

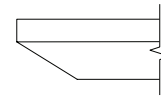

Reverse Bevel Edge (K9)

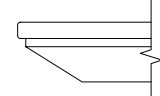

Reverse Bevel Edge (S7)

	D	W	H	CTN WT	CU FT	① Model	Veneer Tables		Solid Surface Tables		
							Essentials	Artisan	Essentials	Artisan	Standard
VENEER	60	240	29	653	281	LKV60240-29TTRY	\$15,475	\$16,712	\$16,868	\$17,963	--
	60	216	29	598	253	LKV60216-29TTRY	\$13,543	\$14,626	\$14,760	\$15,721	--
	54	240	29	584	254	LKV54240-29TTRY	\$12,909	\$14,008	\$13,547	\$14,589	--
	54	216	29	538	229	LKV54216-29TTRY	\$11,451	\$12,423	\$12,038	\$12,960	--
	48	240	29	545	228	LKV48240-29TTRY	\$12,269	\$13,235	\$12,846	\$13,761	--
	48	216	29	492	206	LKV48216-29TTRY	\$11,240	\$12,095	\$11,772	\$12,581	--
SOLID SURFACE	60	240	29	653	281	LKS60240-29TTRY	--	--	--	--	\$35,344
	60	216	29	598	253	LKS60216-29TTRY	--	--	--	--	\$31,880
	54	240	29	584	254	LKS54240-29TTRY	--	--	--	--	\$31,996
	54	216	29	538	229	LKS54216-29TTRY	--	--	--	--	\$28,405
	48	240	29	545	228	LKS48240-29TTRY	--	--	--	--	\$29,028
	48	216	29	492	206	LKS48216-29TTRY	--	--	--	--	\$26,130

Electrical Options and Upcharges

	216 - 240 wide
CT6	
Six Power Center Top - Black	CT6BL - add \$4,137
Six Power Center Top - White	CT6WH - add \$4,137
CU2	
Dual Power Underside - Black	CU2-1C - add \$1,084
Dual Power Underside with 4 Wireless Charging - Black	CU2-1CW - add \$2,740
CT6U2	
Six Power Center Top - Black with Dual Underside	CT6U2-BL - add \$4,805
Six Power Center Top - White with Dual Underside	CT6U2-WH - add \$4,805
Six Power Center Top - Black Dual Underside with 4 Wireless Charging	CT6U2-BLW2 - add \$6,410
Six Power Center Top - White Dual Underside with 4 Wireless Charging	CT6U2-WHW2 - add \$6,410

LOK - CONFERENCE

To Order Specify

Note: Order power infed that best fits application

① Veneer Model #	② Edge Detail	③ Wood Collection	④ Wood Finish	⑤ Electrical	⑥ Metal Color
Veneer (LKV)	See Edge Detail Options	Essentials	See Essentials Wood Finish Options	N None CT6 Six Power Center Top CU2 Dual Power Underside CT6U2 Six Power Center Top with Underside (See chart above)	See Metal Finish Color Options
		Artisan	④ Wood Finish See Artisan Wood Finish Options		

① Solid Surface Model #	② Top Surface Selection	③ Electrical	④ Metal Color
Solid Surface (LKS)	See Solid Surface Top Surface Selection Options	N None CT6 Six Power Center Top CU2 Dual Power Underside CT6U2 Six Power Center Top with Underside (See chart above)	See Metal Finish Color Options

Description

Rounded Rectangular 2pc Table with Y Base at Working Height

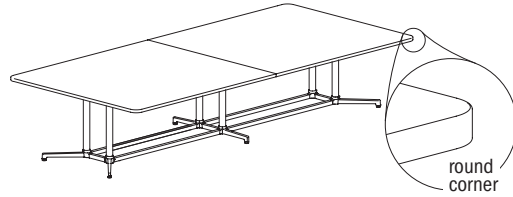

Laminate Tables "LKT" Models

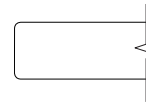

Eased Edge (R3)

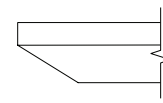

Reverse Bevel Edge (K9)

LAMINATE	D	W	H	CTN WT	CU FT	Model	Standard Tier 1	Graded In Tier 2	Standard Tier 1	Graded In Tier 2
		60	192	29	513	226	LKT60192-29TTRY	\$6,951	\$7,082	\$7,586
	60	168	29	460	198	LKT60168-29TTRY	\$6,457	\$6,573	\$7,063	\$7,179
	60	144	29	345	169	LKT60144-29TTRY	\$5,883	\$5,981	\$6,456	\$6,555
	60	120	29	342	143	LKT60120-29TTRY	\$5,299	\$5,380	\$5,844	\$5,926
	54	192	29	462	204	LKT54192-29TTRY	\$6,708	\$6,826	\$7,318	\$7,435
	54	168	29	368	178	LKT54168-29TTRY	\$5,973	\$6,077	\$6,555	\$6,659
	54	144	29	365	154	LKT54144-29TTRY	\$5,431	\$5,519	\$5,987	\$6,073
	54	120	29	316	130	LKT54120-29TTRY	\$4,976	\$5,050	\$5,504	\$5,578
	48	192	29	422	183	LKT48192-29TTRY	\$6,523	\$6,630	\$7,104	\$7,209
	48	168	29	375	161	LKT48168-29TTRY	\$5,290	\$5,380	\$5,847	\$5,937
	48	144	29	333	139	LKT48144-29TTRY	\$4,899	\$4,978	\$5,435	\$5,514
	48	120	29	291	116	LKT48120-29TTRY	\$4,427	\$4,494	\$4,939	\$5,004
	48	108	29	269	105	LKT48108-29TTRY	\$3,944	\$4,004	\$4,444	\$4,502

Features:

- price reflects complete table - top and base
- ships KD in multiple cartons
- two piece top
- model includes adjustable glide

Options:

- specify power/charging option, see below for options and upcharges

Electrical Options and Upcharges

	108 wide	120 - 192 wide
CT2		
Dual Power Center Top - Black	CT2BL - add \$1,535	n/a
Dual Power Center Top - White	CT2WH - add \$1,535	n/a
CU1		
Single Power Underside - Black	CU1-1C - add \$610	CU1-1C - add \$709
Single Power Underside with Wireless Charging - Black	CU1-1CW - add \$1,413	CU1-1CW - add \$1,484
CT2U1		
Dual Power Center Top - Black with Underside	CT2U1-BL - add \$1,868	n/a
Dual Power Center Top - White with Underside	CT2U1-WH - add \$1,868	n/a
Dual Power Center Top - Black with Wireless Charging	CT2U1-BLW2 - add \$2,670	n/a
Dual Power Center Top - White with Wireless Charging	CT2U1-WHW2 - add \$2,670	n/a

Note: Order power infeed that best fits application.

	108 wide	120 - 192 wide
CT4U1		
Four Power Center Top with Single Underside - Black	n/a	CT4U1-BL - add \$3,265
Four Power Center Top with Single Underside - White	n/a	CT4U1-WH - add \$3,265
Four Power Center Top - Black with Underside & Wireless Charging	n/a	CT4U1-BLW2 - add \$4,046
Four Power Center Top - White with Underside & Wireless Charging	n/a	CT4U1-WHW2 - add \$4,046
CT4		
Four Power Center Top - Black	n/a	CT4BL - add \$2,859
Four Power Center Top - White	n/a	CT4WH - add \$2,859



top shape

To Order Specify

1 Laminate Model #	2 Edge Detail	3 Laminate Selection	3a PVC Edge Color	4 Electrical	5 Metal Color
Laminate (LKT)	See Edge Detail Options	See Laminate Selection	See PVC Edge Color Options	N None CT2 Dual Power Center Top CU2 Dual Power Underside CT2U1 Dual Power Center Top with Underside CT4U2 Four Power Center Top with Underside CT4 Four Power Center Top (See chart above)	See Metal Finish Color Options

Model Number Breakdown

LKT60192-29TTRY						
LK	T	60192	29	TT	R	Y
LOK	Laminate	60" x 192"	Height	Rectangular Top Shape	Rounded Corner	Y base

Description

Rounded Rectangular 2pc Table with Y Base at Working Height (continued)

Veneer Tables "LKV" Models

Solid Surface Tables "LKS" Models

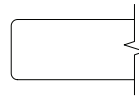

Eased Edge (R3)

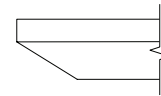

Reverse Bevel Edge (K9)

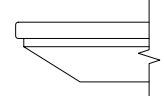

Reverse Bevel Edge (S7)

	D	W	H	CTN WT	CU FT	① Model	Veneer Tables "LKV" Models		Solid Surface Tables "LKS" Models			
							Essentials	Artisan	Essentials	Artisan	Standard	
VENEER	60	192	29	513	226	LKV60192-29TTRY	\$10,837	\$11,704	\$11,813	\$12,580	--	
	60	168	29	460	198	LKV60168-29TTRY	\$9,929	\$10,723	\$10,824	\$11,526	--	
	60	144	29	345	169	LKV60144-29TTRY	\$8,932	\$9,645	\$9,735	\$10,366	--	
	60	120	29	342	143	LKV60120-29TTRY	\$8,001	\$8,639	\$8,718	\$9,286	--	
	54	192	29	462	204	LKV54192-29TTRY	\$10,041	\$10,845	\$10,945	\$11,655	--	
	54	168	29	368	178	LKV54168-29TTRY	\$9,043	\$9,767	\$9,856	\$10,497	--	
	54	144	29	365	154	LKV54144-29TTRY	\$8,114	\$8,763	\$8,844	\$9,420	--	
	54	120	29	316	130	LKV54120-29TTRY	\$7,334	\$7,919	\$7,995	\$8,511	--	
	48	192	29	422	183	LKV48192-29TTRY	\$9,960	\$10,709	\$10,450	\$11,158	--	
	48	168	29	389	161	LKV48168-29TTRY	\$8,062	\$8,707	\$8,508	\$9,115	--	
	48	144	29	333	139	LKV48144-29TTRY	\$7,368	\$7,913	\$7,771	\$8,286	--	
	48	120	29	291	116	LKV48120-29TTRY	\$6,583	\$7,032	\$6,948	\$7,369	--	
	48	108	29	269	105	LKV48108-29TTRY	\$5,657	\$6,109	\$6,166	\$6,567	--	
	SOLID SURFACE	60	192	29	513	226	LKS60192-29TTRY	--	--	--	--	\$26,626
		60	168	29	460	198	LKS60168-29TTRY	--	--	--	--	\$23,473
		60	144	29	345	169	LKS60144-29TTRY	--	--	--	--	\$20,304
60		120	29	342	143	LKS60120-29TTRY	--	--	--	--	\$22,404	
54		192	29	462	204	LKS54192-29TTRY	--	--	--	--	\$24,229	
54		168	29	368	178	LKS54168-29TTRY	--	--	--	--	\$21,366	
54		144	29	365	154	LKS54144-29TTRY	--	--	--	--	\$18,513	
54		120	29	316	130	LKS54120-29TTRY	--	--	--	--	\$15,866	
48		192	29	422	183	LKS48192-29TTRY	--	--	--	--	\$22,853	
48		168	29	375	161	LKS48168-29TTRY	--	--	--	--	\$19,213	
48		144	29	333	139	LKS48144-29TTRY	--	--	--	--	\$16,832	
48		120	29	291	116	LKS48120-29TTRY	--	--	--	--	\$14,418	
48		108	29	269	105	LKS48108-29TTRY	--	--	--	--	\$13,436	

LOK- CONFERENCE

To Order Specify

① Veneer Model #	② Edge Detail	③ Wood Collection	④ Wood Finish	⑤ Electrical	⑥ Metal Color
Veneer (LKV)	See Edge Detail Options	Essentials	See Essentials Wood Finish Options	N None CT2 Dual Power Center Top CU2 Dual Power Underside CT2U1 Dual Power Center Top with Underside CT4U2 Four Power Center Top with Underside CT4 Four Power Center Top (See chart on previous page)	See Metal Finish Color Options
		Artisan	④ Wood Finish See Artisan Wood Finish Options		

① Solid Surface Model #	② Top Surface Selection	③ Electrical	④ Metal Color
Solid Surface (LKS)	See Solid Surface Top Surface Selection Options	N None CT2 Dual Power Center Top CU2 Dual Power Underside CT2U1 Dual Power Center Top with Underside CT4U2 Four Power Center Top with Underside CT4 Four Power Center Top (See chart on previous page)	See Metal Finish Color Options

Description

Rounded Rectangular Table with Y Base at Working Height

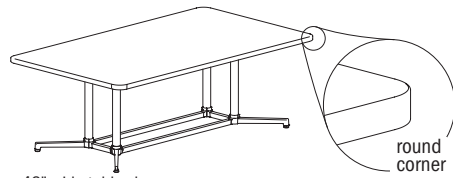

48" wide tables have double column base

LAMINATE	D	W	H	CTN WT	CU FT	Model	Laminate Tables "LKT" Models			
							Eased Edge (R3)		Reverse Bevel Edge (K9)	
							Standard Tier 1	Graded In Tier 2	Standard Tier 1	Graded In Tier 2
	48	96	29	225	105	LKT4896-29TTRY	\$3,258	\$3,310	\$3,744	\$3,796
	48	84	29	333	83	LKT4884-29TTRY	\$2,859	\$2,905	\$3,333	\$3,382
	42	96	29	174	83	LKT4296-29TTRY	\$3,102	\$3,149	\$3,575	\$3,624
	42	84	29	174	72	LKT4284-29TTRY	\$2,599	\$2,639	\$3,063	\$3,105
	36	96	29	152	72	LKT3696-29TTRY	\$2,485	\$2,524	\$2,945	\$2,984
	36	84	29	156	64	LKT3684-29TTRY	\$2,271	\$2,307	\$2,724	\$2,758

Features:

- price reflects complete table - top and base
- ships KD in multiple cartons
- one piece top
- model includes adjustable glide

Options:

- specify power/charging option, see below for options and upcharges

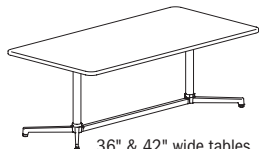

36" & 42" wide tables have single column base



top shape

To Order Specify

1 Laminata Model #	2 Edge Detail	3 Laminata Selection	3a PVC Edge Color	4 Electrical	5 Metal Color
Laminata (LKT)	See Edge Detail Options	See Laminata Selection	See PVC Edge Color Options	N None CT2 Dual Power Center Top CU2 Dual Power Underside CT2U1 Dual Power Center Top with Underside (See chart on next page)	See Metal Finish Color Options

Model Number Breakdown

LKT4896-29TTRY						
LK	T	4896	29	TT	R	Y
LOK	Laminata	48" x 96"	Height	Rectangular Top Shape	Rounded Corner	Y base

Description

Rounded Rectangular Table with Y Base at Working Height (continued)

Veneer Tables "LKV" Models Solid Surface Tables "LKS" Models

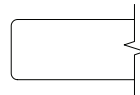

Eased Edge (R3)

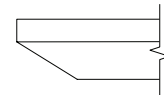

Reverse Bevel Edge (K9)

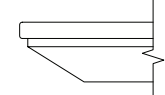

Reverse Bevel Edge (S7)

	D	W	H	CTN WT	CU FT	① Model	Veneer Tables "LKV" Models		Solid Surface Tables "LKS" Models		
							Essentials	Artisan	Essentials	Artisan	Standard
VENEER	48	96	29	225	105	LKV4896-29TTRY	\$4,536	\$4,884	\$4,853	\$5,179	--
	48	84	29	333	83	LKV4884-29TTRY	\$4,092	\$4,392	\$4,389	\$4,669	--
	42	96	29	174	83	LKV4296-29TTRY	\$4,598	\$4,965	\$5,011	\$5,338	--
	42	84	29	174	72	LKV4284-29TTRY	\$3,910	\$4,223	\$4,262	\$4,539	--
	36	96	29	152	72	LKV3696-29TTRY	\$3,358	\$3,627	\$3,661	\$3,898	--
	36	84	29	156	64	LKV3684-29TTRY	\$3,141	\$3,392	\$3,423	\$3,644	--
SOLID SURFACE	48	96	29	225	105	LKS4896-29TTRY	--	--	--	--	\$10,592
	48	84	29	333	83	LKS4884-29TTRY	--	--	--	--	\$9,350
	42	96	29	174	83	LKS4296-29TTRY	--	--	--	--	\$8,801
	42	84	29	174	72	LKS4284-29TTRY	--	--	--	--	\$7,793
	36	96	29	152	72	LKS3696-29TTRY	--	--	--	--	\$7,568
	36	84	29	156	64	LKS3684-29TTRY	--	--	--	--	\$6,875

Electrical Options and Upcharges

CT2	84 - 96 wide
Dual Power Center Top - Black	CT2BL - add \$1,535
Dual Power Center Top - White	CT2WH - add \$1,535
CU1	
Single Power Underside - Black	CU1-1C - add \$610
Single Power Underside with Wireless Charging - Black	CU1-1CW - add \$1,413
CT2U1	
Dual Power Center Top - Black with Single Underside	CT2U1-BL - add \$1,904
Dual Power Center Top - White with Single Underside	CT2U1-WH - add \$1,904
Dual Power Center Top - Black with Wireless Charging	CT2U1-BLW2 - add \$2,670
Dual Power Center Top - White with Wireless Charging	CT2U1-WhW2 - add \$2,670

LOK - CONFERENCE

Note: Order power infeed that best fits application

To Order Specify

① Veneer Model #	② Edge Detail	③ Wood Collection	④ Wood Finish	⑤ Electrical	⑥ Metal Color
Veneer (LKV)	See Edge Detail Options	Essentials	See Essentials Wood Finish Options	N None CT2 Dual Power Center Top CU2 Dual Power Underside CT2U1 Dual Power Center Top with Underside (See chart above)	See Metal Finish Color Options
		Artisan	④ Wood Finish See Artisan Wood Finish Options		

① Solid Surface Model #	② Top Surface Selection	③ Electrical	④ Metal Color
Solid Surface (LKS)	See Solid Surface Top Surface Selection Options	N None CT2 Dual Power Center Top CU2 Dual Power Underside CT2U1 Dual Power Center Top with Underside (See chart above)	See Metal Finish Color Options

Description

Arc Rectangular 3pc Table with T Base at Working Height

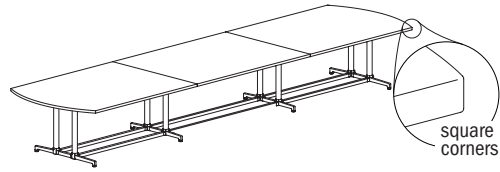

Laminate Tables
"LKT" Models

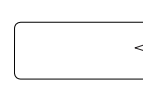

Eased Edge (R3)

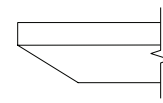

Reverse Bevel Edge (K9)

D	W	H	CTN WT	CU FT	① Model	Eased Edge (R3)		Reverse Bevel Edge (K9)	
						Standard Tier 1	Graded In Tier 2	Standard Tier 1	Graded In Tier 2
60	240	29	648	281	LKT60240-29ART	\$10,259	\$10,426	\$10,959	\$11,124
60	216	29	593	253	LKT60216-29ART	\$8,745	\$8,892	\$9,414	\$9,563
54	240	29	598	254	LKT54240-29ART	\$8,276	\$8,423	\$8,940	\$9,088
54	216	29	549	229	LKT54216-29ART	\$7,842	\$7,975	\$8,480	\$8,613
48	240	29	548	228	LKT48240-29ART	\$7,883	\$8,016	\$8,513	\$8,644
48	216	29	549	206	LKT48216-29ART	\$6,974	\$7,093	\$7,581	\$7,700

LAMINATE

Features:

- price reflects complete table - top and base
- ships KD in multiple cartons
- three piece top
- model includes adjustable glide

Options:

- specify power/charging option, see below for options and upcharges



top shape

LOK - CONFERENCE

To Order Specify

① Laminate Model #	② Edge Detail	③ Laminate Selection	④ PVC Edge Color	⑤ Electrical	⑥ Metal Color
Laminate (LKT)	See Edge Detail Options	See Laminate Selection	See PVC Edge Color Options	N None CT6 Six Power Center Top CU2 Dual Power Underside CT6U2 Six Power Center Top with Underside (See chart on next page)	See Metal Finish Color Options

Model Number Breakdown

LKT60240-29ART					
LK	T	60240	29	TT	T
LOK	Laminate	60" x 240"	Height	Rectangular Top Shape	T base

Description

Arc Rectangular 3pc Table with T Base at Working Height (continued)

Veneer Tables "LKV" Models

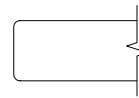

Eased Edge (R3)

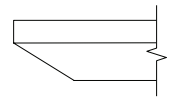

Reverse Bevel Edge (K9)

VENEER	D	W	H	CTN WT	CU FT	Model	Essentials	Artisan	Essentials	Artisan
		60	240	29	648	281	LKV60240-29ART	\$15,957	\$17,234	\$17,393
	60	216	29	593	253	LKV60216-29ART	\$14,046	\$15,169	\$15,309	\$16,305
	54	240	29	598	254	LKV54240-29ART	\$13,519	\$14,614	\$14,156	\$15,197
	54	216	29	549	229	LKV54216-29ART	\$12,631	\$13,603	\$13,215	\$14,139
	48	240	29	548	228	LKV48240-29ART	\$12,683	\$13,649	\$13,263	\$14,175
	48	216	29	549	206	LKV48216-29ART	\$11,140	\$11,998	\$11,675	\$12,484

Electrical Options and Upcharges

	216 - 240 wide
CT6	
Six Power Center Top - Black	CT6BL - add \$4,137
Six Power Center Top - White	CT6WH - add \$4,137
CU2	
Dual Power Underside - Black	CU2-1C - add \$1,084
Dual Power Underside with 4 Wireless Charging - Black	CU2-1CW - add \$2,740
CT6U2	
Six Power Center Top - Black with Dual Underside	CT6U2-BL - add \$4,805
Six Power Center Top - White with Dual Underside	CT6U2-WH - add \$4,805
Six Power Center Top- Black Dual Underside with 4 Wireless Charging	CT6U2-BLW2 - add \$6,410
Six Power Center Top- White Dual Underside with 4 Wireless Charging	CT6U2-WHW2 - add \$6,410

Note: Order power infeed that best fits application

To Order Specify

1 Veneer Model #	2 Edge Detail	3 Wood Collection	4 Wood Finish	5 Electrical	6 Metal Color
Veneer (LKV)	See Edge Detail Options	Essentials	See Essentials Wood Finish Options	N None CT6 Six Power Center Top CU2 Dual Power Underside CT6U2 Six Power Center Top with Underside (See chart above)	See Metal Finish Color Options
		Artisan	4 Wood Finish See Artisan Wood Finish Options		

LOK- CONFERENCE

Description

Arc Rectangular 2pc Table with T Base at Working Height

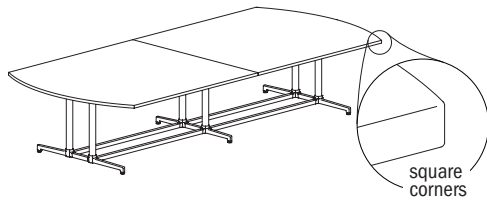

Laminate Tables "LKT" Models

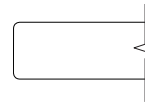

Eased Edge (R3)

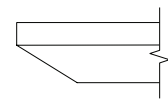

Reverse Bevel Edge (K9)

D	W	H	CTN WT	CU FT	Model	Eased Edge (R3)		Reverse Bevel Edge (K9)	
						Standard Tier 1	Graded In Tier 2	Standard Tier 1	Graded In Tier 2
60	192	29	507	226	LKT60192-29ART	\$7,146	\$7,280	\$7,781	\$7,913
60	168	29	453	198	LKT60168-29ART	\$6,669	\$6,784	\$7,273	\$7,389
60	144	29	396	169	LKT60144-29ART	\$6,153	\$6,251	\$6,728	\$6,826
60	120	29	339	143	LKT60120-29ART	\$5,455	\$5,537	\$6,000	\$6,082
LAMINATE									
54	192	29	467	204	LKT54192-29ART	\$6,800	\$6,920	\$7,408	\$7,527
54	168	29	389	178	LKT54168-29ART	\$6,159	\$6,264	\$6,743	\$6,845
54	144	29	368	154	LKT54144-29ART	\$5,674	\$5,764	\$6,230	\$6,319
54	120	29	316	130	LKT54120-29ART	\$5,083	\$5,157	\$5,608	\$5,683
48	192	29	429	183	LKT48192-29ART	\$5,933	\$6,039	\$6,515	\$6,620
48	168	29	385	161	LKT48168-29ART	\$5,516	\$5,608	\$6,073	\$6,166
48	144	29	339	139	LKT48144-29ART	\$5,060	\$5,139	\$5,594	\$5,674
48	120	29	293	116	LKT48120-29ART	\$4,547	\$4,613	\$5,058	\$5,125
48	108	29	270	105	LKT48108-29ART	\$3,852	\$3,910	\$4,349	\$4,409

Features:

- price reflects complete table - top and base
- ships KD in multiple cartons
- two piece top
- model includes adjustable glide

Options:

- specify power/charging option, see below for options and upcharges

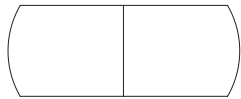

top shape

LOK - CONFERENCE

To Order Specify

1 Laminate Model #	2 Edge Detail	3 Laminate Selection	3a PVC Edge Color	4 Electrical	5 Metal Color
Laminate (LKT)	See Edge Detail Options	See Laminate Selection	See PVC Edge Color Options	N None CT2 Dual Power Center Top CU2 Dual Power Underside CT2U1 Dual Power Center Top with Underside CT4U2 Four Power Center Top with Underside CT4 Four Power Center Top (See chart on next page)	See Metal Finish Color Options

Model Number Breakdown

LKT60192-29ART					
LK	T	60192	29	TT	T
LOK	Laminate	60" x 192"	Height	Rectangular Top Shape	T base

Description

Arc Rectangular 2pc Table with T Base at Working Height (continued)

Veneer Tables "LKV" Models

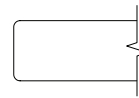

Eased Edge (R3)

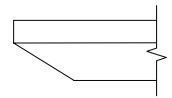

Reverse Bevel Edge (K9)

D	W	H	CTN WT	CU FT	Model	Eased Edge (R3)		Reverse Bevel Edge (K9)	
						Essentials	Artisan	Essentials	Artisan
60	192	29	507	226	LKV60192-29ART	\$11,121	\$12,011	\$12,121	\$12,908
60	168	29	453	198	LKV60168-29ART	\$10,229	\$11,047	\$11,149	\$11,874
60	144	29	396	169	LKV60144-29ART	\$9,311	\$10,056	\$10,148	\$10,808
60	120	29	339	143	LKV60120-29ART	\$8,216	\$8,873	\$8,955	\$9,535
54	192	29	467	204	LKV54192-29ART	\$10,172	\$10,988	\$11,089	\$11,807
54	168	29	389	178	LKV54168-29ART	\$9,302	\$10,048	\$10,140	\$10,799
54	144	29	368	154	LKV54144-29ART	\$8,449	\$9,125	\$9,211	\$9,807
54	120	29	316	130	LKV54120-29ART	\$7,477	\$8,075	\$8,149	\$8,676
48	192	29	429	183	LKV48192-29ART	\$9,135	\$9,884	\$9,624	\$10,330
48	168	29	385	161	LKV48168-29ART	\$8,375	\$9,021	\$8,820	\$9,431
48	144	29	339	139	LKV48144-29ART	\$7,584	\$8,130	\$7,989	\$8,502
48	120	29	293	116	LKV48120-29ART	\$6,743	\$7,191	\$7,106	\$7,526
48	108	29	270	105	LKV48108-29ART	\$5,536	\$5,979	\$6,033	\$6,425

Electrical Options and Upcharges

CT2	108 wide	120 - 192 wide
Dual Power Center Top - Black	CT2BL - add \$1,535	n/a
Dual Power Center Top - White	CT2WH - add \$1,535	n/a
CU1		
Single Power Underside - Black	CU1-1C - add \$610	CU1-1C - add \$709
Single Power Underside with Wireless Charging - Black	CU1-1CW - add \$1,413	CU1-1CW - add \$1,484
CT2U1		
Dual Power Center Top - Black with Underside	CT2U1-BL - add \$1,868	n/a
Dual Power Center Top - White with Underside	CT2U1-WH - add \$1,868	n/a
Dual Power Center Top - Black with Wireless Charging	CT2U1-BLW2 - add \$2,670	n/a
Dual Power Center Top - White with Wireless Charging	CT2U1-WHW2 - add \$2,670	n/a

CT4U1	108 wide	120 - 192 wide
Four Power Center Top with Single Underside - Black	n/a	CT4U1-BL - add \$3,265
Four Power Center Top with Single Underside - White	n/a	CT4U1-WH - add \$3,265
Four Power Center Top - Black with Underside & Wireless Charging	n/a	CT4U1-BLW2 - add \$4,046
Four Power Center Top - White with Underside & Wireless Charging	n/a	CT4U1-WHW2 - add \$4,046
CT4		
Four Power Center Top - Black	n/a	CT4BL - add \$2,859
Four Power Center Top - White	n/a	CT4WH - add \$2,859

Note: Order power infeed that best fits application

To Order Specify

1 Veneer Model #	2 Edge Detail	3 Wood Collection	4 Wood Finish	5 Electrical	6 Metal Color
Veneer (LKV)	See Edge Detail Options	Essentials	See Essentials Wood Finish Options	N None CT2 Dual Power Center Top CU2 Dual Power Underside CT2U1 Dual Power Center Top with Underside CT4U2 Four Power Center Top with Underside CT4 Four Power Center Top	See Metal Finish Color Options
		Artisan	4 Wood Finish See Artisan Wood Finish Options		

Description

Arc Rectangular Table with T Base at Working Height

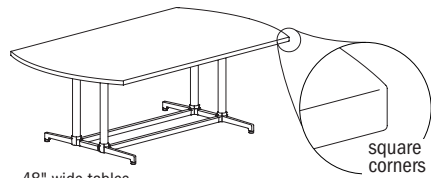

48" wide tables have double column base

LAMINATE	D	W	H	CTN WT	CU FT	Model	Laminate Tables "LKT" Models			
							Eased Edge (R3)		Reverse Bevel Edge (K9)	
							Standard Tier 1	Graded In Tier 2	Standard Tier 1	Graded In Tier 2
	48	96	29	219	83	LKT4896-29ART	\$3,239	\$3,290	\$3,725	\$3,779
	48	84	29	196	83	LKT4884-29ART	\$2,875	\$2,924	\$3,350	\$3,396
	42	96	29	179	73	LKT4296-29ART	\$2,940	\$2,986	\$3,414	\$3,459
	42	84	29	158	72	LKT4284-29ART	\$2,422	\$2,463	\$2,888	\$2,928
	36	96	29	160	72	LKT3696-29ART	\$2,472	\$2,513	\$2,934	\$2,974
	36	84	29	148	64	LKT3684-29ART	\$2,219	\$2,251	\$2,670	\$2,706

Features:

- price reflects complete table - top and base
- ships KD in multiple cartons
- one piece top
- model includes adjustable glide

Options:

- specify power/charging option, see below for options and upcharges

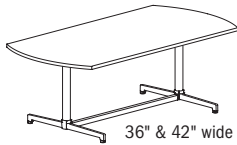

36" & 42" wide tables have single column base



top shape

LOK - CONFERENCE

To Order Specify

1 Laminite Model #	2 Edge Detail	3 Laminite Selection	3a PVC Edge Color	4 Electrical	5 Metal Color
Laminite (LKT)	See Edge Detail Options	See Laminite Selection	See PVC Edge Color Options	N None CT2 Dual Power Center Top CU2 Dual Power Underside CT2U1 Dual Power Center Top with Underside (See chart on next page)	See Metal Finish Color Options

Model Number Breakdown

LKT4896-29ART					
LK	T	4896	29	AR	T
LOK	Laminite	48" x 96"	Height	Arc Rectangular Top Shape	T base

Description

Arc Rectangular Table with T Base at Working Height (continued)

Veneer Tables "LKV" Models

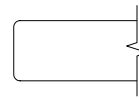

Eased Edge (R3)

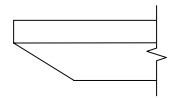

Reverse Bevel Edge (K9)

D	W	H	CTN WT	CU FT	① Model	Eased Edge (R3)		Reverse Bevel Edge (K9)	
						Essentials	Artisan	Essentials	Artisan
48	96	29	219	83	LKV4896-29ART	\$4,510	\$4,857	\$4,828	\$5,156
48	84	29	196	83	LKV4884-29ART	\$4,115	\$4,415	\$4,410	\$4,690
42	96	29	179	73	LKV4296-29ART	\$4,394	\$4,747	\$4,789	\$5,100
	84	29	158	72	LKV4284-29ART	\$3,694	\$3,988	\$4,026	\$4,289
36	96	29	160	72	LKV3696-29ART	\$3,345	\$3,611	\$3,644	\$3,882
36	84	29	148	64	LKV3684-29ART	\$3,077	\$3,321	\$3,353	\$3,570

VENEER

Electrical Options and Upcharges

CT2	84 - 96 wide
Dual Power Center Top - Black	CT2BL - add \$1,535
Dual Power Center Top - White	CT2WH - add \$1,535
CU1	
Single Power Underside - Black	CU1-1C - add \$610
Single Power Underside with Wireless Charging - Black	CU1-1CW - add \$1,413
CT2U1	
Dual Power Center Top - Black with Single Underside	CT2U1-BL - add \$1,904
Dual Power Center Top - White with Single Underside	CT2U1-WH - add \$1,904
Dual Power Center Top - Black with Wireless Charging	CT2U1-BLW2 - add \$2,670
Dual Power Center Top - White with Wireless Charging	CT2U1-WHW2 - add \$2,670

Note: Order power infed that best fits application

To Order Specify

① Veneer Model #	② Edge Detail	③ Wood Collection	④ Wood Finish	⑤ Electrical	⑥ Metal Color
Veneer (LKV)	See Edge Detail Options	Essentials	See Essentials Wood Finish Options	N None CT2 Dual Power Center Top CU2 Dual Power Underside CT2U1 Dual Power Center Top with Underside (See chart above)	See Metal Finish Color Options
		Artisan	④ Wood Finish See Artisan Wood Finish Options		

LOK - CONFERENCE

Description

Rounded Arc Rectangular 3pc Table with T Base at Working Height

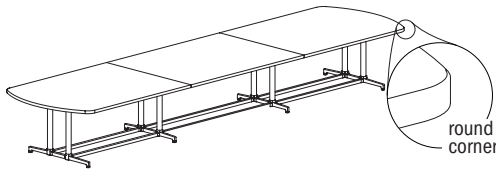

Laminate Tables
"LKT" Models

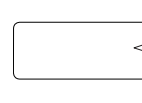

Eased Edge (R3)

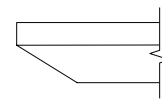

Reverse Bevel Edge (K9)

D	W	H	CTN WT	CU FT	Model	Eased Edge (R3)		Reverse Bevel Edge (K9)	
						Standard Tier 1	Graded In Tier 2	Standard Tier 1	Graded In Tier 2
60	240	29	648	281	LKT60240-29ARRT	\$10,259	\$10,426	\$10,959	\$11,124
60	216	29	593	253	LKT60216-29ARRT	\$8,745	\$8,892	\$9,414	\$9,563
54	240	29	598	254	LKT54240-29ARRT	\$8,276	\$8,423	\$8,940	\$9,088
54	216	29	549	229	LKT54216-29ARRT	\$7,782	\$7,917	\$8,422	\$8,554
48	240	29	548	228	LKT48240-29ARRT	\$7,883	\$8,016	\$8,513	\$8,644
48	216	29	549	206	LKT48216-29ARRT	\$6,974	\$7,093	\$7,581	\$7,700

LAMINATE

Features:

- price reflects complete table - top and base
- ships KD in multiple cartons
- three piece top
- model includes adjustable glide

Options:

- specify power/charging option, see below for options and upcharges



top shape

LOK - CONFERENCE

To Order Specify

1 Laminate Model #	2 Edge Detail	3 Laminate Selection	3a PVC Edge Color	4 Electrical	5 Metal Color
Laminate (LKT)	See Edge Detail Options	See Laminate Selection	See PVC Edge Color Options	N None CT6 Six Power Center Top CU2 Dual Power Underside CT6U2 Six Power Center Top with Underside (See chart on next page)	See Metal Finish Color Options

Model Number Breakdown

LKT60240-29ARRT						
LK	T	60240	29	AR	R	T
LOK	Laminate	60" x 240"	Height	Arc Rectangular Top Shape	Rounded Corner	T base

Description

Rounded Arc Rectangular 3pc Table with T Base at Working Height (continued)

Veneer Tables "LKV" Models

Solid Surface Tables "LKS" Models

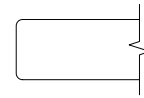

Eased Edge (R3)

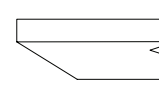

Reverse Bevel Edge (K9)

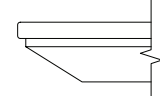

Reverse Bevel Edge (S7)

	D	W	H	CTN WT	CU FT	① Model	Veneer		Solid Surface		
							Essentials	Artisan	Essentials	Artisan	Standard
VENEER	60	240	29	648	281	LKV60240-29ARRT	\$15,957	\$17,234	\$17,393	\$18,524	--
	60	216	29	593	253	LKV60216-29ARRT	\$14,046	\$15,169	\$15,309	\$16,305	--
	54	240	29	598	254	LKV54240-29ARRT	\$13,519	\$14,614	\$14,156	\$15,197	--
	54	216	29	549	229	LKV54216-29ARRT	\$12,545	\$13,519	\$13,130	\$14,053	--
	48	240	29	548	228	LKV48240-29ARRT	\$12,683	\$13,649	\$13,263	\$14,175	--
	48	216	29	549	206	LKV48216-29ARRT	\$11,140	\$11,998	\$11,675	\$12,484	--
SOLID SURFACE	60	240	29	648	281	LKS60240-29ARRT	--	--	--	--	\$35,826
	60	216	29	593	253	LKS60216-29ARRT	--	--	--	--	\$32,381
	54	240	29	598	254	LKS54240-29ARRT	--	--	--	--	\$32,600
	54	216	29	549	229	LKS54216-29ARRT	--	--	--	--	\$29,499
	48	240	29	548	228	LKS48240-29ARRT	--	--	--	--	\$29,441
	48	216	29	549	206	LKS48216-29ARRT	--	--	--	--	\$26,032

Electrical Options and Upcharges

	216 - 240 wide
CT6	
Six Power Center Top - Black	CT6BL - add \$4,137
Six Power Center Top - White	CT6WH - add \$4,137
CU2	
Dual Power Underside - Black	CU2-1C - add \$1,084
Dual Power Underside with 4 Wireless Charging - Black	CU2-1CW - add \$2,740
CT6U2	
Six Power Center Top - Black with Dual Underside	CT6U2-BL - add \$4,805
Six Power Center Top - White with Dual Underside	CT6U2-WH - add \$4,805
Six Power Center Top - Black Dual Underside with 4 Wireless Charging	CT6U2-BLW2 - add \$6,410
Six Power Center Top - White Dual Underside with 4 Wireless Charging	CT6U2-WHW2 - add \$6,410

LOK - CONFERENCE

To Order Specify

Note: Order power infed that best fits application

① Veneer Model #	② Edge Detail	③ Wood Collection	④ Wood Finish	⑤ Electrical	⑥ Metal Color
Veneer (LKV)	See Edge Detail Options	Essentials	See Essentials Wood Finish Options	N None CT6 Six Power Center Top CU2 Dual Power Underside CT6U2 Six Power Center Top with Underside (See chart above)	See Metal Finish Color Options
		Artisan	④ Wood Finish See Artisan Wood Finish Options		

① Solid Surface Model #	② Top Surface Selection	③ Electrical	④ Metal Color
Solid Surface (LKS)	See Solid Surface Top Surface Selection Options	N None CT6 Six Power Center Top CU2 Dual Power Underside CT6U2 Six Power Center Top with Underside (See chart above)	See Metal Finish Color Options

Description

Rounded Arc Rectangular 2pc Table with T Base at Working Height

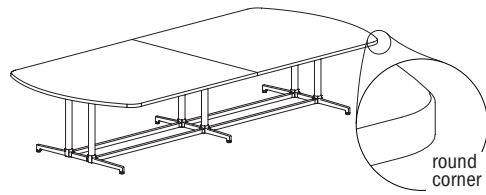

Laminate Tables "LKT" Models

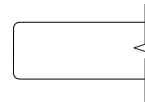

Eased Edge (R3)

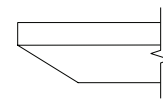

Reverse Bevel Edge (K9)

D	W	H	CTN WT	CU FT	Model	Eased Edge (R3)		Reverse Bevel Edge (K9)	
						Standard Tier 1	Graded In Tier 2	Standard Tier 1	Graded In Tier 2
60	192	29	507	226	LKT60192-29ARRT	\$7,146	\$7,280	\$7,781	\$7,913
60	168	29	453	198	LKT60168-29ARRT	\$6,669	\$6,784	\$7,273	\$7,389
60	144	29	396	169	LKT60144-29ARRT	\$6,153	\$6,251	\$6,728	\$6,826
60	120	29	339	143	LKT60120-29ARRT	\$5,455	\$5,537	\$6,000	\$6,082
54	192	29	467	204	LKT54192-29ARRT	\$6,800	\$6,920	\$7,408	\$7,527
54	168	29	389	178	LKT54168-29ARRT	\$6,159	\$6,264	\$6,743	\$6,845
54	144	29	368	154	LKT54144-29ARRT	\$5,674	\$5,764	\$6,230	\$6,319
54	120	29	316	130	LKT54120-29ARRT	\$5,083	\$5,157	\$5,608	\$5,683
48	192	29	429	183	LKT48192-29ARRT	\$5,933	\$6,039	\$6,515	\$6,620
48	168	29	385	161	LKT48168-29ARRT	\$5,516	\$5,608	\$6,073	\$6,166
48	144	29	339	139	LKT48144-29ARRT	\$5,812	\$5,890	\$6,345	\$6,424
48	120	29	293	116	LKT48120-29ARRT	\$4,547	\$4,613	\$5,058	\$5,125
48	108	29	270	105	LKT48108-29ARRT	\$3,852	\$3,910	\$4,349	\$4,409

LAMINATE

Features:

- price reflects complete table - top and base
- ships KD in multiple cartons
- two piece top
- model includes adjustable glide

Options:

- specify power/charging option, see below for options and upcharges

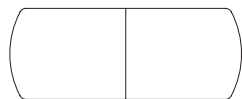

top shape

Electrical Options and Upcharges

	108 wide	120 - 192 wide
CT2		
Dual Power Center Top - Black	CT2BL - add \$1,535	n/a
Dual Power Center Top - White	CT2WH - add \$1,535	n/a
CU1		
Single Power Underside - Black	CU1-1C - add \$610	CU1-1C - add \$709
Single Power Underside with Wireless Charging - Black	CU1-1CW - add \$1,413	CU1-1CW - add \$1,484
CT2U1		
Dual Power Center Top - Black with Underside	CT2U1-BL - add \$1,868	n/a
Dual Power Center Top - White with Underside	CT2U1-WH - add \$1,868	n/a
Dual Power Center Top - Black with Wireless Charging	CT2U1-BLW2 - add \$2,670	n/a
Dual Power Center Top - White with Wireless Charging	CT2U1-WHW2 - add \$2,670	n/a

Note: Order power infeed that best fits application.

	108 wide	120 - 192 wide
CT4U1		
Four Power Center Top with Single Underside - Black	n/a	CT4U1-BL - add \$3,265
Four Power Center Top with Single Underside - White	n/a	CT4U1-WH - add \$3,265
Four Power Center Top - Black with Underside & Wireless Charging	n/a	CT4U1-BLW2 - add \$4,046
Four Power Center Top - White with Underside & Wireless Charging	n/a	CT4U1-WHW2 - add \$4,046
CT4		
Four Power Center Top - Black	n/a	CT4BL - add \$2,859
Four Power Center Top - White	n/a	CT4WH - add \$2,859

To Order Specify

1 Laminate Model #	2 Edge Detail	3 Laminate Selection	3a PVC Edge Color	4 Electrical	5 Metal Color
Laminate (LKT)	See Edge Detail Options	See Laminate Selection	See PVC Edge Color Options	N None CT2 Dual Power Center Top CU2 Dual Power Underside CT2U1 Dual Power Center Top with Underside CT4U2 Four Power Center Top with Underside CT4 Four Power Center Top (See chart above)	See Metal Finish Color Options

Model Number Breakdown

LKT60192-29ARRT						
LK	T	60192	29	AR	R	T
LOK	Laminate	60" x 192"	Height	Arc Rectangular Top Shape	Rounded Corner	T base

LOK - CONFERENCE

Description

Rounded Arc Rectangular 2pc
Table with T Base at Working Height
(continued)

Veneer Tables
"LKV" Models

Solid Surface Tables
"LKS" Models

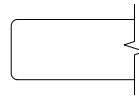

Eased Edge (R3)

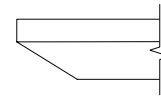

Reverse Bevel Edge (K9)

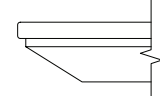

Reverse Bevel Edge (S7)

	D	W	H	CTN WT	CU FT	① Model	Veneer Tables "LKV" Models		Solid Surface Tables "LKS" Models			
							Essentials	Artisan	Essentials	Artisan	Standard	
VENEER	60	192	29	507	226	LKV60192-29ARRT	\$11,121	\$12,011	\$12,121	\$12,908	--	
	60	168	29	453	198	LKV60168-29ARRT	\$10,229	\$11,047	\$11,149	\$11,874	--	
	60	144	29	396	169	LKV60144-29ARRT	\$9,311	\$10,056	\$10,148	\$10,808	--	
	60	120	29	339	143	LKV60120-29ARRT	\$8,216	\$8,873	\$8,955	\$9,535	--	
	54	192	29	467	204	LKV54192-29ARRT	\$10,172	\$10,988	\$11,089	\$11,807	--	
	54	168	29	389	178	LKV54168-29ARRT	\$9,302	\$10,048	\$10,140	\$10,799	--	
	54	144	29	368	154	LKV54144-29ARRT	\$8,449	\$9,125	\$9,211	\$9,807	--	
	54	120	29	316	130	LKV54120-29ARRT	\$7,477	\$8,075	\$8,149	\$8,676	--	
	48	192	29	429	183	LKV48192-29ARRT	\$9,135	\$9,884	\$9,624	\$10,330	--	
	48	168	29	385	161	LKV48168-29ARRT	\$8,375	\$9,021	\$8,820	\$9,431	--	
	48	144	29	339	139	LKV48144-29ARRT	\$7,584	\$8,130	\$7,989	\$8,502	--	
	48	120	29	293	116	LKV48120-29ARRT	\$6,743	\$7,191	\$7,106	\$7,526	--	
	48	108	29	270	105	LKV48108-29ARRT	\$5,536	\$5,979	\$6,033	\$6,425	--	
	SOLID SURFACE	60	192	29	507	226	LKS60192-29ARRT	--	--	--	--	\$26,908
		60	168	29	453	198	LKS60168-29ARRT	--	--	--	--	\$23,776
		60	144	29	396	169	LKS60144-29ARRT	--	--	--	--	\$20,683
60		120	29	339	143	LKS60120-29ARRT	--	--	--	--	\$22,621	
54		192	29	467	204	LKS54192-29ARRT	--	--	--	--	\$24,361	
54		168	29	389	178	LKS54168-29ARRT	--	--	--	--	\$21,627	
54		144	29	368	154	LKS54144-29ARRT	--	--	--	--	\$18,846	
54		120	29	316	130	LKS54120-29ARRT	--	--	--	--	\$16,010	
48		192	29	429	183	LKS48192-29ARRT	--	--	--	--	\$22,028	
48		168	29	385	161	LKS48168-29ARRT	--	--	--	--	\$19,528	
48		144	29	339	139	LKS48144-29ARRT	--	--	--	--	\$17,049	
48		120	29	293	116	LKS48120-29ARRT	--	--	--	--	\$14,576	
48		108	29	270	105	LKS48108-29ARRT	--	--	--	--	\$13,315	

LOK- CONFERENCE

To Order Specify

① Veneer Model #	② Edge Detail	③ Wood Collection	④ Wood Finish	⑤ Electrical	⑥ Metal Color
Veneer (LKV)	See Edge Detail Options	Essentials	See Essentials Wood Finish Options	N None CT2 Dual Power Center Top CU2 Dual Power Underside CT2U1 Dual Power Center Top with Underside CT4U2 Four Power Center Top with Underside CT4 Four Power Center Top (See chart on previous page)	See Metal Finish Color Options
		Artisan	④ Wood Finish See Artisan Wood Finish Options		

① Solid Surface Model #	② Top Surface Selection	③ Electrical	④ Metal Color
Solid Surface (LKS)	See Solid Surface Top Surface Selection Options	N None CT2 Dual Power Center Top CU2 Dual Power Underside CT2U1 Dual Power Center Top with Underside CT4U2 Four Power Center Top with Underside CT4 Four Power Center Top (See chart on previous page)	See Metal Finish Color Options

Description

Rounded Arc Rectangular Table with T Base at Working Height

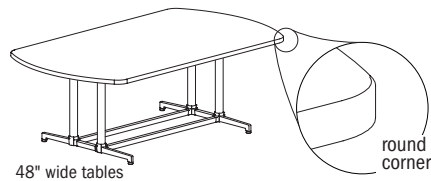

48" wide tables have double column base

D W H CTN WT CU FT **1** Model

LAMINATE

48	96	29	219	83	LKT4896-29ARRT
48	84	29	196	83	LKT4884-29ARRT
42	96	29	179	83	LKT4296-29ARRT
42	84	29	158	73	LKT4284-29ARRT
36	96	29	160	72	LKT3696-29ARRT
36	84	29	148	64	LKT3684-29ARRT

Laminate Tables "LKT" Models

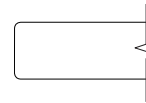

Eased Edge (R3)

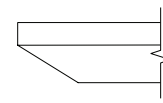

Reverse Bevel Edge (K9)

Eased Edge (R3)		Reverse Bevel Edge (K9)	
Standard Tier 1	Graded In Tier 2	Standard Tier 1	Graded In Tier 2
\$3,239	\$3,290	\$3,725	\$3,779
\$2,875	\$2,924	\$3,350	\$3,396
\$2,940	\$2,986	\$3,414	\$3,459
\$2,422	\$2,463	\$2,888	\$2,928
\$2,472	\$2,513	\$2,934	\$2,974
\$2,219	\$2,251	\$2,670	\$2,706

Features:

- price reflects complete table - top and base
- ships KD in multiple cartons
- one piece top
- model includes adjustable glide

Options:

- specify power/charging option, see below for options and upcharges

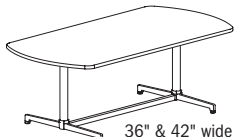

36" & 42" wide tables have single column base

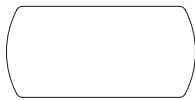

top shape

LOK - CONFERENCE

To Order Specify

1 Laminates Model #	2 Edge Detail	3 Laminates Selection	3a PVC Edge Color	4 Electrical	5 Metal Color
Laminates (LKT)	See Edge Detail Options	See Laminates Selection	See PVC Edge Color Options	N None CT2 Dual Power Center Top CU2 Dual Power Underside CT2U1 Dual Power Center Top with Underside (See chart on next page)	See Metal Finish Color Options

Model Number Breakdown

LKT4896-29ARRT						
LK	T	4896	29	AR	R	T
LOK	Laminates	48" x 96"	Height	Arc Rectangular Top Shape	Rounded Corner	T base

Description

Rounded Arc Rectangular Table with T Base at Working Height (continued)

Veneer Tables "LKV" Models Solid Surface Tables "LKS" Models

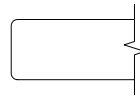

Eased Edge (R3)

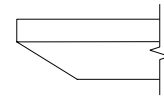

Reverse Bevel Edge (K9)

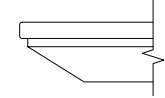

Reverse Bevel Edge (S7)

	D	W	H	CTN WT	CU FT	① Model	Veneer		Solid Surface		
							Essentials	Artisan	Essentials	Artisan	Standard
VENEER	48	96	29	219	83	LKV4896-29ARRT	\$4,510	\$4,857	\$4,828	\$5,156	--
	48	84	29	196	83	LKV4884-29ARRT	\$4,115	\$4,415	\$4,410	\$4,690	--
	42	96	29	179	83	LKV4296-29ARRT	\$4,394	\$4,747	\$4,789	\$5,100	--
	42	84	29	158	73	LKV4284-29ARRT	\$3,694	\$3,988	\$4,026	\$4,289	--
	36	96	29	160	72	LKV3696-29ARRT	\$3,345	\$3,611	\$3,644	\$3,882	--
	36	84	29	148	64	LKV3684-29ARRT	\$3,077	\$3,321	\$3,353	\$3,570	--
SOLID SURFACE	48	96	29	219	83	LKS4896-29ARRT	--	--	--	--	\$10,569
	48	84	29	196	83	LKS4884-29ARRT	--	--	--	--	\$9,368
	42	96	29	179	83	LKS4296-29ARRT	--	--	--	--	\$8,599
	42	84	29	158	73	LKS4284-29ARRT	--	--	--	--	\$7,579
	36	96	29	160	72	LKS3696-29ARRT	--	--	--	--	\$7,556
	36	84	29	148	64	LKS3684-29ARRT	--	--	--	--	\$6,810

Electrical Options and Upcharges

CT2	84 - 96 wide
Dual Power Center Top - Black	CT2BL - add \$1,535
Dual Power Center Top - White	CT2WH - add \$1,535
CU1	
Single Power Underside - Black	CU1-1C - add \$610
Single Power Underside with Wireless Charging - Black	CU1-1CW - add \$1,413
CT2U1	
Dual Power Center Top - Black with Single Underside	CT2U1-BL - add \$1,904
Dual Power Center Top - White with Single Underside	CT2U1-WH - add \$1,904
Dual Power Center Top - Black with Wireless Charging	CT2U1-BLW2 - add \$2,670
Dual Power Center Top - White with Wireless Charging	CT2U1-WHW2 - add \$2,670

LOK - CONFERENCE

Note: Order power infeed that best fits application

To Order Specify

① Veneer Model #	② Edge Detail	③ Wood Collection	④ Wood Finish	⑤ Electrical	⑥ Metal Color
Veneer (LKV)	See Edge Detail Options	Essentials	See Essentials Wood Finish Options	N None CT2 Dual Power Center Top CU2 Dual Power Underside CT2U1 Dual Power Center Top with Underside (See chart above)	See Metal Finish Color Options
		Artisan	④ Wood Finish See Artisan Wood Finish Options		

① Solid Surface Model #	② Top Surface Selection	③ Electrical	④ Metal Color
Solid Surface (LKS)	See Solid Surface Top Surface Selection Options	N None CT2 Dual Power Center Top CU2 Dual Power Underside CT2U1 Dual Power Center Top with Underside (See chart above)	See Metal Finish Color Options

Description

Arc Rectangular 3pc Table with Y Base at Working Height

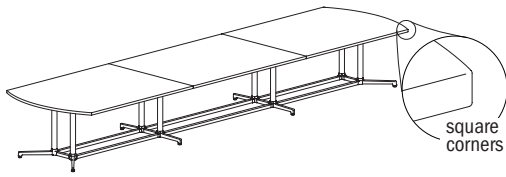

Laminate Tables
"LKT" Models

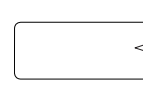

Eased Edge (R3)

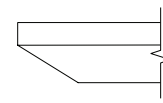

Reverse Bevel Edge (K9)

D	W	H	CTN WT	CU FT	Model	Eased Edge (R3)		Reverse Bevel Edge (K9)	
						Standard Tier 1	Graded In Tier 2	Standard Tier 1	Graded In Tier 2
60	240	29	648	281	LKT60240-29ARY	\$9,940	\$10,102	\$10,637	\$10,801
60	216	29	593	253	LKT60216-29ARY	\$8,404	\$8,554	\$9,073	\$9,222
54	240	29	575	254	LKT54240-29ARY	\$7,864	\$8,011	\$8,527	\$8,675
54	216	29	529	229	LKT54216-29ARY	\$7,029	\$7,163	\$7,666	\$7,800
48	240	29	548	228	LKT48240-29ARY	\$7,598	\$7,732	\$8,227	\$8,359
48	216	29	486	206	LKT48216-29ARY	\$7,042	\$7,161	\$7,651	\$7,768

LAMINATE

Features:

- price reflects complete table - top and base
- ships KD in multiple cartons
- three piece top
- model includes adjustable glide

Options:

- specify power/charging option, see below for options and upcharges



top shape

LOK - CONFERENCE

To Order Specify

1 Laminate Model #	2 Edge Detail	3 Laminate Selection	4 PVC Edge Color	5 Electrical	6 Metal Color
Laminate (LKT)	See Edge Detail Options	See Laminate Selection	See PVC Edge Color Options	N None CT6 Six Power Center Top CU2 Dual Power Underside CT6U2 Six Power Center Top with Underside (See chart on next page)	See Metal Finish Color Options

Model Number Breakdown

LKT60240-29ARY					
LK	T	60240	29	AR	Y
LK	Laminate	60" x 240"	Height	Arc Rectangular Top Shape	Y base

Description

Arc Rectangular 3pc Table with Y Base at Working Height (continued)

Veneer Tables "LKV" Models

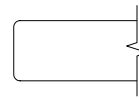

Eased Edge (R3)

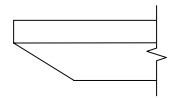

Reverse Bevel Edge (K9)

D	W	H	CTN WT	CU FT	Model	Eased Edge (R3)		Reverse Bevel Edge (K9)		
						Essentials	Artisan	Essentials	Artisan	
60	240	29	648	281	LKV60240-29ARY	\$15,475	\$16,712	\$16,868	\$17,963	
60	216	29	593	253	LKV60216-29ARY	\$13,543	\$14,626	\$14,760	\$15,721	
VENEER	54	240	29	575	254	LKV54240-29ARY	\$12,909	\$14,008	\$13,547	\$14,589
	54	216	29	529	229	LKV54216-29ARY	\$11,451	\$12,423	\$12,038	\$12,960
	48	240	29	548	228	LKV48240-29ARY	\$12,269	\$13,235	\$12,846	\$13,761
	48	216	29	486	206	LKV48216-29ARY	\$11,240	\$12,095	\$11,772	\$12,581

Electrical Options and Upcharges

	216 - 240 wide
CT6	
Six Power Center Top - Black	CT6BL - add \$4,137
Six Power Center Top - White	CT6WH - add \$4,137
CU2	
Dual Power Underside - Black	CU2-1C - add \$1,084
Dual Power Underside with 4 Wireless Charging - Black	CU2-1CW - add \$2,740
CT6U2	
Six Power Center Top - Black with Dual Underside	CT6U2-BL - add \$4,805
Six Power Center Top - White with Dual Underside	CT6U2-WH - add \$4,805
Six Power Center Top - Black Dual Underside with 4 Wireless Charging	CT6U2-BLW2 - add \$6,410
Six Power Center Top - White Dual Underside with 4 Wireless Charging	CT6U2-WHW2 - add \$6,410

Note: Order power infeed that best fits application

To Order Specify

1 Veneer Model #	2 Edge Detail	3 Wood Collection	4 Wood Finish	5 Electrical	6 Metal Color
Veneer (LKV)	See Edge Detail Options	Essentials	See Essentials Wood Finish Options	N None CT6 Six Power Center Top CU2 Dual Power Underside CT6U2 Six Power Center Top with Underside (See chart above)	See Metal Finish Color Options
		Artisan	4 Wood Finish See Artisan Wood Finish Options		

LOK - CONFERENCE

Description

Arc Rectangular 2pc Table with Y Base at Working Height

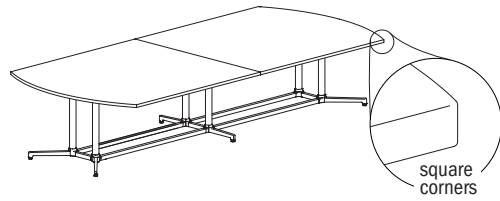

Laminate Tables "LKT" Models

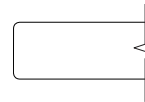

Eased Edge (R3)

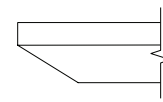

Reverse Bevel Edge (K9)

D	W	H	CTN WT	CU FT	Model	Eased Edge (R3)		Reverse Bevel Edge (K9)	
						Standard Tier 1	Graded In Tier 2	Standard Tier 1	Graded In Tier 2
60	192	29	507	226	LKT60192-29ARY	\$7,736	\$7,870	\$8,371	\$8,505
60	168	29	453	198	LKT60168-29ARY	\$6,457	\$6,573	\$7,063	\$7,179
60	144	29	333	169	LKT60144-29ARY	\$5,883	\$5,981	\$6,456	\$6,555
60	120	29	300	143	LKT60120-29ARY	\$5,299	\$5,380	\$5,844	\$5,926
LAMINATE									
54	192	29	454	204	LKT54192-29ARY	\$6,708	\$6,826	\$7,318	\$7,435
54	168	29	360	178	LKT54168-29ARY	\$5,973	\$6,077	\$6,555	\$6,659
54	144	29	357	154	LKT54144-29ARY	\$5,431	\$5,519	\$5,987	\$6,073
54	120	29	308	130	LKT54120-29ARY	\$4,976	\$5,050	\$5,504	\$5,578
48	192	29	416	183	LKT48192-29ARY	\$6,523	\$6,630	\$7,104	\$7,209
48	168	29	369	161	LKT48168-29ARY	\$5,290	\$5,380	\$5,847	\$5,937
48	144	29	327	139	LKT48144-29ARY	\$4,899	\$4,978	\$5,435	\$5,514
48	120	29	285	116	LKT48120-29ARY	\$4,427	\$4,494	\$4,939	\$5,004
48	108	29	263	105	LKT48108-29ARY	\$3,944	\$4,004	\$4,444	\$4,502

Features:

- price reflects complete table - top and base
- ships KD in multiple cartons
- two piece top
- model includes adjustable glide

Options:

- specify power/charging option, see below for options and upcharges



top shape

LOK - CONFERENCE

To Order Specify

1 Laminate Model #	2 Edge Detail	3 Laminate Selection	3a PVC Edge Color	4 Electrical	5 Metal Color
Laminate (LKT)	See Edge Detail Options	See Laminate Selection	See PVC Edge Color Options	N None CT2 Dual Power Center Top CU2 Dual Power Underside CT2U1 Dual Power Center Top with Underside CT4U2 Four Power Center Top with Underside CT4 Four Power Center Top (See chart on next page)	See Metal Finish Color Options

Model Number Breakdown

LKT60192-29ARY					
LK	T	60192	29	AR	Y
LOK	Laminate	60" x 192"	Height	Arc Rectangular Top Shape	Y base

Description

Arc Rectangular 2pc Table with Y Base at Working Height (continued)

Veneer Tables "LKV" Models

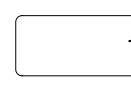

Eased Edge (R3)

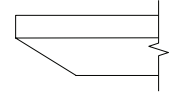

Reverse Bevel Edge (K9)

D	W	H	CTN WT	CU FT	Model	Eased Edge (R3)		Reverse Bevel Edge (K9)	
						Essentials	Artisan	Essentials	Artisan
60	192	29	507	226	LKV60192-29ARY	\$11,976	\$12,934	\$13,054	\$13,902
60	168	29	453	198	LKV60168-29ARY	\$9,929	\$10,723	\$10,824	\$11,526
60	144	29	333	169	LKV60144-29ARY	\$8,932	\$9,645	\$9,735	\$10,366
60	120	29	300	143	LKV60120-29ARY	\$8,001	\$8,639	\$8,718	\$9,286
54	192	29	454	204	LKV54192-29ARY	\$10,041	\$10,845	\$10,945	\$11,655
54	168	29	360	178	LKV54168-29ARY	\$9,043	\$9,767	\$9,856	\$10,497
54	144	29	357	154	LKV54144-29ARY	\$8,114	\$8,763	\$8,844	\$9,420
54	120	29	308	130	LKV54120-29ARY	\$7,334	\$7,919	\$7,995	\$8,511
48	192	29	416	183	LKV48192-29ARY	\$9,960	\$10,709	\$10,450	\$11,158
48	168	29	369	161	LKV48168-29ARY	\$8,062	\$8,707	\$8,508	\$9,115
48	144	29	327	139	LKV48144-29ARY	\$7,368	\$7,913	\$7,771	\$8,286
48	120	29	285	116	LKV48120-29ARY	\$6,583	\$7,032	\$6,948	\$7,369
48	108	29	263	105	LKV48108-29ARY	\$5,657	\$6,109	\$6,166	\$6,567

Electrical Options and Upcharges

CT2	108 wide	120 - 192 wide
Dual Power Center Top - Black	CT2BL - add \$1,535	n/a
Dual Power Center Top - White	CT2WH - add \$1,535	n/a
CU1		
Single Power Underside - Black	CU1-1C - add \$610	CU1-1C - add \$709
Single Power Underside with Wireless Charging - Black	CU1-1CW - add \$1,413	CU1-1CW - add \$1,484
CT2U1		
Dual Power Center Top - Black with Underside	CT2U1-BL - add \$1,868	n/a
Dual Power Center Top - White with Underside	CT2U1-WH - add \$1,868	n/a
Dual Power Center Top - Black with Wireless Charging	CT2U1-BLW2 - add \$2,670	n/a
Dual Power Center Top - White with Wireless Charging	CT2U1-WHW2 - add \$2,670	n/a

CT4U1	108 wide	120 - 192 wide
Four Power Center Top with Single Underside - Black	n/a	CT4U1-BL - add \$3,265
Four Power Center Top with Single Underside - White	n/a	CT4U1-WH - add \$3,265
Four Power Center Top - Black with Underside & Wireless Charging	n/a	CT4U1-BLW2 - add \$4,046
Four Power Center Top - White with Underside & Wireless Charging	n/a	CT4U1-WHW2 - add \$4,046
CT4		
Four Power Center Top - Black	n/a	CT4BL - add \$2,859
Four Power Center Top - White	n/a	CT4WH - add \$2,859

Note: Order power infeed that best fits application

To Order Specify

1 Veneer Model #	2 Edge Detail	3 Wood Collection	4 Wood Finish	5 Electrical	6 Metal Color
Veneer (LKV)	See Edge Detail Options	Essentials	See Essentials Wood Finish Options	N None CT2 Dual Power Center Top CU2 Dual Power Underside CT2U1 Dual Power Center Top with Underside CT4U2 Four Power Center Top with Underside CT4 Four Power Center Top	See Metal Finish Color Options
		Artisan	4 Wood Finish See Artisan Wood Finish Options		

LOK - CONFERENCE

Description

Arc Rectangular Table with Y Base at Working Height

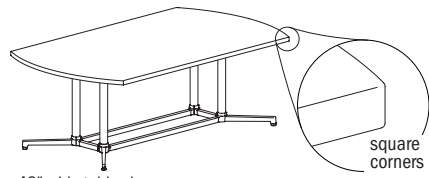

48" wide tables have double column base

CTN WT CU FT **1 Model**

D	W	H	CTN WT	CU FT	Model
48	96	29	218	105	LKT4896-29ARY
48	84	29	333	83	LKT4884-29ARY
42	96	29	169	83	LKT4296-29ARY
42	84	29	636	281	LKT4284-29ARY
36	96	29	636	281	LKT3696-29ARY
36	84	29	648	281	LKT3684-29ARY

LAMINATE

Laminate Tables "LKT" Models

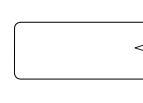

Eased Edge (R3)

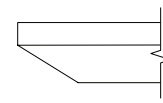

Reverse Bevel Edge (K9)

Standard Tier 1	Graded In Tier 2	Standard Tier 1	Graded In Tier 2
\$2,859	\$2,905	\$3,333	\$3,382
\$3,102	\$3,149	\$3,575	\$3,624
\$2,599	\$2,639	\$3,063	\$3,105
\$2,526	\$2,565	\$2,986	\$3,027
\$2,271	\$2,307	\$2,724	\$2,758

Features:

- price reflects complete table - top and base
- ships KD in multiple cartons
- one piece top
- model includes adjustable glide

Options:

- specify power/charging option, see below for options and upcharges

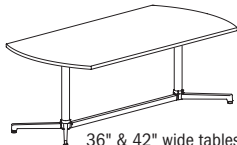

36" & 42" wide tables have single column base



top shape

LOK - CONFERENCE

To Order Specify

1 Laminate Model #	2 Edge Detail	3 Laminate Selection	3a PVC Edge Color	4 Electrical	5 Metal Color
Laminate (LKT)	See Edge Detail Options	See Laminate Selection	See PVC Edge Color Options	N None CT2 Dual Power Center Top CU2 Dual Power Underside CT2U1 Dual Power Center Top with Underside (See chart on next page)	See Metal Finish Color Options

Model Number Breakdown

LKT4896-29ARY					
LK	T	4896	29	AR	Y
LOK	Laminate	48" x 96"	Height	Arc Rectangular Top Shape	Y base

Description

Arc Rectangular Table with Y Base at Working Height (continued)

Veneer Tables "LKV" Models



Eased Edge (R3)

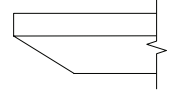

Reverse Bevel Edge (K9)

D	W	H	CTN WT	CU FT	Model	Eased Edge (R3)		Reverse Bevel Edge (K9)		
						Essentials	Artisan	Essentials	Artisan	
48	96	29	218	105	LKV4896-29ARY	\$4,536	\$4,884	\$4,853	\$5,179	
48	84	29	333	83	LKV4884-29ARY	\$4,092	\$4,392	\$4,389	\$4,669	
VENEER	42	96	29	169	83	LKV4296-29ARY	\$4,598	\$4,965	\$5,011	\$5,338
	42	84	29	636	281	LKV4284-29ARY	\$3,910	\$4,223	\$4,262	\$4,539
	36	96	29	636	281	LKV3696-29ARY	\$3,410	\$3,681	\$3,715	\$3,957
	36	84	29	648	281	LKV3684-29ARY	\$3,141	\$3,392	\$3,423	\$3,644

Electrical Options and Upcharges

CT2	84 - 96 wide
Dual Power Center Top - Black	CT2BL - add \$1,535
Dual Power Center Top - White	CT2WH - add \$1,535
CU1	
Single Power Underside - Black	CU1-1C - add \$610
Single Power Underside with Wireless Charging - Black	CU1-1CW - add \$1,413
CT2U1	
Dual Power Center Top - Black with Single Underside	CT2U1-BL - add \$1,904
Dual Power Center Top - White with Single Underside	CT2U1-WH - add \$1,904
Dual Power Center Top - Black with Wireless Charging	CT2U1-BLW2 - add \$2,670
Dual Power Center Top - White with Wireless Charging	CT2U1-WHW2 - add \$2,670

Note: Order power infed that best fits application

To Order Specify

1 Veneer Model #	2 Edge Detail	3 Wood Collection	4 Wood Finish	5 Electrical	6 Metal Color
Veneer (LKV)	See Edge Detail Options	Essentials	See Essentials Wood Finish Options	N None CT2 Dual Power Center Top CU2 Dual Power Underside CT2U1 Dual Power Center Top with Underside (See chart above)	See Metal Finish Color Options
		Artisan	4 Wood Finish See Artisan Wood Finish Options		

LOK - CONFERENCE

Description

Rounded Arc Rectangular 3pc Table with Y Base at Working Height

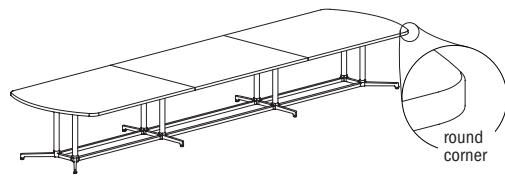

Laminate Tables
"LKT" Models

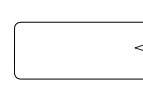

Eased Edge (R3)

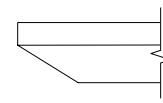

Reverse Bevel Edge (K9)

LAMINATE	D	W	H	CTN WT	CU FT	Model	Eased Edge (R3)		Reverse Bevel Edge (K9)	
							Standard Tier 1	Graded In Tier 2	Standard Tier 1	Graded In Tier 2
	60	240	29	648	281	LKT60240-29ARRY	\$9,940	\$10,102	\$10,637	\$10,801
	60	216	29	593	253	LKT60216-29ARRY	\$8,404	\$8,554	\$9,073	\$9,222
	54	240	29	575	254	LKT54240-29ARRY	\$7,864	\$8,011	\$8,527	\$8,675
	54	216	29	529	229	LKT54216-29ARRY	\$7,029	\$7,163	\$7,666	\$7,800
	48	240	29	548	228	LKT48240-29ARRY	\$7,598	\$7,732	\$8,227	\$8,359
	48	216	29	486	206	LKT48216-29ARRY	\$7,042	\$7,161	\$7,651	\$7,768

Features:

- price reflects complete table - top and base
- ships KD in multiple cartons
- three piece top
- model includes adjustable glide

Options:

- specify power/charging option, see below for options and upcharges



top shape

LOK - CONFERENCE

To Order Specify

1 Laminate Model #	2 Edge Detail	3 Laminate Selection	3a PVC Edge Color	4 Electrical	5 Metal Color
Laminate (LKT)	See Edge Detail Options	See Laminate Selection	See PVC Edge Color Options	N None CT6 Six Power Center Top CU2 Dual Power Underside CT6U2 Six Power Center Top with Underside (See chart on next page)	See Metal Finish Color Options

Model Number Breakdown

LKT60240-29ARRY						
LK	T	60240	29	AR	R	Y
LOK	Laminate	60" x 240"	Height	Arc Rectangular Top Shape	Rounded Corner	Y base

Description

Rounded Arc Rectangular 3pc Table with Y Base at Working Height (continued)

Veneer Tables "LKV" Models

Solid Surface Tables "LKS" Models

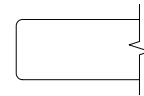

Eased Edge (R3)

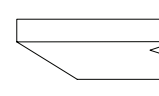

Reverse Bevel Edge (K9)

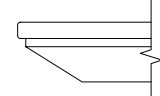

Reverse Bevel Edge (S7)

	D	W	H	CTN WT	CU FT	① Model	Veneer Tables		Solid Surface Tables		
							Essentials	Artisan	Essentials	Artisan	Standard
VENEER	60	240	29	648	281	LKV60240-29ARRY	\$15,475	\$16,712	\$16,868	\$17,963	--
	60	216	29	593	253	LKV60216-29ARRY	\$13,543	\$14,626	\$14,760	\$15,721	--
	54	240	29	575	254	LKV54240-29ARRY	\$12,909	\$14,008	\$13,547	\$14,589	--
	54	216	29	529	229	LKV54216-29ARRY	\$11,451	\$12,423	\$12,038	\$12,960	--
	48	240	29	548	228	LKV48240-29ARRY	\$12,269	\$13,235	\$12,846	\$13,761	--
	48	216	29	486	206	LKV48216-29ARRY	\$11,240	\$12,095	\$11,772	\$12,581	--
SOLID SURFACE	60	240	29	648	281	LKS60240-29ARRY	--	--	--	--	\$35,344
	60	216	29	593	253	LKS60216-29ARRY	--	--	--	--	\$31,880
	54	240	29	575	254	LKS54240-29ARRY	--	--	--	--	\$31,996
	54	216	29	529	229	LKS54216-29ARRY	--	--	--	--	\$28,405
	48	240	29	548	228	LKS48240-29ARRY	--	--	--	--	\$29,028
	48	216	29	486	206	LKS48216-29ARRY	--	--	--	--	\$26,130

Electrical Options and Upcharges

	216 - 240 wide
CT6	
Six Power Center Top - Black	CT6BL - add \$4,137
Six Power Center Top - White	CT6WH - add \$4,137
CU2	
Dual Power Underside - Black	CU2-1C - add \$1,084
Dual Power Underside with 4 Wireless Charging - Black	CU2-1CW - add \$2,740
CT6U2	
Six Power Center Top - Black with Dual Underside	CT6U2-BL - add \$4,805
Six Power Center Top - White with Dual Underside	CT6U2-WH - add \$4,805
Six Power Center Top - Black Dual Underside with 4 Wireless Charging	CT6U2-BLW2 - add \$6,410
Six Power Center Top - White Dual Underside with 4 Wireless Charging	CT6U2-WHW2 - add \$6,410

LOK - CONFERENCE

To Order Specify

Note: Order power infed that best fits application

① Veneer Model #	② Edge Detail	③ Wood Collection	④ Wood Finish	⑤ Electrical	⑥ Metal Color
Veneer (LKV)	See Edge Detail Options	Essentials	See Essentials Wood Finish Options	N None CT6 Six Power Center Top CU2 Dual Power Underside CT6U2 Six Power Center Top with Underside (See chart above)	See Metal Finish Color Options
		Artisan	④ Wood Finish See Artisan Wood Finish Options		

① Solid Surface Model #	② Top Surface Selection	③ Electrical	④ Metal Color
Solid Surface (LKS)	See Solid Surface Top Surface Selection Options	N None CT6 Six Power Center Top CU2 Dual Power Underside CT6U2 Six Power Center Top with Underside (See chart above)	See Metal Finish Color Options

Description

Rounded Arc Rectangular 2pc Table with Y Base at Working Height

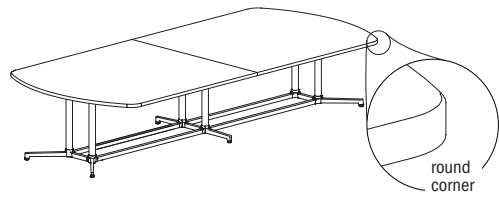

Laminate Tables "LKT" Models

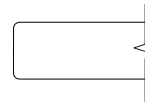

Eased Edge (R3)

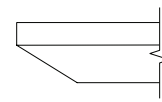

Reverse Bevel Edge (K9)

D	W	H	CTN WT	CU FT	Model	Eased Edge (R3)		Reverse Bevel Edge (K9)	
						Standard Tier 1	Graded In Tier 2	Standard Tier 1	Graded In Tier 2
60	192	29	507	226	LKT60192-29ARRY	\$6,951	\$7,082	\$7,586	\$7,717
60	168	29	453	198	LKT60168-29ARRY	\$6,457	\$6,573	\$7,063	\$7,179
60	144	29	333	169	LKT60144-29ARRY	\$5,883	\$5,981	\$6,456	\$6,555
60	120	29	330	143	LKT60120-29ARRY	\$5,299	\$5,380	\$5,844	\$5,926
54	192	29	454	204	LKT54192-29ARRY	\$6,708	\$6,826	\$7,318	\$7,435
54	168	29	360	178	LKT54168-29ARRY	\$5,973	\$6,077	\$6,555	\$6,659
54	144	29	357	154	LKT54144-29ARRY	\$5,431	\$5,519	\$5,987	\$6,073
54	120	29	308	130	LKT54120-29ARRY	\$4,976	\$5,050	\$5,504	\$5,578
48	192	29	416	183	LKT48192-29ARRY	\$6,523	\$6,630	\$7,104	\$7,209
48	168	29	369	161	LKT48168-29ARRY	\$5,290	\$5,380	\$5,847	\$5,937
48	144	29	327	139	LKT48144-29ARRY	\$4,899	\$4,978	\$5,435	\$5,514
48	120	29	285	116	LKT48120-29ARRY	\$4,427	\$4,494	\$4,939	\$5,004
48	108	29	263	105	LKT48108-29ARRY	\$3,864	\$3,923	\$4,364	\$4,422

Features:

- price reflects complete table - top and base
- ships KD in multiple cartons
- two piece top
- model includes adjustable glide

Options:

- specify power/charging option, see below for options and upcharges

Electrical Options and Upcharges

	108 wide	120 - 192 wide
CT2		
Dual Power Center Top - Black	CT2BL - add \$1,535	n/a
Dual Power Center Top - White	CT2WH - add \$1,535	n/a
CU1		
Single Power Underside - Black	CU1-1C - add \$610	CU1-1C - add \$709
Single Power Underside with Wireless Charging - Black	CU1-1CW - add \$1,413	CU1-1CW - add \$1,484
CT2U1		
Dual Power Center Top - Black with Underside	CT2U1-BL - add \$1,868	n/a
Dual Power Center Top - White with Underside	CT2U1-WH - add \$1,868	n/a
Dual Power Center Top - Black with Wireless Charging	CT2U1-BLW2 - add \$2,670	n/a
Dual Power Center Top - White with Wireless Charging	CT2U1-WHW2 - add \$2,670	n/a

Note: Order power infeed that best fits application.

	108 wide	120 - 192 wide
CT4U1		
Four Power Center Top with Single Underside - Black	n/a	CT4U1-BL - add \$3,265
Four Power Center Top with Single Underside - White	n/a	CT4U1-WH - add \$3,265
Four Power Center Top - Black with Underside & Wireless Charging	n/a	CT4U1-BLW2 - add \$4,046
Four Power Center Top - White with Underside & Wireless Charging	n/a	CT4U1-WHW2 - add \$4,046
CT4		
Four Power Center Top - Black	n/a	CT4BL - add \$2,859
Four Power Center Top - White	n/a	CT4WH - add \$2,859

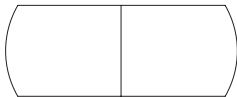

top shape

To Order Specify

1 Laminate Model #	2 Edge Detail	3 Laminate Selection	3a PVC Edge Color	4 Electrical	5 Metal Color
Laminate (LKT)	See Edge Detail Options	See Laminate Selection	See PVC Edge Color Options	N None CT2 Dual Power Center Top CU2 Dual Power Underside CT2U1 Dual Power Center Top with Underside CT4U2 Four Power Center Top with Underside CT4 Four Power Center Top (See chart above)	See Metal Finish Color Options

Model Number Breakdown

LKT60192-29ARRY						
LK	T	60192	29	AR	R	Y
LOK	Laminate	60" x 192"	Height	Arc Rectangular Top Shape	Rounded Corner	Y base

Description

Rounded Arc Rectangular 2pc Table with Y Base at Working Height (continued)

Veneer Tables "LKV" Models Solid Surface Tables "LKS" Models

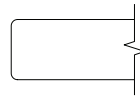

Eased Edge (R3)

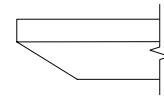

Reverse Bevel Edge (K9)

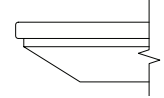

Reverse Bevel Edge (S7)

	D	W	H	CTN WT	CU FT	① Model	Veneer Tables "LKV" Models		Solid Surface Tables "LKS" Models			
							Essentials	Artisan	Essentials	Artisan	Standard	
VENEER	60	192	29	507	226	LKV60192-29ARRY	\$10,837	\$11,704	\$11,813	\$12,580	--	
	60	168	29	453	198	LKV60168-29ARRY	\$9,929	\$10,723	\$10,824	\$11,526	--	
	60	144	29	333	169	LKV60144-29ARRY	\$8,932	\$9,645	\$9,735	\$10,366	--	
	60	120	29	330	143	LKV60120-29ARRY	\$8,001	\$8,639	\$8,718	\$9,286	--	
	54	192	29	454	204	LKV54192-29ARRY	\$10,041	\$10,845	\$10,945	\$11,655	--	
	54	168	29	360	178	LKV54168-29ARRY	\$9,043	\$9,767	\$9,856	\$10,497	--	
	54	144	29	357	154	LKV54144-29ARRY	\$8,114	\$8,763	\$8,844	\$9,420	--	
	54	120	29	308	130	LKV54120-29ARRY	\$7,334	\$7,919	\$7,995	\$8,511	--	
	48	192	29	416	183	LKV48192-29ARRY	\$9,960	\$10,709	\$10,450	\$11,158	--	
	48	168	29	385	161	LKV48168-29ARRY	\$8,062	\$8,707	\$8,508	\$9,115	--	
	48	144	29	327	139	LKV48144-29ARRY	\$7,368	\$7,913	\$7,771	\$8,286	--	
	48	120	29	285	116	LKV48120-29ARRY	\$6,583	\$7,032	\$6,948	\$7,369	--	
	48	108	29	263	105	LKV48108-29ARRY	\$5,553	\$5,996	\$6,054	\$6,445	--	
	SOLID SURFACE	60	192	29	507	226	LKS60192-29ARRY	--	--	--	--	\$26,626
		60	168	29	453	198	LKS60168-29ARRY	--	--	--	--	\$23,473
		60	144	29	333	169	LKS60144-29ARRY	--	--	--	--	\$20,304
60		120	29	330	143	LKS60120-29ARRY	--	--	--	--	\$22,404	
54		192	29	454	204	LKS54192-29ARRY	--	--	--	--	\$24,229	
54		168	29	360	178	LKS54168-29ARRY	--	--	--	--	\$21,366	
54		144	29	357	154	LKS54144-29ARRY	--	--	--	--	\$18,513	
54		120	29	308	130	LKS54120-29ARRY	--	--	--	--	\$15,866	
48		192	29	416	183	LKS48192-29ARRY	--	--	--	--	\$22,853	
48		168	29	369	161	LKS48168-29ARRY	--	--	--	--	\$19,213	
48		144	29	327	139	LKS48144-29ARRY	--	--	--	--	\$16,832	
48		120	29	285	116	LKS48120-29ARRY	--	--	--	--	\$14,418	
48		108	29	263	105	LKS48108-29ARRY	--	--	--	--	\$13,330	

LOK- CONFERENCE

To Order Specify

① Veneer Model #	② Edge Detail	③ Wood Collection	④ Wood Finish	⑤ Electrical	⑥ Metal Color
Veneer (LKV)	See Edge Detail Options	Essentials	See Essentials Wood Finish Options	N None CT2 Dual Power Center Top CU2 Dual Power Underside CT2U1 Dual Power Center Top with Underside CT4U2 Four Power Center Top with Underside CT4 Four Power Center Top (See chart on previous page)	See Metal Finish Color Options
		Artisan	④ Wood Finish See Artisan Wood Finish Options		

① Solid Surface Model #	② Top Surface Selection	③ Electrical	④ Metal Color
Solid Surface (LKS)	See Solid Surface Top Surface Selection Options	N None CT2 Dual Power Center Top CU2 Dual Power Underside CT2U1 Dual Power Center Top with Underside CT4U2 Four Power Center Top with Underside CT4 Four Power Center Top (See chart on previous page)	See Metal Finish Color Options

Description

Rounded Arc Rectangular Table with Y Base at Working Height

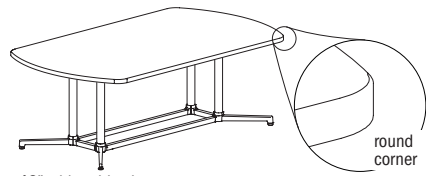

48" wide tables have double column base

LAMINATE

D	W	H	CTN WT	CU FT	Model
48	96	29	218	105	LKT4896-29ARRY
48	84	29	333	83	LKT4884-29ARRY
42	96	29	169	83	LKT4296-29ARRY
42	84	29	174	72	LKT4284-29ARRY
36	96	29	156	72	LKT3696-29ARRY
36	84	29	152	64	LKT3684-29ARRY

Laminate Tables "LKT" Models

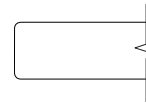

Eased Edge (R3)

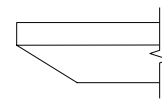

Reverse Bevel Edge (K9)

Standard Tier 1	Graded In Tier 2	Standard Tier 1	Graded In Tier 2
\$2,859	\$2,905	\$3,333	\$3,382
\$3,102	\$3,149	\$3,575	\$3,624
\$2,599	\$2,639	\$3,063	\$3,105
\$2,526	\$2,565	\$2,986	\$3,027
\$2,271	\$2,307	\$2,724	\$2,758

Features:

- price reflects complete table - top and base
- ships KD in multiple cartons
- one piece top
- model includes adjustable glide

Options:

- specify power/charging option, see below for options and upcharges



36" & 42" wide tables have single column base



top shape

LOK - CONFERENCE

To Order Specify

1 Laminate Model #	2 Edge Detail	3 Laminate Selection	3a PVC Edge Color	4 Electrical	5 Metal Color
Laminate (LKT)	See Edge Detail Options	See Laminate Selection	See PVC Edge Color Options	N None CT2 Dual Power Center Top CU2 Dual Power Underside CT2U1 Dual Power Center Top with Underside (See chart on next page)	See Metal Finish Color Options

Model Number Breakdown

LKT4896-29ARRY						
LK	T	4896	29	AR	R	Y
LOK	Laminate	48" x 96"	Height	Arc Rectangular Top Shape	Rounded Corner	Y base

Description

Rounded Arc Rectangular Table with Y Base at Working Height (continued)

Veneer Tables "LKV" Models Solid Surface Tables "LKS" Models

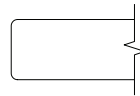

Eased Edge (R3)

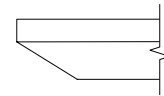

Reverse Bevel Edge (K9)

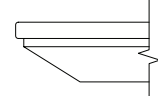

Reverse Bevel Edge (S7)

	D	W	H	CTN WT	CU FT	① Model	Veneer		Solid Surface		
							Essentials	Artisan	Essentials	Artisan	Standard
VENEER	48	96	29	218	105	LKV4896-29ARRY	\$4,536	\$4,884	\$4,853	\$5,179	--
	48	84	29	333	83	LKV4884-29ARRY	\$4,092	\$4,392	\$4,389	\$4,669	--
	42	96	29	169	83	LKV4296-29ARRY	\$4,598	\$4,965	\$5,011	\$5,338	--
	42	84	29	174	72	LKV4284-29ARRY	\$3,910	\$4,223	\$4,262	\$4,539	--
	36	96	29	156	72	LKV3696-29ARRY	\$3,410	\$3,681	\$3,715	\$3,957	--
	36	84	29	152	64	LKV3684-29ARRY	\$3,141	\$3,392	\$3,423	\$3,644	--
SOLID SURFACE	48	96	29	218	105	LKS4896-29ARRY	--	--	--	--	\$10,592
	48	84	29	333	73	LKS4884-29ARRY	--	--	--	--	\$9,350
	42	96	29	169	83	LKS4296-29ARRY	--	--	--	--	\$8,801
	42	84	29	174	72	LKS4284-29ARRY	--	--	--	--	\$7,793
	36	96	29	156	72	LKS3696-29ARRY	--	--	--	--	\$7,620
	36	84	29	152	64	LKS3684-29ARRY	--	--	--	--	\$6,875

Electrical Options and Upcharges

CT2	84 - 96 wide
Dual Power Center Top - Black	CT2BL - add \$1,535
Dual Power Center Top - White	CT2WH - add \$1,535
CU1	
Single Power Underside - Black	CU1-1C - add \$610
Single Power Underside with Wireless Charging - Black	CU1-1CW - add \$1,413
CT2U1	
Dual Power Center Top - Black with Single Underside	CT2U1-BL - add \$1,904
Dual Power Center Top - White with Single Underside	CT2U1-WH - add \$1,904
Dual Power Center Top - Black with Wireless Charging	CT2U1-BLW2 - add \$2,670
Dual Power Center Top - White with Wireless Charging	CT2U1-WHW2 - add \$2,670

LOK - CONFERENCE

Note: Order power infeed that best fits application

To Order Specify

① Veneer Model #	② Edge Detail	③ Wood Collection	④ Wood Finish	⑤ Electrical	⑥ Metal Color
Veneer (LKV)	See Edge Detail Options	Essentials	See Essentials Wood Finish Options	N None CT2 Dual Power Center Top CU2 Dual Power Underside CT2U1 Dual Power Center Top with Underside (See chart above)	See Metal Finish Color Options
		Artisan	④ Wood Finish See Artisan Wood Finish Options		

① Solid Surface Model #	② Top Surface Selection	③ Electrical	④ Metal Color
Solid Surface (LKS)	See Solid Surface Top Surface Selection Options	N None CT2 Dual Power Center Top CU2 Dual Power Underside CT2U1 Dual Power Center Top with Underside (See chart above)	See Metal Finish Color Options

Description

Racetrack 3pc Table with Y Base at Working Height

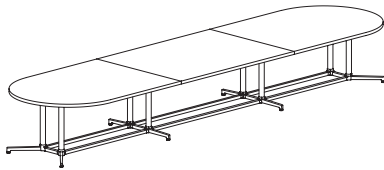

Laminate Tables
"LKT" Models

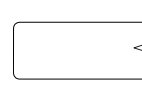

Eased Edge (R3)

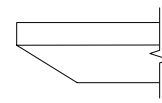

Reverse Bevel Edge (K9)

LAMINATE	D	W	H	CTN WT	CU FT	1 Model	Eased Edge (R3)		Reverse Bevel Edge (K9)	
							Standard	Graded In	Standard	Graded In
							Tier 1	Tier 2	Tier 1	Tier 2
	60	240	29	636	281	LKT60240-29RKY	\$9,940	\$10,102	\$10,637	\$10,801
	60	216	29	584	253	LKT60216-29RKY	\$8,404	\$8,554	\$9,073	\$9,222
	54	240	29	561	254	LKT54240-29RKY	\$7,864	\$8,011	\$8,527	\$8,675
	54	216	29	515	229	LKT54216-29RKY	\$6,985	\$7,118	\$7,624	\$7,755
	48	240	29	517	228	LKT48240-29RKY	\$7,062	\$7,192	\$7,692	\$7,823
	48	216	29	474	206	LKT48216-29RKY	\$6,630	\$6,748	\$7,236	\$7,357

Features:

- price reflects complete table - top and base
- ships KD in multiple cartons
- three piece top
- model includes adjustable glide

Options:

- specify power/charging option, see below for options and upcharges

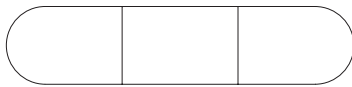

top shape

LOK - CONFERENCE

To Order Specify

1 Laminate Model #	2 Edge Detail	3 Laminate Selection	3a PVC Edge Color	4 Electrical	5 Metal Color
Laminate (LKT)	See Edge Detail Options	See Laminate Selection	See PVC Edge Color Options	N None CT6 Six Power Center Top CU2 Dual Power Underside CT6U2 Six Power Center Top with Underside (See chart on next page)	See Metal Finish Color Options

Model Number Breakdown

LKT60240-29RKY					
LK	T	60240	29	RK	Y
LOK	Laminate	60" x 240"	Height	Racetrack Top Shape	Y base

Description

Racetrack 3pc Table with Y Base at Working Height (continued)

Veneer Tables "LKV" Models

Solid Surface Tables "LKS" Models

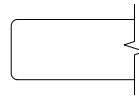

Eased Edge (R3)

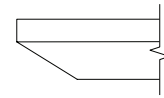

Reverse Bevel Edge (K9)

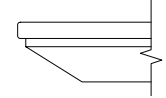

Reverse Bevel Edge (S7)

	D	W	H	CTN WT	CU FT	① Model	Veneer Tables		Solid Surface Tables		
							Essentials	Artisan	Essentials	Artisan	Standard
VENEER	60	240	29	636	281	LKV60240-29RKY	\$15,475	\$16,712	\$16,868	\$17,963	--
	60	216	29	584	253	LKV60216-29RKY	\$13,543	\$14,626	\$14,760	\$15,721	--
	54	240	29	561	254	LKV54240-29RKY	\$12,909	\$14,008	\$13,547	\$14,589	--
	54	216	29	515	229	LKV54216-29RKY	\$11,386	\$12,358	\$11,973	\$12,897	--
	48	240	29	517	228	LKV48240-29RKY	\$11,490	\$12,456	\$12,068	\$12,983	--
	48	216	29	474	206	LKV48216-29RKY	\$10,652	\$11,508	\$11,183	\$11,993	--
SOLID SURFACE	60	240	29	636	281	LKS60240-29RKY	--	--	--	--	\$35,344
	60	216	29	584	253	LKS60216-29RKY	--	--	--	--	\$31,880
	54	240	29	561	254	LKS54240-29RKY	--	--	--	--	\$31,996
	54	216	29	515	229	LKS54216-29RKY	--	--	--	--	\$28,341
	48	240	29	517	228	LKS48240-29RKY	--	--	--	--	\$28,249
	48	216	29	474	206	LKS48216-29RKY	--	--	--	--	\$25,542

Electrical Options and Upcharges

	216 - 240 wide
CT6	
Six Power Center Top - Black	CT6BL - add \$4,137
Six Power Center Top - White	CT6WH - add \$4,137
CU2	
Dual Power Underside - Black	CU2-1C - add \$1,084
Dual Power Underside with 4 Wireless Charging - Black	CU2-1CW - add \$2,740
CT6U2	
Six Power Center Top - Black with Dual Underside	CT6U2-BL - add \$4,805
Six Power Center Top - White with Dual Underside	CT6U2-WH - add \$4,805
Six Power Center Top - Black Dual Underside with 4 Wireless Charging	CT6U2-BLW2 - add \$6,410
Six Power Center Top - White Dual Underside with 4 Wireless Charging	CT6U2-WHW2 - add \$6,410

LOK - CONFERENCE

To Order Specify

Note: Order power infed that best fits application

① Veneer Model #	② Edge Detail	③ Wood Collection	④ Wood Finish	⑤ Electrical	⑥ Metal Color
Veneer (LKV)	See Edge Detail Options	Essentials	See Essentials Wood Finish Options	N None CT6 Six Power Center Top CU2 Dual Power Underside CT6U2 Six Power Center Top with Underside (See chart above)	See Metal Finish Color Options
		Artisan	④ Wood Finish See Artisan Wood Finish Options		

① Solid Surface Model #	② Top Surface Selection	③ Electrical	④ Metal Color
Solid Surface (LKS)	See Solid Surface Top Surface Selection Options	N None CT6 Six Power Center Top CU2 Dual Power Underside CT6U2 Six Power Center Top with Underside (See chart above)	See Metal Finish Color Options

Description

Racetrack 2pc Table with Y Base at Working Height

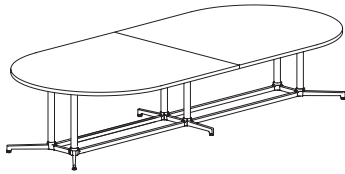

Laminate Tables
"LKT" Models

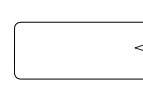

Eased Edge (R3)

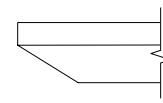

Reverse Bevel Edge (K9)

LAMINATE	D	W	H	CTN WT	CU FT	Model	Standard Tier 1	Graded In Tier 2	Standard Tier 1	Graded In Tier 2
	60	192	29	511	226	LKT60192-29RKY	\$6,841	\$6,974	\$7,478	\$7,609
	60	168	29	449	198	LKT60168-29RKY	\$6,457	\$6,573	\$7,063	\$7,179
60	144	29	315	169	LKT60144-29RKY	\$5,746	\$5,844	\$6,320	\$6,417	
60	120	29	313	143	LKT60120-29RKY	\$5,226	\$5,309	\$5,772	\$5,853	
54	192	29	439	204	LKT54192-29RKY	\$6,610	\$6,729	\$7,217	\$7,337	
54	168	29	343	178	LKT54168-29RKY	\$5,887	\$5,991	\$6,468	\$6,571	
54	144	29	294	154	LKT54144-29RKY	\$5,342	\$5,433	\$5,897	\$5,988	
54	120	29	294	130	LKT54120-29RKY	\$4,904	\$4,977	\$5,431	\$5,506	
48	192	29	403	183	LKT48192-29RKY	\$5,676	\$5,780	\$6,256	\$6,363	
48	168	29	356	161	LKT48168-29RKY	\$5,162	\$5,255	\$5,719	\$5,813	
48	144	29	314	139	LKT48144-29RKY	\$4,688	\$4,768	\$5,225	\$5,303	
48	120	29	273	116	LKT48120-29RKY	\$4,347	\$4,415	\$4,857	\$4,926	
48	108	29	250	105	LKT48108-29RKY	\$3,822	\$3,882	\$4,320	\$4,381	

Features:

- price reflects complete table - top and base
- ships KD in multiple cartons
- two piece top
- model includes adjustable glide

Options:

- specify power/charging option, see below for options and upcharges

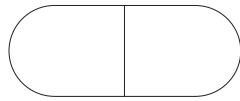

top shape

Electrical Options and Upcharges

	108 wide	120 - 192 wide
CT2		
Dual Power Center Top - Black	CT2BL - add \$1,535	n/a
Dual Power Center Top - White	CT2WH - add \$1,535	n/a
CU1		
Single Power Underside - Black	CU1-1C - add \$610	CU1-1C - add \$709
Single Power Underside with Wireless Charging - Black	CU1-1CW - add \$1,413	CU1-1CW - add \$1,484
CT2U1		
Dual Power Center Top - Black with Underside	CT2U1-BL - add \$1,868	n/a
Dual Power Center Top - White with Underside	CT2U1-WH - add \$1,868	n/a
Dual Power Center Top - Black with Wireless Charging	CT2U1-BLW2 - add \$2,670	n/a
Dual Power Center Top - White with Wireless Charging	CT2U1-WhW2 - add \$2,670	n/a

Note: Order power infeed that best fits application.

	108 wide	120 - 192 wide
CT4U1		
Four Power Center Top with Single Underside - Black	n/a	CT4U1-BL - add \$3,265
Four Power Center Top with Single Underside - White	n/a	CT4U1-WH - add \$3,265
Four Power Center Top - Black with Underside & Wireless Charging	n/a	CT4U1-BLW2 - add \$4,046
Four Power Center Top - White with Underside & Wireless Charging	n/a	CT4U1-WhW2 - add \$4,046
CT4		
Four Power Center Top - Black	n/a	CT4BL - add \$2,859
Four Power Center Top - White	n/a	CT4WH - add \$2,859

To Order Specify

1 Laminate Model #	2 Edge Detail	3 Laminate Selection	3a PVC Edge Color	4 Electrical	5 Metal Color
Laminate (LKT)	See Edge Detail Options	See Laminate Selection	See PVC Edge Color Options	N None CT2 Dual Power Center Top CU2 Dual Power Underside CT2U1 Dual Power Center Top with Underside CT4U2 Four Power Center Top with Underside CT4 Four Power Center Top (See chart above)	See Metal Finish Color Options

Model Number Breakdown

LKT60192-29RKY					
LK	T	60192	29	RK	Y
LOK	Laminate	60" x 192"	Height	Racetrack Top Shape	Y base

Description

Racetrack 2pc Table with Y
Base at Working Height
(continued)

Veneer Tables
"LKV" Models

Solid Surface Tables
"LKS" Models

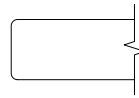

Eased Edge (R3)

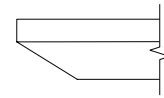

Reverse Bevel Edge (K9)

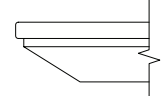

Reverse Bevel Edge (S7)

	D	W	H	CTN WT	CU FT	① Model	Veneer Tables		Solid Surface Tables			
							Essentials	Artisan	Essentials	Artisan	Standard	
VENEER	60	192	29	511	226	LKV60192-29RKY	\$11,820	\$12,765	\$12,881	\$13,718	--	
	60	168	29	449	198	LKV60168-29RKY	\$9,929	\$10,723	\$10,824	\$11,526	--	
	60	144	29	315	169	LKV60144-29RKY	\$8,738	\$9,437	\$9,525	\$10,144	--	
	60	120	29	313	143	LKV60120-29RKY	\$7,900	\$8,531	\$8,611	\$9,172	--	
	54	192	29	439	204	LKV54192-29RKY	\$9,902	\$10,693	\$10,791	\$11,493	--	
	54	168	29	343	178	LKV54168-29RKY	\$8,918	\$9,633	\$9,722	\$10,352	--	
	54	144	29	294	154	LKV54144-29RKY	\$7,995	\$8,632	\$8,712	\$9,279	--	
	54	120	29	294	130	LKV54120-29RKY	\$7,235	\$7,812	\$7,886	\$8,398	--	
	48	192	29	403	183	LKV48192-29RKY	\$8,772	\$9,522	\$9,262	\$9,967	--	
	48	168	29	356	161	LKV48168-29RKY	\$7,886	\$8,534	\$8,333	\$8,941	--	
	48	144	29	314	139	LKV48144-29RKY	\$7,083	\$7,630	\$7,489	\$8,001	--	
	48	120	29	273	116	LKV48120-29RKY	\$6,478	\$6,925	\$6,840	\$7,260	--	
	48	108	29	250	105	LKV48108-29RKY	\$5,501	\$5,937	\$5,993	\$6,383	--	
	SOLID SURFACE	60	192	29	511	226	LKS60192-29RKY	--	--	--	--	\$26,465
		60	168	29	449	198	LKS60168-29RKY	--	--	--	--	\$23,473
		60	144	29	315	169	LKS60144-29RKY	--	--	--	--	\$20,112
60		120	29	313	143	LKS60120-29RKY	--	--	--	--	\$22,307	
54		192	29	439	204	LKS54192-29RKY	--	--	--	--	\$24,092	
54		168	29	343	178	LKS54168-29RKY	--	--	--	--	\$21,245	
54		144	29	294	154	LKS54144-29RKY	--	--	--	--	\$18,393	
54		120	29	294	130	LKS54120-29RKY	--	--	--	--	\$15,770	
48		192	29	403	183	LKS48192-29RKY	--	--	--	--	\$21,664	
48		168	29	356	161	LKS48168-29RKY	--	--	--	--	\$19,039	
48		144	29	314	139	LKS48144-29RKY	--	--	--	--	\$16,550	
48		120	29	273	116	LKS48120-29RKY	--	--	--	--	\$14,310	
48		108	29	250	105	LKS48108-29RKY	--	--	--	--	\$13,277	

LOK- CONFERENCE

To Order Specify

① Veneer Model #	② Edge Detail	③ Wood Collection	④ Wood Finish	⑤ Electrical	⑥ Metal Color
Veneer (LKV)	See Edge Detail Options	Essentials	See Essentials Wood Finish Options	N None CT2 Dual Power Center Top CU2 Dual Power Underside CT2U1 Dual Power Center Top with Underside CT4U2 Four Power Center Top with Underside CT4 Four Power Center Top (See chart on previous page)	See Metal Finish Color Options
		Artisan	④ Wood Finish See Artisan Wood Finish Options		

① Solid Surface Model #	② Top Surface Selection	③ Electrical	④ Metal Color
Solid Surface (LKS)	See Solid Surface Top Surface Selection Options	N None CT2 Dual Power Center Top CU2 Dual Power Underside CT2U1 Dual Power Center Top with Underside CT4U2 Four Power Center Top with Underside CT4 Four Power Center Top (See chart on previous page)	See Metal Finish Color Options

Description

Racetrack Table with Y Base at Working Height

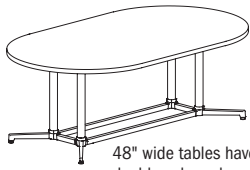

48" wide tables have double column base

Laminate Tables "LKT" Models

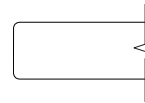

Eased Edge (R3)

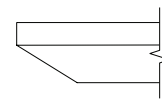

Reverse Bevel Edge (K9)

LAMINATE	D	W	H	CTN WT	CU FT	1 Model	Eased Edge (R3)		Reverse Bevel Edge (K9)	
							Standard Tier 1	Graded In Tier 2	Standard Tier 1	Graded In Tier 2
		48	96	29	207	105	LKT4896-29RKY	\$3,258	\$3,310	\$3,744
	48	84	29	315	83	LKT4884-29RKY	\$2,859	\$2,905	\$3,333	\$3,382
	42	96	29	161	83	LKT4296-29RKY	\$3,102	\$3,149	\$3,575	\$3,624
	42	84	29	161	72	LKT4284-29RKY	\$2,599	\$2,639	\$3,063	\$3,105
	36	96	29	150	72	LKT3696-29RKY	\$2,485	\$2,524	\$2,945	\$2,984
	36	84	29	146	64	LKT3684-29RKY	\$2,271	\$2,307	\$2,724	\$2,758

Features:

- price reflects complete table - top and base
- ships KD in multiple cartons
- one piece top
- model includes adjustable glide

Options:

- specify power/charging option, see below for options and upcharges

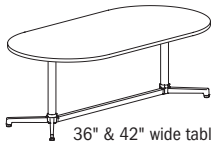

36" & 42" wide tables have single column base



top shape

LOK - CONFERENCE

To Order Specify

1 Laminate Model #	2 Edge Detail	3 Laminate Selection	3a PVC Edge Color	4 Electrical	5 Metal Color
Laminate (LKT)	See Edge Detail Options	See Laminate Selection	See PVC Edge Color Options	N None CT2 Dual Power Center Top CU2 Dual Power Underside CT2U1 Dual Power Center Top with Underside (See chart on next page)	See Metal Finish Color Options

Model Number Breakdown

LKT4896-29RKY					
LK	T	4896	29	RK	Y
LOK	Laminate	48" x 96"	Height	Racetrack Top Shape	Y base

Description

Racetrack Table with Y Base at Working Height (continued)

Veneer Tables "LKV" Models

Solid Surface Tables "LKS" Models

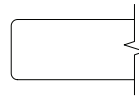

Eased Edge (R3)

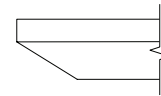

Reverse Bevel Edge (K9)

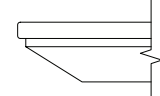

Reverse Bevel Edge (S7)

	D	W	H	CTN WT	CU FT	① Model	Veneer		Solid Surface		
							Essentials	Artisan	Essentials	Artisan	Standard
VENEER	48	96	29	207	105	LKV4896-29RKY	\$4,536	\$4,884	\$4,853	\$5,179	--
	48	84	29	315	83	LKV4884-29RKY	\$4,092	\$4,392	\$4,389	\$4,669	--
	42	96	29	161	83	LKV4296-29RKY	\$4,598	\$4,965	\$5,011	\$5,338	--
	42	84	29	161	72	LKV4284-29RKY	\$3,910	\$4,223	\$4,262	\$4,539	--
	36	96	29	150	72	LKV3696-29RKY	\$3,358	\$3,627	\$3,661	\$3,898	--
	36	84	29	146	64	LKV3684-29RKY	\$3,141	\$3,392	\$3,423	\$3,644	--
SOLID SURFACE	48	96	29	207	105	LKS4896-29RKY	--	--	--	--	\$10,592
	48	84	29	315	83	LKS4884-29RKY	--	--	--	--	\$9,350
	42	96	29	161	83	LKS4296-29RKY	--	--	--	--	\$8,801
	42	84	29	161	72	LKS4284-29RKY	--	--	--	--	\$7,793
	36	96	29	150	72	LKS3696-29RKY	--	--	--	--	\$7,568
	36	84	29	146	64	LKS3684-29RKY	--	--	--	--	\$6,875

Electrical Options and Upcharges

CT2	84 - 96 wide
Dual Power Center Top - Black	CT2BL - add \$1,535
Dual Power Center Top - White	CT2WH - add \$1,535
CU1	
Single Power Underside - Black	CU1-1C - add \$610
Single Power Underside with Wireless Charging - Black	CU1-1CW - add \$1,413
CT2U1	
Dual Power Center Top - Black with Single Underside	CT2U1-BL - add \$1,904
Dual Power Center Top - White with Single Underside	CT2U1-WH - add \$1,904
Dual Power Center Top - Black with Wireless Charging	CT2U1-BLW2 - add \$2,670
Dual Power Center Top - White with Wireless Charging	CT2U1-WHW2 - add \$2,670

Note: Order power infeed that best fits application

To Order Specify

① Veneer Model #	② Edge Detail	③ Wood Collection	④ Wood Finish	⑤ Electrical	⑥ Metal Color
Veneer (LKV)	See Edge Detail Options	Essentials	See Essentials Wood Finish Options	N None CT2 Dual Power Center Top CU2 Dual Power Underside CT2U1 Dual Power Center Top with Underside (See chart above)	See Metal Finish Color Options
		Artisan	④ Wood Finish See Artisan Wood Finish Options		

① Solid Surface Model #	② Top Surface Selection	③ Electrical	④ Metal Color
Solid Surface (LKS)	See Solid Surface Top Surface Selection Options	N None CT2 Dual Power Center Top CU2 Dual Power Underside CT2U1 Dual Power Center Top with Underside (See chart above)	See Metal Finish Color Options

LOK - CONFERENCE

Description

Oval 2pc Table with Y Base at Working Height

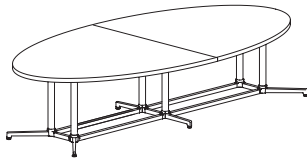

Laminate Tables
"LKT" Models

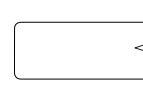

Eased Edge (R3)

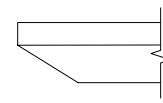

Reverse Bevel Edge (K9)

LAMINATE	D	W	H	CTN WT	CU FT	1 Model	Eased Edge (R3)		Reverse Bevel Edge (K9)	
							Standard	Graded In	Standard	Graded In
							Tier 1	Tier 2	Tier 1	Tier 2
	60	120	29	294	130	LKT60120-290VY	\$5,183	\$5,265	\$5,727	\$5,811
	54	108	29	222	117	LKT54108-290VY	\$4,061	\$4,127	\$4,574	\$4,641

Features:

- price reflects complete table - top and base
- ships KD in multiple cartons
- two piece top
- model includes adjustable glide

Options:

- specify power/charging option, see below for options and upcharges

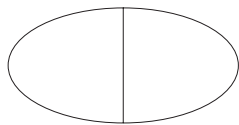

top shape

To Order Specify

1 Laminate Model #	2 Edge Detail	3 Laminate Selection	3a PVC Edge Color	4 Electrical	5 Metal Color
Laminate (LKT)	See Edge Detail Options	See Laminate Selection	See PVC Edge Color Options	N None CT2 Dual Power Center Top CU2 Dual Power Underside CT2U1 Dual Power Center Top with Underside CT4U2 Four Power Center Top with Underside CT4 Four Power Center Top (See chart above)	See Metal Finish Color Options

Model Number Breakdown

LKT60120-290VY					
LK	T	60120	29	OV	Y
LOK	Laminate	60" x 120"	Height	Oval Top Shape	Y base

Description

Oval 2pc Table with Y Base at Working Height (continued)

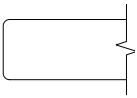
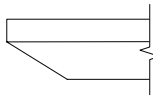
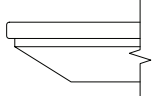
		Veneer Tables "LKV" Models				Solid Surface Tables "LKS" Models					
		 <p>Eased Edge (R3)</p>		 <p>Reverse Bevel Edge (K9)</p>		 <p>Reverse Bevel Edge (S7)</p>					
	D	W	H	CTN WT	CU FT	Model	Essentials	Artisan	Essentials	Artisan	Standard
VENEER	60	120	29	294	130	LKV60120-290VY	\$7,842	\$8,468	\$8,546	\$9,102	--
	54	108	29	222	117	LKV54108-290VY	\$6,092	\$6,549	\$6,458	\$6,886	--
SOL. SURF.	60	120	29	294	130	LKS60120-290VY	--	--	--	--	\$22,246
	54	108	29	222	117	LKS54108-290VY	--	--	--	--	\$17,959

Electrical Options and Upcharges

CT2	108 wide	120 - 192 wide
Dual Power Center Top - Black	CT2BL - add \$1,535	n/a
Dual Power Center Top - White	CT2WH - add \$1,535	n/a
CU1		
Single Power Underside - Black	CU1-1C - add \$610	CU1-1C - add \$709
Single Power Underside with Wireless Charging - Black	CU1-1CW - add \$1,413	CU1-1CW - add \$1,484
CT2U1		
Dual Power Center Top - Black with Underside	CT2U1-BL - add \$1,868	n/a
Dual Power Center Top - White with Underside	CT2U1-WH - add \$1,868	n/a
Dual Power Center Top-Black with Wireless Charging	CT2U1-BLW2 - add \$2,670	n/a
Dual Power Center Top-White with Wireless Charging	CT2U1-WhW2 - add \$2,670	n/a

CT4U1	108 wide	120 - 192 wide
Four Power Center Top with Single Underside - Black	n/a	CT4U1-BL - add \$3,265
Four Power Center Top with Single Underside - White	n/a	CT4U1-WH - add \$3,265
Four Power Center Top - Black with Underside & Wireless Charging	n/a	CT4U1-BLW2 - add \$4,046
Four Power Center Top - White with Underside & Wireless Charging	n/a	CT4U1-WhW2 - add \$4,046
CT4		
Four Power Center Top - Black	n/a	CT4BL - add \$2,859
Four Power Center Top - White	n/a	CT4WH - add \$2,859

Note: Order power infed that best fits application, see page 408.

To Order Specify

1 Veneer Model #	2 Edge Detail	3 Wood Collection	4 Wood Finish	5 Electrical	6 Metal Color
Veneer (LKV)	See Edge Detail Options	Essentials	See Essentials Wood Finish Options	N None CT2 Dual Power Center Top CU2 Dual Power Underside CT2U1 Dual Power Center Top with Underside CT4U2 Four Power Center Top with Underside CT4 Four Power Center Top (See chart on previous page)	See Metal Finish Color Options
		Artisan	4 Wood Finish See Artisan Wood Finish Options		

1 Solid Surface Model #	2 Top Surface Selection	3 Electrical	4 Metal Color
Solid Surface (LKS)	See Solid Surface Top Surface Selection Options	N None CT2 Dual Power Center Top CU2 Dual Power Underside CT2U1 Dual Power Center Top with Underside CT4U2 Four Power Center Top with Underside CT4 Four Power Center Top (See chart on previous page)	See Metal Finish Color Options

LOK - CONFERENCE

Description

Oval Table with Y Base at Working Height

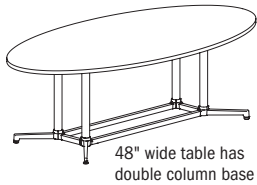

Laminate Tables "LKT" Models

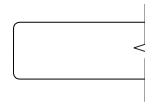

Eased Edge (R3)

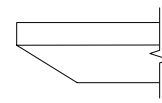

Reverse Bevel Edge (K9)

LAMINATE	D	W	H	CTN WT	CU FT	1 Model	Eased Edge (R3)		Reverse Bevel Edge (K9)	
							Standard Tier 1	Graded In Tier 2	Standard Tier 1	Graded In Tier 2
	48	96	29	186	105	LKT4896-290VY	\$3,184	\$3,238	\$3,671	\$3,724
42	84	29	147	72	LKT4284-290VY	\$2,599	\$2,639	\$3,063	\$3,105	

Features:

- price reflects complete table - top and base
- ships KD in multiple cartons
- one piece top
- model includes adjustable glide

Options:

- specify power/charging option, see below for options and upcharges

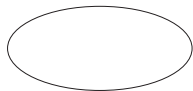
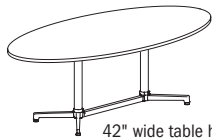

top shape

LOK - CONFERENCE

To Order Specify

1 Laminite Model #	2 Edge Detail	3 Laminite Selection	3a PVC Edge Color	4 Electrical	5 Metal Color
Laminite (LKT)	See Edge Detail Options	See Laminite Selection	See PVC Edge Color Options	N None CT2 Dual Power Center Top CU2 Dual Power Underside CT2U1 Dual Power Center Top with Underside (See chart on next page)	See Metal Finish Color Options

Model Number Breakdown

LKT4896-290VY					
LK	T	4896	29	OV	Y
LOK	Laminite	48" x 96"	Height	Oval Top Shape	Y base

Description

Oval Table with Y Base at Working Height (continued)

Veneer Tables "LKV" Models Solid Surface Tables "LKS" Models

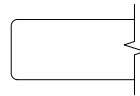

Eased Edge (R3)

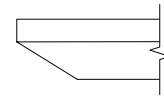

Reverse Bevel Edge (K9)

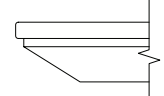

Reverse Bevel Edge (S7)

	D	W	H	CTN WT	CU FT	① Model	Veneer Tables "LKV" Models		Solid Surface Tables "LKS" Models		
							Essentials	Artisan	Essentials	Artisan	Standard
VENEER	48	96	29	186	105	LKV4896-290VY	\$4,442	\$4,789	\$4,759	\$5,085	--
	42	84	29	147	72	LKV4284-290VY	\$3,910	\$4,223	\$4,262	\$4,539	--
SOL SURF	48	96	29	186	105	LKS4896-290VY	--	--	--	--	\$10,498
	42	84	29	147	72	LKS4284-290VY	--	--	--	--	\$7,793

Electrical Options and Upcharges

CT2	84 - 96 wide
Dual Power Center Top - Black	CT2BL - add \$1,535
Dual Power Center Top - White	CT2WH - add \$1,535
CU1	
Single Power Underside - Black	CU1-1C - add \$610
Single Power Underside with Wireless Charging - Black	CU1-1CW - add \$1,413
CT2U1	
Dual Power Center Top - Black with Single Underside	CT2U1-BL - add \$1,904
Dual Power Center Top - White with Single Underside	CT2U1-WH - add \$1,904
Dual Power Center Top - Black with Wireless Charging	CT2U1-BLW2 - add \$2,670
Dual Power Center Top - White with Wireless Charging	CT2U1-WHW2 - add \$2,670

LOK - CONFERENCE

Note: Order power infeed that best fits application

To Order Specify

① Veneer Model #	② Edge Detail	③ Wood Collection	④ Wood Finish	⑤ Electrical	⑥ Metal Color
Veneer (LKV)	See Edge Detail Options	Essentials	See Essentials Wood Finish Options	N None CT2 Dual Power Center Top CU2 Dual Power Underside CT2U1 Dual Power Center Top with Underside (See chart above)	See Metal Finish Color Options
		Artisan	④ Wood Finish See Artisan Wood Finish Options		

① Solid Surface Model #	② Top Surface Selection	③ Electrical	④ Metal Color
Solid Surface (LKS)	See Solid Surface Top Surface Selection Options	N None CT2 Dual Power Center Top CU2 Dual Power Underside CT2U1 Dual Power Center Top with Underside (See chart above)	See Metal Finish Color Options

Description

Boat 3pc Table with T Base
at Working Height

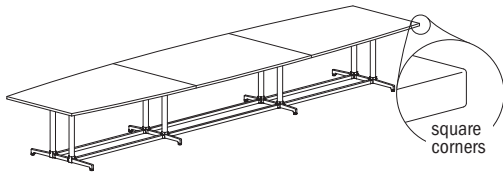

Laminate Tables "LKT" Models

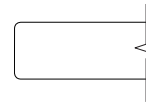

Eased Edge (R3)

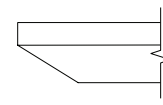

Reverse Bevel Edge (K9)

LAMINATE	D	W	H	CTN WT	CU FT	1 Model	Eased Edge (R3)		Reverse Bevel Edge (K9)	
							Standard	Graded In	Standard	Graded In
							Tier 1	Tier 2	Tier 1	Tier 2
	60	240	29	636	281	LKT60240-29BTT	\$10,259	\$10,426	\$10,959	\$11,124
	60	216	29	584	253	LKT60216-29BTT	\$8,745	\$8,892	\$9,414	\$9,563
	54	240	29	586	254	LKT54240-29BTT	\$8,276	\$8,423	\$8,940	\$9,088
	54	216	29	538	229	LKT54216-29BTT	\$7,782	\$7,917	\$8,422	\$8,554
	48	240	29	534	228	LKT48240-29BTT	\$7,883	\$8,016	\$8,513	\$8,644
	48	216	29	538	206	LKT48216-29BTT	\$6,974	\$7,093	\$7,581	\$7,700

Features:

- price reflects complete table - top and base
- ships KD in multiple cartons
- three piece top
- model includes adjustable glide

Options:

- specify power/charging option, see below for options and upcharges



top shape

LOK - CONFERENCE

To Order Specify

1 Laminate Model #	2 Edge Detail	3 Laminate Selection	4 PVC Edge Color	4 Electrical	5 Metal Color
Laminate (LKT)	See Edge Detail Options	See Laminate Selection	See PVC Edge Color Options	N None CT6 Six Power Center Top CU2 Dual Power Underside CT6U2 Six Power Center Top with Underside (See chart on next page)	See Metal Finish Color Options

Model Number Breakdown

LKT60240-29BTT					
LK	T	60240	29	BT	T
LOK	Laminate	60" x 240"	Height	Boat Top Shape	T base

Description

Boat 3pc Table with T Base
at Working Height
(continued)

Veneer Tables
"LKV" Models

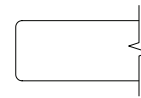

Eased Edge (R3)

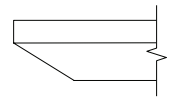

Reverse Bevel Edge (K9)

D	W	H	CTN WT	CU FT	① Model	Eased Edge (R3)		Reverse Bevel Edge (K9)		
						Essentials	Artisan	Essentials	Artisan	
60	240	29	636	281	LKV60240-29BTT	\$15,957	\$17,234	\$17,393	\$18,524	
60	216	29	584	253	LKV60216-29BTT	\$14,046	\$15,169	\$15,309	\$16,305	
VENEER	54	240	29	586	254	LKV54240-29BTT	\$13,519	\$14,614	\$14,156	\$15,197
	54	216	29	538	229	LKV54216-29BTT	\$12,545	\$13,519	\$13,130	\$14,053
	48	240	29	534	228	LKV48240-29BTT	\$12,683	\$13,649	\$13,263	\$14,175
	48	216	29	538	206	LKV48216-29BTT	\$11,140	\$11,998	\$11,675	\$12,484

Electrical Options and Upcharges

	216 - 240 wide
CT6	
Six Power Center Top - Black	CT6BL - add \$4,137
Six Power Center Top - White	CT6WH - add \$4,137
CU2	
Dual Power Underside - Black	CU2-1C - add \$1,084
Dual Power Underside with 4 Wireless Charging - Black	CU2-1CW - add \$2,740
CT6U2	
Six Power Center Top - Black with Dual Underside	CT6U2-BL - add \$4,805
Six Power Center Top - White with Dual Underside	CT6U2-WH - add \$4,805
Six Power Center Top - Black Dual Underside with 4 Wireless Charging	CT6U2-BLW2 - add \$6,410
Six Power Center Top - White Dual Underside with 4 Wireless Charging	CT6U2-WHW2 - add \$6,410

Note: Order power infeed that best fits application

To Order Specify

① Veneer Model #	② Edge Detail	③ Wood Collection	④ Wood Finish	⑤ Electrical	⑥ Metal Color
Veneer (LKV)	See Edge Detail Options	Essentials	See Essentials Wood Finish Options	N None CT6 Six Power Center Top CU2 Dual Power Underside CT6U2 Six Power Center Top with Underside (See chart above)	See Metal Finish Color Options
		Artisan	④ Wood Finish See Artisan Wood Finish Options		

LOK - CONFERENCE

Description

Boat 2pc Table with T Base at Working Height

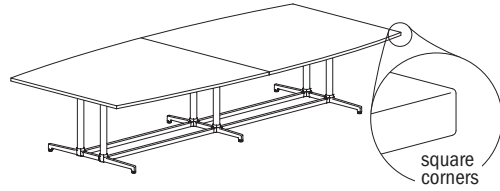

Laminate Tables "LKT" Models

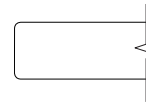

Eased Edge (R3)

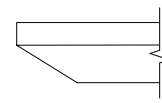

Reverse Bevel Edge (K9)

D	W	H	CTN WT	CU FT	Model	Eased Edge (R3)		Reverse Bevel Edge (K9)	
						Standard Tier 1	Graded In Tier 2	Standard Tier 1	Graded In Tier 2
60	192	29	511	226	LKT60192-29BTT	\$7,146	\$7,280	\$7,781	\$7,913
60	168	29	449	198	LKT60168-29BTT	\$6,669	\$6,784	\$7,273	\$7,389
60	144	29	395	169	LKT60144-29BTT	\$6,153	\$6,251	\$6,728	\$6,826
60	120	29	342	143	LKT60120-29BTT	\$5,455	\$5,537	\$6,000	\$6,082
54	192	29	459	204	LKT54192-29BTT	\$6,800	\$6,920	\$7,408	\$7,527
54	168	29	377	178	LKT54168-29BTT	\$6,159	\$6,264	\$6,743	\$6,845
54	144	29	365	154	LKT54144-29BTT	\$5,674	\$5,764	\$6,230	\$6,319
54	120	29	316	130	LKT54120-29BTT	\$5,083	\$5,157	\$5,608	\$5,683
48	192	29	419	183	LKT48192-29BTT	\$5,933	\$6,039	\$6,515	\$6,620
48	168	29	377	161	LKT48168-29BTT	\$5,516	\$5,608	\$6,073	\$6,166
48	144	29	334	139	LKT48144-29BTT	\$5,060	\$5,139	\$5,594	\$5,674
48	120	29	290	116	LKT48120-29BTT	\$4,547	\$4,613	\$5,058	\$5,125
48	108	29	268	105	LKT48108-29BTT	\$3,852	\$3,910	\$4,349	\$4,409

LAMINATE

Features:

- price reflects complete table - top and base
- ships KD in multiple cartons
- two piece top
- model includes adjustable glide

Options:

- specify power/charging option, see below for options and upcharges



top shape

LOK - CONFERENCE

To Order Specify

1 Laminate Model #	2 Edge Detail	3 Laminate Selection	3a PVC Edge Color	4 Electrical	5 Metal Color
Laminate (LKT)	See Edge Detail Options	See Laminate Selection	See PVC Edge Color Options	N None CT2 Dual Power Center Top CU2 Dual Power Underside CT2U1 Dual Power Center Top with Underside CT4U2 Four Power Center Top with Underside CT4 Four Power Center Top (See chart on next page)	See Metal Finish Color Options

Model Number Breakdown

LKT60192-29BTT					
LK	T	60192	29	BT	T
LOK	Laminate	60" x 192"	Height	Boat Top Shape	T base

Description

Boat 2pc Table with
T Base at Working Height
(continued)

Veneer Tables
"LKV" Models

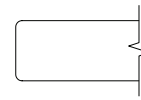

Eased Edge (R3)

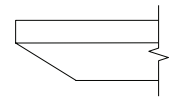

Reverse Bevel Edge (K9)

D	W	H	CTN WT	CU FT	Model	Eased Edge (R3)		Reverse Bevel Edge (K9)		
						Essentials	Artisan	Essentials	Artisan	
60	192	29	511	226	LKV60192-29BTT	\$11,121	\$12,011	\$12,121	\$12,908	
60	168	29	449	198	LKV60168-29BTT	\$10,229	\$11,047	\$11,149	\$11,874	
60	144	29	395	169	LKV60144-29BTT	\$9,311	\$10,056	\$10,148	\$10,808	
60	120	29	342	143	LKV60120-29BTT	\$8,216	\$8,873	\$8,955	\$9,535	
VENEER	54	192	29	459	204	LKV54192-29BTT	\$10,172	\$10,988	\$11,089	\$11,807
	54	168	29	377	178	LKV54168-29BTT	\$9,302	\$10,048	\$10,140	\$10,799
	54	144	29	365	154	LKV54144-29BTT	\$8,449	\$9,125	\$9,211	\$9,807
	54	120	29	316	130	LKV54120-29BTT	\$7,477	\$8,075	\$8,149	\$8,676
48	192	29	419	183	LKV48192-29BTT	\$9,135	\$9,884	\$9,624	\$10,330	
48	168	29	377	161	LKV48168-29BTT	\$8,375	\$9,021	\$8,820	\$9,431	
48	144	29	334	139	LKV48144-29BTT	\$7,584	\$8,130	\$7,989	\$8,502	
48	120	29	290	116	LKV48120-29BTT	\$6,743	\$7,191	\$7,106	\$7,526	
48	108	29	268	105	LKV48108-29BTT	\$5,536	\$5,979	\$6,033	\$6,425	

Electrical Options and Upcharges

CT2	108 wide	120 - 192 wide
Dual Power Center Top - Black	CT2BL - add \$1,535	n/a
Dual Power Center Top - White	CT2WH - add \$1,535	n/a
CU1		
Single Power Underside - Black	CU1-1C - add \$610	CU1-1C - add \$709
Single Power Underside with Wireless Charging - Black	CU1-1CW - add \$1,413	CU1-1CW - add \$1,484
CT2U1		
Dual Power Center Top - Black with Underside	CT2U1-BL - add \$1,868	n/a
Dual Power Center Top - White with Underside	CT2U1-WH - add \$1,868	n/a
Dual Power Center Top - Black with Wireless Charging	CT2U1-BLW2 - add \$2,670	n/a
Dual Power Center Top - White with Wireless Charging	CT2U1-WHW2 - add \$2,670	n/a

CT4U1	108 wide	120 - 192 wide
Four Power Center Top with Single Underside - Black	n/a	CT4U1-BL - add \$3,265
Four Power Center Top with Single Underside - White	n/a	CT4U1-WH - add \$3,265
Four Power Center Top - Black with Underside & Wireless Charging	n/a	CT4U1-BLW2 - add \$4,046
Four Power Center Top - White with Underside & Wireless Charging	n/a	CT4U1-WHW2 - add \$4,046
CT4		
Four Power Center Top - Black	n/a	CT4BL - add \$2,859
Four Power Center Top - White	n/a	CT4WH - add \$2,859

Note: Order power infeed that best fits application

To Order Specify

1 Veneer Model #	2 Edge Detail	3 Wood Collection	4 Wood Finish	5 Electrical	6 Metal Color
Veneer (LKV)	See Edge Detail Options	Essentials	See Essentials Wood Finish Options	N None CT2 Dual Power Center Top CU2 Dual Power Underside CT2U1 Dual Power Center Top with Underside CT4U2 Four Power Center Top with Underside CT4 Four Power Center Top	See Metal Finish Color Options
		Artisan	4 Wood Finish See Artisan Wood Finish Options		

LOK - CONFERENCE

Description

Boat Table with T Base at Working Height

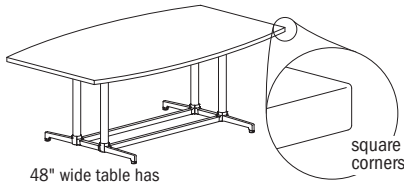

48" wide table has double column base

square corners

Laminate Tables "LKT" Models

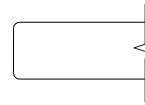

Eased Edge (R3)

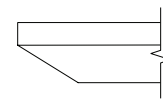

Reverse Bevel Edge (K9)

LAMINATE	D	W	H	CTN WT	CU FT	Model	Eased Edge (R3)		Reverse Bevel Edge (K9)	
							Standard Tier 1	Graded In Tier 2	Standard Tier 1	Graded In Tier 2
	48	96	29	219	83	LKT4896-29BTT	\$3,239	\$3,290	\$3,725	\$3,779
	48	84	29	198	83	LKT4884-29BTT	\$2,875	\$2,924	\$3,350	\$3,396
	42	96	29	177	73	LKT4296-29BTT	\$2,940	\$2,986	\$3,414	\$3,459
	42	84	29	158	72	LKT4284-29BTT	\$2,422	\$2,463	\$2,888	\$2,928
	36	96	29	156	72	LKT3696-29BTT	\$2,472	\$2,513	\$2,934	\$2,974
	36	84	29	146	64	LKT3684-29BTT	\$2,219	\$2,251	\$2,670	\$2,706

Features:

- price reflects complete table - top and base
- ships KD in multiple cartons
- one piece top
- model includes adjustable glide

Options:

- specify power/charging option, see below for options and upcharges

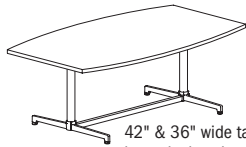

42" & 36" wide tables have single column base



top shape

LOK - CONFERENCE

To Order Specify

1 Laminite Model #	2 Edge Detail	3 Laminite Selection	3a PVC Edge Color	4 Electrical	5 Metal Color
Laminite (LKT)	See Edge Detail Options	See Laminite Selection	See PVC Edge Color Options	N None CT2 Dual Power Center Top CU2 Dual Power Underside CT2U1 Dual Power Center Top with Underside (See chart on next page)	See Metal Finish Color Options

Model Number Breakdown

LKT4896-29BTT					
LK	T	4896	29	BT	T
LOK	Laminite	48" x 96"	Height	Boat Top Shape	T base

Description

Boat Table with T Base at Working Height (continued)

Veneer Tables "LKV" Models

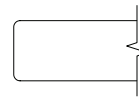

Eased Edge (R3)

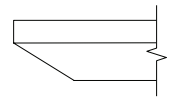

Reverse Bevel Edge (K9)

VENEER	D	W	H	CTN WT	CU FT	1 Model	Essentials	Artisan	Essentials	Artisan
		48	96	29	219	83	LKV4896-29BTT	\$4,510	\$4,857	\$4,828
	48	84	29	198	83	LKV4884-29BTT	\$4,115	\$4,415	\$4,410	\$4,690
	42	96	29	177	73	LKV4296-29BTT	\$4,394	\$4,747	\$4,789	\$5,100
	42	84	29	158	72	LKV4284-29BTT	\$3,694	\$3,988	\$4,026	\$4,289
	36	96	29	156	72	LKV3696-29BTT	\$3,345	\$3,611	\$3,644	\$3,882
	36	84	29	146	64	LKV3684-29BTT	\$3,077	\$3,321	\$3,353	\$3,570

Electrical Options and Upcharges

CT2	84 - 96 wide
Dual Power Center Top - Black	CT2BL - add \$1,535
Dual Power Center Top - White	CT2WH - add \$1,535
CU1	
Single Power Underside - Black	CU1-1C - add \$610
Single Power Underside with Wireless Charging - Black	CU1-1CW - add \$1,413
CT2U1	
Dual Power Center Top - Black with Single Underside	CT2U1-BL - add \$1,904
Dual Power Center Top - White with Single Underside	CT2U1-WH - add \$1,904
Dual Power Center Top - Black with Wireless Charging	CT2U1-BLW2 - add \$2,670
Dual Power Center Top - White with Wireless Charging	CT2U1-WHW2 - add \$2,670

Note: Order power infed that best fits application

To Order Specify

1 Veneer Model #	2 Edge Detail	3 Wood Collection	4 Wood Finish	5 Electrical	6 Metal Color
Veneer (LKV)	See Edge Detail Options	Essentials	See Essentials Wood Finish Options	N None CT2 Dual Power Center Top CU2 Dual Power Underside CT2U1 Dual Power Center Top with Underside (See chart above)	See Metal Finish Color Options
		Artisan	4 Wood Finish See Artisan Wood Finish Options		

Description

Rounded Boat 3pc Table with T Base at Working Height

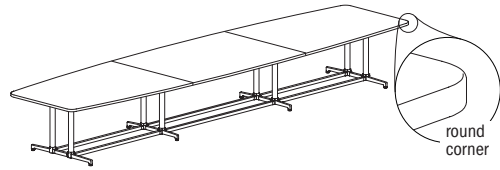

Laminate Tables
"LKT" Models

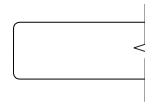

Eased Edge (R3)

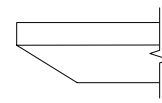

Reverse Bevel Edge (K9)

LAMINATE	D	W	H	CTN WT	CU FT	1 Model	Standard Tier 1	Graded In Tier 2	Standard Tier 1	Graded In Tier 2
		60	240	29	636	281	LKT60240-29BTRT	\$10,259	\$10,426	\$10,959
	60	216	29	584	253	LKT60216-29BTRT	\$8,745	\$8,892	\$9,414	\$9,563
	54	240	29	586	254	LKT54240-29BTRT	\$8,276	\$8,423	\$8,940	\$9,088
	54	216	29	538	229	LKT54216-29BTRT	\$7,782	\$7,917	\$8,422	\$8,554
	48	240	29	534	228	LKT48240-29BTRT	\$7,883	\$8,016	\$8,513	\$8,644
	48	216	29	538	206	LKT48216-29BTRT	\$6,974	\$7,093	\$7,581	\$7,700

Features:

- price reflects complete table - top and base
- ships KD in multiple cartons
- three piece top
- model includes adjustable glide

Options:

- specify power/charging option, see below for options and upcharges



top shape

LOK - CONFERENCE

To Order Specify

1 Laminate Model #	2 Edge Detail	3 Laminate Selection	3a PVC Edge Color	4 Electrical	5 Metal Color
Laminate (LKT)	See Edge Detail Options	See Laminate Selection	See PVC Edge Color Options	N None CT6 Six Power Center Top CU2 Dual Power Underside CT6U2 Six Power Center Top with Underside (See chart on next page)	See Metal Finish Color Options

Model Number Breakdown

LKT60240-29BTRT						
LK	T	60240	29	BT	R	T
LOK	Laminate	60" x 240"	Height	Boat Top Shape	Rounded Corner	T base

Description

Rounded Boat 3pc Table with T Base at Working Height (continued)

Veneer Tables "LKV" Models

Solid Surface Tables "LKS" Models

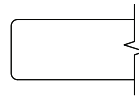

Eased Edge (R3)

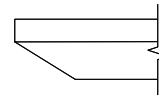

Reverse Bevel Edge (K9)

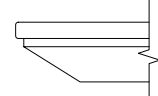

Reverse Bevel Edge (S7)

	D	W	H	CTN WT	CU FT	① Model	Veneer		Solid Surface		
							Essentials	Artisan	Essentials	Artisan	Standard
VENEER	60	240	29	636	281	LKV60240-29BTRT	\$15,957	\$17,234	\$17,393	\$18,524	--
	60	216	29	584	253	LKV60216-29BTRT	\$14,046	\$15,169	\$15,309	\$16,305	--
	54	240	29	586	254	LKV54240-29BTRT	\$13,519	\$14,614	\$14,156	\$15,197	--
	54	216	29	538	229	LKV54216-29BTRT	\$12,545	\$13,519	\$13,130	\$14,053	--
	48	240	29	534	228	LKV48240-29BTRT	\$12,683	\$13,649	\$13,263	\$14,175	--
	48	216	29	538	206	LKV48216-29BTRT	\$11,140	\$11,998	\$11,675	\$12,484	--
SOLID SURFACE	60	240	29	636	281	LKS60240-29BTRT	--	--	--	--	\$35,826
	60	216	29	584	253	LKS60216-29BTRT	--	--	--	--	\$32,381
	54	240	29	586	254	LKS54240-29BTRT	--	--	--	--	\$32,600
	54	216	29	538	229	LKS54216-29BTRT	--	--	--	--	\$29,499
	48	240	29	534	228	LKS48240-29BTRT	--	--	--	--	\$29,441
	48	216	29	538	206	LKS48216-29BTRT	--	--	--	--	\$26,032

Electrical Options and Upcharges

	216 - 240 wide
CT6	
Six Power Center Top - Black	CT6BL - add \$4,137
Six Power Center Top - White	CT6WH - add \$4,137
CU2	
Dual Power Underside - Black	CU2-1C - add \$1,084
Dual Power Underside with 4 Wireless Charging - Black	CU2-1CW - add \$2,740
CT6U2	
Six Power Center Top - Black with Dual Underside	CT6U2-BL - add \$4,805
Six Power Center Top - White with Dual Underside	CT6U2-WH - add \$4,805
Six Power Center Top - Black Dual Underside with 4 Wireless Charging	CT6U2-BLW2 - add \$6,410
Six Power Center Top - White Dual Underside with 4 Wireless Charging	CT6U2-WHW2 - add \$6,410

LOK - CONFERENCE

To Order Specify

Note: Order power infed that best fits application

① Veneer Model #	② Edge Detail	③ Wood Collection	④ Wood Finish	⑤ Electrical	⑥ Metal Color
Veneer (LKV)	See Edge Detail Options	Essentials	See Essentials Wood Finish Options	N None CT6 Six Power Center Top CU2 Dual Power Underside CT6U2 Six Power Center Top with Underside (See chart above)	See Metal Finish Color Options
		Artisan	④ Wood Finish See Artisan Wood Finish Options		

① Solid Surface Model #	② Top Surface Selection	③ Electrical	④ Metal Color
Solid Surface (LKS)	See Solid Surface Top Surface Selection Options	N None CT6 Six Power Center Top CU2 Dual Power Underside CT6U2 Six Power Center Top with Underside (See chart above)	See Metal Finish Color Options

Description

Rounded Boat 2pc Table with T Base at Working Height

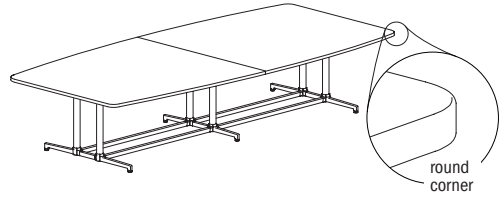

Laminate Tables "LKT" Models

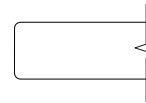

Eased Edge (R3)

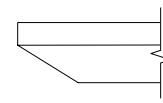

Reverse Bevel Edge (K9)

D	W	H	CTN WT	CU FT	Model	Eased Edge (R3)		Reverse Bevel Edge (K9)	
						Standard Tier 1	Graded In Tier 2	Standard Tier 1	Graded In Tier 2
60	192	29	511	226	LKT60192-29BTRT	\$7,146	\$7,280	\$7,781	\$7,913
60	168	29	449	198	LKT60168-29BTRT	\$6,669	\$6,784	\$7,273	\$7,389
60	144	29	395	169	LKT60144-29BTRT	\$6,153	\$6,251	\$6,728	\$6,826
60	120	29	342	143	LKT60120-29BTRT	\$5,455	\$5,537	\$6,000	\$6,082
54	192	29	459	204	LKT54192-29BTRT	\$6,800	\$6,920	\$7,408	\$7,527
54	168	29	377	178	LKT54168-29BTRT	\$6,159	\$6,264	\$6,743	\$6,845
54	144	29	365	154	LKT54144-29BTRT	\$5,674	\$5,764	\$6,230	\$6,319
54	120	29	316	130	LKT54120-29BTRT	\$5,083	\$5,157	\$5,608	\$5,683
48	192	29	419	183	LKT48192-29BTRT	\$5,933	\$6,039	\$6,515	\$6,620
48	168	29	377	161	LKT48168-29BTRT	\$5,516	\$5,608	\$6,073	\$6,166
48	144	29	334	139	LKT48144-29BTRT	\$5,060	\$5,139	\$5,594	\$5,674
48	120	29	290	116	LKT48120-29BTRT	\$4,547	\$4,613	\$5,058	\$5,125
48	108	29	268	105	LKT48108-29BTRT	\$3,852	\$3,910	\$4,349	\$4,409

LAMINATE

Features:

- price reflects complete table - top and base
- ships KD in multiple cartons
- two piece top
- model includes adjustable glide

Options:

- specify power/charging option, see below for options and upcharges

Electrical Options and Upcharges

	108 wide	120 - 192 wide
CT2		
Dual Power Center Top - Black	CT2BL - add \$1,535	n/a
Dual Power Center Top - White	CT2WH - add \$1,535	n/a
CU1		
Single Power Underside - Black	CU1-1C - add \$610	CU1-1C - add \$709
Single Power Underside with Wireless Charging - Black	CU1-1CW - add \$1,413	CU1-1CW - add \$1,484
CT2U1		
Dual Power Center Top - Black with Underside	CT2U1-BL - add \$1,868	n/a
Dual Power Center Top - White with Underside	CT2U1-WH - add \$1,868	n/a
Dual Power Center Top - Black with Wireless Charging	CT2U1-BLW2 - add \$2,670	n/a
Dual Power Center Top - White with Wireless Charging	CT2U1-WHW2 - add \$2,670	n/a

Note: Order power infeed that best fits application.

	108 wide	120 - 192 wide
CT4U1		
Four Power Center Top with Single Underside - Black	n/a	CT4U1-BL - add \$3,265
Four Power Center Top with Single Underside - White	n/a	CT4U1-WH - add \$3,265
Four Power Center Top - Black with Underside & Wireless Charging	n/a	CT4U1-BLW2 - add \$4,046
Four Power Center Top - White with Underside & Wireless Charging	n/a	CT4U1-WHW2 - add \$4,046
CT4		
Four Power Center Top - Black	n/a	CT4BL - add \$2,859
Four Power Center Top - White	n/a	CT4WH - add \$2,859



top shape

To Order Specify

1 Laminate Model #	2 Edge Detail	3 Laminate Selection	3a PVC Edge Color	4 Electrical	5 Metal Color
Laminate (LKT)	See Edge Detail Options	See Laminate Selection	See PVC Edge Color Options	N None CT2 Dual Power Center Top CU2 Dual Power Underside CT2U1 Dual Power Center Top with Underside CT4U2 Four Power Center Top with Underside CT4 Four Power Center Top (See chart above)	See Metal Finish Color Options

Model Number Breakdown

LKT60192-29BTRT						
LK	T	60192	29	BT	R	T
LOK	Laminate	60" x 192"	Height	Boat Top Shape	Rounded Corner	T base

LOK - CONFERENCE

Description

Rounded Boat 2pc Table with T Base at Working Height (continued)

Veneer Tables "LKV" Models

Solid Surface Tables "LKS" Models

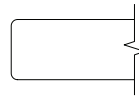

Eased Edge (R3)

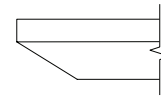

Reverse Bevel Edge (K9)

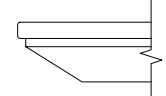

Reverse Bevel Edge (S7)

	D	W	H	CTN WT	CU FT	① Model	Veneer Tables "LKV" Models		Solid Surface Tables "LKS" Models			
							Essentials	Artisan	Essentials	Artisan	Standard	
VENEER	60	192	29	511	226	LKV60192-29BTRT	\$11,121	\$12,011	\$12,121	\$12,908	--	
	60	168	29	449	198	LKV60168-29BTRT	\$10,229	\$11,047	\$11,149	\$11,874	--	
	60	144	29	395	169	LKV60144-29BTRT	\$9,311	\$10,056	\$10,148	\$10,808	--	
	60	120	29	342	143	LKV60120-29BTRT	\$8,216	\$8,873	\$8,955	\$9,535	--	
	54	192	29	459	204	LKV54192-29BTRT	\$10,172	\$10,988	\$11,089	\$11,807	--	
	54	168	29	377	178	LKV54168-29BTRT	\$9,302	\$10,048	\$10,140	\$10,799	--	
	54	144	29	365	154	LKV54144-29BTRT	\$8,449	\$9,125	\$9,211	\$9,807	--	
	54	120	29	316	130	LKV54120-29BTRT	\$7,477	\$8,075	\$8,149	\$8,676	--	
	48	192	29	419	183	LKV48192-29BTRT	\$9,135	\$9,884	\$9,624	\$10,330	--	
	48	168	29	377	161	LKV48168-29BTRT	\$8,375	\$9,021	\$8,820	\$9,431	--	
	48	144	29	334	139	LKV48144-29BTRT	\$7,584	\$8,130	\$7,989	\$8,502	--	
	48	120	29	290	116	LKV48120-29BTRT	\$6,743	\$7,191	\$7,106	\$7,526	--	
	48	108	29	268	105	LKV48108-29BTRT	\$5,536	\$5,979	\$6,033	\$6,425	--	
	SOLID SURFACE	60	192	29	511	226	LKS60192-29BTRT	--	--	--	--	\$26,908
		60	168	29	449	198	LKS60168-29BTRT	--	--	--	--	\$23,776
		60	144	29	395	169	LKS60144-29BTRT	--	--	--	--	\$20,683
60		120	29	342	143	LKS60120-29BTRT	--	--	--	--	\$22,621	
54		192	29	459	204	LKS54192-29BTRT	--	--	--	--	\$24,361	
54		168	29	377	178	LKS54168-29BTRT	--	--	--	--	\$21,627	
54		144	29	365	154	LKS54144-29BTRT	--	--	--	--	\$18,846	
54		120	29	316	130	LKS54120-29BTRT	--	--	--	--	\$16,010	
48		192	29	419	183	LKS48192-29BTRT	--	--	--	--	\$22,028	
48		168	29	377	161	LKS48168-29BTRT	--	--	--	--	\$19,528	
48		144	29	334	139	LKS48144-29BTRT	--	--	--	--	\$17,049	
48		120	29	290	116	LKS48120-29BTRT	--	--	--	--	\$14,576	
48		108	29	268	105	LKS48108-29BTRT	--	--	--	--	\$13,315	

LOK- CONFERENCE

To Order Specify

① Veneer Model #	② Edge Detail	③ Wood Collection	④ Wood Finish	⑤ Electrical	⑥ Metal Color
Veneer (LKV)	See Edge Detail Options	Essentials	See Essentials Wood Finish Options	N None CT2 Dual Power Center Top CU2 Dual Power Underside CT2U1 Dual Power Center Top with Underside CT4U2 Four Power Center Top with Underside CT4 Four Power Center Top (See chart on previous page)	See Metal Finish Color Options
		Artisan	④ Wood Finish See Artisan Wood Finish Options		

① Solid Surface Model #	② Top Surface Selection	③ Electrical	④ Metal Color
Solid Surface (LKS)	See Solid Surface Top Surface Selection Options	N None CT2 Dual Power Center Top CU2 Dual Power Underside CT2U1 Dual Power Center Top with Underside CT4U2 Four Power Center Top with Underside CT4 Four Power Center Top (See chart on previous page)	See Metal Finish Color Options

Description

Rounded Boat Table with T Base at Working Height

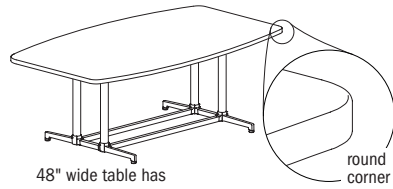

48" wide table has double column base

D	W	H	CTN WT	CU FT	Model
48	96	29	219	83	LKT4896-29BTRT
48	84	29	198	83	LKT4884-29BTRT
42	96	29	177	73	LKT4296-29BTRT
42	84	29	158	72	LKT4284-29BTRT
36	96	29	156	72	LKT3696-29BTRT
36	84	29	146	64	LKT3684-29BTRT

LAMINATE

Laminate Tables "LKT" Models

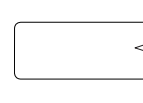

Eased Edge (R3)

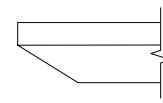

Reverse Bevel Edge (K9)

Eased Edge (R3)		Reverse Bevel Edge (K9)	
Standard Tier 1	Graded In Tier 2	Standard Tier 1	Graded In Tier 2
\$3,239	\$3,290	\$3,725	\$3,779
\$2,875	\$2,924	\$3,350	\$3,396
\$2,940	\$2,986	\$3,414	\$3,459
\$2,422	\$2,463	\$2,888	\$2,928
\$2,472	\$2,513	\$2,934	\$2,974
\$2,219	\$2,251	\$2,670	\$2,706

Features:

- price reflects complete table - top and base
- ships KD in multiple cartons
- one piece top
- model includes adjustable glide

Options:

- specify power/charging option, see below for options and upcharges

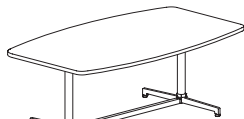

42" & 36" wide tables have single column base



top shape

LOK - CONFERENCE

To Order Specify

1 Laminates Model #	2 Edge Detail	3 Laminates Selection	3a PVC Edge Color	4 Electrical	5 Metal Color
Laminates (LKT)	See Edge Detail Options	See Laminates Selection	See PVC Edge Color Options	N None CT2 Dual Power Center Top CU2 Dual Power Underside CT2U1 Dual Power Center Top with Underside (See chart on next page)	See Metal Finish Color Options

Model Number Breakdown

LKT4896-29BTRT						
LK	T	4896	29	BT	R	T
LOK	Laminates	48" x 96"	Height	Boat Top Shape	Rounded Corner	T base

Description

Rounded Boat Table with T Base at Working Height (continued)

Veneer Tables "LKV" Models Solid Surface Tables "LKS" Models

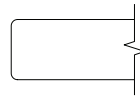

Eased Edge (R3)

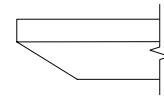

Reverse Bevel Edge (K9)

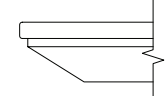

Reverse Bevel Edge (S7)

	D	W	H	CTN WT	CU FT	1 Model	Veneer		Solid Surface		
							Essentials	Artisan	Essentials	Artisan	Standard
VENEER	48	96	29	219	83	LKV4896-29BTRT	\$4,510	\$4,857	\$4,828	\$5,156	--
	48	84	29	198	83	LKV4884-29BTRT	\$4,115	\$4,415	\$4,410	\$4,690	--
	42	96	29	177	73	LKV4296-29BTRT	\$4,394	\$4,747	\$4,789	\$5,100	--
	42	84	29	158	72	LKV4284-29BTRT	\$3,694	\$3,988	\$4,026	\$4,289	--
	36	96	29	156	72	LKV3696-29BTRT	\$3,345	\$3,611	\$3,644	\$3,882	--
	36	84	29	146	64	LKV3684-29BTRT	\$3,077	\$3,321	\$3,353	\$3,570	--
SOLID SURFACE	48	96	29	219	83	LKS4896-29BTRT	--	--	--	--	\$10,569
	48	84	29	198	83	LKS4884-29BTRT	--	--	--	--	\$9,368
	42	96	29	177	73	LKS4296-29BTRT	--	--	--	--	\$8,599
	42	84	29	158	72	LKS4284-29BTRT	--	--	--	--	\$7,579
	36	96	29	156	72	LKS3696-29BTRT	--	--	--	--	\$7,556
	36	84	29	146	64	LKS3684-29BTRT	--	--	--	--	\$6,810

Electrical Options and Upcharges

CT2	84 - 96 wide
Dual Power Center Top - Black	CT2BL - add \$1,535
Dual Power Center Top - White	CT2WH - add \$1,535
CU1	
Single Power Underside - Black	CU1-1C - add \$610
Single Power Underside with Wireless Charging - Black	CU1-1CW - add \$1,413
CT2U1	
Dual Power Center Top - Black with Single Underside	CT2U1-BL - add \$1,904
Dual Power Center Top - White with Single Underside	CT2U1-WH - add \$1,904
Dual Power Center Top - Black with Wireless Charging	CT2U1-BLW2 - add \$2,670
Dual Power Center Top - White with Wireless Charging	CT2U1-WhW2 - add \$2,670

LOK - CONFERENCE

Note: Order power infeed that best fits application

To Order Specify

1 Veneer Model #	2 Edge Detail	3 Wood Collection	4 Wood Finish	5 Electrical	6 Metal Color
Veneer (LKV)	See Edge Detail Options	Essentials	See Essentials Wood Finish Options	N None CT2 Dual Power Center Top CU2 Dual Power Underside CT2U1 Dual Power Center Top with Underside (See chart above)	See Metal Finish Color Options
		Artisan	4 Wood Finish See Artisan Wood Finish Options		

1 Solid Surface Model #	2 Top Surface Selection	3 Electrical	4 Metal Color
Solid Surface (LKS)	See Solid Surface Top Surface Selection Options	N None CT2 Dual Power Center Top CU2 Dual Power Underside CT2U1 Dual Power Center Top with Underside (See chart above)	See Metal Finish Color Options

Description

Boat 3pc Table with Y Base at Working Height

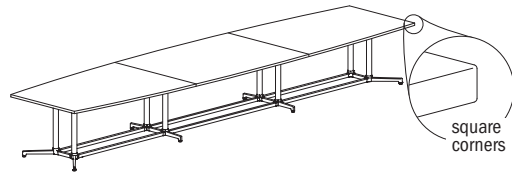

Laminate Tables "LKT" Models

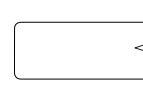

Eased Edge (R3)

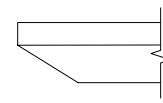

Reverse Bevel Edge (K9)

LAMINATE	D	W	H	CTN WT	CU FT	Model	Eased Edge (R3)		Reverse Bevel Edge (K9)	
							Standard Tier 1	Graded In Tier 2	Standard Tier 1	Graded In Tier 2
	60	240	29	636	281	LKT60240-29BTY	\$9,940	\$10,102	\$10,637	\$10,801
60	216	29	584	253	LKT60216-29BTY	\$8,404	\$8,554	\$9,073	\$9,222	
54	240	29	575	254	LKT54240-29BTY	\$7,864	\$8,011	\$8,527	\$8,675	
54	216	29	523	229	LKT54216-29BTY	\$7,029	\$7,163	\$7,666	\$7,800	
48	240	29	537	228	LKT48240-29BTY	\$7,598	\$7,732	\$8,227	\$8,359	
48	216	29	477	206	LKT48216-29BTY	\$7,042	\$7,161	\$7,651	\$7,768	

Features:

- price reflects complete table - top and base
- ships KD in multiple cartons
- three piece top
- model includes adjustable glide

Options:

- specify power/charging option, see below for options and upcharges



top shape

LOK - CONFERENCE

To Order Specify

1 Laminate Model #	2 Edge Detail	3 Laminate Selection	4 PVC Edge Color	4 Electrical	5 Metal Color
Laminate (LKT)	See Edge Detail Options	See Laminate Selection	See PVC Edge Color Options	N None CT6 Six Power Center Top CU2 Dual Power Underside CT6U2 Six Power Center Top with Underside (See chart on next page)	See Metal Finish Color Options

Model Number Breakdown

LKT60240-29BTY					
LK	T	60240	29	BT	Y
LOK	Laminate	60" x 240"	Height	Boat Top Shape	Y base

Description

Boat 3pc Table with Y Base
at Working Height
(continued)

Veneer Tables
"LKV" Models

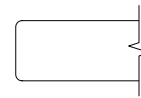

Eased Edge (R3)

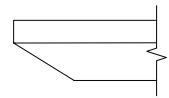

Reverse Bevel Edge (K9)

D	W	H	CTN WT	CU FT	① Model	Eased Edge (R3)		Reverse Bevel Edge (K9)		
						Essentials	Artisan	Essentials	Artisan	
60	240	29	636	281	LKV60240-29BTY	\$15,475	\$16,712	\$16,868	\$17,963	
60	216	29	584	253	LKV60216-29BTY	\$13,543	\$14,626	\$14,760	\$15,721	
VENEER	54	240	29	575	254	LKV54240-29BTY	\$12,909	\$14,008	\$13,547	\$14,589
	54	216	29	523	229	LKV54216-29BTY	\$11,451	\$12,423	\$12,038	\$12,960
	48	240	29	537	228	LKV48240-29BTY	\$12,269	\$13,235	\$12,846	\$13,761
	48	216	29	477	206	LKV48216-29BTY	\$11,240	\$12,095	\$11,772	\$12,581

Electrical Options and Upcharges

	216 - 240 wide
CT6	
Six Power Center Top - Black	CT6BL - add \$4,137
Six Power Center Top - White	CT6WH - add \$4,137
CU2	
Dual Power Underside - Black	CU2-1C - add \$1,084
Dual Power Underside with 4 Wireless Charging - Black	CU2-1CW - add \$2,740
CT6U2	
Six Power Center Top - Black with Dual Underside	CT6U2-BL - add \$4,805
Six Power Center Top - White with Dual Underside	CT6U2-WH - add \$4,805
Six Power Center Top - Black Dual Underside with 4 Wireless Charging	CT6U2-BLW2 - add \$6,410
Six Power Center Top - White Dual Underside with 4 Wireless Charging	CT6U2-WHW2 - add \$6,410

Note: Order power infeed that best fits application

To Order Specify

① Veneer Model #	② Edge Detail	③ Wood Collection	④ Wood Finish	⑤ Electrical	⑥ Metal Color
Veneer (LKV)	See Edge Detail Options	Essentials	See Essentials Wood Finish Options	N None CT6 Six Power Center Top CU2 Dual Power Underside CT6U2 Six Power Center Top with Underside (See chart above)	See Metal Finish Color Options
		Artisan	④ Wood Finish See Artisan Wood Finish Options		

LOK - CONFERENCE

Description

Boat 2pc Table with Y Base at Working Height

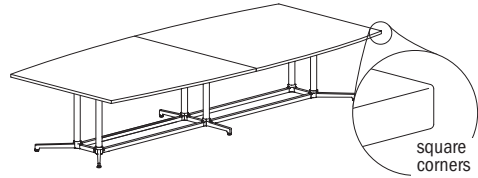

Laminate Tables "LKT" Models

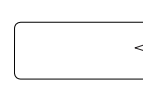

Eased Edge (R3)

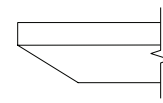

Reverse Bevel Edge (K9)

D	W	H	CTN WT	CU FT	Model	Eased Edge (R3)		Reverse Bevel Edge (K9)		
						Standard Tier 1	Graded In Tier 2	Standard Tier 1	Graded In Tier 2	
60	192	29	511	226	LKT60192-29BTY	\$6,951	\$7,082	\$7,586	\$7,717	
60	168	29	449	198	LKT60168-29BTY	\$6,457	\$6,573	\$7,063	\$7,179	
60	144	29	333	169	LKT60144-29BTY	\$5,883	\$5,981	\$6,456	\$6,555	
60	120	29	334	143	LKT60120-29BTY	\$5,299	\$5,380	\$5,844	\$5,926	
LAMINATE	54	192	29	449	204	LKT54192-29BTY	\$6,708	\$6,826	\$7,318	\$7,435
	54	168	29	359	178	LKT54168-29BTY	\$5,973	\$6,077	\$6,555	\$6,659
	54	144	29	356	154	LKT54144-29BTY	\$5,431	\$5,519	\$5,987	\$6,073
	54	120	29	308	130	LKT54120-29BTY	\$4,976	\$5,050	\$5,504	\$5,578
48	192	29	409	183	LKT48192-29BTY	\$6,523	\$6,630	\$7,104	\$7,209	
48	168	29	363	161	LKT48168-29BTY	\$5,290	\$5,380	\$5,847	\$5,937	
48	144	29	323	139	LKT48144-29BTY	\$4,899	\$4,978	\$5,435	\$5,514	
48	120	29	283	116	LKT48120-29BTY	\$4,427	\$4,494	\$4,939	\$5,004	
48	108	29	262	105	LKT48108-29BTY	\$3,944	\$4,004	\$4,444	\$4,502	

Features:

- price reflects complete table - top and base
- ships KD in multiple cartons
- two piece top
- model includes adjustable glide

Options:

- specify power/charging option, see below for options and upcharges



top shape

LOK - CONFERENCE

To Order Specify

1 Laminate Model #	2 Edge Detail	3 Laminate Selection	3a PVC Edge Color	4 Electrical	5 Metal Color
Laminate (LKT)	See Edge Detail Options	See Laminate Selection	See PVC Edge Color Options	N None CT2 Dual Power Center Top CU2 Dual Power Underside CT2U1 Dual Power Center Top with Underside CT4U2 Four Power Center Top with Underside CT4 Four Power Center Top (See chart on next page)	See Metal Finish Color Options

Model Number Breakdown

LKT60192-29BTY					
LK	T	60192	29	BT	Y
LOK	Laminate	60" x 192"	Height	Boat Top Shape	Y base

Description

Boat 2pc Table with Y Base
at Working Height
(continued)

Veneer Tables
"LKV" Models

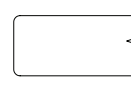

Eased Edge (R3)

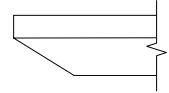

Reverse Bevel Edge (K9)

D	W	H	CTN WT	CU FT	Model	Eased Edge (R3)		Reverse Bevel Edge (K9)		
						Essentials	Artisan	Essentials	Artisan	
60	192	29	511	226	LKV60192-29BTY	\$10,837	\$11,704	\$11,813	\$12,580	
60	168	29	449	198	LKV60168-29BTY	\$9,929	\$10,723	\$10,824	\$11,526	
60	144	29	333	169	LKV60144-29BTY	\$8,932	\$9,645	\$9,735	\$10,366	
60	120	29	334	143	LKV60120-29BTY	\$8,001	\$8,639	\$8,718	\$9,286	
VENEER	54	192	29	449	204	LKV54192-29BTY	\$10,041	\$10,845	\$10,945	\$11,655
	54	168	29	359	178	LKV54168-29BTY	\$9,043	\$9,767	\$9,856	\$10,497
	54	144	29	356	154	LKV54144-29BTY	\$8,114	\$8,763	\$8,844	\$9,420
	54	120	29	308	130	LKV54120-29BTY	\$7,334	\$7,919	\$7,995	\$8,511
48	192	29	409	183	LKV48192-29BTY	\$9,960	\$10,709	\$10,450	\$11,158	
48	168	29	363	161	LKV48168-29BTY	\$8,062	\$8,707	\$8,508	\$9,115	
48	144	29	323	139	LKV48144-29BTY	\$7,368	\$7,913	\$7,771	\$8,286	
48	120	29	283	116	LKV48120-29BTY	\$6,583	\$7,032	\$6,948	\$7,369	
48	108	29	262	105	LKV48108-29BTY	\$5,657	\$6,109	\$6,166	\$6,567	

Electrical Options and Upcharges

CT2	108 wide	120 - 192 wide
Dual Power Center Top - Black	CT2BL - add \$1,535	n/a
Dual Power Center Top - White	CT2WH - add \$1,535	n/a
CU1		
Single Power Underside - Black	CU1-1C - add \$610	CU1-1C - add \$709
Single Power Underside with Wireless Charging - Black	CU1-1CW - add \$1,413	CU1-1CW - add \$1,484
CT2U1		
Dual Power Center Top - Black with Underside	CT2U1-BL - add \$1,868	n/a
Dual Power Center Top - White with Underside	CT2U1-WH - add \$1,868	n/a
Dual Power Center Top - Black with Wireless Charging	CT2U1-BLW2 - add \$2,670	n/a
Dual Power Center Top - White with Wireless Charging	CT2U1-WHW2 - add \$2,670	n/a

CT4U1	108 wide	120 - 192 wide
Four Power Center Top with Single Underside - Black	n/a	CT4U1-BL - add \$3,265
Four Power Center Top with Single Underside - White	n/a	CT4U1-WH - add \$3,265
Four Power Center Top - Black with Underside & Wireless Charging	n/a	CT4U1-BLW2 - add \$4,046
Four Power Center Top - White with Underside & Wireless Charging	n/a	CT4U1-WHW2 - add \$4,046
CT4		
Four Power Center Top - Black	n/a	CT4BL - add \$2,859
Four Power Center Top - White	n/a	CT4WH - add \$2,859

Note: Order power infeed that best fits application

To Order Specify

1 Veneer Model #	2 Edge Detail	3 Wood Collection	4 Wood Finish	5 Electrical	6 Metal Color
Veneer (LKV)	See Edge Detail Options	Essentials	See Essentials Wood Finish Options	N None CT2 Dual Power Center Top CU2 Dual Power Underside CT2U1 Dual Power Center Top with Underside CT4U2 Four Power Center Top with Underside CT4 Four Power Center Top	See Metal Finish Color Options
		Artisan	4 Wood Finish See Artisan Wood Finish Options		

LOK - CONFERENCE

Description

Boat Table with Y Base at Working Height

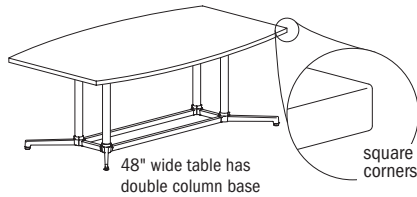

Laminate Tables "LKT" Models

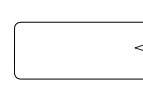

Eased Edge (R3)

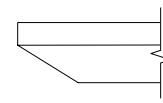

Reverse Bevel Edge (K9)

LAMINATE	D	W	H	CTN WT	CU FT	Model	Eased Edge (R3)		Reverse Bevel Edge (K9)	
							Standard Tier 1	Graded In Tier 2	Standard Tier 1	Graded In Tier 2
	48	96	29	219	105	LKT4896-29BTY	\$3,258	\$3,310	\$3,744	\$3,796
	48	84	29	327	83	LKT4884-29BTY	\$2,859	\$2,905	\$3,333	\$3,382
	42	96	29	168	83	LKT4296-29BTY	\$3,102	\$3,149	\$3,575	\$3,624
	42	84	29	636	281	LKT4284-29BTY	\$2,599	\$2,639	\$3,063	\$3,105
	36	96	29	636	281	LKT3696-29BTY	\$2,526	\$2,565	\$2,986	\$3,027
	36	84	29	648	281	LKT3684-29BTY	\$2,271	\$2,307	\$2,724	\$2,758

Features:

- price reflects complete table - top and base
- ships KD in multiple cartons
- one piece top
- model includes adjustable glide

Options:

- specify power/charging option, see below for options and upcharges

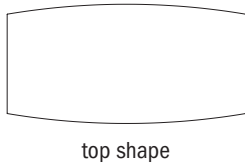
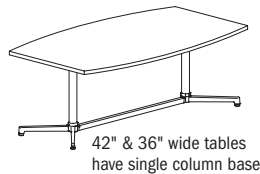

LOK - CONFERENCE

To Order Specify

1 Laminite Model #	2 Edge Detail	3 Laminite Selection	3a PVC Edge Color	4 Electrical	5 Metal Color
Laminite (LKT)	See Edge Detail Options	See Laminite Selection	See PVC Edge Color Options	N None CT2 Dual Power Center Top CU2 Dual Power Underside CT2U1 Dual Power Center Top with Underside (See chart on next page)	See Metal Finish Color Options

Model Number Breakdown

LKT4896-29BTY					
LK	T	4896	29	BT	Y
LOK	Laminite	48" x 96"	Height	Boat Top Shape	Y base

Description

Boat Table with
Y Base at Working Height
(continued)

Veneer Tables
"LKV" Models

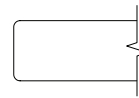

Eased Edge (R3)

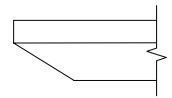

Reverse Bevel Edge (K9)

D	W	H	CTN WT	CU FT	① Model	Eased Edge (R3)		Reverse Bevel Edge (K9)	
						Essentials	Artisan	Essentials	Artisan
48	96	29	219	105	LKV4896-29BTY	\$4,536	\$4,884	\$4,853	\$5,179
48	84	29	327	83	LKV4884-29BTY	\$4,092	\$4,392	\$4,389	\$4,669
42	96	29	168	83	LKV4296-29BTY	\$4,598	\$4,965	\$5,011	\$5,338
	84	29	636	281	LKV4284-29BTY	\$3,910	\$4,223	\$4,262	\$4,539
36	96	29	636	281	LKV3696-29BTY	\$3,410	\$3,681	\$3,715	\$3,957
36	84	29	648	281	LKV3684-29BTY	\$3,141	\$3,392	\$3,423	\$3,644

VENEER

Electrical Options and Upcharges

CT2	84 - 96 wide
Dual Power Center Top - Black	CT2BL - add \$1,535
Dual Power Center Top - White	CT2WH - add \$1,535
CU1	
Single Power Underside - Black	CU1-1C - add \$610
Single Power Underside with Wireless Charging - Black	CU1-1CW - add \$1,413
CT2U1	
Dual Power Center Top - Black with Single Underside	CT2U1-BL - add \$1,904
Dual Power Center Top - White with Single Underside	CT2U1-WH - add \$1,904
Dual Power Center Top - Black with Wireless Charging	CT2U1-BLW2 - add \$2,670
Dual Power Center Top - White with Wireless Charging	CT2U1-WHW2 - add \$2,670

Note: Order power infed that best fits application

To Order Specify

① Veneer Model #	② Edge Detail	③ Wood Collection	④ Wood Finish	⑤ Electrical	⑥ Metal Color
Veneer (LKV)	See Edge Detail Options	Essentials	See Essentials Wood Finish Options	N None CT2 Dual Power Center Top CU2 Dual Power Underside CT2U1 Dual Power Center Top with Underside (See chart above)	See Metal Finish Color Options
		Artisan	④ Wood Finish See Artisan Wood Finish Options		

LOK - CONFERENCE

Description

Rounded Double Chevron Table with T Base at Working Height

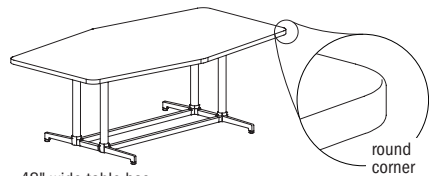

48" wide table has double column base

Laminate Tables "LKT" Models

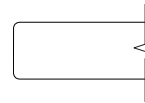

Eased Edge (R3)

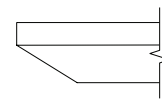

Reverse Bevel Edge (K9)

LAMINATE	D	W	H	CTN WT	CU FT	1 Model	Eased Edge (R3)		Reverse Bevel Edge (K9)	
							Standard Tier 1	Graded In Tier 2	Standard Tier 1	Graded In Tier 2
	48	96	29	204	105	LKT4896-29DCRT	\$3,239	\$3,290	\$3,725	\$3,779
48	84	29	182	83	LKT4884-29DCRT	\$2,875	\$2,924	\$3,350	\$3,396	
42	96	29	161	73	LKT4296-29DCRT	\$2,940	\$2,986	\$3,414	\$3,459	
42	84	29	142	72	LKT4284-29DCRT	\$2,422	\$2,463	\$2,888	\$2,928	
36	96	29	146	72	LKT3696-29DCRT	\$2,472	\$2,513	\$2,934	\$2,974	
36	84	29	134	64	LKT3684-29DCRT	\$2,219	\$2,251	\$2,670	\$2,706	

Features:

- price reflects complete table - top and base
- ships KD in multiple cartons
- one piece top
- model includes adjustable glide

Options:

- specify power/charging option, see below for options and upcharges

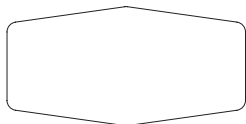
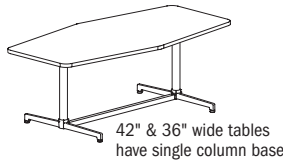

top shape

LOK - CONFERENCE

To Order Specify

1 Laminite Model #	2 Edge Detail	3 Laminite Selection	3a PVC Edge Color	4 Electrical	5 Metal Color
Laminite (LKT)	See Edge Detail Options	See Laminite Selection	See PVC Edge Color Options	N None CT2 Dual Power Center Top CU2 Dual Power Underside CT2U1 Dual Power Center Top with Underside (See chart on next page)	See Metal Finish Color Options

Model Number Breakdown

LKT4896-29DCRT						
LK	T	4896	29	DC	R	T
LOK	Laminite	48" x 96"	Height	Double Chevron Top Shape	Rounded Corner	T base

Description

Rounded Double Chevron Table with T Base at Working Height (continued)

Veneer Tables "LKV" Models Solid Surface Tables "LKS" Models

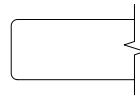

Eased Edge (R3)

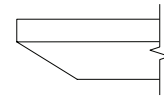

Reverse Bevel Edge (K9)

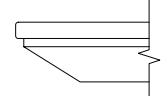

Reverse Bevel Edge (S7)

	D	W	H	CTN WT	CU FT	① Model	Veneer		Solid Surface		
							Essentials	Artisan	Essentials	Artisan	Standard
VENEER	48	96	29	204	105	LKV4896-29DCRT	\$4,510	\$4,857	\$4,828	\$5,156	--
	48	84	29	182	83	LKV4884-29DCRT	\$4,115	\$4,415	\$4,410	\$4,690	--
	42	96	29	161	73	LKV4296-29DCRT	\$4,394	\$4,747	\$4,789	\$5,100	--
	42	84	29	142	72	LKV4284-29DCRT	\$3,694	\$3,988	\$4,026	\$4,289	--
	36	96	29	146	72	LKV3696-29DCRT	\$3,345	\$3,611	\$3,644	\$3,882	--
	36	84	29	134	64	LKV3684-29DCRT	\$3,077	\$3,321	\$3,353	\$3,570	--
SOLID SURFACE	48	96	29	204	105	LKS4896-29DCRT	--	--	--	--	\$10,569
	48	84	29	182	83	LKS4884-29DCRT	--	--	--	--	\$9,368
	42	96	29	161	73	LKS4296-29DCRT	--	--	--	--	\$8,599
	42	84	29	142	72	LKS4284-29DCRT	--	--	--	--	\$7,579
	36	96	29	146	72	LKS3696-29DCRT	--	--	--	--	\$7,556
	36	84	29	134	64	LKS3684-29DCRT	--	--	--	--	\$6,810

Electrical Options and Upcharges

CT2	84 - 96 wide
Dual Power Center Top - Black	CT2BL - add \$1,535
Dual Power Center Top - White	CT2WH - add \$1,535
CU1	
Single Power Underside - Black	CU1-1C - add \$610
Single Power Underside with Wireless Charging - Black	CU1-1CW - add \$1,413
CT2U1	
Dual Power Center Top - Black with Single Underside	CT2U1-BL - add \$1,904
Dual Power Center Top - White with Single Underside	CT2U1-WH - add \$1,904
Dual Power Center Top - Black with Wireless Charging	CT2U1-BLW2 - add \$2,670
Dual Power Center Top - White with Wireless Charging	CT2U1-WHW2 - add \$2,670

Note: Order power infeed that best fits application

To Order Specify

① Veneer Model #	② Edge Detail	③ Wood Collection	④ Wood Finish	⑤ Electrical	⑥ Metal Color
Veneer (LKV)	See Edge Detail Options	Essentials	See Essentials Wood Finish Options	N None CT2 Dual Power Center Top CU2 Dual Power Underside CT2U1 Dual Power Center Top with Underside (See chart above)	See Metal Finish Color Options
		Artisan	④ Wood Finish See Artisan Wood Finish Options		

① Solid Surface Model #	② Top Surface Selection	③ Electrical	④ Metal Color
Solid Surface (LKS)	See Solid Surface Top Surface Selection Options	N None CT2 Dual Power Center Top CU2 Dual Power Underside CT2U1 Dual Power Center Top with Underside (See chart above)	See Metal Finish Color Options

LOK - CONFERENCE

Description

Rounded Double Chevron Table with Y Base at Working Height

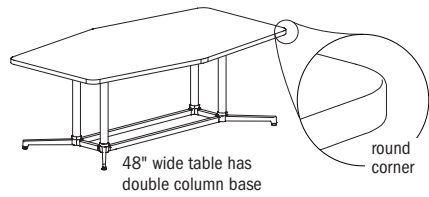

Laminate Tables "LKT" Models

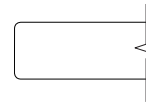

Eased Edge (R3)

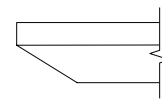

Reverse Bevel Edge (K9)

LAMINATE	D	W	H	CTN WT	CU FT	Model	Standard Tier 1	Graded In Tier 2	Standard Tier 1	Graded In Tier 2
	48	96	29	199	105	LKT4896-29DCRY	\$3,258	\$3,310	\$3,744	\$3,796
	48	84	29	312	83	LKT4884-29DCRY	\$2,859	\$2,905	\$3,333	\$3,382
42	96	29	153	83	LKT4296-29DCRY	\$3,102	\$3,149	\$3,575	\$3,624	
42	84	29	153	72	LKT4284-29DCRY	\$2,599	\$2,639	\$3,063	\$3,105	
36	96	29	150	72	LKT3696-29DCRY	\$2,526	\$2,565	\$2,986	\$3,027	
36	84	29	144	64	LKT3684-29DCRY	\$2,271	\$2,307	\$2,724	\$2,758	

Features:

- price reflects complete table - top and base
- ships KD in multiple cartons
- one piece top
- model includes adjustable glide

Options:

- specify power/charging option, see below for options and upcharges

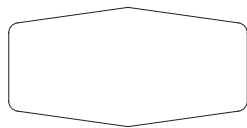
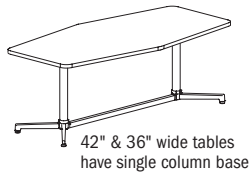

LOK - CONFERENCE

To Order Specify

1 Laminate Model #	2 Edge Detail	3 Laminate Selection	3a PVC Edge Color	4 Electrical	5 Metal Color
Laminate (LKT)	See Edge Detail Options	See Laminate Selection	See PVC Edge Color Options	N None CT2 Dual Power Center Top CU2 Dual Power Underside CT2U1 Dual Power Center Top with Underside (See chart on next page)	See Metal Finish Color Options

Model Number Breakdown

LKT4896-29DCRY						
LK	T	4896	29	DC	R	Y
LOK	Laminate	48" x 96"	Height	Double Chevron Top Shape	Rounded Corner	Y base

Description

Rounded Double Chevron Table with Y Base at Working Height (continued)

Veneer Tables "LKV" Models Solid Surface Tables "LKS" Models

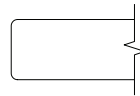

Eased Edge (R3)

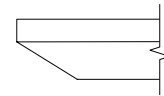

Reverse Bevel Edge (K9)

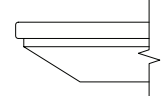

Reverse Bevel Edge (S7)

	D	W	H	CTN WT	CU FT	① Model	Veneer		Solid Surface		
							Essentials	Artisan	Essentials	Artisan	Standard
VENEER	48	96	29	199	105	LKV4896-29DCRY	\$4,536	\$4,884	\$4,853	\$5,179	--
	48	84	29	312	83	LKV4884-29DCRY	\$4,092	\$4,392	\$4,389	\$4,669	--
	42	96	29	153	83	LKV4296-29DCRY	\$4,598	\$4,965	\$5,011	\$5,338	--
	42	84	29	153	72	LKV4284-29DCRY	\$3,910	\$4,223	\$4,262	\$4,539	--
	36	96	29	150	72	LKV3696-29DCRY	\$3,410	\$3,681	\$3,715	\$3,957	--
	36	84	29	144	64	LKV3684-29DCRY	\$3,141	\$3,392	\$3,423	\$3,644	--
SOLID SURFACE	48	96	29	199	105	LKS4896-29DCRY	--	--	--	--	\$10,592
	48	84	29	312	83	LKS4884-29DCRY	--	--	--	--	\$9,350
	42	96	29	153	83	LKS4296-29DCRY	--	--	--	--	\$8,801
	42	84	29	153	72	LKS4284-29DCRY	--	--	--	--	\$7,793
	36	96	29	150	72	LKS3696-29DCRY	--	--	--	--	\$7,620
	36	84	29	144	64	LKS3684-29DCRY	--	--	--	--	\$6,875

Electrical Options and Upcharges

CT2	84 - 96 wide
Dual Power Center Top - Black	CT2BL - add \$1,535
Dual Power Center Top - White	CT2WH - add \$1,535
CU1	
Single Power Underside - Black	CU1-1C - add \$610
Single Power Underside with Wireless Charging - Black	CU1-1CW - add \$1,413
CT2U1	
Dual Power Center Top - Black with Single Underside	CT2U1-BL - add \$1,904
Dual Power Center Top - White with Single Underside	CT2U1-WH - add \$1,904
Dual Power Center Top - Black with Wireless Charging	CT2U1-BLW2 - add \$2,670
Dual Power Center Top - White with Wireless Charging	CT2U1-WHW2 - add \$2,670

LOK - CONFERENCE

Note: Order power infeed that best fits application

To Order Specify

① Veneer Model #	② Edge Detail	③ Wood Collection	④ Wood Finish	⑤ Electrical	⑥ Metal Color
Veneer (LKV)	See Edge Detail Options	Essentials	See Essentials Wood Finish Options	N None CT2 Dual Power Center Top CU2 Dual Power Underside CT2U1 Dual Power Center Top with Underside (See chart above)	See Metal Finish Color Options
		Artisan	④ Wood Finish See Artisan Wood Finish Options		

① Solid Surface Model #	② Top Surface Selection	③ Electrical	④ Metal Color
Solid Surface (LKS)	See Solid Surface Top Surface Selection Options	N None CT2 Dual Power Center Top CU2 Dual Power Underside CT2U1 Dual Power Center Top with Underside (See chart above)	See Metal Finish Color Options

Description

Taper 2pc Table with T Base at Working Height

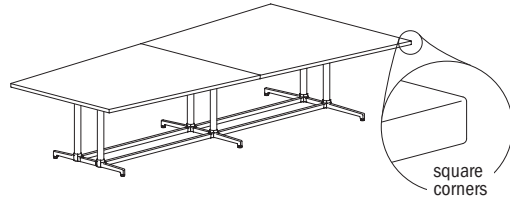

Laminate Tables "LKT" Models

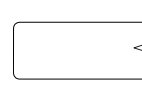

Eased Edge (R3)

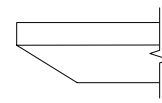

Reverse Bevel Edge (K9)

LAMI	D	W	H	CTN WT	CU FT	Model	Standard Tier 1	Graded In Tier 2	Standard Tier 1	Graded In Tier 2
		60	120	29	312	143	LKT60120-29TPT	\$5,416	\$5,501	\$5,961

Features:

- price reflects complete table - top and base
- ships KD in multiple cartons
- two piece top
- model includes adjustable glide

Options:

- specify power/charging option, see below for options and upcharges

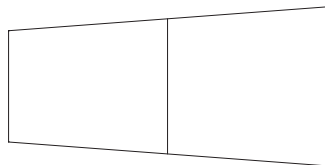

top shape

LOK - CONFERENCE

To Order Specify

1 Laminate Model #	2 Edge Detail	3 Laminate Selection	3a PVC Edge Color	4 Electrical	5 Metal Color
Laminate (LKT)	See Edge Detail Options	See Laminate Selection	See PVC Edge Color Options	N None CT2 Dual Power Center Top CU2 Dual Power Underside CT2U1 Dual Power Center Top with Underside (See chart on next page)	See Metal Finish Color Options

Model Number Breakdown

LKT60120-29TPT					
LK	T	60120	29	TP	T
LOK	Laminate	60" x 120"	Height	Taper Top Shape	T base

Description

Taper 2pc Table with T Base
at Working Height
(continued)

Veneer Tables
"LKV" Models

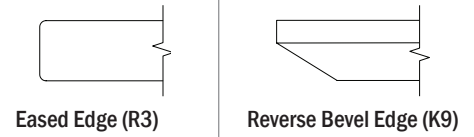

VEN.	D	W	H	CTN WT	CU FT	① Model	Essentials		Artisan	
	60	120	29	312	143	LKV60120-29TPT	\$8,160		\$8,813	
									\$8,895	\$9,473

Electrical Options and Upcharges

Code	Description	Price
CT24	120 - 192 wide 84 - 96 wide	
CT4BL	Dual Power Center Top - Black	add \$2,775
CT4WH	Dual Power Center Top - White	add \$2,775
CU1	Single Power Underside - Black	add \$688
CU1-CW	Single Power Underside with Wireless Charging - Black	add \$1,440
CT2U1	Dual Power Center Top with Underside - White	
CT4U1	Dual Power Center Top with Underside - Black	add \$3,169
CT4U1-BL	Dual Power Center Top with Underside - Black	add \$3,169
CT4U1-WH	Dual Power Center Top with Underside - White	add \$3,169
CT4U1-BLW2	Dual Power Center Top with Underside & 2 Wireless Charging	add \$3,928
CT4U1-WHW2	Dual Power Center Top with Underside & 2 Wireless Charging	add \$3,928

Note: Order power infed that best fits application

To Order Specify

① Veneer Model #	② Edge Detail	③ Wood Collection	④ Wood Finish	⑤ Electrical	⑥ Metal Color
Veneer (LKV)	See Edge Detail Options	Essentials	See Essentials Wood Finish Options	N None CT2 Dual Power Center Top CU2 Dual Power Underside CT2U1 Dual Power Center Top with Underside (See chart above)	See Metal Finish Color Options
		Artisan	④ Wood Finish See Artisan Wood Finish Options		

LOK - CONFERENCE

Description

Taper Table with T Base at Working Height

Laminate Tables
"LKT" Models

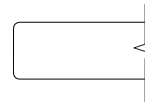
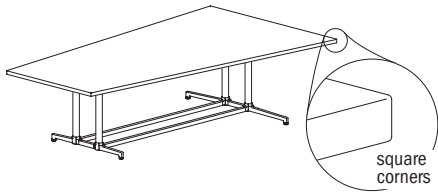

Eased Edge (R3)

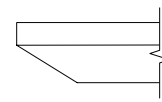

Reverse Bevel Edge (K9)

LAMI	D	W	H	CTN WT	CU FT	Model	Standard Tier 1	Graded In Tier 2	Standard Tier 1	Graded In Tier 2
		54	96	29	216	105	LKT5496-29TPT	\$3,681	\$3,741	\$4,180

Features:

- price reflects complete table - top and base
- ships KD in multiple cartons
- one piece top
- model includes adjustable glide

Options:

- specify power/charging option, see below for options and upcharges

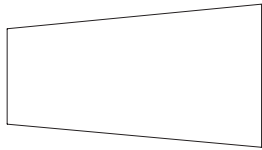

top shape

LOK - CONFERENCE

To Order Specify

1 Laminite Model #	2 Edge Detail	3 Laminite Selection	3a PVC Edge Color	4 Electrical	5 Metal Color
Laminite (LKT)	See Edge Detail Options	See Laminite Selection	See PVC Edge Color Options	N None CT2 Dual Power Center Top CU2 Dual Power Underside CT2U1 Dual Power Center Top with Underside (See chart on next page)	See Metal Finish Color Options

Model Number Breakdown

LKT5496-29TPT					
LK	T	5496	29	TP	T
LOK	Laminite	54" x 96"	Height	Taper Top Shape	T base

Description

Taper Table with T Base
at Working Height
(continued)

Veneer Tables
"LKV" Models

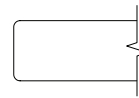

Eased Edge (R3)

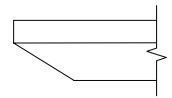

Reverse Bevel Edge (K9)

VEN.	D	W	H	CTN WT	CU FT	① Model	Eased Edge (R3)		Reverse Bevel Edge (K9)	
							Essentials	Artisan	Essentials	Artisan
	54	96	29	216	105	LKV5496-29TPT	\$5,033	\$5,437	\$5,485	\$5,844

Electrical Options and Upcharges

CT2	84 - 96 wide
Dual Power Center Top - Black	CT2BL - add \$1,535
Dual Power Center Top - White	CT2WH - add \$1,535
CU1	
Single Power Underside - Black	CU1-1C - add \$610
Single Power Underside with Wireless Charging - Black	CU1-1CW - add \$1,413
CT2U1	
Dual Power Center Top - Black with Single Underside	CT2U1-BL - add \$1,904
Dual Power Center Top - White with Single Underside	CT2U1-WH - add \$1,904
Dual Power Center Top - Black with Wireless Charging	CT2U1-BLW2 - add \$2,670
Dual Power Center Top - White with Wireless Charging	CT2U1-WHW2 - add \$2,670

Note: Order power infed that best fits application

To Order Specify

① Veneer Model #	② Edge Detail	③ Wood Collection	④ Wood Finish	⑤ Electrical	⑥ Metal Color
Veneer (LKV)	See Edge Detail Options	Essentials	See Essentials Wood Finish Options	N None CT2 Dual Power Center Top CU2 Dual Power Underside CT2U1 Dual Power Center Top with Underside (See chart above)	See Metal Finish Color Options
		Artisan	④ Wood Finish See Artisan Wood Finish Options		

LOK - CONFERENCE

Description

Rounded Taper 2pc Table with T Base at Working Height

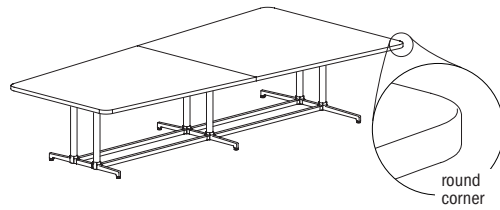

Laminate Tables
"LKT" Models

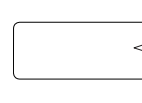

Eased Edge (R3)

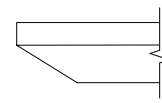

Reverse Bevel Edge (K9)

LAMI	D	W	H	CTN WT	CU FT	Model	Standard	Graded In	Standard	Graded In
							Tier 1	Tier 2	Tier 1	Tier 2
	60	120	29	312	143	LKT60120-29TPRT	\$5,416	\$5,501	\$5,961	\$6,042

Features:

- price reflects complete table - top and base
- ships KD in multiple cartons
- two piece top
- model includes adjustable glide

Options:

- specify power/charging option, see below for options and upcharges

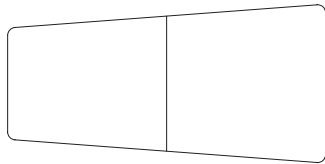

top shape

LOK - CONFERENCE

To Order Specify

1 Laminata Model #	2 Edge Detail	3 Laminata Selection	3a PVC Edge Color	4 Electrical	5 Metal Color
Laminata (LKT)	See Edge Detail Options	See Laminata Selection	See PVC Edge Color Options	N None CT2 Dual Power Center Top CU2 Dual Power Underside CT2U1 Dual Power Center Top with Underside (See chart on next page)	See Metal Finish Color Options

Model Number Breakdown

LKT60120-29TPRT						
LK	T	60120	29	TP	R	T
LOK	Laminata	60" x 120"	Height	Taper Top Shape	Rounded Corner	T base

Description

Rounded Taper 2pc Table with T Base at Working Height (continued)

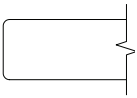
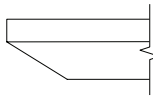
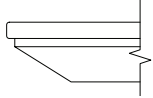
		Veneer Tables "LKV" Models				Solid Surface Tables "LKS" Models					
		 <p>Eased Edge (R3)</p>		 <p>Reverse Bevel Edge (K9)</p>		 <p>Reverse Bevel Edge (S7)</p>					
	D	W	H	CTN WT	CU FT	Model	Essentials	Artisan	Essentials	Artisan	Standard
VEN.	60	120	29	312	143	LKV60120-29TPRT	\$8,160	\$8,813	\$8,895	\$9,473	--
S.S.	60	120	29	312	143	LKS60120-29TPRT	--	--	--	--	\$22,567

Electrical Options and Upcharges

CT4	120 - 192 wide
Four Power Center Top - Black	CT4BL - add \$2,775
Four Power Center Top - White	CT4WH - add \$2,775
CU1	
Single Power Underside - Black	CU1-1C - add \$688
Single Power Underside with Wireless Charging - Black	CU1-1CW - add \$1,440
CT4U1	
Four Power Center Top with Underside - Black	CT4U1-BL - add \$3,169
Four Power Center Top with Underside - White	CT4U1-WH - add \$3,169
Four Power Center Top - Black with Underside & 2 Wireless Charging	CT4U1-BLW2 - add \$3,928
Four Power Center Top - White with Underside & 2 Wireless Charging	CT4U1-WHW2 - add \$3,928

Note: Order power infeed that best fits application, see page 408.

To Order Specify

1 Veneer Model #	2 Edge Detail	3 Wood Collection	4 Wood Finish	5 Electrical	6 Metal Color
Veneer (LKV)	See Edge Detail Options	Essentials	See Essentials Wood Finish Options	N None CT2 Dual Power Center Top CU2 Dual Power Underside CT2U1 Dual Power Center Top with Underside (See chart above)	See Metal Finish Color Options
		Artisan	4 Wood Finish See Artisan Wood Finish Options		
1 Solid Surface Model #	2 Top Surface Selection	3 Electrical		4 Metal Color	
Solid Surface (LKS)	See Solid Surface Top Surface Selection Options	N None CT2 Dual Power Center Top CU2 Dual Power Underside (See chart above) CT2U1 Dual Power Center Top with Underside		See Metal Finish Color Options	

LOK - CONFERENCE

Description

Rounded Taper Table with T Base at Working Height

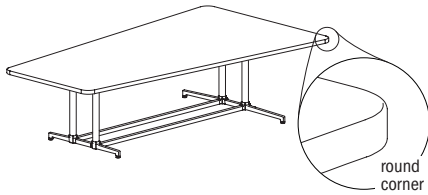

Laminate Tables "LKT" Models

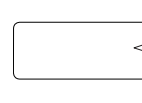

Eased Edge (R3)

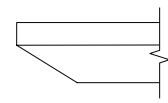

Reverse Bevel Edge (K9)

LAMI	D	W	H	CTN WT	CU FT	Model	Standard Tier 1	Graded In Tier 2	Standard Tier 1	Graded In Tier 2
		54	96	29	216	105	LKT5496-29TPRT	\$3,681	\$3,741	\$4,180

Features:

- price reflects complete table - top and base
- ships KD in multiple cartons
- one piece top
- model includes adjustable glide

Options:

- specify power/charging option, see below for options and upcharges

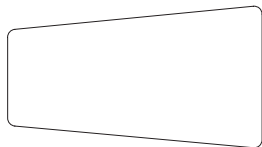

top shape

LOK - CONFERENCE

To Order Specify

1 Laminate Model #	2 Edge Detail	3 Laminate Selection	3a PVC Edge Color	4 Electrical	5 Metal Color
Laminate (LKT)	See Edge Detail Options	See Laminate Selection	See PVC Edge Color Options	N None CT2 Dual Power Center Top CU2 Dual Power Underside CT2U1 Dual Power Center Top with Underside (See chart on next page)	See Metal Finish Color Options

Model Number Breakdown

LKT5496-29TPRT						
LK	T	5496	29	TP	R	T
LOK	Laminate	54" x 96"	Height	Taper Top Shape	Rounded Corner	T base

Description

Rounded Taper Table with T Base at Working Height (continued)

Veneer Tables "LKV" Models	Solid Surface Tables "LKS" Models
----------------------------	-----------------------------------

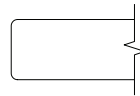

Eased Edge (R3)

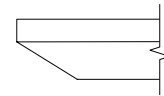

Reverse Bevel Edge (K9)

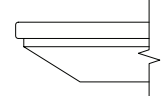

Reverse Bevel Edge (S7)

	D	W	H	CTN WT	CU FT	① Model	Veneer Tables "LKV" Models		Solid Surface Tables "LKS" Models		
							Essentials	Artisan	Essentials	Artisan	Standard
VEN.	54	96	29	216	105	LKV5496-29TPRT	\$5,033	\$5,437	\$5,485	\$5,844	--
S.S.	54	96	29	216	105	LKS5496-29TPRT	--	--	--	--	\$14,083

Electrical Options and Upcharges

CT2	84 - 96 wide
Dual Power Center Top - Black	CT2BL - add \$1,535
Dual Power Center Top - White	CT2WH - add \$1,535
CU1	
Single Power Underside - Black	CU1-1C - add \$610
Single Power Underside with Wireless Charging - Black	CU1-1CW - add \$1,413
CT2U1	
Dual Power Center Top - Black with Single Underside	CT2U1-BL - add \$1,904
Dual Power Center Top - White with Single Underside	CT2U1-WH - add \$1,904
Dual Power Center Top - Black with Wireless Charging	CT2U1-BLW2 - add \$2,670
Dual Power Center Top - White with Wireless Charging	CT2U1-WHW2 - add \$2,670

LOK - CONFERENCE

Note: Order power infeed that best fits application, see page 408.

To Order Specify

① Veneer Model #	② Edge Detail	③ Wood Collection	④ Wood Finish	⑤ Electrical	⑥ Metal Color
Veneer (LKV)	See Edge Detail Options	Essentials	See Essentials Wood Finish Options	N None CT2 Dual Power Center Top CU2 Dual Power Underside CT2U1 Dual Power Center Top with Underside (See chart above)	See Metal Finish Color Options
		Artisan	④ Wood Finish See Artisan Wood Finish Options		

① Solid Surface Model #	② Top Surface Selection	③ Electrical	④ Metal Color
Solid Surface (LKS)	See Solid Surface Top Surface Selection Options	N None CT2 Dual Power Center Top CU2 Dual Power Underside (See chart above) CT2U1 Dual Power Center Top with Underside	See Metal Finish Color Options

Description

Taper 2pc Table with Y Base at Working Height

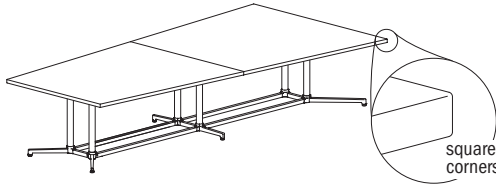

Laminate Tables "LKT" Models

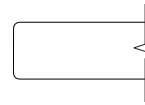

Eased Edge (R3)

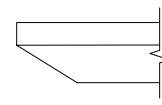

Reverse Bevel Edge (K9)

LAMI	D	W	H	CTN WT	CU FT	Model	Standard Tier 1	Graded In Tier 2	Standard Tier 1	Graded In Tier 2
		60	120	29	301	143	LKT60120-29TPY	\$5,260	\$5,340	\$5,801

Features:

- price reflects complete table - top and base
- ships KD in multiple cartons
- two piece top
- model includes adjustable glide

Options:

- specify power/charging option, see below for options and upcharges

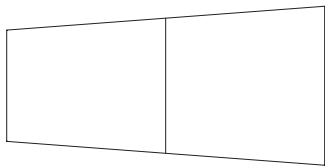

top shape

LOK - CONFERENCE

To Order Specify

1 Laminate Model #	2 Edge Detail	3 Laminate Selection	3a PVC Edge Color	4 Electrical	5 Metal Color
Laminate (LKT)	See Edge Detail Options	See Laminate Selection	See PVC Edge Color Options	N None CT2 Dual Power Center Top CU2 Dual Power Underside CT2U1 Dual Power Center Top with Underside (See chart on next page)	See Metal Finish Color Options

Model Number Breakdown

LKT60120-29TPY					
LK	T	60120	29	TP	Y
LOK	Laminate	60" x 120"	Height	Taper Top Shape	Y base

Description

Taper 2pc Table with Y Base
at Working Height
(continued)

Veneer Tables
"LKV" Models

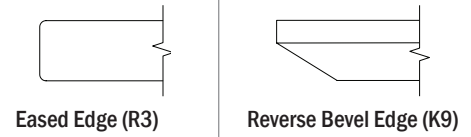

VEN.	D	W	H	CTN WT	CU FT	① Model	Eased Edge (R3)		Reverse Bevel Edge (K9)	
							Essentials	Artisan	Essentials	Artisan
	60	120	29	301	143	LKV60120-29TPY	\$3,891	\$4,201	\$4,239	\$4,514

Electrical Options and Upcharges

Code	Description	Price
CT4	Four Power Center Top - Black	120 - 192 wide
CT4BL	Four Power Center Top - Black with Underside - Black	84 - 96 wide
CT4WH	Four Power Center Top - White with Underside - White	
CU1	Single Power Underside - Black	
CU1-1C	Single Power Underside - Black with Wireless Charging	CU1-1C - add \$688
CU1-1CW	Single Power Underside - Black with Wireless Charging	CU1-1CW - add \$1,440
CT2U1	Dual Power Center Top with Underside - Black	
CT4U1-BL	Dual Power Center Top with Underside - Black	CT4U1-BL - add \$3,169
CT4U1-WH	Dual Power Center Top with Underside - White	CT4U1-WH - add \$3,169
CT4U1-BLW2	Dual Power Center Top with Underside - Black with Wireless Charging	CT4U1-BLW2 - add \$3,928
CT4U1-WHW2	Dual Power Center Top with Underside - White with Wireless Charging	CT4U1-WHW2 - add \$3,928

Note: Order power infed that best fits application

To Order Specify

① Veneer Model #	② Edge Detail	③ Wood Collection	④ Wood Finish	⑤ Electrical	⑥ Metal Color
Veneer (LKV)	See Edge Detail Options	Essentials	See Essentials Wood Finish Options	N None CT2 Dual Power Center Top CU2 Dual Power Underside CT2U1 Dual Power Center Top with Underside (See chart above)	See Metal Finish Color Options
		Artisan	④ Wood Finish See Artisan Wood Finish Options		

LOK - CONFERENCE

Description

Taper Table with Y Base at Working Height

Laminate Tables "LKT" Models

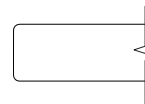
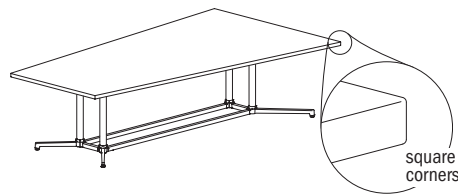

Eased Edge (R3)

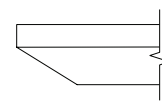

Reverse Bevel Edge (K9)

LAMI	D	W	H	CTN WT	CU FT	Model	Eased Edge (R3)		Reverse Bevel Edge (K9)	
							Standard Tier 1	Graded In Tier 2	Standard Tier 1	Graded In Tier 2
	54	96	29	198	105	LKT5496-29TPY	\$1,707	\$1,764	\$2,206	\$2,266

Features:

- price reflects complete table - top and base
- ships KD in multiple cartons
- one piece top
- model includes adjustable glide

Options:

- specify power/charging option, see below for options and upcharges

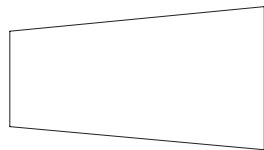

top shape

LOK - CONFERENCE

To Order Specify

1 Laminite Model #	2 Edge Detail	3 Laminite Selection	3a PVC Edge Color	4 Electrical	5 Metal Color
Laminite (LKT)	See Edge Detail Options	See Laminite Selection	See PVC Edge Color Options	N None CT2 Dual Power Center Top CU2 Dual Power Underside CT2U1 Dual Power Center Top with Underside (See chart on next page)	See Metal Finish Color Options

Model Number Breakdown

LKT5496-29TPY					
LK	T	5496	29	TP	Y
LOK	Laminite	54" x 96"	Height	Taper Top Shape	Y base

Description

Taper Table with Y Base
at Working Height
(continued)

Veneer Tables
"LKV" Models

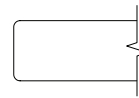

Eased Edge (R3)

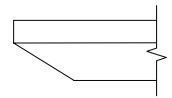

Reverse Bevel Edge (K9)

VEN.	D	W	H	CTN WT	CU FT	① Model	Eased Edge (R3)		Reverse Bevel Edge (K9)	
							Essentials	Artisan	Essentials	Artisan
	54	96	29	198	105	LKV5496-29TPY	\$5,130	\$5,540	\$5,591	\$5,954

Electrical Options and Upcharges

CT2	84 - 96 wide
Dual Power Center Top - Black	CT2BL - add \$1,535
Dual Power Center Top - White	CT2WH - add \$1,535
CU1	
Single Power Underside - Black	CU1-1C - add \$610
Single Power Underside with Wireless Charging - Black	CU1-1CW - add \$1,413
CT2U1	
Dual Power Center Top - Black with Single Underside	CT2U1-BL - add \$1,904
Dual Power Center Top - White with Single Underside	CT2U1-WH - add \$1,904
Dual Power Center Top- Black with Wireless Charging	CT2U1-BLW2 - add \$2,670
Dual Power Center Top- White with Wireless Charging	CT2U1-WHW2 - add \$2,670

Note: Order power infeed that best fits application

To Order Specify

① Veneer Model #	② Edge Detail	③ Wood Collection	④ Wood Finish	⑤ Electrical	⑥ Metal Color
Veneer (LKV)	See Edge Detail Options	Essentials	See Essentials Wood Finish Options	N None CT2 Dual Power Center Top CU2 Dual Power Underside CT2U1 Dual Power Center Top with Underside (See chart above)	See Metal Finish Color Options
		Artisan	④ Wood Finish See Artisan Wood Finish Options		

Description

Rounded Taper 2pc Table with Y Base at Working Height

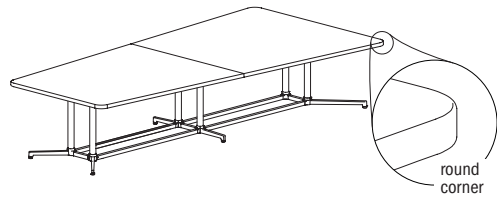

Laminate Tables
"LKT" Models

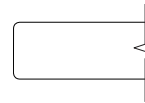

Eased Edge (R3)

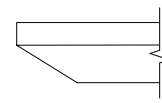

Reverse Bevel Edge (K9)

LAMI	D	W	H	CTN WT	CU FT	① Model	Eased Edge (R3)		Reverse Bevel Edge (K9)	
							Standard Tier 1	Graded In Tier 2	Standard Tier 1	Graded In Tier 2
	60	120	29	301	143	LKT60120-29TPRY	\$5,260	\$5,340	\$5,801	\$5,886

Features:

- price reflects complete table - top and base
- ships KD in multiple cartons
- two piece top
- model includes adjustable glide

Options:

- specify power/charging option, see below for options and upcharges

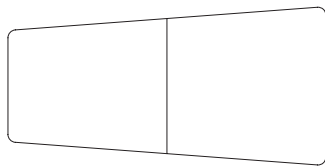

top shape

LOK - CONFERENCE

To Order Specify

① Laminate Model #	② Edge Detail	③ Laminate Selection	④ PVC Edge Color	⑤ Electrical	⑥ Metal Color
Laminate (LKT)	See Edge Detail Options	See Laminate Selection	See PVC Edge Color Options	N None CT2 Dual Power Center Top CU2 Dual Power Underside CT2U1 Dual Power Center Top with Underside (See chart on next page)	See Metal Finish Color Options

Model Number Breakdown

LKT60120-29TPRY						
LK	T	60120	29	TP	R	Y
LOK	Laminate	60" x 120"	Height	Taper Top Shape	Rounded Corner	Y base

Description

Rounded Taper 2pc Table with Y Base at Working Height (continued)

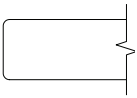
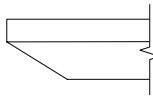
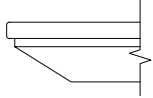
		Veneer Tables "LKV" Models				Solid Surface Tables "LKS" Models					
		 <p>Eased Edge (R3)</p>		 <p>Reverse Bevel Edge (K9)</p>		 <p>Reverse Bevel Edge (S7)</p>					
	D	W	H	CTN WT	CU FT	Model	Essentials	Artisan	Essentials	Artisan	Standard
VEN.	60	120	29	301	143	LKV60120-29TPRY	\$7,945	\$8,578	\$8,660	\$9,220	--
S.S.	60	120	29	301	143	LKS60120-29TPRY	--	--	--	--	\$22,350

Electrical Options and Upcharges

120 - 192 wide	
CT4	
Four Power Center Top - Black	CT4BL - add \$2,775
Four Power Center Top - White	CT4WH - add \$2,775
CU1	
Single Power Underside - Black	CU1-1C - add \$688
Single Power Underside with Wireless Charging - Black	CU1-1CW - add \$1,440
CT4U1	
Four Power Center Top with Underside - Black	CT4U1-BL - add \$3,169
Four Power Center Top with Underside - White	CT4U1-WH - add \$3,169
Four Power Center Top - Black with Underside & 2 Wireless Charging	CT4U1-BLW2 - add \$3,928
Four Power Center Top - White with Underside & 2 Wireless Charging	CT4U1-WhW2 - add \$3,928

Note: Order power infeed that best fits application, see page 408.

To Order Specify

1 Veneer Model #	2 Edge Detail	3 Wood Collection	4 Wood Finish	5 Electrical	6 Metal Color
Veneer (LKV)	See Edge Detail Options	Essentials	See Essentials Wood Finish Options	N None CT2 Dual Power Center Top CU2 Dual Power Underside CT2U1 Dual Power Center Top with Underside (See chart above)	See Metal Finish Color Options
		Artisan	4 Wood Finish See Artisan Wood Finish Options		
1 Solid Surface Model #	2 Top Surface Selection	3 Electrical		4 Metal Color	
Solid Surface (LKS)	See Solid Surface Top Surface Selection Options	N None CT2 Dual Power Center Top CU2 Dual Power Underside (See chart above) CT2U1 Dual Power Center Top with Underside		See Metal Finish Color Options	

LOK - CONFERENCE

Description

Rounded Taper Table with Y Base at Working Height

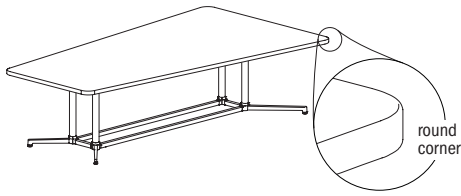

Laminate Tables "LKT" Models

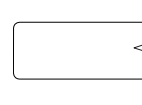

Eased Edge (R3)

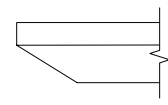

Reverse Bevel Edge (K9)

LAMI	D	W	H	CTN WT	CU FT	Model	Standard Tier 1	Graded In Tier 2	Standard Tier 1	Graded In Tier 2
		54	96	29	198	105	LKT5496-29TPRY	\$3,759	\$3,819	\$4,259

Features:

- price reflects complete table - top and base
- ships KD in multiple cartons
- one piece top
- model includes adjustable glide

Options:

- specify power/charging option, see below for options and upcharges

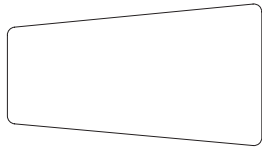

top shape

LOK - CONFERENCE

To Order Specify

1 Laminate Model #	2 Edge Detail	3 Laminate Selection	3a PVC Edge Color	4 Electrical	5 Metal Color
Laminate (LKT)	See Edge Detail Options	See Laminate Selection	See PVC Edge Color Options	N None CT2 Dual Power Center Top CU2 Dual Power Underside CT2U1 Dual Power Center Top with Underside (See chart on next page)	See Metal Finish Color Options

Model Number Breakdown

LKT5496-29TPRY						
LK	T	5496	29	TP	R	Y
LOK	Laminate	54" x 96"	Height	Taper Top Shape	Rounded Corner	Y base

Description

Rounded Taper Table with Y Base at Working Height (continued)

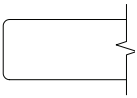
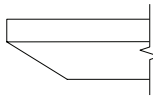
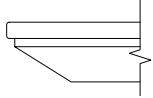
		Veneer Tables "LKV" Models				Solid Surface Tables "LKS" Models					
		 <p>Eased Edge (R3)</p>		 <p>Reverse Bevel Edge (K9)</p>		 <p>Reverse Bevel Edge (S7)</p>					
	D	W	H	CTN WT	CU FT	① Model	Essentials	Artisan	Essentials	Artisan	Standard
VEN.	54	96	29	198	105	LKV5496-29TPRY	\$5,130	\$5,540	\$5,591	\$5,954	--
S.S.	54	96	29	198	105	LKS5496-29TPRY	--	--	--	--	\$14,177

Electrical Options and Upcharges

	84 - 96 wide
CT2	
Dual Power Center Top - Black	CT2BL - add \$1,535
Dual Power Center Top - White	CT2WH - add \$1,535
CU1	
Single Power Underside - Black	CU1-1C - add \$610
Single Power Underside with Wireless Charging - Black	CU1-1CW - add \$1,413
CT2U1	
Dual Power Center Top - Black with Single Underside	CT2U1-BL - add \$1,904
Dual Power Center Top - White with Single Underside	CT2U1-WH - add \$1,904
Dual Power Center Top - Black with Wireless Charging	CT2U1-BLW2 - add \$2,670
Dual Power Center Top - White with Wireless Charging	CT2U1-WHW2 - add \$2,670

LOK - CONFERENCE

Note: Order power infeed that best fits application, see page 408.

To Order Specify

① Veneer Model #	② Edge Detail	③ Wood Collection	④ Wood Finish	⑤ Electrical	⑥ Metal Color
Veneer (LKV)	See Edge Detail Options	Essentials	See Essentials Wood Finish Options	N None CT2 Dual Power Center Top CU2 Dual Power Underside (See chart above) CT2U1 Dual Power Center Top with Underside (See chart above)	See Metal Finish Color Options
		Artisan	④ Wood Finish See Artisan Wood Finish Options		

① Solid Surface Model #	② Top Surface Selection	③ Electrical	④ Metal Color
Solid Surface (LKS)	See Solid Surface Top Surface Selection Options	N None CT2 Dual Power Center Top CU2 Dual Power Underside (See chart above) CT2U1 Dual Power Center Top with Underside	See Metal Finish Color Options

Description

Round Table with X Base
at Working Height



Laminate Tables
"LKT" Models

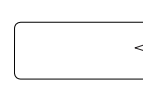

Eased Edge (R3)

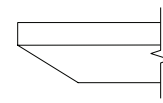

Reverse Bevel Edge (K9)

LAMINATE	D	W	H	CTN WT	CU FT	1 Model	Eased Edge (R3)		Reverse Bevel Edge (K9)	
							Standard	Graded In	Standard	Graded In
							Tier 1	Tier 2	Tier 1	Tier 2
	48	48	29	86	49	LKT48-29RDX	\$1,619	\$1,743	\$2,087	\$2,211
	42	42	29	72	38	LKT42-29RDX	\$1,478	\$1,600	\$1,948	\$2,068
	36	36	29	58	29	LKT36-29RDX	\$1,430	\$1,474	\$1,899	\$1,942
	30	30	29	58	21	LKT30-29RDX	\$1,378	\$1,414	\$1,833	\$1,883

Features:

- price reflects complete table - top and base
- ships KD in multiple cartons
- one piece top
- model includes adjustable glide
- when electrical option is selected, power accessible base is shipped; see page 178 for details
- power/charging units have 72" cord
- power cord is routed inside base column

Options:

- specify power access base with power unit option; None (N), add \$663 for EC23 (CTEC23), add \$549 for EC24 (CTEC24)

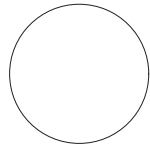

top shape

LOK - CONFERENCE

To Order Specify

1 Laminite Model #	2 Edge Detail	3 Laminite Selection	3a PVC Edge Color	4 Electrical	5 Metal Color
Laminite (LKT)	See Edge Detail Options	See Laminite Selection	See PVC Edge Color Options	N None CTEC23 Power Center Top CTEC24 Power Center Top (See chart on next page)	See Metal Finish Color Options

Model Number Breakdown

LKT48-29RDX					
LK	T	48	29	RD	X
LOK	Laminite	48" dia.	Height	Round Top Shape	X base

Description

Round Table with X Base
at Working Height
(continued)

Veneer Tables
"LKV" Models

Solid Surface Tables
"LKS" Models

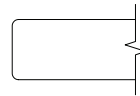

Eased Edge (R3)

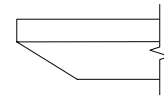

Reverse Bevel Edge (K9)

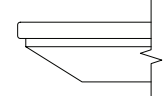

Reverse Bevel Edge (S7)

	D	W	H	CTN WT	CU FT	① Model	Veneer Tables "LKV" Models		Solid Surface Tables "LKS" Models		
							Essentials	Artisan	Essentials	Artisan	Standard
VENEER	48	48	29	86	49	LKV48-29RDX	\$2,169	\$2,319	\$2,255	\$2,415	--
	42	42	29	72	38	LKV42-29RDX	\$1,979	\$2,119	\$2,060	\$2,205	--
	36	36	29	58	29	LKV36-29RDX	\$1,917	\$2,051	\$1,996	\$2,135	--
	30	30	29	58	21	LKV30-29RDX	\$1,845	\$1,975	\$1,920	\$2,055	--
SOLID SURFACE	48	48	29	86	49	LKS48-29RDX	--	--	--	--	\$5,199
	42	42	29	72	38	LKS42-29RDX	--	--	--	--	\$4,415
	36	36	29	58	29	LKS36-29RDX	--	--	--	--	\$3,835
	30	30	29	47	21	LKS30-29RDX	--	--	--	--	\$3,324

Electrical Options and Upcharges

CTEC23	
EC23 Power Center Top - Black	CTEC23BL - add \$643
EC23 Power Center Top - White	CTEC23WH - add \$643
CTEC24	
EC24 Power Center Top - Black	CTEC43BL - add \$533
EC24 Power Center Top - White	CTEC43WH - add \$533

To Order Specify

① Veneer Model #	② Edge Detail	③ Wood Collection	④ Wood Finish	⑤ Electrical	⑥ Metal Color
Veneer (LKV)	See Edge Detail Options	Essentials	See Essentials Wood Finish Options	N None CTEC23 Power Center Top CTEC24 Power Center Top (See chart above)	See Metal Finish Color Options
		Artisan	See Artisan Wood Finish Options		

① Solid Surface Model #	② Top Surface Selection	③ Electrical Cut Out	④ Metal Color
Solid Surface (LKS)	See Solid Surface Top Surface Selection Options	N None CTEC23 Power Center Top CTEC24 Power Center Top (See chart above)	See Metal Finish Color Options

LOK- CONFERENCE

Description

Round Table with X4 Base at Working Height



Laminate Tables "LKT" Models

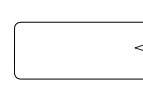

Eased Edge (R3)

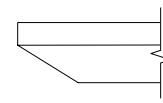

Reverse Bevel Edge (K9)

LAMINATE	D	W	H	CTN WT	CU FT	Model	Eased Edge (R3)		Reverse Bevel Edge (K9)	
							Standard Tier 1	Graded In Tier 2	Standard Tier 1	Graded In Tier 2
	60	60	29	148	73	LKT60-29RDZ	\$2,638	\$2,733	\$3,107	\$3,204
54	54	29	130	61	LKT54-29RDZ	\$2,584	\$2,658	\$3,053	\$3,128	

Features:

- price reflects complete table - top and base
- ships KD in multiple cartons
- one piece top
- model includes adjustable glide
- power cord is routed outside base column
- order vertical wire manager separately; see page 408

Options:

- specify power unit option; None (N), add \$663 for EC23 (CTEC23), add \$549 for EC24 (CTEC24)

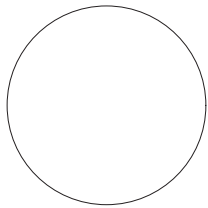

top shape

LOK - CONFERENCE

To Order Specify

1 Laminate Model #	2 Edge Detail	3 Laminate Selection	3a PVC Edge Color	4 Electrical	5 Metal Color
Laminate (LKT)	See Edge Detail Options	See Laminate Selection	See PVC Edge Color Options	N None CTEC23 Power Center Top CTEC24 Power Center Top (See chart on next page)	See Metal Finish Color Options

Model Number Breakdown

LKT60-29RDZ					
LK	T	60	29	RD	Z
LOK	Laminate	60" dia.	Height	Round Top Shape	X4 base

Description

Round Table with X4 Base
at Working Height
(continued)

Veneer Tables
"LKV" Models

Solid Surface Tables
"LKS" Models

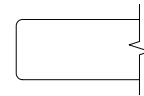

Eased Edge (R3)

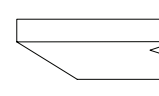

Reverse Bevel Edge (K9)

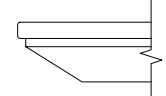

Reverse Bevel Edge (S7)

	D	W	H	CTN WT	CU FT	① Model	Veneer Tables "LKV" Models		Solid Surface Tables "LKS" Models		
							Essentials	Artisan	Essentials	Artisan	Standard
VENEER	60	60	29	148	73	LKV60-29RDZ	\$3,533	\$3,782	\$3,675	\$3,935	--
	54	54	29	130	61	LKV54-29RDZ	\$3,460	\$3,703	\$3,601	\$3,854	--
SOL. SURF.	60	60	29	148	73	LKS60-29RDZ	--	--	--	--	\$7,989
	54	54	29	130	61	LKS54-29RDZ	--	--	--	--	\$7,166

Electrical Options and Upcharges

CTEC23	
EC23 Power Center Top - Black	CTEC23BL - add \$643
EC23 Power Center Top - White	CTEC23WH - add \$643
CTEC24	
EC24 Power Center Top - Black	CTEC43BL - add \$533
EC24 Power Center Top - White	CTEC43WH - add \$533

To Order Specify

① Veneer Model #	② Edge Detail	③ Wood Collection	④ Wood Finish	⑤ Electrical	⑥ Metal Color
Veneer (LKV)	See Edge Detail Options	Essentials	See Essentials Wood Finish Options	N None CTEC23 Power Center Top CTEC24 Power Center Top (See chart above)	See Metal Finish Color Options
		Artisan	④ Wood Finish See Artisan Wood Finish Options		

① Solid Surface Model #	② Top Surface Selection	③ Electrical Cut Out	④ Metal Color
Solid Surface (LKS)	See Solid Surface Top Surface Selection Options	N None CTEC23 Power Center Top CTEC24 Power Center Top (See chart above)	See Metal Finish Color Options

LOK-CONFERENCE

Description

Square Table with X Base at Working Height

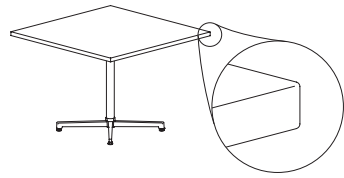

Laminate Tables "LKT" Models

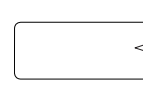

Eased Edge (R3)

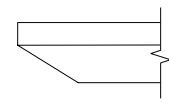

Reverse Bevel Edge (K9)

LAMINATE	D	W	H	CTN WT	CU FT	1 Model	Eased Edge (R3)		Reverse Bevel Edge (K9)	
							Standard Tier 1	Graded In Tier 2	Standard Tier 1	Graded In Tier 2
	48	48	29	103	49	LKT4848-29SQX	\$1,655	\$1,712	\$2,125	\$2,180
	42	42	29	85	38	LKT4242-29SQX	\$1,518	\$1,572	\$1,987	\$2,041
	36	36	29	69	29	LKT3636-29SQX	\$1,336	\$1,380	\$1,935	\$1,953
	30	30	29	53	21	LKT3030-29SQX	\$1,192	\$1,228	\$1,660	\$1,695

Features:

- price reflects complete table - top and base
- ships KD in multiple cartons
- one piece top
- model includes adjustable glide
- when electrical option is selected, power accessible base is shipped; see page 178 for details
- power/charging units have 72" cord
- power cord is routed inside base column

Options:

- specify power access base with power unit option; None (N), add \$663 for EC23 (CTEC23), add \$549 for EC24 (CTEC24)



top shape

LOK - CONFERENCE

To Order Specify

1 Laminate Model #	2 Edge Detail	3 Laminate Selection	3a PVC Edge Color	4 Electrical	5 Metal Color
Laminate (LKT)	See Edge Detail Options	See Laminate Selection	See PVC Edge Color Options	N None CTEC23 Power Center Top CTEC24 Power Center Top (See chart on next page)	See Metal Finish Color Options

Model Number Breakdown

LKT4848-29SQX					
LK	T	4848	29	SQ	X
LOK	Laminate	48" x 48"	Height	Square Top Shape	X base

Description

Square Table with X Base
at Working Height
(continued)

Veneer Tables
"LKV" Models

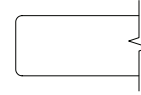

Eased Edge (R3)

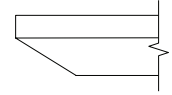

Reverse Bevel Edge (K9)

D	W	H	CTN WT	CU FT	① Model	Eased Edge (R3)		Reverse Bevel Edge (K9)	
						Essentials	Artisan	Essentials	Artisan
48	48	29	103	49	LKV4848-29SQX	\$2,184	\$2,338	\$2,272	\$2,432
42	42	29	85	38	LKV4242-29SQX	\$2,003	\$2,142	\$2,083	\$2,229
36	36	29	69	29	LKV3636-29SQX	\$1,763	\$1,890	\$1,836	\$1,964
30	30	29	53	21	LKV3030-29SQX	\$1,573	\$1,684	\$1,637	\$1,751

VENEER

LOK- CONFERENCE

Electrical Options and Upcharges

CTEC23	
EC23 Power Center Top - Black	CTEC23BL - add \$643
EC23 Power Center Top - White	CTEC23WH - add \$643
CTEC24	
EC24 Power Center Top - Black	CTEC43BL - add \$533
EC24 Power Center Top - White	CTEC43WH - add \$533

To Order Specify

① Veneer Model #	② Edge Detail	③ Wood Collection	④ Wood Finish	⑤ Electrical	⑥ Metal Color
Veneer (LKV)	See Edge Detail Options	Essentials	See Essentials Wood Finish Options	N None CTEC23 Power Center Top CTEC24 Power Center Top (See chart above)	See Metal Finish Color Options
		Artisan	④ Wood Finish See Artisan Wood Finish Options		

Description

Rounded Square Table with X Base at Working Height

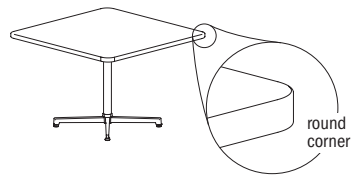

Laminate Tables
"LKT" Models

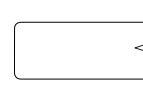

Eased Edge (R3)

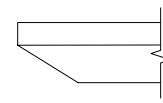

Reverse Bevel Edge (K9)

LAMINATE	D	W	H	CTN WT	CU FT	1 Model	Standard Tier 1	Graded In Tier 2	Standard Tier 1	Graded In Tier 2
		48	48	29	103	49	LKT4848-29SQRX	\$2,038	\$2,093	\$2,505
	42	42	29	85	38	LKT4242-29SQRX	\$1,884	\$1,938	\$2,352	\$2,410
	36	36	29	69	29	LKT3636-29SQRX	\$1,555	\$1,598	\$2,023	\$2,068
	30	30	29	53	21	LKT3030-29SQRX	\$1,381	\$1,419	\$1,850	\$1,888

Features:

- price reflects complete table - top and base
- ships KD in multiple cartons
- one piece top
- model includes adjustable glide
- when electrical option is selected, power accessible base is shipped; see page 178 for details
- power/charging units have 72" cord
- power cord is routed inside base column

Options:

- specify power access base with power unit option; None (N), add \$663 for EC23 (CTEC23), add \$549 for EC24 (CTEC24)

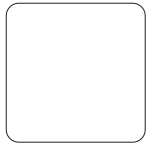

top shape

LOK - CONFERENCE

To Order Specify

1 Laminate Model #	2 Edge Detail	3 Laminate Selection	3a PVC Edge Color	4 Electrical	5 Metal Color
Laminate (LKT)	See Edge Detail Options	See Laminate Selection	See PVC Edge Color Options	N None CTEC23 Power Center Top CTEC24 Power Center Top (See chart on next page)	See Metal Finish Color Options

Model Number Breakdown

LKT4848-29SQRX						
LK	T	4848	29	SQ	R	X
LOK	Laminate	48" x 48"	Height	Square Top Shape	Round Corner	X base

Description

Rounded Square Table with X Base at Working Height (continued)

		Veneer Tables "LKV" Models				Solid Surface Tables "LKS" Models						
		Eased Edge (R3)		Reverse Bevel Edge (K9)		Reverse Bevel Edge (S7)						
		D	W	H	CTN WT	CU FT	Model	Essentials	Artisan	Essentials	Artisan	Standard
VENEER		48	48	29	103	49	LKV4848-29SQRX	\$2,686	\$2,875	\$2,795	\$2,991	--
		42	42	29	85	38	LKV4242-29SQRX	\$2,496	\$2,670	\$2,598	\$2,778	--
		36	36	29	69	29	LKV3636-29SQRX	\$2,051	\$2,196	\$2,134	\$2,284	--
		30	30	29	53	21	LKV3030-29SQRX	\$1,825	\$1,952	\$1,897	\$2,030	--
SOLID SURFACE		48	48	29	103	49	LKS4848-29SQRX	--	--	--	--	\$5,716
		42	42	29	85	38	LKS4242-29SQRX	--	--	--	--	\$4,930
		36	36	29	69	29	LKS3636-29SQRX	--	--	--	--	\$3,970
		30	30	29	53	21	LKS3030-29SQRX	--	--	--	--	\$3,305

Electrical Options and Upcharges

CTEC23	
EC23 Power Center Top - Black	CTEC23BL - add \$643
EC23 Power Center Top - White	CTEC23WH - add \$643
CTEC24	
EC24 Power Center Top - Black	CTEC43BL - add \$533
EC24 Power Center Top - White	CTEC43WH - add \$533

To Order Specify

1 Veneer Model #	2 Edge Detail	3 Wood Collection	4 Wood Finish	5 Electrical	6 Metal Color
Veneer (LKV)	See Edge Detail Options	Essentials	See Essentials Wood Finish Options	N None CTEC23 Power Center Top CTEC24 Power Center Top (See chart above)	See Metal Finish Color Options
		Artisan	See Artisan Wood Finish Options		

1 Solid Surface Model #	2 Top Surface Selection	3 Electrical Cut Out	4 Metal Color
Solid Surface (LKS)	See Solid Surface Top Surface Selection Options	N None CTEC23 Power Center Top CTEC24 Power Center Top (See chart above)	See Metal Finish Color Options

LOK - CONFERENCE

Description

Square Table with X4 Base at Working Height

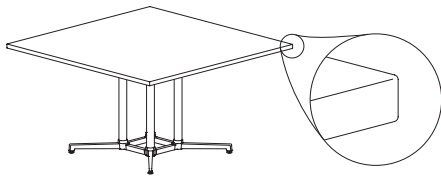

Laminate Tables
"LKT" Models

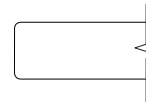

Eased Edge (R3)

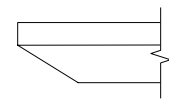

Reverse Bevel Edge (K9)

LAMINATE	D	W	H	CTN WT	CU FT	① Model	Eased Edge (R3)		Reverse Bevel Edge (K9)	
							Standard	Graded In	Standard	Graded In
							Tier 1	Tier 2	Tier 1	Tier 2
	60	60	29	174	73	LKT6060-29SQZ	\$3,029	\$3,123	\$3,497	\$3,593
	54	54	29	151	61	LKT5454-29SQZ	\$2,872	\$2,957	\$3,343	\$3,426

Features:

- price reflects complete table - top and base
- ships KD in multiple cartons
- one piece top
- model includes adjustable glide
- power cord is routed outside base column
- order vertical wire manager separately; see page 408

Options:

- specify power unit option; None (N), add \$663 for EC23 (CTEC23), add \$549 for EC24 (CTEC24)

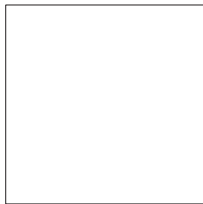

top shape

LOK - CONFERENCE

To Order Specify

① Laminate Model #	② Edge Detail	③ Laminate Selection	④ PVC Edge Color	⑤ Electrical	⑥ Metal Color
Laminate (LKT)	See Edge Detail Options	See Laminate Selection	See PVC Edge Color Options	N None CTEC23 Power Center Top CTEC24 Power Center Top (See chart on next page)	See Metal Finish Color Options

Model Number Breakdown

LKT6060-29SQZ					
LK	T	6060	29	SQ	Z
LOK	Laminate	60" x 60"	Height	Square Top Shape	X4 base

Description

Square Table with X4 Base
at Working Height
(continued)

Veneer Tables
"LKV" Models

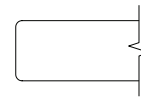

Eased Edge (R3)

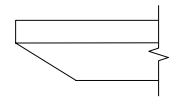

Reverse Bevel Edge (K9)

VENEER	D	W	H	CTN WT	CU FT	① Model	Eased Edge (R3)		Reverse Bevel Edge (K9)	
							Essentials	Artisan	Essentials	Artisan
	60	60	29	174	73	LKV6060-29SQZ	\$3,996	\$4,277	\$4,157	\$4,448
	54	54	29	151	61	LKV5454-29SQZ	\$3,792	\$4,058	\$3,943	\$4,221

LOK - CONFERENCE

Electrical Options and Upcharges

CTEC23	
EC23 Power Center Top - Black	CTEC23BL - add \$643
EC23 Power Center Top - White	CTEC23WH - add \$643
CTEC24	
EC24 Power Center Top - Black	CTEC43BL - add \$533
EC24 Power Center Top - White	CTEC43WH - add \$533

To Order Specify

① Veneer Model #	② Edge Detail	③ Wood Collection	④ Wood Finish	⑤ Electrical	⑥ Metal Color
Veneer (LKV)	See Edge Detail Options	Essentials	See Essentials Wood Finish Options	N None CTEC23 Power Center Top CTEC24 Power Center Top (See chart above)	See Metal Finish Color Options
		Artisan	④ Wood Finish See Artisan Wood Finish Options		

Description

Rounded Square Table with X4 Base at Working Height

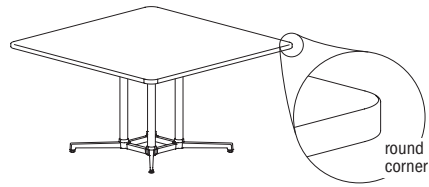

Laminate Tables "LKT" Models

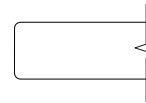

Eased Edge (R3)

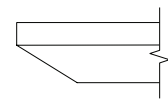

Reverse Bevel Edge (K9)

LAMINATE	D	W	H	CTN WT	CU FT	1 Model	Eased Edge (R3)		Reverse Bevel Edge (K9)	
							Standard	Graded In	Standard	Graded In
							Tier 1	Tier 2	Tier 1	Tier 2
	60	60	29	174	73	LKT6060-29SQRZ	\$3,271	\$3,354	\$3,739	\$3,823
	54	54	29	151	61	LKT5454-29SQRZ	\$2,669	\$2,755	\$3,139	\$3,222

Features:

- price reflects complete table - top and base
- ships KD in multiple cartons
- one piece top
- model includes adjustable glide
- power cord is routed outside base column
- order vertical wire manager separately; see page 408

Options:

- specify power unit option; None (N), add \$663 for EC23 (CTEC23), add \$549 for EC24 (CTEC24)

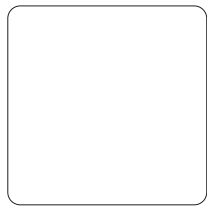

top shape

LOK - CONFERENCE

To Order Specify

1 Laminate Model #	2 Edge Detail	3 Laminate Selection	3a PVC Edge Color	4 Electrical	5 Metal Color
Laminate (LKT)	See Edge Detail Options	See Laminate Selection	See PVC Edge Color Options	N None CTEC23 Power Center Top CTEC24 Power Center Top (See chart on next page)	See Metal Finish Color Options

Model Number Breakdown

LKT6060-29SQRZ						
LK	T	6060	29	SQ	R	Z
LOK	Laminate	60" x 60"	Height	Square Top Shape	Round Corner	X4 base

Description

Rounded Square Table with X4 Base at Working Height (continued)

Veneer Tables "LKV" Models Solid Surface Tables "LKS" Models

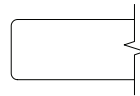

Eased Edge (R3)

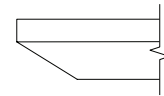

Reverse Bevel Edge (K9)

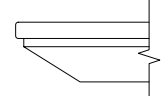

Reverse Bevel Edge (S7)

	D	W	H	CTN WT	CU FT	① Model	Veneer Tables "LKV" Models		Solid Surface Tables "LKS" Models		
							Essentials	Artisan	Essentials	Artisan	Standard
VENEER	60	60	29	174	73	LKV6060-29SQRZ	\$4,316	\$4,620	\$4,489	\$4,804	--
	54	54	29	151	61	LKV5454-29SQRZ	\$3,524	\$3,770	\$3,664	\$3,922	--
SOL. SURF.	60	60	29	174	73	LKS6060-29SQRZ	--	--	--	--	\$8,771
	54	54	29	151	61	LKS5454-29SQRZ	--	--	--	--	\$7,229

Electrical Options and Upcharges

CTEC23	
EC23 Power Center Top - Black	CTEC23BL - add \$643
EC23 Power Center Top - White	CTEC23WH - add \$643
CTEC24	
EC24 Power Center Top - Black	CTEC43BL - add \$533
EC24 Power Center Top - White	CTEC43WH - add \$533

To Order Specify

① Veneer Model #	② Edge Detail	③ Wood Collection	④ Wood Finish	⑤ Electrical	⑥ Metal Color
Veneer (LKV)	See Edge Detail Options	Essentials	See Essentials Wood Finish Options	N None CTEC23 Power Center Top CTEC24 Power Center Top (See chart above)	See Metal Finish Color Options
		Artisan	See Artisan Wood Finish Options		

① Solid Surface Model #	② Top Surface Selection	③ Electrical Cut Out	④ Metal Color
Solid Surface (LKS)	See Solid Surface Top Surface Selection Options	N None CTEC23 Power Center Top CTEC24 Power Center Top (See chart above)	See Metal Finish Color Options

LOK-CONFERENCE

Description

Squirele Table with X Base at Working Height



Laminate Tables "LKT" Models

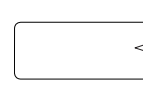

Eased Edge (R3)

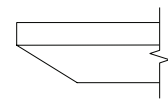

Reverse Bevel Edge (K9)

LAMINATE	D	W	H	CTN WT	CU FT	1 Model	Eased Edge (R3)		Reverse Bevel Edge (K9)	
							Standard Tier 1	Graded In Tier 2	Standard Tier 1	Graded In Tier 2
	48	48	29	92	49	LKT48-29SCX	\$1,641	\$1,762	\$2,110	\$2,234
42	42	29	101	38	LKT42-29SCX	\$1,500	\$1,622	\$1,972	\$2,092	
36	36	29	62	29	LKT36-29SCX	\$1,451	\$1,495	\$1,921	\$1,966	
30	30	29	61	21	LKT30-29SCX	\$1,398	\$1,432	\$1,868	\$1,904	

Features:

- price reflects complete table - top and base
- ships KD in multiple cartons
- one piece top
- model includes adjustable glide
- when electrical option is selected, power accessible base is shipped; see page 178 for details
- power/charging units have 72" cord
- power cord is routed inside base column

Options:

- specify power access base with power unit option; None (N), add \$663 for EC23 (CTEC23), add \$549 for EC24 (CTEC24)

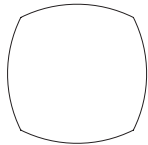

top shape

LOK - CONFERENCE

To Order Specify

1 Laminate Model #	2 Edge Detail	3 Laminate Selection	3a PVC Edge Color	4 Electrical	5 Metal Color
Laminate (LKT)	See Edge Detail Options	See Laminate Selection	See PVC Edge Color Options	N None CTEC23 Power Center Top CTEC24 Power Center Top (See chart on next page)	See Metal Finish Color Options

Model Number Breakdown

LKT48-29SQX					
LK	T	48	29	SQ	X
LOK	Laminate	48" dia.	Height	Squirele Top Shape	X base

Description

Squirrel Table with X Base at Working Height (continued)

		Veneer Tables "LKV" Models				Solid Surface Tables "LKS" Models						
		Eased Edge (R3)		Reverse Bevel Edge (K9)		Reverse Bevel Edge (S7)						
		D	W	H	CTN WT	CU FT	Model	Essentials	Artisan	Essentials	Artisan	Standard
VENEER		48	48	29	92	49	LKV48-29SCX	\$2,190	\$2,341	\$2,279	\$2,437	--
		42	42	29	101	38	LKV42-29SCX	\$2,003	\$2,140	\$2,083	\$2,228	--
		36	36	29	62	29	LKV36-29SCX	\$1,937	\$2,072	\$2,016	\$2,158	--
		30	30	29	61	21	LKV30-29SCX	\$1,866	\$1,996	\$1,941	\$2,077	--
SOLID SURFACE		48	48	29	92	49	LKS48-29SCX	--	--	--	--	\$5,239
		42	42	29	101	38	LKS42-29SCX	--	--	--	--	\$4,456
		36	36	29	62	29	LKS36-29SCX	--	--	--	--	\$3,876
		30	30	29	61	21	LKS30-29SCX	--	--	--	--	\$3,367

Electrical Options and Upcharges

CTEC23	
EC23 Power Center Top - Black	CTEC23BL - add \$643
EC23 Power Center Top - White	CTEC23WH - add \$643
CTEC24	
EC24 Power Center Top - Black	CTEC43BL - add \$533
EC24 Power Center Top - White	CTEC43WH - add \$533

To Order Specify

1 Veneer Model #	2 Edge Detail	3 Wood Collection	4 Wood Finish	5 Electrical	6 Metal Color
Veneer (LKV)	See Edge Detail Options	Essentials	See Essentials Wood Finish Options	N None CTEC23 Power Center Top CTEC24 Power Center Top (See chart above)	See Metal Finish Color Options
		Artisan	See Artisan Wood Finish Options		

1 Solid Surface Model #	2 Top Surface Selection	3 Electrical Cut Out	4 Metal Color
Solid Surface (LKS)	See Solid Surface Top Surface Selection Options	N None CTEC23 Power Center Top CTEC24 Power Center Top (See chart above)	See Metal Finish Color Options

LOK - CONFERENCE

Description

Squire Table with X4 Base at Working Height



Laminate Tables "LKT" Models

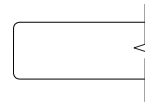

Eased Edge (R3)

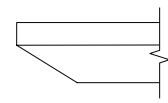

Reverse Bevel Edge (K9)

LAMINATE	D	W	H	CTN WT	CU FT	Model	Eased Edge (R3)		Reverse Bevel Edge (K9)	
							Standard Tier 1	Graded In Tier 2	Standard Tier 1	Graded In Tier 2
	60	60	29	156	74	LKT60-29SCZ	\$2,658	\$2,756	\$3,129	\$3,227
54	54	29	138	61	LKT54-29SCZ	\$2,604	\$2,682	\$3,076	\$3,151	

Features:

- price reflects complete table - top and base
- ships KD in multiple cartons
- one piece top
- model includes adjustable glide
- power cord is routed outside base column
- order vertical wire manager separately; see page 408

Options:

- specify power unit option; None (N), add \$663 for EC23 (CTEC23), add \$549 for EC24 (CTEC24)

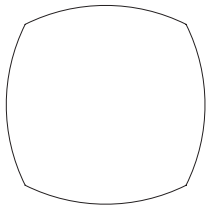

top shape

LOK - CONFERENCE

To Order Specify

1 Laminate Model #	2 Edge Detail	3 Laminate Selection	3a PVC Edge Color	4 Electrical	5 Metal Color
Laminate (LKT)	See Edge Detail Options	See Laminate Selection	See PVC Edge Color Options	N None CTEC23 Power Center Top CTEC24 Power Center Top (See chart on next page)	See Metal Finish Color Options

Model Number Breakdown

LKT60-29SCZ					
LK	T	60	29	SC	Z
LOK	Laminate	60" dia.	Height	Squire Top Shape	X4 base

Description

Squirrel Table with X4 Base at Working Height (continued)

Veneer Tables "LKV" Models Solid Surface Tables "LKS" Models

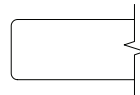

Eased Edge (R3)

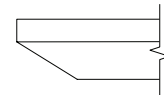

Reverse Bevel Edge (K9)

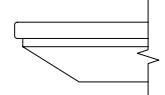

Reverse Bevel Edge (S7)

	D	W	H	CTN WT	CU FT	① Model	Veneer Tables "LKV" Models		Solid Surface Tables "LKS" Models		
							Essentials	Artisan	Essentials	Artisan	Standard
VENEER	60	60	29	156	74	LKV60-29SCZ	\$3,555	\$3,804	\$3,699	\$3,957	--
	54	54	29	138	61	LKV54-29SCZ	\$3,484	\$3,726	\$3,624	\$3,874	--
SOL. SURF.	60	60	29	156	74	LKS60-29SCZ	--	--	--	--	\$8,030
	54	54	29	138	61	LKS54-29SCZ	--	--	--	--	\$7,206

Electrical Options and Upcharges

CTEC23	
EC23 Power Center Top - Black	CTEC23BL - add \$643
EC23 Power Center Top - White	CTEC23WH - add \$643
CTEC24	
EC24 Power Center Top - Black	CTEC43BL - add \$533
EC24 Power Center Top - White	CTEC43WH - add \$533

To Order Specify

① Veneer Model #	② Edge Detail	③ Wood Collection	④ Wood Finish	⑤ Electrical	⑥ Metal Color
Veneer (LKV)	See Edge Detail Options	Essentials	See Essentials Wood Finish Options	N None CTEC23 Power Center Top CTEC24 Power Center Top (See chart above)	See Metal Finish Color Options
		Artisan	See Artisan Wood Finish Options		

① Solid Surface Model #	② Top Surface Selection	③ Electrical Cut Out	④ Metal Color
Solid Surface (LKS)	See Solid Surface Top Surface Selection Options	N None CTEC23 Power Center Top CTEC24 Power Center Top (See chart above)	See Metal Finish Color Options

LOK-CONFERENCE

Description

Hive Table with T Base at Working Height

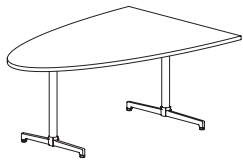

Laminate Tables
"LKT" Models

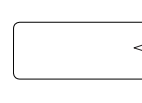

Eased Edge (R3)

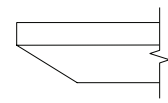

Reverse Bevel Edge (K9)

LAMI	D	W	H	CTN WT	CU FT	① Model	Standard Tier 1	Graded In Tier 2	Standard Tier 1	Graded In Tier 2
		48	72	29	135	71	LKT4872-29HVT	\$2,104	\$2,147	\$2,614

Features:

- price reflects complete table - top and base
- ships KD in multiple cartons

Options:

- specify power/charging option, see below for options and upcharges
- specify glide (G) or caster (C) -choice of black (BL) or white/grey casters (WG)

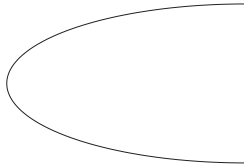

top shape

LOK - CONFERENCE

To Order Specify

① Laminate Model #	② Edge Detail	③ Laminate Selection	③a PVC Edge Color	④ Electrical
Laminate (LKT)	See Edge Detail Options	See Laminate Selection	See PVC Edge Color Options	N None CT2 Dual Power Center Top (See chart on next page) CU1 Single Power Underside ⑤ Foot/Caster G Glide C Caster - BL Black Caster - WG White Caster w/Grey Wheels ⑥ Metal Finish See Metal Finish Color Options

Model Number Breakdown

LKT4872-29HVT					
LK	T	4872	29	HV	T
LOK	Laminate	48" x 72"	Height	Hive Top Shape	T base

Description

Hive Table with T Base at Working Height (continued)

Veneer Tables "LKV" Models

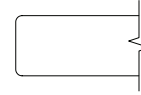

Eased Edge (R3)

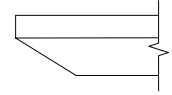

Reverse Bevel Edge (K9)

VEN.	D	W	H	CTN WT	CU FT	① Model	Essentials		Artisan	
							Price	Price	Price	Price
	48	72	29	135	71	LKV4872-29HVT	\$2,694	\$2,909	\$2,937	\$3,129

Electrical Options and Upcharges

CT2	
Dual Power Center Top - Black	CT2BL - add \$1,437
Dual Power Center Top - White	CT2WH - add \$1,437
CU1	
Single Power Underside - Black	CU11C - add \$559
Single Power Underside with Wireless Charging - Black	CU11CW - add \$1,338

Note: Order power infed that best fits application, see page 408.

To Order, Specify:

① Veneer Model #	② Edge Detail	③ Wood Collection	④ Top Wood Finish	⑤ Electrical	⑥ Base - Foot/Caster	⑦ Metal Color
Veneer (LKV)	See Edge Detail Options	Essentials	See Essentials Wood Finish Options	N None CT2 Dual Power Center Top CU1 Single Power Underside (See chart above)	G Glide C Caster - BL Black Caster - WG White Caster with Grey Wheels	See Metal Finish Color Options
		Artisan	④ Top Wood Finish See Artisan Wood Finish Options			

LOK- CONFERENCE

Description

Rectangular Table with T Base at Counter Height

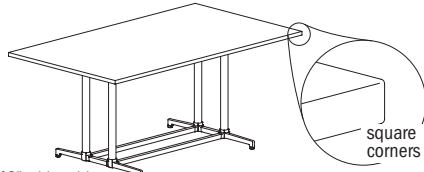

48" wide tables have double column base

D	W	H	CTN WT	CU FT	Model	Laminates Tables "LKT" Models			
						Eased Edge (R3)		Reverse Bevel Edge (K9)	
						Standard Tier 1	Graded In Tier 2	Standard Tier 1	Graded In Tier 2
48	96	36	233	115	LKT4896-36TTT	\$3,386	\$3,439	\$3,872	\$3,924
48	84	36	209	101	LKT4884-36TTT	\$3,098	\$3,144	\$3,572	\$3,617
42	96	36	186	83	LKT4296-36TTT	\$3,034	\$3,078	\$3,504	\$3,553
42	84	36	167	90	LKT4284-36TTT	\$2,519	\$2,560	\$2,983	\$3,023
36	96	36	166	89	LKT3696-36TTT	\$2,569	\$2,611	\$3,033	\$3,072
36	84	36	149	78	LKT3684-36TTT	\$2,318	\$2,353	\$2,772	\$2,805

LAMINATE

Features:

- price reflects complete table - top and base
- ships KD in multiple cartons
- one piece top
- model includes adjustable glide

Options:

- specify power/charging option, see below for options and upcharges

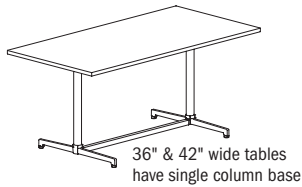

36" & 42" wide tables have single column base



top shape

LOK - CONFERENCE

To Order Specify

1 Laminates Model #	2 Edge Detail	3 Laminates Selection	3a PVC Edge Color	4 Electrical	5 Metal Color
Laminates (LKT)	See Edge Detail Options	See Laminates Selection	See PVC Edge Color Options	N None CT2 Dual Power Center Top CU2 Dual Power Underside CT2U1 Dual Power Center Top with Underside (See chart on next page)	See Metal Finish Color Options

Model Number Breakdown

LKT4896-36TTT					
LK	T	4896	36	TT	T
LOK	Laminates	48" x 96"	Height	Rectangular Top Shape	T base

Description

Rectangular Table with T Base
at Counter Height
(continued)

Veneer Tables
"LKV" Models

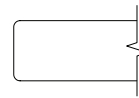

Eased Edge (R3)

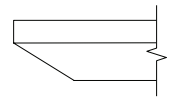

Reverse Bevel Edge (K9)

VENEER	D	W	H	CTN WT	CU FT	① Model	Essentials	Artisan	Essentials	Artisan
		48	96	36	233	115	LKV4896-36TTT	\$4,699	\$5,047	\$5,018
	48	84	36	209	101	LKV4884-36TTT	\$4,389	\$4,691	\$4,687	\$4,965
	42	96	36	186	83	LKV4296-36TTT	\$4,510	\$4,870	\$4,917	\$5,235
	42	84	36	167	90	LKV4284-36TTT	\$3,811	\$4,116	\$4,154	\$4,424
	36	96	36	166	89	LKV3696-36TTT	\$3,462	\$3,740	\$3,775	\$4,020
	36	84	36	149	78	LKV3684-36TTT	\$3,201	\$3,456	\$3,488	\$3,715

Electrical Options and Upcharges

CT2	84 - 96 wide
Dual Power Center Top - Black	CT2BL - add \$1,535
Dual Power Center Top - White	CT2WH - add \$1,535
CU1	
Dual Power Underside - Black	CU1-1C - add \$610
Dual Power Underside with Wireless Charging - Black	CU1-1CW - add \$1,413
CT2U1	
Dual Power Center Top - Black with Underside	CT2U1-BL - add \$1,868
Dual Power Center Top - White with Underside	CT2U1-WH - add \$1,868
Dual Power Center Top - Black with Wireless Charging	CT2U1-BLW2 - add \$2,670
Dual Power Center Top - White with Wireless Charging	CT2U1-WhW2 - add \$2,670

Note: Order power infeed that best fits application

To Order Specify

① Veneer Model #	② Edge Detail	③ Wood Collection	④ Wood Finish	⑤ Electrical	⑥ Metal Color
Veneer (LKV)	See Edge Detail Options	Essentials	See Essentials Wood Finish Options	N None CT2 Dual Power Center Top CU2 Dual Power Underside CT2U1 Dual Power Center Top with Underside (See chart above)	See Metal Finish Color Options
		Artisan	④ Wood Finish See Artisan Wood Finish Options		

LOK- CONFERENCE

Description

Rounded Rectangular Table with T Base at Counter Height

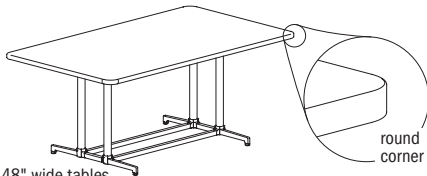

48" wide tables have double column base

LAMINATE

D	W	H	CTN WT	CU FT	Model
48	96	36	233	115	LKT4896-36TTRT
48	84	36	209	101	LKT4884-36TTRT
42	96	36	186	83	LKT4296-36TTRT
42	84	36	167	90	LKT4284-36TTRT
36	96	36	166	89	LKT3696-36TTRT
36	84	36	149	78	LKT3684-36TTRT

Laminate Tables "LKT" Models

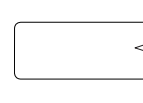

Eased Edge (R3)

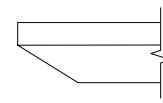

Reverse Bevel Edge (K9)

Eased Edge (R3)		Reverse Bevel Edge (K9)	
Standard Tier 1	Graded In Tier 2	Standard Tier 1	Graded In Tier 2
\$3,470	\$3,523	\$3,957	\$4,009
\$3,155	\$3,202	\$3,630	\$3,678
\$3,090	\$3,139	\$3,565	\$3,612
\$2,574	\$2,615	\$3,038	\$3,078
\$2,626	\$2,665	\$3,086	\$3,124
\$2,372	\$2,406	\$2,823	\$2,858

Features:

- price reflects complete table - top and base
- ships KD in multiple cartons
- one piece top
- model includes adjustable glide

Options:

- specify power/charging option, see below for options and upcharges

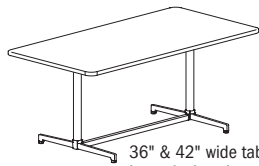

36" & 42" wide tables have single column base



top shape

LOK - CONFERENCE

To Order Specify

1 Laminate Model #	2 Edge Detail	3 Laminate Selection	3a PVC Edge Color	4 Electrical	5 Metal Color
Laminate (LKT)	See Edge Detail Options	See Laminate Selection	See PVC Edge Color Options	N None CT2 Dual Power Center Top CU2 Dual Power Underside CT2U1 Dual Power Center Top with Underside (See chart on next page)	See Metal Finish Color Options

Model Number Breakdown

LKT4896-36TTRT						
LK	T	4896	36	TT	R	T
LOK	Laminate	48" x 96"	Height	Rectangular Top Shape	Rounded Corner	T Base

Description

Rounded Rectangular Table with T Base at Counter Height (continued)

Veneer Tables "LKV" Models Solid Surface Tables "LKS" Models

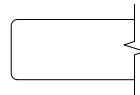

Eased Edge (R3)

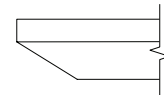

Reverse Bevel Edge (K9)

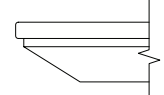

Reverse Bevel Edge (K7)

	D	W	H	CTN WT	CU FT	① Model	Veneer Tables		Solid Surface Tables		
							Essentials	Artisan	Essentials	Artisan	Standard
VENEER	48	96	36	233	115	LKV4896-36TTRT	\$4,805	\$5,156	\$5,125	\$5,446	--
	48	84	36	209	101	LKV4884-36TTRT	\$4,465	\$4,764	\$4,762	\$5,041	--
	42	96	36	186	83	LKV4296-36TTRT	\$4,585	\$4,953	\$4,997	\$5,324	--
	42	84	36	167	90	LKV4284-36TTRT	\$3,881	\$4,191	\$4,230	\$4,502	--
	36	96	36	166	89	LKV3696-36TTRT	\$3,529	\$3,814	\$3,849	\$4,097	--
	36	84	36	149	78	LKV3684-36TTRT	\$3,261	\$3,524	\$3,558	\$3,787	--
SOLID SURFACE	48	96	36	233	115	LKS4896-36TTRT	--	--	--	--	\$10,864
	48	84	36	209	101	LKS4884-36TTRT	--	--	--	--	\$9,721
	42	96	36	186	83	LKS4296-36TTRT	--	--	--	--	\$8,784
	42	84	36	167	90	LKS4284-36TTRT	--	--	--	--	\$7,764
	36	96	36	166	89	LKS3696-36TTRT	--	--	--	--	\$7,741
	36	84	36	149	78	LKS3684-36TTRT	--	--	--	--	\$6,994

Electrical Options and Upcharges

CT2	84 - 96 wide
Dual Power Center Top - Black	CT2BL - add \$1,535
Dual Power Center Top - White	CT2WH - add \$1,535
CU1	
Dual Power Underside - Black	CU1-1C - add \$610
Dual Power Underside with Wireless Charging - Black	CU1-1CW - add \$1,413
CT2U1	
Dual Power Center Top - Black with Underside	CT2U1-BL - add \$1,868
Dual Power Center Top - White with Underside	CT2U1-WH - add \$1,868
Dual Power Center Top - Black with Wireless Charging	CT2U1-BLW2 - add \$2,670
Dual Power Center Top - White with Wireless Charging	CT2U1-WHW2 - add \$2,670

Note: Order power infeed that best fits application

To Order Specify

① Veneer Model #	② Edge Detail	③ Wood Collection	④ Wood Finish	⑤ Electrical	⑥ Metal Color
Veneer (LKV)	See Edge Detail Options	Essentials	See Essentials Wood Finish Options	N None CT2 Dual Power Center Top CU2 Dual Power Underside CT2U1 Dual Power Center Top with Underside (See chart above)	See Metal Finish Color Options
		Artisan	④ Wood Finish See Artisan Wood Finish Options		

① Solid Surface Model #	② Top Surface Selection	③ Electrical	④ Metal Color
Solid Surface (LKS)	See Solid Surface Top Surface Selection Options	N None CT2 Dual Power Center Top CU2 Dual Power Underside CT2U1 Dual Power Center Top with Underside (See chart above)	See Metal Finish Color Options

LOK - CONFERENCE

Description

Rectangular Table with Y Base at Counter Height

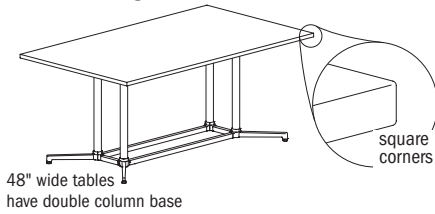

Laminate Tables "LKT" Models

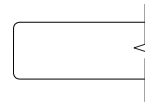

Eased Edge (R3)

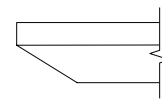

Reverse Bevel Edge (K9)

LAMINATE	D	W	H	CTN WT	CU FT	Model	Eased Edge (R3)		Reverse Bevel Edge (K9)	
							Standard Tier 1	Graded In Tier 2	Standard Tier 1	Graded In Tier 2
	48	96	36	232	115	LKT4896-36TTY	\$3,419	\$3,473	\$3,906	\$3,960
48	84	36	209	101	LKT4884-36TTY	\$3,027	\$3,073	\$3,500	\$3,548	
42	96	36	197	102	LKT4296-36TTY	\$3,874	\$3,922	\$4,349	\$4,394	
42	84	36	178	89	LKT4284-36TTY	\$2,637	\$2,677	\$3,101	\$3,141	
36	96	36	177	89	LKT3696-36TTY	\$2,650	\$2,690	\$3,111	\$3,151	
36	84	36	159	78	LKT3684-36TTY	\$2,355	\$2,390	\$2,808	\$2,843	

Features:

- price reflects complete table - top and base
- ships KD in multiple cartons
- one piece top
- model includes adjustable glide

Options:

- specify power/charging option, see below for options and upcharges

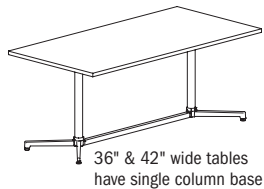

top shape

LOK - CONFERENCE

To Order Specify

1 Laminite Model #	2 Edge Detail	3 Laminite Selection	3a PVC Edge Color	4 Electrical	5 Metal Color
Laminite (LKT)	See Edge Detail Options	See Laminite Selection	See PVC Edge Color Options	N None CT2 Dual Power Center Top CU2 Dual Power Underside CT2U1 Dual Power Center Top with Underside (See chart on next page)	See Metal Finish Color Options

Model Number Breakdown

LKT4896-36TTY					
LK	T	4896	36	TT	Y
LOK	Laminite	48" x 96"	Height	Rectangular Top Shape	Y Base

Description

Rectangular Table with Y Base
at Counter Height
(continued)

Veneer Tables
"LKV" Models

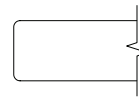

Eased Edge (R3)

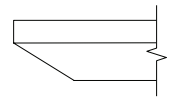

Reverse Bevel Edge (K9)

D	W	H	CTN WT	CU FT	① Model	Essentials		Artisan	
						Essentials	Artisan	Essentials	Artisan
48	96	36	232	115	LKV4896-36TTY	\$4,743	\$5,090	\$5,060	\$5,385
48	84	36	209	101	LKV4884-36TTY	\$4,301	\$4,602	\$4,599	\$4,878
42	96	36	197	102	LKV4296-36TTY	\$5,566	\$6,010	\$6,065	\$6,458
	84	36	178	89	LKV4284-36TTY	\$3,958	\$4,274	\$4,314	\$4,594
36	96	36	177	89	LKV3696-36TTY	\$3,562	\$3,847	\$3,882	\$4,133
36	84	36	159	78	LKV3684-36TTY	\$3,244	\$3,502	\$3,536	\$3,766

VENEER

Electrical Options and Upcharges

CT2	84 - 96 wide
Dual Power Center Top - Black	CT2BL - add \$1,535
Dual Power Center Top - White	CT2WH - add \$1,535
CU1	
Dual Power Underside - Black	CU1-1C - add \$610
Dual Power Underside with Wireless Charging - Black	CU1-1CW - add \$1,413
CT2U1	
Dual Power Center Top - Black with Underside	CT2U1-BL - add \$1,868
Dual Power Center Top - White with Underside	CT2U1-WH - add \$1,868
Dual Power Center Top - Black with Wireless Charging	CT2U1-BLW2 - add \$2,670
Dual Power Center Top - White with Wireless Charging	CT2U1-WhW2 - add \$2,670

Note: Order power infeed that best fits application

To Order Specify

① Veneer Model #	② Edge Detail	③ Wood Collection	④ Wood Finish	⑤ Electrical	⑥ Metal Color
Veneer (LKV)	See Edge Detail Options	Essentials	See Essentials Wood Finish Options	N None CT2 Dual Power Center Top CU2 Dual Power Underside CT2U1 Dual Power Center Top with Underside (See chart above)	See Metal Finish Color Options
		Artisan	④ Wood Finish See Artisan Wood Finish Options		

LOK - CONFERENCE

Description

Rounded Rectangular Table with Y Base at Counter Height

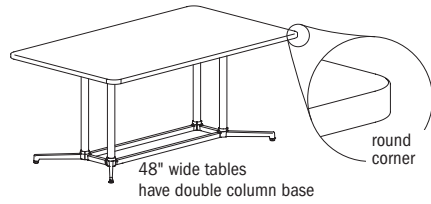

Laminate Tables "LKT" Models

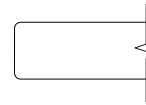

Eased Edge (R3)

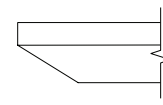

Reverse Bevel Edge (K9)

LAMINATE	D	W	H	CTN WT	CU FT	Model	Standard Tier 1	Graded In Tier 2	Standard Tier 1	Graded In Tier 2
	48	96	36	232	115	LKT4896-36TTRY	\$3,485	\$3,536	\$3,970	\$4,024
	48	84	36	209	101	LKT4884-36TTRY	\$3,085	\$3,132	\$3,561	\$3,607
42	96	36	197	102	LKT4296-36TTRY	\$3,936	\$3,981	\$4,408	\$4,455	
42	84	36	178	89	LKT4284-36TTRY	\$2,691	\$2,731	\$3,155	\$3,196	
36	96	36	177	89	LKT3696-36TTRY	\$2,705	\$2,744	\$3,166	\$3,205	
36	84	36	159	78	LKT3684-36TTRY	\$2,407	\$2,442	\$2,860	\$2,896	

Features:

- price reflects complete table - top and base
- ships KD in multiple cartons
- one piece top
- model includes adjustable glide

Options:

- specify power/charging option, see below for options and upcharges

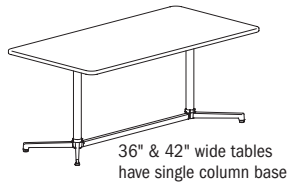

To Order Specify

1 Laminite Model #	2 Edge Detail	3 Laminite Selection	3a PVC Edge Color	4 Electrical	5 Metal Color
Laminite (LKT)	See Edge Detail Options	See Laminite Selection	See PVC Edge Color Options	N None CT2 Dual Power Center Top CU2 Dual Power Underside CT2U1 Dual Power Center Top with Underside (See chart on next page)	See Metal Finish Color Options

Model Number Breakdown

LKT4896-36TTRY						
LK	T	4896	36	TT	R	Y
LOK	Laminite	48" x 96"	Height	Rectangular Top Shape	Rounded Corner	Y Base

Description

Rounded Rectangular Table with Y Base at Counter Height (continued)

Veneer Tables "LKV" Models Solid Surface Tables "LKS" Models

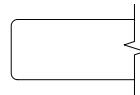

Eased Edge (R3)

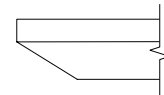

Reverse Bevel Edge (K9)

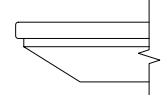

Reverse Bevel Edge (K7)

	D	W	H	CTN WT	CU FT	① Model	Veneer Tables		Solid Surface Tables		
							Essentials	Artisan	Essentials	Artisan	Standard
VENEER	48	96	36	232	115	LKV4896-36TTRY	\$4,824	\$5,173	\$5,142	\$5,469	--
	48	84	36	209	101	LKV4884-36TTRY	\$4,377	\$4,676	\$4,673	\$4,954	--
	42	96	36	197	102	LKV4296-36TTRY	\$5,639	\$6,090	\$6,147	\$6,545	--
	42	84	36	178	89	LKV4284-36TTRY	\$4,024	\$4,345	\$4,385	\$4,672	--
	36	96	36	177	89	LKV3696-36TTRY	\$3,627	\$3,918	\$3,952	\$4,210	--
	36	84	36	159	78	LKV3684-36TTRY	\$3,308	\$3,572	\$3,604	\$3,838	--
SOLID SURFACE	48	96	36	232	115	LKS4896-36TTRY	--	--	--	--	\$10,881
	48	84	36	209	101	LKS4884-36TTRY	--	--	--	--	\$9,633
	42	96	36	197	102	LKS4296-36TTRY	--	--	--	--	\$9,840
	42	84	36	178	89	LKS4284-36TTRY	--	--	--	--	\$7,908
	36	96	36	177	89	LKS3696-36TTRY	--	--	--	--	\$7,839
	36	84	36	159	78	LKS3684-36TTRY	--	--	--	--	\$7,038

Electrical Options and Upcharges

CT2	84 - 96 wide
Dual Power Center Top - Black	CT2BL - add \$1,535
Dual Power Center Top - White	CT2WH - add \$1,535
CU1	
Dual Power Underside - Black	CU1-1C - add \$610
Dual Power Underside with Wireless Charging - Black	CU1-1CW - add \$1,413
CT2U1	
Dual Power Center Top - Black with Underside	CT2U1-BL - add \$1,868
Dual Power Center Top - White with Underside	CT2U1-WH - add \$1,868
Dual Power Center Top - Black with Wireless Charging	CT2U1-BLW2 - add \$2,670
Dual Power Center Top - White with Wireless Charging	CT2U1-WHW2 - add \$2,670

Note: Order power infeed that best fits application

To Order Specify

① Veneer Model #	② Edge Detail	③ Wood Collection	④ Wood Finish	⑤ Electrical	⑥ Metal Color
Veneer (LKV)	See Edge Detail Options	Essentials	See Essentials Wood Finish Options	N None CT2 Dual Power Center Top CU2 Dual Power Underside CT2U1 Dual Power Center Top with Underside (See chart above)	See Metal Finish Color Options
		Artisan	④ Wood Finish See Artisan Wood Finish Options		

① Solid Surface Model #	② Top Surface Selection	③ Electrical	④ Metal Color
Solid Surface (LKS)	See Solid Surface Top Surface Selection Options	N None CT2 Dual Power Center Top CU2 Dual Power Underside CT2U1 Dual Power Center Top with Underside (See chart above)	See Metal Finish Color Options

LOK - CONFERENCE

Description

Arc Rectangular Table with T Base at Counter Height

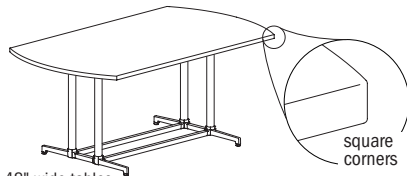

48" wide tables have double column base

LAMINATE	D	W	H	CTN WT	CU FT	Model	Laminate Tables "LKT" Models			
							Eased Edge (R3)		Reverse Bevel Edge (K9)	
							Standard Tier 1	Graded In Tier 2	Standard Tier 1	Graded In Tier 2
	48	96	36	226	115	LKT4896-36ART	\$3,470	\$3,523	\$3,957	\$4,009
	48	84	36	202	101	LKT4884-36ART	\$3,155	\$3,202	\$3,630	\$3,678
	42	96	36	182	83	LKT4296-36ART	\$3,090	\$3,139	\$3,565	\$3,612
	42	84	36	162	90	LKT4284-36ART	\$2,574	\$2,615	\$3,038	\$3,078
	36	96	36	163	89	LKT3696-36ART	\$2,626	\$2,665	\$3,086	\$3,124
	36	84	36	145	78	LKT3684-36ART	\$2,372	\$2,406	\$2,823	\$2,858

Features:

- price reflects complete table - top and base
- ships KD in multiple cartons
- one piece top
- model includes adjustable glide

Options:

- specify power/charging option, see below for options and upcharges

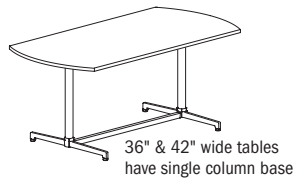

LOK - CONFERENCE

To Order Specify

1 Laminite Model #	2 Edge Detail	3 Laminite Selection	3a PVC Edge Color	4 Electrical	5 Metal Color
Laminite (LKT)	See Edge Detail Options	See Laminite Selection	See PVC Edge Color Options	N None CT2 Dual Power Center Top CU2 Dual Power Underside CT2U1 Dual Power Center Top with Underside (See chart on next page)	See Metal Finish Color Options

Model Number Breakdown

LKT4896-36ART					
LK	T	4896	36	AR	T
LOK	Laminite	48" x 96"	Height	Arc Rectangular Top Shape	T Base

Description

Arc Rectangular Table with T Base at Counter Height (continued)

Veneer Tables "LKV" Models

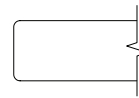

Eased Edge (R3)

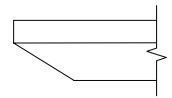

Reverse Bevel Edge (K9)

D	W	H	CTN WT	CU FT	Model	Essentials		Artisan	
						Essentials	Artisan	Essentials	Artisan
48	96	36	226	115	LKV4896-36ART	\$4,805	\$5,156	\$5,125	\$5,446
48	84	36	202	101	LKV4884-36ART	\$4,465	\$4,764	\$4,762	\$5,041
42	96	36	182	83	LKV4296-36ART	\$4,585	\$4,953	\$4,997	\$5,324
42	84	36	162	90	LKV4284-36ART	\$3,881	\$4,191	\$4,230	\$4,502
36	96	36	163	89	LKV3696-36ART	\$3,529	\$3,814	\$3,849	\$4,097
36	84	36	145	78	LKV3684-36ART	\$3,261	\$3,524	\$3,558	\$3,787

VENEER

Electrical Options and Upcharges

CT2	84 - 96 wide
Dual Power Center Top - Black	CT2BL - add \$1,535
Dual Power Center Top - White	CT2WH - add \$1,535
CU1	
Dual Power Underside - Black	CU1-1C - add \$610
Dual Power Underside with Wireless Charging - Black	CU1-1CW - add \$1,413
CT2U1	
Dual Power Center Top - Black with Underside	CT2U1-BL - add \$1,868
Dual Power Center Top - White with Underside	CT2U1-WH - add \$1,868
Dual Power Center Top - Black with Wireless Charging	CT2U1-BLW2 - add \$2,670
Dual Power Center Top - White with Wireless Charging	CT2U1-WhW2 - add \$2,670

Note: Order power infeed that best fits application

To Order Specify

1 Veneer Model #	2 Edge Detail	3 Wood Collection	4 Wood Finish	5 Electrical	6 Metal Color
Veneer (LKV)	See Edge Detail Options	Essentials	See Essentials Wood Finish Options	N None CT2 Dual Power Center Top CU2 Dual Power Underside CT2U1 Dual Power Center Top with Underside (See chart above)	See Metal Finish Color Options
		Artisan	4 Wood Finish See Artisan Wood Finish Options		

LOK - CONFERENCE

Description

Rounded Arc Rectangular Table with T Base at Counter Height

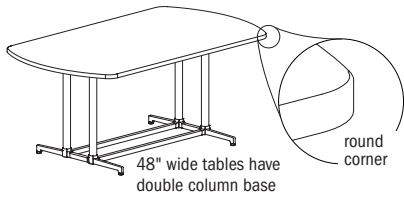

Laminate Tables
"LKT" Models

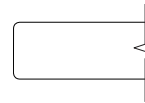

Eased Edge (R3)

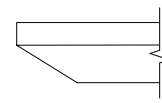

Reverse Bevel Edge (K9)

LAMINATE	D	W	H	CTN WT	CU FT	Model	Standard Tier 1	Graded In Tier 2	Standard Tier 1	Graded In Tier 2
		48	96	36	226	115	LKT4896-36ARRT	\$3,470	\$3,523	\$3,957
	48	84	36	202	101	LKT4884-36ARRT	\$3,155	\$3,202	\$3,630	\$3,678
	42	96	36	182	83	LKT4296-36ARRT	\$3,090	\$3,139	\$3,565	\$3,612
	42	84	36	162	90	LKT4284-36ARRT	\$2,574	\$2,615	\$3,038	\$3,078
	36	96	36	163	89	LKT3696-36ARRT	\$2,626	\$2,665	\$3,086	\$3,124
	36	84	36	145	78	LKT3684-36ARRT	\$2,372	\$2,406	\$2,823	\$2,858

Features:

- price reflects complete table - top and base
- ships KD in multiple cartons
- one piece top
- model includes adjustable glide

Options:

- specify power/charging option, see below for options and upcharges

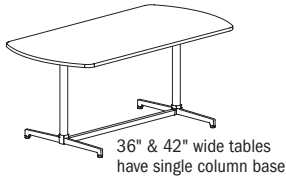

LOK - CONFERENCE

To Order Specify

1 Laminite Model #	2 Edge Detail	3 Laminite Selection	3a PVC Edge Color	4 Electrical	5 Metal Color
Laminite (LKT)	See Edge Detail Options	See Laminite Selection	See PVC Edge Color Options	N None CT2 Dual Power Center Top CU2 Dual Power Underside CT2U1 Dual Power Center Top with Underside (See chart on next page)	See Metal Finish Color Options

Model Number Breakdown

LKT4896-36ARRT						
LK	T	4896	36	AR	R	T
LOK	Laminite	48" x 96"	Height	Arc Rectangular Top Shape	Rounded Corner	T Base

Description

Rounded Arc Rectangular Table with T Base at Counter Height (continued)

Veneer Tables "LKV" Models Solid Surface Tables "LKS" Models

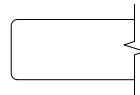

Eased Edge (R3)

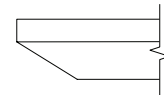

Reverse Bevel Edge (K9)

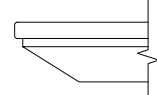

Reverse Bevel Edge (K7)

	D	W	H	CTN WT	CU FT	① Model	Veneer Tables		Solid Surface Tables		
							Essentials	Artisan	Essentials	Artisan	Standard
VENEER	48	96	36	226	115	LKV4896-36ARRT	\$4,805	\$5,156	\$5,125	\$5,446	--
	48	84	36	202	101	LKV4884-36ARRT	\$4,465	\$4,764	\$4,762	\$5,041	--
	42	96	36	182	83	LKV4296-36ARRT	\$4,585	\$4,953	\$4,997	\$5,324	--
	42	84	36	162	90	LKV4284-36ARRT	\$3,881	\$4,191	\$4,230	\$4,502	--
	36	96	36	163	89	LKV3696-36ARRT	\$3,529	\$3,814	\$3,849	\$4,097	--
	36	84	36	145	78	LKV3684-36ARRT	\$3,261	\$3,524	\$3,558	\$3,787	--
SOLID SURFACE	48	96	36	226	115	LKS4896-36ARRT	--	--	--	--	\$10,864
	48	84	36	202	101	LKS4884-36ARRT	--	--	--	--	\$9,721
	42	96	36	182	83	LKS4296-36ARRT	--	--	--	--	\$8,784
	42	84	36	162	90	LKS4284-36ARRT	--	--	--	--	\$7,764
	36	96	36	163	89	LKS3696-36ARRT	--	--	--	--	\$7,741
	36	84	36	145	78	LKS3684-36ARRT	--	--	--	--	\$6,994

Electrical Options and Upcharges

CT2	84 - 96 wide
Dual Power Center Top - Black	CT2BL - add \$1,535
Dual Power Center Top - White	CT2WH - add \$1,535
CU1	
Dual Power Underside - Black	CU1-1C - add \$610
Dual Power Underside with Wireless Charging - Black	CU1-1CW - add \$1,413
CT2U1	
Dual Power Center Top - Black with Underside	CT2U1-BL - add \$1,868
Dual Power Center Top - White with Underside	CT2U1-WH - add \$1,868
Dual Power Center Top - Black with Wireless Charging	CT2U1-BLW2 - add \$2,670
Dual Power Center Top - White with Wireless Charging	CT2U1-WHW2 - add \$2,670

Note: Order power infeed that best fits application

To Order Specify

① Veneer Model #	② Edge Detail	③ Wood Collection	④ Wood Finish	⑤ Electrical	⑥ Metal Color
Veneer (LKV)	See Edge Detail Options	Essentials	See Essentials Wood Finish Options	N None CT2 Dual Power Center Top CU2 Dual Power Underside CT2U1 Dual Power Center Top with Underside (See chart above)	See Metal Finish Color Options
		Artisan	④ Wood Finish See Artisan Wood Finish Options		

① Solid Surface Model #	② Top Surface Selection	③ Electrical	④ Metal Color
Solid Surface (LKS)	See Solid Surface Top Surface Selection Options	N None CT2 Dual Power Center Top CU2 Dual Power Underside CT2U1 Dual Power Center Top with Underside (See chart above)	See Metal Finish Color Options

LOK - CONFERENCE

Description

Arc Rectangular Table with Y Base at Counter Height

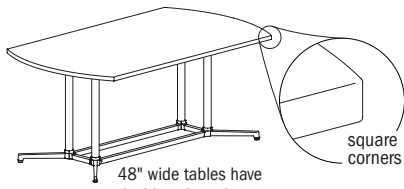

Laminate Tables "LKT" Models

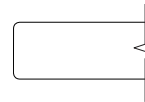

Eased Edge (R3)

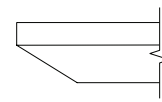

Reverse Bevel Edge (K9)

LAMINATE	D	W	H	CTN WT	CU FT	Model	Eased Edge (R3)		Reverse Bevel Edge (K9)	
							Standard Tier 1	Graded In Tier 2	Standard Tier 1	Graded In Tier 2
	48	96	36	226	115	LKT4896-36ARY	\$3,485	\$3,536	\$3,970	\$4,024
	48	84	36	201	101	LKT4884-36ARY	\$3,085	\$3,132	\$3,561	\$3,607
	42	96	36	193	102	LKT4296-36ARY	\$3,936	\$3,981	\$4,408	\$4,455
	42	84	36	172	89	LKT4284-36ARY	\$2,691	\$2,731	\$3,155	\$3,196
	36	96	36	177	89	LKT3696-36ARY	\$2,705	\$2,744	\$3,166	\$3,205
	36	84	36	156	78	LKT3684-36ARY	\$2,407	\$2,442	\$2,860	\$2,896

Features:

- price reflects complete table - top and base
- ships KD in multiple cartons
- one piece top
- model includes adjustable glide

Options:

- specify power/charging option, see below for options and upcharges

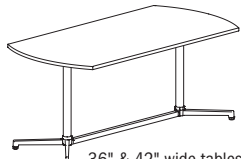

LOK - CONFERENCE

To Order Specify

1 Laminite Model #	2 Edge Detail	3 Laminite Selection	3a PVC Edge Color	4 Electrical	5 Metal Color
Laminite (LKT)	See Edge Detail Options	See Laminite Selection	See PVC Edge Color Options	N None CT2 Dual Power Center Top CU2 Dual Power Underside CT2U1 Dual Power Center Top with Underside (See chart on next page)	See Metal Finish Color Options

Model Number Breakdown

LKT4896-36ARY					
LK	T	4896	36	AR	Y
LOK	Laminite	48" x 96"	Height	Arc Rectangular Top Shape	Y Base

Description

Arc Rectangular Table with Y Base at Counter Height (continued)

Veneer Tables "LKV" Models

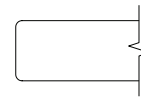

Eased Edge (R3)

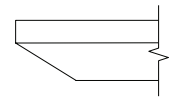

Reverse Bevel Edge (K9)

VENEER	D	W	H	CTN WT	CU FT	Model	Essentials	Artisan	Essentials	Artisan
	48	96	36	226	115	LKV4896-36ARY	\$4,824	\$5,173	\$5,142	\$5,469
	48	84	36	201	101	LKV4884-36ARY	\$4,377	\$4,676	\$4,673	\$4,954
	42	96	36	193	102	LKV4296-36ARY	\$5,639	\$6,090	\$6,147	\$6,545
	42	84	36	172	89	LKV4284-36ARY	\$4,024	\$4,345	\$4,385	\$4,672
	36	96	36	177	89	LKV3696-36ARY	\$3,627	\$3,918	\$3,952	\$4,210
	36	84	36	156	78	LKV3684-36ARY	\$3,308	\$3,572	\$3,604	\$3,838

Electrical Options and Upcharges

CT2	84 - 96 wide
Dual Power Center Top - Black	CT2BL - add \$1,535
Dual Power Center Top - White	CT2WH - add \$1,535
CU1	
Dual Power Underside - Black	CU1-1C - add \$610
Dual Power Underside with Wireless Charging - Black	CU1-1CW - add \$1,413
CT2U1	
Dual Power Center Top - Black with Underside	CT2U1-BL - add \$1,868
Dual Power Center Top - White with Underside	CT2U1-WH - add \$1,868
Dual Power Center Top - Black with Wireless Charging	CT2U1-BLW2 - add \$2,670
Dual Power Center Top - White with Wireless Charging	CT2U1-WHW2 - add \$2,670

Note: Order power infeed that best fits application

To Order Specify

1 Veneer Model #	2 Edge Detail	3 Wood Collection	4 Wood Finish	5 Electrical	6 Metal Color
Veneer (LKV)	See Edge Detail Options	Essentials	See Essentials Wood Finish Options	N None CT2 Dual Power Center Top CU2 Dual Power Underside CT2U1 Dual Power Center Top with Underside (See chart above)	See Metal Finish Color Options
		Artisan	4 Wood Finish See Artisan Wood Finish Options		

LOK - CONFERENCE

Description

Rounded Arc Rectangular Table with Y Base at Counter Height

Laminate Tables
"LKT" Models

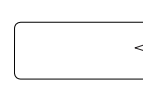
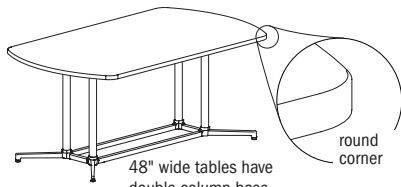

Eased Edge (R3)

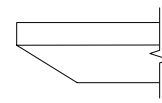

Reverse Bevel Edge (K9)

LAMINATE	D	W	H	CTN WT	CU FT	① Model	Eased Edge (R3)		Reverse Bevel Edge (K9)	
							Standard	Graded In	Standard	Graded In
							Tier 1	Tier 2	Tier 1	Tier 2
	48	96	36	226	115	LKT4896-36ARRY	\$3,485	\$3,536	\$3,970	\$4,024
	48	84	36	201	101	LKT4884-36ARRY	\$3,085	\$3,132	\$3,561	\$3,607
	42	96	36	193	102	LKT4296-36ARRY	\$3,936	\$3,981	\$4,408	\$4,455
	42	84	36	172	89	LKT4284-36ARRY	\$2,691	\$2,731	\$3,155	\$3,196
	36	96	36	177	89	LKT3696-36ARRY	\$2,705	\$2,744	\$3,166	\$3,205
	36	84	36	156	78	LKT3684-36ARRY	\$2,407	\$2,442	\$2,860	\$2,896

Features:

- price reflects complete table - top and base
- ships KD in multiple cartons
- one piece top
- model includes adjustable glide

Options:

- specify power/charging option, see below for options and upcharges



36" & 42" wide tables have single column base

LOK - CONFERENCE

To Order Specify

① Laminate Model #	② Edge Detail	③ Laminate Selection	④ PVC Edge Color	⑤ Electrical	⑥ Metal Color
Laminate (LKT)	See Edge Detail Options	See Laminate Selection	See PVC Edge Color Options	N None CT2 Dual Power Center Top CU2 Dual Power Underside CT2U1 Dual Power Center Top with Underside (See chart on next page)	See Metal Finish Color Options

Model Number Breakdown

LKT4896-36ARRY						
LK	T	4896	36	AR	R	Y
LOK	Laminate	48" x 96"	Height	Arc Rectangular Top Shape	Rounded Corner	Y Base

Description

Rounded Arc Rectangular Table with Y Base at Counter Height (continued)

Veneer Tables "LKV" Models Solid Surface Tables "LKS" Models

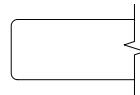

Eased Edge (R3)

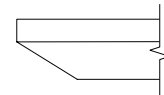

Reverse Bevel Edge (K9)

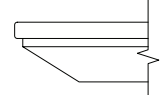

Reverse Bevel Edge (K7)

	D	W	H	CTN WT	CU FT	① Model	Veneer		Solid Surface		
							Essentials	Artisan	Essentials	Artisan	Standard
VENEER	48	96	36	226	115	LKV4896-36ARRY	\$4,824	\$5,173	\$5,142	\$5,469	--
	48	84	36	201	101	LKV4884-36ARRY	\$4,377	\$4,676	\$4,673	\$4,954	--
	42	96	36	193	102	LKV4296-36ARRY	\$5,639	\$6,090	\$6,147	\$6,545	--
	42	84	36	172	89	LKV4284-36ARRY	\$4,024	\$4,345	\$4,385	\$4,672	--
	36	96	36	177	89	LKV3696-36ARRY	\$3,627	\$3,918	\$3,952	\$4,210	--
	36	84	36	156	78	LKV3684-36ARRY	\$3,308	\$3,572	\$3,604	\$3,838	--
SOLID SURFACE	48	96	36	226	115	LKS4896-36ARRY	--	--	--	--	\$10,881
	48	84	36	201	101	LKS4884-36ARRY	--	--	--	--	\$9,633
	42	96	36	193	102	LKS4296-36ARRY	--	--	--	--	\$9,840
	42	84	36	172	89	LKS4284-36ARRY	--	--	--	--	\$7,908
	36	96	36	177	89	LKS3696-36ARRY	--	--	--	--	\$7,839
	36	84	36	156	78	LKS3684-36ARRY	--	--	--	--	\$7,038

Electrical Options and Upcharges

CT2	84 - 96 wide
Dual Power Center Top - Black	CT2BL - add \$1,535
Dual Power Center Top - White	CT2WH - add \$1,535
CU1	
Dual Power Underside - Black	CU1-1C - add \$610
Dual Power Underside with Wireless Charging - Black	CU1-1CW - add \$1,413
CT2U1	
Dual Power Center Top - Black with Underside	CT2U1-BL - add \$1,868
Dual Power Center Top - White with Underside	CT2U1-WH - add \$1,868
Dual Power Center Top - Black with Wireless Charging	CT2U1-BLW2 - add \$2,670
Dual Power Center Top - White with Wireless Charging	CT2U1-WHW2 - add \$2,670

Note: Order power infeed that best fits application

To Order Specify

① Veneer Model #	② Edge Detail	③ Wood Collection	④ Wood Finish	⑤ Electrical	⑥ Metal Color
Veneer (LKV)	See Edge Detail Options	Essentials	See Essentials Wood Finish Options	N None CT2 Dual Power Center Top CU2 Dual Power Underside CT2U1 Dual Power Center Top with Underside (See chart above)	See Metal Finish Color Options
		Artisan	④ Wood Finish See Artisan Wood Finish Options		

① Solid Surface Model #	② Top Surface Selection	③ Electrical	④ Metal Color
Solid Surface (LKS)	See Solid Surface Top Surface Selection Options	N None CT2 Dual Power Center Top CU2 Dual Power Underside CT2U1 Dual Power Center Top with Underside (See chart above)	See Metal Finish Color Options

LOK - CONFERENCE

Description

Racetrack Table with Y Base at Counter Height

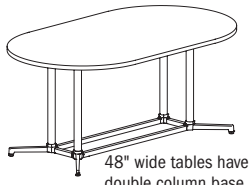

Laminate Tables "LKT" Models

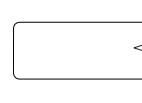

Eased Edge (R3)

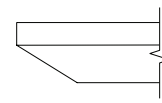

Reverse Bevel Edge (K9)

LAMINATE	D	W	H	CTN WT	CU FT	Model	Eased Edge (R3)		Reverse Bevel Edge (K9)	
							Standard Tier 1	Graded In Tier 2	Standard Tier 1	Graded In Tier 2
	48	96	36	213	115	LKT4896-36RKY	\$3,354	\$3,409	\$3,840	\$3,896
48	84	36	191	101	LKT4884-36RKY	\$3,085	\$3,132	\$3,561	\$3,607	
42	96	36	185	102	LKT4296-36RKY	\$3,936	\$3,981	\$4,408	\$4,455	
42	84	36	164	89	LKT4284-36RKY	\$2,691	\$2,731	\$3,155	\$3,196	
36	96	36	168	89	LKT3696-36RKY	\$2,705	\$2,744	\$3,166	\$3,205	
36	84	36	150	78	LKT3684-36RKY	\$2,407	\$2,442	\$2,860	\$2,896	

Features:

- price reflects complete table - top and base
- ships KD in multiple cartons
- one piece top
- model includes adjustable glide

Options:

- specify power/charging option, see below for options and upcharges

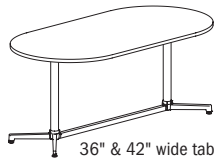

36" & 42" wide tables have single column base

LOK - CONFERENCE

To Order Specify

1 Laminate Model #	2 Edge Detail	3 Laminate Selection	3a PVC Edge Color	4 Electrical	5 Metal Color
Laminate (LKT)	See Edge Detail Options	See Laminate Selection	See PVC Edge Color Options	N None CT2 Dual Power Center Top CU2 Dual Power Underside CT2U1 Dual Power Center Top with Underside (See chart on next page)	See Metal Finish Color Options

Model Number Breakdown

LKT4896-36RKY					
LK	T	4896	36	RK	Y
LOK	Laminate	48" x 96"	Height	Racetrack Top Shape	Y Base

Description

Racetrack Table with Y Base at Counter Height (continued)

Veneer Tables "LKV" Models

Solid Surface Tables "LKS" Models

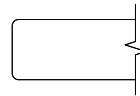

Eased Edge (R3)

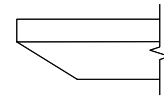

Reverse Bevel Edge (K9)

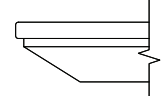

Reverse Bevel Edge (K7)

	D	W	H	CTN WT	CU FT	① Model	Veneer Tables		Solid Surface Tables		
							Essentials	Artisan	Essentials	Artisan	Standard
VENEER	48	96	36	213	115	LKV4896-36RKY	\$4,661	\$5,007	\$4,978	\$5,303	--
	48	84	36	191	101	LKV4884-36RKY	\$4,377	\$4,676	\$4,673	\$4,954	--
	42	96	36	185	102	LKV4296-36RKY	\$5,639	\$6,090	\$6,147	\$6,545	--
	42	84	36	164	89	LKV4284-36RKY	\$4,024	\$4,345	\$4,385	\$4,672	--
	36	96	36	168	89	LKV3696-36RKY	\$3,627	\$3,918	\$3,952	\$4,210	--
	36	84	36	150	78	LKV3684-36RKY	\$3,308	\$3,572	\$3,604	\$3,838	--
SOLID SURFACE	48	96	36	213	115	LKS4896-36RKY	--	--	--	--	\$10,716
	48	84	36	191	101	LKS4884-36RKY	--	--	--	--	\$9,633
	42	96	36	185	102	LKS4296-36RKY	--	--	--	--	\$9,840
	42	84	36	164	89	LKS4284-36RKY	--	--	--	--	\$7,908
	36	96	36	168	89	LKS3696-36RKY	--	--	--	--	\$7,839
	36	84	36	150	78	LKS3684-36RKY	--	--	--	--	\$7,038

Electrical Options and Upcharges

CT2	84 - 96 wide
Dual Power Center Top - Black	CT2BL - add \$1,535
Dual Power Center Top - White	CT2WH - add \$1,535
CU1	
Dual Power Underside - Black	CU1-1C - add \$610
Dual Power Underside with Wireless Charging - Black	CU1-1CW - add \$1,413
CT2U1	
Dual Power Center Top - Black with Underside	CT2U1-BL - add \$1,868
Dual Power Center Top - White with Underside	CT2U1-WH - add \$1,868
Dual Power Center Top - Black with Wireless Charging	CT2U1-BLW2 - add \$2,670
Dual Power Center Top - White with Wireless Charging	CT2U1-WHW2 - add \$2,670

Note: Order power infeed that best fits application

To Order Specify

① Veneer Model #	② Edge Detail	③ Wood Collection	④ Wood Finish	⑤ Electrical	⑥ Metal Color
Veneer (LKV)	See Edge Detail Options	Essentials	See Essentials Wood Finish Options	N None CT2 Dual Power Center Top CU2 Dual Power Underside CT2U1 Dual Power Center Top with Underside (See chart above)	See Metal Finish Color Options
		Artisan	④ Wood Finish See Artisan Wood Finish Options		
① Solid Surface Model #	② Top Surface Selection	③ Electrical		④ Metal Color	
Solid Surface (LKS)	See Solid Surface Top Surface Selection Options	N None CT2 Dual Power Center Top CU2 Dual Power Underside CT2U1 Dual Power Center Top with Underside (See chart above)		See Metal Finish Color Options	

LOK - CONFERENCE

Description

Oval Table with Y Base at Counter Height

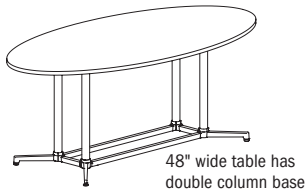

Laminate Tables
"LKT" Models

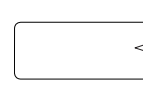

Eased Edge (R3)

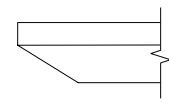

Reverse Bevel Edge (K9)

LAMINATE	D	W	H	CTN WT	CU FT	Model	Eased Edge (R3)		Reverse Bevel Edge (K9)	
							Standard	Graded In	Standard	Graded In
							Tier 1	Tier 2	Tier 1	Tier 2
	48	96	36	194	115	LKT4896-360VY	\$3,238	\$3,289	\$3,725	\$3,776
	42	84	36	150	89	LKT4284-360VY	\$2,691	\$2,731	\$3,155	\$3,196

Features:

- price reflects complete table - top and base
- ships KD in multiple cartons
- one piece top
- model includes adjustable glide

Options:

- specify power/charging option, see below for options and upcharges

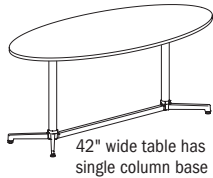

LOK - CONFERENCE

To Order Specify

1 Laminate Model #	2 Edge Detail	3 Laminate Selection	3a PVC Edge Color	4 Electrical	5 Metal Color
Laminate (LKT)	See Edge Detail Options	See Laminate Selection	See PVC Edge Color Options	N None CT2 Dual Power Center Top CU2 Dual Power Underside CT2U1 Dual Power Center Top with Underside (See chart on next page)	See Metal Finish Color Options

Model Number Breakdown

LKT4896-36RKY					
LK	T	4896	36	RK	Y
LOK	Laminate	48" x 96"	Height	Racetrack Top Shape	Y Base

Description

Oval Table with Y Base at Counter Height (continued)

Veneer Tables "LKV" Models Solid Surface Tables "LKS" Models

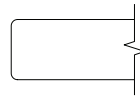

Eased Edge (R3)

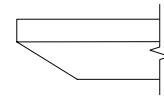

Reverse Bevel Edge (K9)

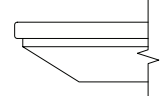

Reverse Bevel Edge (K7)

	D	W	H	CTN WT	CU FT	① Model	Veneer Tables "LKV" Models		Solid Surface Tables "LKS" Models		
							Essentials	Artisan	Essentials	Artisan	Standard
VENEER	48	96	36	194	115	LKV4896-360VY	\$4,510	\$4,856	\$4,827	\$5,152	--
	42	84	36	150	89	LKV4284-360VY	\$4,024	\$4,345	\$4,385	\$4,672	--
SOL SURF	48	96	36	194	115	LKS4896-360VY	--	--	--	--	\$10,567
	42	84	36	150	89	LKS4284-360VY	--	--	--	--	\$7,908

Electrical Options and Upcharges

CT2	84 - 96 wide
Dual Power Center Top - Black	CT2BL - add \$1,535
Dual Power Center Top - White	CT2WH - add \$1,535
CU1	
Dual Power Underside - Black	CU1-1C - add \$610
Dual Power Underside with Wireless Charging - Black	CU1-1CW - add \$1,413
CT2U1	
Dual Power Center Top - Black with Underside	CT2U1-BL - add \$1,868
Dual Power Center Top - White with Underside	CT2U1-WH - add \$1,868
Dual Power Center Top - Black with Wireless Charging	CT2U1-BLW2 - add \$2,670
Dual Power Center Top - White with Wireless Charging	CT2U1-WHW2 - add \$2,670

LOK - CONFERENCE

Note: Order power infeed that best fits application

To Order Specify

① Veneer Model #	② Edge Detail	③ Wood Collection	④ Wood Finish	⑤ Electrical	⑥ Metal Color
Veneer (LKV)	See Edge Detail Options	Essentials	See Essentials Wood Finish Options	N None CT2 Dual Power Center Top CU2 Dual Power Underside CT2U1 Dual Power Center Top with Underside (See chart above)	See Metal Finish Color Options
		Artisan	④ Wood Finish See Artisan Wood Finish Options		
① Solid Surface Model #	② Top Surface Selection	③ Electrical		④ Metal Color	
Solid Surface (LKS)	See Solid Surface Top Surface Selection Options	N None CT2 Dual Power Center Top CU2 Dual Power Underside (See chart above) CT2U1 Dual Power Center Top with Underside		See Metal Finish Color Options	

Description

Boat Table with T Base at Counter Height

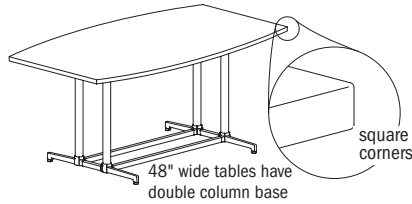

Laminate Tables
"LKT" Models

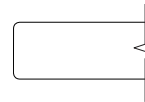

Eased Edge (R3)

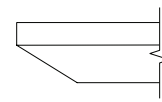

Reverse Bevel Edge (K9)

LAMINATE	D	W	H	CTN WT	CU FT	Model	Eased Edge (R3)		Reverse Bevel Edge (K9)	
							Standard	Graded In	Standard	Graded In
							Tier 1	Tier 2	Tier 1	Tier 2
	48	96	36	226	101	LKT4896-36BTT	\$3,470	\$3,523	\$3,957	\$4,009
	48	84	36	204	101	LKT4884-36BTT	\$3,155	\$3,202	\$3,630	\$3,678
	42	96	36	180	83	LKT4296-36BTT	\$3,090	\$3,139	\$3,565	\$3,612
	42	84	36	162	90	LKT4284-36BTT	\$2,574	\$2,615	\$3,038	\$3,078
	36	96	36	159	89	LKT3696-36BTT	\$2,626	\$2,665	\$3,086	\$3,124
	36	84	36	143	78	LKT3684-36BTT	\$2,372	\$2,406	\$2,823	\$2,858

Features:

- price reflects complete table - top and base
- ships KD in multiple cartons
- one piece top
- model includes adjustable glide

Options:

- specify power/charging option, see below for options and upcharges

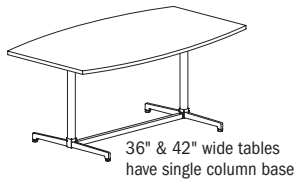

LOK - CONFERENCE

To Order Specify

1 Laminite Model #	2 Edge Detail	3 Laminite Selection	3a PVC Edge Color	4 Electrical	5 Metal Color
Laminite (LKT)	See Edge Detail Options	See Laminite Selection	See PVC Edge Color Options	N None CT2 Dual Power Center Top CU2 Dual Power Underside CT2U1 Dual Power Center Top with Underside (See chart on next page)	See Metal Finish Color Options

Model Number Breakdown

LKT4896-36BTT					
LK	T	4896	36	BT	T
LOK	Laminite	48" x 96"	Height	Boat Top Shape	T Base

Description

Boat Table with T Base at Counter Height (continued)

Veneer Tables "LKV" Models

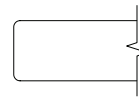

Eased Edge (R3)

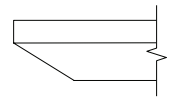

Reverse Bevel Edge (K9)

D	W	H	CTN WT	CU FT	Model	Essentials		Artisan	
						Essentials	Artisan	Essentials	Artisan
48	96	36	226	101	LKV4896-36BTT	\$4,805	\$5,156	\$5,125	\$5,446
48	84	36	204	101	LKV4884-36BTT	\$4,465	\$4,764	\$4,762	\$5,041
42	96	36	180	83	LKV4296-36BTT	\$4,585	\$4,953	\$4,997	\$5,324
	84	36	162	90	LKV4284-36BTT	\$3,881	\$4,191	\$4,230	\$4,502
36	96	36	159	89	LKV3696-36BTT	\$3,529	\$3,814	\$3,849	\$4,097
36	84	36	143	78	LKV3684-36BTT	\$3,261	\$3,524	\$3,558	\$3,787

VENEER

Electrical Options and Upcharges

CT2	84 - 96 wide
Dual Power Center Top - Black	CT2BL - add \$1,535
Dual Power Center Top - White	CT2WH - add \$1,535
CU1	
Dual Power Underside - Black	CU1-1C - add \$610
Dual Power Underside with Wireless Charging - Black	CU1-1CW - add \$1,413
CT2U1	
Dual Power Center Top - Black with Underside	CT2U1-BL - add \$1,868
Dual Power Center Top - White with Underside	CT2U1-WH - add \$1,868
Dual Power Center Top - Black with Wireless Charging	CT2U1-BLW2 - add \$2,670
Dual Power Center Top - White with Wireless Charging	CT2U1-WHW2 - add \$2,670

Note: Order power infeed that best fits application

To Order Specify

1 Veneer Model #	2 Edge Detail	3 Wood Collection	4 Wood Finish	5 Electrical	6 Metal Color
Veneer (LKV)	See Edge Detail Options	Essentials	See Essentials Wood Finish Options	N None CT2 Dual Power Center Top CU2 Dual Power Underside CT2U1 Dual Power Center Top with Underside (See chart above)	See Metal Finish Color Options
		Artisan	4 Wood Finish See Artisan Wood Finish Options		

LOK - CONFERENCE

Description

Boat Table with Y Base at Counter Height

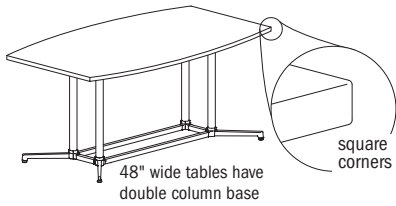

Laminate Tables
"LKT" Models

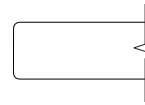

Eased Edge (R3)

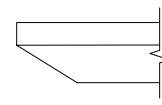

Reverse Bevel Edge (K9)

LAMINATE	D	W	H	CTN WT	CU FT	Model	Eased Edge (R3)		Reverse Bevel Edge (K9)	
							Standard	Graded In	Standard	Graded In
							Tier 1	Tier 2	Tier 1	Tier 2
	48	96	36	225	115	LKT4896-36BTY	\$3,485	\$3,536	\$3,970	\$4,024
	48	84	36	204	101	LKT4884-36BTY	\$3,085	\$3,132	\$3,561	\$3,607
	42	96	36	194	102	LKT4296-36BTY	\$3,936	\$3,981	\$4,408	\$4,455
	42	84	36	172	89	LKT4284-36BTY	\$2,691	\$2,731	\$3,155	\$3,196
	36	96	36	175	89	LKT3696-36BTY	\$2,705	\$2,744	\$3,166	\$3,205
	36	84	36	153	78	LKT3684-36BTY	\$2,407	\$2,442	\$2,860	\$2,896

Features:

- price reflects complete table - top and base
- ships KD in multiple cartons
- one piece top
- model includes adjustable glide

Options:

- specify power/charging option, see below for options and upcharges

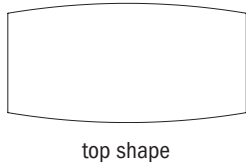
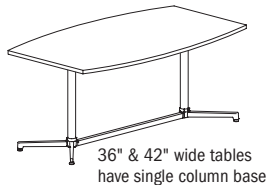

LOK - CONFERENCE

To Order Specify

1 Laminite Model #	2 Edge Detail	3 Laminite Selection	3a PVC Edge Color	4 Electrical	5 Metal Color
Laminite (LKT)	See Edge Detail Options	See Laminite Selection	See PVC Edge Color Options	N None CT2 Dual Power Center Top CU2 Dual Power Underside CT2U1 Dual Power Center Top with Underside (See chart on next page)	See Metal Finish Color Options

Model Number Breakdown

LKT4896-36BTY					
LK	T	4896	36	BT	Y
LOK	Laminite	48" x 96"	Height	Boat Top Shape	Y Base

Description

Boat Table with Y Base at Counter Height
(continued)

Veneer Tables
"LKV" Models

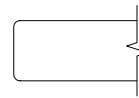

Eased Edge (R3)

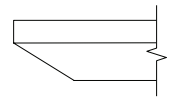

Reverse Bevel Edge (K9)

D	W	H	CTN WT	CU FT	① Model	Essentials		Artisan	
						Essentials	Artisan	Essentials	Artisan
48	96	36	225	115	LKV4896-36BTY	\$4,824	\$5,173	\$5,142	\$5,469
48	84	36	204	101	LKV4884-36BTY	\$4,377	\$4,676	\$4,673	\$4,954
42	96	36	194	102	LKV4296-36BTY	\$5,639	\$6,090	\$6,147	\$6,545
	84	36	172	89	LKV4284-36BTY	\$4,024	\$4,345	\$4,385	\$4,672
36	96	36	175	89	LKV3696-36BTY	\$3,627	\$3,918	\$3,952	\$4,210
36	84	36	153	78	LKV3684-36BTY	\$3,308	\$3,572	\$3,604	\$3,838

VENEER

Electrical Options and Upcharges

CT2	84 - 96 wide
Dual Power Center Top - Black	CT2BL - add \$1,535
Dual Power Center Top - White	CT2WH - add \$1,535
CU1	
Dual Power Underside - Black	CU1-1C - add \$610
Dual Power Underside with Wireless Charging - Black	CU1-1CW - add \$1,413
CT2U1	
Dual Power Center Top - Black with Underside	CT2U1-BL - add \$1,868
Dual Power Center Top - White with Underside	CT2U1-WH - add \$1,868
Dual Power Center Top - Black with Wireless Charging	CT2U1-BLW2 - add \$2,670
Dual Power Center Top - White with Wireless Charging	CT2U1-WHW2 - add \$2,670

Note: Order power infeed that best fits application

To Order Specify

① Veneer Model #	② Edge Detail	③ Wood Collection	④ Wood Finish	⑤ Electrical	⑥ Metal Color
Veneer (LKV)	See Edge Detail Options	Essentials	See Essentials Wood Finish Options	N None CT2 Dual Power Center Top CU2 Dual Power Underside CT2U1 Dual Power Center Top with Underside (See chart above)	See Metal Finish Color Options
		Artisan	④ Wood Finish See Artisan Wood Finish Options		

LOK - CONFERENCE

Description

Rounded Double Chevron Table with T Base at Counter Height

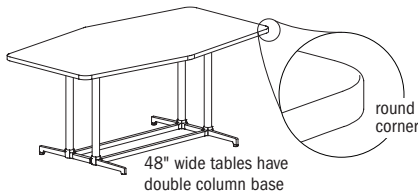

Laminate Tables "LKT" Models

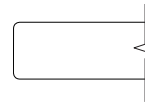

Eased Edge (R3)

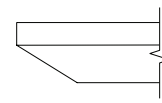

Reverse Bevel Edge (K9)

LAMINATE	D	W	H	CTN WT	CU FT	Model	Eased Edge (R3)		Reverse Bevel Edge (K9)	
							Standard Tier 1	Graded In Tier 2	Standard Tier 1	Graded In Tier 2
	48	96	36	211	115	LKT4896-36DCRT	\$3,470	\$3,523	\$3,957	\$4,009
48	84	36	189	101	LKT4884-36DCRT	\$3,155	\$3,202	\$3,630	\$3,678	
42	96	36	165	83	LKT4296-36DCRT	\$3,090	\$3,139	\$3,565	\$3,612	
42	84	36	146	90	LKT4284-36DCRT	\$2,574	\$2,615	\$3,038	\$3,078	
36	96	36	149	89	LKT3696-36DCRT	\$2,626	\$2,665	\$3,086	\$3,124	
36	84	36	142	78	LKT3684-36DCRT	\$2,372	\$2,406	\$2,823	\$2,858	

Features:

- price reflects complete table - top and base
- ships KD in multiple cartons
- one piece top
- model includes adjustable glide

Options:

- specify power/charging option, see below for options and upcharges

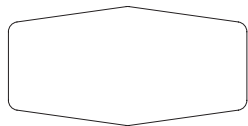
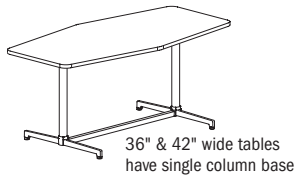

top shape

LOK - CONFERENCE

To Order Specify

1 Laminate Model #	2 Edge Detail	3 Laminate Selection	3a PVC Edge Color	4 Electrical	5 Metal Color
Laminate (LKT)	See Edge Detail Options	See Laminate Selection	See PVC Edge Color Options	N None CT2 Dual Power Center Top CU2 Dual Power Underside CT2U1 Dual Power Center Top with Underside (See chart on next page)	See Metal Finish Color Options

Model Number Breakdown

LKT4896-36DCRT						
LK	T	4896	36	DC	R	T
LOK	Laminate	48" x 96"	Height	Double Chevron Top Shape	Rounded Corner	T Base

Description

Rounded Double Chevron Table with T Base at Counter Height (continued)

Veneer Tables "LKV" Models Solid Surface Tables "LKS" Models

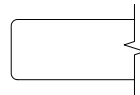

Eased Edge (R3)

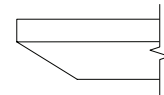

Reverse Bevel Edge (K9)

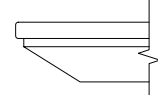

Reverse Bevel Edge (K7)

	D	W	H	CTN WT	CU FT	① Model	Veneer		Solid Surface		
							Essentials	Artisan	Essentials	Artisan	Standard
VENEER	48	96	36	211	115	LKV4896-36DCRT	\$4,805	\$5,156	\$5,125	\$5,446	--
	48	84	36	189	101	LKV4884-36DCRT	\$4,465	\$4,764	\$4,762	\$5,041	--
	42	96	36	165	83	LKV4296-36DCRT	\$4,585	\$4,953	\$4,997	\$5,324	--
	42	84	36	146	90	LKV4284-36DCRT	\$3,881	\$4,191	\$4,230	\$4,502	--
	36	96	36	149	89	LKV3696-36DCRT	\$3,529	\$3,814	\$3,849	\$4,097	--
	36	84	36	142	78	LKV3684-36DCRT	\$3,261	\$3,524	\$3,558	\$3,787	--
SOLID SURFACE	48	96	36	211	115	LKS4896-36DCRT	--	--	--	--	\$10,864
	48	84	36	189	101	LKS4884-36DCRT	--	--	--	--	\$9,721
	42	96	36	165	83	LKS4296-36DCRT	--	--	--	--	\$8,784
	42	84	36	146	90	LKS4284-36DCRT	--	--	--	--	\$7,764
	36	96	36	149	89	LKS3696-36DCRT	--	--	--	--	\$7,741
	36	84	36	142	78	LKS3684-36DCRT	--	--	--	--	\$6,994

Electrical Options and Upcharges

CT2	84 - 96 wide
Dual Power Center Top - Black	CT2BL - add \$1,535
Dual Power Center Top - White	CT2WH - add \$1,535
CU1	
Dual Power Underside - Black	CU1-1C - add \$610
Dual Power Underside with Wireless Charging - Black	CU1-1CW - add \$1,413
CT2U1	
Dual Power Center Top - Black with Underside	CT2U1-BL - add \$1,868
Dual Power Center Top - White with Underside	CT2U1-WH - add \$1,868
Dual Power Center Top - Black with Wireless Charging	CT2U1-BLW2 - add \$2,670
Dual Power Center Top - White with Wireless Charging	CT2U1-WHW2 - add \$2,670

Note: Order power infeed that best fits application

To Order Specify

① Veneer Model #	② Edge Detail	③ Wood Collection	④ Wood Finish	⑤ Electrical	⑥ Metal Color
Veneer (LKV)	See Edge Detail Options	Essentials	See Essentials Wood Finish Options	N None CT2 Dual Power Center Top CU2 Dual Power Underside CT2U1 Dual Power Center Top with Underside (See chart above)	See Metal Finish Color Options
		Artisan	④ Wood Finish See Artisan Wood Finish Options		

① Solid Surface Model #	② Top Surface Selection	③ Electrical	④ Metal Color
Solid Surface (LKS)	See Solid Surface Top Surface Selection Options	N None CT2 Dual Power Center Top CU2 Dual Power Underside CT2U1 Dual Power Center Top with Underside (See chart above)	See Metal Finish Color Options

LOK - CONFERENCE

Description

Rounded Double Chevron Table with Y Base at Counter Height

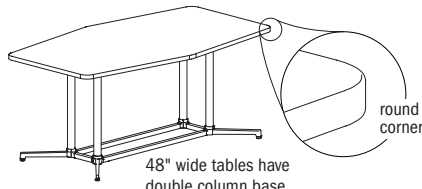

Laminate Tables "LKT" Models

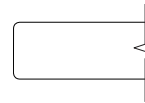

Eased Edge (R3)

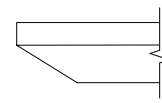

Reverse Bevel Edge (K9)

LAMINATE	D	W	H	CTN WT	CU FT	Model	Eased Edge (R3)		Reverse Bevel Edge (K9)	
							Standard Tier 1	Graded In Tier 2	Standard Tier 1	Graded In Tier 2
	48	96	36	206	115	LKT4896-36DCRY	\$3,485	\$3,536	\$3,970	\$4,024
48	84	36	188	101	LKT4884-36DCRY	\$3,085	\$3,132	\$3,561	\$3,607	
42	96	36	172	102	LKT4296-36DCRY	\$3,936	\$3,981	\$4,408	\$4,455	
42	84	36	156	89	LKT4284-36DCRY	\$2,691	\$2,731	\$3,155	\$3,196	
36	96	36	175	89	LKT3696-36DCRY	\$2,705	\$2,744	\$3,166	\$3,205	
36	84	36	144	78	LKT3684-36DCRY	\$2,407	\$2,442	\$2,860	\$2,896	

Features:

- price reflects complete table - top and base
- ships KD in multiple cartons
- one piece top
- model includes adjustable glide

Options:

- specify power/charging option, see below for options and upcharges

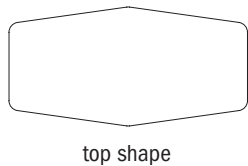
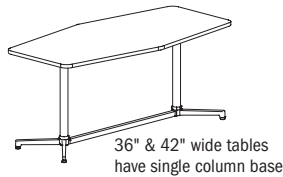

LOK - CONFERENCE

To Order Specify

1 Laminite Model #	2 Edge Detail	3 Laminite Selection	3a PVC Edge Color	4 Electrical	5 Metal Color
Laminite (LKT)	See Edge Detail Options	See Laminite Selection	See PVC Edge Color Options	N None CT2 Dual Power Center Top CU2 Dual Power Underside CT2U1 Dual Power Center Top with Underside (See chart on next page)	See Metal Finish Color Options

Model Number Breakdown

LKT4896-36DCRY						
LK	T	4896	36	DC	R	Y
LOK	Laminite	48" x 96"	Height	Double Chevron Top Shape	Rounded Corner	Y Base

Description

Rounded Double Chevron Table with Y Base at Counter Height (continued)

Veneer Tables "LKV" Models Solid Surface Tables "LKS" Models

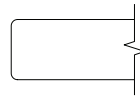

Eased Edge (R3)

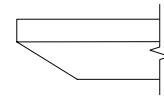

Reverse Bevel Edge (K9)

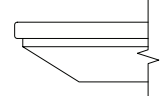

Reverse Bevel Edge (K7)

	D	W	H	CTN WT	CU FT	1 Model	Veneer Tables		Solid Surface Tables		
							Essentials	Artisan	Essentials	Artisan	Standard
VENEER	48	96	36	206	115	LKV4896-36DCRY	\$4,824	\$5,173	\$5,142	\$5,469	--
	48	84	36	188	101	LKV4884-36DCRY	\$4,377	\$4,676	\$4,673	\$4,954	--
	42	96	36	172	102	LKV4296-36DCRY	\$5,639	\$6,090	\$6,147	\$6,545	--
	42	84	36	156	89	LKV4284-36DCRY	\$4,024	\$4,345	\$4,385	\$4,672	--
	36	96	36	175	89	LKV3696-36DCRY	\$3,627	\$3,918	\$3,952	\$4,210	--
	36	84	36	144	78	LKV3684-36DCRY	\$3,308	\$3,572	\$3,604	\$3,838	--
SOLID SURFACE	48	96	36	206	115	LKS4896-36DCRY	--	--	--	--	\$10,881
	48	84	36	188	101	LKS4884-36DCRY	--	--	--	--	\$9,633
	42	96	36	172	102	LKS4296-36DCRY	--	--	--	--	\$9,840
	42	84	36	156	89	LKS4284-36DCRY	--	--	--	--	\$7,908
	36	96	36	175	89	LKS3696-36DCRY	--	--	--	--	\$7,839
	36	84	36	144	78	LKS3684-36DCRY	--	--	--	--	\$7,038

Electrical Options and Upcharges

CT2	84 - 96 wide
Dual Power Center Top - Black	CT2BL - add \$1,535
Dual Power Center Top - White	CT2WH - add \$1,535
CU1	
Dual Power Underside - Black	CU1-1C - add \$610
Dual Power Underside with Wireless Charging - Black	CU1-1CW - add \$1,413
CT2U1	
Dual Power Center Top - Black with Underside	CT2U1-BL - add \$1,868
Dual Power Center Top - White with Underside	CT2U1-WH - add \$1,868
Dual Power Center Top - Black with Wireless Charging	CT2U1-BLW2 - add \$2,670
Dual Power Center Top - White with Wireless Charging	CT2U1-WHW2 - add \$2,670

Note: Order power infeed that best fits application

To Order Specify

1 Veneer Model #	2 Edge Detail	3 Wood Collection	4 Wood Finish	5 Electrical	6 Metal Color
Veneer (LKV)	See Edge Detail Options	Essentials	See Essentials Wood Finish Options	N None CT2 Dual Power Center Top CU2 Dual Power Underside CT2U1 Dual Power Center Top with Underside (See chart above)	See Metal Finish Color Options
		Artisan	4 Wood Finish See Artisan Wood Finish Options		

1 Solid Surface Model #	2 Top Surface Selection	3 Electrical	4 Metal Color
Solid Surface (LKS)	See Solid Surface Top Surface Selection Options	N None CT2 Dual Power Center Top CU2 Dual Power Underside CT2U1 Dual Power Center Top with Underside (See chart above)	See Metal Finish Color Options

LOK - CONFERENCE

Description

Taper Table with T Base at Counter Height

Laminate Tables
"LKT" Models

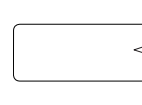
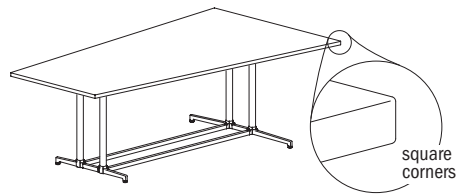

Eased Edge (R3)

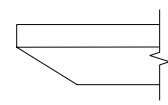

Reverse Bevel Edge (K9)

LAMI	D	W	H	CTN WT	CU FT	① Model	Standard Tier 1	Graded In Tier 2	Standard Tier 1	Graded In Tier 2
		54	96	36	222	127	LKT5496-36TPT	\$3,706	\$3,767	\$4,207

Features:

- price reflects complete table - top and base
- ships KD in multiple cartons
- one piece top
- model includes adjustable glide

Options:

- specify power/charging option, see below for options and upcharges

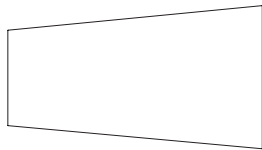

top shape

LOK - CONFERENCE

To Order Specify

① Laminate Model #	② Edge Detail	③ Laminate Selection	④ PVC Edge Color	⑤ Electrical	⑥ Metal Color
Laminate (LKT)	See Edge Detail Options	See Laminate Selection	See PVC Edge Color Options	N None CT2 Dual Power Center Top CU2 Dual Power Underside CT2U1 Dual Power Center Top with Underside (See chart on next page)	See Metal Finish Color Options

Model Number Breakdown

LKT5496-36TPT					
LK	T	5496	36	TP	T
LOK	Laminate	54" x 96"	Height	Taper Top Shape	T Base

Description

Taper Table with T Base at Counter Height (continued)

Veneer Tables "LKV" Models

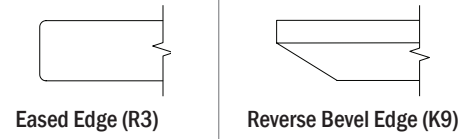

	D	W	H	CTN WT	CU FT	1 Model	Essentials	Artisan	Essentials	Artisan
VEN.	54	96	36	222	127	LKV5496-36TPT	\$5,066	\$5,471	\$5,521	\$5,881

Electrical Options and Upcharges

	84 - 96 wide
CT2	
Dual Power Center Top - Black	CT2BL - add \$1,535
Dual Power Center Top - White	CT2WH - add \$1,535
CU1	
Dual Power Underside - Black	CU1-1C - add \$610
Dual Power Underside with Wireless Charging - Black	CU1-1CW - add \$1,413
CT2U1	
Dual Power Center Top - Black with Underside	CT2U1-BL - add \$1,868
Dual Power Center Top - White with Underside	CT2U1-WH - add \$1,868
Dual Power Center Top - Black with Wireless Charging	CT2U1-BLW2 - add \$2,670
Dual Power Center Top - White with Wireless Charging	CT2U1-WHW2 - add \$2,670

Note: Order power infeed that best fits application

To Order Specify

1 Veneer Model #	2 Edge Detail	3 Wood Collection	4 Wood Finish	5 Electrical	6 Metal Color
Veneer (LKV)	See Edge Detail Options	Essentials	See Essentials Wood Finish Options	N None CT2 Dual Power Center Top CU2 Dual Power Underside CT2U1 Dual Power Center Top with Underside (See chart above)	See Metal Finish Color Options
		Artisan	4 Wood Finish See Artisan Wood Finish Options		

LOK - CONFERENCE

Description

Rounded Taper Table with T Base at Counter Height

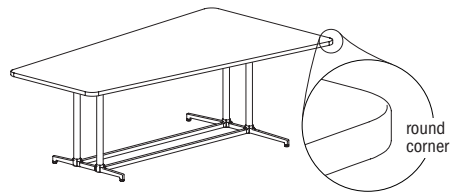

Laminate Tables "LKT" Models

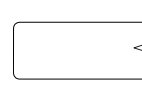

Eased Edge (R3)

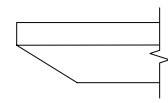

Reverse Bevel Edge (K9)

LAMI	D	W	H	CTN WT	CU FT	Model	Standard Tier 1	Graded In Tier 2	Standard Tier 1	Graded In Tier 2
		54	96	36	222	127	LKT5496-36TPRT	\$3,706	\$3,767	\$4,207

Features:

- price reflects complete table - top and base
- ships KD in multiple cartons
- one piece top
- model includes adjustable glide

Options:

- specify power/charging option, see below for options and upcharges

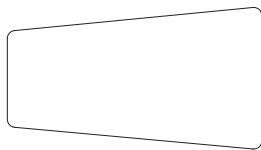

top shape

LOK - CONFERENCE

To Order Specify

1 Laminates Model #	2 Edge Detail	3 Laminates Selection	3a PVC Edge Color	4 Electrical	5 Metal Color
Laminates (LKT)	See Edge Detail Options	See Laminates Selection	See PVC Edge Color Options	N None CT2 Dual Power Center Top CU2 Dual Power Underside CT2U1 Dual Power Center Top with Underside (See chart on next page)	See Metal Finish Color Options

Model Number Breakdown

LKT5496-36TPRT						
LK	T	4896	36	TP	R	T
LOK	Laminates	48" x 96"	Height	Taper Top Shape	Rounded Corner	T Base

Description

Rounded Taper Table with T Base at Counter Height (continued)

Veneer Tables "LKV" Models Solid Surface Tables "LKS" Models

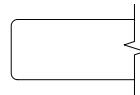

Eased Edge (R3)

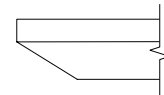

Reverse Bevel Edge (K9)

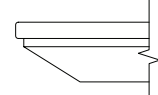

Reverse Bevel Edge (K7)

	D	W	H	CTN WT	CU FT	Model	Essentials	Artisan	Essentials	Artisan	Standard
VEN.	54	96	36	222	127	LKV5496-36TPRT	\$5,066	\$5,471	\$5,521	\$5,881	--
S.S.	54	96	36	222	127	LKS5496-36TPRT	--	--	--	--	\$14,116

Electrical Options and Upcharges

CT2	84 - 96 wide
Dual Power Center Top - Black	CT2BL - add \$1,535
Dual Power Center Top - White	CT2WH - add \$1,535
CU1	
Dual Power Underside - Black	CU1-1C - add \$610
Dual Power Underside with Wireless Charging - Black	CU1-1CW - add \$1,413
CT2U1	
Dual Power Center Top - Black with Underside	CT2U1-BL - add \$1,868
Dual Power Center Top - White with Underside	CT2U1-WH - add \$1,868
Dual Power Center Top - Black with Wireless Charging	CT2U1-BLW2 - add \$2,670
Dual Power Center Top - White with Wireless Charging	CT2U1-WHW2 - add \$2,670

Note: Order power infeed that best fits application

To Order Specify

1 Veneer Model #	2 Edge Detail	3 Wood Collection	4 Wood Finish	5 Electrical	6 Metal Color
Veneer (LKV)	See Edge Detail Options	Essentials	See Essentials Wood Finish Options	N None CT2 Dual Power Center Top CU2 Dual Power Underside CT2U1 Dual Power Center Top with Underside (See chart above)	See Metal Finish Color Options
		Artisan	4 Wood Finish See Artisan Wood Finish Options		

1 Solid Surface Model #	2 Top Surface Selection	3 Electrical	4 Metal Color
Solid Surface (LKS)	See Solid Surface Top Surface Selection Options	N None CT2 Dual Power Center Top CU2 Dual Power Underside CT2U1 Dual Power Center Top with Underside (See chart above)	See Metal Finish Color Options

LOK - CONFERENCE

Description

Taper Table with Y Base at Counter Height

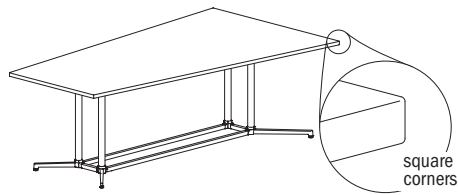

Laminate Tables "LKT" Models

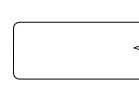

Eased Edge (R3)

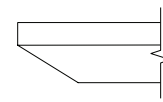

Reverse Bevel Edge (K9)

LAMI	D	W	H	CTN WT	CU FT	Model	Standard Tier 1	Graded In Tier 2	Standard Tier 1	Graded In Tier 2
		54	96	36	198	127	LKT5496-36TPY	\$3,508	\$3,567	\$4,007

Features:

- price reflects complete table - top and base
- ships KD in multiple cartons
- one piece top
- model includes adjustable glide

Options:

- specify power/charging option, see below for options and upcharges

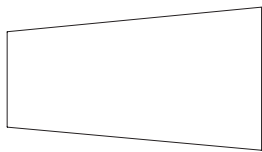

top shape

LOK - CONFERENCE

To Order Specify

1 Laminate Model #	2 Edge Detail	3 Laminate Selection	3a PVC Edge Color	4 Electrical	5 Metal Color
Laminate (LKT)	See Edge Detail Options	See Laminate Selection	See PVC Edge Color Options	N None CT2 Dual Power Center Top CU2 Dual Power Underside CT2U1 Dual Power Center Top with Underside (See chart on next page)	See Metal Finish Color Options

Model Number Breakdown

LKT4896-36TPY					
LK	T	4896	36	TP	Y
LOK	Laminate	48" x 96"	Height	Taper Top Shape	Y Base

Description

Taper Table with Y Base at Counter Height
(continued)

Veneer Tables "LKV" Models

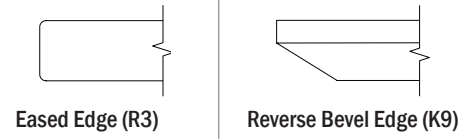

	D	W	H	CTN WT	CU FT	① Model	Essentials	Artisan	Essentials	Artisan
VEN.	54	96	36	198	127	LKV5496-36TPY	\$4,823	\$5,207	\$5,258	\$5,599

Electrical Options and Upcharges

	84 - 96 wide
CT2	
Dual Power Center Top - Black	CT2BL - add \$1,535
Dual Power Center Top - White	CT2WH - add \$1,535
CU1	
Dual Power Underside - Black	CU1-1C - add \$610
Dual Power Underside with Wireless Charging - Black	CU1-1CW - add \$1,413
CT2U1	
Dual Power Center Top - Black with Underside	CT2U1-BL - add \$1,868
Dual Power Center Top - White with Underside	CT2U1-WH - add \$1,868
Dual Power Center Top - Black with Wireless Charging	CT2U1-BLW2 - add \$2,670
Dual Power Center Top - White with Wireless Charging	CT2U1-WHW2 - add \$2,670

Note: Order power infeed that best fits application

To Order Specify

① Veneer Model #	② Edge Detail	③ Wood Collection	④ Wood Finish	⑤ Electrical	⑥ Metal Color
Veneer (LKV)	See Edge Detail Options	Essentials	See Essentials Wood Finish Options	N None CT2 Dual Power Center Top CU2 Dual Power Underside CT2U1 Dual Power Center Top with Underside (See chart above)	See Metal Finish Color Options
		Artisan	④ Wood Finish See Artisan Wood Finish Options		

LOK- CONFERENCE

Description

Rounded Taper Table with Y Base at Counter Height

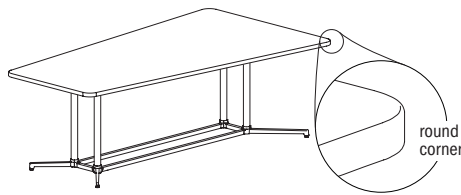

Laminate Tables "LKT" Models

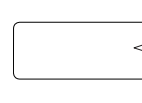

Eased Edge (R3)

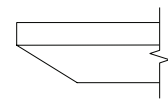

Reverse Bevel Edge (K9)

LAMI	D	W	H	CTN WT	CU FT	Model	Standard Tier 1	Graded In Tier 2	Standard Tier 1	Graded In Tier 2
		54	96	36	198	127	LKT5496-36TPRY	\$3,508	\$3,567	\$4,007

Features:

- price reflects complete table - top and base
- ships KD in multiple cartons
- one piece top
- model includes adjustable glide

Options:

- specify power/charging option, see below for options and upcharges

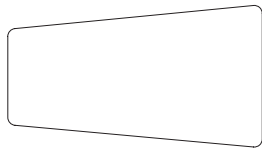

top shape

LOK - CONFERENCE

To Order Specify

1 Laminate Model #	2 Edge Detail	3 Laminate Selection	3a PVC Edge Color	4 Electrical	5 Metal Color
Laminate (LKT)	See Edge Detail Options	See Laminate Selection	See PVC Edge Color Options	N None CT2 Dual Power Center Top CU2 Dual Power Underside CT2U1 Dual Power Center Top with Underside (See chart on next page)	See Metal Finish Color Options

Model Number Breakdown

LKT5496-36TPRY						
LK	T	4896	36	TP	R	Y
LOK	Laminate	48" x 96"	Height	Taper Top Shape	Rounded Corner	Y Base

Description

Rounded Taper Table with Y Base at Counter Height (continued)

Veneer Tables "LKV" Models Solid Surface Tables "LKS" Models

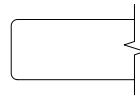

Eased Edge (R3)

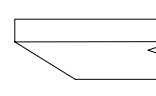

Reverse Bevel Edge (K9)

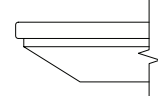

Reverse Bevel Edge (K7)

	D	W	H	CTN WT	CU FT	① Model	Essentials	Artisan	Essentials	Artisan	Standard
VEN.	54	96	36	198	127	LKV5496-36TPRY	\$4,823	\$5,207	\$5,258	\$5,599	--
S.S.	54	96	36	198	127	LKS5496-36TPRY	--	--	--	--	\$13,872

Electrical Options and Upcharges

CT2	84 - 96 wide
Dual Power Center Top - Black	CT2BL - add \$1,535
Dual Power Center Top - White	CT2WH - add \$1,535
CU1	
Dual Power Underside - Black	CU1-1C - add \$610
Dual Power Underside with Wireless Charging - Black	CU1-1CW - add \$1,413
CT2U1	
Dual Power Center Top - Black with Underside	CT2U1-BL - add \$1,868
Dual Power Center Top - White with Underside	CT2U1-WH - add \$1,868
Dual Power Center Top - Black with Wireless Charging	CT2U1-BLW2 - add \$2,670
Dual Power Center Top - White with Wireless Charging	CT2U1-WHW2 - add \$2,670

Note: Order power infeed that best fits application

To Order Specify

① Veneer Model #	② Edge Detail	③ Wood Collection	④ Wood Finish	⑤ Electrical	⑥ Metal Color
Veneer (LKV)	See Edge Detail Options	Essentials	See Essentials Wood Finish Options	N None CT2 Dual Power Center Top CU2 Dual Power Underside CT2U1 Dual Power Center Top with Underside (See chart above)	See Metal Finish Color Options
		Artisan	④ Wood Finish See Artisan Wood Finish Options		

① Solid Surface Model #	② Top Surface Selection	③ Electrical	④ Metal Color
Solid Surface (LKS)	See Solid Surface Top Surface Selection Options	N None CT2 Dual Power Center Top CU2 Dual Power Underside CT2U1 Dual Power Center Top with Underside (See chart above)	See Metal Finish Color Options

LOK - CONFERENCE

Description

Round Table with X Base at Counter Height



Laminate Tables "LKT" Models

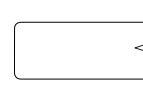

Eased Edge (R3)

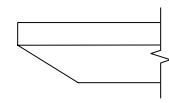

Reverse Bevel Edge (K9)

LAMINATE	D	W	H	CTN WT	CU FT	1 Model	Eased Edge (R3)		Reverse Bevel Edge (K9)	
							Standard Tier 1	Graded In Tier 2	Standard Tier 1	Graded In Tier 2
	48	48	36	88	37	LKT48-36RDX	\$1,734	\$1,858	\$2,204	\$2,325
42	42	36	74	35	LKT42-36RDX	\$1,595	\$1,716	\$2,064	\$2,184	
36	36	36	60	33	LKT36-36RDX	\$1,544	\$1,591	\$2,015	\$2,060	
30	30	36	48	30	LKT30-36RDX	\$1,493	\$1,529	\$1,963	\$1,999	

Features:

- price reflects complete table - top and base
- ships KD in multiple cartons
- one piece top
- model includes adjustable glide
- when electrical option is selected, power accessible base is shipped; see page 178 for details
- power/charging units have 72" cord
- power cord is routed inside base column

Options:

- specify power access base with power unit option; None (N), add \$663 for EC23 (CTEC23), add \$549 for EC24 (CTEC24)

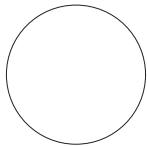

top shape

LOK - CONFERENCE

To Order Specify

1 Laminate Model #	2 Edge Detail	3 Laminate Selection	3a PVC Edge Color	4 Electrical	5 Metal Color
Laminate (LKT)	See Edge Detail Options	See Laminate Selection	See PVC Edge Color Options	N None CTEC23 Power Center Top CTEC24 Power Center Top (See chart on next page)	See Metal Finish Color Options

Model Number Breakdown

LKT48-36RDX					
LK	T	48	36	RD	X
LOK	Laminate	48" dia.	Height	Round Top Shape	X Base

Description

Round Table with X Base
at Counter Height
(continued)

Veneer Tables
"LKV" Models

Solid Surface Tables
"LKS" Models

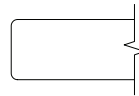

Eased Edge (R3)

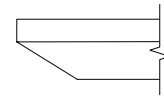

Reverse Bevel Edge (K9)

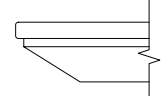

Reverse Bevel Edge (K7)

	D	W	H	CTN WT	CU FT	① Model	Veneer Tables "LKV" Models		Solid Surface Tables "LKS" Models		
							Essentials	Artisan	Essentials	Artisan	Standard
VENEER	48	48	36	88	37	LKV48-36RDX	\$2,284	\$2,435	\$2,373	\$2,528	--
	42	42	36	74	35	LKV42-36RDX	\$2,096	\$2,235	\$2,176	\$2,319	--
	36	36	36	60	33	LKV36-36RDX	\$2,032	\$2,168	\$2,110	\$2,250	--
	30	30	36	48	30	LKV30-36RDX	\$1,962	\$2,091	\$2,038	\$2,171	--
SOLID SURFACE	48	48	36	118	37	LKS48-36RDX	--	--	--	--	\$5,312
	42	42	36	95	35	LKS42-36RDX	--	--	--	--	\$4,531
	36	36	36	76	33	LKS36-36RDX	--	--	--	--	\$3,950
	30	30	36	59	30	LKS30-36RDX	--	--	--	--	\$3,442

Electrical Options and Upcharges

CTEC23	
EC23 Power Center Top - Black	CTEC23BL - add \$663
EC23 Power Center Top - White	CTEC23WH - add \$663
CTEC24	
EC24 Power Center Top - Black	CTEC43BL - add \$549
EC24 Power Center Top - White	CTEC43WH - add \$549

To Order Specify

① Veneer Model #	② Edge Detail	③ Wood Collection	④ Wood Finish	⑤ Electrical	⑥ Metal Color
Veneer (LKV)	See Edge Detail Options	Essentials	See Essentials Wood Finish Options	N None CTEC23 Power Center Top CTEC24 Power Center Top (See chart above)	See Metal Finish Color Options
		Artisan	④ Wood Finish See Artisan Wood Finish Options		

① Solid Surface Model #	② Top Surface Selection	③ Electrical Cut Out	④ Metal Color
Solid Surface (LKS)	See Solid Surface Top Surface Selection Options	N None CTEC23 Power Center Top CTEC24 Power Center Top (See chart above)	See Metal Finish Color Options

LOK - CONFERENCE

Description

Round Table with X4 Base at Counter Height



Laminate Tables "LKT" Models

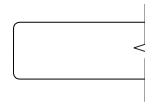

Eased Edge (R3)

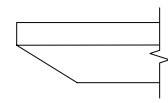

Reverse Bevel Edge (K9)

LAMINATE	D	W	H	CTN WT	CU FT	1 Model	Eased Edge (R3)		Reverse Bevel Edge (K9)	
							Standard	Graded In	Standard	Graded In
							Tier 1	Tier 2	Tier 1	Tier 2
	60	60	36	157	66	LKT60-36RDZ	\$2,890	\$2,986	\$3,359	\$3,456
	54	54	36	215	63	LKT54-36RDZ	\$2,700	\$2,774	\$3,168	\$3,243

Features:

- price reflects complete table - top and base
- ships KD in multiple cartons
- one piece top
- model includes adjustable glide
- power cord is routed outside base column
- order vertical wire manager separately; see page 407

Options:

- specify power unit option; None (N), add \$663 for EC23 (CTEC23), add \$549 for EC24 (CTEC24)

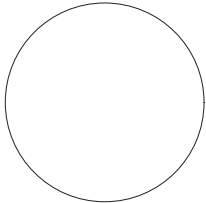

top shape

LOK - CONFERENCE

To Order Specify

1 Laminate Model #	2 Edge Detail	3 Laminate Selection	3a PVC Edge Color	4 Electrical	5 Metal Color
Laminate (LKT)	See Edge Detail Options	See Laminate Selection	See PVC Edge Color Options	N None CTEC23 Power Center Top CTEC24 Power Center Top (See chart on next page)	See Metal Finish Color Options

Model Number Breakdown

LKT60-36RDZ					
LK	T	60	36	RD	Z
LOK	Laminate	60" dia.	Height	Round Top Shape	X4 Base

Description

Round Table with X4 Base
at Counter Height
(continued)

Veneer Tables "LKV" Models	Solid Surface Tables "LKS" Models
-------------------------------	--------------------------------------

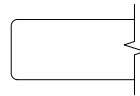

Eased Edge (R3)

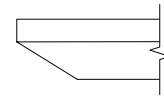

Reverse Bevel Edge (K9)

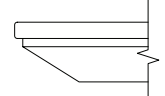

Reverse Bevel Edge (K7)

	D	W	H	CTN WT	CU FT	① Model	Veneer Tables "LKV" Models		Solid Surface Tables "LKS" Models		
							Essentials	Artisan	Essentials	Artisan	Standard
VENEER	60	60	36	215	66	LKV60-36RDZ	\$3,787	\$4,035	\$3,926	\$4,186	--
	54	54	36	186	63	LKV54-36RDZ	\$3,576	\$3,819	\$3,715	\$3,968	--
SOL SURF	60	60	36	157	66	LKS60-36RDZ	--	--	--	--	\$8,244
	54	54	36	186	63	LKS54-36RDZ	--	--	--	--	\$7,282

Electrical Options and Upcharges

CTEC23	
EC23 Power Center Top - Black	CTEC23BL - add \$663
EC23 Power Center Top - White	CTEC23WH - add \$663
CTEC24	
EC24 Power Center Top - Black	CTEC43BL - add \$549
EC24 Power Center Top - White	CTEC43WH - add \$549

To Order Specify

① Veneer Model #	② Edge Detail	③ Wood Collection	④ Wood Finish	⑤ Electrical	⑥ Metal Color
Veneer (LKV)	See Edge Detail Options	Essentials	See Essentials Wood Finish Options	N None CTEC23 Power Center Top CTEC24 Power Center Top (See chart above)	See Metal Finish Color Options
		Artisan	④ Wood Finish See Artisan Wood Finish Options		

① Solid Surface Model #	② Top Surface Selection	③ Electrical Cut Out	④ Metal Color
Solid Surface (LKS)	See Solid Surface Top Surface Selection Options	N None CTEC23 Power Center Top CTEC24 Power Center Top (See chart above)	See Metal Finish Color Options

LOK-CONFERENCE

Description

Square Table with X Base at Counter Height

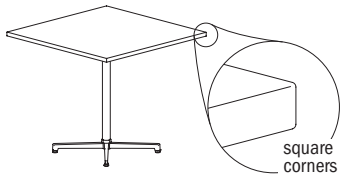

Laminate Tables "LKT" Models

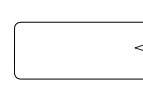

Eased Edge (R3)

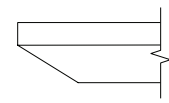

Reverse Bevel Edge (K9)

LAMINATE	D	W	H	CTN WT	CU FT	Model	Standard Tier 1	Graded In Tier 2	Standard Tier 1	Graded In Tier 2
		42	42	36	93	35	LKT4242-36SQX	\$1,632	\$1,686	\$2,103
	36	36	36	81	33	LKT3636-36SQX	\$1,452	\$1,495	\$1,921	\$1,965
	30	30	36	62	30	LKT3030-36SQX	\$1,308	\$1,342	\$1,773	\$1,810

Features:

- price reflects complete table - top and base
- ships KD in multiple cartons
- one piece top
- model includes adjustable glide
- when electrical option is selected, power accessible base is shipped; see page 178 for details
- power/charging units have 72" cord
- power cord is routed inside base column

Options:

- specify power access base with power unit option; None (N), add \$663 for EC23 (CTEC23), add \$549 for EC24 (CTEC24)

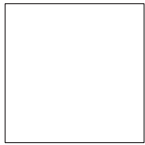

top shape

LOK - CONFERENCE

To Order Specify

1 Laminate Model #	2 Edge Detail	3 Laminate Selection	3a PVC Edge Color	4 Electrical	5 Metal Color
Laminate (LKT)	See Edge Detail Options	See Laminate Selection	See PVC Edge Color Options	N None CTEC23 Power Center Top CTEC24 Power Center Top (See chart on next page)	See Metal Finish Color Options

Model Number Breakdown

LKT4242-36SQX					
LK	T	4242	36	SQ	X
LOK	Laminate	42" x 42"	Height	Square Top Shape	X Base

Description

Square Table with X Base
at Counter Height
(continued)

Veneer Tables
"LKV" Models

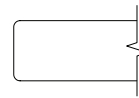

Eased Edge (R3)

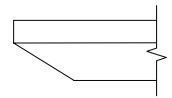

Reverse Bevel Edge (K9)

D	W	H	CTN WT	CU FT	① Model	Essentials		Artisan	
						Essentials	Artisan	Essentials	Artisan
42	42	36	93	35	LKV4242-36SQX	\$2,118	\$2,258	\$2,200	\$2,346
36	36	36	81	33	LKV3636-36SQX	\$1,880	\$2,004	\$1,951	\$2,080
30	30	36	62	30	LKV3030-36SQX	\$1,688	\$1,799	\$1,751	\$1,867

VENEER

LOK- CONFERENCE

Electrical Options and Upcharges

CTEC23	
EC23 Power Center Top - Black	CTEC23BL - add \$663
EC23 Power Center Top - White	CTEC23WH - add \$663
CTEC24	
EC24 Power Center Top - Black	CTEC43BL - add \$549
EC24 Power Center Top - White	CTEC43WH - add \$549

To Order Specify

① Veneer Model #	② Edge Detail	③ Wood Collection	④ Wood Finish	⑤ Electrical	⑥ Metal Color
Veneer (LKV)	See Edge Detail Options	Essentials	See Essentials Wood Finish Options	N None CTEC23 Power Center Top CTEC24 Power Center Top (See chart above)	See Metal Finish Color Options
		Artisan	④ Wood Finish See Artisan Wood Finish Options		

Description

Rounded Square Table with X Base at Counter Height

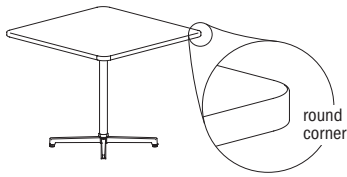

Laminate Tables
"LKT" Models

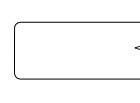

Eased Edge (R3)

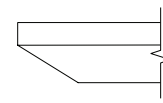

Reverse Bevel Edge (K9)

LAMINATE	D	W	H	CTN WT	CU FT	Model	Standard Tier 1	Graded In Tier 2	Standard Tier 1	Graded In Tier 2
	42	42	36	93	35	LKT4242-36SQRX	\$2,001	\$2,055	\$2,467	\$2,524
	36	36	36	81	33	LKT3636-36SQRX	\$1,555	\$1,598	\$2,023	\$2,068
	30	30	36	62	30	LKT3030-36SQRX	\$1,446	\$1,474	\$1,914	\$1,952

Features:

- price reflects complete table - top and base
- ships KD in multiple cartons
- one piece top
- model includes adjustable glide
- when electrical option is selected, power accessible base is shipped; see page 178 for details
- power/charging units have 72" cord
- power cord is routed inside base column

Options:

- specify power access base with power unit option; None (N), add \$663 for EC23 (CTEC23), add \$549 for EC24 (CTEC24)

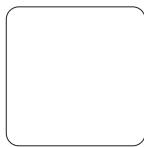

top shape

LOK - CONFERENCE

To Order Specify

1 Laminate Model #	2 Edge Detail	3 Laminate Selection	3a PVC Edge Color	4 Electrical	5 Metal Color
Laminate (LKT)	See Edge Detail Options	See Laminate Selection	See PVC Edge Color Options	N None CTEC23 Power Center Top CTEC24 Power Center Top (See chart on next page)	See Metal Finish Color Options

Model Number Breakdown

LKT4242-36SQRX						
LK	T	4242	36	SQ	R	X
LOK	Laminate	42" x 42"	Height	Square Top Shape	Rounded Corner	X Base

Description

Rounded Square Table with X Base at Counter Height (continued)

Veneer Tables "LKV" Models Solid Surface Tables "LKS" Models

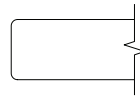

Eased Edge (R3)

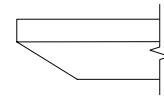

Reverse Bevel Edge (K9)

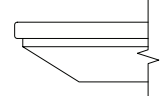

Reverse Bevel Edge (K7)

	D	W	H	CTN WT	CU FT	① Model	Veneer Tables		Solid Surface Tables		
							Essentials	Artisan	Essentials	Artisan	Standard
VENEER	42	42	36	93	35	LKV4242-36SQRX	\$2,613	\$2,787	\$2,711	\$2,896	--
	36	36	36	81	33	LKV3636-36SQRX	\$2,168	\$2,311	\$2,249	\$2,398	--
	30	30	36	62	30	LKV3030-36SQRX	\$1,938	\$2,067	\$2,013	\$2,146	--
SOLID SURFACE	42	42	36	93	35	LKS4242-36SQRX	--	--	--	--	\$5,161
	36	36	36	81	33	LKS3636-36SQRX	--	--	--	--	\$4,087
	30	30	36	62	30	LKS3030-36SQRX	--	--	--	--	\$3,419

Electrical Options and Upcharges

CTEC23	
EC23 Power Center Top - Black	CTEC23BL - add \$663
EC23 Power Center Top - White	CTEC23WH - add \$663
CTEC24	
EC24 Power Center Top - Black	CTEC24BL - add \$549
EC24 Power Center Top - White	CTEC24WH - add \$549

To Order Specify

① Veneer Model #	② Edge Detail	③ Wood Collection	④ Wood Finish	⑤ Electrical	⑥ Metal Color
Veneer (LKV)	See Edge Detail Options	Essentials	See Essentials Wood Finish Options	N None CTEC23 Power Center Top CTEC24 Power Center Top (See chart above)	See Metal Finish Color Options
		Artisan	See Artisan Wood Finish Options		

① Solid Surface Model #	② Top Surface Selection	③ Electrical Cut Out	④ Metal Color
Solid Surface (LKS)	See Solid Surface Top Surface Selection Options	N None CTEC23 Power Center Top CTEC24 Power Center Top (See chart above)	See Metal Finish Color Options

Description

Square Table with X4 Base at Counter Height

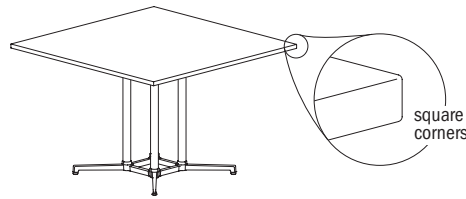

Laminate Tables "LKT" Models

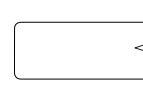

Eased Edge (R3)

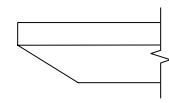

Reverse Bevel Edge (K9)

LAMINATE	D	W	H	CTN WT	CU FT	Model	Eased Edge (R3)		Reverse Bevel Edge (K9)	
							Standard Tier 1	Graded In Tier 2	Standard Tier 1	Graded In Tier 2
	60	60	36	181	66	LKT6060-36SQZ	\$3,281	\$3,376	\$3,750	\$3,847
54	54	36	157	63	LKT5454-36SQZ	\$3,124	\$3,208	\$3,594	\$3,678	
48	48	36	108	60	LKT4848-36SQZ	\$2,600	\$2,657	\$3,069	\$3,126	

Features:

- price reflects complete table - top and base
- ships KD in multiple cartons
- one piece top
- model includes adjustable glide
- power cord is routed outside base column
- order vertical wire manager separately; see page 407

Options:

- specify power unit option; None (N), add \$663 for EC23 (CTEC23), add \$549 for EC24 (CTEC24)

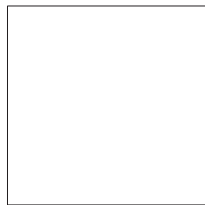

top shape

LOK - CONFERENCE

To Order Specify

1 Laminates Model #	2 Edge Detail	3 Laminates Selection	3a PVC Edge Color	4 Electrical	5 Metal Color
Laminates (LKT)	See Edge Detail Options	See Laminates Selection	See PVC Edge Color Options	N None CTEC23 Power Center Top CTEC24 Power Center Top (See chart on next page)	See Metal Finish Color Options

Model Number Breakdown

LKT6060-36SQZ					
LK	T	6060	36	SQ	Z
LOK	Laminates	60" x 60"	Height	Square Top Shape	X4 Base

Description

Square Table with X4 Base
at Counter Height
(continued)

Veneer Tables
"LKV" Models

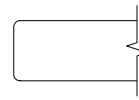

Eased Edge (R3)

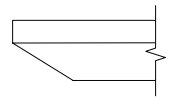

Reverse Bevel Edge (K9)

VENEER	D	W	H	CTN WT	CU FT	① Model	Essentials	Artisan	Essentials	Artisan
	60	60	36	181	66	LKV6060-36SQZ	\$4,250	\$4,530	\$4,409	\$4,701
	54	54	36	157	63	LKV5454-36SQZ	\$4,045	\$4,312	\$4,195	\$4,473
	48	48	36	108	60	LKV4848-36SQZ	\$3,129	\$3,282	\$3,218	\$3,378

LOK - CONFERENCE

Electrical Options and Upcharges

CTEC23	
EC23 Power Center Top - Black	CTEC23BL - add \$663
EC23 Power Center Top - White	CTEC23WH - add \$663
CTEC24	
EC24 Power Center Top - Black	CTEC43BL - add \$549
EC24 Power Center Top - White	CTEC43WH - add \$549

To Order Specify

① Veneer Model #	② Edge Detail	③ Wood Collection	④ Wood Finish	⑤ Electrical	⑥ Metal Color
Veneer (LKV)	See Edge Detail Options	Essentials	See Essentials Wood Finish Options	N None CTEC23 Power Center Top CTEC24 Power Center Top (See chart above)	See Metal Finish Color Options
		Artisan	④ Wood Finish See Artisan Wood Finish Options		

Description

Rounded Square Table with X4 Base at Counter Height

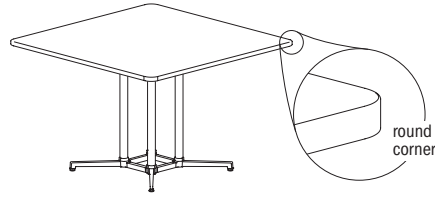

Laminate Tables
"LKT" Models

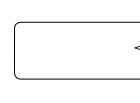

Eased Edge (R3)

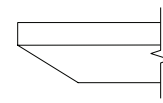

Reverse Bevel Edge (K9)

LAMINATE	D	W	H	CTN WT	CU FT	1 Model	Eased Edge (R3)		Reverse Bevel Edge (K9)	
							Standard Tier 1	Graded In Tier 2	Standard Tier 1	Graded In Tier 2
	60	60	36	181	66	LKT6060-36SQRZ	\$3,484	\$3,536	\$4,095	\$4,150
	54	54	36	157	63	LKT5454-36SQRZ	\$2,924	\$3,008	\$3,391	\$3,476
	48	48	36	181	60	LKT4848-36SQRZ	\$2,979	\$3,039	\$3,450	\$3,508

Features:

- price reflects complete table - top and base
- ships KD in multiple cartons
- one piece top
- model includes adjustable glide
- power cord is routed outside base column
- order vertical wire manager separately; see page 407

Options:

- specify power unit option; None (N), add \$663 for EC23 (CTEC23), add \$549 for EC24 (CTEC24)

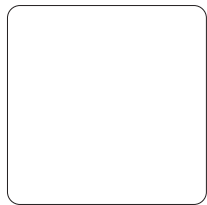

top shape

LOK - CONFERENCE

To Order Specify

1 Laminate Model #	2 Edge Detail	3 Laminate Selection	3a PVC Edge Color	4 Electrical	5 Metal Color
Laminate (LKT)	See Edge Detail Options	See Laminate Selection	See PVC Edge Color Options	N None CTEC23 Power Center Top CTEC24 Power Center Top (See chart on next page)	See Metal Finish Color Options

Model Number Breakdown

LKT6060-36SQRX						
LK	T	6060	36	SQ	R	Z
LOK	Laminate	60" x 60"	Height	Square Top Shape	Rounded Corner	X Base

Description

Rounded Square Table with X4 Base at Counter Height (continued)

		Veneer Tables "LKV" Models				Solid Surface Tables "LKS" Models					
		Eased Edge (R3)		Reverse Bevel Edge (K9)		Reverse Bevel Edge (K7)					
		Essentials	Artisan	Essentials	Artisan	Standard					
	D	W	H	CTN WT	CU FT	① Model	Essentials	Artisan	Essentials	Artisan	Standard
VENEER	60	60	36	181	66	LKV6060-36SQRZ	\$4,569	\$4,871	\$4,742	\$5,056	--
	54	54	36	157	63	LKV5454-36SQRZ	\$3,776	\$4,023	\$3,918	\$4,176	--
	48	48	36	142	60	LKV4848-36SQRZ	\$3,631	\$3,820	\$3,740	\$3,937	--
SOLID SURFACE	60	60	36	215	66	LKS6060-36SQRZ	--	--	--	--	\$9,023
	54	54	36	186	63	LKS5454-36SQRZ	--	--	--	--	\$7,480
	48	48	36	181	60	LKS4848-36SQRZ	--	--	--	--	\$5,949

Electrical Options and Upcharges

CTEC23	
EC23 Power Center Top - Black	CTEC23BL - add \$663
EC23 Power Center Top - White	CTEC23WH - add \$663
CTEC24	
EC24 Power Center Top - Black	CTEC43BL - add \$549
EC24 Power Center Top - White	CTEC43WH - add \$549

To Order Specify

① Veneer Model #	② Edge Detail	③ Wood Collection	④ Wood Finish	⑤ Electrical	⑥ Metal Color
Veneer (LKV)	See Edge Detail Options	Essentials	See Essentials Wood Finish Options	N None CTEC23 Power Center Top CTEC24 Power Center Top (See chart above)	See Metal Finish Color Options
		Artisan	④ Wood Finish See Artisan Wood Finish Options		

① Solid Surface Model #	② Top Surface Selection	③ Electrical Cut Out	④ Metal Color
Solid Surface (LKS)	See Solid Surface Top Surface Selection Options	N None CTEC23 Power Center Top CTEC24 Power Center Top (See chart above)	See Metal Finish Color Options

LOK-CONFERENCE

Description

Squircle Table with X Base at Counter Height



Laminate Tables "LKT" Models

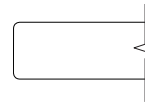

Eased Edge (R3)

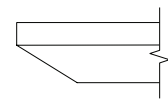

Reverse Bevel Edge (K9)

LAMINATE	D	W	H	CTN WT	CU FT	Model	Eased Edge (R3)		Reverse Bevel Edge (K9)	
							Standard Tier 1	Graded In Tier 2	Standard Tier 1	Graded In Tier 2
	42	42	36	93	35	LKT42-36SCX	\$1,617	\$1,736	\$2,085	\$2,207
36	36	36	81	33	LKT36-36SCX	\$1,565	\$1,610	\$2,038	\$2,082	
30	30	36	62	30	LKT30-36SCX	\$1,513	\$1,550	\$1,981	\$1,903	

Features:

- price reflects complete table - top and base
- ships KD in multiple cartons
- one piece top
- model includes adjustable glide
- when electrical option is selected, power accessible base is shipped; see page 178 for details
- power/charging units have 72" cord
- power cord is routed inside base column

Options:

- specify power access base with power unit option; None (N), add \$663 for EC23 (CTEC23), add \$549 for EC24 (CTEC24)

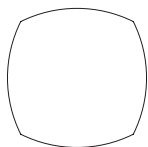

top shape

LOK - CONFERENCE

To Order Specify

1 Laminates Model #	2 Edge Detail	3 Laminates Selection	3a PVC Edge Color	4 Electrical	5 Metal Color
Laminates (LKT)	See Edge Detail Options	See Laminates Selection	See PVC Edge Color Options	N None CTEC23 Power Center Top CTEC24 Power Center Top (See chart on next page)	See Metal Finish Color Options

Model Number Breakdown

LKT42-36SCX					
LK	T	42	36	SC	X
LOK	Laminates	42" dia.	Height	Squircle Top Shape	X Base

Description

Squirrel Table with X Base at Counter Height (continued)

Veneer Tables "LKV" Models Solid Surface Tables "LKS" Models

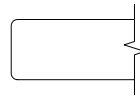

Eased Edge (R3)

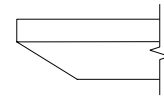

Reverse Bevel Edge (K9)

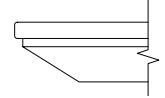

Reverse Bevel Edge (K7)

	D	W	H	CTN WT	CU FT	① Model	Veneer Tables		Solid Surface Tables		
							Essentials	Artisan	Essentials	Artisan	Standard
VENEER	42	42	36	93	35	LKV42-36SCX	\$2,118	\$2,257	\$2,200	\$2,345	--
	36	36	36	81	33	LKV36-36SCX	\$2,053	\$2,186	\$2,133	\$2,272	--
	30	30	36	62	30	LKV30-36SCX	\$1,979	\$2,110	\$2,057	\$2,191	--
SOLID SURFACE	42	42	36	93	35	LKS42-36SCX	--	--	--	--	\$4,571
	36	36	36	81	33	LKS36-36SCX	--	--	--	--	\$3,690
	30	30	36	62	30	LKS30-36SCX	--	--	--	--	\$3,850

Electrical Options and Upcharges

CTEC23	
EC23 Power Center Top - Black	CTEC23BL - add \$663
EC23 Power Center Top - White	CTEC23WH - add \$663
CTEC24	
EC24 Power Center Top - Black	CTEC43BL - add \$549
EC24 Power Center Top - White	CTEC43WH - add \$549

To Order Specify

① Veneer Model #	② Edge Detail	③ Wood Collection	④ Wood Finish	⑤ Electrical	⑥ Metal Color
Veneer (LKV)	See Edge Detail Options	Essentials	See Essentials Wood Finish Options	N None CTEC23 Power Center Top CTEC24 Power Center Top (See chart above)	See Metal Finish Color Options
		Artisan	④ Wood Finish See Artisan Wood Finish Options		

① Solid Surface Model #	② Top Surface Selection	③ Electrical Cut Out	④ Metal Color
Solid Surface (LKS)	See Solid Surface Top Surface Selection Options	N None CTEC23 Power Center Top CTEC24 Power Center Top (See chart above)	See Metal Finish Color Options

LOK-CONFERENCE

Description

Squire Table with X4 Base at Counter Height



Laminate Tables "LKT" Models

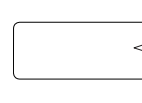

Eased Edge (R3)

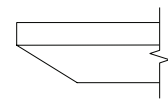

Reverse Bevel Edge (K9)

LAMINATE	D	W	H	CTN WT	CU FT	Model	Eased Edge (R3)		Reverse Bevel Edge (K9)	
							Standard Tier 1	Graded In Tier 2	Standard Tier 1	Graded In Tier 2
	60	60	36	163	66	LKT60-36SCZ	\$2,910	\$3,009	\$3,383	\$3,481
54	54	36	143	63	LKT54-36SCZ	\$2,722	\$2,796	\$3,191	\$3,267	
48	48	36	136	60	LKT48-36SCZ	\$2,587	\$2,708	\$3,055	\$3,179	

Features:

- price reflects complete table - top and base
- ships KD in multiple cartons
- one piece top
- model includes adjustable glide
- power cord is routed outside base column
- order vertical wire manager separately; see page 407

Options:

- specify power unit option; None (N), add \$663 for EC23 (CTEC23), add \$549 for EC24 (CTEC24)

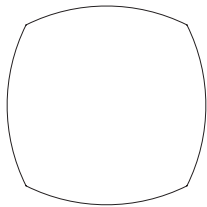

top shape

LOK - CONFERENCE

To Order Specify

1 Laminates Model #	2 Edge Detail	3 Laminates Selection	3a PVC Edge Color	4 Electrical	5 Metal Color
Laminates (LKT)	See Edge Detail Options	See Laminates Selection	See PVC Edge Color Options	N None CTEC23 Power Center Top CTEC24 Power Center Top (See chart on next page)	See Metal Finish Color Options

Model Number Breakdown

LKT60-36SCZ					
LK	T	60	36	SC	Z
LOK	Laminates	60" dia.	Height	Squire Top Shape	X4 Base

Description

Squirrel Table with X4 Base at Counter Height (continued)

Veneer Tables "LKV" Models Solid Surface Tables "LKS" Models

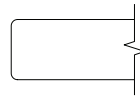

Eased Edge (R3)

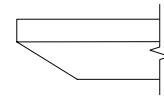

Reverse Bevel Edge (K9)

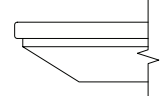

Reverse Bevel Edge (K7)

	D	W	H	CTN WT	CU FT	① Model	Essentials		Artisan		Standard		
VENEER	60	60	36	163	66	LKV60-36SCZ	\$3,808		\$4,057		\$3,950	\$4,209	--
	54	54	36	143	63	LKV54-36SCZ	\$3,599		\$3,840		\$3,739	\$3,992	--
	48	48	36	136	60	LKV48-36SCZ	\$3,136		\$3,285		\$3,222	\$3,383	--
SOLID SURFACE	60	60	36	163	66	LKS60-36SCZ	--	--	--	--	--	--	\$8,284
	54	54	36	143	63	LKS54-36SCZ	--	--	--	--	--	--	\$7,778
	48	48	36	136	60	LKS48-36SCZ	--	--	--	--	--	--	\$6,185

Electrical Options and Upcharges

CTEC23	
EC23 Power Center Top - Black	CTEC23BL - add \$663
EC23 Power Center Top - White	CTEC23WH - add \$663
CTEC24	
EC24 Power Center Top - Black	CTEC43BL - add \$549
EC24 Power Center Top - White	CTEC43WH - add \$549

To Order Specify

① Veneer Model #	② Edge Detail	③ Wood Collection	④ Wood Finish	⑤ Electrical	⑥ Metal Color
Veneer (LKV)	See Edge Detail Options	Essentials	See Essentials Wood Finish Options	N None CTEC23 Power Center Top CTEC24 Power Center Top (See chart above)	See Metal Finish Color Options
		Artisan	④ Wood Finish See Artisan Wood Finish Options		

① Solid Surface Model #	② Top Surface Selection	③ Electrical Cut Out	④ Metal Color
Solid Surface (LKS)	See Solid Surface Top Surface Selection Options	N None CTEC23 Power Center Top CTEC24 Power Center Top (See chart above)	See Metal Finish Color Options

LOK-CONFERENCE

Description

Hive Table with T Base at Counter Height

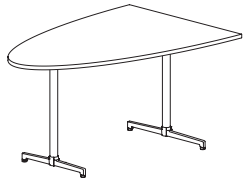

Laminate Tables
"LKT" Models

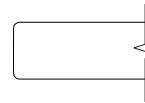

Eased Edge (R3)

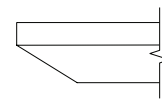

Reverse Bevel Edge (K9)

LAMI	D	W	H	CTN WT	CU FT	Model	Standard Tier 1	Graded In Tier 2	Standard Tier 1	Graded In Tier 2
		48	72	36	135	87	LKT4872-36HVT	\$2,276	\$2,321	\$2,787

Features:

- price reflects complete table - top and base
- ships KD in multiple cartons
- model includes adjustable glide

Options:

- specify power/charging option, see below for options and upcharges

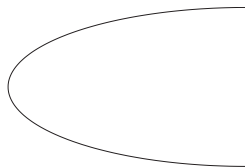

top shape

LOK - CONFERENCE

To Order Specify

1 Laminate Model #	2 Edge Detail	3 Laminate Selection	3a PVC Edge Color	4 Electrical
Laminate (LKT)	See Edge Detail Options	See Laminate Selection	See PVC Edge Color Options	N None CT2 Dual Power Center Top (See chart on next page) CU1 Single Power Underside 5 Metal Finish See Metal Finish Color Options

Model Number Breakdown

LKT4872-36HVT					
LK	T	4872	36	HV	T
LOK	Laminate	48" x 72"	Height	Hive Top Shape	T base

Description

Hive Table with T Base at Counter Height
(continued)

Veneer Tables
"LKV" Models

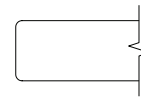

Eased Edge (R3)

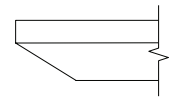

Reverse Bevel Edge (K9)

VEN.	D	W	H	CTN WT	CU FT	① Model	Essentials		Artisan	
	48	72	36	135	87	LKV4872-36HVT	\$2,868		\$3,098	
									\$3,124	\$3,328

Electrical Options and Upcharges

CT2	
Dual Power Center Top - Black	CT2BL - add \$1,437
Dual Power Center Top - White	CT2WH - add \$1,437
CU1	
Single Power Underside - Black	CU11C - add \$559
Single Power Underside with Wireless Charging - Black	CU11CW - add \$1,338

Note: Order power infeed that best fits application.

To Order, Specify:

① Veneer Model #	② Edge Detail	③ Wood Collection	④ Top Wood Finish	⑤ Electrical	⑥ Metal Color
Veneer (LKV)	See Edge Detail Options	Essentials	See Essentials Wood Finish Options	N None CT2 Dual Power Center Top CU1 Single Power Underside (See chart above)	See Metal Finish Color Options
		Artisan	④ Top Wood Finish See Artisan Wood Finish Options		

LOK- CONFERENCE

Description

Rectangular Table with T Base at Bar Height

Laminate Tables "LKT" Models

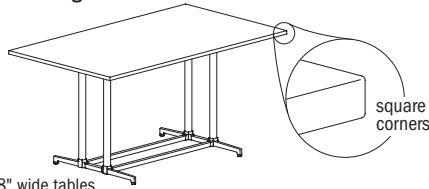

48" wide tables have double column base

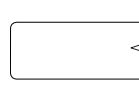

Eased Edge (R3)

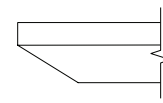

Reverse Bevel Edge (K9)

LAMINATE	D	W	H	CTN WT	CU FT	Model	Eased Edge (R3)		Reverse Bevel Edge (K9)	
							Standard Tier 1	Graded In Tier 2	Standard Tier 1	Graded In Tier 2
		48	96	42	239	132	LKT4896-42TTT	\$3,438	\$3,491	\$3,924
	48	84	42	216	117	LKT4884-42TTT	\$3,171	\$3,218	\$3,647	\$3,693
	42	96	42	190	118	LKT4296-42TTT	\$3,050	\$3,097	\$3,523	\$3,568
	42	84	42	215	105	LKT4284-42TTT	\$3,131	\$3,171	\$3,594	\$3,635
	36	96	42	169	102	LKT3696-42TTT	\$2,589	\$2,627	\$3,048	\$3,087
	36	84	42	151	90	LKT3684-42TTT	\$2,337	\$2,373	\$2,791	\$2,823

Features:

- price reflects complete table - top and base
- ships KD in multiple cartons
- one piece top
- model includes adjustable glide

Options:

- specify power/charging option, see below for options and upcharges

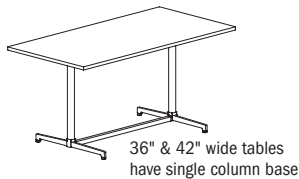

36" & 42" wide tables have single column base



top shape

LOK - CONFERENCE

To Order Specify

1 Laminite Model #	2 Edge Detail	3 Laminite Selection	3a PVC Edge Color	4 Electrical	5 Metal Color
Laminite (LKT)	See Edge Detail Options	See Laminite Selection	See PVC Edge Color Options	N None CT2 Dual Power Center Top CU2 Dual Power Underside CT2U1 Dual Power Center Top with Underside (See chart on next page)	See Metal Finish Color Options

Model Number Breakdown

LKT4896-42TTT					
LK	T	4896	42	TT	T
LOK	Laminite	48" x 96"	Height	Rectangular Top Shape	T base

Description

Rectangular Table with T Base
at Bar Height
(continued)

Veneer Tables
"LKV" Models

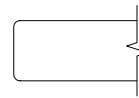

Eased Edge (R3)

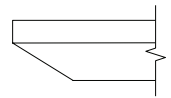

Reverse Bevel Edge (K9)

D	W	H	CTN WT	CU FT	① Model	Essentials		Artisan	
						Essentials	Artisan	Essentials	Artisan
48	96	42	239	132	LKV4896-42TTT	\$4,766	\$5,114	\$5,085	\$5,408
48	84	42	216	117	LKV4884-42TTT	\$4,484	\$4,785	\$4,781	\$5,058
42	96	42	190	118	LKV4296-42TTT	\$4,532	\$4,893	\$4,939	\$5,261
	84	42	215	105	LKV4284-42TTT	\$3,878	\$4,190	\$4,229	\$4,501
36	96	42	169	102	LKV3696-42TTT	\$3,485	\$3,764	\$3,796	\$4,045
36	84	42	151	90	LKV3684-42TTT	\$3,220	\$3,479	\$3,509	\$3,738

VENEER

Electrical Options and Upcharges

CT2	84 - 96 wide
Dual Power Center Top - Black	CT2BL - add \$1,535
Dual Power Center Top - White	CT2WH - add \$1,535
CU1	
Dual Power Underside - Black	CU1-1C - add \$610
Dual Power Underside with Wireless Charging - Black	CU1-1CW - add \$1,413
CT2U1	
Dual Power Center Top - Black with Underside	CT2U1-BL - add \$1,868
Dual Power Center Top - White with Underside	CT2U1-WH - add \$1,868
Dual Power Center Top - Black with Wireless Charging	CT2U1-BLW2 - add \$2,670
Dual Power Center Top - White with Wireless Charging	CT2U1-WHW2 - add \$2,670

Note: Order power infeed that best fits application

To Order Specify

① Veneer Model #	② Edge Detail	③ Wood Collection	④ Wood Finish	⑤ Electrical	⑥ Metal Color
Veneer (LKV)	See Edge Detail Options	Essentials	See Essentials Wood Finish Options	N None CT2 Dual Power Center Top CU2 Dual Power Underside CT2U1 Dual Power Center Top with Underside (See chart above)	See Metal Finish Color Options
		Artisan	④ Wood Finish See Artisan Wood Finish Options		

LOK - CONFERENCE

Description

Rounded Rectangular Table with T Base at Bar Height

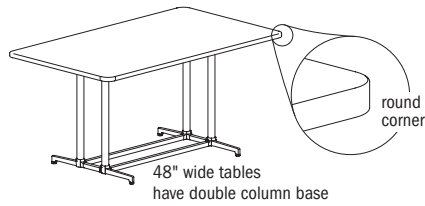

Laminate Tables "LKT" Models

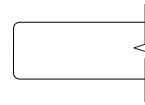

Eased Edge (R3)

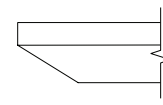

Reverse Bevel Edge (K9)

LAMINATE

D	W	H	CTN WT	CU FT	Model	Eased Edge (R3)		Reverse Bevel Edge (K9)	
						Standard Tier 1	Graded In Tier 2	Standard Tier 1	Graded In Tier 2
48	96	42	239	132	LKT4896-42TTRT	\$3,501	\$3,555	\$3,988	\$4,043
48	84	42	216	117	LKT4884-42TTRT	\$3,189	\$3,236	\$3,664	\$3,708
42	96	42	190	118	LKT4296-42TTRT	\$3,108	\$3,154	\$3,583	\$3,629
42	84	42	215	105	LKT4284-42TTRT	\$3,186	\$3,226	\$3,649	\$3,691
36	96	42	169	102	LKT3696-42TTRT	\$2,641	\$2,682	\$3,103	\$3,143
36	84	42	151	90	LKT3684-42TTRT	\$2,387	\$2,422	\$2,839	\$2,874

Features:

- price reflects complete table - top and base
- ships KD in multiple cartons
- one piece top
- model includes adjustable glide

Options:

- specify power/charging option, see below for options and upcharges

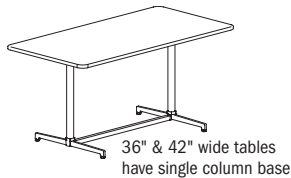

top shape

LOK - CONFERENCE

To Order Specify

1 Laminate Model #	2 Edge Detail	3 Laminate Selection	3a PVC Edge Color	4 Electrical	5 Metal Color
Laminate (LKT)	See Edge Detail Options	See Laminate Selection	See PVC Edge Color Options	N None CT2 Dual Power Center Top CU2 Dual Power Underside CT2U1 Dual Power Center Top with Underside (See chart on next page)	See Metal Finish Color Options

Model Number Breakdown

LKT4896-42TTRT						
LK	T	4896	42	TT	R	T
LOK	Laminate	48" x 96"	Height	Rectangular Top Shape	Rounded Corner	T Base

Description

Rounded Rectangular Table with T Base at Bar Height (continued)

Veneer Tables "LKV" Models Solid Surface Tables "LKS" Models

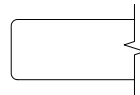

Eased Edge (R3)

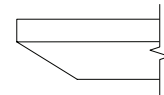

Reverse Bevel Edge (K9)

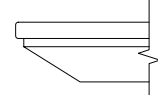

Reverse Bevel Edge (K7)

	D	W	H	CTN WT	CU FT	① Model	Veneer Tables		Solid Surface Tables		
							Essentials	Artisan	Essentials	Artisan	Standard
VENEER	48	96	42	239	132	LKV4896-42TTRT	\$4,849	\$5,197	\$5,165	\$5,489	--
	48	84	42	216	117	LKV4884-42TTRT	\$4,507	\$4,806	\$4,803	\$5,084	--
	42	96	42	190	118	LKV4296-42TTRT	\$4,607	\$4,973	\$5,020	\$5,345	--
	42	84	42	215	105	LKV4284-42TTRT	\$4,628	\$4,998	\$5,045	\$5,373	--
	36	96	42	169	102	LKV3696-42TTRT	\$3,551	\$3,833	\$3,869	\$4,120	--
	36	84	42	151	90	LKV3684-42TTRT	\$3,282	\$3,544	\$3,576	\$3,810	--
SOLID SURFACE	48	96	42	239	132	LKS4896-42TTRT	--	--	--	--	\$10,904
	48	84	42	216	117	LKS4884-42TTRT	--	--	--	--	\$9,763
	42	96	42	190	118	LKS4296-42TTRT	--	--	--	--	\$8,807
	42	84	42	215	105	LKS4284-42TTRT	--	--	--	--	\$8,513
	36	96	42	169	102	LKS3696-42TTRT	--	--	--	--	\$7,762
	36	84	42	151	90	LKS3684-42TTRT	--	--	--	--	\$7,014

Electrical Options and Upcharges

CT2	84 - 96 wide
Dual Power Center Top - Black	CT2BL - add \$1,535
Dual Power Center Top - White	CT2WH - add \$1,535
CU1	
Dual Power Underside - Black	CU1-1C - add \$610
Dual Power Underside with Wireless Charging - Black	CU1-1CW - add \$1,413
CT2U1	
Dual Power Center Top - Black with Underside	CT2U1-BL - add \$1,868
Dual Power Center Top - White with Underside	CT2U1-WH - add \$1,868
Dual Power Center Top - Black with Wireless Charging	CT2U1-BLW2 - add \$2,670
Dual Power Center Top - White with Wireless Charging	CT2U1-WHW2 - add \$2,670

Note: Order power infeed that best fits application

To Order Specify

① Veneer Model #	② Edge Detail	③ Wood Collection	④ Wood Finish	⑤ Electrical	⑥ Metal Color
Veneer (LKV)	See Edge Detail Options	Essentials	See Essentials Wood Finish Options	N None CT2 Dual Power Center Top CU2 Dual Power Underside CT2U1 Dual Power Center Top with Underside (See chart above)	See Metal Finish Color Options
		Artisan	④ Wood Finish See Artisan Wood Finish Options		

① Solid Surface Model #	② Top Surface Selection	③ Electrical	④ Metal Color
Solid Surface (LKS)	See Solid Surface Top Surface Selection Options	N None CT2 Dual Power Center Top CU2 Dual Power Underside CT2U1 Dual Power Center Top with Underside (See chart above)	See Metal Finish Color Options

LOK - CONFERENCE

Description

Rectangular Table with Y Base at Bar Height

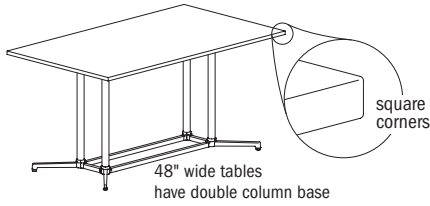

Laminate Tables "LKT" Models

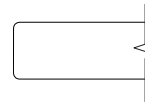

Eased Edge (R3)

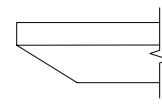

Reverse Bevel Edge (K9)

LAMINATE	D	W	H	CTN WT	CU FT	Model	Standard Tier 1	Graded In Tier 2	Standard Tier 1	Graded In Tier 2
		48	96	42	229	132	LKT4896-42TTY	\$3,353	\$3,407	\$3,839
	48	84	42	215	117	LKT4884-42TTY	\$2,962	\$3,006	\$3,433	\$3,482
	42	96	42	200	118	LKT4296-42TTY	\$3,809	\$3,855	\$4,282	\$4,330
	42	84	42	160	103	LKT4284-42TTY	\$2,647	\$2,689	\$3,112	\$3,152
	36	96	42	180	102	LKT3696-42TTY	\$2,659	\$2,701	\$3,120	\$3,162
	36	84	42	162	90	LKT3684-42TTY	\$2,369	\$2,402	\$2,821	\$2,857

Features:

- price reflects complete table - top and base
- ships KD in multiple cartons
- one piece top
- model includes adjustable glide

Options:

- specify power/charging option, see below for options and upcharges

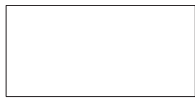
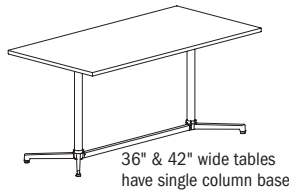

top shape

LOK - CONFERENCE

To Order Specify

1 Laminite Model #	2 Edge Detail	3 Laminite Selection	3a PVC Edge Color	4 Electrical	5 Metal Color
Laminite (LKT)	See Edge Detail Options	See Laminite Selection	See PVC Edge Color Options	N None CT2 Dual Power Center Top CU2 Dual Power Underside CT2U1 Dual Power Center Top with Underside (See chart on next page)	See Metal Finish Color Options

Model Number Breakdown

LKT4896-42TTY					
LK	T	4896	42	TT	Y
LOK	Laminite	48" x 96"	Height	Rectangular Top Shape	Y Base

Description

Rectangular Table with Y Base at Bar Height (continued)

Veneer Tables "LKV" Models

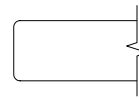

Eased Edge (R3)

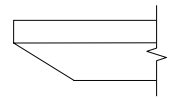

Reverse Bevel Edge (K9)

D	W	H	CTN WT	CU FT	① Model	Essentials		Artisan	
						Essentials	Artisan	Essentials	Artisan
48	96	42	229	132	LKV4896-42TTY	\$4,659	\$5,004	\$4,977	\$5,301
48	84	42	215	117	LKV4884-42TTY	\$4,219	\$4,519	\$4,514	\$4,794
42	96	42	200	118	LKV4296-42TTY	\$5,481	\$5,921	\$5,974	\$6,364
	84	42	160	103	LKV4284-42TTY	\$3,969	\$4,288	\$4,326	\$4,608
36	96	42	180	102	LKV3696-42TTY	\$3,573	\$3,860	\$3,896	\$4,148
36	84	42	162	90	LKV3684-42TTY	\$3,259	\$3,521	\$3,553	\$3,784

VENEER

Electrical Options and Upcharges

CT2	84 - 96 wide
Dual Power Center Top - Black	CT2BL - add \$1,535
Dual Power Center Top - White	CT2WH - add \$1,535
CU1	
Dual Power Underside - Black	CU1-1C - add \$610
Dual Power Underside with Wireless Charging - Black	CU1-1CW - add \$1,413
CT2U1	
Dual Power Center Top - Black with Underside	CT2U1-BL - add \$1,868
Dual Power Center Top - White with Underside	CT2U1-WH - add \$1,868
Dual Power Center Top - Black with Wireless Charging	CT2U1-BLW2 - add \$2,670
Dual Power Center Top - White with Wireless Charging	CT2U1-WHW2 - add \$2,670

Note: Order power infeed that best fits application

To Order Specify

① Veneer Model #	② Edge Detail	③ Wood Collection	④ Wood Finish	⑤ Electrical	⑥ Metal Color
Veneer (LKV)	See Edge Detail Options	Essentials	See Essentials Wood Finish Options	N None CT2 Dual Power Center Top CU2 Dual Power Underside CT2U1 Dual Power Center Top with Underside (See chart above)	See Metal Finish Color Options
		Artisan	④ Wood Finish See Artisan Wood Finish Options		

LOK - CONFERENCE

Description

Rounded Rectangular Table with Y Base at Bar Height

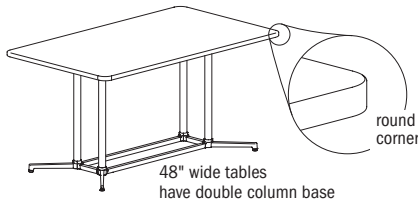

Laminate Tables
"LKT" Models

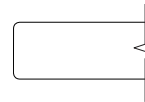

Eased Edge (R3)

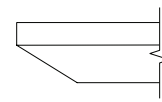

Reverse Bevel Edge (K9)

LAMINATE	D	W	H	CTN WT	CU FT	1 Model	Eased Edge (R3)		Reverse Bevel Edge (K9)	
							Standard Tier 1	Graded In Tier 2	Standard Tier 1	Graded In Tier 2
	48	96	42	229	132	LKT4896-42TTRY	\$3,418	\$3,471	\$3,904	\$3,958
48	84	42	215	117	LKT4884-42TTRY	\$3,017	\$3,065	\$3,494	\$3,540	
42	96	42	200	118	LKT4296-42TTRY	\$3,868	\$3,913	\$4,341	\$4,388	
42	84	42	160	103	LKT4284-42TTRY	\$2,703	\$2,743	\$3,167	\$3,207	
36	96	42	180	102	LKT3696-42TTRY	\$2,716	\$2,756	\$3,176	\$3,217	
36	84	42	162	90	LKT3684-42TTRY	\$2,418	\$2,454	\$2,870	\$2,906	

Features:

- price reflects complete table - top and base
- ships KD in multiple cartons
- one piece top
- model includes adjustable glide

Options:

- specify power/charging option, see below for options and upcharges

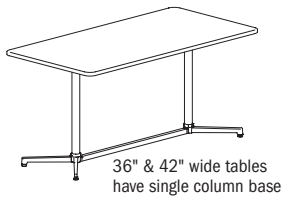

top shape

LOK - CONFERENCE

To Order Specify

1 Laminate Model #	2 Edge Detail	3 Laminate Selection	3a PVC Edge Color	4 Electrical	5 Metal Color
Laminate (LKT)	See Edge Detail Options	See Laminate Selection	See PVC Edge Color Options	N None CT2 Dual Power Center Top CU2 Dual Power Underside CT2U1 Dual Power Center Top with Underside (See chart on next page)	See Metal Finish Color Options

Model Number Breakdown

LKT4896-42TTRY						
LK	T	4896	42	TT	R	Y
LOK	Laminate	48" x 96"	Height	Rectangular Top Shape	Rounded Corner	Y Base

Description

Rounded Rectangular Table with Y Base at Bar Height (continued)

Veneer Tables "LKV" Models Solid Surface Tables "LKS" Models

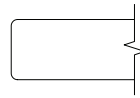

Eased Edge (R3)

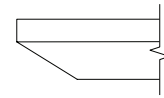

Reverse Bevel Edge (K9)

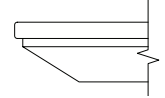

Reverse Bevel Edge (K7)

	D	W	H	CTN WT	CU FT	① Model	Veneer		Solid Surface		
							Essentials	Artisan	Essentials	Artisan	Standard
VENEER	48	96	42	229	132	LKV4896-42TTRY	\$4,741	\$5,087	\$5,058	\$5,381	--
	48	84	42	215	117	LKV4884-42TTRY	\$4,294	\$4,594	\$4,589	\$4,869	--
	42	96	42	200	118	LKV4296-42TTRY	\$5,555	\$6,000	\$6,056	\$6,449	--
	42	84	42	160	103	LKV4284-42TTRY	\$4,038	\$4,360	\$4,402	\$4,686	--
	36	96	42	180	102	LKV3696-42TTRY	\$3,641	\$3,933	\$3,968	\$4,227	--
	36	84	42	162	90	LKV3684-42TTRY	\$3,321	\$3,588	\$3,619	\$3,856	--
SOLID SURFACE	48	96	42	229	132	LKS4896-42TTRY	--	--	--	--	\$10,797
	48	84	42	215	117	LKS4884-42TTRY	--	--	--	--	\$9,549
	42	96	36	197	102	LKS4296-42TTRY	--	--	--	--	\$9,756
	42	84	42	160	103	LKS4284-42TTRY	--	--	--	--	\$7,920
	36	96	42	180	102	LKS3696-42TTRY	--	--	--	--	\$7,850
	36	84	42	162	90	LKS3684-42TTRY	--	--	--	--	\$7,056

Electrical Options and Upcharges

CT2	84 - 96 wide
Dual Power Center Top - Black	CT2BL - add \$1,535
Dual Power Center Top - White	CT2WH - add \$1,535
CU1	
Dual Power Underside - Black	CU1-1C - add \$610
Dual Power Underside with Wireless Charging - Black	CU1-1CW - add \$1,413
CT2U1	
Dual Power Center Top - Black with Underside	CT2U1-BL - add \$1,868
Dual Power Center Top - White with Underside	CT2U1-WH - add \$1,868
Dual Power Center Top - Black with Wireless Charging	CT2U1-BLW2 - add \$2,670
Dual Power Center Top - White with Wireless Charging	CT2U1-WHW2 - add \$2,670

Note: Order power infeed that best fits application

To Order Specify

① Veneer Model #	② Edge Detail	③ Wood Collection	④ Wood Finish	⑤ Electrical	⑥ Metal Color
Veneer (LKV)	See Edge Detail Options	Essentials	See Essentials Wood Finish Options	N None CT2 Dual Power Center Top CU2 Dual Power Underside CT2U1 Dual Power Center Top with Underside (See chart above)	See Metal Finish Color Options
		Artisan	④ Wood Finish See Artisan Wood Finish Options		

① Solid Surface Model #	② Top Surface Selection	③ Electrical	④ Metal Color
Solid Surface (LKS)	See Solid Surface Top Surface Selection Options	N None CT2 Dual Power Center Top CU2 Dual Power Underside CT2U1 Dual Power Center Top with Underside (See chart above)	See Metal Finish Color Options

LOK - CONFERENCE

Description

Arc Rectangular Table with T Base at Bar Height

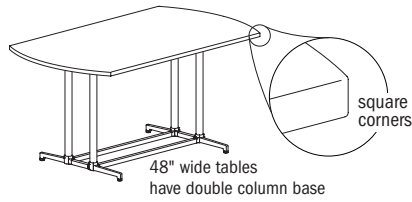

Laminate Tables
"LKT" Models

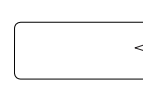

Eased Edge (R3)

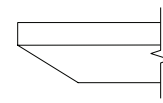

Reverse Bevel Edge (K9)

LAMINATE	D	W	H	CTN WT	CU FT	Model	Eased Edge (R3)		Reverse Bevel Edge (K9)	
							Standard Tier 1	Graded In Tier 2	Standard Tier 1	Graded In Tier 2
	48	96	42	232	132	LKT4896-42ART	\$3,501	\$3,555	\$3,988	\$4,043
48	84	42	208	117	LKT4884-42ART	\$3,189	\$3,236	\$3,664	\$3,708	
42	96	42	186	118	LKT4296-42ART	\$3,108	\$3,154	\$3,583	\$3,629	
42	84	42	207	90	LKT4284-42ART	\$3,186	\$3,226	\$3,649	\$3,691	
36	96	42	166	102	LKT3696-42ART	\$2,641	\$2,682	\$3,103	\$3,143	
36	84	42	147	90	LKT3684-42ART	\$2,387	\$2,422	\$2,839	\$2,874	

Features:

- price reflects complete table - top and base
- ships KD in multiple cartons
- one piece top
- model includes adjustable glide

Options:

- specify power/charging option, see below for options and upcharges

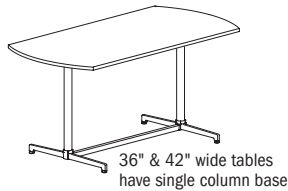

top shape

LOK - CONFERENCE

To Order Specify

1 Laminite Model #	2 Edge Detail	3 Laminite Selection	3a PVC Edge Color	4 Electrical	5 Metal Color
Laminite (LKT)	See Edge Detail Options	See Laminite Selection	See PVC Edge Color Options	N None CT2 Dual Power Center Top CU2 Dual Power Underside CT2U1 Dual Power Center Top with Underside (See chart on next page)	See Metal Finish Color Options

Model Number Breakdown

LKT4896-42ART					
LK	T	4896	42	AR	T
LOK	Laminite	48" x 96"	Height	Arc Rectangular Top Shape	T Base

Description

Arc Rectangular Table with T Base at Bar Height (continued)

Veneer Tables "LKV" Models

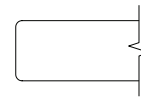

Eased Edge (R3)

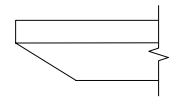

Reverse Bevel Edge (K9)

VENEER	D	W	H	CTN WT	CU FT	Model	Essentials	Artisan	Essentials	Artisan
	48	96	42	232	132	LKV4896-42ART	\$4,849	\$5,197	\$5,165	\$5,489
	48	84	42	208	117	LKV4884-42ART	\$4,507	\$4,806	\$4,803	\$5,084
	42	96	42	186	118	LKV4296-42ART	\$4,607	\$4,973	\$5,020	\$5,345
	42	84	42	207	90	LKV4284-42ART	\$4,628	\$4,998	\$5,045	\$5,373
	36	96	42	166	102	LKV3696-42ART	\$3,551	\$3,833	\$3,869	\$4,120
	36	84	42	147	90	LKV3684-42ART	\$3,282	\$3,544	\$3,576	\$3,810

Electrical Options and Upcharges

CT2	84 - 96 wide
Dual Power Center Top - Black	CT2BL - add \$1,535
Dual Power Center Top - White	CT2WH - add \$1,535
CU1	
Dual Power Underside - Black	CU1-1C - add \$610
Dual Power Underside with Wireless Charging - Black	CU1-1CW - add \$1,413
CT2U1	
Dual Power Center Top - Black with Underside	CT2U1-BL - add \$1,868
Dual Power Center Top - White with Underside	CT2U1-WH - add \$1,868
Dual Power Center Top - Black with Wireless Charging	CT2U1-BLW2 - add \$2,670
Dual Power Center Top - White with Wireless Charging	CT2U1-WhW2 - add \$2,670

Note: Order power infeed that best fits application

To Order Specify

1 Veneer Model #	2 Edge Detail	3 Wood Collection	4 Wood Finish	5 Electrical	6 Metal Color
Veneer (LKV)	See Edge Detail Options	Essentials	See Essentials Wood Finish Options	N None CT2 Dual Power Center Top CU2 Dual Power Underside CT2U1 Dual Power Center Top with Underside (See chart above)	See Metal Finish Color Options
		Artisan	4 Wood Finish See Artisan Wood Finish Options		

LOK- CONFERENCE

Description

Rounded Arc Rectangular Table with T Base at Bar Height

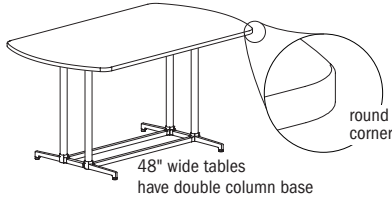

Laminate Tables
"LKT" Models

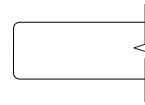

Eased Edge (R3)

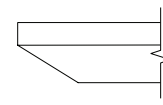

Reverse Bevel Edge (K9)

D	W	H	CTN WT	CU FT	Model	Eased Edge (R3)		Reverse Bevel Edge (K9)	
						Standard Tier 1	Graded In Tier 2	Standard Tier 1	Graded In Tier 2
48	96	42	232	132	LKT4896-42ARRT	\$3,501	\$3,555	\$3,988	\$4,043
48	84	42	208	117	LKT4884-42ARRT	\$3,189	\$3,236	\$3,664	\$3,708
42	96	42	186	118	LKT4296-42ARRT	\$3,108	\$3,154	\$3,583	\$3,629
42	84	42	207	90	LKT4284-42ARRT	\$3,186	\$3,226	\$3,649	\$3,691
36	96	42	166	102	LKT3696-42ARRT	\$2,641	\$2,682	\$3,103	\$3,143
36	84	42	147	90	LKT3684-42ARRT	\$2,387	\$2,422	\$2,839	\$2,874

LAMINATE

Features:

- price reflects complete table - top and base
- ships KD in multiple cartons
- one piece top
- model includes adjustable glide

Options:

- specify power/charging option, see below for options and upcharges

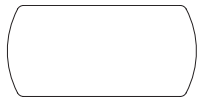
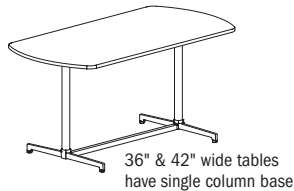

top shape

LOK - CONFERENCE

To Order Specify

1 Laminate Model #	2 Edge Detail	3 Laminate Selection	3a PVC Edge Color	4 Electrical	5 Metal Color
Laminate (LKT)	See Edge Detail Options	See Laminate Selection	See PVC Edge Color Options	N None CT2 Dual Power Center Top CU2 Dual Power Underside CT2U1 Dual Power Center Top with Underside (See chart on next page)	See Metal Finish Color Options

Model Number Breakdown

LKT4896-42ARRT						
LK	T	4896	42	AR	R	T
LOK	Laminate	48" x 96"	Height	Arc Rectangular Top Shape	Rounded Corner	T Base

Description

Rounded Arc Rectangular Table with T Base at Bar Height (continued)

Veneer Tables "LKV" Models Solid Surface Tables "LKS" Models

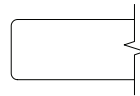

Eased Edge (R3)

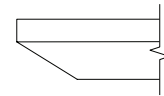

Reverse Bevel Edge (K9)

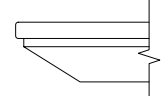

Reverse Bevel Edge (K7)

	D	W	H	CTN WT	CU FT	① Model	Veneer		Solid Surface		
							Essentials	Artisan	Essentials	Artisan	Standard
VENEER	48	96	42	232	132	LKV4896-42ARRT	\$4,849	\$5,197	\$5,165	\$5,489	--
	48	84	42	208	117	LKV4884-42ARRT	\$4,507	\$4,806	\$4,803	\$5,084	--
	42	96	42	186	118	LKV4296-42ARRT	\$4,607	\$4,973	\$5,020	\$5,345	--
	42	84	42	207	90	LKV4284-42ARRT	\$4,628	\$4,998	\$5,045	\$5,373	--
	36	96	42	166	102	LKV3696-42ARRT	\$3,551	\$3,833	\$3,869	\$4,120	--
	36	84	42	147	90	LKV3684-42ARRT	\$3,282	\$3,544	\$3,576	\$3,810	--
SOLID SURFACE	48	96	42	232	132	LKS4896-42ARRT	--	--	--	--	\$10,904
	48	84	42	208	117	LKS4884-42ARRT	--	--	--	--	\$9,763
	42	96	42	186	118	LKS4296-42ARRT	--	--	--	--	\$8,807
	42	84	42	207	90	LKS4284-42ARRT	--	--	--	--	\$8,513
	36	96	42	166	102	LKS3696-42ARRT	--	--	--	--	\$7,762
	36	84	42	147	90	LKS3684-42ARRT	--	--	--	--	\$7,014

Electrical Options and Upcharges

CT2	84 - 96 wide
Dual Power Center Top - Black	CT2BL - add \$1,535
Dual Power Center Top - White	CT2WH - add \$1,535
CU1	
Dual Power Underside - Black	CU1-1C - add \$610
Dual Power Underside with Wireless Charging - Black	CU1-1CW - add \$1,413
CT2U1	
Dual Power Center Top - Black with Underside	CT2U1-BL - add \$1,868
Dual Power Center Top - White with Underside	CT2U1-WH - add \$1,868
Dual Power Center Top - Black with Wireless Charging	CT2U1-BLW2 - add \$2,670
Dual Power Center Top - White with Wireless Charging	CT2U1-WHW2 - add \$2,670

Note: Order power infeed that best fits application

To Order Specify

① Veneer Model #	② Edge Detail	③ Wood Collection	④ Wood Finish	⑤ Electrical	⑥ Metal Color
Veneer (LKV)	See Edge Detail Options	Essentials	See Essentials Wood Finish Options	N None CT2 Dual Power Center Top CU2 Dual Power Underside CT2U1 Dual Power Center Top with Underside (See chart above)	See Metal Finish Color Options
		Artisan	④ Wood Finish See Artisan Wood Finish Options		

① Solid Surface Model #	② Top Surface Selection	③ Electrical	④ Metal Color
Solid Surface (LKS)	See Solid Surface Top Surface Selection Options	N None CT2 Dual Power Center Top CU2 Dual Power Underside CT2U1 Dual Power Center Top with Underside (See chart above)	See Metal Finish Color Options

LOK - CONFERENCE

Description

Arc Rectangular Table with Y Base at Bar Height

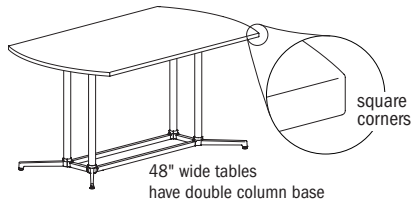

Laminate Tables "LKT" Models

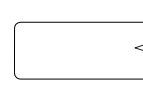

Eased Edge (R3)

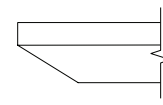

Reverse Bevel Edge (K9)

LAMINATE	D	W	H	CTN WT	CU FT	Model	Standard Tier 1	Graded In Tier 2	Standard Tier 1	Graded In Tier 2
	48	96	42	231	132	LKT4896-42ARY	\$3,418	\$3,471	\$3,904	\$3,958
	48	84	42	207	117	LKT4884-42ARY	\$3,017	\$3,065	\$3,494	\$3,540
42	96	42	196	118	LKT4296-42ARY	\$3,868	\$3,913	\$4,341	\$4,388	
42	84	42	160	103	LKT4284-42ARY	\$2,703	\$2,743	\$3,167	\$3,207	
36	96	42	167	102	LKT3696-42ARY	\$2,716	\$2,756	\$3,176	\$3,217	
36	84	42	153	90	LKT3684-42ARY	\$2,418	\$2,454	\$2,870	\$2,906	

Features:

- price reflects complete table - top and base
- ships KD in multiple cartons
- one piece top
- model includes adjustable glide

Options:

- specify power/charging option, see below for options and upcharges

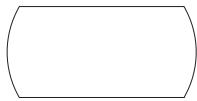
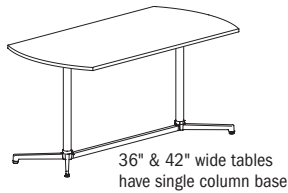

top shape

LOK - CONFERENCE

To Order Specify

1 Laminate Model #	2 Edge Detail	3 Laminate Selection	3a PVC Edge Color	4 Electrical	5 Metal Color
Laminate (LKT)	See Edge Detail Options	See Laminate Selection	See PVC Edge Color Options	N None CT2 Dual Power Center Top CU2 Dual Power Underside CT2U1 Dual Power Center Top with Underside (See chart on next page)	See Metal Finish Color Options

Model Number Breakdown

LKT4896-42ARY					
LK	T	4896	42	AR	Y
LOK	Laminate	48" x 96"	Height	Acr Rectangular Top Shape	Y Base

Description

Arc Rectangular Table with Y Base at Bar Height (continued)

Veneer Tables "LKV" Models

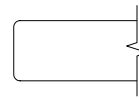

Eased Edge (R3)

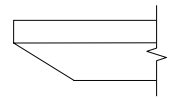

Reverse Bevel Edge (K9)

D	W	H	CTN WT	CU FT	Model	Essentials		Artisan	
						Essentials	Artisan	Essentials	Artisan
48	96	42	231	132	LKV4896-42ARY	\$4,741	\$5,087	\$5,058	\$5,381
48	84	42	207	117	LKV4884-42ARY	\$4,294	\$4,594	\$4,589	\$4,869
42	96	42	196	118	LKV4296-42ARY	\$5,555	\$6,000	\$6,056	\$6,449
	84	42	160	103	LKV4284-42ARY	\$4,038	\$4,360	\$4,402	\$4,686
36	96	42	167	102	LKV3696-42ARY	\$3,641	\$3,933	\$3,968	\$4,227
36	84	42	153	90	LKV3684-42ARY	\$3,321	\$3,588	\$3,619	\$3,856

Electrical Options and Upcharges

CT2	84 - 96 wide
Dual Power Center Top - Black	CT2BL - add \$1,535
Dual Power Center Top - White	CT2WH - add \$1,535
CU1	
Dual Power Underside - Black	CU1-1C - add \$610
Dual Power Underside with Wireless Charging - Black	CU1-1CW - add \$1,413
CT2U1	
Dual Power Center Top - Black with Underside	CT2U1-BL - add \$1,868
Dual Power Center Top - White with Underside	CT2U1-WH - add \$1,868
Dual Power Center Top - Black with Wireless Charging	CT2U1-BLW2 - add \$2,670
Dual Power Center Top - White with Wireless Charging	CT2U1-WHW2 - add \$2,670

Note: Order power infeed that best fits application

To Order Specify

1 Veneer Model #	2 Edge Detail	3 Wood Collection	4 Wood Finish	5 Electrical	6 Metal Color
Veneer (LKV)	See Edge Detail Options	Essentials	See Essentials Wood Finish Options	N None CT2 Dual Power Center Top CU2 Dual Power Underside CT2U1 Dual Power Center Top with Underside (See chart above)	See Metal Finish Color Options
		Artisan	4 Wood Finish See Artisan Wood Finish Options		

LOK - CONFERENCE

Description

Rounded Arc Rectangular Table with Y Base at Bar Height

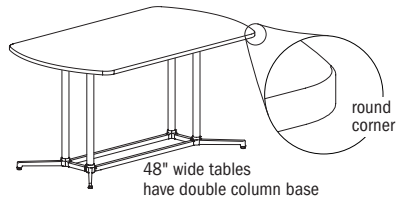

Laminate Tables
"LKT" Models

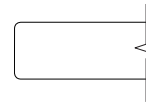

Eased Edge (R3)

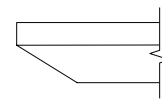

Reverse Bevel Edge (K9)

D	W	H	CTN WT	CU FT	Model	Eased Edge (R3)		Reverse Bevel Edge (K9)	
						Standard Tier 1	Graded In Tier 2	Standard Tier 1	Graded In Tier 2
48	96	42	231	132	LKT4896-42ARRY	\$3,418	\$3,471	\$3,904	\$3,958
48	84	42	175	117	LKT4884-42ARRY	\$3,017	\$3,065	\$3,494	\$3,540
42	96	42	196	118	LKT4296-42ARRY	\$3,868	\$3,913	\$4,341	\$4,388
42	84	42	180	103	LKT4284-42ARRY	\$2,703	\$2,743	\$3,167	\$3,207
36	96	42	167	102	LKT3696-42ARRY	\$2,716	\$2,756	\$3,176	\$3,217
36	84	42	159	90	LKT3684-42ARRY	\$2,418	\$2,454	\$2,870	\$2,906

LAMINATE

Features:

- price reflects complete table - top and base
- ships KD in multiple cartons
- one piece top
- model includes adjustable glide

Options:

- specify power/charging option, see below for options and upcharges

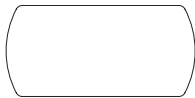
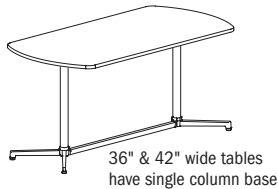

top shape

LOK - CONFERENCE

To Order Specify

1 Laminate Model #	2 Edge Detail	3 Laminate Selection	3a PVC Edge Color	4 Electrical	5 Metal Color
Laminate (LKT)	See Edge Detail Options	See Laminate Selection	See PVC Edge Color Options	N None CT2 Dual Power Center Top CU2 Dual Power Underside CT2U1 Dual Power Center Top with Underside (See chart on next page)	See Metal Finish Color Options

Model Number Breakdown

LKT4896-42ARRY						
LK	T	4896	42	AR	R	Y
LOK	Laminate	48" x 96"	Height	Arc Rectangular Top Shape	Rounded Corner	Y Base

Description

Rounded Arc Rectangular Table with Y Base at Bar Height (continued)

Veneer Tables "LKV" Models Solid Surface Tables "LKS" Models

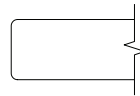

Eased Edge (R3)

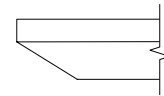

Reverse Bevel Edge (K9)

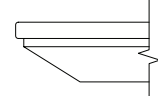

Reverse Bevel Edge (K7)

	D	W	H	CTN WT	CU FT	① Model	Veneer		Solid Surface		
							Essentials	Artisan	Essentials	Artisan	Standard
VENEER	48	96	42	231	132	LKV4896-42ARRY	\$4,741	\$5,087	\$5,058	\$5,381	--
	48	84	42	175	117	LKV4884-42ARRY	\$4,294	\$4,594	\$4,589	\$4,869	--
	42	96	42	196	118	LKV4296-42ARRY	\$5,555	\$6,000	\$6,056	\$6,449	--
	42	84	42	180	103	LKV4284-42ARRY	\$4,038	\$4,360	\$4,402	\$4,686	--
	36	96	42	167	102	LKV3696-42ARRY	\$3,641	\$3,933	\$3,968	\$4,227	--
	36	84	42	159	90	LKV3684-42ARRY	\$3,321	\$3,588	\$3,619	\$3,856	--
SOLID SURFACE	48	96	42	231	132	LKS4896-42ARRY	--	--	--	--	\$10,797
	48	84	42	175	117	LKS4884-42ARRY	--	--	--	--	\$9,549
	42	96	42	196	118	LKS4296-42ARRY	--	--	--	--	\$9,756
	42	84	42	180	103	LKS4284-42ARRY	--	--	--	--	\$7,920
	36	96	42	167	102	LKS3696-42ARRY	--	--	--	--	\$7,850
	36	84	42	159	90	LKS3684-42ARRY	--	--	--	--	\$7,056

Electrical Options and Upcharges

CT2	84 - 96 wide
Dual Power Center Top - Black	CT2BL - add \$1,535
Dual Power Center Top - White	CT2WH - add \$1,535
CU1	
Dual Power Underside - Black	CU1-1C - add \$610
Dual Power Underside with Wireless Charging - Black	CU1-1CW - add \$1,413
CT2U1	
Dual Power Center Top - Black with Underside	CT2U1-BL - add \$1,868
Dual Power Center Top - White with Underside	CT2U1-WH - add \$1,868
Dual Power Center Top - Black with Wireless Charging	CT2U1-BLW2 - add \$2,670
Dual Power Center Top - White with Wireless Charging	CT2U1-WHW2 - add \$2,670

Note: Order power infeed that best fits application

To Order Specify

① Veneer Model #	② Edge Detail	③ Wood Collection	④ Wood Finish	⑤ Electrical	⑥ Metal Color
Veneer (LKV)	See Edge Detail Options	Essentials	See Essentials Wood Finish Options	N None CT2 Dual Power Center Top CU2 Dual Power Underside CT2U1 Dual Power Center Top with Underside (See chart above)	See Metal Finish Color Options
		Artisan	④ Wood Finish See Artisan Wood Finish Options		

① Solid Surface Model #	② Top Surface Selection	③ Electrical	④ Metal Color
Solid Surface (LKS)	See Solid Surface Top Surface Selection Options	N None CT2 Dual Power Center Top CU2 Dual Power Underside CT2U1 Dual Power Center Top with Underside (See chart above)	See Metal Finish Color Options

LOK - CONFERENCE

Description

Racetrack Table with Y Base at Bar Height

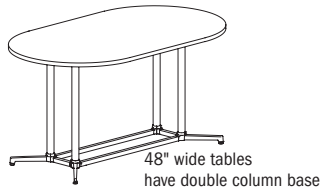

Laminate Tables "LKT" Models

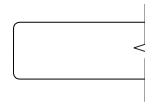

Eased Edge (R3)

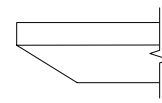

Reverse Bevel Edge (K9)

LAMINATE	D	W	H	CTN WT	CU FT	Model	Eased Edge (R3)		Reverse Bevel Edge (K9)	
							Standard Tier 1	Graded In Tier 2	Standard Tier 1	Graded In Tier 2
		48	96	42	219	132	LKT4896-42RKY	\$3,418	\$3,471	\$3,904
	48	84	42	197	117	LKT4884-42RKY	\$3,017	\$3,065	\$3,494	\$3,540
	42	96	42	188	118	LKT4296-42RKY	\$3,868	\$3,913	\$4,341	\$4,388
	42	84	42	167	103	LKT4284-42RKY	\$2,703	\$2,743	\$3,167	\$3,207
	36	96	42	177	102	LKT3696-42RKY	\$2,716	\$2,756	\$3,176	\$3,217
	36	84	42	152	90	LKT3684-42RKY	\$2,418	\$2,454	\$2,870	\$2,906

Features:

- price reflects complete table - top and base
- ships KD in multiple cartons
- one piece top
- model includes adjustable glide

Options:

- specify power/charging option, see below for options and upcharges

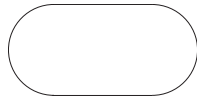

top shape

LOK - CONFERENCE

To Order Specify

1 Laminate Model #	2 Edge Detail	3 Laminate Selection	3a PVC Edge Color	4 Electrical	5 Metal Color
Laminate (LKT)	See Edge Detail Options	See Laminate Selection	See PVC Edge Color Options	N None CT2 Dual Power Center Top CU2 Dual Power Underside CT2U1 Dual Power Center Top with Underside (See chart on next page)	See Metal Finish Color Options

Model Number Breakdown

LKT4896-42RKY					
LK	T	4896	42	RK	Y
LOK	Laminate	48" x 96"	Height	Racetrack Top Shape	Y Base

Description

Racetrack Table with Y Base at Bar Height (continued)

Veneer Tables "LKV" Models

Solid Surface Tables "LKS" Models

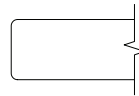

Eased Edge (R3)

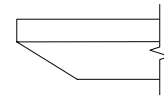

Reverse Bevel Edge (K9)

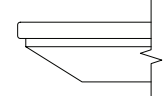

Reverse Bevel Edge (K7)

	D	W	H	CTN WT	CU FT	① Model	Veneer Tables		Solid Surface Tables		
							Essentials	Artisan	Essentials	Artisan	Standard
VENEER	48	96	42	219	132	LKV4896-42RKY	\$4,741	\$5,087	\$5,058	\$5,381	--
	48	84	42	197	117	LKV4884-42RKY	\$4,294	\$4,594	\$4,589	\$4,869	--
	42	96	42	188	118	LKV4296-42RKY	\$5,555	\$6,000	\$6,056	\$6,449	--
	42	84	42	167	103	LKV4284-42RKY	\$4,038	\$4,360	\$4,402	\$4,686	--
	36	96	42	177	102	LKV3696-42RKY	\$3,641	\$3,933	\$3,968	\$4,227	--
	36	84	42	152	90	LKV3684-42RKY	\$3,321	\$3,588	\$3,619	\$3,856	--
SOLID SURFACE	48	96	42	219	132	LKS4896-42RKY	--	--	--	--	\$10,797
	48	84	42	197	117	LKS4884-42RKY	--	--	--	--	\$9,549
	42	96	42	188	118	LKS4296-42RKY	--	--	--	--	\$9,756
	42	84	42	167	103	LKS4284-42RKY	--	--	--	--	\$7,920
	36	96	42	177	102	LKS3696-42RKY	--	--	--	--	\$7,850
	36	84	42	152	90	LKS3684-42RKY	--	--	--	--	\$7,056

Electrical Options and Upcharges

CT2	84 - 96 wide
Dual Power Center Top - Black	CT2BL - add \$1,535
Dual Power Center Top - White	CT2WH - add \$1,535
CU1	
Dual Power Underside - Black	CU1-1C - add \$610
Dual Power Underside with Wireless Charging - Black	CU1-1CW - add \$1,413
CT2U1	
Dual Power Center Top - Black with Underside	CT2U1-BL - add \$1,868
Dual Power Center Top - White with Underside	CT2U1-WH - add \$1,868
Dual Power Center Top - Black with Wireless Charging	CT2U1-BLW2 - add \$2,670
Dual Power Center Top - White with Wireless Charging	CT2U1-WHW2 - add \$2,670

Note: Order power infeed that best fits application

To Order Specify

① Veneer Model #	② Edge Detail	③ Wood Collection	④ Wood Finish	⑤ Electrical	⑥ Metal Color
Veneer (LKV)	See Edge Detail Options	Essentials	See Essentials Wood Finish Options	N None CT2 Dual Power Center Top CU2 Dual Power Underside CT2U1 Dual Power Center Top with Underside (See chart above)	See Metal Finish Color Options
		Artisan	④ Wood Finish See Artisan Wood Finish Options		

① Solid Surface Model #	② Top Surface Selection	③ Electrical	④ Metal Color
Solid Surface (LKS)	See Solid Surface Top Surface Selection Options	N None CT2 Dual Power Center Top CU2 Dual Power Underside CT2U1 Dual Power Center Top with Underside (See chart above)	See Metal Finish Color Options

LOK - CONFERENCE

Description

Oval Table with Y Base at Bar Height

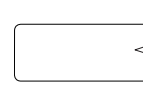
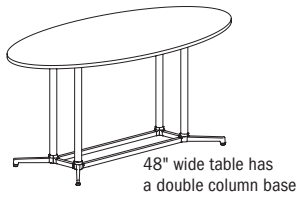

Eased Edge (R3)

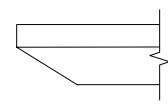

Reverse Bevel Edge (K9)

Laminate Tables
"LKT" Models

LAMINATE	D	W	H	CTN WT	CU FT	Model	Standard Tier 1	Graded In Tier 2	Standard Tier 1	Graded In Tier 2
		48	96	42	198	132	LKT4896-42OVY	\$3,171	\$3,222	\$3,656
	42	84	42	153	103	LKT4284-42OVY	\$2,703	\$2,743	\$3,167	\$3,207

Features:

- price reflects complete table - top and base
- ships KD in multiple cartons
- one piece top
- model includes adjustable glide

Options:

- specify power/charging option, see below for options and upcharges

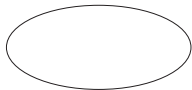
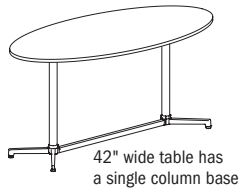

top shape

LOK - CONFERENCE

To Order Specify

1 Laminate Model #	2 Edge Detail	3 Laminate Selection	3a PVC Edge Color	4 Electrical	5 Metal Color
Laminate (LKT)	See Edge Detail Options	See Laminate Selection	See PVC Edge Color Options	N None CT2 Dual Power Center Top CU2 Dual Power Underside CT2U1 Dual Power Center Top with Underside (See chart on next page)	See Metal Finish Color Options

Model Number Breakdown

LKT4896-42OVY					
LK	T	4896	42	OV	Y
LOK	Laminate	48" x 96"	Height	Oval Top Shape	Y Base

Description

Oval Table with Y Base at Bar Height
(continued)

Veneer Tables
"LKV" Models

Solid Surface Tables
"LKS" Models

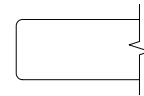

Eased Edge (R3)

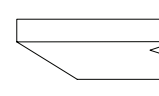

Reverse Bevel Edge (K9)

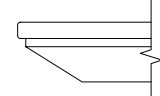

Reverse Bevel Edge (K7)

	D	W	H	CTN WT	CU FT	① Model	Veneer Tables "LKV" Models		Solid Surface Tables "LKS" Models		
							Essentials	Artisan	Essentials	Artisan	Standard
VENEER	48	96	42	198	132	LKV4896-420VY	\$4,423	\$4,772	\$4,743	\$5,067	--
	42	84	42	153	103	LKV4284-420VY	\$4,038	\$4,360	\$4,402	\$4,686	--
SOL. SURF.	48	96	42	198	132	LKS4896-420VY	--	--	--	--	\$10,481
	42	84	42	153	103	LKS4284-420VY	--	--	--	--	\$7,920

Electrical Options and Upcharges

CT2	84 - 96 wide
Dual Power Center Top - Black	CT2BL - add \$1,535
Dual Power Center Top - White	CT2WH - add \$1,535
CU1	
Dual Power Underside - Black	CU1-1C - add \$610
Dual Power Underside with Wireless Charging - Black	CU1-1CW - add \$1,413
CT2U1	
Dual Power Center Top - Black with Underside	CT2U1-BL - add \$1,868
Dual Power Center Top - White with Underside	CT2U1-WH - add \$1,868
Dual Power Center Top - Black with Wireless Charging	CT2U1-BLW2 - add \$2,670
Dual Power Center Top - White with Wireless Charging	CT2U1-WHW2 - add \$2,670

Note: Order power infeed that best fits application

To Order Specify

① Veneer Model #	② Edge Detail	③ Wood Collection	④ Wood Finish	⑤ Electrical	⑥ Metal Color
Veneer (LKV)	See Edge Detail Options	Essentials	See Essentials Wood Finish Options	N None CT2 Dual Power Center Top CU2 Dual Power Underside CT2U1 Dual Power Center Top with Underside (See chart above)	See Metal Finish Color Options
		Artisan	④ Wood Finish See Artisan Wood Finish Options		

① Solid Surface Model #	② Top Surface Selection	③ Electrical	④ Metal Color
Solid Surface (LKS)	See Solid Surface Top Surface Selection Options	N None CT2 Dual Power Center Top CU2 Dual Power Underside CT2U1 Dual Power Center Top with Underside (See chart above)	See Metal Finish Color Options

LOK - CONFERENCE

Description

Boat Table with T Base at Bar Height

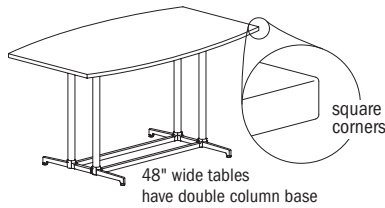

Laminate Tables "LKT" Models

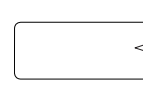

Eased Edge (R3)

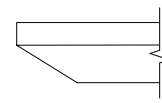

Reverse Bevel Edge (K9)

LAMINATE	D	W	H	CTN WT	CU FT	Model	Eased Edge (R3)		Reverse Bevel Edge (K9)	
							Standard Tier 1	Graded In Tier 2	Standard Tier 1	Graded In Tier 2
	48	96	42	216	132	LKT4896-42BTT	\$3,501	\$3,555	\$3,988	\$4,043
48	84	42	210	117	LKT4884-42BTT	\$3,189	\$3,236	\$3,664	\$3,708	
42	96	42	183	118	LKT4296-42BTT	\$3,108	\$3,154	\$3,583	\$3,629	
42	84	42	209	105	LKT4284-42BTT	\$3,186	\$3,226	\$3,649	\$3,691	
36	96	42	162	102	LKT3696-42BTT	\$2,641	\$2,682	\$3,103	\$3,143	
36	84	42	146	90	LKT3684-42BTT	\$2,387	\$2,422	\$2,839	\$2,874	

Features:

- price reflects complete table - top and base
- ships KD in multiple cartons
- one piece top
- model includes adjustable glide

Options:

- specify power/charging option, see below for options and upcharges

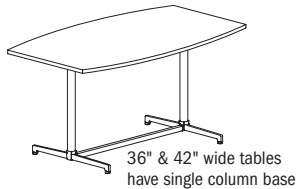

top shape

To Order Specify

1 Laminate Model #	2 Edge Detail	3 Laminate Selection	3a PVC Edge Color	4 Electrical	5 Metal Color
Laminate (LKT)	See Edge Detail Options	See Laminate Selection	See PVC Edge Color Options	N None CT2 Dual Power Center Top CU2 Dual Power Underside CT2U1 Dual Power Center Top with Underside (See chart on next page)	See Metal Finish Color Options

Model Number Breakdown

LKT4896-42BTT					
LK	T	4896	42	BT	T
LOK	Laminate	48" x 96"	Height	Boat Top Shape	T Base

Description

Boat Table with T Base at Bar Height
(continued)

Veneer Tables
"LKV" Models

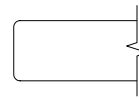

Eased Edge (R3)

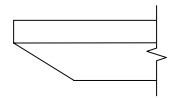

Reverse Bevel Edge (K9)

D	W	H	CTN WT	CU FT	① Model	Essentials		Artisan	
						Essentials	Artisan	Essentials	Artisan
48	96	42	216	132	LKV4896-42BTT	\$4,849	\$5,197	\$5,165	\$5,489
48	84	42	210	117	LKV4884-42BTT	\$4,507	\$4,806	\$4,803	\$5,084
42	96	42	183	118	LKV4296-42BTT	\$4,607	\$4,973	\$5,020	\$5,345
	84	42	209	105	LKV4284-42BTT	\$4,628	\$4,998	\$5,045	\$5,373
36	96	42	162	102	LKV3696-42BTT	\$3,551	\$3,833	\$3,869	\$4,120
36	84	42	146	90	LKV3684-42BTT	\$3,282	\$3,544	\$3,576	\$3,810

VENEER

Electrical Options and Upcharges

CT2	84 - 96 wide
Dual Power Center Top - Black	CT2BL - add \$1,535
Dual Power Center Top - White	CT2WH - add \$1,535
CU1	
Dual Power Underside - Black	CU1-1C - add \$610
Dual Power Underside with Wireless Charging - Black	CU1-1CW - add \$1,413
CT2U1	
Dual Power Center Top - Black with Underside	CT2U1-BL - add \$1,868
Dual Power Center Top - White with Underside	CT2U1-WH - add \$1,868
Dual Power Center Top - Black with Wireless Charging	CT2U1-BLW2 - add \$2,670
Dual Power Center Top - White with Wireless Charging	CT2U1-WHW2 - add \$2,670

Note: Order power infeed that best fits application

To Order Specify

① Veneer Model #	② Edge Detail	③ Wood Collection	④ Wood Finish	⑤ Electrical	⑥ Metal Color
Veneer (LKV)	See Edge Detail Options	Essentials	See Essentials Wood Finish Options	N None CT2 Dual Power Center Top CU2 Dual Power Underside CT2U1 Dual Power Center Top with Underside (See chart above)	See Metal Finish Color Options
		Artisan	④ Wood Finish See Artisan Wood Finish Options		

LOK - CONFERENCE

Description

Boat Table with Y Base at Bar Height

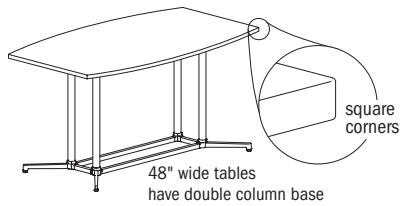

Laminate Tables
"LKT" Models

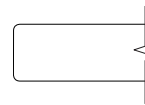

Eased Edge (R3)

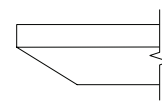

Reverse Bevel Edge (K9)

LAMINATE	D	W	H	CTN WT	CU FT	Model	Eased Edge (R3)		Reverse Bevel Edge (K9)	
							Standard	Graded In	Standard	Graded In
							Tier 1	Tier 2	Tier 1	Tier 2
	48	96	42	231	132	LKT4896-42BTY	\$3,418	\$3,471	\$3,904	\$3,958
	48	84	42	209	117	LKT4884-42BTY	\$3,017	\$3,065	\$3,494	\$3,540
	42	96	42	198	118	LKT4296-42BTY	\$3,868	\$3,913	\$4,341	\$4,388
	42	84	42	175	103	LKT4284-42BTY	\$2,703	\$2,743	\$3,167	\$3,207
	36	96	42	175	102	LKT3696-42BTY	\$2,716	\$2,756	\$3,176	\$3,217
	36	84	42	156	90	LKT3684-42BTY	\$2,418	\$2,454	\$2,870	\$2,906

Features:

- price reflects complete table - top and base
- ships KD in multiple cartons
- one piece top
- model includes adjustable glide

Options:

- specify power/charging option, see below for options and upcharges

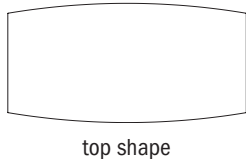
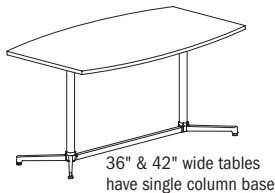

top shape

LOK - CONFERENCE

To Order Specify

1 Laminite Model #	2 Edge Detail	3 Laminite Selection	3a PVC Edge Color	4 Electrical	5 Metal Color
Laminite (LKT)	See Edge Detail Options	See Laminite Selection	See PVC Edge Color Options	N None CT2 Dual Power Center Top CU2 Dual Power Underside CT2U1 Dual Power Center Top with Underside (See chart on next page)	See Metal Finish Color Options

Model Number Breakdown

LKT4896-42BTY					
LK	T	4896	42	BT	Y
LOK	Laminite	48" x 96"	Height	Boat Top Shape	Y Base

Description

Boat Table with Y Base at Bar Height
(continued)

Veneer Tables
"LKV" Models

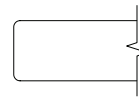

Eased Edge (R3)

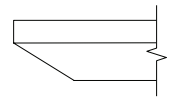

Reverse Bevel Edge (K9)

D	W	H	CTN WT	CU FT	① Model	Essentials		Artisan	
						Essentials	Artisan	Essentials	Artisan
48	96	42	231	132	LKV4896-42BTY	\$4,741	\$5,087	\$5,058	\$5,381
48	84	42	209	117	LKV4884-42BTY	\$4,294	\$4,594	\$4,589	\$4,869
42	96	42	198	118	LKV4296-42BTY	\$5,555	\$6,000	\$6,056	\$6,449
	84	42	175	103	LKV4284-42BTY	\$4,038	\$4,360	\$4,402	\$4,686
36	96	42	175	102	LKV3696-42BTY	\$3,641	\$3,933	\$3,968	\$4,227
36	84	42	156	90	LKV3684-42BTY	\$3,321	\$3,588	\$3,619	\$3,856

VENEER

Electrical Options and Upcharges

CT2	84 - 96 wide
Dual Power Center Top - Black	CT2BL - add \$1,535
Dual Power Center Top - White	CT2WH - add \$1,535
CU1	
Dual Power Underside - Black	CU1-1C - add \$610
Dual Power Underside with Wireless Charging - Black	CU1-1CW - add \$1,413
CT2U1	
Dual Power Center Top - Black with Underside	CT2U1-BL - add \$1,868
Dual Power Center Top - White with Underside	CT2U1-WH - add \$1,868
Dual Power Center Top - Black with Wireless Charging	CT2U1-BLW2 - add \$2,670
Dual Power Center Top - White with Wireless Charging	CT2U1-WHW2 - add \$2,670

Note: Order power infeed that best fits application

To Order Specify

① Veneer Model #	② Edge Detail	③ Wood Collection	④ Wood Finish	⑤ Electrical	⑥ Metal Color
Veneer (LKV)	See Edge Detail Options	Essentials	See Essentials Wood Finish Options	N None CT2 Dual Power Center Top CU2 Dual Power Underside CT2U1 Dual Power Center Top with Underside (See chart above)	See Metal Finish Color Options
		Artisan	④ Wood Finish See Artisan Wood Finish Options		

LOK - CONFERENCE

Description

Rounded Double Chevron Table with T Base at Bar Height

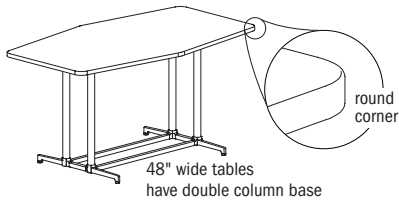

Laminate Tables
"LKT" Models

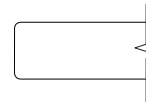

Eased Edge (R3)

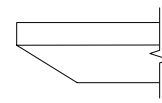

Reverse Bevel Edge (K9)

LAMINATE	D	W	H	CTN WT	CU FT	① Model	Eased Edge (R3)		Reverse Bevel Edge (K9)	
							Standard Tier 1	Graded In Tier 2	Standard Tier 1	Graded In Tier 2
	48	96	42	216	132	LKT4896-42DCRT	\$3,501	\$3,555	\$3,988	\$4,043
	48	84	42	195	117	LKT4884-42DCRT	\$3,189	\$3,236	\$3,664	\$3,708
	42	96	42	189	118	LKT4296-42DCRT	\$3,108	\$3,154	\$3,583	\$3,629
	42	84	42	195	105	LKT4284-42DCRT	\$3,186	\$3,226	\$3,649	\$3,691
	36	96	42	152	102	LKT3696-42DCRT	\$2,641	\$2,682	\$3,103	\$3,143
	36	84	42	135	90	LKT3684-42DCRT	\$2,387	\$2,422	\$2,839	\$2,874

Features:

- price reflects complete table - top and base
- ships KD in multiple cartons
- one piece top
- model includes adjustable glide

Options:

- specify power/charging option, see below for options and upcharges

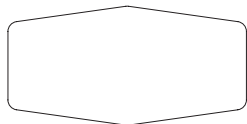
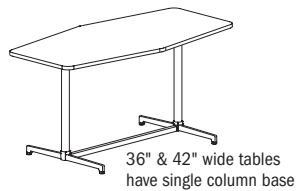

top shape

LOK - CONFERENCE

To Order Specify

① Laminate Model #	② Edge Detail	③ Laminate Selection	④ PVC Edge Color	⑤ Electrical	⑥ Metal Color
Laminate (LKT)	See Edge Detail Options	See Laminate Selection	See PVC Edge Color Options	N None CT2 Dual Power Center Top CU2 Dual Power Underside CT2U1 Dual Power Center Top with Underside (See chart on next page)	See Metal Finish Color Options

Model Number Breakdown

LKT4896-42DCRT						
LK	T	4896	42	DC	R	T
LOK	Laminate	48" x 96"	Height	Double Chevron Top Shape	Rounded Corner	T Base

Description

Rounded Double Chevron Table with T Base at Bar Height (continued)

Veneer Tables "LKV" Models Solid Surface Tables "LKS" Models

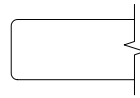

Eased Edge (R3)

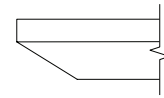

Reverse Bevel Edge (K9)

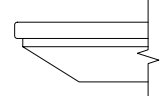

Reverse Bevel Edge (K7)

	D	W	H	CTN WT	CU FT	① Model	Veneer Tables		Solid Surface Tables		
							Essentials	Artisan	Essentials	Artisan	Standard
VENEER	48	96	42	216	132	LKV4896-42DCRT	\$4,849	\$5,197	\$5,165	\$5,489	--
	48	84	42	195	117	LKV4884-42DCRT	\$4,507	\$4,806	\$4,803	\$5,084	--
	42	96	42	189	118	LKV4296-42DCRT	\$4,607	\$4,973	\$5,020	\$5,345	--
	42	84	42	195	105	LKV4284-42DCRT	\$4,628	\$4,998	\$5,045	\$5,373	--
	36	96	42	152	102	LKV3696-42DCRT	\$3,551	\$3,833	\$3,869	\$4,120	--
	36	84	42	135	90	LKV3684-42DCRT	\$3,282	\$3,544	\$3,576	\$3,810	--
SOLID SURFACE	48	96	42	216	132	LKS4896-42DCRT	--	--	--	--	\$10,904
	48	84	42	195	117	LKS4884-42DCRT	--	--	--	--	\$9,763
	42	96	42	189	118	LKS4296-42DCRT	--	--	--	--	\$8,807
	42	84	42	195	105	LKS4284-42DCRT	--	--	--	--	\$8,513
	36	96	42	152	102	LKS3696-42DCRT	--	--	--	--	\$7,762
	36	84	42	135	90	LKS3684-42DCRT	--	--	--	--	\$7,014

Electrical Options and Upcharges

CT2	84 - 96 wide
Dual Power Center Top - Black	CT2BL - add \$1,535
Dual Power Center Top - White	CT2WH - add \$1,535
CU1	
Dual Power Underside - Black	CU1-1C - add \$610
Dual Power Underside with Wireless Charging - Black	CU1-1CW - add \$1,413
CT2U1	
Dual Power Center Top - Black with Underside	CT2U1-BL - add \$1,868
Dual Power Center Top - White with Underside	CT2U1-WH - add \$1,868
Dual Power Center Top - Black with Wireless Charging	CT2U1-BLW2 - add \$2,670
Dual Power Center Top - White with Wireless Charging	CT2U1-WHW2 - add \$2,670

Note: Order power infeed that best fits application

To Order Specify

① Veneer Model #	② Edge Detail	③ Wood Collection	④ Wood Finish	⑤ Electrical	⑥ Metal Color
Veneer (LKV)	See Edge Detail Options	Essentials	See Essentials Wood Finish Options	N None CT2 Dual Power Center Top CU2 Dual Power Underside CT2U1 Dual Power Center Top with Underside (See chart above)	See Metal Finish Color Options
		Artisan	④ Wood Finish See Artisan Wood Finish Options		

① Solid Surface Model #	② Top Surface Selection	③ Electrical	④ Metal Color
Solid Surface (LKS)	See Solid Surface Top Surface Selection Options	N None CT2 Dual Power Center Top CU2 Dual Power Underside CT2U1 Dual Power Center Top with Underside (See chart above)	See Metal Finish Color Options

LOK - CONFERENCE

Description

Rounded Double Chevron Table with Y Base at Bar Height

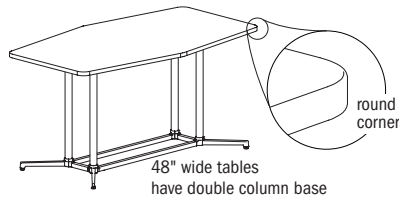

Laminate Tables "LKT" Models

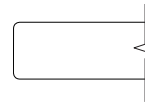

Eased Edge (R3)

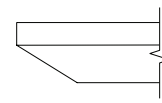

Reverse Bevel Edge (K9)

LAMINATE	D	W	H	CTN WT	CU FT	Model	Eased Edge (R3)		Reverse Bevel Edge (K9)	
							Standard Tier 1	Graded In Tier 2	Standard Tier 1	Graded In Tier 2
		48	96	42	211	132	LKT4896-42DCRY	\$3,418	\$3,471	\$3,904
	48	84	42	194	117	LKT4884-42DCRY	\$3,017	\$3,065	\$3,494	\$3,540
	42	96	42	175	118	LKT4296-42DCRY	\$3,868	\$3,913	\$4,341	\$4,388
	42	84	42	159	103	LKT4284-42DCRY	\$2,703	\$2,743	\$3,167	\$3,207
	36	96	42	175	102	LKT3696-42DCRY	\$2,716	\$2,756	\$3,176	\$3,217
	36	84	42	154	90	LKT3684-42DCRY	\$2,418	\$2,454	\$2,870	\$2,906

Features:

- price reflects complete table - top and base
- ships KD in multiple cartons
- one piece top
- model includes adjustable glide

Options:

- specify power/charging option, see below for options and upcharges

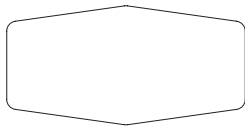
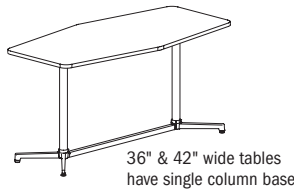

top shape

LOK - CONFERENCE

To Order Specify

1 Laminate Model #	2 Edge Detail	3 Laminate Selection	3a PVC Edge Color	4 Electrical	5 Metal Color
Laminate (LKT)	See Edge Detail Options	See Laminate Selection	See PVC Edge Color Options	N None CT2 Dual Power Center Top CU2 Dual Power Underside CT2U1 Dual Power Center Top with Underside (See chart on next page)	See Metal Finish Color Options

Model Number Breakdown

LKT4896-42DCRY						
LK	T	4896	42	DC	R	Y
LOK	Laminate	48" x 96"	Height	Double Chevron Top Shape	Rounded Corner	Y Base

Description

Rounded Double Chevron Table with Y Base at Bar Height (continued)

Veneer Tables "LKV" Models Solid Surface Tables "LKS" Models

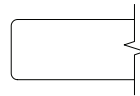

Eased Edge (R3)

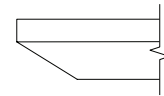

Reverse Bevel Edge (K9)

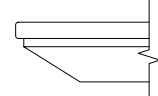

Reverse Bevel Edge (K7)

	D	W	H	CTN WT	CU FT	① Model	Veneer Tables		Solid Surface Tables		
							Essentials	Artisan	Essentials	Artisan	Standard
VENEER	48	96	42	211	132	LKV4896-42DCRY	\$4,741	\$5,087	\$5,058	\$5,381	--
	48	84	42	194	117	LKV4884-42DCRY	\$4,294	\$4,594	\$4,589	\$4,869	--
	42	96	42	175	118	LKV4296-42DCRY	\$5,555	\$6,000	\$6,056	\$6,449	--
	42	84	42	159	103	LKV4284-42DCRY	\$4,038	\$4,360	\$4,402	\$4,686	--
	36	96	42	175	102	LKV3696-42DCRY	\$3,641	\$3,933	\$3,968	\$4,227	--
	36	84	42	154	90	LKV3684-42DCRY	\$3,321	\$3,588	\$3,619	\$3,856	--
SOLID SURFACE	48	96	42	211	132	LKS4896-42DCRY	--	--	--	--	\$10,797
	48	84	42	194	117	LKS4884-42DCRY	--	--	--	--	\$9,549
	42	96	42	175	118	LKS4296-42DCRY	--	--	--	--	\$9,756
	42	84	42	159	103	LKS4284-42DCRY	--	--	--	--	\$7,920
	36	96	42	175	102	LKS3696-42DCRY	--	--	--	--	\$7,850
	36	84	42	154	90	LKS3684-42DCRY	--	--	--	--	\$7,056

Electrical Options and Upcharges

CT2	84 - 96 wide
Dual Power Center Top - Black	CT2BL - add \$1,535
Dual Power Center Top - White	CT2WH - add \$1,535
CU1	
Dual Power Underside - Black	CU1-1C - add \$610
Dual Power Underside with Wireless Charging - Black	CU1-1CW - add \$1,413
CT2U1	
Dual Power Center Top - Black with Underside	CT2U1-BL - add \$1,868
Dual Power Center Top - White with Underside	CT2U1-WH - add \$1,868
Dual Power Center Top - Black with Wireless Charging	CT2U1-BLW2 - add \$2,670
Dual Power Center Top - White with Wireless Charging	CT2U1-WHW2 - add \$2,670

Note: Order power infeed that best fits application

To Order Specify

① Veneer Model #	② Edge Detail	③ Wood Collection	④ Wood Finish	⑤ Electrical	⑥ Metal Color
Veneer (LKV)	See Edge Detail Options	Essentials	See Essentials Wood Finish Options	N None CT2 Dual Power Center Top CU2 Dual Power Underside CT2U1 Dual Power Center Top with Underside (See chart above)	See Metal Finish Color Options
		Artisan	④ Wood Finish See Artisan Wood Finish Options		

① Solid Surface Model #	② Top Surface Selection	③ Electrical	④ Metal Color
Solid Surface (LKS)	See Solid Surface Top Surface Selection Options	N None CT2 Dual Power Center Top CU2 Dual Power Underside CT2U1 Dual Power Center Top with Underside (See chart above)	See Metal Finish Color Options

LOK - CONFERENCE

Description

Taper Table with T Base at Bar Height

Laminate Tables
"LKT" Models

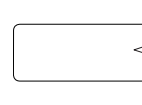
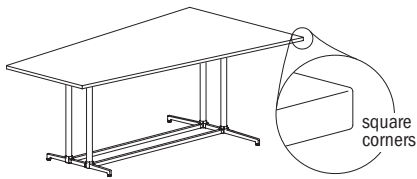

Eased Edge (R3)

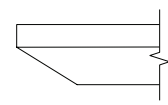

Reverse Bevel Edge (K9)

LAMI	D	W	H	CTN WT	CU FT	Model	Standard Tier 1	Graded In Tier 2	Standard Tier 1	Graded In Tier 2
		54	96	42	228	147	LKT5496-42TPT	\$3,745	\$3,805	\$4,244

Features:

- price reflects complete table - top and base
- ships KD in multiple cartons
- one piece top
- model includes adjustable glide

Options:

- specify power/charging option, see below for options and upcharges

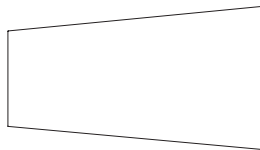

top shape

LOK - CONFERENCE

To Order Specify

1 Laminite Model #	2 Edge Detail	3 Laminite Selection	3a PVC Edge Color	4 Electrical	5 Metal Color
Laminite (LKT)	See Edge Detail Options	See Laminite Selection	See PVC Edge Color Options	N None CT2 Dual Power Center Top CU2 Dual Power Underside CT2U1 Dual Power Center Top with Underside (See chart on next page)	See Metal Finish Color Options

Model Number Breakdown

LKT5496-42TPT					
LK	T	5496	42	TP	T
LOK	Laminite	54" x 96"	Height	Taper Top Shape	T Base

Description

Taper Table with T Base at Bar Height
(continued)

Veneer Tables
"LKV" Models

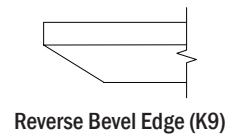
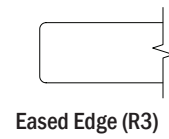

VEN.	D	W	H	CTN WT	CU FT	① Model	Essentials	Artisan	Essentials	Artisan
		54	96	42	228	147	LKV5496-42TPT	\$5,112	\$5,519	\$5,571

Electrical Options and Upcharges

CT2	84 - 96 wide
Dual Power Center Top - Black	CT2BL - add \$1,535
Dual Power Center Top - White	CT2WH - add \$1,535
CU1	
Dual Power Underside - Black	CU1-1C - add \$610
Dual Power Underside with Wireless Charging - Black	CU1-1CW - add \$1,413
CT2U1	
Dual Power Center Top - Black with Underside	CT2U1-BL - add \$1,868
Dual Power Center Top - White with Underside	CT2U1-WH - add \$1,868
Dual Power Center Top - Black with Wireless Charging	CT2U1-BLW2 - add \$2,670
Dual Power Center Top - White with Wireless Charging	CT2U1-WHW2 - add \$2,670

Note: Order power infeed that best fits application

To Order Specify

① Veneer Model #	② Edge Detail	③ Wood Collection	④ Wood Finish	⑤ Electrical	⑥ Metal Color
Veneer (LKV)	See Edge Detail Options	Essentials	See Essentials Wood Finish Options	N None CT2 Dual Power Center Top CU2 Dual Power Underside CT2U1 Dual Power Center Top with Underside (See chart above)	See Metal Finish Color Options
		Artisan	④ Wood Finish See Artisan Wood Finish Options		

LOK - CONFERENCE

Description

Rounded Taper Table with T Base at Bar Height

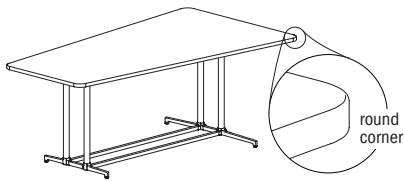

Laminate Tables "LKT" Models

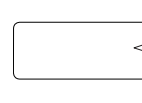

Eased Edge (R3)

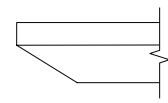

Reverse Bevel Edge (K9)

LAMI	D	W	H	CTN WT	CU FT	Model	Standard Tier 1	Graded In Tier 2	Standard Tier 1	Graded In Tier 2
		54	96	42	228	147	LKT5496-42TPRT	\$3,745	\$3,805	\$4,244

Features:

- price reflects complete table - top and base
- ships KD in multiple cartons
- one piece top
- model includes adjustable glide

Options:

- specify power/charging option, see below for options and upcharges

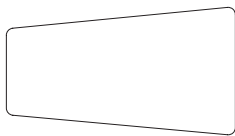

top shape

LOK - CONFERENCE

To Order Specify

1 Laminate Model #	2 Edge Detail	3 Laminate Selection	3a PVC Edge Color	4 Electrical	5 Metal Color
Laminate (LKT)	See Edge Detail Options	See Laminate Selection	See PVC Edge Color Options	N None CT2 Dual Power Center Top CU2 Dual Power Underside CT2U1 Dual Power Center Top with Underside (See chart on next page)	See Metal Finish Color Options

Model Number Breakdown

LKT5496-42TPRT						
LK	T	5496	42	TP	R	T
LOK	Laminate	54" x 96"	Height	Taper Top Shape	Rounded Corner	T Base

Description

Rounded Taper Table with T
Base at Bar Height
(continued)

Veneer Tables "LKV" Models	Solid Surface Tables "LKS" Models
-------------------------------	--------------------------------------

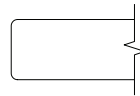

Eased Edge (R3)

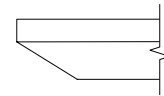

Reverse Bevel Edge (K9)

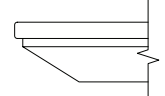

Reverse Bevel Edge (K7)

	D	W	H	CTN WT	CU FT	① Model	Essentials	Artisan	Essentials	Artisan	Standard
VEN.	54	96	42	228	147	LKV5496-42TPRT	\$5,112	\$5,519	\$5,571	\$5,932	--
S.S.	54	96	42	228	147	LKS5496-42TPRT	--	--	--	--	\$14,160

Electrical Options and Upcharges

CT2	84 - 96 wide
Dual Power Center Top - Black	CT2BL - add \$1,535
Dual Power Center Top - White	CT2WH - add \$1,535
CU1	
Dual Power Underside - Black	CU1-1C - add \$610
Dual Power Underside with Wireless Charging - Black	CU1-1CW - add \$1,413
CT2U1	
Dual Power Center Top - Black with Underside	CT2U1-BL - add \$1,868
Dual Power Center Top - White with Underside	CT2U1-WH - add \$1,868
Dual Power Center Top - Black with Wireless Charging	CT2U1-BLW2 - add \$2,670
Dual Power Center Top - White with Wireless Charging	CT2U1-WHW2 - add \$2,670

LOK - CONFERENCE

Note: Order power infeed that best fits application

To Order Specify

① Veneer Model #	② Edge Detail	③ Wood Collection	④ Wood Finish	⑤ Electrical	⑥ Metal Color
Veneer (LKV)	See Edge Detail Options	Essentials	See Essentials Wood Finish Options	N None CT2 Dual Power Center Top CU2 Dual Power Underside CT2U1 Dual Power Center Top with Underside (See chart above)	See Metal Finish Color Options
		Artisan	④ Wood Finish See Artisan Wood Finish Options		

① Solid Surface Model #	② Top Surface Selection	③ Electrical	④ Metal Color
Solid Surface (LKS)	See Solid Surface Top Surface Selection Options	N None CT2 Dual Power Center Top CU2 Dual Power Underside CT2U1 Dual Power Center Top with Underside (See chart above)	See Metal Finish Color Options

Description

Taper Table with Y Base at Bar Height

Laminate Tables
"LKT" Models

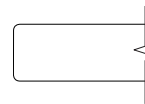
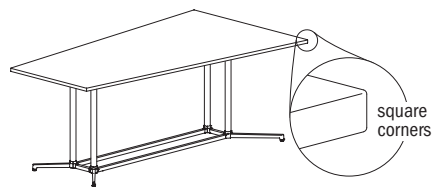

Eased Edge (R3)

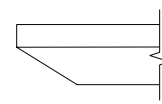

Reverse Bevel Edge (K9)

LAMI	D	W	H	CTN WT	CU FT	Model	Standard Tier 1	Graded In Tier 2	Standard Tier 1	Graded In Tier 2
		54	96	42	198	147	LKT5496-42TPY	\$3,625	\$3,683	\$4,124

Features:

- price reflects complete table - top and base
- ships KD in multiple cartons
- one piece top
- model includes adjustable glide

Options:

- specify power/charging option, see below for options and upcharges

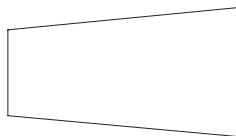

top shape

To Order Specify

1 Laminate Model #	2 Edge Detail	3 Laminate Selection	3a PVC Edge Color	4 Electrical	5 Metal Color
Laminate (LKT)	See Edge Detail Options	See Laminate Selection	See PVC Edge Color Options	N None CT2 Dual Power Center Top CU2 Dual Power Underside CT2U1 Dual Power Center Top with Underside (See chart on next page)	See Metal Finish Color Options

Model Number Breakdown

LKT5496-42TPY					
LK	T	5496	42	TP	Y
LOK	Laminate	54" x 96"	Height	Taper Top Shape	Y Base

Description

Taper Table with Y Base at Bar Height
(continued)

Veneer Tables
"LKV" Models

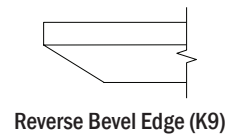
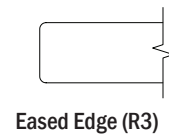

VEN.	D	W	H	CTN WT	CU FT	① Model	Essentials	Artisan	Essentials	Artisan
		54	96	42	198	147	LKV5496-42TPY	\$4,964	\$5,362	\$5,412

Electrical Options and Upcharges

CT2	84 - 96 wide
Dual Power Center Top - Black	CT2BL - add \$1,535
Dual Power Center Top - White	CT2WH - add \$1,535
CU1	
Dual Power Underside - Black	CU1-1C - add \$610
Dual Power Underside with Wireless Charging - Black	CU1-1CW - add \$1,413
CT2U1	
Dual Power Center Top - Black with Underside	CT2U1-BL - add \$1,868
Dual Power Center Top - White with Underside	CT2U1-WH - add \$1,868
Dual Power Center Top - Black with Wireless Charging	CT2U1-BLW2 - add \$2,670
Dual Power Center Top - White with Wireless Charging	CT2U1-WHW2 - add \$2,670

Note: Order power infeed that best fits application

To Order Specify

① Veneer Model #	② Edge Detail	③ Wood Collection	④ Wood Finish	⑤ Electrical	⑥ Metal Color
Veneer (LKV)	See Edge Detail Options	Essentials	See Essentials Wood Finish Options	N None CT2 Dual Power Center Top CU2 Dual Power Underside CT2U1 Dual Power Center Top with Underside (See chart above)	See Metal Finish Color Options
		Artisan	④ Wood Finish See Artisan Wood Finish Options		

Description

Rounded Taper Table with Y Base at Bar Height

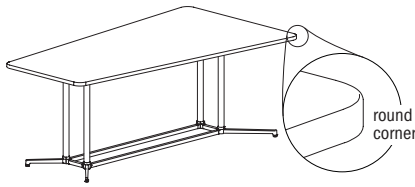

Laminate Tables "LKT" Models

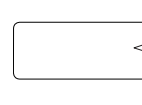

Eased Edge (R3)

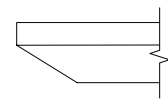

Reverse Bevel Edge (K9)

LAMI	D	W	H	CTN WT	CU FT	Model	Standard Tier 1	Graded In Tier 2	Standard Tier 1	Graded In Tier 2
		54	96	42	198	147	LKT5496-42TPRY	\$3,625	\$3,683	\$4,124

Features:

- price reflects complete table - top and base
- ships KD in multiple cartons
- one piece top
- model includes adjustable glide

Options:

- specify power/charging option, see below for options and upcharges

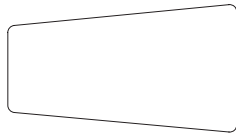

top shape

LOK - CONFERENCE

To Order Specify

1 Laminate Model #	2 Edge Detail	3 Laminate Selection	3a PVC Edge Color	4 Electrical	5 Metal Color
Laminate (LKT)	See Edge Detail Options	See Laminate Selection	See PVC Edge Color Options	N None CT2 Dual Power Center Top CU2 Dual Power Underside CT2U1 Dual Power Center Top with Underside (See chart on next page)	See Metal Finish Color Options

Model Number Breakdown

LKT5496-42TPRY						
LK	T	5496	42	TP	R	Y
LOK	Laminate	54" x 96"	Height	Taper Top Shape	Rounded Corner	Y Base

Description

Rounded Taper Table with Y Base at Bar Height (continued)

Veneer Tables "LKV" Models Solid Surface Tables "LKS" Models

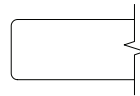

Eased Edge (R3)

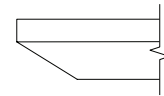

Reverse Bevel Edge (K9)

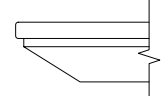

Reverse Bevel Edge (K7)

	D	W	H	CTN WT	CU FT	Model	Essentials	Artisan	Essentials	Artisan	Standard
VEN.	54	96	42	198	147	LKV5496-42TPRY	\$4,964	\$5,362	\$5,412	\$5,761	--
S.S.	54	96	42	198	147	LKS5496-42TPRY	--	--	--	--	\$14,013

Electrical Options and Upcharges

CT2	84 - 96 wide
Dual Power Center Top - Black	CT2BL - add \$1,535
Dual Power Center Top - White	CT2WH - add \$1,535
CU1	
Dual Power Underside - Black	CU1-1C - add \$610
Dual Power Underside with Wireless Charging - Black	CU1-1CW - add \$1,413
CT2U1	
Dual Power Center Top - Black with Underside	CT2U1-BL - add \$1,868
Dual Power Center Top - White with Underside	CT2U1-WH - add \$1,868
Dual Power Center Top - Black with Wireless Charging	CT2U1-BLW2 - add \$2,670
Dual Power Center Top - White with Wireless Charging	CT2U1-WHW2 - add \$2,670

LOK - CONFERENCE

Note: Order power infeed that best fits application

To Order Specify

1 Veneer Model #	2 Edge Detail	3 Wood Collection	4 Wood Finish	5 Electrical	6 Metal Color
Veneer (LKV)	See Edge Detail Options	Essentials	See Essentials Wood Finish Options	N None CT2 Dual Power Center Top CU2 Dual Power Underside CT2U1 Dual Power Center Top with Underside (See chart above)	See Metal Finish Color Options
		Artisan	4 Wood Finish See Artisan Wood Finish Options		

1 Solid Surface Model #	2 Top Surface Selection	3 Electrical	4 Metal Color
Solid Surface (LKS)	See Solid Surface Top Surface Selection Options	N None CT2 Dual Power Center Top CU2 Dual Power Underside CT2U1 Dual Power Center Top with Underside (See chart above)	See Metal Finish Color Options

Description

Round Table with X Base at Bar Height



Laminate Tables
"LKT" Models

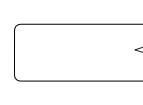

Eased Edge (R3)

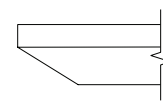

Reverse Bevel Edge (K9)

LAMINATE	D	W	H	CTN WT	CU FT	1 Model	Eased Edge (R3)		Reverse Bevel Edge (K9)	
							Standard	Graded In	Standard	Graded In
							Tier 1	Tier 2	Tier 1	Tier 2
	48	48	42	90	69	LKT48-42RDX	\$1,749	\$1,871	\$2,217	\$2,340
	42	42	42	75	54	LKT42-42RDX	\$1,609	\$1,730	\$2,079	\$2,200
	36	36	42	60	41	LKT36-42RDX	\$1,560	\$1,605	\$2,030	\$2,075
	30	30	42	50	30	LKT30-42RDX	\$1,507	\$1,542	\$1,976	\$2,012

Features:

- price reflects complete table - top and base
- ships KD in multiple cartons
- one piece top
- model includes adjustable glide
- when electrical option is selected, power accessible base is shipped; see page 178 for details
- power/charging units have 72" cord
- power cord is routed inside base column

Options:

- specify power access base with power unit option; None (N), add \$663 for EC23 (CTEC23), add \$549 for EC24 (CTEC24)

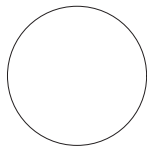

top shape

LOK - CONFERENCE

To Order Specify

1 Laminite Model #	2 Edge Detail	3 Laminite Selection	3a PVC Edge Color	4 Electrical	5 Metal Color
Laminite (LKT)	See Edge Detail Options	See Laminite Selection	See PVC Edge Color Options	N None CTEC23 Power Center Top CTEC24 Power Center Top (See chart on next page)	See Metal Finish Color Options

Model Number Breakdown

LKT48-42RDX					
LK	T	48	42	RD	X
LOK	Laminite	48" dia.	Height	Round Top Shape	X Base

Description

Round Table with X Base at Bar Height
(continued)

Veneer Tables
"LKV" Models

Solid Surface Tables
"LKS" Models

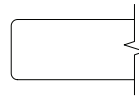

Eased Edge (R3)

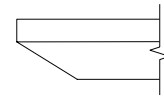

Reverse Bevel Edge (K9)

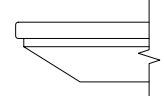

Reverse Bevel Edge (K7)

	D	W	H	CTN WT	CU FT	① Model	Veneer Tables		Solid Surface Tables		
							Essentials	Artisan	Essentials	Artisan	Standard
VENEER	48	48	42	90	69	LKV48-42RDX	\$2,299	\$2,450	\$2,385	\$2,545	--
	42	42	42	75	54	LKV42-42RDX	\$2,110	\$2,249	\$2,190	\$2,336	--
	36	36	42	60	41	LKV36-42RDX	\$2,046	\$2,180	\$2,126	\$2,266	--
	30	30	42	50	30	LKV30-42RDX	\$1,975	\$2,105	\$2,050	\$2,184	--
SOLID SURFACE	48	48	42	90	69	LKS48-42RDX	--	--	--	--	\$5,330
	42	42	42	75	54	LKS42-42RDX	--	--	--	--	\$4,545
	36	36	42	60	41	LKS36-42RDX	--	--	--	--	\$3,967
	30	30	42	50	30	LKS30-42RDX	--	--	--	--	\$3,455

Electrical Options and Upcharges

CTEC23	
EC23 Power Center Top - Black	CTEC23BL - add \$663
EC23 Power Center Top - White	CTEC23WH - add \$663
CTEC24	
EC24 Power Center Top - Black	CTEC43BL - add \$549
EC24 Power Center Top - White	CTEC43WH - add \$549

To Order Specify

① Veneer Model #	② Edge Detail	③ Wood Collection	④ Wood Finish	⑤ Electrical	⑥ Metal Color
Veneer (LKV)	See Edge Detail Options	Essentials	See Essentials Wood Finish Options	N None CTEC23 Power Center Top CTEC24 Power Center Top (See chart above)	See Metal Finish Color Options
		Artisan	④ Wood Finish See Artisan Wood Finish Options		

① Solid Surface Model #	② Top Surface Selection	③ Electrical Cut Out	④ Metal Color
Solid Surface (LKS)	See Solid Surface Top Surface Selection Options	N None CTEC23 Power Center Top CTEC24 Power Center Top (See chart above)	See Metal Finish Color Options

Description

Round Table with X4 Base at Bar Height



Laminate Tables
"LKT" Models

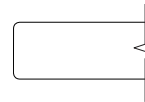

Eased Edge (R3)

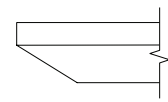

Reverse Bevel Edge (K9)

LAMINATE	D	W	H	CTN WT	CU FT	① Model	Eased Edge (R3)		Reverse Bevel Edge (K9)	
							Standard	Graded In	Standard	Graded In
							Tier 1	Tier 2	Tier 1	Tier 2
	60	60	42	207	94	LKT60-42RDZ	\$2,899	\$2,996	\$3,368	\$3,462
	54	54	42	180	86	LKT54-42RDZ	\$2,715	\$2,791	\$3,183	\$3,258

Features:

- price reflects complete table - top and base
- ships KD in multiple cartons
- one piece top
- model includes adjustable glide
- power cord is routed outside base column
- order vertical wire manager separately; see page 407

Options:

- specify power unit option; None (N), add \$663 for EC23 (CTEC23), add \$549 for EC24 (CTEC24)

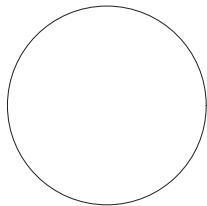

top shape

LOK - CONFERENCE

To Order Specify

① Laminate Model #	② Edge Detail	③ Laminate Selection	④ PVC Edge Color	⑤ Electrical	⑥ Metal Color
Laminate (LKT)	See Edge Detail Options	See Laminate Selection	See PVC Edge Color Options	N None CTEC23 Power Center Top CTEC24 Power Center Top (See chart on next page)	See Metal Finish Color Options

Model Number Breakdown

LKT60-42RDZ					
LK	T	60	42	RD	Z
LOK	Laminate	60" dia.	Height	Round Top Shape	X4 Base

Description

Round Table with X4 Base at Bar Height
(continued)

Veneer Tables
"LKV" Models

Solid Surface Tables
"LKS" Models

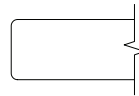

Eased Edge (R3)

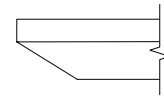

Reverse Bevel Edge (K9)

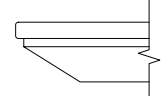

Reverse Bevel Edge (K7)

	D	W	H	CTN WT	CU FT	① Model	Veneer Tables "LKV" Models		Solid Surface Tables "LKS" Models		
							Essentials	Artisan	Essentials	Artisan	Standard
VENEER	60	60	42	207	94	LKV60-42RDZ	\$3,794	\$4,044	\$3,937	\$4,194	--
	54	54	42	180	86	LKV54-42RDZ	\$3,592	\$3,833	\$3,729	\$3,982	--
SOL. SURF.	60	60	42	207	94	LKS60-42RDZ	--	--	--	--	\$8,251
	54	54	42	180	86	LKS54-42RDZ	--	--	--	--	\$7,295

Electrical Options and Upcharges

CTEC23	
EC23 Power Center Top - Black	CTEC23BL - add \$663
EC23 Power Center Top - White	CTEC23WH - add \$663
CTEC24	
EC24 Power Center Top - Black	CTEC43BL - add \$549
EC24 Power Center Top - White	CTEC43WH - add \$549

To Order Specify

① Veneer Model #	② Edge Detail	③ Wood Collection	④ Wood Finish	⑤ Electrical	⑥ Metal Color
Veneer (LKV)	See Edge Detail Options	Essentials	See Essentials Wood Finish Options	N None CTEC23 Power Center Top CTEC24 Power Center Top (See chart above)	See Metal Finish Color Options
		Artisan	④ Wood Finish See Artisan Wood Finish Options		

① Solid Surface Model #	② Top Surface Selection	③ Electrical Cut Out	④ Metal Color
Solid Surface (LKS)	See Solid Surface Top Surface Selection Options	N None CTEC23 Power Center Top CTEC24 Power Center Top (See chart above)	See Metal Finish Color Options

Description

Square Table with X Base
at Bar Height

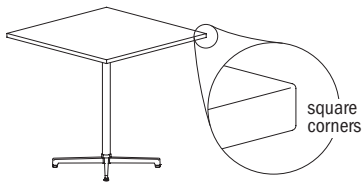

Laminate Tables
"LKT" Models

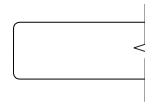

Eased Edge (R3)

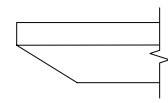

Reverse Bevel Edge (K9)

LAMINATE	D	W	H	CTN WT	CU FT	Model	Standard Tier 1	Graded In Tier 2	Standard Tier 1	Graded In Tier 2
		42	42	42	87	54	LKT4242-42SQX	\$1,647	\$1,701	\$2,117
	36	36	42	70	41	LKT3636-42SQX	\$1,467	\$1,509	\$1,936	\$1,978
	30	30	42	55	30	LKT3030-42SQX	\$1,321	\$1,356	\$1,791	\$1,826

Features:

- price reflects complete table - top and base
- ships KD in multiple cartons
- one piece top
- model includes adjustable glide
- when electrical option is selected, power accessible base is shipped; see page 178 for details
- power/charging units have 72" cord
- power cord is routed inside base column

Options:

- specify power access base with power unit option; None (N), add \$663 for EC23 (CTEC23), add \$549 for EC24 (CTEC24)



top shape

LOK - CONFERENCE

To Order Specify

1 Laminates Model #	2 Edge Detail	3 Laminates Selection	3a PVC Edge Color	4 Electrical	5 Metal Color
Laminates (LKT)	See Edge Detail Options	See Laminates Selection	See PVC Edge Color Options	N None CTEC23 Power Center Top CTEC24 Power Center Top (See chart on next page)	See Metal Finish Color Options

Model Number Breakdown

LKT4242-42SQX					
LK	T	4242	42	SQ	X
LOK	Laminates	42" x 42"	Height	Square Top Shape	X Base

Description

Square Table with X Base at Bar Height
(continued)

Veneer Tables
"LKV" Models

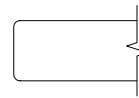

Eased Edge (R3)

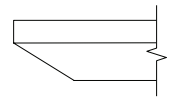

Reverse Bevel Edge (K9)

VENEER	D	W	H	CTN WT	CU FT	① Model	Essentials	Artisan	Essentials	Artisan
	42	42	42	87	54	LKV4242-42SQX	\$2,133	\$2,272	\$2,213	\$2,358
	36	36	42	70	41	LKV3636-42SQX	\$1,895	\$2,018	\$1,965	\$2,093
	30	30	42	55	30	LKV3030-42SQX	\$1,704	\$1,814	\$1,764	\$1,882

LOK- CONFERENCE

Electrical Options and Upcharges

CTEC23	
EC23 Power Center Top - Black	CTEC23BL - add \$663
EC23 Power Center Top - White	CTEC23WH - add \$663
CTEC24	
EC24 Power Center Top - Black	CTEC43BL - add \$549
EC24 Power Center Top - White	CTEC43WH - add \$549

To Order Specify

① Veneer Model #	② Edge Detail	③ Wood Collection	④ Wood Finish	⑤ Electrical	⑥ Metal Color
Veneer (LKV)	See Edge Detail Options	Essentials	See Essentials Wood Finish Options	N None CTEC23 Power Center Top CTEC24 Power Center Top (See chart above)	See Metal Finish Color Options
		Artisan	④ Wood Finish See Artisan Wood Finish Options		

Description

Rounded Square Table with X Base at Bar Height

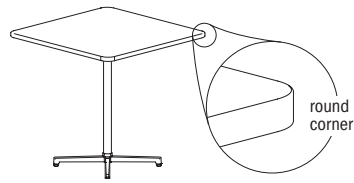

Laminate Tables "LKT" Models

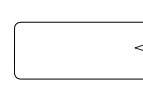

Eased Edge (R3)

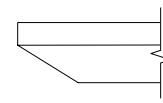

Reverse Bevel Edge (K9)

LAMINATE	D	W	H	CTN WT	CU FT	Model	Standard Tier 1	Graded In Tier 2	Standard Tier 1	Graded In Tier 2
		42	42	42	87	54	LKT4242-42SQRX	\$2,014	\$2,068	\$2,484
	36	36	42	70	41	LKT3636-42SQRX	\$1,685	\$1,729	\$2,153	\$2,199
	30	30	42	55	30	LKT3030-42SQRX	\$1,509	\$1,550	\$1,979	\$2,018

Features:

- price reflects complete table - top and base
- ships KD in multiple cartons
- one piece top
- model includes adjustable glide
- when electrical option is selected, power accessible base is shipped; see page 178 for details
- power/charging units have 72" cord
- power cord is routed inside base column

Options:

- specify power access base with power unit option; None (N), add \$663 for EC23 (CTEC23), add \$549 for EC24 (CTEC24)

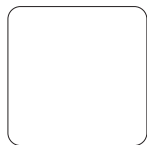

top shape

LOK - CONFERENCE

To Order Specify

1 Laminates Model #	2 Edge Detail	3 Laminates Selection	3a PVC Edge Color	4 Electrical	5 Metal Color
Laminates (LKT)	See Edge Detail Options	See Laminates Selection	See PVC Edge Color Options	N None CTEC23 Power Center Top CTEC24 Power Center Top (See chart on next page)	See Metal Finish Color Options

Model Number Breakdown

LKT4242-42SQRX						
LK	T	4242	42	SQ	R	X
LOK	Laminates	42" x 42"	Height	Square Top Shape	Rounded Corner	X Base

Description

Rounded Square Table with X Base at Bar Height (continued)

Veneer Tables "LKV" Models Solid Surface Tables "LKS" Models

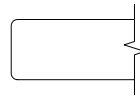

Eased Edge (R3)

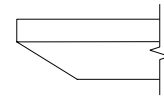

Reverse Bevel Edge (K9)

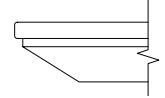

Reverse Bevel Edge (K7)

	D	W	H	CTN WT	CU FT	① Model	Veneer Tables		Solid Surface Tables		
							Essentials	Artisan	Essentials	Artisan	Standard
VENEER	42	42	42	87	54	LKV4242-42SQRX	\$2,627	\$2,800	\$2,727	\$2,908	--
	36	36	42	70	41	LKV3636-42SQRX	\$2,180	\$2,325	\$2,265	\$2,415	--
	30	30	42	55	30	LKV3030-42SQRX	\$1,953	\$2,082	\$2,027	\$2,160	--
SOLID SURFACE	42	42	42	87	54	LKS4242-42SQRX	--	--	--	--	\$5,059
	36	36	42	70	41	LKS3636-42SQRX	--	--	--	--	\$4,100
	30	30	42	55	30	LKS3030-42SQRX	--	--	--	--	\$3,433

Electrical Options and Upcharges

CTEC23	
EC23 Power Center Top - Black	CTEC23BL - add \$663
EC23 Power Center Top - White	CTEC23WH - add \$663
CTEC24	
EC24 Power Center Top - Black	CTEC43BL - add \$549
EC24 Power Center Top - White	CTEC43WH - add \$549

To Order Specify

① Veneer Model #	② Edge Detail	③ Wood Collection	④ Wood Finish	⑤ Electrical	⑥ Metal Color
Veneer (LKV)	See Edge Detail Options	Essentials	See Essentials Wood Finish Options	N None CTEC23 Power Center Top CTEC24 Power Center Top (See chart above)	See Metal Finish Color Options
		Artisan	④ Wood Finish See Artisan Wood Finish Options		

① Solid Surface Model #	② Top Surface Selection	③ Electrical Cut Out	④ Metal Color
Solid Surface (LKS)	See Solid Surface Top Surface Selection Options	N None CTEC23 Power Center Top CTEC24 Power Center Top (See chart above)	See Metal Finish Color Options

LOK - CONFERENCE

Description

Square Table with X4 Base at Bar Height

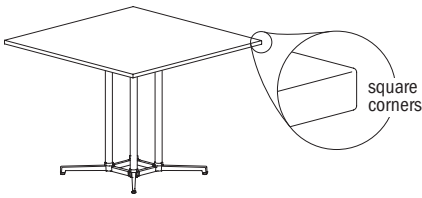

Laminate Tables
"LKT" Models

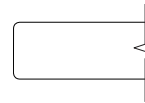

Eased Edge (R3)

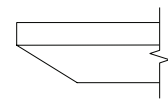

Reverse Bevel Edge (K9)

LAMINATE	D	W	H	CTN WT	CU FT	1 Model	Eased Edge (R3)		Reverse Bevel Edge (K9)	
							Standard Tier 1	Graded In Tier 2	Standard Tier 1	Graded In Tier 2
	60	60	42	207	94	LKT6060-42SQZ	\$3,289	\$3,386	\$3,759	\$3,855
	54	54	42	180	86	LKT5454-42SQZ	\$3,134	\$3,218	\$3,603	\$3,687
	48	48	42	124	69	LKT4848-42SQZ	\$2,615	\$2,671	\$3,083	\$3,141

Features:

- price reflects complete table - top and base
- ships KD in multiple cartons
- one piece top
- model includes adjustable glide
- power cord is routed outside base column
- order vertical wire manager separately; see page 407

Options:

- specify power unit option; None (N), add \$663 for EC23 (CTEC23), add \$549 for EC24 (CTEC24)



top shape

LOK - CONFERENCE

To Order Specify

1 Laminate Model #	2 Edge Detail	3 Laminate Selection	3a PVC Edge Color	4 Electrical	5 Metal Color
Laminate (LKT)	See Edge Detail Options	See Laminate Selection	See PVC Edge Color Options	N None CTEC23 Power Center Top CTEC24 Power Center Top (See chart on next page)	See Metal Finish Color Options

Model Number Breakdown

LKT6060-42SQZ					
LK	T	6060	42	SQ	Z
LOK	Laminate	60" x 60"	Height	Square Top Shape	X4 Base

Description

Square Table with X4 Base
at Bar Height
(continued)

Veneer Tables
"LKV" Models

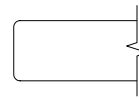

Eased Edge (R3)

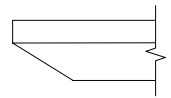

Reverse Bevel Edge (K9)

D	W	H	GTN WT	CU FT	① Model	Essentials		Artisan	
						Essentials	Artisan	Essentials	Artisan
60	60	42	207	94	LKV6060-42SQZ	\$4,257	\$4,538	\$4,419	\$4,711
54	54	42	180	86	LKV5454-42SQZ	\$4,053	\$4,318	\$4,204	\$4,482
48	48	42	124	69	LKV4848-42SQZ	\$3,145	\$3,298	\$3,232	\$3,392

VENEER

LOK- CONFERENCE

Electrical Options and Upcharges

CTEC23	
EC23 Power Center Top - Black	CTEC23BL - add \$663
EC23 Power Center Top - White	CTEC23WH - add \$663
CTEC24	
EC24 Power Center Top - Black	CTEC43BL - add \$549
EC24 Power Center Top - White	CTEC43WH - add \$549

To Order Specify

① Veneer Model #	② Edge Detail	③ Wood Collection	④ Wood Finish	⑤ Electrical	⑥ Metal Color
Veneer (LKV)	See Edge Detail Options	Essentials	See Essentials Wood Finish Options	N None CTEC23 Power Center Top CTEC24 Power Center Top (See chart above)	See Metal Finish Color Options
		Artisan	④ Wood Finish See Artisan Wood Finish Options		

Description

Rounded Square Table with X4 Base at Bar Height

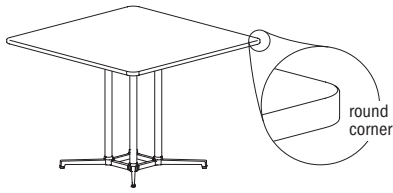

Laminate Tables "LKT" Models

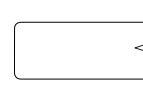

Eased Edge (R3)

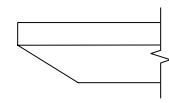

Reverse Bevel Edge (K9)

LAMINATE	D	W	H	CTN WT	CU FT	1 Model	Eased Edge (R3)		Reverse Bevel Edge (K9)	
							Standard Tier 1	Graded In Tier 2	Standard Tier 1	Graded In Tier 2
	60	60	42	207	94	LKT6060-42SQRZ	\$3,529	\$3,616	\$4,001	\$4,084
54	54	42	180	86	LKT5454-42SQRZ	\$2,932	\$3,015	\$3,399	\$3,485	
48	48	42	124	69	LKT4848-42SQRZ	\$2,996	\$3,053	\$3,462	\$3,523	

Features:

- price reflects complete table - top and base
- ships KD in multiple cartons
- one piece top
- model includes adjustable glide
- power cord is routed outside base column
- order vertical wire manager separately; see page 407

Options:

- specify power unit option; None (N), add \$663 for EC23 (CTEC23), add \$549 for EC24 (CTEC24)

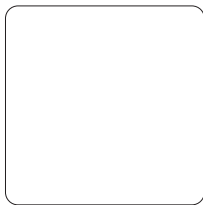

top shape

LOK - CONFERENCE

To Order Specify

1 Laminate Model #	2 Edge Detail	3 Laminate Selection	3a PVC Edge Color	4 Electrical	5 Metal Color
Laminate (LKT)	See Edge Detail Options	See Laminate Selection	See PVC Edge Color Options	N None CTEC23 Power Center Top CTEC24 Power Center Top (See chart on next page)	See Metal Finish Color Options

Model Number Breakdown

LKT6060-42SQRZ						
LK	T	6060	42	SQ	R	Z
LOK	Laminate	60" x 60"	Height	Square Top Shape	Rounded Corner	X4 Base

Description

Rounded Square Table with X4 Base at Bar Height (continued)

Veneer Tables "LKV" Models Solid Surface Tables "LKS" Models

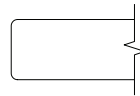

Eased Edge (R3)

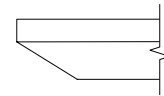

Reverse Bevel Edge (K9)

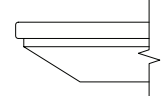

Reverse Bevel Edge (K7)

	D	W	H	CTN WT	CU FT	① Model	Veneer Tables		Solid Surface Tables		
							Essentials	Artisan	Essentials	Artisan	Standard
VENEER	60	60	42	207	94	LKV6060-42SQRZ	\$4,577	\$4,880	\$4,751	\$5,064	--
	54	54	42	180	86	LKV5454-42SQRZ	\$3,784	\$4,032	\$3,925	\$4,184	--
	48	48	42	124	69	LKV4848-42SQRZ	\$3,647	\$3,834	\$3,753	\$3,950	--
SOLID SURFACE	60	60	42	207	94	LKS6060-42SQRZ	--	--	--	--	\$9,033
	54	54	42	180	86	LKS5454-42SQRZ	--	--	--	--	\$7,489
	48	48	42	124	69	LKS4848-42SQRZ	--	--	--	--	\$5,847

Electrical Options and Upcharges

CTEC23	
EC23 Power Center Top - Black	CTEC23BL - add \$663
EC23 Power Center Top - White	CTEC23WH - add \$663
CTEC24	
EC24 Power Center Top - Black	CTEC43BL - add \$549
EC24 Power Center Top - White	CTEC43WH - add \$549

To Order Specify

① Veneer Model #	② Edge Detail	③ Wood Collection	④ Wood Finish	⑤ Electrical	⑥ Metal Color
Veneer (LKV)	See Edge Detail Options	Essentials	See Essentials Wood Finish Options	N None CTEC23 Power Center Top CTEC24 Power Center Top (See chart above)	See Metal Finish Color Options
		Artisan	④ Wood Finish See Artisan Wood Finish Options		
① Solid Surface Model #	② Top Surface Selection	③ Electrical Cut Out		④ Metal Color	
Solid Surface (LKS)	See Solid Surface Top Surface Selection Options	N None CTEC23 Power Center Top CTEC24 Power Center Top (See chart above)		See Metal Finish Color Options	

LOK - CONFERENCE

Description

Squircle Table with X Base at Bar Height



Laminate Tables
"LKT" Models

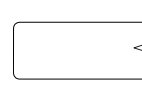

Eased Edge (R3)

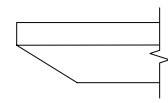

Reverse Bevel Edge (K9)

LAMINATE	D	W	H	CTN WT	CU FT	1 Model	Standard Tier 1	Graded In Tier 2	Standard Tier 1	Graded In Tier 2
	42	42	42	104	54	LKT42-42SCX	\$1,630	\$1,751	\$2,101	\$2,221
	36	36	42	82	41	LKT36-42SCX	\$1,581	\$1,624	\$2,049	\$2,093
30	30	42	64	30	LKT30-42SCX	\$1,528	\$1,563	\$1,999	\$2,036	

Features:

- price reflects complete table - top and base
- ships KD in multiple cartons
- one piece top
- model includes adjustable glide
- when electrical option is selected, power accessible base is shipped; see page 178 for details
- power/charging units have 72" cord
- power cord is routed inside base column

Options:

- specify power access base with power unit option; None (N), add \$663 for EC23 (CTEC23), add \$549 for EC24 (CTEC24)

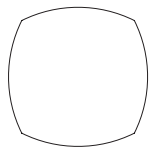

top shape

LOK - CONFERENCE

To Order Specify

1 Laminates Model #	2 Edge Detail	3 Laminates Selection	3a PVC Edge Color	4 Electrical	5 Metal Color
Laminates (LKT)	See Edge Detail Options	See Laminates Selection	See PVC Edge Color Options	N None CTEC23 Power Center Top CTEC24 Power Center Top (See chart on next page)	See Metal Finish Color Options

Model Number Breakdown

LKT42-42SCX					
LK	T	42	42	SC	X
LOK	Laminates	42" dia.	Height	Squircle Top Shape	X Base

Description

Squirrel Table with X Base at Bar Height (continued)

Veneer Tables "LKV" Models Solid Surface Tables "LKS" Models

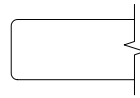

Eased Edge (R3)

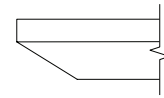

Reverse Bevel Edge (K9)

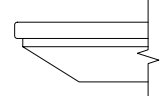

Reverse Bevel Edge (K7)

	D	W	H	CTN WT	CU FT	① Model	Veneer Tables		Solid Surface Tables		
							Essentials	Artisan	Essentials	Artisan	Standard
VENEER	42	42	42	104	54	LKV42-42SCX	\$2,133	\$2,271	\$2,213	\$2,357	--
	36	36	42	82	41	LKV36-42SCX	\$2,067	\$2,203	\$2,147	\$2,286	--
	30	30	42	64	30	LKV30-42SCX	\$1,996	\$2,126	\$2,072	\$2,206	--
SOLID SURFACE	42	42	42	104	54	LKS42-42SCX	--	--	--	--	\$4,585
	36	36	42	82	41	LKS36-42SCX	--	--	--	--	\$4,007
	30	30	42	64	30	LKS30-42SCX	--	--	--	--	\$3,864

Electrical Options and Upcharges

CTEC23	
EC23 Power Center Top - Black	CTEC23BL - add \$663
EC23 Power Center Top - White	CTEC23WH - add \$663
CTEC24	
EC24 Power Center Top - Black	CTEC43BL - add \$549
EC24 Power Center Top - White	CTEC43WH - add \$549

To Order Specify

① Veneer Model #	② Edge Detail	③ Wood Collection	④ Wood Finish	⑤ Electrical	⑥ Metal Color
Veneer (LKV)	See Edge Detail Options	Essentials	See Essentials Wood Finish Options	N None CTEC23 Power Center Top CTEC24 Power Center Top (See chart above)	See Metal Finish Color Options
		Artisan	④ Wood Finish See Artisan Wood Finish Options		

① Solid Surface Model #	② Top Surface Selection	③ Electrical Cut Out	④ Metal Color
Solid Surface (LKS)	See Solid Surface Top Surface Selection Options	N None CTEC23 Power Center Top CTEC24 Power Center Top (See chart above)	See Metal Finish Color Options

LOK-CONFERENCE

Description

Squire Table with X4 Base at Bar Height



Laminate Tables "LKT" Models

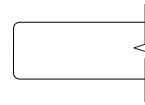

Eased Edge (R3)

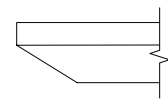

Reverse Bevel Edge (K9)

LAMINATE	D	W	H	CTN WT	CU FT	Model	Eased Edge (R3)		Reverse Bevel Edge (K9)	
							Standard	Graded In	Standard	Graded In
							Tier 1	Tier 2	Tier 1	Tier 2
	60	60	42	207	94	LKT60-42SCZ	\$2,922	\$3,016	\$3,391	\$3,487
	54	54	42	180	86	LKT54-42SCZ	\$2,735	\$2,811	\$3,206	\$3,281
	48	48	42	129	69	LKT48-42SCZ	\$2,600	\$2,723	\$3,072	\$3,192

Features:

- price reflects complete table - top and base
- ships KD in multiple cartons
- one piece top
- model includes adjustable glide
- power cord is routed outside base column
- order vertical wire manager separately; see page 407

Options:

- specify power unit option; None (N), add \$663 for EC23 (CTEC23), add \$549 for EC24 (CTEC24)

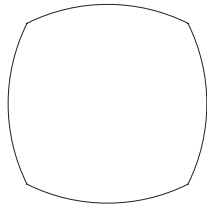

top shape

LOK - CONFERENCE

To Order Specify

1 Laminates Model #	2 Edge Detail	3 Laminates Selection	3a PVC Edge Color	4 Electrical	5 Metal Color
Laminates (LKT)	See Edge Detail Options	See Laminates Selection	See PVC Edge Color Options	N None CTEC23 Power Center Top CTEC24 Power Center Top (See chart on next page)	See Metal Finish Color Options

Model Number Breakdown

LKT60-42SCZ					
LK	T	60	42	SC	Z
LOK	Laminates	60" dia.	Height	Squire Top Shape	X4 Base

Description

Squirrel Table with X4
Base at Bar Height
(continued)

Veneer Tables "LKV" Models Solid Surface Tables "LKS" Models

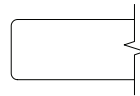

Eased Edge (R3)

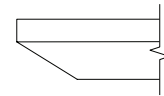

Reverse Bevel Edge (K9)

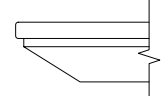

Reverse Bevel Edge (K7)

	D	W	H	CTN WT	CU FT	① Model	Veneer Tables "LKV" Models		Solid Surface Tables "LKS" Models		
							Essentials	Artisan	Essentials	Artisan	Standard
VENEER	60	60	42	207	94	LKV60-42SCZ	\$3,817	\$4,063	\$3,960	\$4,218	--
	54	54	42	180	86	LKV54-42SCZ	\$3,613	\$3,856	\$3,752	\$4,006	--
	48	48	42	129	69	LKV48-42SCZ	\$3,150	\$3,302	\$3,239	\$3,395	--
SOLID SURFACE	60	60	42	207	94	LKS60-42SCZ	--	--	--	--	\$8,291
	54	54	42	180	86	LKS54-42SCZ	--	--	--	--	\$7,336
	48	48	42	129	69	LKS48-42SCZ	--	--	--	--	\$6,198

Electrical Options and Upcharges

CTEC23	
EC23 Power Center Top - Black	CTEC23BL - add \$663
EC23 Power Center Top - White	CTEC23WH - add \$663
CTEC24	
EC24 Power Center Top - Black	CTEC43BL - add \$549
EC24 Power Center Top - White	CTEC43WH - add \$549

To Order Specify

① Veneer Model #	② Edge Detail	③ Wood Collection	④ Wood Finish	⑤ Electrical	⑥ Metal Color
Veneer (LKV)	See Edge Detail Options	Essentials	See Essentials Wood Finish Options	N None CTEC23 Power Center Top CTEC24 Power Center Top (See chart above)	See Metal Finish Color Options
		Artisan	See Artisan Wood Finish Options		

① Solid Surface Model #	② Top Surface Selection	③ Electrical Cut Out	④ Metal Color
Solid Surface (LKS)	See Solid Surface Top Surface Selection Options	N None CTEC23 Power Center Top CTEC24 Power Center Top (See chart above)	See Metal Finish Color Options

LOK - CONFERENCE

Description

Hive Table with T Base
at Bar Height

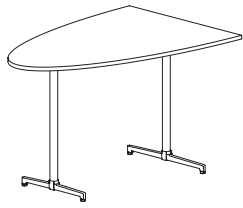

Laminate Tables
"LKT" Models

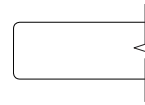

Eased Edge (R3)

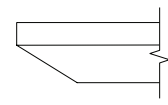

Reverse Bevel Edge (K9)

LAMI	D	W	H	CTN WT	CU FT	1 Model	Standard Tier 1	Graded In Tier 2	Standard Tier 1	Graded In Tier 2
		48	72	42	138	101	LKT4872-42HVT	\$2,295	\$2,340	\$2,804

Features:

- price reflects complete table - top and base
- ships KD in multiple cartons
- model includes adjustable glide

Options:

- specify power/charging option, see below for options and upcharges

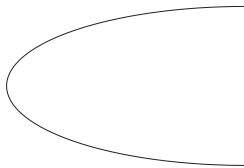

top shape

LOK - CONFERENCE

To Order Specify

1 Laminate Model #	2 Edge Detail	3 Laminate Selection	3a PVC Edge Color	4 Electrical
Laminate (LKT)	See Edge Detail Options	See Laminate Selection	See PVC Edge Color Options	N None CT2 Dual Power Center Top (See chart on next page) CU1 Single Power Underside 5 Metal Finish See Metal Finish Color Options

Model Number Breakdown

LKT4872-42HVT					
LK	T	4872	42	HV	T
LOK	Laminate	48" x 72"	Height	Hive Top Shape	T base

Description

Hive Table with T Base
at Bar Height
(continued)

Veneer Tables
"LKV" Models

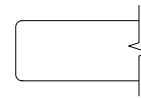

Eased Edge (R3)

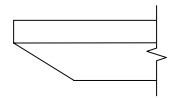

Reverse Bevel Edge (K9)

VEN.	D	W	H	CTN WT	CU FT	① Model	Essentials		Artisan	
	48	72	42	138	101	LKV4872-42HVT	\$2,888		\$3,117	
									\$3,146	\$3,350

Electrical Options and Upcharges

CT2	
Dual Power Center Top - Black	CT2BL - add \$1,437
Dual Power Center Top - White	CT2WH - add \$1,437
CU1	
Single Power Underside - Black	CU11C - add \$559
Single Power Underside with Wireless Charging - Black	CU11CW - add \$1,338

Note: Order power infeed that best fits application.

To Order, Specify:

① Veneer Model #	② Edge Detail	③ Wood Collection	④ Top Wood Finish	⑤ Electrical	⑥ Metal Color
Veneer (LKV)	See Edge Detail Options	Essentials	See Essentials Wood Finish Options	N None CT2 Dual Power Center Top CU1 Single Power Underside (See chart above)	See Metal Finish Color Options
		Artisan	④ Top Wood Finish See Artisan Wood Finish Options		

Description	D	W	H	CTN WT	CU FT	① Model	Laminate	Essentials Veneer	Artisan Veneer
Closed Storage Credenza	20	72	29	343	32	LKT2072-29L777	\$3,373		
	20	72	29	343	32	LKV2072-29L777		\$4,312	\$4,742
	20	60	29	237	28	LKT2060-29L777	\$3,197		
	20	60	29	237	28	LKV2060-29L777		\$4,071	\$4,475



Features:

- model comes with finished top, profiled top available to order separately, see page 444-445
- each compartment has one adjustable shelf
- back access grommet standard at top of each compartment
- door pulls match metal finish selected for column

Options:

- locking doors available, specify and add \$441

Closed/Open Storage Credenza	20	72	29	339	32	LKT2072-29L707	\$3,232		
	20	72	29	339	32	LKV2072-29L707		\$4,134	\$4,547
	20	60	29	230	28	LKT2060-29L707	\$3,064		
	20	60	29	230	28	LKV2060-29L707		\$3,899	\$4,289

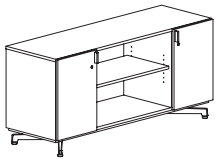

Features:

- model comes with finished top, profiled top available to order separately, see page 444-445
- each compartment has one adjustable shelf
- back access grommet standard at top of each compartment
- door pulls match metal finish selected for column

Options:

- locking doors available, specify and add \$294

LOK - CONFERENCE

To Order Specify

Laminate Model #	② Laminate Selection	③ PVC Edge Color
Laminate (LKT)	See Laminate Selection	See PVC Edge Color Options

Model Number Breakdown

LKT2060-29L777				
LK	T	2060	29	L777
LOK	Laminate	20"x60"	Height	Door Configuration

Description	D	W	H	CTN WT	CU FT	① Model	Laminate	Essentials Veneer	Artisan Veneer
Closed Storage Credenza at Counter Height	20	72	36	362	38	LKT2072-36L777	\$3,679		
	20	72	36	362	38	LKV2072-36L777		\$4,699	\$5,169
	20	60	36	303	34	LKT2060-36L777	\$3,486		
	20	60	36	303	34	LKV2060-36L777		\$4,435	\$4,879



Features:

- model comes with finished top, profiled top available to order separately, see page 444-445
- each compartment has one adjustable shelf
- back access grommet standard at top of each compartment
- door pulls match metal finish selected for column

Options:

- locking doors available, specify and add \$441

Closed/Open Storage Credenza at Counter Height	20	72	36	355	38	LKT2072-36L707	\$3,528		
	20	72	36	355	38	LKV2072-36L707		\$4,507	\$4,958
	20	60	36	296	34	LKT2060-36L707	\$3,342		
	20	60	36	296	34	LKV2060-36L707		\$4,251	\$4,675

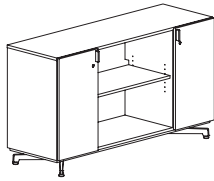

Features:

- model comes with finished top, profiled top available to order separately, see page 444-445
- each compartment has one adjustable shelf
- back access grommet standard at top of each compartment
- door pulls match metal finish selected for column

Options:

- locking doors available, specify and add \$294

To Order Specify

① Veneer Model #	② Wood Collection	③ Wood Finish
Veneer (LKV)	Essentials	See Essentials Wood Finish Options
	Artisan	③ Wood Finish See Artisan Wood Finish Options

Description

Credenza Cabinet Top



Laminate Tables
"LKT" Models

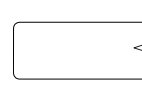

Eased Edge (R3)

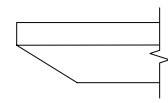

Reverse Bevel Edge (K9)

LAMINATE	D	W	H	CTN WT	CU FT	① Model	Standard Tier 1	Graded In Tier 2	Standard Tier 1	Graded In Tier 2
	20	72	1 3/16	55	8	LKT2072TT	\$549	\$571	\$1,037	\$1,056
	20	60	1 3/16	47	7	LKT2060TT	\$485	\$502	\$967	\$983

Features:

- edge profile on approach side
- placed on top of storage credenza

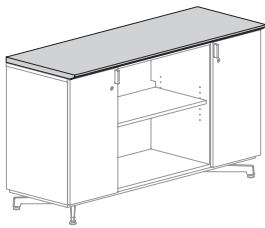

LOK - CONFERENCE

To Order Specify

① Laminate Model #	② Edge Detail	③ Laminate Selection	④ PVC Edge Color
Laminate (LKT)	See Edge Detail Options	See Laminate Selection	See PVC Edge Color Options N None CT2 Dual Power Center Top CU2 Dual Power Underside CT2U1 Dual Power Center Top with Underside (See chart on next page)

[See Metal Finish Color Options](#)

Model Number Breakdown

LKT2072TT			
LK	T	2072	TT
LOK	Laminate	20" x 72"	Rectangular Top Shape

Description

Credenza Cabinet Top
(continued)

Veneer Tables
"LKV" Models

Solid Surface Tables
"LKS" Models

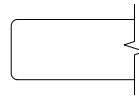

Eased Edge (R3)

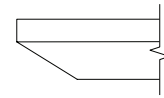

Reverse Bevel Edge (K9)

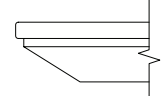

Reverse Bevel Edge (K7)

	D	W	H	CTN WT	CU FT	① Model	Essentials	Artisan	Essentials	Artisan	Standard
VENEER	20	72	1 3/16	55	8	LKV2072TT	\$847	\$956	\$847	\$956	--
	20	60	1 3/16	47	7	LKV2060TT	\$777	\$869	\$777	\$869	--
SOL SURF	20	72	1 3/16	55	8	LKS2072TT	--	--	--	--	\$2,327
	20	60	1 3/16	47	7	LKS2060TT	--	--	--	--	\$2,114

To Order Specify

① Veneer Model #	② Edge Detail	③ Wood Collection	④ Wood Finish
Veneer (LKV)	See Edge Detail Options	Essentials	See Essentials Wood Finish Options
		Artisan	④ Wood Finish See Artisan Wood Finish Options

① Solid Surface Model #	② Top Surface Selection
Solid Surface (LKS)	See Solid Surface Top Surface Selection Options

LOK- CONFERENCE

Description	D	W	H	CTN WT	CU FT	① Model	List Price
3 Prong Plug - 110 Power Infeed				1	1	AP72	\$332

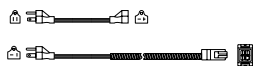

- Features:**
- 72" plug power infeed
 - 20 amps/110 volts max
 - 3 prong plug - 15 amp adapter plug included
 - single circuit use only

Hardwire Power Infeed				1	1	HP72	\$270
------------------------------	--	--	--	---	---	------	-------



- Features:**
- 72" hardwire power infeed
 - 20 amps/120 volts max
 - single or double circuit
 - electrical contractor responsible for connection to building power source

Quick Disconnect Power Infeed				1	1	MP72	\$249
--------------------------------------	--	--	--	---	---	------	-------



- Features:**
- must be used with QD1
 - 72" modular power infeed
 - 20 amps/120 volts max
 - single or double circuit

Quick Disconnect Wall Outlet				1	1	QD1	\$127
-------------------------------------	--	--	--	---	---	-----	-------

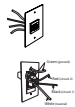

- Features:**
- must be used with MP72
 - works for both single or double circuit
 - 20 amps/120 volts max
 - electrical contractor responsible for connection to building power source

Vertical Wire Manager	1/2	2 1/4	33	1	1	AVL33	\$143
	1/2	2 1/4	25	1	1	AVL25	\$108
	1/2	2 1/4	22	1	1	AVL20	\$88
	1/2	2 1/4	17	1	1	AVL17	\$83



- Features:**
- field installed
 - use AVL33 for 42"h tables with disk base
 - use AVL25 for 42"h tables
 - use AVL20 for 36"h tables
 - use AVL17 for 29"h tables

- Options:**
- specify plastic color, Black (B) or Silver (S)

Flexible Vertical Wire Manager	1 1/2	1 1/2	45	4	1	45VWM	\$135
---------------------------------------	-------	-------	----	---	---	-------	-------



- Features:**
- black plastic
 - field installed to bottom of table top, with screws provided
 - wire manager is 1 1/2" diameter
 - weighted base is 4" diameter
 - length can be adjusted by removing individual discs as required

LOK - CONFERENCE

Description	D	W	H	CTN WT	CU FT	Model	List Price
Power Strip	1 1/2	1 7/8	8	3	1	GP9ACP1-0212	\$96

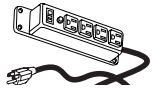

- Features:**
- power surge with 10" cord
 - four electrical outlets
 - includes switch
 - field installed

Wire Management Velcro Straps	1 3/4	3 1/2	1/4	1	1	04WVS	\$58
-------------------------------	-------	-------	-----	---	---	-------	------

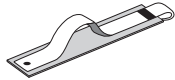

- Features:**
- black, set of 4
 - field installed to bottom of table top, with adhesive tape provided

Cable Management Clips	2 5/8	3 3/4	1 5/8	1	1	0304CMC	\$56
------------------------	-------	-------	-------	---	---	---------	------

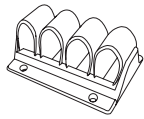

- Features:**
- black plastic
 - installed to bottom of table top
 - four retention loops

Floor Mount Glide	3	2 1/4	1/2	1	1	LKB516-18ANCHOR	\$43
-------------------	---	-------	-----	---	---	-----------------	------

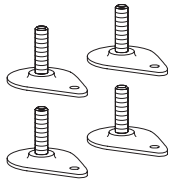

- Features:**
- field installed glides for mounting table base to floor
 - 1/4" diameter hole in the glide for mounting
 - set of 4
 - table can be leveled before attached to floor
 - floor attachment hardware provided by installer
 - glide threads 3/8"-16

Wire Management Tray	7 1/2	45	3	8	2	GP9WMT1-0845	\$279
	7 1/2	35	3	6	1	GP9WMT1-0835	\$235
	7 1/2	25	3	4	1	GP9WMT1-0825	\$191

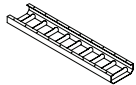

- Features:**
- silver powder-coated finish
 - four hanging brackets (CI2C00)

Wire Manager Trough	2 1/2	36	2 1/2	4	1	36WCT	\$157
	2 1/2	24	2 1/2	3	1	24WCT	\$143
	2 1/2	12	2 1/2	2	1	12WCT	\$123

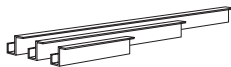

- Features:**
- black plastic
 - field installed to bottom of table top, with screws provided

Accessories/ Keyboard/ Tasklights

For an additional list of electrical units, grommets, keyboards, wire management, monitor arms & telecom jacks, please see our [accessories price list](#)

Contact your customer service representative for specific questions regarding which units can be used with Lok Conferencing.

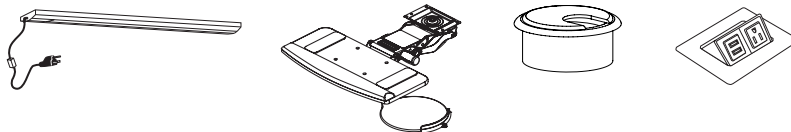

Page left intentionally blank

Lounge - Table of Contents



Training



Teamwork



Conference



Lounge

Lok - Lounge

Product Information

Lounge Overview 410
 Tables Shapes & Sizes 415-416
 Laminate Specifications 413
 Veneer Specifications 414
 Solid Surface Specifications 414
 Base Styles - Features 417
 Electrical Planning - Options 417

Pricing Pages

Lounge Tables at 16" Height 418-435
 Lounge Tables at 26" Height 436-453
 Electrical 454

Lounge - Overview



rectangular
16 "H - Page 448
26""H - Page 464



rounded rectangular
16 "H - Page 450



arc rectangular
16 "H - Page 452



rounded arc
rectangular
16 "H - Page 454



oval
16 "H - Page 456
26""H - Page 466

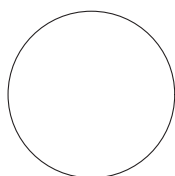

round
16 "H - Page 458
26""H - Page 468

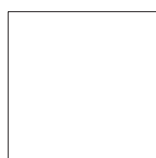

square
26""H - Page 470



rounded square
16 "H - Page 460
26""H - Page 472

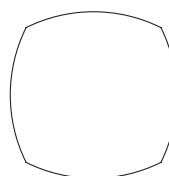

squircle
16 "H - Page 462
26""H - Page 474

Lounge - Materials

Laminate Tops

Lok training table worksurfaces are offered in HPL (High Pressure Laminate) The tops are 1 3/16" thick, 3 ply balanced construction. Particle board core and a phenolic backer sheet complete the balanced construction.

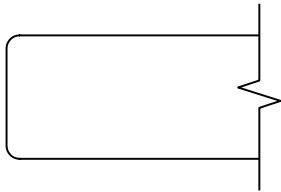

Eased Edge (R3)
PVC

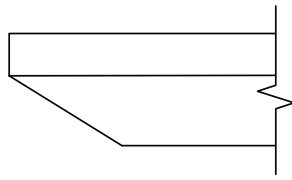

Reverse Bevel (K9)
PVC on painted top of painted MDF

Standard PVC Edge Colors

JSI supports 26 standard PVC edge colors listed below. These coordinate with our Standard (Tier1) Laminates.

When selecting a Standard (Tier 1) Laminate, the coordinating PVC edge color is automatically applied. When selecting a Graded-In Laminate (Tier 2 or 3), you will be prompted to choose one these 26 PVC edge colors to be applied to the edge.

ALB Alabaster	MES Mesa
BEL Belair	MIN Mineral
BLK Black	MCH Mocha
BRK Brickdust	OBK Outback
BBL Bridal Blanco	PIL Pilsner
CSK Cask	PIN Pinnacle Walnut
CLY Clay	SHD Shadow
DWH Designer White	SLG Slate Grey
EGR Egret	UMB Umber
FAW Fawn	VAL Valley
FLN Flint	WAL Walnut Heights
FLO Florence Walnut	WEA Weathered Ash
LOF Loft	ZEN Zen Grey

Standard Laminates

JSI Standard Laminate program consists of 26 solid and wood grain patterns, and establish our Tier 1 laminate pricing. Each has a coordinating PVC edge color that is automatically used with the Standard Laminates.

Wood Grain Laminate

BEL Belair	MIN Mineral
BRK Brickdust	MCH Mocha
CSK Cask	OBK Outback
CLY Clay	PIL Pilsner
EGR Egret	PIN Pinnacle Walnut
FAW Fawn	UMB Umber
FLN Flint	VAL Valley
FLO Florence Walnut	WLH Walnut Heights
LOF Loft	WEA Weathered Ash
MES Mesa	

Solid Laminate

ALB Alabaster
BLK Black
BBL Bridal Blanco
DWH Designer White
SHD Shadow
SLG Slate Grey
ZEN Zen Grey

Lounge - Materials

Veneer Tops

Tops are 1 3/8" thick, 5 ply balanced construction with particle board core. Standard Tier 1 veneer is essentials, book matched for cherry, maple, walnut and black oak veneer. Standard Tier 2 veneer is artisan.

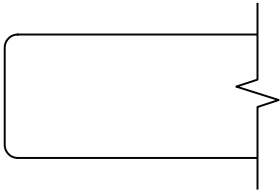

Eased Edge (R3)
Internal Lumber Band

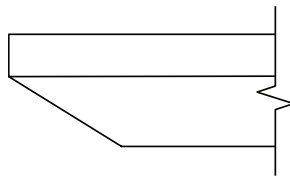

Reverse Bevel (K9)
Veneer Band on Stained MDF

Finish - Stain/Colors

ESS Essentials Veneer Collection

BRK Brickdust	MIN Mineral
CSK Cask	MCH Mocha
CLY Clay	OBK Outback
FAW Fawn	PIL Pilsner
FLX Flax	SIE Sienna
FLN Flint	TRF Truffle
LOF Loft	UMB Umber
MES Mesa	VAL Valley

ART Artisan Veneer Collection

BAR Barrel	RAV Raven
BUF Buff	RYE Rye
CND Cinder	SAB Sable
EGR Egret	SAD Saddle

Protective Top Coat

DuraTex™ offers exceptional hardness along with abrasion and impact resistance, it has been formulated to eliminate hazardous and harmful gases that are normally associated with wood finish.

DuraTex™ Features

- Safety - Significantly reduces hazardous formaldehyde emissions which help improve the quality of the of the indoor air we breathe.
- Quality - Developed to be tough and durable with special attention to appearance. The DuraTex™ finish preserves the natural beauty of wood.
- Durability - Designed to meet a wide range of demanding performance and environmental standards to withstand even the highest wear and tear.

Finish Sheen

All veneer finishes are standard in 35-sheen, with the exception of Raven. Raven is only offered in 15-sheen. All other finishes can have their sheen modified with a 15% upcharge added to the list price of each item.

Custom/Special Finishes

JSI, upon request, will accommodate special finishes. A written request is required to proceed with custom finish orders. A sample reference is required for first-time matches and must be included with the written request.

There is a one-time charge of **\$384 list per order** for any non-standard wood finish.

Orders will be entered noting the special finish. A sample match will be provided to the customer. Written approval is needed before the finish process can be started. Delays in approval may have an impact on lead times.

Every effort will be made to create the requested match; however, an acceptable match may not be possible because of natural variations of wood. These natural variations can also cause minor differences in the final finish product.

Use standard pricing and option pricing for each line item with a special finish, unless additional modifications have been specified. For items available in both Essential and Artisan veneers, apply the Essentials pricing.

Solid Surface Tops

Tops are 1 3/8" thick constructed of 1/2" thick Solid Surface on top of a 1/4" MDF sub top. Sub top has an under cut bevel profile and is painted in a coordinated color to match the Solid Surface.

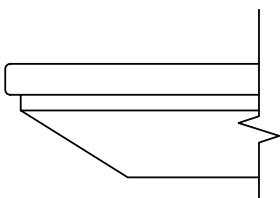





Standard Solid Surface

ONX	Black Onyx Mirage
DWH	Designer White
HST	Hot Stone
SOG	Soothing Grey

Reverse Bevel Edge (K7)
Solid Surface over painted MDF

Lounge -Top Shapes

Lok offers 9 lounge table top shapes. Tables are available in 16" or 26" high and in laminate, veneer or solid surface. Compatible bases are: X Base or Y Base.

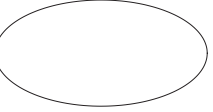
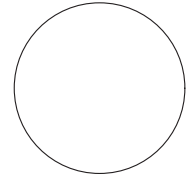
					
rectangular	rounded rectangular	arc rectangular	rounded arc rectangular	oval	round
16"h	16"h	16"h	16"h	16"h	16"h
24" x 48"	24" x 48"	24" x 48"	24" x 48"	30" x 48"	24"
30" x 48"	30" x 48"	30" x 48"	30" x 48"		30"
					36"
					42"
26"h	26"h	26"h	26"h	26"h	26"h
24" x 48"	24" x 48"	24" x 48"	24" x 48"	30" x 48"	24"
30" x 48"	30" x 48"	30" x 48"	30" x 48"		30"
					36"
					42"

Lounge - Top Shapes

Lok offers 9 lounge table top shapes. Tables are available in 16" or 26" high and in laminate, veneer or solid surface. Compatible bases are: X Base or Y Base.

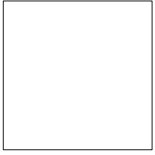

square

16"h

24" x 24"
30" x 30"
36" x 36"

26"h

24" x 24"
30" x 30"
36" x 36"

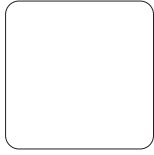

rounded square

26"h

24" x 24"
30" x 30"
36" x 36"

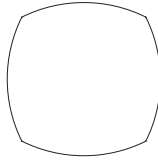

squircle

16"h

24" x 24"
30" x 30"
36" x 36"

26"h

24" x 24"
30" x 30"
36" x 36"

Lounge- Base Styles

Lok provides a choice selection of bases in both function and aesthetics to serve a variety of needs. The conferencing offering includes: X-base and Y-Base.

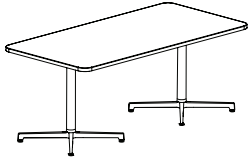

X-Base

- available 16"h or 26"h only in glides.
- compatible with the following top shapes: round, square, square, squircle
- base finish - select single metal finish or two-tone metal finish. See options listed below
- power access version, with integrated wire management available with an upcharge

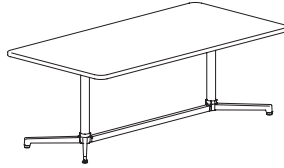

Y Base

- available in 16"h or 26"h only in glides
- compatible with the following top shapes: arc rectangular, oval
- base finish - select single metal finish or two-tone metal finish. See options listed below

Single Metal Finish

- ABZ** Aged Bronze Feet & Post
- ASL** Arctic Silver Feet & Post
- GLD** Gold Feet & Post
- PEW** Pewter Feet & Post
- MBK** Matte Black Feet & Post
- SBZ** Soft Bronze Feet & Post
- SNK** Soft Nickel Feet & Post

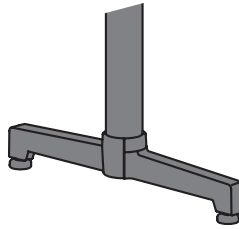

Two - Tone Metal Finish

Two-Tone Aesthetics can be achieved by specifying Polished Aluminum on the foot and a contrasting finish on the post

Polished Aluminum Feet

- ABZ** Aged Bronze Post
- ASL** Arctic Silver Post
- GLD** Gold Post
- PEW** Pewter Post
- MBK** Matte Black Post
- SBZ** Soft Bronze Post
- SNK** Soft Nickel Post

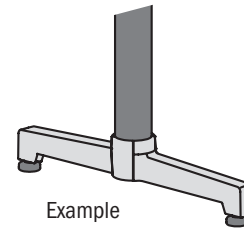

Power/Charging Options

Lok offers the ability to place power and charging options in the center of select tables. Select your choice of EC23 or EC24, available in black and white.

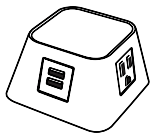

Moire - EC23

- Three 110 outlets
- Dual USB port with 72" power cord
- Black (B) or White (W)

select CTEC23 for cutout in worksurfaces



Node - EC24

- One 110 outlet
- Dual USB port with 72" power cord
- Black (B) or White (W)

select CTEC24 for cutout in worksurfaces

Cut outs are located in the center of each table. See below for representation or location.

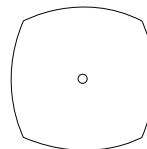
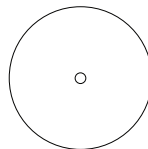
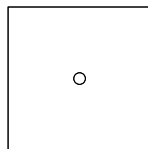
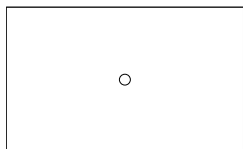

Description

Rectangular Table with Y Base at 16" Lounge Height

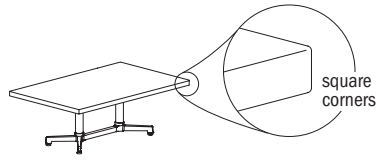

Laminate Tables
"LKT" Models

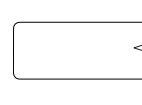

Eased Edge (R3)

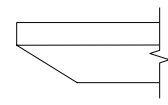

Reverse Bevel Edge (K9)

LAMINATE	D	W	H	CTN WT	CU FT	Model	Standard Tier 1	Graded In Tier 2	Standard Tier 1	Graded In Tier 2
	30	48	16	79	18	LKT3048-16TTY	\$1,677	\$1,696	\$2,141	\$2,161
	24	48	16	74	16	LKT2448-16TTY	\$1,609	\$1,623	\$2,067	\$2,083

Features:

- price reflects complete table - top and base
- ships KD in multiple cartons
- model includes adjustable glide
- power cord is routed outside base column
- order vertical wire manager separately; see page 454

Options:

- specify power unit option; None (N), add \$663 for EC23 (CTEC23), add \$549 for EC24 (CTEC24)



top shape

To Order Specify

1 Laminates Model #	2 Edge Detail	3 Laminates Selection	3a PVC Edge Color	4 Electrical	5 Metal Color
Laminates (LKT)	See Edge Detail Options	See Laminates Selection	See PVC Edge Color Options	N None CTEC23 Power Center Top CTEC24 Power Center Top (See chart on next page)	See Metal Finish Color Options

Model Number Breakdown

LKT3048-16TTY					
LK	T	3048	16	TT	Y
LOK	Laminates	30" x 48"	Height	Rectangular Top Shape	Y base

Description

Rectangular Table with Y
Base at 16" Lounge Height
(continued)

Veneer Tables
"LKV" Models

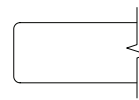

Eased Edge (R3)

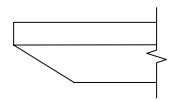

Reverse Bevel Edge (K9)

VENEER	D	W	H	CTN WT	CU FT	① Model	Essentials	Artisan	Essentials	Artisan
	30	48	16	79	18	LKV3048-16TTY	\$1,957	\$2,062	\$2,159	\$2,248
24	48	16	74	16	LKV2448-16TTY	\$1,887	\$1,972	\$2,080	\$2,152	

Electrical Options and Upcharges

CTEC23	
EC23 Power Center Top - Black	CTEC23BL - add \$663
EC23 Power Center Top - White	CTEC23WH - add \$663
CTEC24	
EC24 Power Center Top - Black	CTEC43BL - add \$549
EC24 Power Center Top - White	CTEC43WH - add \$549

To Order Specify

① Veneer Model #	② Edge Detail	③ Wood Collection	④ Wood Finish	⑤ Electrical	⑥ Metal Color
Veneer (LKV)	R3 Eased K9 Reverse Bevel	Essentials	See Essentials Wood Finish Options	N None CTEC23 Power Center Top CTEC24 Power Center Top (See chart above)	See Metal Finish Color Options
	Artisan	④ Wood Finish See Artisan Wood Finish Options			

Description

Rounded Rectangular Table with Y Base at 16" Lounge Height

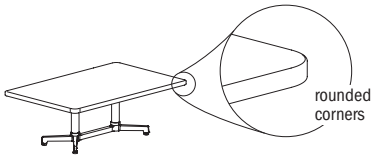

Laminate Tables
"LKT" Models

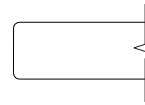

Eased Edge (R3)

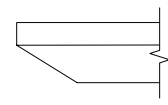

Reverse Bevel Edge (K9)

LAMINATE	D	W	H	CTN WT	CU FT	❶ Model	Standard Tier 1	Graded In Tier 2	Standard Tier 1	Graded In Tier 2
	30	48	16	79	18	LKT3048-16TTRY	\$1,742	\$1,760	\$2,209	\$2,230
	24	48	16	69	16	LKT2448-16TTRY	\$1,646	\$1,662	\$2,106	\$2,120

Features:

- price reflects complete table - top and base
- ships KD in multiple cartons
- model includes adjustable glide
- power cord is routed outside base column
- order vertical wire manager separately; see page 454

Options:

- specify power unit option; None (N), add \$663 for EC23 (CTEC23), add \$549 for EC24 (CTEC24)

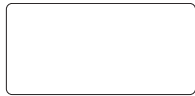

top shape

To Order Specify

❶ Laminates Model #	❷ Edge Detail	❸ Laminates Selection	❹ PVC Edge Color	❺ Electrical	❻ Metal Color
Laminates (LKT)	See Edge Detail Options	See Laminates Selection	See PVC Edge Color Options	N None CTEC23 Power Center Top CTEC24 Power Center Top (See chart on next page)	See Metal Finish Color Options

Model Number Breakdown

LKT3048-16TTRY						
LK	T	3048	16	TT	R	Y
LOK	Laminates	30" x 48"	Height	Rectangular Top Shape	Rounded Corner	Y Base

Description

Rounded Rectangular Table with Y Base at 16" Lounge Height (continued)

Veneer Tables "LKV" Models Solid Surface Tables "LKS" Models

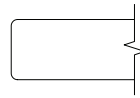

Eased Edge (R3)

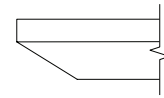

Reverse Bevel Edge (K9)

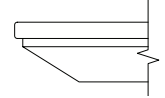

Reverse Bevel Edge (S7)

	D	W	H	CTN WT	CU FT	① Model	Veneer Tables "LKV" Models		Solid Surface Tables "LKS" Models		
							Essentials	Artisan	Essentials	Artisan	Standard
VENEER	30	48	16	79	18	LKV3048-16TTRY	\$2,015	\$2,130	\$2,219	\$2,319	--
	24	48	16	69	16	LKV2448-16TTRY	\$1,927	\$2,008	\$2,117	\$2,191	--
SOL. SURF.	30	48	16	79	18	LKS3048-16TTRY	--	--	--	--	\$4,084
	24	48	16	69	16	LKS2448-16TTRY	--	--	--	--	\$3,036

Electrical Options and Upcharges

CTEC23	
EC23 Power Center Top - Black	CTEC23BL - add \$663
EC23 Power Center Top - White	CTEC23WH - add \$663
CTEC24	
EC24 Power Center Top - Black	CTEC43BL - add \$549
EC24 Power Center Top - White	CTEC43WH - add \$549

To Order Specify

① Veneer Model #	② Edge Detail	③ Wood Collection	④ Wood Finish	⑤ Electrical	⑥ Metal Color
Veneer (LKV)	See Edge Detail Options	Essentials	See Essentials Wood Finish Options	N None CTEC23 Power Center Top CTEC24 Power Center Top (See chart above)	See Metal Finish Color Options
		Artisan	See Artisan Wood Finish Options		

① Solid Surface Model #	② Top Surface Selection	③ Electrical Cut Out	④ Metal Color
Solid Surface (LKS)	See Solid Surface Top Surface Selection Options	N None CTEC23 Power Center Top CTEC24 Power Center Top (See chart above)	See Metal Finish Color Options

LOK - LOUNGE

Description

Arc Rectangular Table with Y
Base at 16" Lounge Height

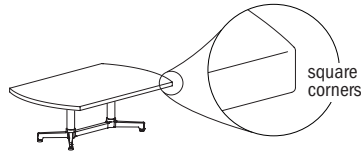

Laminate Tables
"LKT" Models

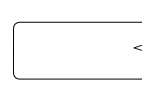

Eased Edge (R3)

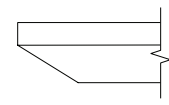

Reverse Bevel Edge (K9)

LAMINATE	D	W	H	CTN WT	CU FT	Model	Standard Tier 1	Graded In Tier 2	Standard Tier 1	Graded In Tier 2
	30	48	16	75	18	LKT3048-16ARY	\$1,742	\$1,760	\$2,209	\$2,230
24	48	16	67	16	LKT2448-16ARY	\$1,646	\$1,662	\$2,106	\$2,120	

Features:

- price reflects complete table - top and base
- ships KD in multiple cartons
- model includes adjustable glide
- power cord is routed outside base column
- order vertical wire manager separately; see page 454

Options:

specify power unit option; None (N), add \$663 for EC23 (CTEC23), add \$549 for EC24 (CTEC24)



top shape

To Order Specify

1 Laminates Model #	2 Edge Detail	3 Laminates Selection	3a PVC Edge Color	4 Electrical	5 Metal Color
Laminates (LKT)	See Edge Detail Options	See Laminates Selection	See PVC Edge Color Options	N None CTEC23 Power Center Top CTEC24 Power Center Top (See chart on next page)	See Metal Finish Color Options

Model Number Breakdown

LKT3048-16ARY					
LK	T	3048	16	AR	Y
LOK	Laminates	30" x 48"	Height	Arc Rectangular Top Shape	Y base

Description

Arc Rectangular Table with Y Base
at 16" Lounge Height
(continued)

Veneer Tables
"LKV" Models

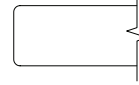

Eased Edge (R3)

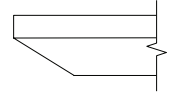

Reverse Bevel Edge (K9)

VENEER	D	W	H	CTN WT	CU FT	① Model	Essentials	Artisan	Essentials	Artisan
	30	48	16	75	18	LKV3048-16ARY	\$2,015	\$2,130	\$2,219	\$2,319
24	48	16	67	16	LKV2448-16ARY	\$1,927	\$2,008	\$2,117	\$2,191	

Electrical Options and Upcharges

CTEC23	
EC23 Power Center Top - Black	CTEC23BL - add \$663
EC23 Power Center Top - White	CTEC23WH - add \$663
CTEC24	
EC24 Power Center Top - Black	CTEC43BL - add \$549
EC24 Power Center Top - White	CTEC43WH - add \$549

To Order Specify

① Veneer Model #	② Edge Detail	③ Wood Collection	④ Wood Finish	⑤ Electrical	⑥ Metal Color
Veneer (LKV)	R3 Eased K9 Reverse Bevel	Essentials	See Essentials Wood Finish Options	N None CTEC23 Power Center Top CTEC24 Power Center Top (See chart above)	See Metal Finish Color Options
	Artisan	④ Wood Finish See Artisan Wood Finish Options			

LOK - LOUNGE

Description

Rounded Arc Rectangular Table with Y Base at 16" Lounge Height

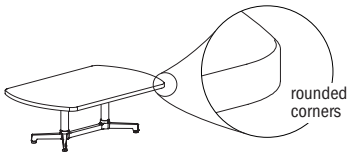

Laminate Tables
"LKT" Models

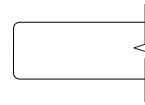

Eased Edge (R3)

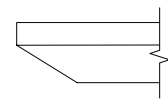

Reverse Bevel Edge (K9)

LAMINATE	D	W	H	CTN WT	CU FT	① Model	Eased Edge (R3)		Reverse Bevel Edge (K9)	
							Standard	Graded In	Standard	Graded In
							Tier 1	Tier 2	Tier 1	Tier 2
	30	48	16	75	18	LKT3048-16ARRY	\$1,742	\$1,760	\$2,209	\$2,230
	24	48	16	67	16	LKT2448-16ARRY	\$1,646	\$1,662	\$2,106	\$2,120

Features:

- price reflects complete table - top and base
- ships KD in multiple cartons
- model includes adjustable glide
- power cord is routed outside base column
- order vertical wire manager separately; see page 454

Options:

- specify power unit option; None (N), add \$663 for EC23 (CTEC23), add \$549 for EC24 (CTEC24)



top shape

To Order Specify

① Laminate Model #	② Edge Detail	③ Laminate Selection	④ PVC Edge Color	⑤ Electrical	⑥ Metal Color
Laminate (LKT)	See Edge Detail Options	See Laminate Selection	See PVC Edge Color Options	N None CTEC23 Power Center Top CTEC24 Power Center Top (See chart on next page)	See Metal Finish Color Options

Model Number Breakdown

LKT3048-16ARRY						
LK	T	3048	16	AR	R	Y
LOK	Laminate	30" x 48"	Height	Arc Rectangular Top Shape	Rounded Corner	Y Base

Description

Rounded Arc Rectangular Table with Y Base at 16" Lounge Height (continued)

Veneer Tables "LKV" Models

Solid Surface Tables "LKS" Models

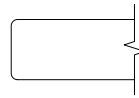

Eased Edge (R3)

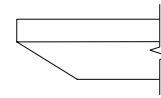

Reverse Bevel Edge (K9)

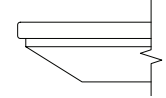

Reverse Bevel Edge (S7)

	D	W	H	CTN WT	CU FT	① Model	Veneer Tables "LKV" Models		Solid Surface Tables "LKS" Models		
							Essentials	Artisan	Essentials	Artisan	Standard
VENEER	30	48	16	75	18	LKV3048-16ARRY	\$2,015	\$2,130	\$2,219	\$2,319	--
	24	48	16	67	16	LKV2448-16ARRY	\$1,927	\$2,008	\$2,117	\$2,191	--
SOL.SURF.	30	48	16	75	18	LKS3048-16ARRY	--	--	--	--	\$4,084
	24	48	16	67	16	LKS2448-16ARRY	--	--	--	--	\$3,036

Electrical Options and Upcharges

CTEC23	
EC23 Power Center Top - Black	CTEC23BL - add \$663
EC23 Power Center Top - White	CTEC23WH - add \$663
CTEC24	
EC24 Power Center Top - Black	CTEC43BL - add \$549
EC24 Power Center Top - White	CTEC43WH - add \$549

To Order Specify

① Veneer Model #	② Edge Detail	③ Wood Collection	④ Wood Finish	⑤ Electrical	⑥ Metal Color
Veneer (LKV)	See Edge Detail Options	Essentials	See Essentials Wood Finish Options	N None CTEC23 Power Center Top CTEC24 Power Center Top (See chart above)	See Metal Finish Color Options
		Artisan	See Artisan Wood Finish Options		

① Solid Surface Model #	② Top Surface Selection	③ Electrical Cut Out	④ Metal Color
Solid Surface (LKS)	See Solid Surface Top Surface Selection Options	N None CTEC23 Power Center Top CTEC24 Power Center Top (See chart above)	See Metal Finish Color Options

LOK - LOUNGE

Description

Oval Table with Y Base at 16"
Lounge Height



Laminate Tables
"LKT" Models

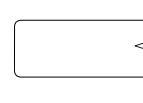

Eased Edge (R3)

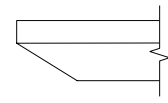

Reverse Bevel Edge (K9)

LAMI	D	W	H	CTN WT	CU FT	Model	Standard Tier 1	Graded In Tier 2	Standard Tier 1	Graded In Tier 2
		30	48	16	68	18	LKT3048-160VY	\$1,723	\$1,747	\$2,193

Features:

- price reflects complete table - top and base
- ships KD in multiple cartons
- model includes adjustable glide
- power cord is routed outside base column
- order vertical wire manager separately; see page 454

Options:

- specify power unit option; None (N), add \$663 for EC23 (CTEC23), add \$549 for EC24 (CTEC24)

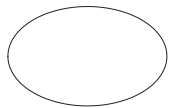

top shape

To Order Specify

1 Laminate Model #	2 Edge Detail	3 Laminate Selection	3a PVC Edge Color	4 Electrical	5 Metal Color
Laminate (LKT)	See Edge Detail Options	See Laminate Selection	See PVC Edge Color Options	N None CTEC23 Power Center Top CTEC24 Power Center Top (See chart on next page)	See Metal Finish Color Options

Model Number Breakdown

LKT3048-160VY					
LK	T	3048	16	OV	Y
LOK	Laminate	30" x 48"	Height	Oval Top Shape	Y base

Description

Oval Table with Y Base at 16"
Lounge Height
(continued)

Veneer Tables
"LKV" Models

Solid Surface Tables
"LKS" Models

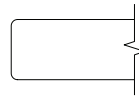

Eased Edge (R3)

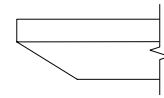

Reverse Bevel Edge (K9)

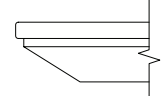

Reverse Bevel Edge (S7)

	D	W	H	CTN WT	CU FT	① Model	Veneer Tables "LKV" Models		Solid Surface Tables "LKS" Models		
							Essentials	Artisan	Essentials	Artisan	Standard
VEN.	30	48	16	68	18	LKV3048-160VY	\$2,001	\$2,114	\$2,204	\$2,306	--
S.S.	30	48	16	68	18	LKS3048-160VY	--	--	--	--	\$4,071

Electrical Options and Upcharges

CTEC23	
EC23 Power Center Top - Black	CTEC23BL - add \$663
EC23 Power Center Top - White	CTEC23WH - add \$663
CTEC24	
EC24 Power Center Top - Black	CTEC43BL - add \$549
EC24 Power Center Top - White	CTEC43WH - add \$549

To Order Specify

① Veneer Model #	② Edge Detail	③ Wood Collection	④ Wood Finish	⑤ Electrical	⑥ Metal Color
Veneer (LKV)	See Edge Detail Options	Essentials	See Essentials Wood Finish Options	N None CTEC23 Power Center Top CTEC24 Power Center Top (See chart above)	See Metal Finish Color Options
		Artisan	See Artisan Wood Finish Options		

① Solid Surface Model #	② Top Surface Selection	③ Electrical Cut Out	④ Metal Color
Solid Surface (LKS)	See Solid Surface Top Surface Selection Options	N None CTEC23 Power Center Top CTEC24 Power Center Top (See chart above)	See Metal Finish Color Options

LOK - LOUNGE

Description

Round Table with X Base at 16" Lounge Height



Laminate Tables "LKT" Models

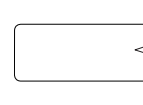

Eased Edge (R3)

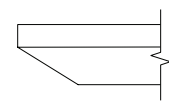

Reverse Bevel Edge (K9)

LAMINATE	D	W	H	CTN WT	CU FT	Model	Eased Edge (R3)		Reverse Bevel Edge (K9)	
							Standard Tier 1	Graded In Tier 2	Standard Tier 1	Graded In Tier 2
	42	42	16	68	18	LKT42-16RDX	\$1,355	\$1,465	\$1,784	\$1,895
36	36	16	55	17	LKT36-16RDX	\$1,250	\$1,266	\$1,715	\$1,731	
30	30	16	43	13	LKT30-16RDX	\$1,250	\$1,286	\$1,675	\$1,711	
24	24	16	35	12	LKT24-16RDX	\$1,007	\$1,019	\$1,462	\$1,470	

Features:

- price reflects complete table - top and base
- ships KD in multiple cartons
- model includes adjustable glide
- when electrical option is selected, power accessible base is shipped; see page 417 for details
- power/charging units have 72" cord
- power cord is routed inside base column

Options:

- specify power access base with power unit option; None (N), add \$663 for EC23 (CTEC23), add \$549 for EC24 (CTEC24)

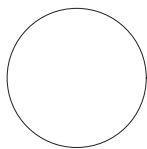

top shape

To Order Specify

1 Laminate Model #	2 Edge Detail	3 Laminate Selection	3a PVC Edge Color	4 Electrical	5 Metal Color
Laminate (LKT)	See Edge Detail Options	See Laminate Selection	See PVC Edge Color Options	N None CTEC23 Power Center Top CTEC24 Power Center Top (See chart on next page)	See Metal Finish Color Options

Model Number Breakdown

LKT42-16RDX					
LK	T	42	16	RD	X
LOK	Laminate	42" dia.	Height	Round Top Shape	X base

Description

Round Table with X Base at 16" Lounge Height (continued)

Veneer Tables "LKV" Models

Solid Surface Tables "LKS" Models

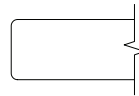

Eased Edge (R3)

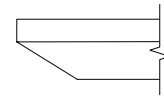

Reverse Bevel Edge (K9)

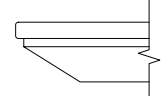

Reverse Bevel Edge (S7)

	D	W	H	CTN WT	CU FT	① Model	Veneer		Solid Surface		
							Essentials	Artisan	Essentials	Artisan	Standard
VENEER	42	42	16	68	18	LKV42-16RDX	\$1,723	\$1,852	\$1,940	\$2,056	--
	36	36	16	55	17	LKV36-16RDX	\$1,557	\$1,654	\$1,761	\$1,847	--
	30	30	16	43	13	LKV30-16RDX	\$1,535	\$1,610	\$1,749	\$1,813	--
	24	24	16	35	12	LKV24-16RDX	\$1,272	\$1,328	\$1,455	\$1,504	--
SOLID SURFACE	42	42	16	91	18	LKS42-16RDX	--	--	--	--	\$4,084
	36	36	16	71	17	LKS36-16RDX	--	--	--	--	\$3,407
	30	30	16	54	13	LKS30-16RDX	--	--	--	--	\$2,959
	24	24	16	41	12	LKS24-16RDX	--	--	--	--	\$2,425

Electrical Options and Upcharges

CTEC23	
EC23 Power Center Top - Black	CTEC23BL - add \$761
EC23 Power Center Top - White	CTEC23WH - add \$761
CTEC24	
EC24 Power Center Top - Black	CTEC43BL - add \$651
EC24 Power Center Top - White	CTEC43WH - add \$651

To Order Specify

① Veneer Model #	② Edge Detail	③ Wood Collection	④ Wood Finish	⑤ Electrical	⑥ Metal Color
Veneer (LKV)	R3 Eased K9 Reverse Bevel	Essentials	See Essentials Wood Finish Options	N None CTEC23 Power Center Top CTEC24 Power Center Top (See chart above)	See Metal Finish Color Options
	Artisan	④ Wood Finish	See Artisan Wood Finish Options		

① Solid Surface Model #	② Top Surface Selection	Electrical Cut Out	Metal Color
Solid Surface (LKS)	See Solid Surface Top Surface Selection Options		

LOK - LOUNGE

Description

Square Table with X Base at 16" Lounge Height

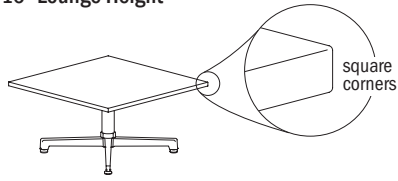

Laminate Tables "LKT" Models

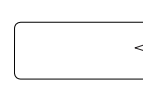

Eased Edge (R3)

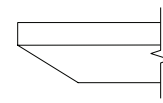

Reverse Bevel Edge (K9)

LAMINATE	D	W	H	CTN WT	CU FT	Model	Eased Edge (R3)		Reverse Bevel Edge (K9)	
							Standard Tier 1	Graded In Tier 2	Standard Tier 1	Graded In Tier 2
	36	36	16	65	17	LKT3636-16SQX	\$1,210	\$1,228	\$1,675	\$1,693
	30	30	16	50	13	LKT3030-16SQX	\$1,215	\$1,231	\$1,735	\$1,749
	24	24	16	38	9	LKT2424-16SQX	\$941	\$946	\$1,380	\$1,386

Features:

- price reflects complete table - top and base
- ships KD in multiple cartons
- model includes adjustable glide
- when electrical option is selected, power accessible base is shipped; see page 417 for details
- power/charging units have 72" cord
- power cord is routed inside base column

Options:

- specify power access base with power unit option; None (N), add \$761 for EC23 (CTEC23), add \$651 for EC24 (CTEC24)



top shape

To Order Specify

1 Laminate Model #	2 Edge Detail	3 Laminate Selection	3a PVC Edge Color	4 Electrical	5 Metal Color
Laminate (LKT)	See Edge Detail Options	See Laminate Selection	See PVC Edge Color Options	N None CTEC23 Power Center Top CTEC24 Power Center Top (See chart on next page)	See Metal Finish Color Options

Model Number Breakdown

LKT3636-16SQX					
LK	T	3636	16	SQ	X
LOK	Laminate	36" x 36"	Height	Square Top Shape	X Base

Description

Square Table with X Base at 16"
Lounge Height
(continued)

Veneer Tables
"LKV" Models



Eased Edge (R3)

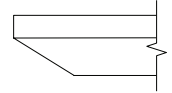

Reverse Bevel Edge (K9)

VENEER	D	W	H	CTN WT	CU FT	① Model	Essentials	Artisan	Essentials	Artisan
		36	36	16	65	17	LKV3636-16SQX	\$1,553	\$1,650	\$1,759
	30	30	16	50	13	LKV3030-16SQX	\$1,531	\$1,607	\$1,744	\$1,807
	24	24	16	38	9	LKV2424-16SQX	\$1,230	\$1,276	\$1,411	\$1,449

Electrical Options and Upcharges

CTEC23	
EC23 Power Center Top - Black	CTEC23BL - add \$761
EC23 Power Center Top - White	CTEC23WH - add \$761
CTEC24	
EC24 Power Center Top - Black	CTEC43BL - add \$651
EC24 Power Center Top - White	CTEC43WH - add \$651

To Order Specify

① Veneer Model #	② Edge Detail	③ Wood Collection	④ Wood Finish	⑤ Electrical	⑥ Metal Color
Veneer (LKV)	R3 Eased K9 Reverse Bevel	Essentials	See Essentials Wood Finish Options	N None CTEC23 Power Center Top CTEC24 Power Center Top (See chart above)	See Metal Finish Color Options
	Artisan	④ Wood Finish See Artisan Wood Finish Options			

LOK - LOUNGE

Description

Rounded Square Table with X Base at 16" Lounge Height

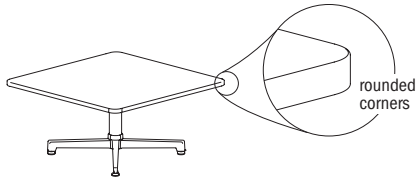

Laminate Tables
"LKT" Models

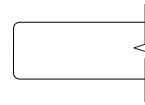

Eased Edge (R3)

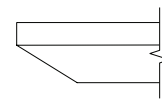

Reverse Bevel Edge (K9)

LAMINATE	D	W	H	CTN WT	CU FT	Model	Standard Tier 1	Graded In Tier 2	Standard Tier 1	Graded In Tier 2
		36	36	16	65	17	LKT3636-16SQRX	\$1,250	\$1,266	\$1,715
	30	30	16	50	13	LKT3030-16SQRX	\$1,238	\$1,286	\$1,675	\$1,711
	24	24	16	38	9	LKT2424-16SQRX	\$988	\$997	\$1,432	\$1,441

Features:

- price reflects complete table - top and base
- ships KD in multiple cartons
- model includes adjustable glide
- when electrical option is selected, power accessible base is shipped; see page 417 for details
- power/charging units have 72" cord
- power cord is routed inside base column

Options:

- specify power access base with power unit option; None (N), add \$761 for EC23 (CTEC23), add \$651 for EC24 (CTEC24)

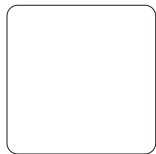

top shape

To Order Specify

1 Laminite Model #	2 Edge Detail	3 Laminite Selection	3a PVC Edge Color	4 Electrical	5 Metal Color
Laminite (LKT)	See Edge Detail Options	See Laminite Selection	See PVC Edge Color Options	N None CTEC23 Power Center Top CTEC24 Power Center Top (See chart on next page)	See Metal Finish Color Options

Model Number Breakdown

LKT3636-16SQRX						
LK	T	3636	16	SQ	R	X
LOK	Laminite	36" x 36"	Height	Square Top Shape	Rounded Corner	X Base

Description

Rounded Square Table with X Base at 16" Lounge Height (continued)

Veneer Tables "LKV" Models Solid Surface Tables "LKS" Models

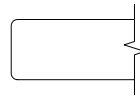

Eased Edge (R3)

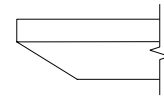

Reverse Bevel Edge (K9)

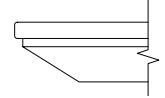

Reverse Bevel Edge (S7)

	D	W	H	CTN WT	CU FT	① Model	Veneer		Solid Surface		
							Essentials	Artisan	Essentials	Artisan	Standard
VENEER	36	36	16	65	17	LKV3636-16SQRX	\$1,595	\$1,692	\$1,800	\$1,885	--
	30	30	16	50	13	LKV3030-16SQRX	\$1,571	\$1,645	\$1,784	\$1,850	--
	24	24	16	38	9	LKV2424-16SQRX	\$1,272	\$1,328	\$1,455	\$1,504	--
SOLID SURFACE	36	36	16	86	17	LKS3636-16SQRX	--	--	--	--	\$3,445
	30	30	16	72	13	LKS3030-16SQRX	--	--	--	--	\$2,959
	24	24	16	47	9	LKS2424-16SQRX	--	--	--	--	\$2,425

Electrical Options and Upcharges

CTEC23	
EC23 Power Center Top - Black	CTEC23BL - add \$761
EC23 Power Center Top - White	CTEC23WH - add \$761
CTEC24	
EC24 Power Center Top - Black	CTEC43BL - add \$651
EC24 Power Center Top - White	CTEC43WH - add \$651

To Order Specify

① Veneer Model #	② Edge Detail	③ Wood Collection	④ Wood Finish	⑤ Electrical	⑥ Metal Color
Veneer (LKV)	R3 Eased K9 Reverse Bevel	Essentials	See Essentials Wood Finish Options	N None CTEC23 Power Center Top CTEC24 Power Center Top (See chart above)	See Metal Finish Color Options
	Artisan	④ Wood Finish	See Artisan Wood Finish Options		

① Solid Surface Model #	② Top Surface Selection	Electrical Cut Out	Metal Color
Solid Surface (LKS)	See Solid Surface Top Surface Selection Options		

LOK - LOUNGE

Description

Squirrel Table with X Base at 16" Lounge Height

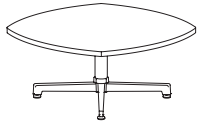

Laminate Tables
"LKT" Models

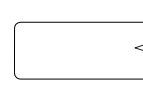

Eased Edge (R3)

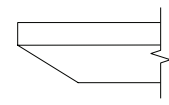

Reverse Bevel Edge (K9)

LAMINATE	D	W	H	CTN WT	CU FT	Model	Eased Edge (R3)		Reverse Bevel Edge (K9)	
							Standard	Graded In	Standard	Graded In
							Tier 1	Tier 2	Tier 1	Tier 2
	36	36	16	65	17	LKT36-16SCX	\$1,250	\$1,266	\$1,715	\$1,731
	30	30	16	50	13	LKT30-16SCX	\$1,250	\$1,286	\$1,675	\$1,711
	24	24	16	38	9	LKT24-16SCX	\$997	\$1,007	\$1,448	\$1,456

Features:

- price reflects complete table - top and base
- ships KD in multiple cartons
- model includes adjustable glide
- when electrical option is selected, power accessible base is shipped; see page 417 for details
- power/charging units have 72" cord
- power cord is routed inside base column

Options:

- specify power access base with power unit option; None (N), add \$761 for EC23 (CTEC23), add \$651 for EC24 (CTEC24)

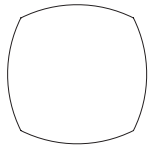

top shape

To Order Specify

1 Laminates Model #	2 Edge Detail	3 Laminates Selection	3a PVC Edge Color	4 Electrical	5 Metal Color
Laminates (LKT)	See Edge Detail Options	See Laminates Selection	See PVC Edge Color Options	N None CTEC23 Power Center Top CTEC24 Power Center Top (See chart on next page)	See Metal Finish Color Options

Model Number Breakdown

LKT36-16SCX					
LK	T	36	16	SC	X
LOK	Laminates	36" dia.	Height	Squirrel Top Shape	X Base

Description

Squirrel Table with X Base at 16" Lounge Height (continued)

Veneer Tables "LKV" Models

Solid Surface Tables "LKS" Models

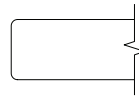

Eased Edge (R3)

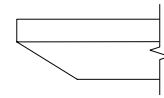

Reverse Bevel Edge (K9)

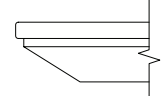

Reverse Bevel Edge (S7)

	D	W	H	CTN WT	CU FT	① Model	Veneer Tables "LKV" Models		Solid Surface Tables "LKS" Models		
							Essentials	Artisan	Essentials	Artisan	Standard
VENEER	36	36	16	65	17	LKV36-16SCX	\$1,595	\$1,692	\$1,800	\$1,885	--
	30	30	16	50	13	LKV30-16SCX	\$1,571	\$1,645	\$1,784	\$1,850	--
	24	24	16	38	9	LKV24-16SCX	\$1,272	\$1,328	\$1,455	\$1,504	--
SOLID SURFACE	36	36	16	86	17	LKS36-16SCX	--	--	--	--	\$3,445
	30	30	16	72	13	LKS30-16SCX	--	--	--	--	\$2,928
	24	24	16	47	9	LKS24-16SCX	--	--	--	--	\$2,425

Electrical Options and Upcharges

CTEC23	
EC23 Power Center Top - Black	CTEC23BL - add \$761
EC23 Power Center Top - White	CTEC23WH - add \$761
CTEC24	
EC24 Power Center Top - Black	CTEC43BL - add \$651
EC24 Power Center Top - White	CTEC43WH - add \$651

To Order Specify

① Veneer Model #	② Edge Detail	③ Wood Collection	④ Wood Finish	⑤ Electrical	⑥ Metal Color
Veneer (LKV)	R3 Eased K9 Reverse Bevel	Essentials	See Essentials Wood Finish Options	N None CTEC23 Power Center Top CTEC24 Power Center Top (See chart above)	See Metal Finish Color Options
	Artisan	④ Wood Finish	See Artisan Wood Finish Options		

① Solid Surface Model #	② Top Surface Selection	Electrical Cut Out	Metal Color
Solid Surface (LKS)	See Solid Surface Top Surface Selection Options		

LOK - LOUNGE

Description

Rectangular Table with Y Base
at 26" Chat Height

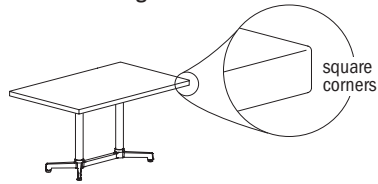

Laminate Tables
"LKT" Models

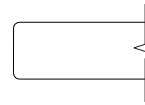

Eased Edge (R3)

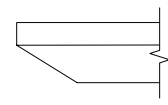

Reverse Bevel Edge (K9)

LAMINATE	D	W	H	CTN WT	CU FT	Model	Standard Tier 1	Graded In Tier 2	Standard Tier 1	Graded In Tier 2
	30	48	26	83	29	LKT3048-26TTY	\$1,677	\$1,696	\$2,142	\$2,161
	24	48	26	74	24	LKT2448-26TTY	\$1,609	\$1,623	\$2,068	\$2,084

Features:

- price reflects complete table - top and base
- ships KD in multiple cartons
- model includes adjustable glide
- power cord is routed outside base column
- order vertical wire manager separately; see page 454

Options:

- specify power unit option; None (N), add \$663 for EC23 (CTEC23), add \$549 for EC24 (CTEC24)



top shape

To Order Specify

1 Laminate Model #	2 Edge Detail	3 Laminate Selection	3a PVC Edge Color	4 Electrical	5 Metal Color
Laminate (LKT)	See Edge Detail Options	See Laminate Selection	See PVC Edge Color Options	N None CTEC23 Power Center Top CTEC24 Power Center Top (See chart on next page)	See Metal Finish Color Options

Model Number Breakdown

LKT3048-26TTY					
LK	T	3048	26	TT	Y
LOK	Laminate	30" x 48"	Height	Rectangular Top Shape	Y Base

Description

Rectangular Table with Y Base
at 26" Chat Height
(continued)

Veneer Tables
"LKV" Models

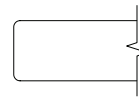

Eased Edge (R3)

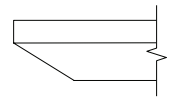

Reverse Bevel Edge (K9)

VENEER	D	W	H	CTN WT	CU FT	1 Model	Essentials	Artisan	Essentials	Artisan
	30	48	26	83	29	LKV3048-26TTY	\$1,961	\$2,062	\$2,160	\$2,248
24	48	26	74	24	LKV2448-26TTY	\$1,888	\$1,972	\$2,081	\$2,153	

Electrical Options and Upcharges

CTEC23	
EC23 Power Center Top - Black	CTEC23BL - add \$663
EC23 Power Center Top - White	CTEC23WH - add \$663
CTEC24	
EC24 Power Center Top - Black	CTEC43BL - add \$549
EC24 Power Center Top - White	CTEC43WH - add \$549

To Order Specify

1 Veneer Model #	2 Edge Detail	3 Wood Collection	4 Wood Finish	5 Electrical	6 Metal Color
Veneer (LKV)	R3 Eased K9 Reverse Bevel	Essentials	See Essentials Wood Finish Options	N None CTEC23 Power Center Top CTEC24 Power Center Top (See chart above)	See Metal Finish Color Options
	Artisan	4 Wood Finish See Artisan Wood Finish Options			

Description

Rounded Rectangular Table with Y Base at 26" Chat Height

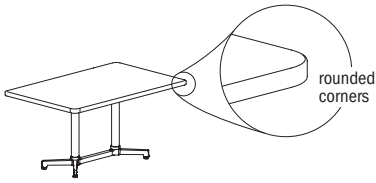

Laminate Tables
"LKT" Models

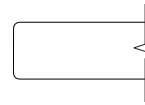

Eased Edge (R3)

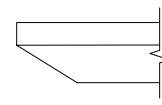

Reverse Bevel Edge (K9)

LAMINATE	D	W	H	CTN WT	CU FT	Model	Standard Tier 1	Graded In Tier 2	Standard Tier 1	Graded In Tier 2
	30	48	26	83	29	LKT3048-26TTRY	\$1,742	\$1,761	\$2,211	\$2,230
	24	48	26	79	24	LKT2448-26TTRY	\$1,646	\$1,662	\$2,106	\$2,120

Features:

- price reflects complete table - top and base
- ships KD in multiple cartons
- model includes adjustable glide
- power cord is routed outside base column
- order vertical wire manager separately; see page 454

Options:

- specify power unit option; None (N), add \$663 for EC23 (CTEC23), add \$549 for EC24 (CTEC24)



top shape

To Order Specify

1 Laminate Model #	2 Edge Detail	3 Laminate Selection	3a PVC Edge Color	4 Electrical	5 Metal Color
Laminate (LKT)	See Edge Detail Options	See Laminate Selection	See PVC Edge Color Options	N None CTEC23 Power Center Top CTEC24 Power Center Top (See chart on next page)	See Metal Finish Color Options

Model Number Breakdown

LKT3048-26TTRY						
LK	T	3048	26	TT	R	Y
LOK	Laminate	30" x 48"	Height	Rectangular Top Shape	Rounded Corner	Y Base

Description

Rounded Rectangular Table with Y Base at 26" Chat Height (continued)

Veneer Tables "LKV" Models Solid Surface Tables "LKS" Models

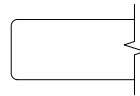

Eased Edge (R3)

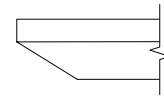

Reverse Bevel Edge (K9)

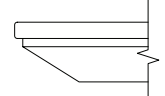

Reverse Bevel Edge (S7)

	D	W	H	CTN WT	CU FT	① Model	Veneer Tables "LKV" Models		Solid Surface Tables "LKS" Models		
							Essentials	Artisan	Essentials	Artisan	Standard
VENEER	30	48	26	83	29	LKV3048-26TTRY	\$2,015	\$2,130	\$2,220	\$2,321	--
	24	48	26	79	24	LKV2448-26TTRY	\$1,927	\$2,008	\$2,118	\$2,191	--
SOL. SURF.	30	48	26	83	29	LKS3048-26TTRY	--	--	--	--	\$4,087
	24	48	26	79	24	LKS2448-26TTRY	--	--	--	--	\$3,188

Electrical Options and Upcharges

CTEC23	
EC23 Power Center Top - Black	CTEC23BL - add \$663
EC23 Power Center Top - White	CTEC23WH - add \$663
CTEC24	
EC24 Power Center Top - Black	CTEC43BL - add \$549
EC24 Power Center Top - White	CTEC43WH - add \$549

To Order Specify

① Veneer Model #	② Edge Detail	③ Wood Collection	④ Wood Finish	⑤ Electrical	⑥ Metal Color
Veneer (LKV)	See Edge Detail Options	Essentials	See Essentials Wood Finish Options	N None CTEC23 Power Center Top CTEC24 Power Center Top (See chart above)	See Metal Finish Color Options
		Artisan	See Artisan Wood Finish Options		

① Solid Surface Model #	② Top Surface Selection	③ Electrical Cut Out	④ Metal Color
Solid Surface (LKS)	See Solid Surface Top Surface Selection Options	N None CTEC23 Power Center Top CTEC24 Power Center Top (See chart above)	See Metal Finish Color Options

LOK - LOUNGE

Description

Arc Rectangular Table with Y Base at 26" Chat Height

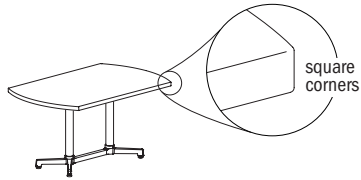

Laminate Tables
"LKT" Models

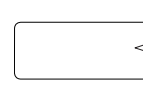

Eased Edge (R3)

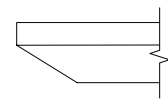

Reverse Bevel Edge (K9)

LAMINATE	D	W	H	CTN WT	CU FT	Model	Standard Tier 1	Graded In Tier 2	Standard Tier 1	Graded In Tier 2
		30	48	26	80	29	LKT3048-26ARY	\$1,742	\$1,761	\$2,211
	24	48	26	72	24	LKT2448-26ARY	\$1,646	\$1,662	\$2,106	\$2,120

Features:

- price reflects complete table - top and base
- ships KD in multiple cartons
- model includes adjustable glide
- power cord is routed outside base column
- order vertical wire manager separately; see page 454

Options:

- specify power unit option; None (N), add \$663 for EC23 (CTEC23), add \$549 for EC24 (CTEC24)



top shape

To Order Specify

1 Laminates Model #	2 Edge Detail	3 Laminates Selection	3a PVC Edge Color	4 Electrical	5 Metal Color
Laminates (LKT)	See Edge Detail Options	See Laminates Selection	See PVC Edge Color Options	N None CTEC23 Power Center Top CTEC24 Power Center Top (See chart on next page)	See Metal Finish Color Options

Model Number Breakdown

LKT3048-26ARY					
LK	T	3048	26	AR	Y
LOK	Laminates	30" x 48"	Height	Arc Rectangular Top Shape	Y Base

Description

Arc Rectangular Table with Y Base at 26" Chat Height (continued)

Veneer Tables "LKV" Models

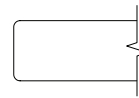

Eased Edge (R3)

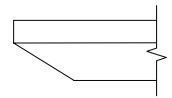

Reverse Bevel Edge (K9)

VENEER	D	W	H	CTN WT	CU FT	① Model	Essentials	Artisan	Essentials	Artisan
	30	48	26	80	29	LKV3048-26ARY	\$2,015	\$2,130	\$2,220	\$2,321
24	48	26	72	24	LKV2448-26ARY	\$1,927	\$2,008	\$2,118	\$2,191	

Electrical Options and Upcharges

CTEC23	
EC23 Power Center Top - Black	CTEC23BL - add \$663
EC23 Power Center Top - White	CTEC23WH - add \$663
CTEC24	
EC24 Power Center Top - Black	CTEC43BL - add \$549
EC24 Power Center Top - White	CTEC43WH - add \$549

To Order Specify

① Veneer Model #	② Edge Detail	③ Wood Collection	④ Wood Finish	⑤ Electrical	⑥ Metal Color
Veneer (LKV)	R3 Eased K9 Reverse Bevel	Essentials	See Essentials Wood Finish Options	N None CTEC23 Power Center Top CTEC24 Power Center Top (See chart above)	See Metal Finish Color Options
	Artisan	④ Wood Finish See Artisan Wood Finish Options			

Description

Rounded Arc Rectangular Table with Y Base at 26" Chat Height

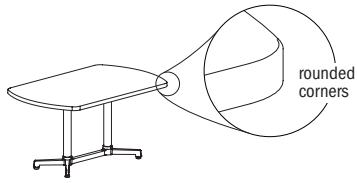

Laminate Tables
"LKT" Models

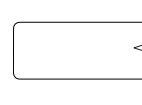

Eased Edge (R3)

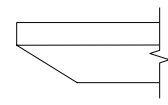

Reverse Bevel Edge (K9)

LAMINATE	D	W	H	CTN WT	CU FT	Model	Standard Tier 1	Graded In Tier 2	Standard Tier 1	Graded In Tier 2
	30	48	26	80	29	LKT3048-26ARRY	\$1,742	\$1,761	\$2,211	\$2,230
	24	48	26	77	24	LKT2448-26ARRY	\$1,646	\$1,662	\$2,106	\$2,120

Features:

- price reflects complete table - top and base
- ships KD in multiple cartons
- model includes adjustable glide
- power cord is routed outside base column
- order vertical wire manager separately; see page 454

Options:

- specify power unit option; None (N), add \$663 for EC23 (CTEC23), add \$549 for EC24 (CTEC24)



top shape

To Order Specify

1 Laminite Model #	2 Edge Detail	3 Laminite Selection	3a PVC Edge Color	4 Electrical	5 Metal Color
Laminite (LKT)	See Edge Detail Options	See Laminite Selection	See PVC Edge Color Options	N None CTEC23 Power Center Top CTEC24 Power Center Top (See chart on next page)	See Metal Finish Color Options

Model Number Breakdown

LKT3048-26ARRY						
LK	T	3048	26	AR	R	Y
LOK	Laminite	30" x 48"	Height	Arc Rectangular Top Shape	Rounded Corner	Y Base

Description

Rounded Arc Rectangular Table with Y Base at 26" Chat Height (continued)

Veneer Tables "LKV" Models

Solid Surface Tables "LKS" Models

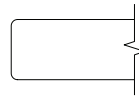

Eased Edge (R3)

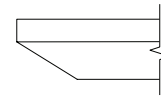

Reverse Bevel Edge (K9)

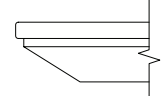

Reverse Bevel Edge (S7)

	D	W	H	CTN WT	CU FT	① Model	Veneer Tables "LKV" Models		Solid Surface Tables "LKS" Models		
							Essentials	Artisan	Essentials	Artisan	Standard
VENEER	30	48	26	80	29	LKV3048-26ARRY	\$2,015	\$2,130	\$2,220	\$2,321	--
	24	48	26	77	24	LKV2448-26ARRY	\$1,927	\$2,008	\$2,118	\$2,191	--
SOL. SURF.	30	48	26	80	29	LKS3048-26ARRY	--	--	--	--	\$4,087
	24	48	26	77	24	LKS2448-26ARRY	--	--	--	--	\$3,188

Electrical Options and Upcharges

CTEC23	
EC23 Power Center Top - Black	CTEC23BL - add \$663
EC23 Power Center Top - White	CTEC23WH - add \$663
CTEC24	
EC24 Power Center Top - Black	CTEC43BL - add \$549
EC24 Power Center Top - White	CTEC43WH - add \$549

To Order Specify

① Veneer Model #	② Edge Detail	③ Wood Collection	④ Wood Finish	⑤ Electrical	⑥ Metal Color
Veneer (LKV)	See Edge Detail Options	Essentials	See Essentials Wood Finish Options	N None CTEC23 Power Center Top CTEC24 Power Center Top (See chart above)	See Metal Finish Color Options
		Artisan	See Artisan Wood Finish Options		

① Solid Surface Model #	② Top Surface Selection	③ Electrical Cut Out	④ Metal Color
Solid Surface (LKS)	See Solid Surface Top Surface Selection Options	N None CTEC23 Power Center Top CTEC24 Power Center Top (See chart above)	See Metal Finish Color Options

LOK - LOUNGE

Description

Oval Table with Y Base at 26" Chat Height



Laminate Tables
"LKT" Models

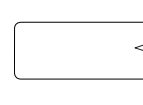

Eased Edge (R3)

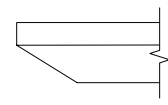

Reverse Bevel Edge (K9)

LAMI	D	W	H	CTN WT	CU FT	Model	Standard Tier 1	Graded In Tier 2	Standard Tier 1	Graded In Tier 2
		30	48	26	74	29	LKT3048-260VY	\$1,725	\$1,747	\$2,194

Features:

- price reflects complete table - top and base
- ships KD in multiple cartons
- model includes adjustable glide
- power cord is routed outside base column
- order vertical wire manager separately; see page 454

Options:

- specify power unit option; None (N), add \$663 for EC23 (CTEC23), add \$549 for EC24 (CTEC24)

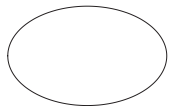

top shape

To Order Specify

1 Laminate Model #	2 Edge Detail	3 Laminate Selection	3a PVC Edge Color	4 Electrical	5 Metal Color
Laminate (LKT)	See Edge Detail Options	See Laminate Selection	See PVC Edge Color Options	N None CTEC23 Power Center Top CTEC24 Power Center Top (See chart on next page)	See Metal Finish Color Options

Model Number Breakdown

LKT3048-260VY					
LK	T	3048	26	OV	Y
LOK	Laminate	30" x 48"	Height	Oval Top Shape	Y Base

Description

Oval Table with Y Base at 26"
 Chat Height
 (continued)

Veneer Tables "LKV" Models				Solid Surface Tables "LKS" Models	
-------------------------------	--	--	--	--------------------------------------	--

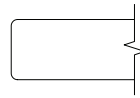

Eased Edge (R3)

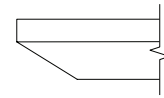

Reverse Bevel Edge (K9)

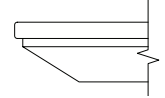

Reverse Bevel Edge (S7)

	D	W	H	CTN WT	CU FT	① Model	Veneer Tables "LKV" Models		Solid Surface Tables "LKS" Models		
							Essentials	Artisan	Essentials	Artisan	Standard
VEN.	30	48	26	74	29	LKV3048-260VY	\$2,002	\$2,114	\$2,205	\$2,306	--
S.S.	30	48	26	74	29	LKS3048-260VY	--	--	--	--	\$4,072

Electrical Options and Upcharges

CTEC23	
EC23 Power Center Top - Black	CTEC23BL - add \$663
EC23 Power Center Top - White	CTEC23WH - add \$663
CTEC24	
EC24 Power Center Top - Black	CTEC43BL - add \$549
EC24 Power Center Top - White	CTEC43WH - add \$549

To Order Specify

① Veneer Model #	② Edge Detail	③ Wood Collection	④ Wood Finish	⑤ Electrical	⑥ Metal Color
Veneer (LKV)	See Edge Detail Options	Essentials	See Essentials Wood Finish Options	N None CTEC23 Power Center Top CTEC24 Power Center Top (See chart above)	See Metal Finish Color Options
		Artisan	See Artisan Wood Finish Options		

① Solid Surface Model #	② Top Surface Selection	③ Electrical Cut Out	④ Metal Color
Solid Surface (LKS)	See Solid Surface Top Surface Selection Options	N None CTEC23 Power Center Top CTEC24 Power Center Top (See chart above)	See Metal Finish Color Options

LOK - LOUNGE

Description

Round Table with X Base at 26" Chat Height



Laminate Tables "LKT" Models

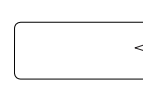

Eased Edge (R3)

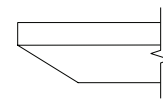

Reverse Bevel Edge (K9)

LAMINATE	D	W	H	CTN WT	CU FT	Model	Eased Edge (R3)		Reverse Bevel Edge (K9)	
							Standard Tier 1	Graded In Tier 2	Standard Tier 1	Graded In Tier 2
		42	42	26	77	35	LKT42-26RDX	\$1,382	\$1,494	\$1,822
	36	36	26	63	26	LKT36-26RDX	\$1,301	\$1,318	\$1,785	\$1,801
	30	30	26	51	19	LKT30-26RDX	\$1,290	\$1,325	\$1,727	\$1,762
	24	24	26	41	13	LKT24-26RDX	\$1,027	\$1,037	\$1,491	\$1,501

Features:

- price reflects complete table - top and base
- ships KD in multiple cartons
- model includes adjustable glide
- when electrical option is selected, power accessible base is shipped; see page 417 for details
- power/charging units have 72" cord
- power cord is routed inside base column

Options:

- specify power access base with power unit option; None (N), add \$761 for EC23 (CTEC23), add \$651 for EC24 (CTEC24)

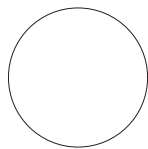

top shape

To Order Specify

1 Laminate Model #	2 Edge Detail	3 Laminate Selection	3a PVC Edge Color	4 Electrical	5 Metal Color
Laminate (LKT)	See Edge Detail Options	See Laminate Selection	See PVC Edge Color Options	N None CTEC23 Power Center Top CTEC24 Power Center Top (See chart on next page)	See Metal Finish Color Options

Model Number Breakdown

LKT42-26RDX					
LK	T	42	26	RD	X
LOK	Laminate	42" dia.	Height	Round Top Shape	X Base

Description

Round Table with X Base at 26" Chat Height (continued)

Veneer Tables "LKV" Models

Solid Surface Tables "LKS" Models

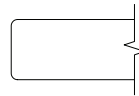

Eased Edge (R3)

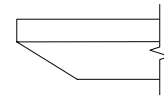

Reverse Bevel Edge (K9)

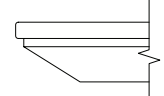

Reverse Bevel Edge (S7)

	D	W	H	CTN WT	CU FT	① Model	Veneer		Solid Surface		
							Essentials	Artisan	Essentials	Artisan	Standard
VENEER	42	42	26	77	35	LKV42-26RDX	\$1,846	\$1,974	\$2,062	\$2,177	--
	36	36	26	63	26	LKV36-26RDX	\$1,595	\$1,692	\$1,800	\$1,885	--
	30	30	26	51	19	LKV30-26RDX	\$1,571	\$1,645	\$1,784	\$1,850	--
	24	24	26	41	13	LKV24-26RDX	\$1,272	\$1,328	\$1,455	\$1,504	--
SOLID SURFACE	42	42	26	99	35	LKS42-26RDX	--	--	--	--	\$4,206
	36	36	26	79	26	LKS36-26RDX	--	--	--	--	\$3,445
	30	30	26	62	19	LKS30-26RDX	--	--	--	--	\$3,111
	24	24	26	48	13	LKS24-26RDX	--	--	--	--	\$2,805

Electrical Options and Upcharges

CTEC23	
EC23 Power Center Top - Black	CTEC23BL - add \$761
EC23 Power Center Top - White	CTEC23WH - add \$761
CTEC24	
EC24 Power Center Top - Black	CTEC43BL - add \$651
EC24 Power Center Top - White	CTEC43WH - add \$651

To Order Specify

① Veneer Model #	② Edge Detail	③ Wood Collection	④ Wood Finish	⑤ Electrical	⑥ Metal Color
Veneer (LKV)	R3 Eased K9 Reverse Bevel	Essentials	See Essentials Wood Finish Options	N None CTEC23 Power Center Top CTEC24 Power Center Top (See chart above)	See Metal Finish Color Options
	Artisan	④ Wood Finish	See Artisan Wood Finish Options		

① Solid Surface Model #	② Top Surface Selection	Electrical Cut Out	Metal Color
Solid Surface (LKS)	See Solid Surface Top Surface Selection Options		

LOK - LOUNGE

Description

Square Table with X Base
at 26" Chat Height

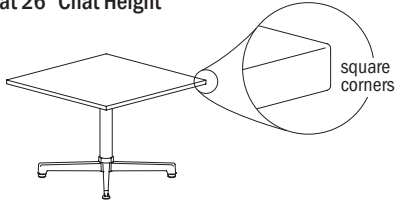

Laminate Tables
"LKT" Models

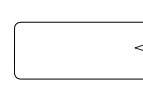

Eased Edge (R3)

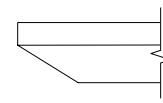

Reverse Bevel Edge (K9)

LAMINATE	D	W	H	CTN WT	CU FT	① Model	Standard Tier 1	Graded In Tier 2	Standard Tier 1	Graded In Tier 2
		36	36	26	73	26	LKT3636-26SQX	\$1,261	\$1,278	\$1,745
	30	30	26	57	19	LKT3030-26SQX	\$1,215	\$1,231	\$1,735	\$1,749
	24	24	26	45	13	LKT2424-26SQX	\$979	\$987	\$1,435	\$1,445

Features:

- price reflects complete table - top and base
- ships KD in multiple cartons
- model includes adjustable glide
- when electrical option is selected, power accessible base is shipped; see page 417 for details
- power/charging units have 72" cord
- power cord is routed inside base column

Options:

- specify power access base with power unit option; None (N), add \$761 for EC23 (CTEC23), add \$651 for EC24 (CTEC24)

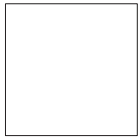

top shape

To Order Specify

① Laminate Model #	② Edge Detail	③ Laminate Selection	④ PVC Edge Color	⑤ Electrical	⑥ Metal Color
Laminate (LKT)	See Edge Detail Options	See Laminate Selection	See PVC Edge Color Options	N None CTEC23 Power Center Top CTEC24 Power Center Top (See chart on next page)	See Metal Finish Color Options

Model Number Breakdown

LKT3636-26SQX					
LK	T	3636	26	SQ	X
LOK	Laminate	36" x 36"	Height	Square Top Shape	X Base

Description

Square Table with X Base
at 26" Chat Height
(continued)

Veneer Tables
"LKV" Models

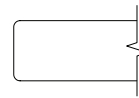

Eased Edge (R3)

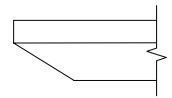

Reverse Bevel Edge (K9)

D	W	H	CTN WT	CU FT	① Model	Essentials		Artisan	
						Essentials	Artisan	Essentials	Artisan
36	36	26	73	26	LKV3636-26SQX	\$1,553	\$1,650	\$1,759	\$1,842
30	30	26	57	19	LKV3030-26SQX	\$1,531	\$1,607	\$1,744	\$1,807
24	24	26	45	13	LKV2424-26SQX	\$1,230	\$1,276	\$1,411	\$1,449

VENEER

Electrical Options and Upcharges

CTEC23	
EC23 Power Center Top - Black	CTEC23BL - add \$761
EC23 Power Center Top - White	CTEC23WH - add \$761
CTEC24	
EC24 Power Center Top - Black	CTEC43BL - add \$651
EC24 Power Center Top - White	CTEC43WH - add \$651

To Order Specify

① Veneer Model #	② Edge Detail	③ Wood Collection	④ Wood Finish	⑤ Electrical	⑥ Metal Color
Veneer (LKV)	R3 Eased K9 Reverse Bevel	Essentials	See Essentials Wood Finish Options	N None CTEC23 Power Center Top CTEC24 Power Center Top (See chart above)	See Metal Finish Color Options
	Artisan	④ Wood Finish See Artisan Wood Finish Options			

LOK - LOUNGE

Description

Rounded Square Table with X Base at 26" Chat Height

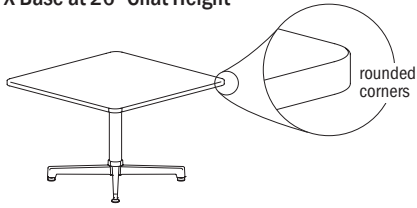

Laminate Tables
"LKT" Models

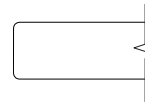

Eased Edge (R3)

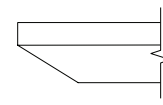

Reverse Bevel Edge (K9)

LAMINATE	D	W	H	CTN WT	CU FT	1 Model	Standard Tier 1	Graded In Tier 2	Standard Tier 1	Graded In Tier 2
		36	36	26	73	26	LKT3636-26SQRX	\$1,301	\$1,318	\$1,785
	30	30	26	57	19	LKT3030-26SQRX	\$1,290	\$1,325	\$1,727	\$1,762
	24	24	26	45	13	LKT2424-26SQRX	\$1,027	\$1,037	\$1,491	\$1,501

Features:

- price reflects complete table - top and base
- ships KD in multiple cartons
- model includes adjustable glide
- when electrical option is selected, power accessible base is shipped; see page 417 for details
- power/charging units have 72" cord
- power cord is routed inside base column

Options:

- specify power access base with power unit option; None (N), add \$761 for EC23 (CTEC23), add \$651 for EC24 (CTEC24)

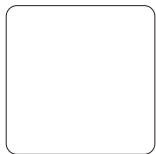

top shape

To Order Specify

1 Laminate Model #	2 Edge Detail	3 Laminate Selection	3a PVC Edge Color	4 Electrical	5 Metal Color
Laminate (LKT)	See Edge Detail Options	See Laminate Selection	See PVC Edge Color Options	N None CTEC23 Power Center Top CTEC24 Power Center Top (See chart on next page)	See Metal Finish Color Options

Model Number Breakdown

LKT3636-26SQRX						
LK	T	3636	26	SQ	R	X
LOK	Laminate	36" x 36"	Height	Square Top Shape	Rounded Corner	X Base

Description

Rounded Square Table with X Base at 26" Chat Height (continued)

Veneer Tables "LKV" Models

Solid Surface Tables "LKS" Models

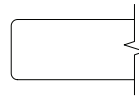

Eased Edge (R3)

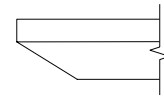

Reverse Bevel Edge (K9)

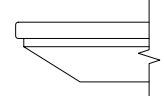

Reverse Bevel Edge (S7)

	D	W	H	CTN WT	CU FT	① Model	Veneer		Solid Surface		
							Essentials	Artisan	Essentials	Artisan	Standard
VENEER	36	36	26	73	26	LKV3636-26SQRX	\$1,595	\$1,692	\$1,800	\$1,885	--
	30	30	26	57	19	LKV3030-26SQRX	\$1,571	\$1,645	\$1,784	\$1,850	--
	24	24	26	45	13	LKV2424-26SQRX	\$1,272	\$1,328	\$1,455	\$1,504	--
SOLID SURFACE	36	36	26	94	26	LKS3636-26SQRX	--	--	--	--	\$3,445
	30	30	26	72	19	LKS3030-26SQRX	--	--	--	--	\$3,111
	24	24	26	54	13	LKS2424-26SQRX	--	--	--	--	\$2,805

Electrical Options and Upcharges

CTEC23	
EC23 Power Center Top - Black	CTEC23BL - add \$761
EC23 Power Center Top - White	CTEC23WH - add \$761
CTEC24	
EC24 Power Center Top - Black	CTEC43BL - add \$651
EC24 Power Center Top - White	CTEC43WH - add \$651

To Order Specify

① Veneer Model #	② Edge Detail	③ Wood Collection	④ Wood Finish	⑤ Electrical	⑥ Metal Color
Veneer (LKV)	R3 Eased K9 Reverse Bevel	Essentials	See Essentials Wood Finish Options	N None CTEC23 Power Center Top CTEC24 Power Center Top (See chart above)	See Metal Finish Color Options
	Artisan	④ Wood Finish See Artisan Wood Finish Options			

① Solid Surface Model #	② Top Surface Selection	Electrical Cut Out	Metal Color
Solid Surface (LKS)	See Solid Surface Top Surface Selection Options		

LOK - LOUNGE

Description

Squircle Table with X Base
at 26" Chat Height



Laminate Tables
"LKT" Models

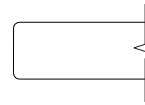

Eased Edge (R3)

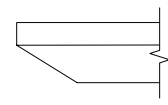

Reverse Bevel Edge (K9)

LAMINATE	D	W	H	CTN WT	CU FT	① Model	Eased Edge (R3)		Reverse Bevel Edge (K9)	
							Standard	Graded In	Standard	Graded In
							Tier 1	Tier 2	Tier 1	Tier 2
	36	36	26	73	26	LKT36-26SCX	\$1,301	\$1,318	\$1,785	\$1,801
	30	30	26	57	19	LKT30-26SCX	\$1,290	\$1,325	\$1,727	\$1,762
	24	24	26	45	13	LKT24-26SCX	\$1,027	\$1,037	\$1,491	\$1,501

Features:

- price reflects complete table - top and base
- ships KD in multiple cartons
- model includes adjustable glide
- when electrical option is selected, power accessible base is shipped; see page 417 for details
- power/charging units have 72" cord
- power cord is routed inside base column

Options:

- specify power access base with power unit option; None (N), add \$761 for EC23 (CTEC23), add \$651 for EC24 (CTEC24)

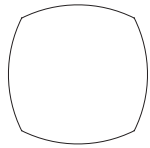

top shape

To Order Specify

① Laminate Model #	② Edge Detail	③ Laminate Selection	④ PVC Edge Color	⑤ Electrical	⑥ Metal Color
Laminate (LKT)	See Edge Detail Options	See Laminate Selection	See PVC Edge Color Options	N None CTEC23 Power Center Top CTEC24 Power Center Top (See chart on next page)	See Metal Finish Color Options

Model Number Breakdown

LKT36-26SCX					
LK	T	36	26	SC	X
LOK	Laminate	36"	Height	Squircle Top Shape	X Base

Description

Squirrel Table with X Base at 26" Chat Height (continued)

Veneer Tables "LKV" Models

Solid Surface Tables "LKS" Models

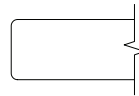

Eased Edge (R3)

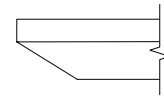

Reverse Bevel Edge (K9)

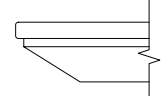

Reverse Bevel Edge (S7)

	D	W	H	CTN WT	CU FT	① Model	Veneer Tables		Solid Surface Tables		
							Essentials	Artisan	Essentials	Artisan	Standard
VENEER	36	36	26	73	26	LKV36-26SCX	\$1,595	\$1,692	\$1,800	\$1,885	--
	30	30	26	57	19	LKV30-26SCX	\$1,571	\$1,645	\$1,784	\$1,850	--
	24	24	26	45	13	LKV24-26SCX	\$1,272	\$1,328	\$1,455	\$1,504	--
SOLID SURFACE	36	36	26	94	26	LKS36-26SCX	--	--	--	--	\$3,445
	30	30	26	72	19	LKS30-26SCX	--	--	--	--	\$3,111
	24	24	26	54	13	LKS24-26SCX	--	--	--	--	\$2,805

Electrical Options and Upcharges

CTEC23	
EC23 Power Center Top - Black	CTEC23BL - add \$761
EC23 Power Center Top - White	CTEC23WH - add \$761
CTEC24	
EC24 Power Center Top - Black	CTEC43BL - add \$651
EC24 Power Center Top - White	CTEC43WH - add \$651

To Order Specify

① Veneer Model #	② Edge Detail	③ Wood Collection	④ Wood Finish	⑤ Electrical	⑥ Metal Color
Veneer (LKV)	R3 Eased K9 Reverse Bevel	Essentials	See Essentials Wood Finish Options	N None CTEC23 Power Center Top CTEC24 Power Center Top (See chart above)	See Metal Finish Color Options
	Artisan	④ Wood Finish See Artisan Wood Finish Options			

① Solid Surface Model #	② Top Surface Selection	Electrical Cut Out	Metal Color
Solid Surface (LKS)	See Solid Surface Top Surface Selection Options		

LOK - LOUNGE

Description	D	W	H	CTN WT	CU FT	① Model	List Price
Power Strip	1 1/2	1 7/8	8	3	1	GP9ACP1-0212	\$96

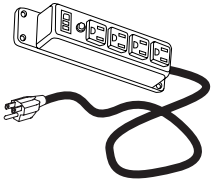

Features:

- power surge with 10" cord
- four electrical outlets
- includes switch
- field installed

Wire Management Velcro Straps	1 3/4	3 1/2	1/4	1	1	04WVS	\$58
-------------------------------	-------	-------	-----	---	---	-------	------



Features:

- black, set of 4
- field installed to bottom of table top, with adhesive tape provided

Cable Management Clips	2 5/8	3 3/4	1 5/8	1	1	0304CMC	\$56
------------------------	-------	-------	-------	---	---	---------	------

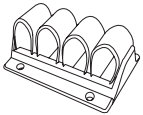

Features:

- black plastic
- installed to bottom of table top
- four retention loops

To Order, Specify:

① Model Number	
----------------	--

Accessories/ Keyboard/ Tasklights

For an additional list of electrical units, grommets, keyboards, wire management, monitor arms & telecom jacks, please see our [accessories price list](#)

Contact your customer service representative for specific questions regarding which units can be used with Lok Lounge.

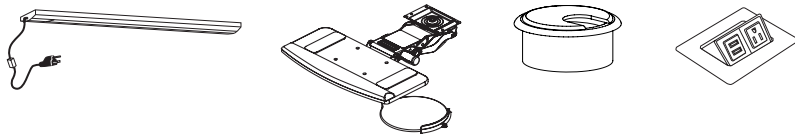



Formica Laminate

Nosh offers an extensive program for laminates beyond our Standard Program. Always reference below the most current listing and tier pricing when using a Graded-In Laminate; on page NS3 select the color of the PVC edge color.

Laminate	Pattern-Sheen	Tier	Laminate	Pattern-Sheen	Tier	Laminate	Pattern-Sheen	Tier	Laminate	Pattern-Sheen	Tier
Acajou Mahogany	7008-58	2	Dark Chocolate	2200-58	2	Mission White	933-58	2	Smoke Onyx	3710-58	2
Aged Ash	8844-58	2	Denim	8822-58	2	Mocha Travertine	3456-58	2	Smoke Quarstone	6220-58	2
Algae	8796-58	2	Desert Beige	899-58	2	Mojave	8751-58	2	Smokey Brown Pear	5488-58	2
Almond	920-58	2	Dover White	7197-58	2	Moonstone	7872-58	2	Solar Orange	8235-58	2
Aluminum	9318-58	2	Earth	5342-58	2	Mouse	928-58	2	Sorrel Cherry	5886-58	2
Amber Kashmir	6227-58	2	Earth Wash	7213-58	2	Muslin Fabric	6127-58	2	Spectrum Blue	851-58	2
Amber Maple	7012-58	2	Earthen Twill	8828-58	2	Natural Ash	8843-58	2	Spectrum Green	7897-58	2
Antique White	932-58	2	Earthen Warp	5880-58	2	Natural Birch	7481-58	2	Spectrum Red	845-58	2
Argento Romano	6697-58	2	Earthenware	8241-58	2	Natural Canvas	7022-58	2	Stainless	9319-58	2
Artichoke	800-58	2	Earthenware	6999-58	2	Natural Gray Felt	4971-58	2	Star Dune	9309-58	2
Ashwood Beige	5785-58	2	Brushstroke		2	Natural Maple	756-58	2	Starched Paperfold	8678-58	2
Ashwood Bone	5784-58	2	Ebony	9012-58	2	Natural Oak	346-58	2	Stone Grafix	503-58	2
Ashwood Oak	5786-58	2	Ebony Oxide	299-58	2	Natural Recycled Kraft	9684-58	2	Stop Red	839-58	2
Basalt Slate	3690-58	2	Elemental Concrete	8830-58	2	Natural Riftwood	9282-58	2	Storm	912-58	2
Beige Elm	5794-58	2	Elemental Stone	8831-58	2	Natural Teak	8849-58	2	Storm Solidz	3505-58	2
Belmonte Granite	3496-58	2	Espresso Pear	5489-58	2	Navy Blue	969-58	2	Storm Teakwood	8908-58	2
Birchbark	8684-58	2	Finnish Oak	118-58	2	Navy Grafix	7018-58	2	Sugar Glass	3705-58	2
Black	909-58	2	Flax Gauze	7708-58	2	Neo Cloud	6314-58	2	Surf	923-58	2
Black Bardiglio	5019-58	2	Flint Crystal	3518-58	2	Neutral Twill	8826-58	2	Swede Rift Oak	8676-58	2
Black Birchply	8552-58	2	Fog	961-58	2	Neutral Weft	5875-58	2	Taupe Walnut	5787-58	2
Black Recycled Kraft	9685-58	2	Folkstone	927-58	2	Neutral White	918-58	2	Terril	2297-58	2
Black Riftwood	6414-58	2	Folkstone Celesta	692-58	2	New Burgundy	7966-58	2	Thermo Walnut	6402-58	2
Black Shalestone	9527-58	2	Folkstone Grafix	507-58	2	Night Forest	8244-58	2	Travertine	3526-58	2
Black Walnut	3485-58	2	Formal Walnut	5782-58	2	Night Shade	8243-58	2	Tula Oak	8589-58	2
Blackened Fiberwood	8916-58	2	Fossil	5349-58	2	Noble Mahogany	9236-58	2	Venetian Gold Granite	6223-58	2
Blackened Legno	8848-58	2	Fox Teakwood	8907-58	2	Nocturne	5323-58	2	Vibrant Green	6901-58	2
Blackened Steel	8918-58	2	Geriba Gray	9308-58	2	Noir Cedar	1547-58	2	Walnut Butcherblock	3712-58	2
Blackstone	271-58	2	Ginger Root Maple	7288-58	2	Noir Envision	7500-58	2	Walnut Fiberwood	8915-58	2
Bleached Legno	8845-58	2	Glamour Cherry	6208-58	2	Nut Brown Cherry	5790-58	2	Walnut Riftwood	9283-58	2
Blond Cedar	8576-58	2	Glass Cloth	8683-58	2	Oiled Legno	8846-58	2	Walnut Softwood	4925-58	2
Blossom Cherrywood	758-58	2	Gold Braze	1193-58	2	Oiled Walnut	5487-58	2	Washi Paperfold	8680-58	2
Blue Felt	9320-58	2	Graphite	837-58	2	Orange Felt	4973-58	2	Waxed Maple	8905-58	2
Blush	8238-58	2	Graphite Elm	5796-58	2	Origami Paperfold	8679-58	2	Weathered Ash	8842-58	2
Brazilian Brown Granite	6222-58	2	Graphite Grafix	515-58	2	Otter	3202-58	2	Weathered Fiberwood	8914-58	2
Brite White	459-58	2	Graphite Twill	8829-58	2	Oxidized Beamwood	9484-58	2	Wenge Strand	6306-58	2
Bronzed Steel	8919-58	2	Gray Fabric	6129-58	2	Oyster Grey	929-58	2	Wheat Strand	6212-58	2
Bubble Art	8958-58	2	Gray Grafix	9300-58	2	Pale Brushstroke	6997-58	2	White	949-58	2
Buff Elm	5793-58	2	Gray Onyx	7409-58	2	Paloma Polar	6698-58	2	White Ash	8841-58	2
Burnished Coin	3708-58	2	Grayed Oak	5791-58	2	Patine Bronze	3707-58	2	White Bardiglio	9306-58	2
Burnished Iron	3709-58	2	Graystone	464-58	2	Patine Concrete	3706-58	2	White Drops	8824-58	2
Burnt Strand	6307-58	2	Green Felt	4974-58	2	Pearl	934-58	2	White Ice Granite	9476-58	2
Butterum Granite	7732-58	2	Green Slate	8793-58	2	Pecan Walnut	6996-58	2	White Marble	9310-58	2
Camel Elm	5795-58	2	Greige Softwood	4924-58	2	Pecan Woodline	5883-58	2	Herringbone		2
Cardboard Solidz	7813-58	2	Gull Grey	9242-58	2	Pencil Wood	7747-58	2	White Onyx	827-58	2
Carrara Bianco	6696-58	2	Hard Rock Maple	86992-58	2	Perlato Granite	3522-58	2	White Painted Wood	8902-58	2
Carrara Envision	7494-58	2	Hazel Walnut	5788-58	2	Planked Coffee Oak	7413-58	2	White Pearl Cascade	3720-58	2
Cascara Teakwood	8909-58	2	Ice Onyx	7408-58	2	Planked Deluxe Pear	6206-58	2	White Shalestone	9525-58	2
Cassis	6903-58	2	Inked Oak	5792-58	2	Planked Raw Oak	7412-58	2	White Thewill	9285-58	2
Ceruse Gray Walnut	6994-58	2	Ivory Kashmir	6226-58	2	Planked Urban Oak	9312-58	2	White Washed	6372-58	2
Chambray Fabric	6130-58	2	Jadeite	1198-58	2	Platinum	902-58	2	Birchply		2
Charcoal Boomerang	6942-58	2	Jamocho Granite	7734-58	2	Portico Marble	7735-58	2	Wild Cherry	5904-58	2
Chelsea Maple	9238-58	2	Just Rose	8858-58	2	Prestige Walnut	6209-58	2	Winter Sky	8792-58	2
Cherry Heartwood	9240-58	2	Labrador Granite	3692-58	2	Pumice	858-58	2	Wood Brushstroke	6998-58	2
Cherry Walnut	6995-58	2	Layered Black Sand	9510-58	2	Purple Dye	1196-58	2	Woolen Cloth	8682-58	2
Chestnut Woodline	5884-58	2	Layered Sand	9511-58	2	Raw Birchply	8910-58	2	Yellow Felt	4972-58	2
Chrome Yellow	1485-58	2	Layered White Sand	9512-58	2	Raw Cedar	1545-58	2			
Cinnamon Cherry	8955-58	2	Lime Stone	7264-58	2	Sail White	463-58	2			
Citadel	1097-58	2	Liquid Glass	8240-58	2	Sand Crystal	3517-58	2			
Citadel Warp	5882-58	2	Luxe Mango	8685-58	2	Sand Maple	9237-58	2			
Classic White	9244-58	2	Macchiato Walnut	6932-58	2	Sarum Grey	2770-58	2			
Clementine	2962-58	2	Maple Woodline	6925-58	2	Sarum Twill	8827-58	2			
Clove Spice Cherry	5789-58	2	Marine Blue	914-58	2	Scandi Rift Oak	8677-58	2			
Cocoa Maple	7739-58	2	Marmara Beige	7406-58	2	Sea Salt	9529-58	2			
Cocoa Oak	9374-58	2	Marmara Gray	7407-58	2	Seasoned Planked Elm	6477-58	2			
Cognac Maple	7738-58	2	Matrix Blue	8795-58	2	Select Cherry	7759-58	2			
Concrete Formwood	6362-58	2	Mdf Solidz	7812-58	2	Sheer Fabric	6126-58	2			
Concrete Stone	7267-58	2	Midnight Stone	6280-58	2	Silver Quartzite	9497-58	2			
Cotton Cloth	8681-58	2	Milk	9634-58	2	Silver Riftwood	6413-58	2			
Cream Softwood	4923-58	2	Millennium Oak	5887-58	2	Silver Shalestone	9307-58	2			
Danish Maple	8906-58	2	Mineral Jet	3450-58	2	Slate Noir	3711-58	2			
			Mineral Spa	6920-58	2	Smoke	3245-58	2			

Wilsonart Laminate

Nosh offers an extensive program for laminates beyond our Standard Program. Always reference below the most current listing and tier pricing when using a Graded-In Laminate; see below on the PVC edge color selection.

Laminate	Pattern-Sheen	Tier	Laminate	Pattern-Sheen	Tier	Laminate	Pattern-Sheen	Tier	Laminate	Pattern-Sheen	Tier
Almond Leather	2932-60	2	Florence Walnut	7993-38	2	Lowell Ash	7994-38	2	Port	D14-60	2
Anitique White	1572-60	2	Fonthill Pear	10745-60	2	Mangalore Mango	7984-38	2	Pressed Linen	4991-38	2
Anzio Marble	5037-38	2	Forged Steel	4995-60	2	Manitoba Maple	7911-60	2	Raw Cotton	4947-38	2
Atlantis	D25-60	2	Fossil Shale	D504-60	2	Midnight	D505-60	2	River Cherry	7937-38	2
Bannister Oak	7806-60	2	French Linen	5016-38	2	Mission Maple	7990-38	2	Rustic Slate	4888-38	2
Beige	1530-60	2	French Pear	8220-38	2	Misted Zephyr	4843-60	2	Sable Soapstone	4883-38	2
Beigewood	7850-60	2	Frosty White	1573-60	2	Monticello Maple	7925-38	2	Sap Walnut	8221-38	2
Boardwalk Oak	7983-38	2	Fusion Maple	7909-60	2	Morelia Maple	7985-38	2	Shadow Zephyr	4857-60	2
Brazilwood	7946-38	2	Graphite	10657-60	2	Morro Zephyr	4846-60	2	Sheer Mesh	4876-38	2
Brittany Blue	D321-60	2	Graphite Nebula	4623-60	2	Natural Almond	D30-60	2	Sierra Cascade	5005-38	2
Bronze Legacy	4656-60	2	Green Tigris	4667-60	2	Natural Cotton	4946-38	2	Silicon Ev	4811-60	2
Buka Bark	7982-38	2	Grey	1500-60	2	Natural Recon	7996-38	2	Solar Oak	7816-60	2
Burnished Chestnut	4796-60	2	Grey Glace	4142-60	2	Natural Rift	7954-38	2	Steel Mesh	4879-38	2
Candy Apple	13096-60	2	Grey Mesh	4877-38	2	Natural Tigris	4669-60	2	Sterling Ash	7995-38	2
Canyon Zephyr	4842-60	2	Grey Nebula	4622-60	2	Navy Legacy	4651-60	2	Sunny Side Up	13089-60	2
Carbon Ev	4820-60	2	Grey Pampas	4168-60	2	Neo Walnut	7991-38	2	Tailored Linen	4992-38	2
Carbon Mesh	4880-60	2	Gumball	13102-60	2	Neutral Glace	4143-60	2	Titanium EV	4810-60	2
Castle Oak	7928-38	2	Handspun Chestnut	5036-38	2	New Age Oak	7938-38	2	Tungsten EV	4814-60	2
Casual Linen	4944-38	2	Handspun Dove	5034-38	2	Nordic Linen	5015-38	2	Tuscan Walnut	7921-38	2
Catalina	13092-60	2	Handspun Pearl	5033-38	2	Nori	13091-60	2	Twilight Zephyr	4845-60	2
Cement	D503-60	2	Hanspun Slate	5035-38	2	North Sea	D90-60	2	Wallaby	D439-60	2
Centizo Cherry	8239-38	2	Harvest Maple	7953-38	2	Norwegian Ash	8241-38	2	Washi Crystal	5017-38	2
Classic Linen	4843-38	2	high Rise	4996-38	2	Oiled Soapstone	4882-38	2	Washi Pewter	5018-38	2
Cloud Nebula	4830-60	2	Hollyberry	D307-60	2	Orange Grove	D501-60	2	White	1570-60	2
Cloud Zephyr	4856-60	2	Huntington Mplae	7929-38	2	Organic Cotton	4945-38	2	White Carrara	4924-38	2
Coffee Bean	D495-60	2	Indigo	D379-60	2	Palisades Oak	7987-38	2	White Cascade	5003-38	2
Crisp Linen	4942-38	2	Invory Birch	8219-38	2	Pampas	4170-60	2	White Nebula	4621-60	2
Crystal	D388-60	2	Jubilee Oak	8242-38	2	Pasadena Oak	7966-38	2	White Sand	D403-60	2
Desert Zephyr	4841-60	2	Kensington Maple	10776-60	2	Pearl Soapstone	4886-38	2	White Tigris	4783-60	2
Dove Grey	D92-60	2	Khaki Brown	D50-60	2	Pepperdust	D327-60	2	Wild Cherry	7054-60	2
Dragon Fly	13088-60	2	Kingswood Walnut	8218-38	2	Pewter	D73-60	2	Windswept Pewter	4795-60	2
Ebony Recon	7997-38	2	Lapis Blue	D417-60	2	Pewter Brush	4779-60	2	Woolamai Brush	4746-60	2
Evening Tigris	4674-60	2	Limber Maple	10734-60	2	Pewter Mesh	4878-38	2			
Fashion Grey	D381-60	2	Linen	D427-60	2	Pinnacle Walnut	7992-38	2			
Flax Linen	4930-38	2	Loden Zephyr	4844-60	2	Platinum	D315-60	2			

PVC Edge Selection

Tier 2 Laminates require the additional specification of a PVC edge band. Choose from one of the following JSI standard options.

ALB	Alabaster	MES	Mesa
BEL	Belair	MIN	Mineral
BLK	Black	MCH	Mocha
BRK	Brickdust	OBK	Outback
BBL	Bridal Blanco	PIL	Pilsner
CSK	Cask	PIN	Pinnacle Walnut
CLY	Clay	SHD	Shadow
DWH	Designer White	SLG	Slate Grey
EGR	Egret	UMB	Umber
FAW	Fawn	VAL	Valley
FLN	Flint	WLH	Walnut Heights
FLO	Florence Walnut	WEA	Weathered Ash
LOF	Loft	ZEN	Zen Grey