

Moto Lounge Order Check List:



Specify:

- 1. Model Number
- 2. Fabric Selection
 - A. Chair - vendor, pattern and color
 - B. Seat Cushion - vendor, pattern and color
 - C. Privacy Screen - vendor, pattern and color
- 3. Optional Tablet Arm; specify material, finish and add \$726 list per arm
- 4. Optional Arm Cap; specify finish or 3D Black Laminate and add \$329 list per arm
- 5. Optional Casters; add \$117 list
- 6. Optional Wood Feet; specify finish; add \$75 list
- 7. Optional Power Center - Flush Mount (EC22) - Black (B) or White (W)
 - Side of Seating; add \$613 list each and specify right or left
 - Side of Privacy Surround; add \$613 list each and specify right or left
 - Back of Work Shelf; add \$732 list each
- 8. Work Shelf Wood Finish
- 9. Work Shelf Laminate Color Selection
- 10. Optional Work Shelf Acrylic Screen; add \$259 list

Example:

MTL301UAR | MOMENTUM | VOX | MYSTIC | CASTERS | TABLET ARM | MCH
 (model #) | (fabric vendor) | (pattern name) | (pattern color) | | | (tablet arm finish)

1. Model Number

2. Fabric Selection - Please supply the following:

- Fabric vendor
- Pattern name
- Pattern color

[For a complete list of JSI Graded-In Fabric click here](#)

When specifying contrasting upholstery, indicate clearly which upholstery is to be applied to the chair, seat and privacy screen. Use higher grade pricing.

- Indicate direction of fabric - Railroaded or Up the Roll
- Please provide illustration, if available

All COM orders must include the following:

- Vendor's name, pattern name and color
- Sample of the fabric attached to the order
- Model numbers of items for fabric application
- Special application instructions (e.g., all stripes will be applied front to back unless specified otherwise)
- Customer and purchase order number

Ship prepaid COM

material to:

JSI
 Attn: COM Dept
 201 East Martin Street
 Receiving B, Dock 71
 Orleans, IN 47452

Application of fabric:

Railroaded Up the Roll

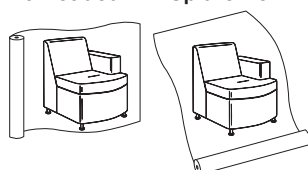

All COM orders will ship at standard lead time from receipt of COM except for orders requiring special custom matched finishes.

MT2 Moto

3. Tablet Arm -

- Rotating 10" x 14" oval surface or 10" x 16" rectangular surface
- 300 lb maximum static weight rating
- Available on Inline or Convex units with arm
- Available in veneer or laminate
- Exposed plywood edge on veneer tablet is finished with veneer color. Laminate tablet will have a clear finish on the exposed plywood edge.
- Add \$726 list per arm and specify shape, material and finish

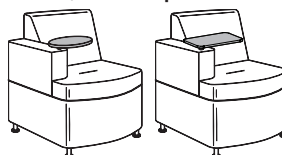

*finishes with coordinating laminate top option

Tablet Arm Wood Finish Selection:

ESS Essentials Veneer Collection

BRK	Brickdust*	MIN	Mineral*
CSK	Cask*	MCH	Mocha*
CLY	Clay*	OBK	Outback*
FAW	Fawn*	PIL	Pilsner*
FLX	Flax	SIE	Sienna
FLN	Flint*	TRF	Truffle
LOF	Loft*	UMB	Umber*
MES	Mesa*	VAL	Valley*

ART Artisan Veneer Collection

BAR	Barrel	RAV	Raven
BUF	Buff	RYE	Rye
CND	Cinder	SAB	Sable
EGR	Egret*	SAD	Saddle

3. Tablet Arm (continued)

Tablet Arm Laminate Selection:

Woodgrain Laminates

BEL Belair	MIN Mineral
BRK Brickdust	MCH Mocha
CSK Cask	OBK Outback
CLY Clay	PIL Pilsner
EGR Egret	PIN Pinnacle Walnut
FAW Fawn	UMB Umber
FLN Flint	VAL Valley
FLO Florence Walnut	WLH Walnut Heights
LOF Loft	WEA Weathered Ash
MES Mesa	

Solid Laminates

ALB Alabaster	SHD Shadow
BLK Black	SLG Slate Grey
BBL Bridal Blanco	ZEN Zen Grey
DWH Designer White	

4. Arm Cap -

Add \$329 list per arm and specify finish.

Arm cap can not be placed on same arm as Tablet Arm

WAC Wood Arm Cap

BAR Barrel	MCH Mocha
BRK Brickdust	OBK Outback
BUF Buff	PIL Pilsner
CSK Cask	PIN Pinnacle Walnut
CND Cinder	RAV Raven
CLY Clay	RYE Rye
EGR Egret	SAB Sable
FAW Fawn	SAD Saddle
FLX Flax	SIE Sienna
FLN Flint	TRF Truffle
FLO Florence Walnut	UMB Umber
LOF Loft	VAL Valley
MES Mesa	WLH Walnut Heights
MIN Mineral	

B3LAC Black 3D Laminate

5. Casters - Add \$117 list

6. Wood Feet - Solid maple wood feet with leveling glide.

Add \$75 list and specify finish.

BAR Barrel	MCH Mocha
BRK Brickdust	OBK Outback
BUF Buff	PIL Pilsner
CSK Cask	PIN Pinnacle Walnut
CND Cinder	RAV Raven
CLY Clay	RYE Rye
EGR Egret	SAB Sable
FAW Fawn	SAD Saddle
FLX Flax	SIE Sienna
FLN Flint	TRF Truffle
FLO Florence Walnut	UMB Umber
LOF Loft	VAL Valley
MES Mesa	WLH Walnut Heights
MIN Mineral	



7. Power Center - Flush Mount (EC22) - Specify Black (B) or White (W).

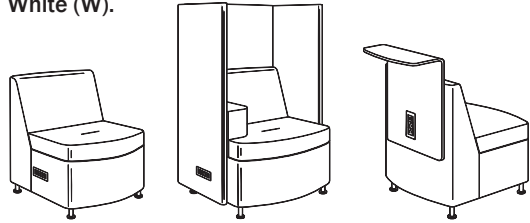

Power Center option can be specified on the sides of seating units and privacy surrounds, or in the back of work shelves. It features two waterproof 110 outlets and one dual USB port. Power is connected to the building supply with a 10' long standard three prong cord. A hook and loop chair bottom allows access to power cords in the base of the chair.

Power Center

- Side of Seating; add \$613 list each and specify right or left
- Side of Privacy Surround; add \$613 list each and specify right or left.
- Back of Work Shelf; add \$732 list each

8. Work Shelf Wood Finish Options:

ESS Essentials Veneer Collection

BRK Brickdust	OBK Outback
CSK Cask	PIL Pilsner
CLY Clay	SIE Sienna
FLX Flax	TRF Truffle
MES Mesa	UMB Umber
MCH Mocha	

9. Work Shelf Laminate Color Options:

DWH Designer White
SHD Shadow
SLG Slate Grey

10. Work Shelf Acrylic Screen

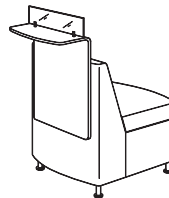

Units with a work shelf can be specified with an acrylic screen. The frosted screen is on brushed aluminum standoffs and is 4 3/8" tall. Add \$259 list.

Discrete Clean Out

Select units with the suffix of -CO offer a discrete clean out for ease in cleaning. Clean out is incorporated in such a way as to not be noticeable from the approach, as well as provide sufficient pass through to an opening in the bottom of the chair.



Moto Conical Tables Order Check List:



Specify:

- 1. Model Number
- 2. Top Material
- 3. Conical Base Color
- 4. Optional Power Unit
 - Moire - Black (B) or White (W); see page MT64

Example:

MTVP22ROUN | **DWH** | **BAR**
 (model #) | (top laminate) | (base finish)

1. Model Number

2. Top Material Selection:

ESS Essentials Veneer Collection

BRK	Brickdust	MIN	Mineral
CSK	Cask	MCH	Mocha
CLY	Clay	OBK	Outback
FAW	Fawn	PIL	Pilsner
FLX	Flax	SIE	Sienna
FLN	Flint	TRF	Truffle
LOF	Loft	UMB	Umber
MES	Mesa	VAL	Valley

ART Artisan Veneer Collection

BAR	Barrel	RAV	Raven
BUF	Buff	RYE	Rye
CND	Cinder	SAB	Sable
EGR	Egret	SAD	Saddle

Woodgrain HPL Laminates

BEL	Belair	MIN	Mineral
BRK	Brickdust	MCH	Mocha
CSK	Cask	OBK	Outback
CLY	Clay	PIL	Pilsner
EGR	Egret	PIN	Pinnacle Walnut
FAW	Fawn	UMB	Umber
FLN	Flint	VAL	Valley
FLO	Florence Walnut	WLH	Walnut Heights
LOF	Loft	WEA	Weathered Ash
MES	Mesa		

Solid HPL Laminates

ALB	Alabaster	SHD	Shadow
BLK	Black	SLG	Slate Grey
BBL	Bridal Blanco	ZEN	Zen Grey
DWH	Designer White		

3. Conical Base Color:

Finish on Polystyrene Base

BAR	Barrel	MCH	Mocha
BRK	Brickdust	OBK	Outback
BUF	Buff	PIL	Pilsner
CSK	Cask	PIN	Pinnacle Walnut
CND	Cinder	RAV	Raven
CLY	Clay	RYE	Rye
EGR	Egret	SAB	Sable
FAW	Fawn	SAD	Saddle
FLX	Flax	SIE	Sienna
FLN	Flint	TRF	Truffle
FLO	Florence Walnut	UMB	Umber
LOF	Loft	VAL	Valley
MES	Mesa	WLH	Walnut Heights
MIN	Mineral		

Laminate Matching Finishes

BRK	Brickdust	MIN	Mineral
CSK	Cask	MCH	Mocha
CLY	Clay	OBK	Outback
EGR	Egret	PIL	Pilsner
FAW	Fawn	PIN	Pinnacle Walnut
FLN	Flint	UMB	Umber
FLO	Florence Walnut	VAL	Valley
LOF	Loft	WLH	Walnut Heights
MES	Mesa		

Paint Color

BKD	Backdrop	NWH	Nonchalant White
BFX	Black Fox	SVP	Silverplate
BWH	Bright White	SKS	Skyline Steel
CHT	Chatroom	STM	Storm
GAL	Gale Force	TRC	Tricorn Black
GRV	Greek Villa	UKH	Universal Khaki

5. Conical Work Table - Moire - EC23

Three 110 outlets and a dual USB port with 72" power cord - Black (B) or White (W); see page MT64.



MOTO

Moto Casegoods Order Check List:



Specify:

- 1. Model Number
- 2. Wood Finish
- 3. Laminate Selection
- 4. Optional Wood Feet; specify finish; add \$75 list
- 5. Optional Power Unit
 - Linking Drum Table - Node - Black (B) or White (w); see page MT64
 - Media Table - Ellora; see page MT64
- 6. Optional Markerboard Back Panel; for 24" unit add \$271 list, for 48" unit add \$527 list
- 7. Deduct TV Bracket; subtract \$186 list
- 8. Optional Door Locks; add \$150 list

Examples:

MT4878-30MACW (model #)		MCH (wood finish)		
MTF54ROUN (model #)		STU (top laminate)		BWH (base finish) Moire - EC23 Power Unit

1. Model Number

2. Wood Finish Selection:

ESS Essentials Veneer Collection

BRK Brickdust*	MIN Mineral*
CSK Cask*	MCH Mocha*
CLY Clay*	OBK Outback*
FAW Fawn*	PIL Pilsner*
FLX Flax	SIE Sienna
FLN Flint*	TRF Truffle
LOF Loft*	UMB Umber*
MES Mesa*	VAL Valley*

ART Artisan Veneer Collection

BAR Barrel	RAV Raven
BUF Buff	RYE Rye
CND Cinder	SAB Sable
EGR Egret*	SAD Saddle

*finishes with coordinating laminate top option

3. Laminate Selection:

Woodgrain Laminates

BEL Belair	MIN Mineral
BRK Brickdust	MCH Mocha
CSK Cask	OBK Outback
CLY Clay	PIL Pilsner
EGR Egret	PIN Pinnacle Walnut
FAW Fawn	UMB Umber
FLN Flint	VAL Valley
FLO Florence Walnut	WLH Walnut Heights
LOF Loft	WEA Weathered Ash
MES Mesa	

Solid Laminates

ALB Alabaster	SHD Shadow
BLK Black	SLG Slate Grey
BBL Bridal Blanco	ZEN Zen Grey
DWH Designer White	

4. Wood Feet - Solid maple wood feet with leveling glide.

Add \$75 list and specify finish.

BAR	Barrel	MCH	Mocha
BRK	Brickdust	OBK	Outback
BUF	Buff	PIL	Pilsner
CSK	Cask	PIN	Pinnacle Walnut
CND	Cinder	RAV	Raven
CLY	Clay	RYE	Rye
EGR	Egret	SAB	Sable
FAW	Fawn	SAD	Saddle
FLX	Flax	SIE	Sienna
FLN	Flint	TRF	Truffle
FLO	Florence Walnut	UMB	Umber
LOF	Loft	VAL	Valley
MES	Mesa	WLH	Walnut Heights
MIN	Mineral		

5. Power Unit - Power Units can be specified in Linking Drum Tables, Conical Work Tables, Media Tables and Media Credenzas. Specify the table to be fitted for power and order the power unit separately.

Linking Drum Table - Node - EC24

One 110 outlet and a dual USB port with 72" power cord - Black (B) or White (W); see page MT64.



Conical Work Table - Moire - EC23

Three 110 outlets and a dual USB port with 72" power cord - Black (B) or White (W); see page MT64.



Media Table - Ellora - EC25

Two 110 power outlets, one 20-watt USB-C+A, and 1 opening for voice/data port with wire pass-through and 72" power cord anodized aluminum; see page MT64.

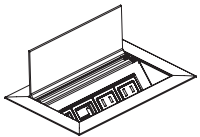

6. Markerboard Back Panel - Dry-Erase markerboard laminate can be specified on the back panels of Media Tables, Media Credenzas and Bookcase units. When specified, the inside back of the cabinet will also be markerboard; for 24" unit add \$271 list, for 48" unit add \$527 list.

7. Deduct TV Bracket; subtract \$186 list

8. Optional Door Locks; add \$150 list

Foot Options

Moto offers two foot styles or casters. The metal foot is standard on seating, casegoods and linking drum tables. An optional wood foot is available at an additional upcharge on lounge, linking drum tables and casegoods. Casters are available on seating with an additional upcharge. Casters are non-locking.

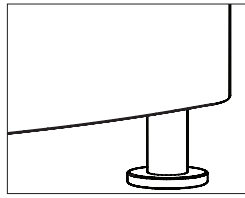

Metal Foot - Standard
 Fabricated Metal
 Arctic Silver Powder Coat
 Adjustable Glide

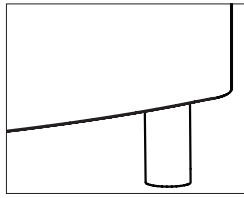

Wood Foot - Optional
 Natural Maple Solid
 Adjustable Glide

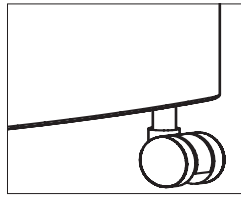

Casters - Optional
 Black Dual Wheel
 Four Caster Set
 Non-locking

Adjustable Foot - Leveling

The standard foot has integrated leveling, which is beneficial when connecting units together in long runs on uneven floors. As the glide is turned to adjust leveling an attached shroud drops to hide the threads of the bolt.

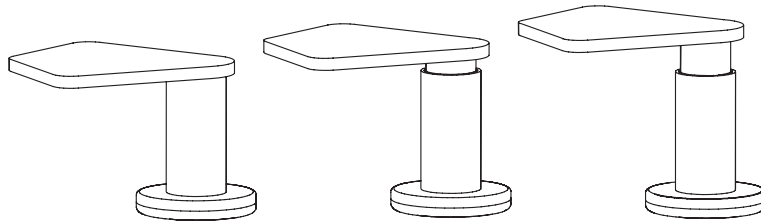

The maximum recommended adjustment is no more than 1 3/4".

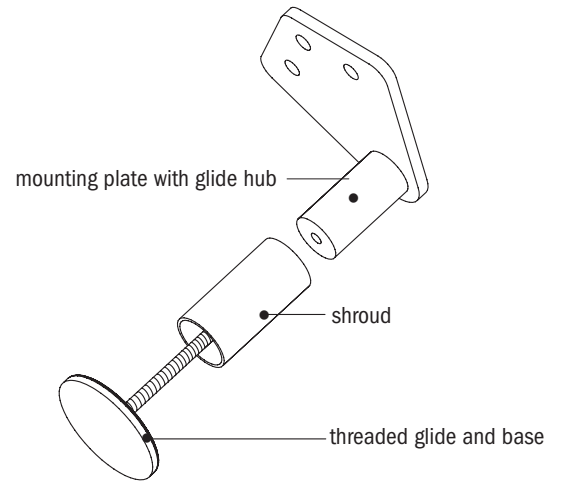

Upholstery Application

The fabric will be applied “up the roll” unless railroad is specified.

The Concave Corner unit will have a diagonal seam on all fabric applications. Shown below is an example of a directional textile on the Corner Club unit.

Additional seaming may be needed pending fabric width and fabric repeat match, contact Customer Service with questions. JSI will strive to match fabric patterns but cannot guarantee a match on repeats greater than 15” on the Moto product line.

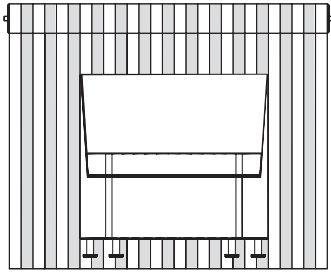

up the roll

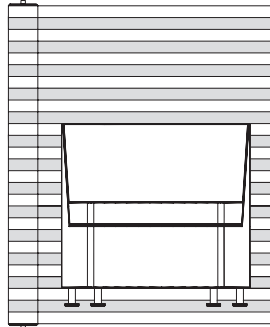

railroaded

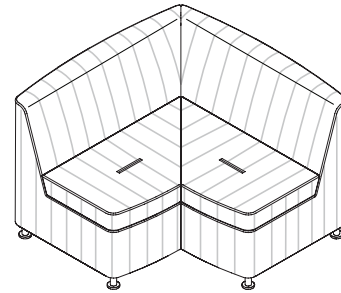

90° Concave Corner

Contrasting Upholstery Specification

This form should accompany orders when specifying contrasting or complementary upholstery.

examples

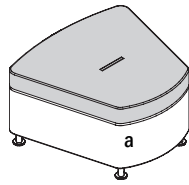

Benches - Inline - Concave- Convex

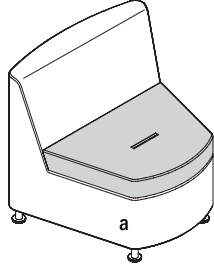

Club Chair - Inline - Concave - Convex

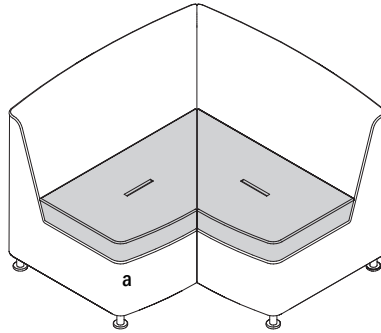

Corner - Concave - Convex

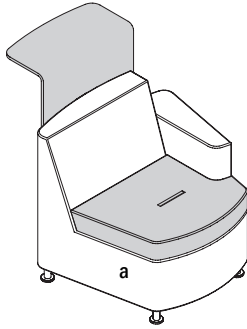

Club Chair with Shelf - Inline - Concave

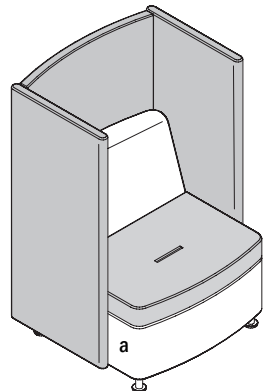

Club Chair with Privacy - Screen - Surround

fill out for each model ordered

Code Explanation

a = upholstered chassis, back and arm(s) - fabric choice required

b = seat cushion (light gray) - fabric choice required

c = work shelf either veneer or laminate

veneer - Essentials - finish choice required

laminate - Designer White, Shadow or Slate Grey

d= Privacy Screen/Surround - fabric choice required

Item 1

Model Number: _____

chassis, back and arms (a): _____

seat (b): _____

work shelf (c): _____

screen/surround (d): _____

Item 2

Model Number: _____

chassis, back and arms (a): _____

seat (b): _____

work shelf (c): _____

screen/surround (d): _____

Item 3

Model Number: _____

chassis, back and arms (a): _____

seat (b): _____

work shelf (c): _____

screen/surround (d): _____

Item 4

Model Number: _____

chassis, back and arms (a): _____

seat (b): _____

work shelf (c): _____

screen/surround (d): _____

Item 5

Model Number: _____

chassis, back and arms (a): _____

seat (b): _____

work shelf (c): _____

screen/surround (d): _____

photo copy or scan

Installation of Privacy Screen and Work Shelf

Simple field installation is required on club chairs when ordering units with privacy screens and work shelves. Instructions are included. Access to the back of the chair is through the chair bottom. Attaching knobs are included, no tools are required.

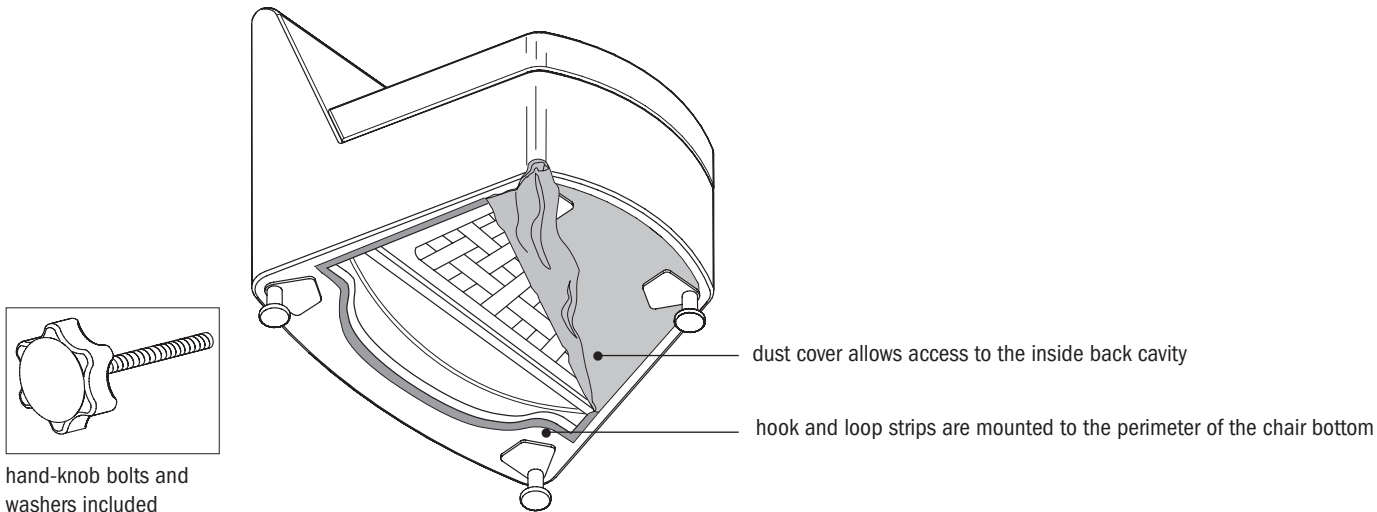

Moto Options for Lounge Seating

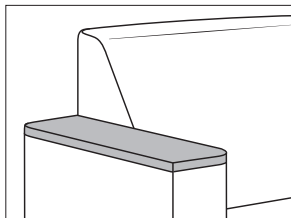

Arm Cap
solid maple
or
Black 3D Laminate (B3LAC)
add \$329 list per arm

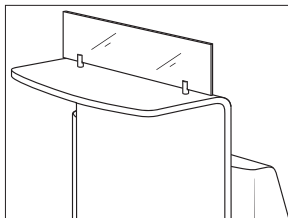

Work Shelf Acrylic Screen
frosted acrylic screens
4 3/8" tall - from work shelf surface
brushed aluminum standoffs
add \$259 list.

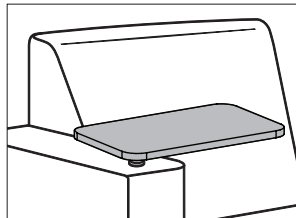

Tablet Arm
rotating 10" x 16" rectangular surface or
10" x 14" oval surface
300 lb max. static weight rating
for inline or convex units with arms
specify surface finish
vener
Essentials
Artisan
(stained plywood edge)
laminat
(clear coat plywood edge)
add \$726 list per arm

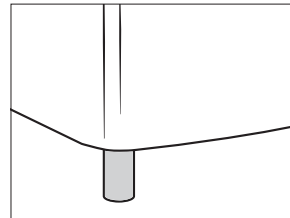

Wood Foot
solid maple
adjustable glide - up to 3/4"
add \$75 list per chair

MOTO

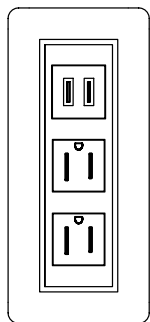

EC22 (3 installed locations)
Flush Mount Power Center
two 110 devices and
one USB 2-Port Simplex for charging

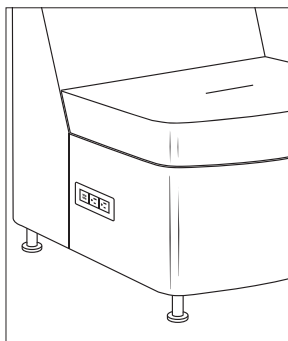

side of seating
specify right or left
add \$613 list for each EC22

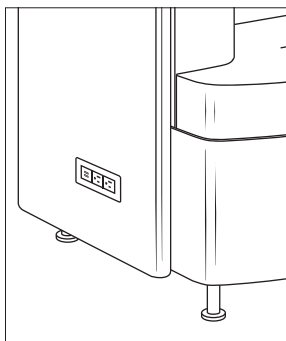

side of privacy surround
specify right or left
add \$613 list for each EC22

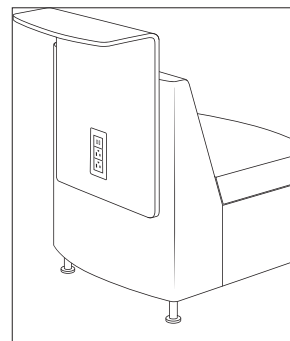

back of work shelf
add \$732 list

Additional Product Information

Half Round Dimensions

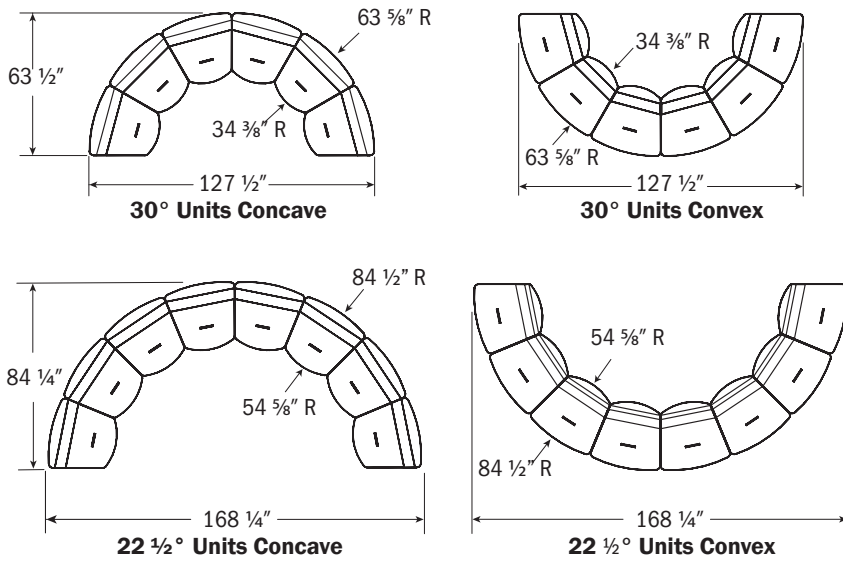

Modular Lounge and Linking Drum Tables

An Alligator Clip assembly is installed to connect lounge and linking drum tables. The clip is installed on the left bottom side rail and the hook is installed on the right bottom side rail. The bottom chair rails are bored to accept either the clip or hook for field re-configurations.

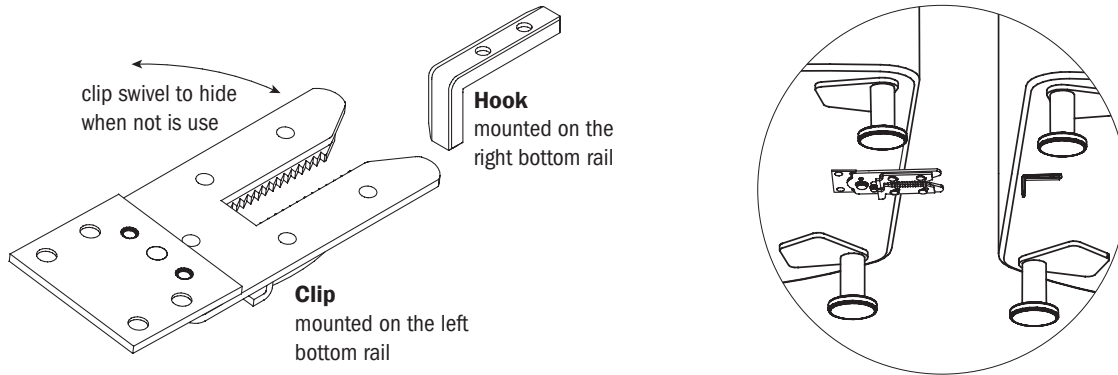

Note: Linking Table Tops are permanent bolt thru attachment and do not use the above clip.

Lounge Seating - Seam Detail

Seats have a seam detail in the center of the seat. This seam detail is standard and will help keep the tailored look of Moto. Please note that fabrics and leathers are all different (fiber content, yarn elasticity and yarn weight) which can affect the tailoring of the Moto Lounge. The aesthetic seam helps with variations in the upholstery cover. Contact Customer Service with fabric and leather information if a concern exists with a certain upholstery cover.

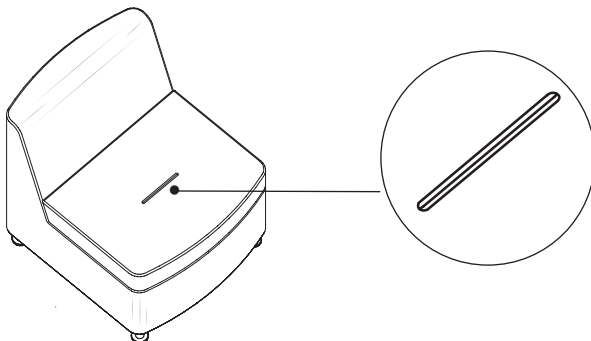

Casegood & Table Edge Details

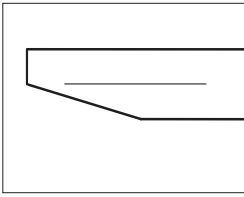

Bevel Edge

used on pull-up tables

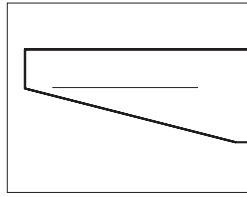

Bevel Edge

used on work tables

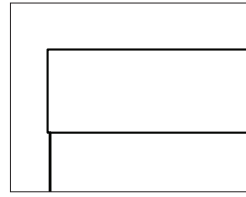

Straight Edge

used on linking tables

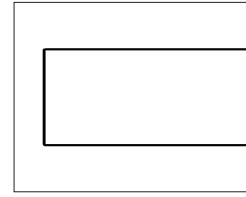

Straight Edge

used on media table surfaces



3/4" thick top
essentials veneer
artisan veneer
laminated - HPL
(bevel underside MDF)

polystyrene base
finishes see page [MT4](#)



1 3/16" thick top
essentials veneer
artisan veneer
laminated - HPL
(bevel underside MDF)

polystyrene base
finishes see page [MT4](#)

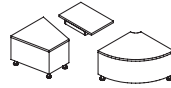

1" thick
available in
essentials veneer
artisan veneer

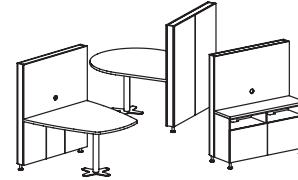

1 3/16" thick
available in
essentials veneer
artisan veneer
laminated - HPL
(bevel underside MDF)

Linking Tables - Grain Direction

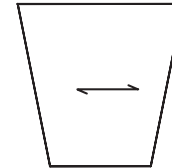
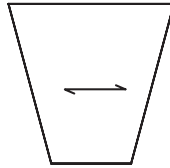
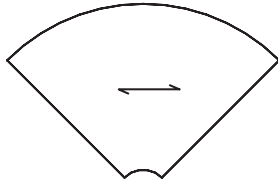
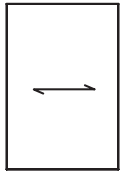

Linking Drum Tables - Power Location

The EC24 or EC23 are available on linking drum tables. Wire management moves through the bottom cavity. The location shown below is for all table shapes.

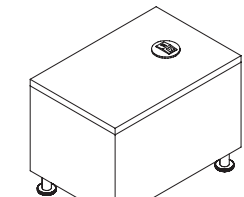

EC24

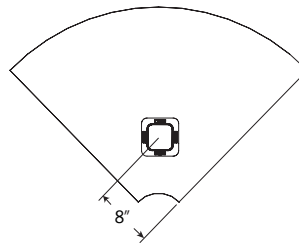
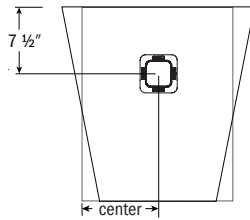

Work Tables - Power and Wire Management

The optional EC23 or EC24 is recommended for the work tables. When electrical units are used on the work tables with a conical base, the base allows wires to run through to a floor outlet. The unrestricted opening at the bottom of the base allows the base to be placed over the floor electrical monument.

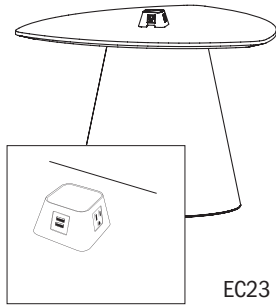

EC23

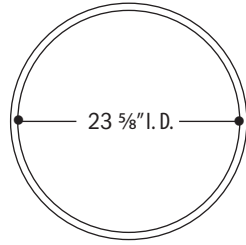

Both the EC23 and EC24 are centered on the top over the base.

Conical Table Base - Material and Grain Direction

The conical base on the pull-up and work tables is polystyrene material with a wood grain texture. This base is available in wood finishes, paint colors and laminate matching finishes. Adjustable leveling glides are included.

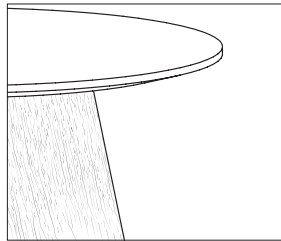

Media Tables and Media Credenzas - Wire Management and Power/Data

Easy access to wiring is provided in the Moto Media products. Well placed grommets, doors, and allowance inside the cabinets makes it easy to outfit these units quickly. The recommended EC25 brings power and data access to the top.

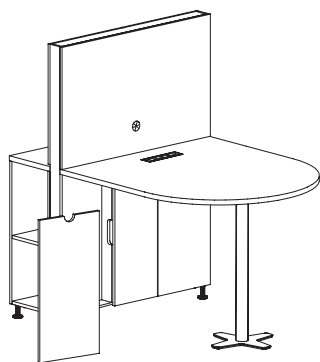
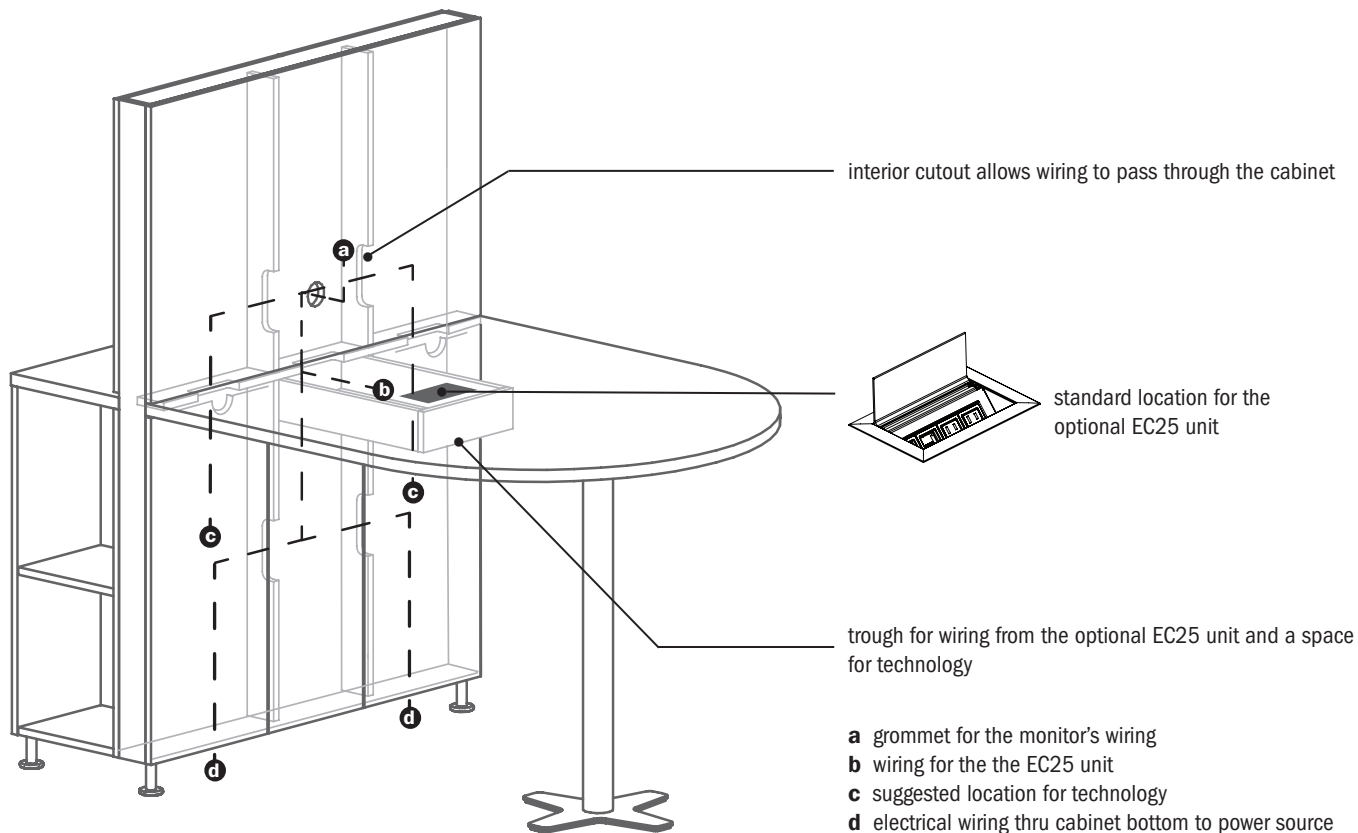

removable panels

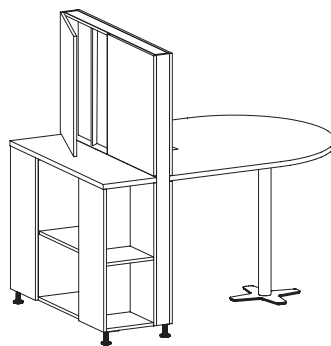

hinged doors

Media Tables - Power Location

The EC25 is available on media tables. The location shown below is for all table wedge shape tops, location for EC25 on bullet shapes are similar.

EC25 Power Unit Location Examples

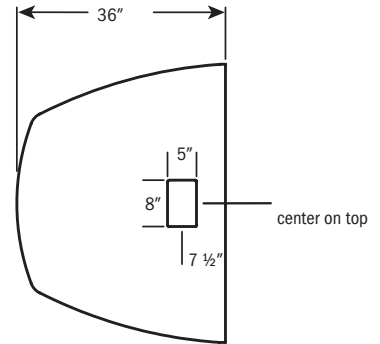
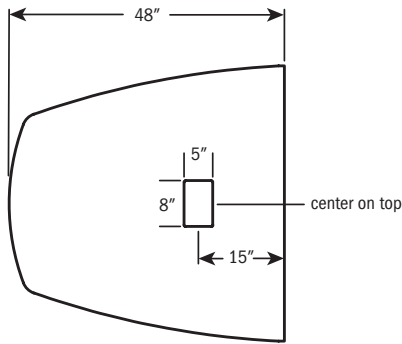
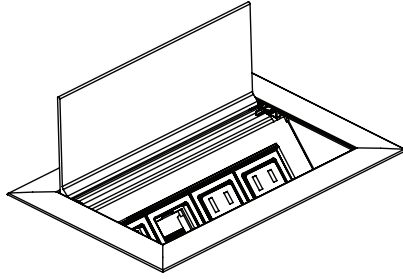

Media Tables - Leveling the Post Column

Leveling is made easy by turning the column.

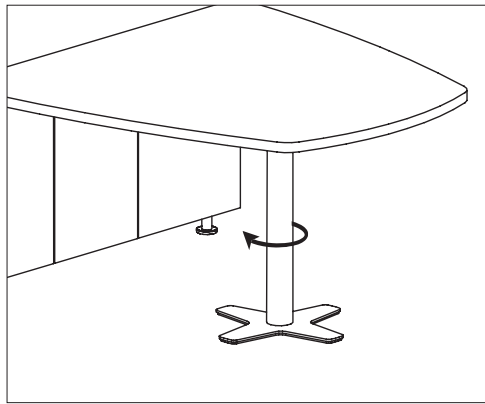

Markerboard Back Panel Options

Markerboard back panels can be specified for the back panels on Media Tables, Media Credenzas and Bookcases.

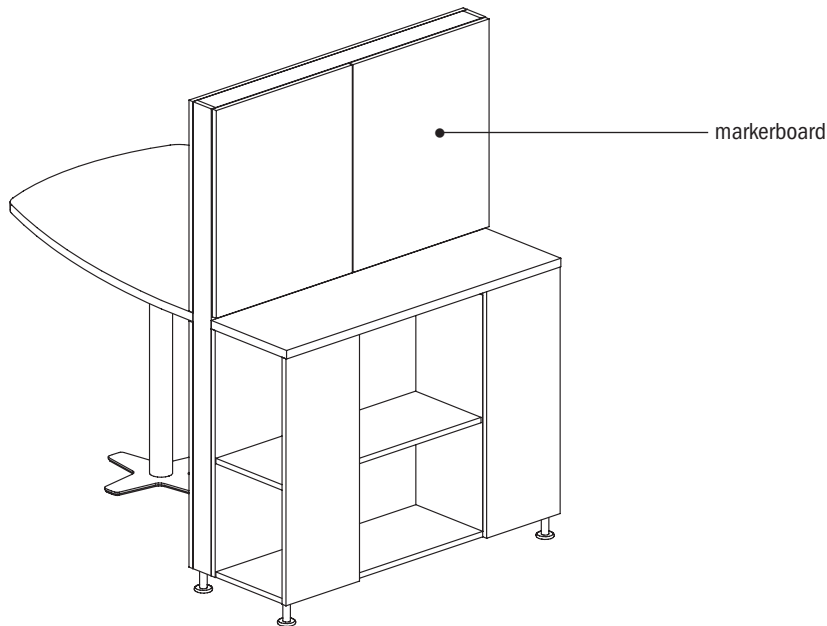

MOTO

Description	Model	Specifications			List Price Per Grade	
Narrow Inline Bench 	MTL260	Dimensions			COM \$1,515	
		Overall	D 30	W 26	H 17 ¾	A \$1,534
		Seat	30	26	17 ¾	B \$1,571
		Upholstery		Shipping		COL/C \$1,635
		COM Ydg	2 ¼	Ctn Wt	43	D \$1,717
		COL Sq Ft	45	Cu Ft	11	E \$1,787
				Chair Wt	38	F \$1,910
						G \$2,041
						H \$2,153
						I \$2,354
				J \$2,592		
				L1 \$2,137		
				L2 \$2,312		

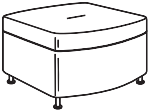
Description	Model	Specifications			List Price Per Grade	
Inline Bench 	MTL300	Dimensions			COM \$1,536	
		Overall	D 30	W 30	H 17 ¾	A \$1,555
		Seat	30	30	17 ¾	B \$1,592
		Upholstery		Shipping		COL/C \$1,656
		COM Ydg	2 ¼	Ctn Wt	46	D \$1,738
		COL Sq Ft	45	Cu Ft	12	E \$1,808
				Chair Wt	40	F \$1,931
						G \$2,062
						H \$2,174
						I \$2,375
				J \$2,613		
				L1 \$2,158		
				L2 \$2,333		

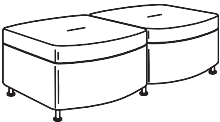
Description	Model	Specifications			List Price Per Grade	
Two Seat Bench 	MTL600 · casters not available	Dimensions			COM \$2,719	
		Overall	D 30	W 60	H 17 ¾	A \$2,756
		Seat	30	60	17 ¾	B \$2,830
		Upholstery		Shipping		COL/C \$2,958
		COM Ydg	4 ½	Ctn Wt	90	D \$3,122
		COL Sq Ft	90	Cu Ft	23	E \$3,262
				Chair Wt	80	F \$3,508
						G \$3,770
						H \$3,995
						I \$4,397
				J \$4,873		
				L1 \$3,963		
				L2 \$4,313		

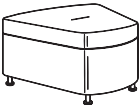
Description	Model	Specifications			List Price Per Grade	
30° Concave Bench 	MTI300	Dimensions			COM \$1,550	
		Overall	D 30	W 32	H 17 ¾	A \$1,569
		Seat	30		17 ¾	B \$1,606
		Upholstery		Shipping		COL/C \$1,670
		COM Ydg	2 ¼	Ctn Wt	42	D \$1,752
		COL Sq Ft	45	Cu Ft	13	E \$1,822
				Chair Wt	37	F \$1,945
						G \$2,076
						H \$2,188
						I \$2,389
				J \$2,627		
				L1 \$2,172		
				L2 \$2,347		

MOTO

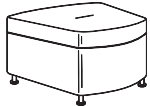
Description	① Model	Specifications			List Price Per Grade		
22 ½° Concave Bench 	MTI220	Dimensions	D	W	H	COM	\$1,552
		Overall	30	32	17 ¾	A	\$1,571
		Seat	30		17 ¾	B	\$1,608
		Upholstery	Shipping		COL/C	\$1,672	
		COM Ydg	2 ¼	Ctn Wt	43	D	\$1,754
		COL Sq Ft	45	Cu Ft	13	E	\$1,824
				Chair Wt	38	F	\$1,947
						G	\$2,078
						H	\$2,190
						I	\$2,391
				J	\$2,629		
				L1	\$2,174		
				L2	\$2,349		

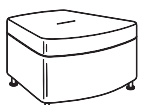
Description	① Model	Specifications			List Price Per Grade		
30° Convex Bench 	MTO300	Dimensions	D	W	H	COM	\$1,550
		Overall	30	32	17 ¾	A	\$1,569
		Seat	30		17 ¾	B	\$1,606
		Upholstery	Shipping		COL/C	\$1,670	
		COM Ydg	2 ¼	Ctn Wt	42	D	\$1,752
		COL Sq Ft	45	Cu Ft	13	E	\$1,822
				Chair Wt	37	F	\$1,945
						G	\$2,076
						H	\$2,188
						I	\$2,389
				J	\$2,627		
				L1	\$2,172		
				L2	\$2,347		

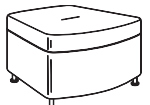
Description	① Model	Specifications			List Price Per Grade		
22 ½° Convex Bench 	MTO220	Dimensions	D	W	H	COM	\$1,552
		Overall	30	32	17 ¾	A	\$1,571
		Seat	30		17 ¾	B	\$1,608
		Upholstery	Shipping		COL/C	\$1,672	
		COM Ydg	2 ¼	Ctn Wt	43	D	\$1,754
		COL Sq Ft	45	Cu Ft	13	E	\$1,824
				Chair Wt	38	F	\$1,947
						G	\$2,078
						H	\$2,190
						I	\$2,391
				J	\$2,629		
				L1	\$2,174		
				L2	\$2,349		

To Order, Specify:

- ① Model Number
- ② Fabric Selection - vendor, pattern and color
 - A. Chair
 - B. Seat Cushion
 Visit www.jsifurniture.com/finishes-and-materials/textiles for our textiles program. See selection of standard and graded in manufacturers and patterns.
- ③ Optional Casters; add \$117 list
- ④ Optional Wood Feet; add \$75 list [See Wood Feet Finish Options](#)
- ⑤ Optional Power Center - Flush Mount (EC22) - Black (B) or White (W); add \$613 list each and specify left or right

Specifications

- Metal leg standard with 2 ¾" diameter leveling disc.
- Frame is puzzle jointed plywood construction.
- Seat has synthetic sheet webbing with cross strap reinforcement and 3 ¼" multi-density high resilience polyurethane foam.
- Linking bracket included.

Description	Model	Specifications				List Price Per Grade
Narrow Inline Club Chair 	MTL261	Dimensions	D	W	H	COM \$1,867
		Overall	30	26	31 ½	A \$1,892
		Seat	20 ½	26	17 ¾	B \$1,941
		Upholstery	Shipping			COL/C \$2,026
		COM Ydg	3	Ctn Wt	55	D \$2,136
		COL Sq Ft	60	Cu Ft	18	E \$2,229
				Chair Wt	48	F \$2,393
						G \$2,568
						H \$2,718
						I \$2,986
				J \$3,303		
				L1 \$2,696		
				L2 \$2,930		



Description	Model	Specifications				List Price Per Grade
Narrow Inline Club Chair with Clean Out 	MTL261-CO · discrete clean out	Dimensions	D	W	H	COM \$1,974
		Overall	30	26	31 ½	A \$2,001
		Seat	20 ½	26	17 ¾	B \$2,054
		Upholstery	Shipping			COL/C \$2,146
		COM Ydg	3 ¼	Ctn Wt	55	D \$2,265
		COL Sq Ft	65	Cu Ft	18	E \$2,367
				Chair Wt	48	F \$2,544
						G \$2,733
						H \$2,896
						I \$3,186
				J \$3,530		
				L1 \$2,872		
				L2 \$3,125		

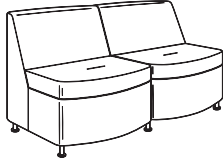

Description	Model	Specifications				List Price Per Grade
Inline Club Chair 	MTL301	Dimensions	D	W	H	COM \$1,886
		Overall	30	30	31 ½	A \$1,911
		Seat	20 ½	30	17 ¾	B \$1,960
		Upholstery	Shipping			COL/C \$2,045
		COM Ydg	3	Ctn Wt	60	D \$2,155
		COL Sq Ft	60	Cu Ft	20	E \$2,248
				Chair Wt	52	F \$2,412
						G \$2,587
						H \$2,737
						I \$3,005
				J \$3,322		
				L1 \$2,715		
				L2 \$2,949		

Description	Model	Specifications				List Price Per Grade
Inline Club Chair with Clean Out 	MTL301-CO · discrete clean out	Dimensions	D	W	H	COM \$2,004
		Overall	30	30	31 ½	A \$2,031
		Seat	20 ½	30	17 ¾	B \$2,084
		Upholstery	Shipping			COL/C \$2,176
		COM Ydg	3 ¼	Ctn Wt	60	D \$2,295
		COL Sq Ft	65	Cu Ft	20	E \$2,397
				Chair Wt	52	F \$2,574
						G \$2,763
						H \$2,926
						I \$3,216
				J \$3,560		
				L1 \$2,902		
				L2 \$3,155		

MOTO

Description	Model	Specifications			List Price Per Grade	
Two Seat Club Chair 	MTL601 • casters not available	Dimensions	D	W	H	COM \$3,612
		Overall	30	60	31 ½	A \$3,664
		Seat	20 ½	60	17 ¾	B \$3,765
		Upholstery	Shipping			COL/C \$3,943
		COM Ydg	6	Ctn Wt	118	D \$4,172
		COL Sq Ft	120	Cu Ft	39	E \$4,367
				Chair Wt	104	F \$4,707
						G \$5,072
						H \$5,384
						I \$5,942
						J \$6,603
						L1 \$5,261
						L2 \$5,728

Description	Model	Specifications			List Price Per Grade	
Narrow Inline Club Chair with Arm   right left	MTL261UAR MTL261UAL	Dimensions	D	W	H	COM \$2,043
		Overall	30	26	31 ½	A \$2,070
		Seat	20 ½	20	17 ¾	B \$2,123
		Upholstery	Shipping			COL/C \$2,215
		COM Ydg	3 ¼	Ctn Wt	67	D \$2,334
		COL Sq Ft	65	Cu Ft	18	E \$2,436
				Chair Wt	60	F \$2,613
						G \$2,802
						H \$2,965
						I \$3,255
						J \$3,599
						L1 \$2,941
						L2 \$3,194



Description	Model	Specifications			List Price Per Grade	
Narrow Inline Club Chair with Arm and Clean Out   right left	MTL261UAR-CO MTL261UAL-CO • discrete clean out	Dimensions	D	W	H	COM \$2,151
		Overall	30	26	31 ½	A \$2,180
		Seat	20 ½	20	17 ¾	B \$2,237
		Upholstery	Shipping			COL/C \$2,337
		COM Ydg	3 ½	Ctn Wt	67	D \$2,465
		COL Sq Ft	70	Cu Ft	18	E \$2,574
				Chair Wt	60	F \$2,764
						G \$2,969
						H \$3,143
						I \$3,456
						J \$3,826
						L1 \$3,118
						L2 \$3,391



To Order, Specify:

- 1 Model Number
- 2 Fabric Selection - vendor, pattern and color
 - A. Chair
 - B. Seat Cushion
 Visit www.jsifurniture.com/finishes-and-materials/textiles for our textiles program. See selection of standard and graded in manufacturers and patterns.
- 3 Optional Casters; add \$117 list
- 4 Optional Wood Feet; add \$75 list [See Wood Feet Finish Options](#)
- 5 Optional Tablet Arm, Oval or Rectangular; specify shape, material, finish and add \$726 list
- 6 Optional Arm Cap; specify finish or 3D Laminate and add \$329 list per arm
- 7 Optional Power Center - Flush Mount (EC22) - Black (B) or White (W); add \$613 list each and specify left or right

Specifications

- Metal leg standard with 2 ¾" diameter leveling disc.
- Frame is puzzle jointed plywood construction.
- Seat has synthetic sheet webbing with cross strap reinforcement and 3 ¼" multi-density high resilience polyurethane foam.
- Back has 1 ¾" multi-density high resilience polyurethane foam.
- Upholstered arms are standard.
- Arm tops have 1" high resilience polyurethane foam.
- Optional arm cap is available in Essentials Veneer or Solid Laminates.
- Optional tablet arm is available in Essentials, Artisan veneer, or HPL with exposed plywood edges.
- Linking bracket included.

Description	Model	Specifications				List Price Per Grade
Inline Club Chair with Arm  right  left	MTL301UAR MTL301UAL	Dimensions	D	W	H	COM \$2,105
		Overall	30	30	31 ½	A \$2,136
		Seat	20 ½	23	17 ¾	B \$2,197
		Upholstery	Shipping		COL/C \$2,304	
		COM Ydg	3 ¾	Ctn Wt	75	D \$2,441
		COL Sq Ft	75	Cu Ft	20	E \$2,558
				Chair Wt	67	F \$2,762
						G \$2,981
						H \$3,168
						I \$3,503
						J \$3,900
						L1 \$3,142
						L2 \$3,433

Description	Model	Specifications				List Price Per Grade
Inline Club Chair with Arm with Clean Out  right  left	MTL301UAR-CO MTL301UAL-CO · discrete clean out	Dimensions	D	W	H	COM \$2,222
		Overall	30	30	31 ½	A \$2,255
		Seat	20 ½	23	17 ¾	B \$2,320
		Upholstery	Shipping		COL/C \$2,434	
		COM Ydg	4	Ctn Wt	75	D \$2,581
		COL Sq Ft	80	Cu Ft	20	E \$2,705
				Chair Wt	67	F \$2,923
						G \$3,156
						H \$3,356
						I \$3,713
						J \$4,137
						L1 \$3,328
						L2 \$3,639

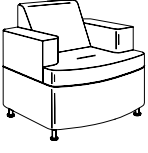
Description	Model	Specifications				List Price Per Grade
Inline Club Chair with Both Arm 	MTL301UA2	Dimensions	D	W	H	COM \$2,446
		Overall	30	32	31 ½	A \$2,485
		Seat	20 ½	21	17 ¾	B \$2,563
		Upholstery	Shipping		COL/C \$2,698	
		COM Ydg	4 ½	Ctn Wt	87	D \$2,872
		COL Sq Ft	90	Cu Ft	21	E \$3,020
				Chair Wt	79	F \$3,278
						G \$3,556
						H \$3,793
						I \$4,217
						J \$4,719
						L1 \$3,759
						L2 \$4,128

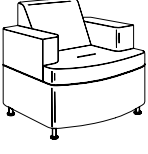
Description	Model	Specifications				List Price Per Grade
Inline Club Chair with Both Arm and Clean Out 	MTL301UA2-CO · discrete clean out	Dimensions	D	W	H	COM \$2,562
		Overall	30	32	31 ½	A \$2,603
		Seat	20 ½	21	17 ¾	B \$2,685
		Upholstery	Shipping		COL/C \$2,827	
		COM Ydg	4 ¾	Ctn Wt	87	D \$3,010
		COL Sq Ft	95	Cu Ft	21	E \$3,166
				Chair Wt	79	F \$3,438
						G \$3,730
						H \$3,980
						I \$4,426
						J \$4,955
						L1 \$3,944
						L2 \$4,333

MOTO

Description

Model

Specifications

List Price Per Grade

Two Seat Club Chair with Arms

MTL601UA

· casters not available

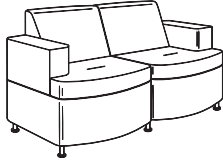

Dimensions	D	W	H
Overall	30	60	31 ½
Seat	20 ½	46	17 ¾
Upholstery		Shipping	
COM Ydg	6 ½	Ctn Wt	148
COL Sq Ft	130	Cu Ft	39
		Chair Wt	134

COM	\$3,890
A	\$3,952
B	\$4,074
COL/C	\$4,287
D	\$4,562
E	\$4,795
F	\$5,204
G	\$5,642
H	\$6,016
I	\$6,686
J	\$7,479
L1	\$5,651
L2	\$6,157

To Order, Specify:

- 1 Model Number
- 2 Fabric Selection - vendor, pattern and color
 - A. Chair
 - B. Seat Cushion
 Visit www.jsifurniture.com/finishes-and-materials/textiles for our textiles program. See selection of standard and graded in manufacturers and patterns.
- 3 Optional Casters; add \$117 list
- 4 Optional Wood Feet; add \$75 list [See Wood Feet Finish Options](#)
- 5 Optional Tablet Arm, Oval or Rectangular; specify shape, material, finish and add \$726 list
- 6 Optional Arm Cap; specify finish or 3D Laminate and add \$329 list per arm
- 7 Optional Power Center - Flush Mount (EC22) - Black (B) or White (W); add \$613 list each and specify left or right

Specifications

- Metal leg standard with 2 ¾" diameter leveling disc.
- Frame is puzzle jointed plywood construction.
- Seat has synthetic sheet webbing with cross strap reinforcement and 3 ¼" multi-density high resilience polyurethane foam.
- Back has 1 ¾" multi-density high resilience polyurethane foam.
- Upholstered arms are standard.
- Arm tops have 1" high resilience polyurethane foam.
- Optional arm cap is available in Essentials Veneer or Solid Laminates.
- Optional tablet arm is available in Essentials, Artisan veneer, or HPL with exposed plywood edges.
- Linking bracket included.

Description	Model	Specifications				List Price Per Grade	
30° Concave Club Chair 	MTI301	Dimensions		D	W	H	COM \$1,897
		Overall	30	32	31 ½		A \$1,922
		Seat	20 ½		17 ¾		B \$1,971
		Upholstery		Shipping			COL/C \$2,056
		COM Ydg	3	Ctn Wt	57		D \$2,166
		COL Sq Ft	60	Cu Ft	22		E \$2,259
				Chair Wt	48		F \$2,423
							G \$2,598
							H \$2,748
							I \$3,016
					J \$3,333		
					L1 \$2,726		
					L2 \$2,960		

22 ½° Concave Club Chair 	MTI221	Dimensions		D	W	H	COM \$1,900
		Overall	30	32	31 ½		A \$1,925
		Seat	20 ½		17 ¾		B \$1,974
		Upholstery		Shipping			COL/C \$2,059
		COM Ydg	3	Ctn Wt	59		D \$2,169
		COL Sq Ft	60	Cu Ft	22		E \$2,262
				Chair Wt	50		F \$2,426
							G \$2,601
							H \$2,751
							I \$3,019
					J \$3,336		
					L1 \$2,729		
					L2 \$2,963		

Description	Model	Specifications			List Price Per Grade		
		Dimensions	D	W	H	COM	
30° Concave Club Chair with Arm	MTI301UAR					\$2,091	
	MTI301UAL						
	· tablet arm not available	Overall	30	32	31 1/2	A	\$2,122
		Seat	20 1/2		17 3/4	B	\$2,183
		Upholstery		Shipping		COL/C	\$2,290
		COM Ydg	3 3/4	Ctn Wt	72	D	\$2,427
		COL Sq Ft	75	Cu Ft	22	E	\$2,544
				Chair Wt	63	F	\$2,748
						G	\$2,967
						H	\$3,154
						I	\$3,489
						J	\$3,886
						L1	\$3,128
						L2	\$3,419

Description	Model	Specifications			List Price Per Grade		
		Dimensions	D	W	H	COM	
22 1/2° Concave Club Chair with Arm	MTI221UAR					\$2,098	
	MTI221UAL						
	· tablet arm not available	Overall	30	32	31 1/2	A	\$2,129
		Seat	20 1/2		17 3/4	B	\$2,190
		Upholstery		Shipping		COL/C	\$2,297
		COM Ydg	3 3/4	Ctn Wt	74	D	\$2,434
		COL Sq Ft	75	Cu Ft	22	E	\$2,551
				Chair Wt	65	F	\$2,755
						G	\$2,974
						H	\$3,161
						I	\$3,496
						J	\$3,893
						L1	\$3,135
						L2	\$3,426

To Order, Specify:



- 1 Model Number
- 2 Fabric Selection - vendor, pattern and color
 - A. Chair
 - B. Seat Cushion
 Visit www.jsifurniture.com/finishes-and-materials/textiles for our textiles program. See selection of standard and graded in manufacturers and patterns.
- 3 Optional Casters; add \$117 list
- 4 Optional Wood Feet; add \$75 list [See Wood Feet Finish Options](#)
- 5 Optional Arm Cap; specify finish or 3D Laminate and add \$329 list per arm [See Arm Cap Finish Options](#)
- 6 Optional Power Center - Flush Mount (EC22) - Black (B) or White (W); add \$613 list each and specify left or right



Specifications

- Metal leg standard with 2 3/8" diameter leveling disc.
- Frame is puzzle jointed plywood construction.
- Seat has synthetic sheet webbing with cross strap reinforcement and 3 1/4" multi-density high resilience polyurethane foam.
- Back has 1 3/4" multi-density high resilience polyurethane foam.
- Upholstered arms are standard.
- Arm tops have 1" high resilience polyurethane foam.
- Optional arm cap is available in Essentials Veneer or Solid Laminate
- Optional tablet arm is available in Essentials, Artisan veneer, or HPL with exposed plywood edges.
- Linking bracket included.

Description	Model	Specifications				List Price Per Grade
30° Convex Club Chair 	MT0301	Dimensions	D	W	H	COM \$1,880
		Overall	30	32	31 ½	A \$1,905
		Seat	20 ½		17 ¾	B \$1,954
		Upholstery	Shipping			COL/C \$2,039
		COM Ydg	3	Ctn Wt	56	D \$2,149
		COL Sq Ft	60	Cu Ft	22	E \$2,242
				Chair Wt	47	F \$2,406
						G \$2,581
						H \$2,731
						I \$2,999
				J \$3,316		
				L1 \$2,709		
				L2 \$2,943		

22 ½° Convex Club Chair 	MT0221	Dimensions	D	W	H	COM \$1,887
		Overall	30	32	31 ½	A \$1,912
		Seat	20 ½		17 ¾	B \$1,961
		Upholstery	Shipping			COL/C \$2,046
		COM Ydg	3	Ctn Wt	57	D \$2,156
		COL Sq Ft	60	Cu Ft	22	E \$2,249
				Chair Wt	48	F \$2,413
						G \$2,588
						H \$2,738
						I \$3,006
				J \$3,323		
				L1 \$2,716		
				L2 \$2,950		

30° Convex Club Chair with Arm   right left	MT0301UAR MT0301UAL	Dimensions	D	W	H	COM \$2,065
		Overall	30	32	31 ½	A \$2,092
		Seat	20 ½		17 ¾	B \$2,145
		Upholstery	Shipping			COL/C \$2,237
		COM Ydg	3 ¼	Ctn Wt	71	D \$2,356
		COL Sq Ft	65	Cu Ft	22	E \$2,458
				Chair Wt	62	F \$2,635
						G \$2,824
						H \$2,987
						I \$3,277
				J \$3,621		
				L1 \$2,963		
				L2 \$3,216		

22 ½° Convex Club Chair with Arm   right left	MT0221UAR MT0221UAL	Dimensions	D	W	H	COM \$2,075
		Overall	30	32	31 ½	A \$2,102
		Seat	20 ½		17 ¾	B \$2,155
		Upholstery	Shipping			COL/C \$2,247
		COM Ydg	3 ¼	Ctn Wt	71	D \$2,366
		COL Sq Ft	65	Cu Ft	22	E \$2,468
				Chair Wt	62	F \$2,645
						G \$2,834
						H \$2,997
						I \$3,287
				J \$3,631		
				L1 \$2,973		
				L2 \$3,226		

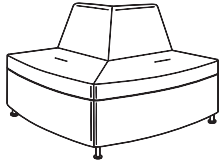
Description	Model	Specifications			List Price Per Grade	
90° Convex Corner 	MT0901 · casters not available	Dimensions	D	W	H	COM \$3,388
		Overall	46	46	31 ½	A \$3,429
		Seat	20 ½		17 ¾	B \$3,511
		Upholstery	Shipping			COL/C \$3,653
		COM Ydg	5	Ctn Wt	122	D \$3,836
		COL Sq Ft	100	Cu Ft	45	E \$3,992
				Chair Wt	107	F \$4,264
						G \$4,556
						H \$4,806
						I \$5,252
						J \$5,781
						L1 \$4,770
						L2 \$5,159

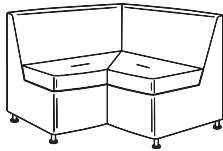
Description	Model	Specifications			List Price Per Grade	
90° Concave Corner 	MTI901 · casters not available	Dimensions	D	W	H	COM \$3,500
		Overall	46	46	31 ½	A \$3,552
		Seat	20 ½		17 ¾	B \$3,653
		Upholstery	Shipping			COL/C \$3,831
		COM Ydg	6 ¼	Ctn Wt	132	D \$4,060
		COL Sq Ft	125	Cu Ft	45	E \$4,255
				Chair Wt	117	F \$4,595
						G \$4,960
						H \$5,272
						I \$5,830
						J \$6,491
						L1 \$5,227
						L2 \$5,714

To Order, Specify:



- 1 Model Number
- 2 Fabric Selection - vendor, pattern and color
 - A. Chair
 - B. Seat Cushion
 Visit www.jsifurniture.com/finishes-and-materials/textiles for our textiles program. See selection of standard and graded in manufacturers and patterns.
- 3 Optional Casters; add \$117 list
- 4 Optional Wood Feet; add \$75 list [See Wood Feet Finish Options](#)
- 5 Optional Tablet Arm, Oval or Rectangular; specify shape, material, finish and add \$726 list
- 6 Optional Arm Cap; specify finish or 3D Laminate and add \$329 list per arm
- 7 Optional Power Center - Flush Mount (EC22) - Black (B) or White (W); add \$613 list each and specify left or right



Specifications

- Metal leg standard with 2 ¾" diameter leveling disc.
- Frame is puzzle jointed plywood construction.
- Seat has synthetic sheet webbing with cross strap reinforcement and 3 ¼" multi-density high resilience polyurethane foam.
- Back has 1 ¾" multi-density high resilience polyurethane foam.
- Upholstered arms are standard.
- Arm tops have 1" high resilience polyurethane foam.
- Optional arm cap is available in Essentials Veneer or Solid Laminate
- Optional tablet arm is available in Essentials, Artisan veneer or HPL with exposed plywood edges.
- Linking bracket included.

Description	Model	Specifications				List Price Per Grade																												
Narrow Inline Club Chair with Work Shelf	MTL264 · casters not available	<table border="1"> <thead> <tr> <th>Dimensions</th> <th>D</th> <th>W</th> <th>H</th> </tr> </thead> <tbody> <tr> <td>Overall</td> <td>41 ¼</td> <td>26</td> <td>39</td> </tr> <tr> <td>Seat</td> <td>20 ½</td> <td>26</td> <td>17 ¾</td> </tr> <tr> <th colspan="2">Upholstery</th> <th colspan="2">Shipping</th> </tr> <tr> <td>COM Ydg</td> <td>3</td> <td>Ctn Wt</td> <td>93</td> </tr> <tr> <td>COL Sq Ft</td> <td>60</td> <td>Cu Ft</td> <td>23</td> </tr> <tr> <td></td> <td></td> <td>Chair Wt</td> <td>83</td> </tr> </tbody> </table>				Dimensions	D	W	H	Overall	41 ¼	26	39	Seat	20 ½	26	17 ¾	Upholstery		Shipping		COM Ydg	3	Ctn Wt	93	COL Sq Ft	60	Cu Ft	23			Chair Wt	83	COM \$2,802 A \$2,827 B \$2,876 COL/C \$2,961 D \$3,071 E \$3,164 F \$3,328 G \$3,503 H \$3,653 I \$3,921 J \$4,238 L1 \$3,631 L2 \$3,865
		Dimensions	D	W	H																													
Overall	41 ¼	26	39																															
Seat	20 ½	26	17 ¾																															
Upholstery		Shipping																																
COM Ydg	3	Ctn Wt	93																															
COL Sq Ft	60	Cu Ft	23																															
		Chair Wt	83																															
																																		

Description	Model	Specifications				List Price Per Grade																												
Inline Club Chair with Work Shelf	MTL304 · casters not available	<table border="1"> <thead> <tr> <th>Dimensions</th> <th>D</th> <th>W</th> <th>H</th> </tr> </thead> <tbody> <tr> <td>Overall</td> <td>41 ¼</td> <td>30</td> <td>39</td> </tr> <tr> <td>Seat</td> <td>20 ½</td> <td>30</td> <td>17 ¾</td> </tr> <tr> <th colspan="2">Upholstery</th> <th colspan="2">Shipping</th> </tr> <tr> <td>COM Ydg</td> <td>3</td> <td>Ctn Wt</td> <td>94</td> </tr> <tr> <td>COL Sq Ft</td> <td>60</td> <td>Cu Ft</td> <td>25</td> </tr> <tr> <td></td> <td></td> <td>Chair Wt</td> <td>87</td> </tr> </tbody> </table>				Dimensions	D	W	H	Overall	41 ¼	30	39	Seat	20 ½	30	17 ¾	Upholstery		Shipping		COM Ydg	3	Ctn Wt	94	COL Sq Ft	60	Cu Ft	25			Chair Wt	87	COM \$2,825 A \$2,850 B \$2,899 COL/C \$2,984 D \$3,094 E \$3,187 F \$3,351 G \$3,526 H \$3,676 I \$3,944 J \$4,261 L1 \$3,654 L2 \$3,888
		Dimensions	D	W	H																													
Overall	41 ¼	30	39																															
Seat	20 ½	30	17 ¾																															
Upholstery		Shipping																																
COM Ydg	3	Ctn Wt	94																															
COL Sq Ft	60	Cu Ft	25																															
		Chair Wt	87																															
																																		

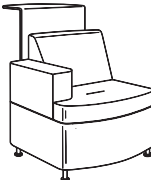
Description	Model	Specifications			List Price Per Grade	
Narrow Inline Club Chair with Arm and Work Shelf	MTL264UAR	Dimensions	D	W	H	COM \$2,979
	MTL264UAL	Overall	41 ¼	26	39	A \$3,006
 right  left	· casters not available	Seat	20 ½	20	17 ¾	B \$3,059
		Upholstery	Shipping			COL/C \$3,151
		COM Ydg	3 ¾	Ctn Wt	106	D \$3,270
		COL Sq Ft	65	Cu Ft	23	E \$3,372
				Chair Wt	95	F \$3,549
						G \$3,738
						H \$3,901
						I \$4,191
						J \$4,535
						L1 \$3,877
						L2 \$4,130

Description	Model	Specifications			List Price Per Grade	
Inline Club Chair with Arm and Work Shelf	MTL304UAR	Dimensions	D	W	H	COM \$3,041
	MTL304UAL	Overall	41 ¼	30	39	A \$3,072
 right  left	· casters not available	Seat	20 ½	23	17 ¾	B \$3,133
		Upholstery	Shipping			COL/C \$3,240
		COM Ydg	3 ¾	Ctn Wt	112	D \$3,377
		COL Sq Ft	75	Cu Ft	25	E \$3,494
				Chair Wt	102	F \$3,698
						G \$3,917
						H \$4,104
						I \$4,439
						J \$4,836
						L1 \$4,078
						L2 \$4,369

To Order, Specify:

- 1 Model Number
- 2 Fabric Selection - vendor, pattern and color
 - A. Chair
 - B. Seat Cushion
 Visit www.jsifurniture.com/finishes-and-materials/textiles for our textiles program. See selection of standard and graded in manufacturers and patterns.
- 3 Optional Wood Feet; add \$75 list [See Wood Feet Finish Options](#)
- 4 Optional Tablet Arm, Oval or Rectangular; specify shape, material, finish and add \$726 list [See Tablet Arm Finish Options](#)
- 5 Optional Arm Cap; specify wood finish or 3D Laminate and add \$329 list per arm [See Arm Cap Finish Options](#)
- 6 Optional Power Center - Flush Mount (EC22) - Black (B) or White (W):
 - Side of Seating; add \$613 list each and specify right or left
 - Back of Work Shelf; add \$732 list each
- 7 Work Shelf Wood Finish [See Work Shelf Wood Finish Options](#)
- 8 Work Shelf Laminate Color Selection [See Laminate Color Selection](#)
- 9 Optional Work Shelf Acrylic Screen; add \$259 list

Specifications

- Metal leg standard with 2 ¾" diameter leveling disc.
- Frame is puzzle jointed plywood construction.
- Seat has synthetic sheet webbing with cross strap reinforcement and 3 ¼" multi-density high resilience polyurethane foam.
- Back has 1 ¾" multi-density high resilience polyurethane foam.
- Upholstered arms are standard.
- Arm tops have 1" high resilience polyurethane foam.
- Optional arm cap is available in Essentials Veneer or Solid Laminate
- Optional tablet arm is available in Essentials, Artisan veneer or HPL with exposed plywood edges.
- 39" high rear work shelf is available in Essentials veneer or solid color HPL with exposed plywood edges.
- Work shelf is field installed.
- Work shelf dimensions 9 ½" x 22"
- Optional frosted acrylic screen with brushed aluminum standoffs is 4 ¾" tall
- Linking bracket included.

Description	Model	Specifications				List Price Per Grade
30° Concave Club Chair with Work Shelf	MTI304 · casters not available	Dimensions				COM \$2,831
			D	W	H	A \$2,856
		Overall	41 ¼	32	39	B \$2,905
		Seat	20 ½		17 ¾	COL/C \$2,990
		Upholstery		Shipping		D \$3,100
		COM Ydg	3	Ctn Wt	95	E \$3,193
		COL Sq Ft	60	Cu Ft	27	F \$3,357
				Chair Wt	83	G \$3,532
						H \$3,682
						I \$3,950
						J \$4,267
						L1 \$3,660
						L2 \$3,894

Description	Model	Specifications				List Price Per Grade
22 ½° Concave Club Chair with Work Shelf	MTI224 · casters not available	Dimensions				COM \$2,847
			D	W	H	A \$2,872
		Overall	41 ¼	32	39	B \$2,921
		Seat	20 ½		17 ¾	COL/C \$3,006
		Upholstery		Shipping		D \$3,116
		COM Ydg	3	Ctn Wt	97	E \$3,209
		COL Sq Ft	60	Cu Ft	27	F \$3,373
				Chair Wt	85	G \$3,548
						H \$3,698
						I \$3,966
						J \$4,283
						L1 \$3,676
						L2 \$3,910

Description

① Model

Specifications

List Price Per Grade

30° Concave Club Chair with Arm and Work Shelf

MTI304UAR
MTI304UAL

- casters not available
- tablet arm not available

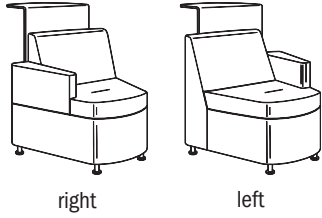

right

left

Dimensions	D	W	H
Overall	41 ¼	32	39
Seat	20 ½		17 ¾
Upholstery		Shipping	
COM Ydg	3 ¾	Ctn Wt	110
COL Sq Ft	75	Cu Ft	27
		Chair Wt	98

COM	\$3,031
A	\$3,062
B	\$3,123
COL/C	\$3,230
D	\$3,367
E	\$3,484
F	\$3,688
G	\$3,907
H	\$4,094
I	\$4,429
J	\$4,826
L1	\$4,068
L2	\$4,359

22 ½° Concave Club Chair with Arm and Work Shelf

MTI224UAR
MTI224UAL

- casters not available
- tablet arm not available

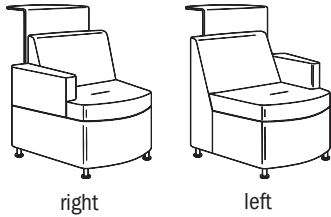

right

left

Dimensions	D	W	H
Overall	41 ¼	32	39
Seat	20 ½		17 ¾
Upholstery		Shipping	
COM Ydg	3 ¾	Ctn Wt	112
COL Sq Ft	75	Cu Ft	27
		Chair Wt	100

COM	\$3,035
A	\$3,066
B	\$3,127
COL/C	\$3,234
D	\$3,371
E	\$3,488
F	\$3,692
G	\$3,911
H	\$4,098
I	\$4,433
J	\$4,830
L1	\$4,072
L2	\$4,363

To Order, Specify:

- ① Model Number
- ② Fabric Selection - vendor, pattern and color
 - A. Chair
 - B. Seat Cushion
 Visit www.jsifurniture.com/finishes-and-materials/textiles for our textiles program. See selection of standard and graded in manufacturers and patterns.
- ③ Optional Wood Feet; add \$75 list [See Wood Feet Finish Options](#)
- ④ Optional Arm Cap; specify wood species, finish or 3D Laminate and add \$329 list per arm [See Arm Cap Finish Options](#)
- ⑤ Optional Power Center - Flush Mount (EC22) - Black (B) or White (W);
 - Side of Seating; add \$613 list each and specify right or left
 - Back of Work Shelf; add \$732 list each
- ⑥ Work Shelf Wood Finish [See Work Shelf Wood Finish Options](#)
- ⑦ Work Shelf Laminate Color Selection [See Laminate Color Selection](#)
- ⑧ Optional Work Shelf Acrylic Screen; add \$259 list

Specifications

- Metal leg standard with 2 ¾" diameter leveling disc.
- Frame is puzzle jointed plywood construction.
- Seat has synthetic sheet webbing with cross strap reinforcement and 3 ¼" multi-density high resilience polyurethane foam.
- Back has 1 ¾" multi-density high resilience polyurethane foam.
- Upholstered arms are standard.
- Arm tops have 1" high resilience polyurethane foam.
- Optional arm cap is available in Essentials Veneer or Solid Laminate
- 39" high rear work shelf is available in Maple, Cherry, Walnut veneer or solid color HPL with exposed plywood edges.
- Work shelf is field installed.
- Work shelf dimensions 9 ½" x 22"
- Optional frosted acrylic screen with brushed aluminum standoffs is 4 ¾" tall
- Linking bracket included.

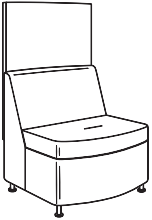
Description	Model	Specifications	List Price Per Grade													
Inline Club Chair with Privacy Screen 	MTL306 · casters not available	<table border="1"> <thead> <tr> <th>Dimensions</th> <th>D</th> <th>W</th> <th>H</th> </tr> </thead> <tbody> <tr> <td>Overall</td> <td>31 ¾</td> <td>30</td> <td>50</td> </tr> <tr> <td>Seat</td> <td>20 ½</td> <td>30</td> <td>17 ¾</td> </tr> </tbody> </table>	Dimensions	D	W	H	Overall	31 ¾	30	50	Seat	20 ½	30	17 ¾	COM \$2,531 A \$2,576 B \$2,666 COL/C \$2,823 D \$3,024 E \$3,195 F \$3,495 G \$3,816 H \$4,090 I \$4,582 J \$5,163 L1 \$3,973 L2 \$4,382	
		Dimensions	D	W	H											
Overall	31 ¾	30	50													
Seat	20 ½	30	17 ¾													
<table border="1"> <thead> <tr> <th>Upholstery</th> <th colspan="3">Shipping</th> </tr> </thead> <tbody> <tr> <td>COM Ydg</td> <td>5 ¼</td> <td>Ctn Wt</td> <td>78</td> </tr> <tr> <td>COL Sq Ft</td> <td>105</td> <td>Cu Ft</td> <td>24</td> </tr> <tr> <td></td> <td></td> <td>Chair Wt</td> <td>67</td> </tr> </tbody> </table>	Upholstery	Shipping			COM Ydg	5 ¼	Ctn Wt	78	COL Sq Ft	105	Cu Ft	24			Chair Wt	67
Upholstery	Shipping															
COM Ydg	5 ¼	Ctn Wt	78													
COL Sq Ft	105	Cu Ft	24													
		Chair Wt	67													

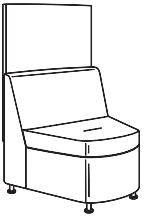
Description	Model	Specifications	List Price Per Grade													
30° Concave Club Chair with Privacy Screen 	MTI306 · casters not available	<table border="1"> <thead> <tr> <th>Dimensions</th> <th>D</th> <th>W</th> <th>H</th> </tr> </thead> <tbody> <tr> <td>Overall</td> <td>31 ¾</td> <td>32</td> <td>50</td> </tr> <tr> <td>Seat</td> <td>20 ½</td> <td></td> <td>17 ¾</td> </tr> </tbody> </table>	Dimensions	D	W	H	Overall	31 ¾	32	50	Seat	20 ½		17 ¾	COM \$2,535 A \$2,578 B \$2,664 COL/C \$2,813 D \$3,006 E \$3,169 F \$3,455 G \$3,761 H \$4,023 I \$4,492 J \$5,048 L1 \$3,986 L2 \$4,395	
		Dimensions	D	W	H											
Overall	31 ¾	32	50													
Seat	20 ½		17 ¾													
<table border="1"> <thead> <tr> <th>Upholstery</th> <th colspan="3">Shipping</th> </tr> </thead> <tbody> <tr> <td>COM Ydg</td> <td>5 ¼</td> <td>Ctn Wt</td> <td>74</td> </tr> <tr> <td>COL Sq Ft</td> <td>105</td> <td>Cu Ft</td> <td>26</td> </tr> <tr> <td></td> <td></td> <td>Chair Wt</td> <td>63</td> </tr> </tbody> </table>	Upholstery	Shipping			COM Ydg	5 ¼	Ctn Wt	74	COL Sq Ft	105	Cu Ft	26			Chair Wt	63
Upholstery	Shipping															
COM Ydg	5 ¼	Ctn Wt	74													
COL Sq Ft	105	Cu Ft	26													
		Chair Wt	63													

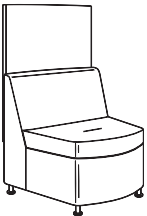
Description	Model	Specifications	List Price Per Grade													
22 ½° Concave Club Chair with Privacy Screen 	MTI226 · casters not available	<table border="1"> <thead> <tr> <th>Dimensions</th> <th>D</th> <th>W</th> <th>H</th> </tr> </thead> <tbody> <tr> <td>Overall</td> <td>31 ¾</td> <td>32</td> <td>50</td> </tr> <tr> <td>Seat</td> <td>20 ½</td> <td></td> <td>17 ¾</td> </tr> </tbody> </table>	Dimensions	D	W	H	Overall	31 ¾	32	50	Seat	20 ½		17 ¾	COM \$2,543 A \$2,586 B \$2,672 COL/C \$2,821 D \$3,014 E \$3,177 F \$3,463 G \$3,769 H \$4,031 I \$4,500 J \$5,056 L1 \$3,994 L2 \$4,403	
		Dimensions	D	W	H											
Overall	31 ¾	32	50													
Seat	20 ½		17 ¾													
<table border="1"> <thead> <tr> <th>Upholstery</th> <th colspan="3">Shipping</th> </tr> </thead> <tbody> <tr> <td>COM Ydg</td> <td>5 ¼</td> <td>Ctn Wt</td> <td>76</td> </tr> <tr> <td>COL Sq Ft</td> <td>105</td> <td>Cu Ft</td> <td>26</td> </tr> <tr> <td></td> <td></td> <td>Chair Wt</td> <td>65</td> </tr> </tbody> </table>	Upholstery	Shipping			COM Ydg	5 ¼	Ctn Wt	76	COL Sq Ft	105	Cu Ft	26			Chair Wt	65
Upholstery	Shipping															
COM Ydg	5 ¼	Ctn Wt	76													
COL Sq Ft	105	Cu Ft	26													
		Chair Wt	65													

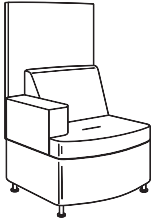
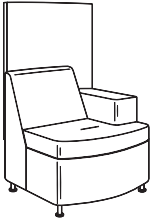
Description	Model	Specifications			List Price Per Grade	
Inline Club Chair with Arm and Privacy Screen   <p style="text-align: center;">right left</p>	MTL306UAR MTL306UAL • casters not available	Dimensions	D	W	H	COM \$2,683
		Overall	31 ¾	30	50	A \$2,733
		Seat	20 ½	23	17 ¾	B \$2,830
		Upholstery	Shipping			COL/C \$3,001
		COM Ydg	6	Ctn Wt	93	D \$3,221
		COL Sq Ft	120	Cu Ft	24	E \$3,407
				Chair Wt	82	F \$3,734
						G \$4,084
						H \$4,384
						I \$4,920
						J \$5,555
						L1 \$4,341
						L2 \$4,808

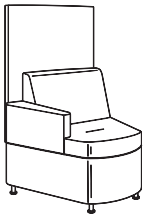
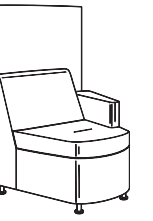
Description	Model	Specifications			List Price Per Grade	
30° Concave Club Chair with Arm and Privacy Screen   <p style="text-align: center;">right left</p>	MTI306UAR MTI306UAL • casters not available • tablet arm not available	Dimensions	D	W	H	COM \$2,734
		Overall	31 ¾	32	50	A \$2,784
		Seat	20 ½		17 ¾	B \$2,881
		Upholstery	Shipping			COL/C \$3,052
		COM Ydg	6	Ctn Wt	89	D \$3,272
		COL Sq Ft	120	Cu Ft	26	E \$3,458
				Chair Wt	78	F \$3,785
						G \$4,135
						H \$4,435
						I \$4,971
						J \$5,606
						L1 \$4,392
						L2 \$4,859

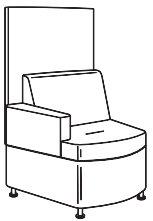
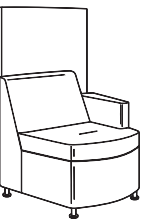
Description	Model	Specifications			List Price Per Grade	
22 ½° Concave Club Chair with Arm and Privacy Screen   <p style="text-align: center;">right left</p>	MTI226UAR MTI226UAL • casters not available • tablet arm not available	Dimensions	D	W	H	COM \$2,741
		Overall	31 ¾	32	50	A \$2,791
		Seat	20 ½		17 ¾	B \$2,888
		Upholstery	Shipping			COL/C \$3,059
		COM Ydg	6	Ctn Wt	91	D \$3,279
		COL Sq Ft	120	Cu Ft	26	E \$3,465
				Chair Wt	80	F \$3,792
						G \$4,142
						H \$4,442
						I \$4,978
						J \$5,613
						L1 \$4,399
						L2 \$4,866

To Order, Specify:

- 1 Model Number
- 2 Fabric Selection - vendor, pattern and color
 - A. Chair
 - B. Seat Cushion
 - C. Privacy Screen
 Visit www.jsifurniture.com/finishes-and-materials/textiles for our textiles program. See selection of standard and graded in manufacturers and patterns.
- 3 Optional Wood Feet; add \$75 list [See Wood Feet Finish Options](#)
- 4 Optional Tablet Arm, Oval or Rectangular; specify shape, material, finish and add \$726 list [See Tablet Arm Finish Options](#)
- 5 Optional Arm Cap; specify wood finish or 3D Laminate and add \$329 list per arm [See Arm Cap Finish Options](#)
- 6 Optional Power Center - Flush Mount (EC22) - Black (B) or White (W); add \$613 list each and specify left or right

Specifications

- Metal leg standard with 2 ¾" diameter leveling disc.
- Frame is puzzle jointed plywood construction.
- Seat has synthetic sheet webbing with cross strap reinforcement and 3 ¼" multi-density high resilience polyurethane foam.
- Back has 1 ¾" multi-density high resilience polyurethane foam.
- Upholstered arms are standard.
- Arm tops have 1" high resilience polyurethane foam.
- Optional arm cap is available in Essentials Veneer or Solid Laminate
- Optional tablet arm is available in Essentials, Artisan veneer, or HPL with exposed plywood edges.
- Upholstered privacy screen has polyurethane foam.
- Screen is field installed.
- Linking bracket included.

Description	Model	Specifications			List Price Per Grade	
Inline Club Chair with Privacy Surround	MTL305	Dimensions			COM \$3,201	
		D	W	H	A \$3,267	
		Overall	31 ¾	33 ½	50	B \$3,397
		Seat	20 ½	30	17 ¾	COL/C \$3,625
		Upholstery		Shipping	D \$3,918	
		COM Ydg	8 ¼	Ctn Wt	118	E \$4,167
		COL Sq Ft	166	Cu Ft	37	F \$4,602
				Chair Wt	107	G \$5,069
						H \$5,469
						I \$6,183
						J \$7,030
						L1 \$5,412
						L2 \$6,034

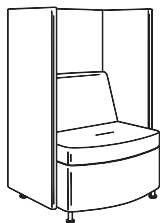

Description	Model	Specifications			List Price Per Grade	
22 ½° Convex Club Chair with Privacy Surround	MT0225	Dimensions			COM \$3,170	
		D	W	H	A \$3,236	
		Overall	31 ¾	33 ½	50	B \$3,366
		Seat	20 ½		17 ¾	COL/C \$3,594
		Upholstery		Shipping	D \$3,887	
		COM Ydg	8 ¼	Ctn Wt	115	E \$4,136
		COL Sq Ft	166	Cu Ft	37	F \$4,571
				Chair Wt	102	G \$5,038
						H \$5,438
						I \$6,152
						J \$6,999
						L1 \$5,381
						L2 \$6,003

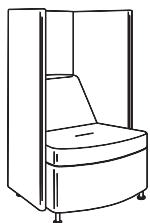

Description	① Model	Specifications			List Price Per Grade		
		Dimensions	D	W	H	COM	
Inline Club Chair with Arm and Privacy Surround	MTL305UAR MTL305UAL · tablet arm not available	Overall	31 ¾	33 ½	50	A	\$3,414
		Seat	20 ½	23	17 ¾	B	\$3,486
		Upholstery		Shipping		C	\$3,628
		COM Ydg	9	Ctn Wt	133	COL/C	\$3,878
		COL Sq Ft	181	Cu Ft	37	D	\$4,198
				Chair Wt	122	E	\$4,470
						F	\$4,947
						G	\$5,458
						H	\$5,894
						I	\$6,676
						J	\$7,602
						L1	\$5,832
						L2	\$6,513

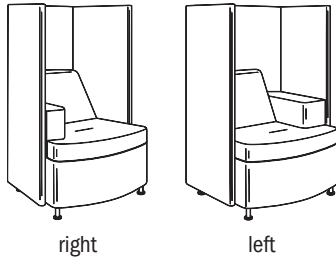

Description	① Model	Specifications			List Price Per Grade		
		Dimensions	D	W	H	COM	
22 ½° Convex Club Chair with Arm and Privacy Surround	MTO225UAR MTO225UAL · tablet arm not available	Overall	31 ¾	33 ½	50	A	\$3,353
		Seat	20 ½		17 ¾	B	\$3,421
		Upholstery		Shipping		C	\$3,555
		COM Ydg	8 ½	Ctn Wt	130	COL/C	\$3,790
		COL Sq Ft	171	Cu Ft	37	D	\$4,092
				Chair Wt	117	E	\$4,349
						F	\$4,798
						G	\$5,280
						H	\$5,692
						I	\$6,429
						J	\$7,301
						L1	\$5,633
						L2	\$6,275

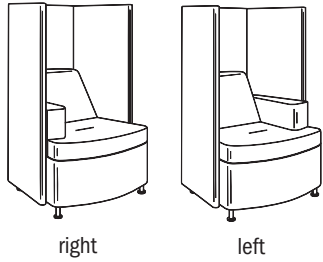

To Order, Specify:

- ① Model Number
- ② Fabric Selection - vendor, pattern and color
 - A. Chair
 - B. Seat Cushion
 - C. Privacy Surround
 Visit www.jsifurniture.com/finishes-and-materials/textiles for our textiles program. See selection of standard and graded in manufacturers and patterns.
- ③ Optional Casters; add \$117 list
- ④ Optional Wood Feet; add \$75 list [See Wood Feet Finish Options](#)
- ⑤ Optional Arm Cap; specify wood finish or 3D Laminate and add \$329 list per arm [See Arm Cap Finish Options](#)
- ⑥ Optional Power Center - Privacy Surround Flush Mount (EC22)
 - Black (B) or White (W); add \$613 list each and specify left or right.

Specifications

- Metal leg standard with 2 ¾" diameter leveling disc.
- Frame is puzzle jointed plywood construction.
- Seat has synthetic sheet webbing with cross strap reinforcement and 3 ¼" multi-density high resilience polyurethane foam.
- Back has 1 ¾" multi-density high resilience polyurethane foam.
- Upholstered arms are standard.
- Arm tops have 1" high resilience polyurethane foam.
- Optional arm cap is available in Essentials Veneer or Solid Laminate
- Upholstered privacy screen has polyurethane foam.

Description	D	W	H	CTN WT	CU FT	① Model	Essentials Veneer	Artisan Veneer
Linking Drum Table	25 13/16	25 13/16	15	48	9	MTV2525DTC	\$3,406	\$3,745



- quarter round
- power unit available, see page MT64

Linking Drum Table	22 1/4	15	15	40	5	MTV1522DTS	\$1,311	\$1,443
--------------------	--------	----	----	----	---	------------	---------	---------

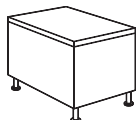

- rectangle
- power unit available, see page MT64

Linking Drum Table	22 1/4	22 1/4	15	47	6	MTV2230DTW	\$1,575	\$1,732
--------------------	--------	--------	----	----	---	------------	---------	---------

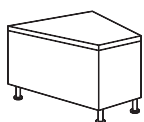

- 30° wedge
- power unit available, see page MT64

Linking Drum Table	22 1/4	22 1/4	15	49	6	MTV2222DTW	\$1,583	\$1,742
--------------------	--------	--------	----	----	---	------------	---------	---------

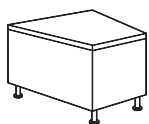



- 22 1/2° wedge
- power unit available, see page MT64

To Order, Specify:

- ① Model Number
- ② Wood Finish [See Wood Finish Options](#)
- ③ Optional Wood Feet; add \$75 list [See Wood Feet Finish Options](#)
- ④ Power Unit
 - Linking Drum Table - Node; specify with EC24 and order separately, see page MT64.

Specifications

- Metal leg standard with 2 3/8" diameter leveling disc.
- Plywood construction with glue, dowel, and metal fasteners.
- Linking bracket included to attach to lounge.

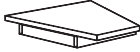
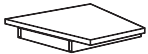
Description	D	W	H	CTN WT	CU FT	① Model	Laminate HPL	Veneer	
								Essentials	Artisan
Linking Table Top 	25 13/16	25 13/16	15	28	4	MTT2525LTC	\$1,237		
	25 13/16	25 13/16	15	28	4	MTV2525LTC		\$1,302	\$1,434
· quarter round									
Linking Table Top 	22 1/4	15	15	18	2	MTT1522LTS	\$1,120		
	22 1/4	15	15	18	2	MTV1522LTS		\$1,180	\$1,297
· rectangular									
Linking Table Top 	22 1/4	22 1/4	15	22	3	MTT2230LTW	\$1,180		
	22 1/4	22 1/4	15	22	3	MTV2230LTW		\$1,238	\$1,364
· 30° wedge									
Linking Table Top 	22 1/4	22 1/4	15	22	3	MTT2222LTW	\$1,180		
	22 1/4	22 1/4	15	22	3	MTV2222LTW		\$1,238	\$1,364
· 22 1/2° wedge									

To Order, Specify:

Veneer Models

- ① Model Number
- ② Wood Finish [See Wood Finish Options](#)

Laminate Models

- ① Model Number
- ② Laminate Color [See Laminate Color Options](#)

Specifications

- 1" thick top with wood rim or PVC edge on silver metal frame.
- Permanent bolt attachment through side of adjacent lounge unit.

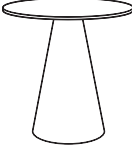
Description	D	W	H	CTN WT	CU FT	① Model	Top Material	
							HPL Laminate or Essentials Veneer	Artisan Veneer
	22	22	26	48	7	MTVP22ROUN	\$1,593	\$1,754
	26	26	26	51	8	MTVP26ROUN	\$1,620	\$1,783
	30	30	26	52	9	MTVP30ROUN	\$1,650	\$1,818

- round top
- power unit not available

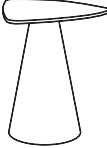
	22	22	26	46	7	MTVP22TRI	\$1,593	\$1,754
	26	26	26	49	8	MTVP26TRI	\$1,620	\$1,783

- triangle top
- power unit not available

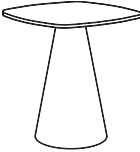
	22	22	26	47	7	MTVP22SQCL	\$1,593	\$1,754
	26	26	26	50	8	MTVP26SQCL	\$1,620	\$1,783

- squircle top
- power unit not available

Description	D	W	H	CTN WT	CU FT	① Model	Top Material	
							HPL Laminate or Essentials Veneer	Artisan Veneer
	36	36	26	116	16	MTVF36ROUN	\$2,279	\$2,508
	42	42	26	127	17	MTVF42ROUN	\$2,355	\$2,592
	48	48	26	138	19	MTVF48ROUN	\$2,423	\$2,664
	54	54	26	152	21	MTVF54ROUN	\$2,510	\$2,761

- round top
- power unit available, see page MT64

	36	36	26	113	16	MTVF36TRI	\$2,307	\$2,537
	42	42	26	122	17	MTVF42TRI	\$2,368	\$2,606
	48	48	26	132	19	MTVF48TRI	\$2,423	\$2,664
	54	54	26	146	21	MTVF54TRI	\$2,510	\$2,761

- triangle top
- power unit available, see page MT64

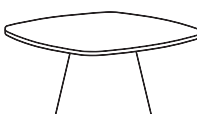
	36	36	26	121	16	MTVF36SQCL	\$2,279	\$2,508
	42	42	26	134	17	MTVF42SQCL	\$2,355	\$2,592
	48	48	26	146	19	MTVF48SQCL	\$2,423	\$2,664
	54	54	26	162	21	MTVF54SQCL	\$2,510	\$2,761

- squircle top
- power unit available, see page MT64

To Order, Specify:

- ① Model Number
- ② Top Material
 - A.) Finish Color [See Top Wood Finish Options](#)
 - B.) Laminate
 - 1.) Laminate Color [See Laminate Color Options](#)
- ③ Conical Base Color [See Base Color Options](#)
- ④ Power Unit - Moire; specify with EC23 cut-out or Node; specify with EC24 cut-out. The EC23 and EC24 must be ordered separately, see page [MT64](#).

Description	D	W	H	CTN WT	CU FT	① Model	Laminate		Veneer	
							TFL Top	HPL Top	Essentials	Artisan
Media Activity Center	48	66	28	245	24	MTT4866-28MATB	\$4,833	\$4,982		
	48	66	28	245	24	MTV4866-28MATB			\$6,015	\$6,615

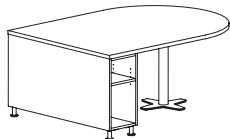
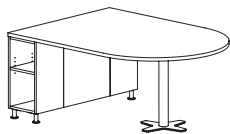

- bullet shape top
- 48" x 66" worksurface
- 28"h worksurface
- side access bookcase base; 12 ¼"w
- front center access panel

Media Activity Center	48	72	28	263	25	MTT4872-28MATB	\$4,898	\$5,050		
	48	72	28	263	25	MTV4872-28MATB			\$6,071	\$6,678

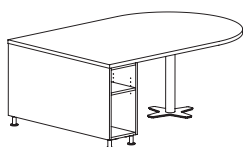
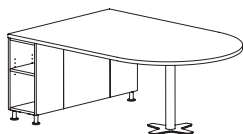

- bullet shape top
- 48" x 72" worksurface
- 28"h worksurface
- side access bookcase base; 12 ¼"w
- front center access panel

Description	D	W	H	CTN WT	CU FT	① Model	Laminate		Veneer	
							TFL Top	HPL Top	Essentials	Artisan
Media Activity Center	48	78	28	281	26	MTT4878-28MATB	\$4,966	\$5,118		
	48	78	28	281	26	MTV4878-28MATB			\$6,097	\$6,707

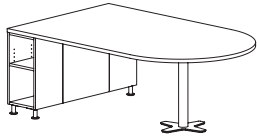

- bullet shape top
- 48" x 78" worksurface
- 28"h worksurface
- side access bookcase base; 12 1/4"w
- front center access panel

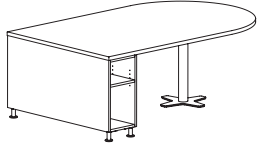

Media Activity Center	48	84	28	299	27	MTT4884-28MATB	\$5,031	\$5,185		
	48	84	28	299	27	MTV4884-28MATB			\$6,188	\$6,809

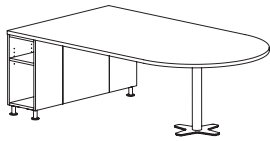

- bullet shape top
- 48" x 84" worksurface
- 28"h worksurface
- side access bookcase base; 12 1/4"w
- front center access panel

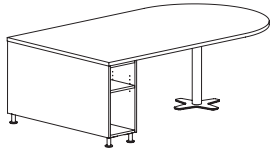

To Order, Specify:

- ① Model Number
- ② Wood Finish [See Wood Finish Options](#)
- ③ Laminate Selection [See Laminate Options](#)
- ④ Optional Wood Feet; add \$75 list [See Wood Feet Finish Options](#)
- ⑤ Optional Power Unit
 - Media Table - Ellora; specify with EC25 and order separately, see page MT64.
- ⑥ Optional Coordinating Wood Grain Laminate Table Top - no upcharge. [See Coordinating Laminate Top Options](#)

Specifications

- Metal leg standard with 2 3/8" diameter leveling disc.
- 3" diameter metal support post with integrated leveling and X-base with neoprene pads.
- Plywood construction with glue, dowel, and metal fasteners.
- 1 3/16" thick worksurface with radiused corners and a wood rim or PVC edge.
- Grommet in media panel
- Bookcase with side access and rear access. Each compartment has one adjustable shelf.
- Rear hinged doors for wire access.
- Removable lower panels for wire access.

Description	D	W	H	CTN WT	CU FT	① Model	Laminate		Veneer	
							TFL Top	HPL Top	Essentials	Artisan
Media Activity Center	48	66	28	240	24	MTT4866-28MATW	\$4,833	\$4,982		
	48	66	28	240	24	MTV4866-28MATW			\$6,015	\$6,615

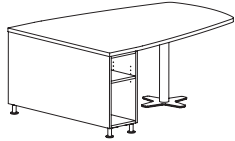
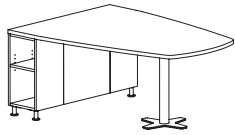

- wedge shape top
- 48" x 66" worksurface
- 28"h worksurface
- side access bookcase base; 12 1/4"w
- front center access panel

Media Activity Center	48	72	28	258	25	MTT4872-28MATW	\$4,898	\$5,050		
	48	72	28	258	25	MTV4872-28MATW			\$6,071	\$6,678

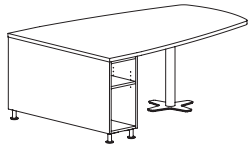
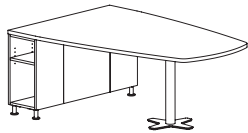

- wedge shape top
- 48" x 72" worksurface
- 28"h worksurface
- side access bookcase base; 12 1/4"w
- front center access panel

Description	D	W	H	CTN WT	CU FT	① Model	Laminate		Veneer	
							TFL Top	HPL Top	Essentials	Artisan
Media Activity Center	48	78	28	276	26	MTT4878-28MATW	\$4,966	\$5,118		
	48	78	28	276	26	MTV4878-28MATW			\$6,097	\$6,707

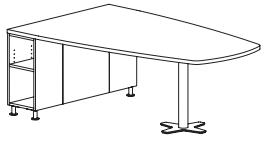

- wedge shape top
- 48" x 78" worksurface
- 28"h worksurface
- side access bookcase base; 12 1/4"w
- front center access panel

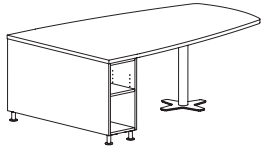

Media Activity Center	48	84	28	294	27	MTT4884-28MATW	\$5,031	\$5,185		
	48	84	28	294	27	MTV4884-28MATW			\$6,188	\$6,809

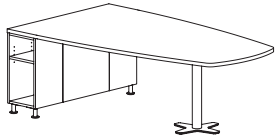

- wedge shape top
- 48" x 84" worksurface
- 28"h worksurface
- side access bookcase base; 12 1/4"w
- front center access panel

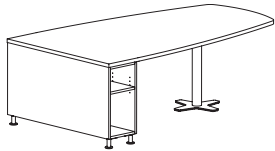

To Order, Specify:

- ① Model Number
- ② Wood Finish [See Wood Finish Options](#)
- ③ Laminate Selection [See Laminate Options](#)
- ④ Optional Wood Feet; add \$75 list [See Wood Feet Finish Options](#)
- ⑤ Optional Power Unit
 - Media Table - Ellora; specify with EC25 and order separately, see page MT64.
- ⑥ Optional Coordinating Wood Grain Laminate Table Top - no upcharge. [See Coordinating Laminate Top Options](#)

Specifications

- Metal leg standard with 2 3/8" diameter leveling disc.
- 3" diameter metal support post with integrated leveling and X-base with neoprene pads.
- Plywood construction with glue, dowel, and metal fasteners.
- 1 3/16" thick worksurface with radiused corners and a wood rim or PVC edge.
- Grommet in media panel
- Bookcase with side access and rear access. Each compartment has one adjustable shelf.
- Rear hinged doors for wire access.
- Removable lower panels for wire access.

Description	D	W	H	CTN WT	CU FT	① Model	Laminate		Veneer	
							TFL Top	HPL Top	Essentials	Artisan
Media Activity Center	48	54	39	241	27	MTT4854-39MATB	\$4,830	\$4,980		
	48	54	39	241	27	MTV4854-39MATB			\$6,078	\$6,687

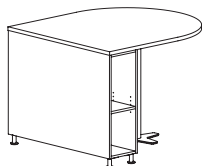
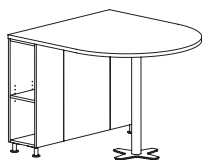

- bullet shape top
- 48" x 54" worksurface
- 39"h worksurface
- side access bookcase base; 12 1/4"w
- front center access panel

Media Activity Center	48	60	39	259	28	MTT4860-39MATB	\$4,884	\$5,036		
	48	60	39	259	28	MTV4860-39MATB			\$6,122	\$6,736

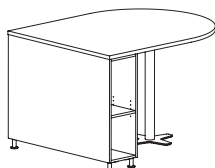
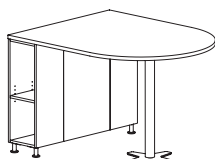

- bullet shape top
- 48" x 60" worksurface
- 39"h worksurface
- side access bookcase base; 12 1/4"w
- front center access panel

Media Activity Center	48	66	39	277	29	MTT4866-39MATB	\$5,016	\$5,171		
	48	66	39	277	29	MTV4866-39MATB			\$6,250	\$6,875

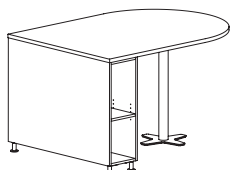
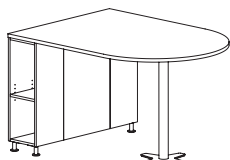

- bullet shape top
- 48" x 66" worksurface
- 39"h worksurface
- side access bookcase base; 12 1/4"w
- front center access panel

Media Activity Center	48	72	39	295	30	MTT4872-39MATB	\$5,080	\$5,238		
	48	72	39	295	30	MTV4872-39MATB			\$6,305	\$6,936

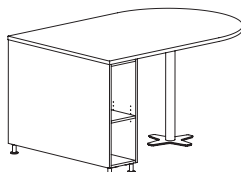
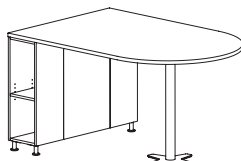

- bullet shape top
- 48" x 72" worksurface
- 39"h worksurface
- side access bookcase base; 12 1/4"w
- front center access panel

Description	D	W	H	CTN WT	CU FT	① Model	Laminate		Veneer	
							TFL Top	HPL Top	Essentials	Artisan
Media Activity Center	48	78	39	313	31	MTT4878-39MATB	\$5,145	\$5,306		
	48	78	39	313	31	MTV4878-39MATB			\$6,360	\$6,999

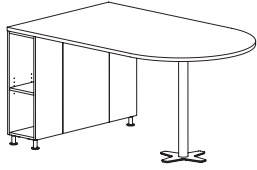

- bullet shape top
- 48" x 78" worksurface
- 39 h worksurface
- side access bookcase base; 12 1/4" w
- front center access panel

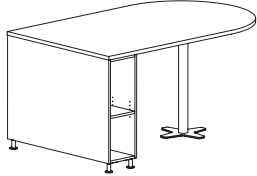

Media Activity Center	48	84	39	331	32	MTT4884-39MATB	\$5,213	\$5,372		
	48	84	39	331	32	MTV4884-39MATB			\$6,421	\$7,063

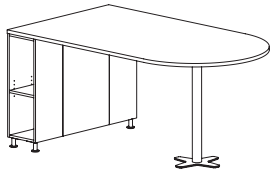

- bullet shape top
- 48" x 84" worksurface
- 39" h worksurface
- side access bookcase base; 12 1/4" w
- front center access panel

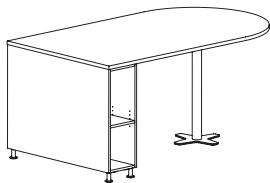

To Order, Specify:

- ① Model Number
- ② Wood Finish [See Wood Finish Options](#)
- ③ Laminate Selection [See Laminate Options](#)
- ④ Optional Wood Feet; add \$75 list [See Wood Feet Finish Options](#)
- ⑤ Optional Power Unit
 - Media Table - Ellora; specify with EC25 and order separately, see page MT64.
- ⑥ Optional Coordinating Wood Grain Laminate Table Top - no upcharge. [See Coordinating Laminate Top Options](#)

Specifications

- Metal leg standard with 2 3/8" diameter leveling disc.
- 3" diameter metal support post with integrated leveling and X-base with neoprene pads.
- Plywood construction with glue, dowel, and metal fasteners.
- 1 3/16" thick worksurface with radiused corners and a wood rim or PVC edge.
- Grommet in media panel
- Bookcase with side access and rear access. Each compartment has one adjustable shelf.
- Rear hinged doors for wire access.
- Removable lower panels for wire access.

Description	D	W	H	CTN WT	CU FT	① Model	Laminate		Veneer	
							TFL Top	HPL Top	Essentials	Artisan
Media Activity Center	48	54	39	236	27	MTT4854-39MATW	\$4,830	\$4,980		
	48	54	39	236	27	MTV4854-39MATW			\$6,078	\$6,687

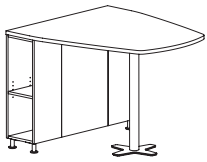

- wedge shape top
- 48" x 54" worksurface
- 39"h worksurface
- side access bookcase base; 12 1/4"w
- front center access panel

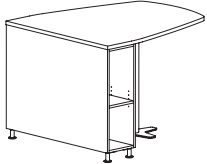

Media Activity Center	48	60	39	254	28	MTT4860-39MATW	\$4,884	\$5,036		
	48	60	39	254	28	MTV4860-39MATW			\$6,122	\$6,736

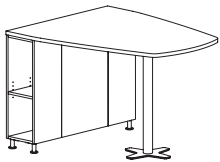

- wedge shape top
- 48" x 60" worksurface
- 39"h worksurface
- side access bookcase base; 12 1/4"w
- front center access panel

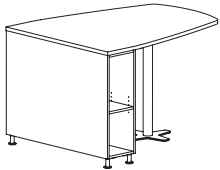

Media Activity Center	48	66	39	272	29	MTT4866-39MATW	\$5,016	\$5,171		
	48	66	39	272	29	MTV4866-39MATW			\$6,250	\$6,875

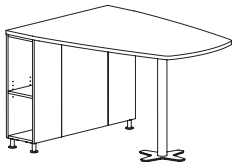

- wedge shape top
- 48" x 66" worksurface
- 39"h worksurface
- side access bookcase base; 12 1/4"w
- front center access panel

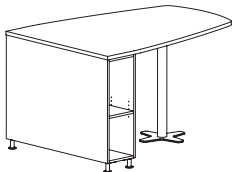

Media Activity Center	48	72	39	290	30	MTT4872-39MATW	\$5,080	\$5,238		
	48	72	39	290	30	MTV4872-39MATW			\$6,305	\$6,936

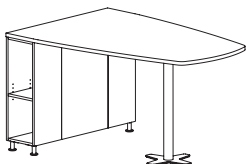

- wedge shape top
- 48" x 72" worksurface
- 39"h worksurface
- side access bookcase base; 12 1/4"w
- front center access panel

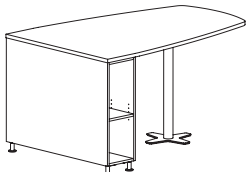

MOTO

Description	D	W	H	CTN WT	CU FT	① Model	Laminate		Veneer	
							TFL Top	HPL Top	Essentials	Artisan
Media Activity Center	48	78	39	308	31	MTT4878-39MATW	\$5,145	\$5,306		
	48	78	39	308	31	MTV4878-39MATW			\$6,360	\$6,999

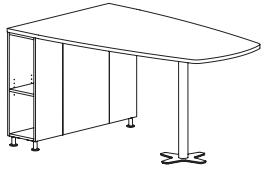

- wedge shape top
- 48" x 78" worksurface
- 39"h worksurface
- side access bookcase base; 12 1/4"w
- front center access panel

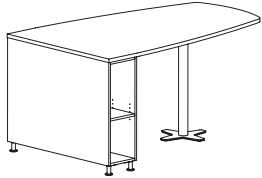

Media Activity Center	48	84	39	326	32	MTT4884-39MATW	\$5,213	\$5,372		
	48	84	39	326	32	MTV4884-39MATW			\$6,421	\$7,063

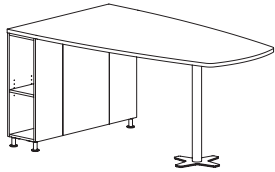

- wedge shape top
- 48" x 84" worksurface
- 39"h worksurface
- side access bookcase base; 12 1/4"w
- front center access panel

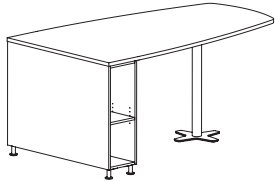

To Order, Specify:

- ① Model Number
- ② Wood Finish [See Wood Finish Options](#)
- ③ Laminate Selection [See Laminate Options](#)
- ④ Optional Wood Feet; add \$75 list [See Wood Feet Finish Options](#)
- ⑤ Optional Power Unit
 - Media Table - Ellora; specify with EC25 and order separately, see page MT64.
- ⑥ Optional Coordinating Wood Grain Laminate Table Top - no upcharge. [See Coordinating Laminate Top Options](#)

Specifications

- Metal leg standard with 2 3/8" diameter leveling disc.
- 3" diameter metal support post with integrated leveling and X-base with neoprene pads.
- Plywood construction with glue, dowel, and metal fasteners.
- 1 3/16" thick worksurface with radiused corners and a wood rim or PVC edge.
- Grommet in media panel
- Bookcase with side access and rear access. Each compartment has one adjustable shelf.
- Rear hinged doors for wire access.
- Removable lower panels for wire access.

Description	D	W	H	CTN WT	CU FT	① Model	Laminate		Veneer	
							TFL Top	HPL Top	Essentials	Artisan
Media Table	48	66	58	363	49	MTT4866-28MACB	\$5,783	\$5,961		
	48	66	58	363	49	MTV4866-28MACB			\$7,728	\$8,502

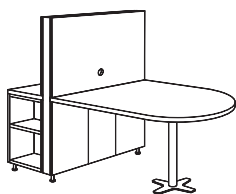

- bullet shape top
- 48" x 48" worksurface
- 28"h worksurface

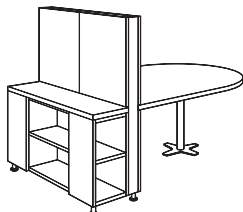

Media Table	48	72	58	381	52	MTT4872-28MACB	\$5,847	\$6,027		
	48	72	58	381	52	MTV4872-28MACB			\$7,784	\$8,563

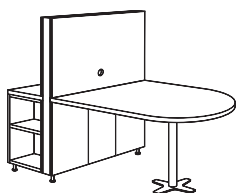

- bullet shape top
- 48" x 54" worksurface
- 28"h worksurface

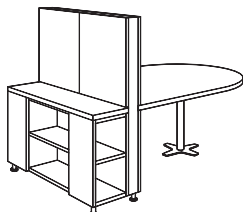

Description	D	W	H	CTN WT	CU FT	① Model	Laminate		Veneer	
							TFL Top	HPL Top	Essentials	Artisan
Media Table	48	78	58	399	54	MTT4878-28MACB	\$5,914	\$6,096		
	48	78	58	399	54	MTV4878-28MACB			\$7,845	\$8,628

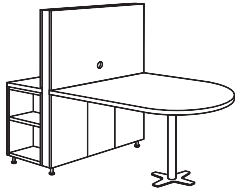

- bullet shape top
- 48" x 60" worksurface
- 28"h worksurface

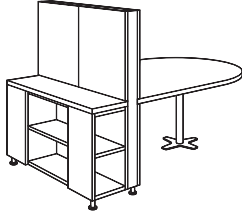

Media Table	48	84	58	417	57	MTT4884-28MACB	\$5,978	\$6,163		
	48	84	58	417	57	MTV4884-28MACB			\$7,904	\$8,692

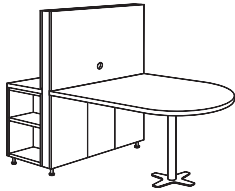

- bullet shape top
- 48" x 66" worksurface
- 28"h worksurface

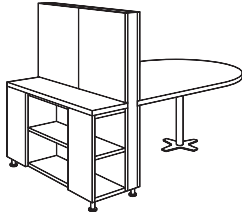

To Order, Specify:

- ① Model Number
- ② Wood Finish [See Wood Finish Options](#)
- ③ Laminate Selection [See Laminate Options](#)
- ④ Optional Wood Feet; add \$75 list [See Wood Feet Finish Options](#)
- ⑤ Optional Power Unit
 - Media Table - Ellora; specify with EC25 and order separately, see page MT64.
- ⑥ Optional Markerboard Back Panel; for 24" unit add \$271 list, for 48" unit add \$527
- ⑦ Deduct TV Bracket; subtract \$186 list
- ⑧ Optional Door Locks; add \$150 list
- ⑨ Optional Coordinating Wood Grain Laminate Table Top - no upcharge. [See Coordinating Laminate Top Options](#)

Specifications

- Metal leg standard with 2 3/8" diameter leveling disc.
- 3" diameter metal support post with integrated leveling and X-base with neoprene pads.
- Plywood construction with glue, dowel, and metal fasteners.
- 1 3/16" thick worksurface with radiused corners and a wood rim or PVC edge.
- Grommet in media panel
- TV bracket included. Recommended TV size 42".
- Bookcase with side access and rear access. Each compartment has one adjustable shelf.
- Rear hinged doors for wire access.
- Removable lower panels for wire access.

Description	D	W	H	CTN WT	CU FT	① Model	Laminate		Veneer	
							TFL Top	HPL Top	Essentials	Artisan
Media Table	48	66	58	358	49	MTT4866-28MACW	\$5,783	\$5,961		
	48	66	58	358	49	MTV4866-28MACW			\$7,728	\$8,502

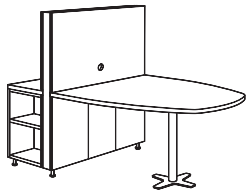

- wedge shape top
- 48" x 48" worksurface
- 28"h worksurface

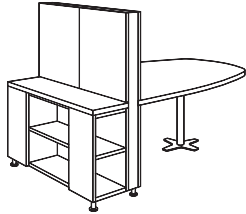

Media Table	48	72	58	374	51	MTT4872-28MACW	\$5,847	\$6,027		
	48	72	58	374	51	MTV4872-28MACW			\$7,784	\$8,563

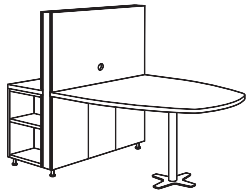

- wedge shape top
- 48" x 54" worksurface
- 28"h worksurface

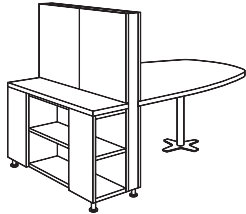

Media Table	48	78	58	391	53	MTT4878-28MACW	\$5,914	\$6,096		
	48	78	58	391	53	MTV4878-28MACW			\$7,845	\$8,628

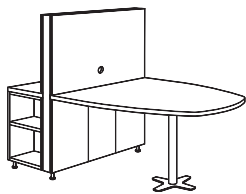

- wedge shape top
- 48" x 60" worksurface
- 28"h worksurface

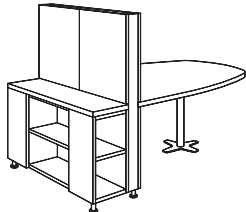

MOTO

Description	D	W	H	CTN WT	CU FT	① Model	Laminate		Veneer	
							TFL Top	HPL Top	Essentials	Artisan
Media Table	48	84	58	407	56	MTT4884-28MACW	\$5,978	\$6,163		
	48	84	58	407	56	MTV4884-28MACW			\$7,904	\$8,692

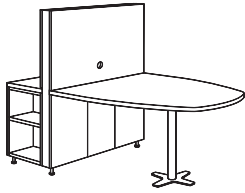

- wedge shape top
- 48" x 66" worksurface
- 28" h worksurface

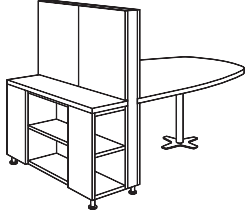

To Order, Specify:

- ① Model Number
- ② Wood Finish [See Wood Finish Options](#)
- ③ Laminate Selection [See Laminate Options](#)
- ④ Optional Wood Feet; add \$75 list [See Wood Feet Finish Options](#)
- ⑤ Optional Power Unit
 - Media Table - Ellora; specify with EC25 and order separately, see page MT64.
- ⑥ Optional Markerboard Back Panel; for 24" unit add \$271 list, for 48" unit add \$527
- ⑦ Deduct TV Bracket; subtract \$186 list
- ⑧ Optional Door Locks; add \$150 list
- ⑨ Optional Coordinating Wood Grain Laminate Table Top - no upcharge. [See Coordinating Laminate Top Options](#)

Specifications

- Metal leg standard with 2 3/8" diameter leveling disc.
- 3" diameter metal support post with integrated leveling and X-base with neoprene pads.
- Plywood construction with glue, dowel, and metal fasteners.
- 1 3/16" thick worksurface with radiused corners and a wood rim or PVC edge.
- Grommet in media panel
- TV bracket included. Recommended TV size 42".
- Bookcase with side access and rear access. Each compartment has one adjustable shelf.
- Rear hinged doors for wire access.
- Removable lower panels for wire access.

Description	D	W	H	CTN WT	CU FT	① Model	Laminate		Veneer	
							TFL Top	HPL Top	Essentials	Artisan
Media Table	48	54	68	367	51	MTT4854-39MACB	\$5,771	\$5,948		
	48	54	68	367	51	MTV4854-39MACB			\$7,784	\$8,563

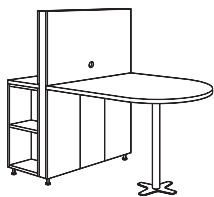

- bullet shape top
- 48" x 36" worksurface
- 39"h worksurface

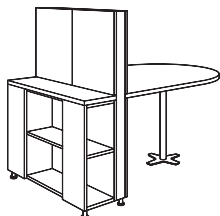

Media Table	48	60	68	385	54	MTT4860-39MACB	\$5,825	\$6,004		
	48	60	68	385	54	MTV4860-39MACB			\$7,831	\$8,615

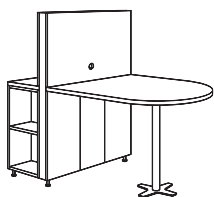

- bullet shape top
- 48" x 42" worksurface
- 39"h worksurface

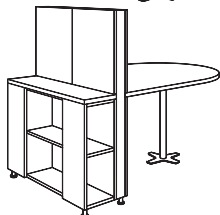

Media Table	48	66	68	403	56	MTT4866-39MACB	\$5,959	\$6,142		
	48	66	68	403	56	MTV4866-39MACB			\$7,956	\$8,752

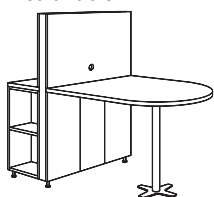

- bullet shape top
- 48" x 48" worksurface
- 39"h worksurface

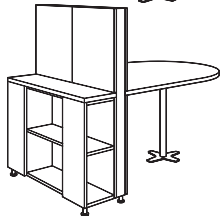

Media Table	48	72	68	421	59	MTT4872-39MACB	\$6,019	\$6,205		
	48	72	68	421	59	MTV4872-39MACB			\$8,012	\$8,814

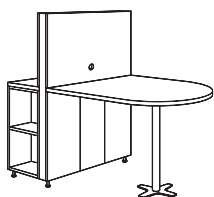

- bullet shape top
- 48" x 54" worksurface
- 39"h worksurface

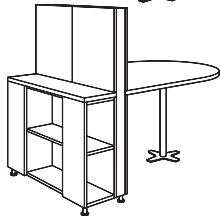

MOTO

Description	D	W	H	CTN WT	CU FT	① Model	Laminate		Veneer	
							TFL Top	HPL Top	Essentials	Artisan
Media Table	48	78	68	439	61	MTT4878-39MACB	\$6,087	\$6,275		
	48	78	68	439	61	MTV4878-39MACB			\$8,072	\$8,880

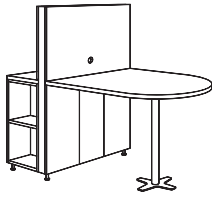

- bullet shape top
- 48" x 60" worksurface
- 39"h worksurface

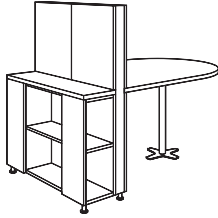

Media Table	48	84	68	457	64	MTT4884-39MACB	\$6,155	\$6,345		
	48	84	68	457	64	MTV4884-39MACB			\$8,133	\$8,945

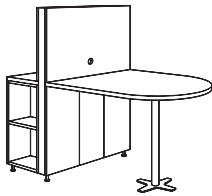

- bullet shape top
- 48" x 66" worksurface
- 39"h worksurface

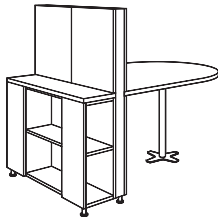

To Order, Specify:

- ① Model Number
- ② Wood Finish [See Wood Finish Options](#)
- ③ Laminate Selection [See Laminate Options](#)
- ④ Optional Wood Feet; add \$75 list [See Wood Feet Finish Options](#)
- ⑤ Optional Power Unit
 - Media Table - Ellora; specify with EC25 and order separately, see page MT64.
- ⑥ Optional Markerboard Back Panel; for 24" unit add \$271 list, for 48" unit add \$527
- ⑦ Deduct TV Bracket; subtract \$186 list
- ⑧ Optional Door Locks; add \$150 list
- ⑨ Optional Coordinating Wood Grain Laminate Table Top - no upcharge. [See Coordinating Laminate Top Options](#)

Specifications

- Metal leg standard with 2 3/8" diameter leveling disc.
- 3" diameter metal support post with integrated leveling and X-base with neoprene pads.
- Plywood construction with glue, dowel, and metal fasteners.
- 1 3/16" thick worksurface with radiused corners and a wood rim or PVC edge.
- Grommet in media panel
- TV bracket included. Recommended TV size 42".
- Bookcase with side access and rear access. Each compartment has one adjustable shelf.
- Rear hinged doors for wire access.
- Removable lower panels for wire access.

Description	D	W	H	CTN WT	CU FT	① Model	Laminate		Veneer	
							TFL Top	HPL Top	Essentials	Artisan
Media Table	48	54	68	365	51	MTT4854-39MACW	\$5,771	\$5,948		
	48	54	68	365	51	MTV4854-39MACW			\$7,784	\$8,563

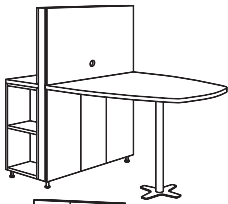

- wedge shape top
- 48" x 36" worksurface
- 39"h worksurface

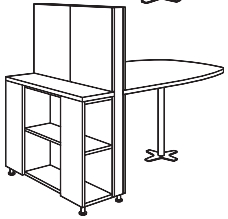

Media Table	48	60	68	381	53	MTT4860-39MACW	\$5,825	\$6,004		
	48	60	68	381	53	MTV4860-39MACW			\$7,831	\$8,615

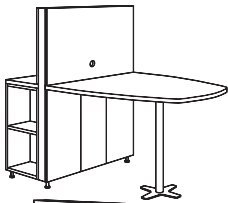

- wedge shape top
- 48" x 42" worksurface
- 39"h worksurface

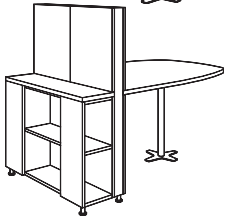

Media Table	48	66	68	398	56	MTT4866-39MACW	\$5,959	\$6,142		
	48	66	68	398	56	MTV4866-39MACW			\$7,956	\$8,752

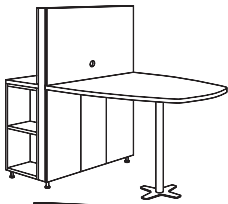

- wedge shape top
- 48" x 48" worksurface
- 39"h worksurface

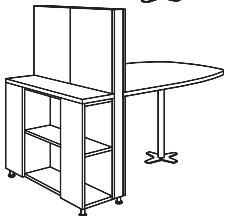

Media Table	48	72	68	414	58	MTT4872-39MACW	\$6,019	\$6,205		
	48	72	68	414	58	MTV4872-39MACW			\$8,012	\$8,814

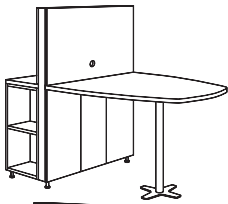

- wedge shape top
- 48" x 54" worksurface
- 39"h worksurface

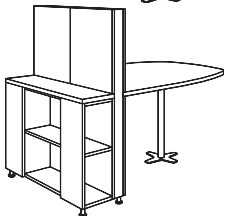

Description	D	W	H	CTN WT	CU FT	① Model	Laminate		Veneer	
							TFL Top	HPL Top	Essentials	Artisan
Media Table	48	78	68	431	60	MTT4878-39MACW	\$6,087	\$6,275		
	48	78	68	431	60	MTV4878-39MACW			\$8,072	\$8,880

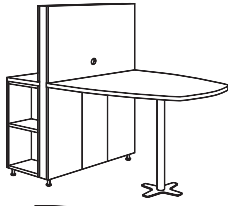

- wedge shape top
- 48" x 60" worksurface
- 39"h worksurface

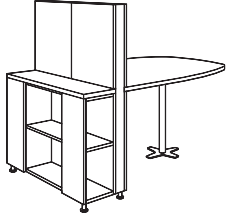

Media Table	48	84	68	447	63	MTT4884-39MACW	\$6,155	\$6,345		
	48	84	68	447	63	MTV4884-39MACW			\$8,133	\$8,945

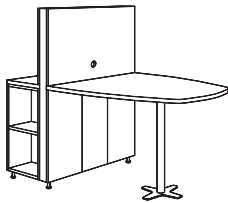

- wedge shape top
- 48" x 66" worksurface
- 39"h worksurface

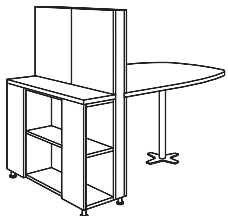

To Order, Specify:

- ① Model Number
- ② Wood Finish [See Wood Finish Options](#)
- ③ Laminate Selection [See Laminate Options](#)
- ④ Optional Wood Feet; add \$75 list [See Wood Feet Finish Options](#)
- ⑤ Optional Power Unit
 - Media Table - Ellora; specify with EC25 and order separately, see page MT64.
- ⑥ Optional Markerboard Back Panel; for 24" unit add \$271 list, for 48" unit add \$527
- ⑦ Deduct TV Bracket; subtract \$186 list
- ⑧ Optional Door Locks; add \$150 list
- ⑨ Optional Coordinating Wood Grain Laminate Table Top - no upcharge. [See Coordinating Laminate Top Options](#)

Specifications

- Metal leg standard with 2 3/8" diameter leveling disc.
- 3" diameter metal support post with integrated leveling and X-base with neoprene pads.
- Plywood construction with glue, dowel, and metal fasteners.
- 1 3/16" thick worksurface with radiused corners and a wood rim or PVC edge.
- Grommet in media panel
- TV bracket included. Recommended TV size 42".
- Bookcase with side access and rear access. Each compartment has one adjustable shelf.
- Rear hinged doors for wire access.
- Removable lower panels for wire access.

Description	D	W	H	CTN WT	CU FT	① Model	Laminate		Veneer	
							TFL Top	HPL Top	Essentials	Artisan
Wall Dependent Media Table	48	54	58	217	20	MTT4854-28MAWB	\$4,618	\$4,758		
	48	54	58	217	20	MTV4854-28MAWB			\$5,720	\$6,293

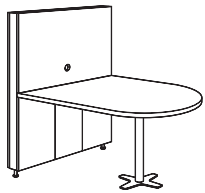

- bullet shape top
- 48" x 48" worksurface
- 28"h worksurface

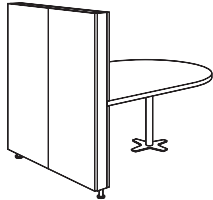

Wall Dependent Media Table	48	60	58	235	23	MTT4860-28MAWB	\$4,683	\$4,827		
	48	60	58	235	23	MTV4860-28MAWB			\$5,779	\$6,354

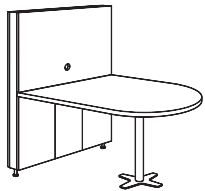

- bullet shape top
- 48" x 54" worksurface
- 28"h worksurface

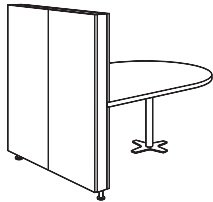

Wall Dependent Media Table	48	66	58	253	25	MTT4866-28MAWB	\$4,750	\$4,895		
	48	66	58	253	25	MTV4866-28MAWB			\$5,800	\$6,382

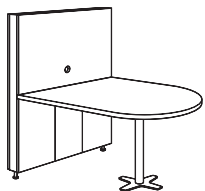

- bullet shape top
- 48" x 60" worksurface
- 28"h worksurface

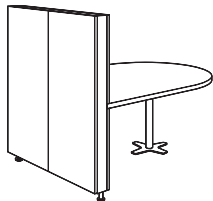

MOTO

Description	D	W	H	CTN WT	CU FT	① Model	Laminate		Veneer	
							TFL Top	HPL Top	Essentials	Artisan
Wall Dependent Media Table	48	72	58	271	28	MTT4872-28MAWB	\$4,813	\$4,964		
	48	72	58	271	28	MTV4872-28MAWB			\$5,894	\$6,486

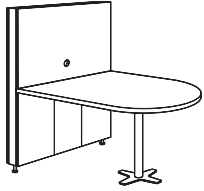

- bullet shape top
- 48" x 66" worksurface
- 28"h worksurface

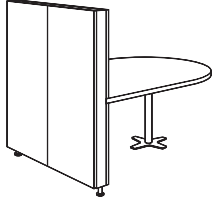

To Order, Specify:

- ① Model Number
- ② Wood Finish [See Wood Finish Options](#)
- ③ Laminate Selection [See Laminate Options](#)
- ④ Optional Wood Feet; add \$75 list [See Wood Feet Finish Options](#)
- ⑤ Optional Power Unit
 - Media Table - Ellora; specify with EC25 and order separately, see page MT64.
- ⑥ Deduct TV Bracket; subtract \$186 list
- ⑦ Optional Door Locks; add \$150 list
- ⑧ Optional Coordinating Wood Grain Laminate Table Top - no upcharge. [See Coordinating Laminate Top Options](#)

Specifications

- Metal leg standard with 2 3/8" diameter leveling disc.
- 3" diameter metal support post with integrated leveling and X-base with neoprene pads.
- Plywood construction with glue, dowel, and metal fasteners.
- 1 3/8" thick worksurface with radiused corners and a wood rim or PVC edge.
- Grommet in media panel
- TV bracket included. Recommended TV size 42".
- Rear hinged doors for wire access.
- Removable lower panels for wire access.
- Intended for use against a wall. Does not attach to the wall.

Description	D	W	H	CTN WT	CU FT	① Model	Laminate		Veneer	
							TFL Top	HPL Top	Essentials	Artisan
Wall Dependent Media Table	48	54	58	212	20	MTT4854-28MAWW	\$4,618	\$4,758		
	48	54	58	212	20	MTV4854-28MAWW			\$5,720	\$6,293

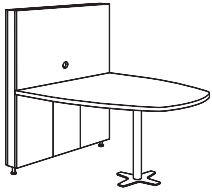

- wedge shape top
- 48" x 48" worksurface
- 28"h worksurface

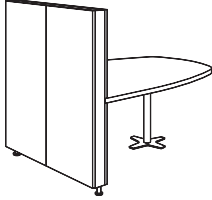

Wall Dependent Media Table	48	60	58	228	22	MTT4860-28MAWW	\$4,683	\$4,827		
	48	60	58	228	22	MTV4860-28MAWW			\$5,779	\$6,354

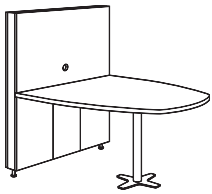

- wedge shape top
- 48" x 54" worksurface
- 28"h worksurface

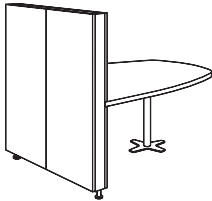

Wall Dependent Media Table	48	66	58	245	24	MTT4866-28MAWW	\$4,750	\$4,895		
	48	66	58	245	24	MTV4866-28MAWW			\$5,800	\$6,382

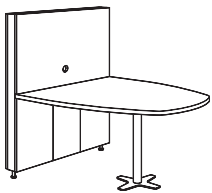

- wedge shape top
- 48" x 60" worksurface
- 28"h worksurface

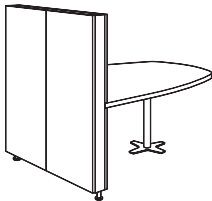

MOTO

Description	D	W	H	CTN WT	CU FT	① Model	Laminate		Veneer	
							TFL Top	HPL Top	Essentials	Artisan
Wall Dependent Media Table	48	72	58	261	27	MTT4872-28MAWW	\$4,813	\$4,964		
	48	72	58	261	27	MTV4872-28MAWW			\$5,894	\$6,486

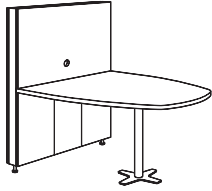

- wedge shape top
- 48" x 66" worksurface
- 28"h worksurface

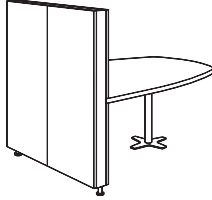

To Order, Specify:

- ① Model Number
- ② Wood Finish [See Wood Finish Options](#)
- ③ Laminate Selection [See Laminate Options](#)
- ④ Optional Wood Feet; add \$75 list [See Wood Feet Finish Options](#)
- ⑤ Optional Power Unit
 - Media Table - Ellora; specify with EC25 and order separately, see page MT64.
- ⑥ Deduct TV Bracket; subtract \$186 list
- ⑦ Optional Door Locks; add \$150 list
- ⑧ Optional Coordinating Wood Grain Laminate Table Top - no upcharge. [See Coordinating Laminate Top Options](#)

Specifications

- Metal leg standard with 2 3/8" diameter leveling disc.
- 3" diameter metal support post with integrated leveling and X-base with neoprene pads.
- Plywood construction with glue, dowel, and metal fasteners.
- 1 3/8" thick worksurface with radiused corners and a wood rim or PVC edge.
- Grommet in media panel
- TV bracket included. Recommended TV size 42".
- Rear hinged doors for wire access.
- Removable lower panels for wire access.
- Intended for use against a wall. Does not attach to the wall.

Description	D	W	H	CTN WT	CU FT	① Model	Laminate		Veneer	
							TFL Top	HPL Top	Essentials	Artisan
Wall Dependent Media Table	48	42	68	204	17	MTT4842-39MAWB	\$4,614	\$4,755		
	48	42	68	204	17	MTV4842-39MAWB			\$5,769	\$6,347

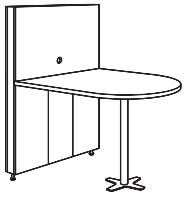

- bullet shape top
- 48" x 36" worksurface
- 39"h worksurface

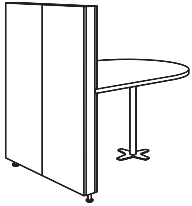

Wall Dependent Media Table	48	48	68	222	20	MTT4848-39MAWB	\$4,666	\$4,809		
	48	48	68	222	20	MTV4848-39MAWB			\$5,819	\$6,397

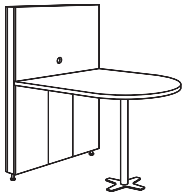

- bullet shape top
- 48" x 42" worksurface
- 39"h worksurface

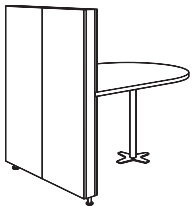

Wall Dependent Media Table	48	54	68	240	22	MTT4854-39MAWB	\$4,801	\$4,946		
	48	54	68	240	22	MTV4854-39MAWB			\$5,939	\$6,536

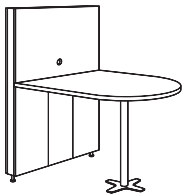

- bullet shape top
- 48" x 48" worksurface
- 39"h worksurface

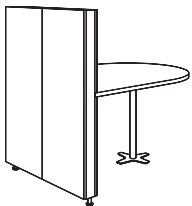

Wall Dependent Media Table	48	60	68	258	25	MTT4860-39MAWB	\$4,864	\$5,014		
	48	60	68	258	25	MTV4860-39MAWB			\$5,999	\$6,599

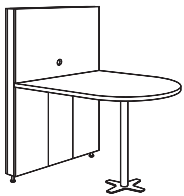

- bullet shape top
- 48" x 54" worksurface
- 39"h worksurface

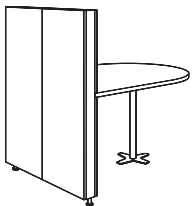

Description	D	W	H	CTN WT	CU FT	① Model	Laminate		Veneer	
							TFL Top	HPL Top	Essentials	Artisan
Wall Dependent Media Table	48	66	68	276	27	MTT4866-39MAWB	\$4,931	\$5,080		
	48	66	68	276	27	MTV4866-39MAWB			\$6,056	\$6,661

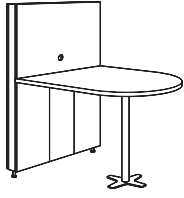

- bullet shape top
- 48" x 60" worksurface
- 39"h worksurface

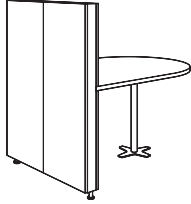

Wall Dependent Media Table	48	72	68	294	30	MTT4872-39MAWB	\$4,994	\$5,151		
	48	72	68	294	30	MTV4872-39MAWB			\$6,113	\$6,725

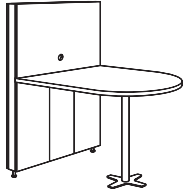

- bullet shape top
- 48" x 66" worksurface
- 39" worksurface

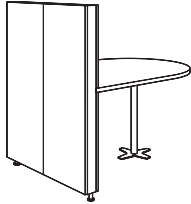

To Order, Specify:

- ① Model Number
- ② Wood Finish [See Wood Finish Options](#)
- ③ Laminate Selection [See Laminate Options](#)
- ④ Optional Wood Feet; add \$75 list [See Wood Feet Finish Options](#)
- ⑤ Optional Power Unit
 - Media Table - Ellora; specify with EC25 and order separately, see page MT64.
- ⑥ Deduct TV Bracket; subtract \$186 list
- ⑦ Optional Door Locks; add \$150 list
- ⑧ Optional Coordinating Wood Grain Laminate Table Top - no upcharge. [See Coordinating Laminate Top Options](#)

Specifications

- Metal leg standard with 2 3/8" diameter leveling disc.
- 3" diameter metal support post with integrated leveling and X-base with neoprene pads.
- Plywood construction with glue, dowel, and metal fasteners.
- 1 3/8" thick worksurface with radiused corners and a wood rim or PVC edge.
- Grommet in media panel
- TV bracket included. Recommended TV size 42".
- Rear hinged doors for wire access.
- Removable lower panels for wire access.
- Intended for use against a wall. Does not attach to the wall.

Description	D	W	H	CTN WT	CU FT	① Model	Laminate		Veneer	
							TFL Top	HPL Top	Essentials	Artisan
Wall Dependent Media Table	48	42	68	202	17	MTT4842-39MAWW	\$4,614	\$4,755		
	48	42	68	202	17	MTV4842-39MAWW			\$5,769	\$6,347



- wedge shape top
- 48" x 36" worksurface
- 39"h worksurface

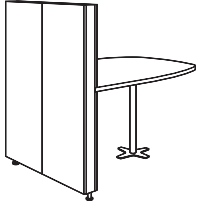

Wall Dependent Media Table	48	48	68	218	19	MTT4848-39MAWW	\$4,666	\$4,809		
	48	48	68	218	19	MTV4848-39MAWW			\$5,819	\$6,397

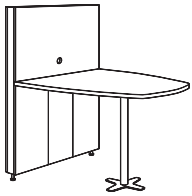

- wedge shape top
- 48" x 42" worksurface
- 39"h worksurface

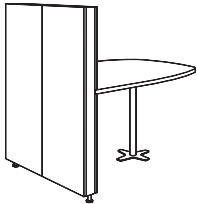

Wall Dependent Media Table	48	54	68	235	22	MTT4854-39MAWW	\$4,801	\$4,946		
	48	54	68	235	22	MTV4854-39MAWW			\$5,939	\$6,536



- wedge shape top
- 48" x 48" worksurface
- 39"h worksurface

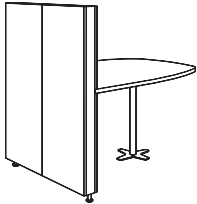

Wall Dependent Media Table	48	60	68	251	24	MTT4860-39MAWW	\$4,864	\$5,014		
	48	60	68	251	24	MTV4860-39MAWW			\$5,999	\$6,599



- wedge shape top
- 48" x 54" worksurface
- 39"h worksurface

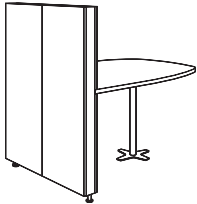

MOTO

Description	D	W	H	CTN WT	CU FT	① Model	Laminate		Veneer	
							TFL Top	HPL Top	Essentials	Artisan
Wall Dependent Media Table	48	66	68	268	26	MTT4866-39MAWW	\$4,931	\$5,080		
	48	66	68	268	26	MTV4866-39MAWW			\$6,056	\$6,661

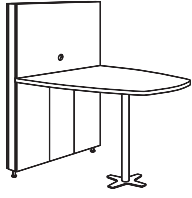

- wedge shape top
- 48" x 60" worksurface
- 39"h worksurface

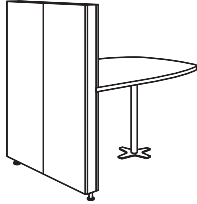

Wall Dependent Media Table	48	72	68	284	29	MTT4872-39MAWW	\$4,994	\$5,151		
	48	72	68	284	29	MTV4872-39MAWW			\$6,113	\$6,725



- wedge shape top
- 48" x 66" worksurface
- 39"h worksurface

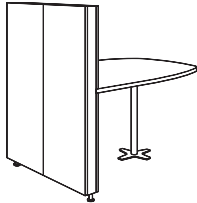

To Order, Specify:

- ① Model Number
- ② Wood Finish [See Wood Finish Options](#)
- ③ Laminate Selection [See Laminate Options](#)
- ④ Optional Wood Feet; add \$75 list [See Wood Feet Finish Options](#)
- ⑤ Optional Power Unit
 - Media Table - Ellora; specify with EC25 and order separately, see page MT64.
- ⑥ Deduct TV Bracket; subtract \$186 list
- ⑦ Optional Door Locks; add \$150 list
- ⑧ Optional Coordinating Wood Grain Laminate Table Top - no upcharge. [See Coordinating Laminate Top Options](#)

Specifications

- Metal leg standard with 2 3/8" diameter leveling disc.
- 3" diameter metal support post with integrated leveling and X-base with neoprene pads.
- Plywood construction with glue, dowel, and metal fasteners.
- 1 3/8" thick worksurface with radiused corners and a wood rim or PVC edge.
- Grommet in media panel
- TV bracket included. Recommended TV size 42".
- Rear hinged doors for wire access.
- Removable lower panels for wire access.
- Intended for use against a wall. Does not attach to the wall.

Description	D	W	H	CTN WT	CU FT	① Model	Laminate		Veneer	
							TFL Top	HPL Top	Essentials	Artisan
Media Credenza	18	48	58	280	35	MTT1848MCW	\$3,927	\$4,046		
	18	48	58	280	35	MTV1848MCW			\$5,500	\$6,052

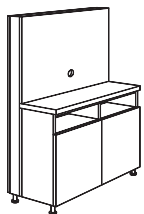

- 13" x 48" top surface
- 2 door cabinet

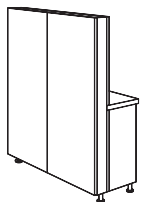

Description	D	W	H	CTN WT	CU FT	① Model	Laminate	Veneer	
								Essentials	Artisan
Bookcase Storage	18	24	58	176	19	MTT1824-58SDR	\$1,523		
	18	24	58	176	19	MTV1824-58SDR		\$2,202	\$2,424
	18	24	58	176	19	MTT1824-58SDL	\$1,523		
	18	24	58	176	19	MTV1824-58SDL		\$2,202	\$2,424

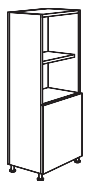

- door hinge left or right

Bookcase Storage	18	48	58	227	35	MTT1848-58SDC	\$1,718		
	18	48	58	227	35	MTV1848-58SDC		\$2,408	\$2,652

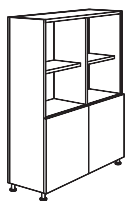

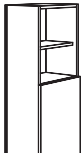
Description	D	W	H	CTN WT	CU FT	① Model	Laminate	Essentials Veneer	Artisan Veneer
	18	24	68	199	22	MTT1824-68SDR	\$1,590		
	18	24	68	199	22	MTV1824-68SDR		\$2,287	\$2,514
	18	24	68	199	22	MTT1824-68SDL	\$1,590		
	18	24	68	199	22	MTV1824-68SDL		\$2,287	\$2,514

· door hinge left or right

Bookcase Storage	18	48	68	268	41	MTT1848-68SDC	\$1,902		
	18	48	68	268	41	MTV1848-68SDC		\$2,643	\$2,909

To Order, Specify:

- ① Model Number
- ② Wood Finish [See Wood Finish Options](#)
- ③ Laminate Selection [See Laminate Options](#)
- ④ Optional Wood Feet; add \$75 list [See Wood Feet Finish Options](#)
- ⑤ Optional Power Unit
 - Media Credenza - Ellora; specify with EC25 and order separately, see page MT64.
- ⑥ Optional Markerboard Back Panel; for 24" unit add \$271 list, for 48" unit add \$527
- ⑦ Deduct TV Bracket; subtract \$186 list
- ⑧ Optional Door Locks; add \$150 lists

Specifications

Media Credenza

- Metal leg standard with 2 3/8" diameter leveling disc.
- Plywood construction with glue, dowel, and metal fasteners.
- Grommet in media panel
- TV bracket included. Recommended TV size 42".
- Open shelf with hinged door compartment below.
- Rear hinged doors for wire access.

Bookcase Storage

- Metal leg standard with 2 3/8" diameter leveling disc.
- Plywood construction with glue, dowel, and metal fasteners.
- Open shelf with hinged door compartment below.
- Adjustable shelves.

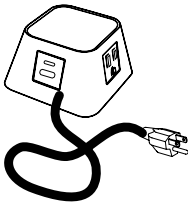
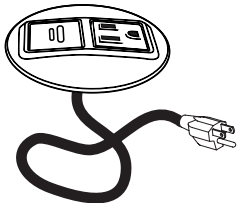
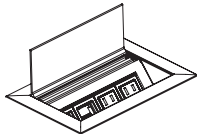
Description	D	W	H	CTN WT	CU FT	① Model	List Price
 <p>Moire Power Unit</p> <ul style="list-style-type: none"> · used in Conical Work Tables · three power 110 outlets · one 20-watt USB-C+A · 72" 3-prong - 15amp plug power feed · 15amp/110 volt · specify Black (BK) or White (WH) 	3 3/8	3 3/8	2	5	1	EC23	\$496
 <p>Node Power Unit</p> <ul style="list-style-type: none"> · used in Linking Drum Tables · one power · one 20-watt USB-C+A, 72" cord · color: black or white 	3 3/8	3 3/8	3/8	5	1	EC24	\$396
 <p>Ellora Power Unit</p> <ul style="list-style-type: none"> · used in Media Table or Media Credenza · two power, one 20-watt USB-C+A & one opening for voice/data port, 72" power cord · adapter kit provided to accept jacks for most port manufactures · accepts one Type 3 telecom jack · wire pass-through · anodized aluminum 	5 1/2	8 1/2	3 1/2	5	1	EC25	\$759

To Order, Specify:

- ① Model Number