

Privacy Solutions



PRIVACY

Privacy Solutions

- Under-Surface Mount [PS2-PS14](#)
- Above-Surface Mount [PS15-PS20](#)
- Edge Mount [PS21](#)
- Side Mount [PS22-PS23](#)
- Freestanding Soft-Sided [PS24-PS33](#)
- Freestanding Hard-Sided. [PS34-PS35](#)

Privacy Solutions - Cleaning Guidelines

We offer numerous textile and hard surface options that will stand up to the rigors of frequent bleach cleaning, ranging from untreated surfaces to those with anti-microbial topcoats. Please contact our Customer Support Team today for more information.

MATERIALS:

ACRYLIC: water based foam or cleaner and bleach cleanable (5:1)*

ACOUSTIC PET: bleach solution cleanable (2% bleach)*

HPL LAMINATE: recommended by suppliers: Clorox Healthcare Bleach Germicidal wipes, Virex II 256, PDI Super Sani-Cloth wipes, PDI Sani-Prime Germicidal spray

TFL LAMINATE: cleaning guidelines will vary between manufacturer; cleaning details available upon request

VENEER: first clean with warm soapy water - do not soak. Pledge Antibacterial cleaner or bleach free disinfectant wipes are recommended

COATED FABRIC: water based foam or cleaner and bleach cleanable (4:1)*

FABRIC: cleaning guidelines will vary between fabric type, pattern and manufacturer; see material recommendations for bleach-solution cleanable fabrics

*Bleach solution cleanable:

Complies with BIFMA HCF 8.1 guidelines

Important to rinse repeatedly with cool, clean water after cleaning to remove all residue. More cleaning details from raw material suppliers available upon request

All surfaces with the exception of some fabrics can be cleaned with Clorox Healthcare Bleach Germicidal Wipes as well as bleach free wipes. This includes all coated fabric, laminate, acrylic and metal surfaces.

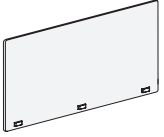
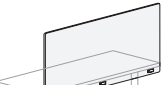
Description	D	W	H	CTN WT	CU FT	① Model	List Price
 	¼	71½	27½	23	3	GP7228LU-ACR	\$1,039
	¼	65½	27½	21	3	GP6628LU-ACR	\$983
	¼	59½	27½	19	3	GP6028LU-ACR	\$879
	¼	53½	27½	18	3	GP5428LU-ACR	\$861
	¼	47½	27½	16	2	GP4828LU-ACR	\$773
	¼	41½	27½	14	2	GP4228LU-ACR	\$724
	¼	35½	27½	13	2	GP3628LU-ACR	\$645
	¼	29½	27½	11	2	GP3028LU-ACR	\$596
	¼	23½	27½	10	1	GP2428LU-ACR	\$530

Features:

- bracket attaches to bottom of worksurface with wood screws
- minimum worksurface overhang clearance for bracket: 1"
- height above worksurface: 24"
- wire pass-through
- bracket visible on approach side only
- corners: ¾" radius
- see cleaning guidelines for cleaning information

To Order, Specify:

- ① Model Number
- ② Material:
 - a. acrylic - frosted or clear
 - b. metal - matte black or arctic silver

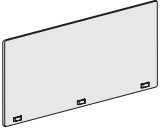
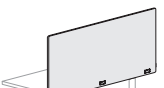
Description	D	W	H	CTN WT	CU FT	① Model	List Price
 	½	71½	27½	10	4	GP7228LU-PET	\$1,005
	½	65½	27½	10	3	GP6628LU-PET	\$989
	½	59½	27½	9	3	GP6028LU-PET	\$956
	½	53½	27½	9	3	GP5428LU-PET	\$931
	½	47½	27½	8	3	GP4828LU-PET	\$628
	½	41½	27½	7	2	GP4228LU-PET	\$618
	½	35½	27½	7	2	GP3628LU-PET	\$594
	½	29½	27½	6	2	GP3028LU-PET	\$487
	½	23½	27½	5	2	GP2428LU-PET	\$363



Features:

- bracket attaches to bottom of worksurface with wood screws
- minimum worksurface overhang clearance for bracket: 1"
- height above worksurface: 24"
- wire pass-through
- bracket visible on approach side only
- corners: ¾" radius
- see cleaning guidelines for cleaning information

To Order, Specify:

- ① Model Number
- ② Material:
 - a. PET - ash grey or silver grey
 - b. metal - matte black or arctic silver

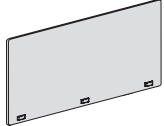
PRIVACY

Description	D	W	H	CTN WT	CU FT	① Model	List Price
 <p>one side: acoustic PET</p>  <p>opposite side: magnetic markerboard</p>	1/2	71 5/8	27 5/8	14	4	GP7228LU-PETMB1	\$2,206
	1/2	65 5/8	27 5/8	13	3	GP6628LU-PETMB1	\$2,201
	1/2	59 5/8	27 5/8	12	3	GP6028LU-PETMB1	\$2,196
	1/2	53 5/8	27 5/8	11	3	GP5428LU-PETMB1	\$1,264
	1/2	47 5/8	27 5/8	10	3	GP4828LU-PETMB1	\$909
	1/2	41 5/8	27 5/8	9	2	GP4228LU-PETMB1	\$906
	1/2	35 5/8	27 5/8	8	2	GP3628LU-PETMB1	\$903
	1/2	29 5/8	27 5/8	8	2	GP3028LU-PETMB1	\$901
	1/2	23 5/8	27 5/8	7	2	GP2428LU-PETMB1	\$589

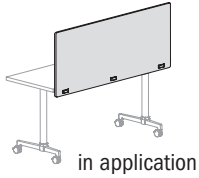

Features:

- bracket attaches to bottom of worksurface with wood screws
- minimum worksurface overhang clearance for bracket: 1"
- one side acoustic PET, opposite side magnetic markerboard
- PET is silver grey
- height above worksurface: 24"
- wire pass-through
- bracket visible on approach side only
- corners: 3/4" radius
- see cleaning guidelines for cleaning information

To Order, Specify:

- ① Model Number
- ② Metal Finish: matte black or arctic silver

Description	D	W	H	CTN WT	CU FT	① Model	List Price
Dual Magnetic Markerboard	1/2	71%	27%	17	4	GP7228LU-PETMB2	\$3,423
Privacy Screen	1/2	65%	27%	16	3	GP6628LU-PETMB2	\$3,419
	1/2	59%	27%	15	3	GP6028LU-PETMB2	\$3,415
	1/2	53%	27%	14	3	GP5428LU-PETMB2	\$1,876
	1/2	47%	27%	12	3	GP4828LU-PETMB2	\$1,315
	1/2	41%	27%	11	2	GP4228LU-PETMB2	\$1,310
	1/2	35%	27%	10	2	GP3628LU-PETMB2	\$1,308
	1/2	29%	27%	9	2	GP3028LU-PETMB2	\$1,306
	1/2	23%	27%	8	2	GP2428LU-PETMB2	\$791

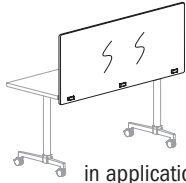
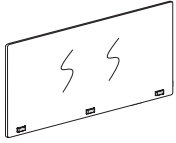

in application

Features:

- bracket attaches to bottom of worksurface with wood screws
- minimum worksurface overhang clearance for bracket: 1"
- exposed edges in PET silver grey
- height above worksurface: 24"
- wire pass-through
- bracket visible on approach side only
- corners: 3/4" radius
- see cleaning guidelines for cleaning information

To Order, Specify:

- ① Model Number
- ② Metal Finish: matte black or arctic silver

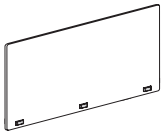
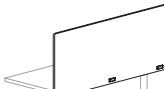
Description	D	W	H	CTN WT	CU FT	① Model	List Price
  in application	¾	71 ½	27 ½	46	4	GP7228LU-TFL	\$538
	¾	65 ½	27 ½	43	4	GP6628LU-TFL	\$523
	¾	59 ½	27 ½	39	3	GP6028LU-TFL	\$509
	¾	53 ½	27 ½	36	3	GP5428LU-TFL	\$493
	¾	47 ½	27 ½	32	3	GP4828LU-TFL	\$434
	¾	41 ½	27 ½	28	3	GP4228LU-TFL	\$417
	¾	35 ½	27 ½	24	2	GP3628LU-TFL	\$401
	¾	29 ½	27 ½	21	2	GP3028LU-TFL	\$388
	¾	23 ½	27 ½	17	2	GP2428LU-TFL	\$371

Features:

- bracket attaches to bottom of worksurface with wood screws
- minimum worksurface overhang clearance for bracket: 1"
- edges are matching PVC
- height above worksurface: 24"
- wire pass-through
- bracket visible on approach side only
- corners: ⅛" radius
- see cleaning guidelines for cleaning information

To Order, Specify:

① Model Number

② Laminate Color

- ③ Metal Finish: matte black
or arctic silver

② Laminate Color

Solid Patterns:

- ALB Alabaster
- BLK Black
- BBL Bridal Blanco
- DWH Designer White
- SHD Shadow
- SLG Slate Grey
- ZEN Zen Grey

Wood Grain Patterns:

- BEL Belair
- BRK Brickdust
- CSK Cask
- CLY Clay
- EGR Egret
- FAW Fawn
- FLN Flint
- FLO Florence Walnut
- LOF Loft
- MES Mesa
- MIN Mineral
- MCH Mocha
- OBK Outback
- PIL Pilsner

- PIN Pinnacle Walnut
- UMB Umber
- VAL Valley
- WLH Walnut Heights
- WEA Weathered Ash

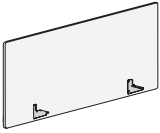
Description	D	W	H	CTN WT	CU FT	① Model	List Price
	¼	71½"	27½"	22	3	GP7224FU-ACR	\$1,186
	¼	65½"	27½"	21	3	GP6624FU-ACR	\$1,118
	¼	59½"	27½"	19	3	GP6024FU-ACR	\$990
	¼	53½"	27½"	18	3	GP5424FU-ACR	\$968
	¼	47½"	27½"	16	2	GP4824FU-ACR	\$884
	¼	41½"	27½"	14	2	GP4224FU-ACR	\$828
	¼	35½"	27½"	13	2	GP3624FU-ACR	\$735
	¼	29½"	27½"	11	2	GP3024FU-ACR	\$658
	¼	23½"	27½"	10	1	GP2424FU-ACR	\$581

Features:

- bracket attaches to bottom of worksurface with wood screws
- minimum worksurface overhang clearance for bracket: 3 ½"
- height above worksurface: 24"
- wire pass-through
- corners: ¾" radius
- see cleaning guidelines for cleaning information
- exposed bolts on approach side

To Order, Specify:

- ① Model Number
- ② Acrylic Options: frosted or clear

PRIVACY

Description	D	W	H	CTN WT	CU FT	① Model	List Price
Acoustic PET/Magnetic Markerboard Privacy Screen	1/2	71 5/8	27 5/8	14	5	GP7224FU-PETMB1	\$2,122
	1/2	65 5/8	27 5/8	13	5	GP6624FU-PETMB1	\$2,118
	1/2	59 5/8	27 5/8	12	4	GP6024FU-PETMB1	\$2,116
	1/2	53 5/8	27 5/8	11	4	GP5424FU-PETMB1	\$1,182
	1/2	47 5/8	27 5/8	10	3	GP4824FU-PETMB1	\$874
	1/2	41 5/8	27 5/8	9	3	GP4224FU-PETMB1	\$872
	1/2	35 5/8	27 5/8	9	3	GP3624FU-PETMB1	\$868
	1/2	29 5/8	27 5/8	8	2	GP3024FU-PETMB1	\$866
	1/2	23 5/8	27 5/8	7	2	GP2424FU-PETMB1	\$556

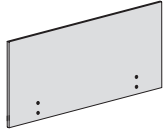
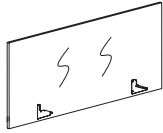

Features:

- bracket attaches to bottom of worksurface with wood screws
- minimum worksurface overhang clearance for bracket: 3 1/8"
- one side acoustic PET, opposite side magnetic markerboard
- PET is silver grey
- height above worksurface: 24"
- wire pass-through
- corners: square
- see cleaning guidelines for cleaning information
- exposed bolts on approach side

To Order, Specify:

- ① Model Number

PRIVACY

Description	D	W	H	CTN WT	CU FT	① Model	List Price
Dual Magnetic Markerboard	½	71%	27%	17	5	GP7224FU-PETMB2	\$3,340
Privacy Screen	½	65%	27%	16	5	GP6624FU-PETMB2	\$3,337
	½	59%	27%	15	4	GP6024FU-PETMB2	\$3,333
	½	53%	27%	14	4	GP5424FU-PETMB2	\$1,793
	½	47%	27%	13	3	GP4824FU-PETMB2	\$1,280
	½	41%	27%	11	3	GP4224FU-PETMB2	\$1,277
	½	35%	27%	10	3	GP3624FU-PETMB2	\$1,275
	½	29%	27%	9	2	GP3024FU-PETMB2	\$1,270
	½	23%	27%	8	2	GP2424FU-PETMB2	\$755

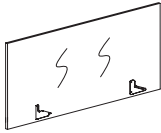

Features:

- bracket attaches to bottom of worksurface with wood screws
- minimum worksurface overhang clearance for bracket: 3 ½"
- exposed edges in PET silver grey
- height above worksurface: 24"
- wire pass-through
- corners: square
- see cleaning guidelines for cleaning information
- exposed bolts on approach side

To Order, Specify:

- ① Model Number

PRIVACY

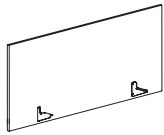
Description	D	W	H	CTN WT	CU FT	① Model	List Price
TFL Privacy Screen 	¾	71 ½	27 ½	46	5	GP7224FU-TFL	\$454
	¾	65 ½	27 ½	43	5	GP6624FU-TFL	\$441
	¾	59 ½	27 ½	39	4	GP6024FU-TFL	\$427
	¾	53 ½	27 ½	35	4	GP5424FU-TFL	\$411
	¾	47 ½	27 ½	32	4	GP4824FU-TFL	\$399
	¾	41 ½	27 ½	28	3	GP4224FU-TFL	\$381
	¾	35 ½	27 ½	25	3	GP3624FU-TFL	\$367
	¾	29 ½	27 ½	21	3	GP3024FU-TFL	\$353
	¾	23 ½	27 ½	18	2	GP2424FU-TFL	\$335

Features:

- bracket attaches to bottom of worksurface with wood screws
- minimum worksurface overhang clearance for bracket: 3 ½"
- edges are matching PVC
- height above worksurface: 24"
- wire pass-through
- corners: square
- see cleaning guidelines for cleaning information
- exposed bolts on approach side

To Order, Specify:

- ① Model Number
- ② Laminate Color

② Laminate Color

Solid Patterns:		Wood Grain Patterns:					
ALB	Alabaster	BEL	Belair	FLO	Florence Walnut	PIN	Pinnacle Walnut
BLK	Black	BRK	Brickdust	LOF	Loft	UMB	Umber
BBL	Bridal Blanco	CSK	Cask	MES	Mesa	VAL	Valley
DWH	Designer White	CLY	Clay	MIN	Mineral	WLH	Walnut Heights
SHD	Shadow	EGR	Egret	MCH	Mocha	WEA	Weathered Ash
SLG	Slate Grey	FAW	Fawn	OBK	Outback		
ZEN	Zen Grey	FLN	Flint	PIL	Pilsner		

PRIVACY

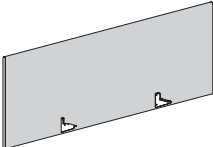
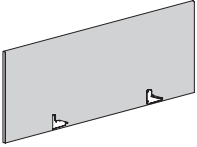
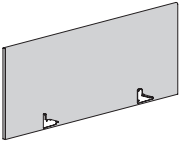
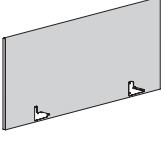
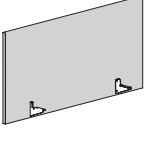
Description	D	W	H	CTN WT	CU FT	① Model	List Price Per Grade	
Fabric Privacy Screen 	1 1/8	72	27 5/8	52	8	GP7228FU-EMTK	COM \$1,593	
	Features:							A \$1,784
	· bracket attaches to bottom of worksurface with wood screws							B \$1,823
	· minimum worksurface overhang clearance for bracket: 3 1/8"							C \$1,937
	· height above worksurface: 24"							D \$2,096
	· wire pass-through							E \$2,242
	· corners: square							F \$2,406
	· see cleaning guidelines for cleaning information							G \$2,602
	· com ydg: 4 1/2							H \$2,893
								I \$2,983
								J \$3,233
	Fabric Privacy Screen 	1 1/8	66	27 5/8	48	8	GP6628FU-EMTK	COM \$1,559
Features:							A \$1,739	
· bracket attaches to bottom of worksurface with wood screws							B \$1,777	
· minimum worksurface overhang clearance for bracket: 3 1/8"							C \$1,883	
· height above worksurface: 24"							D \$2,034	
· wire pass-through							E \$2,172	
· corners: square							F \$2,327	
· see cleaning guidelines for cleaning information							G \$2,512	
· com ydg: 4 1/4							H \$2,787	
							I \$2,873	
							J \$3,109	
Fabric Privacy Screen 		1 1/8	60	27 5/8	44	7	GP6028FU-EMTK	COM \$1,524
	Features:							A \$1,694
	· bracket attaches to bottom of worksurface with wood screws							B \$1,729
	· minimum worksurface overhang clearance for bracket: 3 1/8"							C \$1,829
	· height above worksurface: 24"							D \$1,971
	· wire pass-through							E \$2,101
	· corners: square							F \$2,247
	· see cleaning guidelines for cleaning information							G \$2,421
	· com ydg: 4							H \$2,680
								I \$2,762
								J \$2,985
	Fabric Privacy Screen 	1 7/8	54	27 5/8	40	6	GP5428FU-EMTK	COM \$1,488
Features:							A \$1,636	
· bracket attaches to bottom of worksurface with wood screws							B \$1,667	
· minimum worksurface overhang clearance for bracket: 3 1/8"							C \$1,755	
· height above worksurface: 24"							D \$1,879	
· wire pass-through							E \$1,992	
· corners: square							F \$2,120	
· see cleaning guidelines for cleaning information							G \$2,272	
· com ydg: 3 1/2							H \$2,501	
							I \$2,574	
							J \$2,770	
Fabric Privacy Screen 		1 1/8	48	27 5/8	36	6	GP4828FU-EMTK	COM \$1,260
	Features:							A \$1,398
	· bracket attaches to bottom of worksurface with wood screws							B \$1,427
	· minimum worksurface overhang clearance for bracket: 3 1/8"							C \$1,508
	· height above worksurface: 24"							D \$1,623
	· wire pass-through							E \$1,729
	· corners: square							F \$1,847
	· see cleaning guidelines for cleaning information							G \$1,989
	· com ydg: 3 1/4							H \$2,200
								I \$2,266
								J \$2,448

PRIVACY

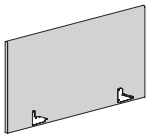
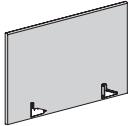
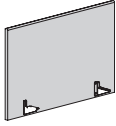
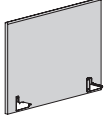
Description	D	W	H	CTN WT	CU FT	① Model	List Price Per Grade	
Fabric Privacy Screen 	1 1/8	42	27 3/8	32	5	GP4228FU-EMTK	COM \$1,225	
	Features:							A \$1,353
	<ul style="list-style-type: none"> • bracket attaches to bottom of worksurface with wood screws • minimum worksurface overhang clearance for bracket: 3 1/8" • height above worksurface: 24" • wire pass-through • corners: square • see cleaning guidelines for cleaning information • com ydg: 3 							B \$1,379
								C \$1,454
								D \$1,560
								E \$1,658
								F \$1,767
								G \$1,898
								H \$2,093
								I \$2,155
							J \$2,323	
Fabric Privacy Screen 	1 1/8	36	27 3/8	28	4	GP3628FU-EMTK	COM \$1,192	
	Features:							A \$1,298
	<ul style="list-style-type: none"> • bracket attaches to bottom of worksurface with wood screws • minimum worksurface overhang clearance for bracket: 3 1/8" • height above worksurface: 24" • wire pass-through • corners: square • see cleaning guidelines for cleaning information • com ydg: 2 1/2 							B \$1,320
								C \$1,383
								D \$1,472
								E \$1,553
								F \$1,644
								G \$1,753
								H \$1,917
								I \$1,970
							J \$2,111	
Fabric Privacy Screen 	1 1/8	30	27 3/8	24	4	GP3028FU-EMTK	COM \$1,097	
	Features:							A \$1,193
	<ul style="list-style-type: none"> • bracket attaches to bottom of worksurface with wood screws • minimum worksurface overhang clearance for bracket: 3 1/8" • height above worksurface: 24" • wire pass-through • corners: square • see cleaning guidelines for cleaning information • com ydg: 2 1/4 							B \$1,213
								C \$1,269
								D \$1,349
								E \$1,422
								F \$1,504
								G \$1,602
								H \$1,750
								I \$1,798
							J \$1,925	
Fabric Privacy Screen 	1 1/8	24	27 3/8	20	3	GP2428FU-EMTK	COM \$999	
	Features:							A \$1,084
	<ul style="list-style-type: none"> • bracket attaches to bottom of worksurface with wood screws • minimum worksurface overhang clearance for bracket: 3 1/8" • height above worksurface: 24" • wire pass-through • corners: square • see cleaning guidelines for cleaning information • com ydg: 2 							B \$1,101
								C \$1,151
								D \$1,222
								E \$1,287
								F \$1,360
								G \$1,447
								H \$1,579
								I \$1,622
							J \$1,735	

To Order, Specify:

① Model Number

② Fabric Selection - vendor, pattern and color

Visit www.jsifurniture.com/finishes-and-materials/textiles for our textiles program.

See selection of standard and graded in manufacturers and patterns.

PRIVACY

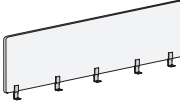
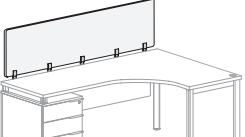
Description	D	W	H	CTN WT	CU FT	① Model	List Price
  in application	¼	71 ¼	23 ⅝	20	4	GP7224SS-ACR	\$1,197
	¼	65 ¼	23 ⅝	19	4	GP6624SS-ACR	\$1,171
	¼	59 ¼	23 ⅝	17	3	GP6024SS-ACR	\$1,051
	¼	53 ¼	23 ⅝	16	3	GP5424SS-ACR	\$999
	¼	47 ¼	23 ⅝	14	3	GP4824SS-ACR	\$872
	¼	41 ¼	23 ⅝	13	3	GP4224SS-ACR	\$831
	¼	35 ¼	23 ⅝	11	2	GP3624SS-ACR	\$713
	¼	29 ¼	23 ⅝	10	2	GP3024SS-ACR	\$607
	¼	23 ¼	23 ⅝	9	2	GP2424SS-ACR	\$558

Features:

- bracket attaches to top side of worksurface with wood screws
- height above worksurface: 24"
- corners: ¾" radius
- see cleaning guidelines for cleaning information

To Order, Specify:

- ① Model Number
- ② Acrylic Options: frosted or clear

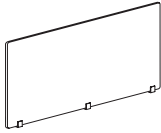
Description	D	W	H	CTN WT	CU FT	① Model	List Price
Acrylic Privacy Screen 	¼	71 ¼	23 ⅝	20	4	GP7224VS-ACR	\$1,206
	¼	65 ¼	23 ⅝	19	4	GP6624VS-ACR	\$1,179
	¼	59 ¼	23 ⅝	17	3	GP6024VS-ACR	\$1,062
	¼	53 ¼	23 ⅝	16	3	GP5424VS-ACR	\$1,011
	¼	47 ¼	23 ⅝	14	3	GP4824VS-ACR	\$887
	¼	41 ¼	23 ⅝	13	3	GP4224VS-ACR	\$833
	¼	35 ¼	23 ⅝	11	2	GP3624VS-ACR	\$717
	¼	29 ½	23 ⅝	10	2	GP3024VS-ACR	\$617
	¼	23 ½	23 ⅝	9	2	GP2424VS-ACR	\$567

Features:

- bracket attaches to top side of worksurface with wood screws
- height above worksurface: 24"
- corners: ¾" radius
- see cleaning guidelines for cleaning information

To Order, Specify:

- ① Model Number
- ② Acrylic Options: frosted or clear

Description	D	W	H	CTN WT	CU FT	① Model	TFL Block	Essentials Block	Artisan Block
Freestanding Above Surface	¼	47¾	23¾	14	4	GPT4824DTS-ACR	\$749		
Acrylic Privacy Screen with Support Block	¼	47¾	23¾	14	4	GPV4824DTS-ACR		\$887	\$901

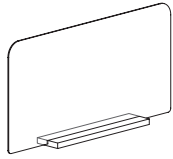

Features:

- sits on top of worksurface
- height above worksurface: 24"
- corners: ¾" radius
- see cleaning guidelines for cleaning information
- stability block dimensions: 1 ½"h x 27"w x 6"d
- ships flat

Options:

- GPT4824DTS-ACR - specify JSI standard laminate
- GPV4824DTS-ACR - specify Essentials or Artisan Veneer and Finish

To Order, Specify:

- ① Model Number
- ② Laminate Color

② Laminate Color

Solid Patterns:	Wood Grain Patterns:		
ALB Alabaster	BEL Belair	FLO Florence Walnut	PIN Pinnacle Walnut
BLK Black	BRK Brickdust	LOF Loft	UMB Umber
BBL Bridal Blanco	CSK Cask	MES Mesa	VAL Valley
DWH Designer White	CLY Clay	MIN Mineral	WLH Walnut Heights
SHD Shadow	EGR Egret	MCH Mocha	WEA Weathered Ash
SLG Slate Grey	FAW Fawn	OBK Outback	
ZEN Zen Grey	FLN Flint	PIL Pilsner	

To Order, Specify:

- ① Model Number
- ② Wood Finish

② Wood Finish

Essentials:	LOF Loft	SIE Sienna
BRK Brickdust	MES Mesa	TRF Truffle
CSK Cask	MIN Mineral	UMB Umber
CLY Clay	MCH Mocha	VAL Valley
FAW Fawn	OBK Outback	
FLX Flax	PIL Pilsner	
FLN Flint		
Artisan:	RYE Rye	
BAR Barrel	SAB Sable	
BUF Buff	SAD Saddle	
CND Cinder		
EGR Egret		
RAV Raven		

PRIVACY

Description	D	W	H	CTN WT	CU FT	① Model	List Price
Straight Acrylic Add On Screen Kit	¼	89 ¼	15 ½	19	5	GPS1690-ACR	\$1,170

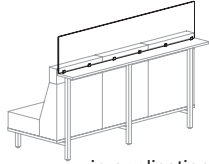
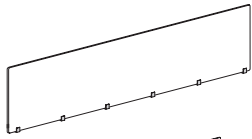

in application

Features:

- bracket attaches to top side of worksurface with hardware and screws
- height above worksurface: 16"
- corners ¾" radius
- see cleaning guidelines for cleaning information
- brackets are satin nickel
- 6 brackets included
- used with: CTL3306, CTL3304

To Order, Specify:

- ① Model Number
- ② Acrylic Options: frosted or clear

Description	D	W	H	CTN WT	CU FT	① Model	List Price
Straight Acrylic Add On Screen Kit	¼	69¼	15½	15	4	GPS1670-ACR	\$939

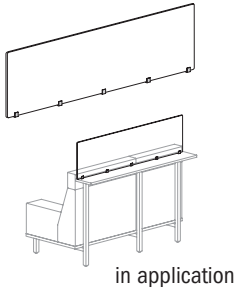

Features:

- bracket attaches to top side of worksurface with hardware and screws
- height above worksurface: 16"
- corners ¾" radius
- see cleaning guidelines for cleaning information
- brackets are satin nickel
- 5 brackets included
- used with: CTL2306WR, CTL2306WL, CTL2306UR, CTL2306UL, CTL2304WR, CTL2304WL, CTL2304UR, CTL2304UL

To Order, Specify:

- ① Model Number
- ② Acrylic Options: frosted or clear

Straight Acrylic Add On Screen Kit	¼	59¼	15½	14	3	GPS1660-ACR	\$806
---	---	-----	-----	----	---	--------------------	--------------

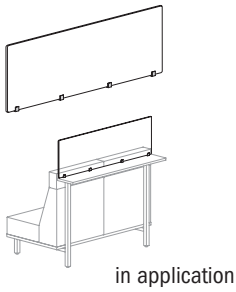

Features:

- bracket attaches to top side of worksurface with hardware and screws
- height above worksurface: 16"
- corners ¾" radius
- see cleaning guidelines for cleaning information
- brackets are satin nickel
- 4 brackets included
- used with: CTL2306, CTL2304

To Order, Specify:

- ① Model Number
- ② Acrylic Options: frosted or clear

Description	D	W	H	CTN WT	CU FT	① Model	List Price
Straight Acrylic Add On Screen Kit	¼	39 ¼	15 ½	10	3	GPS1640-ACR	\$578

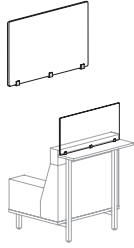

in application

Features:

- bracket attaches to top side of worksurface with hardware and screws
- height above worksurface: 16"
- corners ¾" radius
- see cleaning guidelines for cleaning information
- brackets are satin nickel
- 3 brackets included
- used with: CTL1306WR, CTL1306WL, CTL1306UR, CTL1306UL, CTL1304WR, CTL1304WL, CTL1304UR, CTL1304UL

To Order, Specify:

- ① Model Number
- ② Acrylic Options: frosted or clear

Straight Acrylic Add On Screen Kit	¼	29 ¼	15 ½	8	2	GPS1630-ACR	\$444
---	---	------	------	---	---	--------------------	--------------

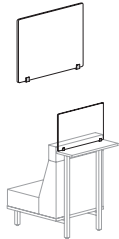

in application

Features:

- bracket attaches to top side of worksurface with hardware and screws
- height above worksurface: 16"
- corners ¾" radius
- see cleaning guidelines for cleaning information
- brackets are satin nickel
- 2 brackets included
- used with: CTL1306, CTL1304

To Order, Specify:

- ① Model Number
- ② Acrylic Options: frosted or clear

Corner Acrylic Add On Screen Kit	¼	31 ½	15 ½	14	3	GPC1632-ACR	\$890
---	---	------	------	----	---	--------------------	--------------

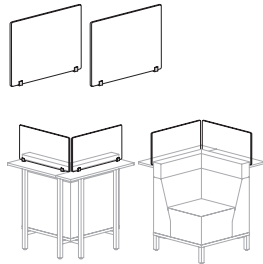

in application

Features:

- bracket attaches to top side of worksurface with hardware and screws
- height above worksurface: 16"
- corners ¾" radius
- see cleaning guidelines for cleaning information
- brackets are satin nickel
- 4 brackets included- 2 per panel
- used with: CTC20T6W, CTC20T6UR, CTC20T6UL, CTC20T6UC, CTC20T4W, CTC20T4UR, CTC20T4UL, CTC20T4UC, CTC20S6UR, CTC20S6UL, CTC20S6UC, CTC20S4UR, CTC20S4UL, CTC20S4UC

To Order, Specify:

- ① Model Number
- ② Acrylic Options: frosted or clear

Description	D	W	H	CTN WT	CU FT	❶ Model	List Price
Radius Acrylic Add On Screen Kit	¼	69	15½	16	4	GPR1669-ACR	\$939

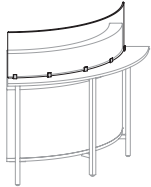
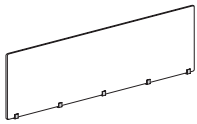

in application

Features:

- bracket attaches to top side of worksurface with hardware and screws
- height above worksurface: 16"
- corners ¾" radius
- see cleaning guidelines for cleaning information
- brackets are satin nickel
- 5 brackets included
- ships flat
- used with: CTI32126, CTI32124

To Order, Specify:

- ❶ Model Number
- ❷ Acrylic Options: frosted or clear

Radius Acrylic Add On Screen Kit	¼	60¼	15½	14	4	GPR1661-ACR	\$821
----------------------------------	---	-----	-----	----	---	-------------	-------

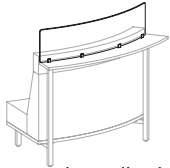
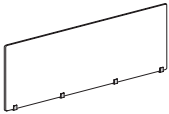

in application

Features:

- bracket attaches to top side of worksurface with hardware and screws
- height above worksurface: 16"
- corners ¾" radius
- see cleaning guidelines for cleaning information
- brackets are satin nickel
- 4 brackets included
- ships flat
- used with: CTI32456, CTI32454

To Order, Specify:

- ❶ Model Number
- ❷ Acrylic Options: frosted or clear

Description	D	W	H	CTN WT	CU FT	❶ Model	List Price
Radius Acrylic Add On Screen Kit	¼	48 ¼	15 ½	11	3	GPR1649-ACR	\$704

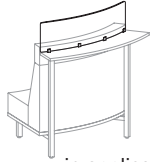
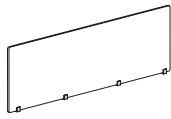

in application

Features:

- bracket attaches to top side of worksurface with hardware and screws
- height above worksurface: 16"
- corners ¾" radius
- see cleaning guidelines for cleaning information
- brackets are satin nickel
- 4 brackets included
- ships flat
- used with: CTI32306, CTI32304

To Order, Specify:

- ❶ Model Number
- ❷ Acrylic Options: frosted or clear

Description	D	W	H	CTN WT	CU FT	① Model	List Price
Acoustic PET Portable Slide on Privacy Screen	1	28	29½	14	3	GP2830SL-PET	\$1,111
	1	24	21½	10	2	GP2422SL-PET	\$843

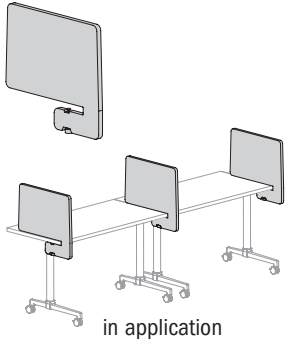

Features:

- slide on to edge of 1" - 1½" worksurface
- hard knob clamps to surface
- minimum worksurface overhang clearance for bracket: 7½"
- height above worksurface: 16" for GP2422SL-PET and 24" for GP2830SL-PET
- see cleaning guidelines for cleaning information

To Order, Specify:

- ① Model Number
- ② PET Color: ash grey or silver grey

Markerboard Portable Slide on Privacy Screen	1 ¼	28	29½	26	3	GP2830SL-PMB	\$969
--	-----	----	-----	----	---	--------------	-------

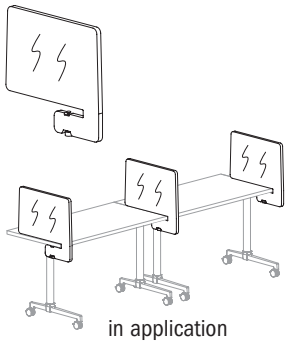

Features:

- slide on to edge of 1" - 1½" worksurface
- hard knob clamps to surface
- minimum worksurface overhang clearance for bracket: 7½"
- height above worksurface: 24"
- plywood core
- edges are white PVC

To Order, Specify:

- ① Model Number

PRIVACY

Description	D	W	H	CTN WT	CU FT	① Model	List Price
HPL Laminate Portable Slide on Privacy Screen	1 1/6	28	29 1/2	26	3	GP2830SL-PHPL	\$1,021

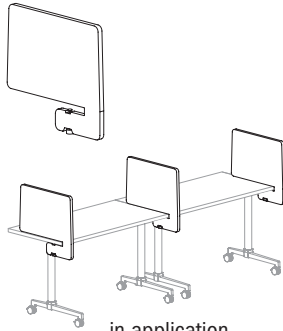

in application

Features:

- slide on to edge of 1" - 1 1/2" worksurface
- hard knob clamps to surface
- minimum worksurface overhang clearance for bracket: 7 1/2"
- height above worksurface: 24"
- plywood core
- edges are matching PVC

To Order, Specify:
① Model Number
② Laminate Color
② Laminate Color
Solid Patterns:

ALB Alabaster
 BLK Black
 BBL Bridal Blanco
 DWH Designer White
 SHD Shadow
 SLG Slate Grey
 ZEN Zen Grey

Wood Grain Patterns:

BEL Belair
 BRK Brickdust
 CSK Cask
 CLY Clay
 EGR Egret
 FAW Fawn
 FLN Flint
 FLO Florence Walnut
 LOF Loft
 MES Mesa
 MIN Mineral
 MCH Mocha
 OBK Outback
 PIL Pilsner

PIN Pinnacle Walnut
 UMB Umber
 VAL Valley
 WLH Walnut Heights
 WEA Weathered Ash

Dual Magnetic Markerboard	1	28	29 1/2	14	3	GP2830SL-PETMB	\$1,638
Portable Slide on Privacy Screen	1	24	21 1/2	10	2	GP2422SL-PETMB	\$1,111

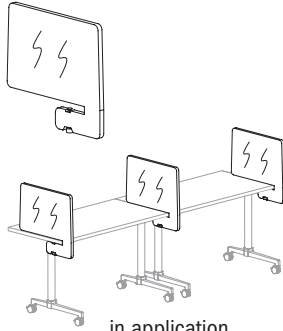

in application

Features:

- slide on to edge of 1" - 1 1/2" worksurface
- hard knob clamps to surface
- minimum worksurface overhang clearance for bracket: 7 1/2"
- height above worksurface: 24"
- exposed edges in PET silver grey
- see cleaning guidelines for cleaning information

To Order, Specify:
① Model Number

Poufy - Freestanding Upholstered Screens

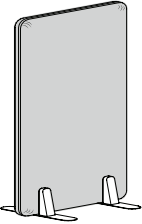
Description	D	W	H	CTN WT	CU FT	① Model	List Price Per Grade
60" Single - Poufy Freestanding Upholstered Screen	27 1/8	48	60	73	9	INF4860-1SUP	COM \$1,910
	Features: <ul style="list-style-type: none"> two metal bases with solid maple supports maple solid wood supports standard walnut or white oak solid wood supports available, specify and add \$199 list heavy cushioned surface not recommended for tacking upholstery can only be cut up the roll for 60" freestanding screens com ydg: 6 3/4 see cleaning guidelines for cleaning information Options: <ul style="list-style-type: none"> specify upholstery specify wood species and finish specify metal finish 						A \$1,966 B \$2,076 C \$2,268 D \$2,515 E \$2,725 F \$3,093 G \$3,487 H \$3,824 I \$4,427 J \$5,141

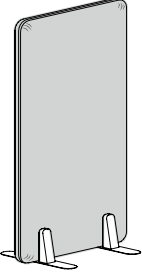
60" Single - Poufy Freestanding Upholstered Screen	2 1/8	36	60	60	7	INF3660-1SUP	COM \$1,771
	Features: <ul style="list-style-type: none"> two metal bases with solid maple supports maple solid wood supports standard walnut or white oak solid wood supports available, specify and add \$199 list heavy cushioned surface not recommended for tacking upholstery can only be cut up the roll for 60" freestanding screens com ydg: 5 1/2 see cleaning guidelines for cleaning information Options: <ul style="list-style-type: none"> specify upholstery specify wood species and finish specify metal finish 						A \$1,816 B \$1,906 C \$2,063 D \$2,264 E \$2,435 F \$2,735 G \$3,056 H \$3,330 I \$3,822 J \$4,403

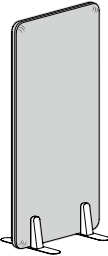
60" Single - Poufy Freestanding Upholstered Screen	2 1/8	30	60	50	6	INF3060-1SUP	COM \$1,562
	Features: <ul style="list-style-type: none"> two metal bases with solid maple supports maple solid wood supports standard walnut or white oak solid wood supports available, specify and add \$199 list heavy cushioned surface not recommended for tacking upholstery can only be cut up the roll for 60" freestanding screens com ydg: 5 see cleaning guidelines for cleaning information Options: <ul style="list-style-type: none"> specify upholstery specify wood species and finish specify metal finish 						A \$1,603 B \$1,685 C \$1,827 D \$2,010 E \$2,166 F \$2,438 G \$2,730 H \$2,980 I \$3,426 J \$3,955

PRIVACY

Poufy - Freestanding Upholstered Screens

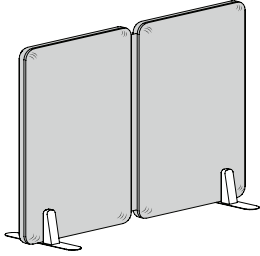
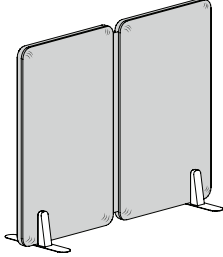
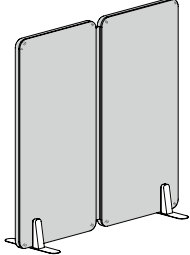
Description	D	W	H	CTN WT	CU FT	① Model	List Price Per Grade
60" h Double - Poufy Freestanding Upholstered Screen 	2 1/8	98	60	134	12	INF4860-2SUP	COM \$2,985 A \$3,069 B \$3,236 C \$3,528 D \$3,903 E \$4,222 F \$4,781 G \$5,379 H \$5,891 I \$6,806 J \$7,890
Features: <ul style="list-style-type: none"> two metal bases with solid maple supports maple solid wood supports standard walnut or white oak solid wood supports available, specify and add \$199 list heavy cushioned surface not recommended for tacking upholstery can only be cut up the roll for 60" h freestanding screens com ydg: 10 1/4 see cleaning guidelines for cleaning information Options: <ul style="list-style-type: none"> specify upholstery specify wood species and finish specify metal finish 							
60" h Double - Poufy Freestanding Upholstered Screen 	2 1/8	74	60	107	10	INF3660-2SUP	COM \$2,782 A \$2,852 B \$2,990 C \$3,232 D \$3,543 E \$3,808 F \$4,271 G \$4,767 H \$5,192 I \$5,951 J \$6,850
Features: <ul style="list-style-type: none"> two metal bases with solid maple supports maple solid wood supports standard walnut or white oak solid wood supports available, specify and add \$199 list heavy cushioned surface not recommended for tacking upholstery can only be cut up the roll for 60" h freestanding screens com ydg: 8 1/2 see cleaning guidelines for cleaning information Options: <ul style="list-style-type: none"> specify upholstery specify wood species and finish specify metal finish 							
60" h Double - Poufy Freestanding Upholstered Screen 	2 1/8	62	60	89	9	INF3060-2SUP	COM \$2,352 A \$2,412 B \$2,530 C \$2,736 D \$3,002 E \$3,227 F \$3,622 G \$4,045 H \$4,407 I \$5,055 J \$5,822
Features: <ul style="list-style-type: none"> two metal bases with solid maple supports maple solid wood supports standard walnut or white oak solid wood supports available, specify and add \$199 list heavy cushioned surface not recommended for tacking upholstery can only be cut up the roll for 60" h freestanding screens com ydg: 7 1/4 see cleaning guidelines for cleaning information Options: <ul style="list-style-type: none"> specify upholstery specify wood species and finish specify metal finish 							

To Order, Specify:

- ① Model Number
- ② Fabric Selection - vendor, pattern and color
 Visit www.jsifurniture.com/finishes-and-materials/textiles for our textiles program.
 See selection of standard and graded in manufacturers and patterns.
- ③ Metal Finish - Aged Bronze (ABZ), Gold (GLD), Matte Black (MBK), Pewter (PEW), Soft Bronze (SBZ), Soft Nickel (SNK), Stardust Silver (STS)

Poufy - Freestanding Upholstered Screens

Description	D	W	H	CTN WT	CU FT	① Model	List Price Per Grade
60" Triple - Poufy Freestanding Upholstered Screen	2 1/8	148	60	199	16	INF4860-3SUP	COM \$4,303 A \$4,418 B \$4,646 C \$5,044 D \$5,557 E \$5,993 F \$6,755 G \$7,572 H \$8,271 I \$9,522 J \$11,003

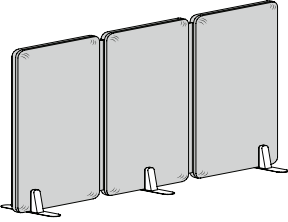

Features:

- two metal bases with solid maple supports
- maple solid wood supports standard
- walnut or white oak solid wood supports available, specify and add \$199 list
- heavy cushioned surface not recommended for tacking
- **upholstery can only be cut up the roll for 60" freestanding screens**
- com ydg: 14
- see cleaning guidelines for cleaning information

Options:

- specify upholstery
- specify wood species and finish
- specify metal finish

60" Triple - Poufy Freestanding Upholstered Screen	2 1/8	112	60	158	13	INF3660-3SUP	COM \$3,528 A \$3,625 B \$3,816 C \$4,150 D \$4,580 E \$4,946 F \$5,586 G \$6,272 H \$6,859 I \$7,908 J \$9,151
--	-------	-----	----	-----	----	--------------	---

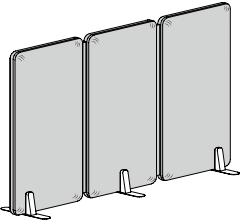

Features:

- two metal bases with solid maple supports
- maple solid wood supports standard
- walnut or white oak solid wood supports available, specify and add \$199 list
- heavy cushioned surface not recommended for tacking
- **upholstery can only be cut up the roll for 60" freestanding screens**
- com ydg: 11 3/4
- see cleaning guidelines for cleaning information

Options:

- specify upholstery
- specify wood species and finish
- specify metal finish

60" Triple - Poufy Freestanding Upholstered Screen	2 1/8	94	60	132	11	INF3060-3SUP	COM \$3,457 A \$3,545 B \$3,720 C \$4,026 D \$4,420 E \$4,755 F \$5,340 G \$5,967 H \$6,504 I \$7,465 J \$8,602
--	-------	----	----	-----	----	--------------	---

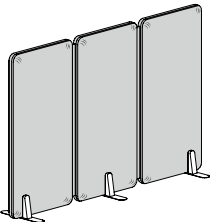

Features:

- two metal bases with solid maple supports
- maple solid wood supports standard
- walnut or white oak solid wood supports available, specify and add \$199 list
- heavy cushioned surface not recommended for tacking
- **upholstery can only be cut up the roll for 60" freestanding screens**
- com ydg: 10 3/4
- see cleaning guidelines for cleaning information

Options:

- specify upholstery
- specify wood species and finish
- specify metal finish

PRIVACY

Poufy - Freestanding Upholstered Screens

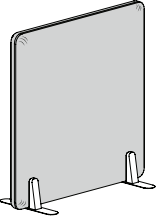
Description	D	W	H	CTN WT	CU FT	① Model	List Price Per Grade
48" Single - Poufy Freestanding Upholstered Screen 	2 1/8	48	48	62	7	INF4848-1SUP	COM \$1,799
							A \$1,847
Features: <ul style="list-style-type: none"> two metal bases with solid maple supports maple solid wood supports standard walnut or white oak solid wood supports available, specify and add \$199 list heavy cushioned surface not recommended for tacking com ydg: 5 3/4 see cleaning guidelines for cleaning information specify upholstery 							B \$1,940
Options: <ul style="list-style-type: none"> specify wood species and finish specify metal finish 							C \$2,104
							D \$2,314
							E \$2,493
							F \$2,806
							G \$3,142
							H \$3,429
							I \$3,943
							J \$4,551

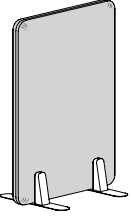
48" Single - Poufy Freestanding Upholstered Screen 	2 1/8	36	48	51	6	INF3648-1SUP	COM \$1,686
							A \$1,725
Features: <ul style="list-style-type: none"> two metal bases with solid maple supports maple solid wood supports standard walnut or white oak solid wood supports available, specify and add \$199 list heavy cushioned surface not recommended for tacking com ydg: 4 3/4 see cleaning guidelines for cleaning information specify upholstery 							B \$1,803
Options: <ul style="list-style-type: none"> specify wood species and finish specify metal finish 							C \$1,938
							D \$2,112
							E \$2,260
							F \$2,518
							G \$2,796
							H \$3,033
							I \$3,457
							J \$3,959

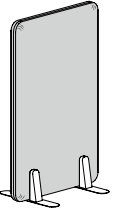
48" Single - Poufy Freestanding Upholstered Screen 	2 1/8	30	48	44	5	INF3048-1SUP	COM \$1,548
							A \$1,585
Features: <ul style="list-style-type: none"> two metal bases with solid maple supports maple solid wood supports standard walnut or white oak solid wood supports available, specify and add \$199 list heavy cushioned surface not recommended for tacking com ydg: 4 1/2 see cleaning guidelines for cleaning information specify upholstery 							B \$1,659
Options: <ul style="list-style-type: none"> specify wood species and finish specify metal finish 							C \$1,787
							D \$1,951
							E \$2,091
							F \$2,337
							G \$2,599
							H \$2,824
							I \$3,226
							J \$3,702

To Order, Specify:

- ① Model Number
- ② Fabric Selection - vendor, pattern and color
Visit www.jsifurniture.com/finishes-and-materials/textiles for our textiles program.
See selection of standard and graded in manufacturers and patterns.
- ③ Metal Finish - Aged Bronze (ABZ), Gold (GLD), Matte Black (MBK), Pewter (PEW), Soft Bronze (SBZ), Soft Nickel (SNK), Stardust Silver (STS)

PRIVACY

Poufy - Freestanding Upholstered Screens

Description	D	W	H	CTN WT	CU FT	① Model	List Price Per Grade
48" h Double - Poufy Freestanding Upholstered Screen	2 1/8	98	48	112	10	INF4848-2SUP	COM \$2,776 A \$2,846 B \$2,984 C \$3,226 D \$3,537 E \$3,802 F \$4,265 G \$4,761 H \$5,186 I \$5,945 J \$6,844

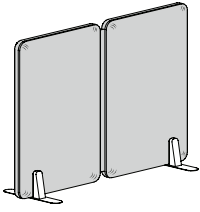

Features:

- two metal bases with solid maple supports
- maple solid wood supports standard
- walnut or white oak solid wood supports available, specify and add \$199 list
- heavy cushioned surface not recommended for tacking
- com ydg: 8 1/2
- see cleaning guidelines for cleaning information
- specify upholstery

Options:

- specify wood species and finish
- specify metal finish

48" h Double - Poufy Freestanding Upholstered Screen	2 1/8	74	48	89	8	INF3648-2SUP	COM \$2,624 A \$2,684 B \$2,802 C \$3,008 D \$3,274 E \$3,499 F \$3,894 G \$4,317 H \$4,679 I \$5,327 J \$6,094
--	-------	----	----	----	---	--------------	---

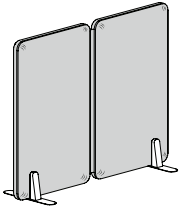

Features:

- two metal bases with solid maple supports
- maple solid wood supports standard
- walnut or white oak solid wood supports available, specify and add \$199 list
- heavy cushioned surface not recommended for tacking
- com ydg: 7 1/4
- see cleaning guidelines for cleaning information
- specify upholstery

Options:

- specify wood species and finish
- specify metal finish

48" h Double - Poufy Freestanding Upholstered Screen	2 1/8	62	48	76	7	INF3048-2SUP	COM \$2,305 A \$2,355 B \$2,452 C \$2,623 D \$2,843 E \$3,029 F \$3,356 G \$3,706 H \$4,006 I \$4,542 J \$5,177
--	-------	----	----	----	---	--------------	---

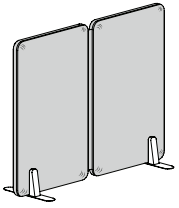

Features:

- two metal bases with solid maple supports
- maple solid wood supports standard
- walnut or white oak solid wood supports available, specify and add \$199 list
- heavy cushioned surface not recommended for tacking
- com ydg: 6 3/4
- see cleaning guidelines for cleaning information
- specify upholstery

Options:

- specify wood species and finish
- specify metal finish

PRIVACY

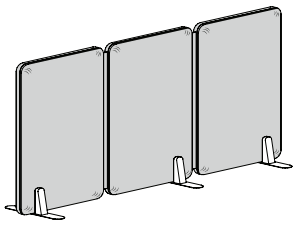
Description	D	W	H	CTN WT	CU FT	① Model	List Price Per Grade
48" Triple - Poufy Freestanding Upholstered Screen 	2 1/8	148	48	166	13	INF4848-3SUP	COM \$3,996
	Features: <ul style="list-style-type: none"> two metal bases with solid maple supports maple solid wood supports standard walnut or white oak solid wood supports available, specify and add \$199 list heavy cushioned surface not recommended for tacking com ydg: 11 1/2 see cleaning guidelines for cleaning information specify upholstery Options: <ul style="list-style-type: none"> specify wood species and finish specify metal finish 						A \$4,091 B \$4,278 C \$4,605 D \$5,026 E \$5,384 F \$6,010 G \$6,682 H \$7,256 I \$8,283 J \$9,500

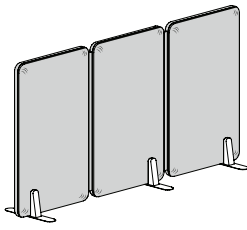
48" Triple - Poufy Freestanding Upholstered Screen 	2 1/8	112	48	131	11	INF3648-3SUP	COM \$3,788
	Features: <ul style="list-style-type: none"> two metal bases with solid maple supports maple solid wood supports standard walnut or white oak solid wood supports available, specify and add \$199 list heavy cushioned surface not recommended for tacking com ydg: 9 3/4 see cleaning guidelines for cleaning information specify upholstery Options: <ul style="list-style-type: none"> specify wood species and finish specify metal finish 						A \$3,868 B \$4,027 C \$4,304 D \$4,661 E \$4,965 F \$5,496 G \$6,065 H \$6,552 I \$7,423 J \$8,454

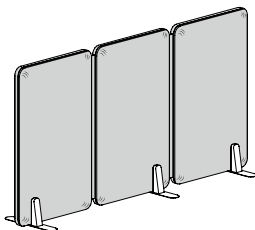
48" Triple - Poufy Freestanding Upholstered Screen 	2 1/8	94	48	112	9	INF3048-3SUP	COM \$3,372
	Features: <ul style="list-style-type: none"> two metal bases with solid maple supports maple solid wood supports standard walnut or white oak solid wood supports available, specify and add \$199 list heavy cushioned surface not recommended for tacking com ydg: 8 3/4 see cleaning guidelines for cleaning information specify upholstery Options: <ul style="list-style-type: none"> specify wood species and finish specify metal finish 						A \$3,444 B \$3,586 C \$3,836 D \$4,156 E \$4,428 F \$4,905 G \$5,416 H \$5,852 I \$6,634 J \$7,560

To Order, Specify:

- ① Model Number
- ② Fabric Selection - vendor, pattern and color
Visit www.jsifurniture.com/finishes-and-materials/textiles for our textiles program.
See selection of standard and graded in manufacturers and patterns.
- ③ Metal Finish - Aged Bronze (ABZ), Gold (GLD), Matte Black (MBK), Pewter (PEW), Soft Bronze (SBZ), Soft Nickel (SNK), Stardust Silver (STS)

PRIVACY

Freestanding Screen Accessories

Description	D	W	H	CTN WT	CU FT	① Model	List Price
Knob - Freestanding Screen Accessory	3 7/8	2 1/2	7	2	1	INA0307F-KNOB	\$252

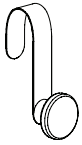

Features:

- supported by a metal hook
- solid maple knob standardmaximum weight rating 10 lbs. (evenly distributed load)

Options:

- solid walnut or white knob available, specify and add \$23 list
- specify wood species and finish
- specify metal finish

Shelves - Freestanding Screen Accessory	6 5/8	24	32	9	4	INA2432F-3SHELF	\$859
	6 5/8	24	20	7	3	INA2420F-2SHELF	\$674
	6 5/8	24	8	5	2	INA2408F-1SHELF	\$479

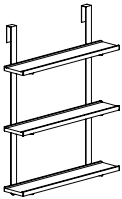

-3SHELF shown

Features:

- supported by two metal hooks
- shelf depth 4 3/4"
- solid maple shelves standardmaximum weight rating 10 lbs. per shelf (evenly distributed load)

Options:

- walnut or white oak shelves available, -3SHELF specify and add \$121 list, -2SHELF specify and add \$82 list or -1SHELF specify and add \$44 list
- specify wood species and finish
- specify metal finish

Planter Shelves - Freestanding Screen Accessory	6 5/8	24	32	9	4	INA2432F-3PLANTER	\$903
	6 5/8	24	20	7	3	INA2420F-2PLANTER	\$704
	6 5/8	24	8	5	2	INA2408F-1PLANTER	\$493

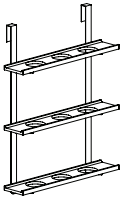

-3PLANTER shown

Features:

- supported by two metal hooks
- planter shelf with 3 1/2" holes for plant containers
- solid maple planter shelves standardmaximum weight rating 10 lbs. per shelf (evenly distributed load)

Options:

- walnut or white oak shelves available, -3PLANTER specify and add \$121 list, -2PLANTER specify and add \$82 list or -1PLANTER specify and add \$44 list
- specify wood species and finish
- specify metal finish

Pouch - Freestanding Screen Accessory	3 3/8	14	20	2	1	INA1111F-POUCH	\$566
---------------------------------------	-------	----	----	---	---	----------------	-------

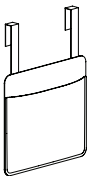

Features:

- supported by two metal hooks
- aniline dye leather
- maximum weight rating 10 lbs. per shelf (evenly distributed load)

Options:

- specify metal finish

Description	D	W	H	CTN WT	CU FT	① Model	List Price
Sconce Lamp - Freestanding Screen Accessory	17 7/8	15	22	9	4	INA1522F-SCONCE	\$836

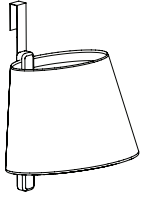

Features:

- supported by a metal hook
- 15' cord
- cord mounted rocker on/off switch - three prong plug fabric power cord
- on/off switch on 32" from light - field assembly required
- maximum 60 watt light bulb, NOT included/LED bulb recommended

Options:

- specify wood species and finish
- specify mode upholstery color for shade
- specify cord color
- specify metal finish

Tray - Poufy and Square Upholstered Wall Mound Tile Accessory	4 3/4	24	1	5	2	INA0524T	\$412
---	-------	----	---	---	---	----------	-------

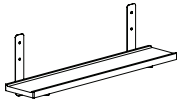

Features:

- for use with square laminate marker, cork and tackable screen accessories
- supported by two metal brackets
- tray can be field installed on any 24" or wider tile except glass marker tiles
- tray can not be installed on intermediate positioned tiles (space is required below tile for clearance)
- maximum weight rating 10 lbs. per shelf (evenly distributed load)

Options:

- walnut or white oak sconce support available, specify and add \$44 list
- specify wood species and finish

To Order, Specify:

- ① Model Number
- ② Metal Finish - Aged Bronze (ABZ), Gold (GLD), Matte Black (MBK), Pewter (PEW), Soft Bronze (SBZ), Soft Nickel (SNK), Stardust Silver (STS)

Specifications

- extruded PVC 1/2" thick panel
- natural cork 1/4" thick tackable face
- extruded aluminum mounting Z clips

PRIVACY

Freestanding Screen Accessories

Description	D	W	H	CTN WT	CU FT	① Model	List Price
Square - Laminate Marker Tile Freestanding Screen Accessory	27 ⁷ / ₈	24	24	17	2	INA2424F-SQM	\$574

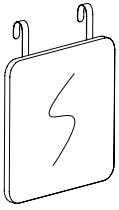

Features:

- supported by two metal hooks
- white markerboard high pressure laminate
- white edge band

Options:

- specify metal finish

Round - Laminate Marker Tile Freestanding Screen Accessory	27 ⁷ / ₈	24	24	17	2	INA24F-RDM	\$566
---	--------------------------------	----	----	----	---	------------	-------

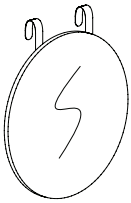

Features:

- supported by two metal hooks
- white markerboard high pressure laminate
- white edge band

Options:

- specify metal finish

Square - Cork Tile Freestanding Screen Accessory	27 ⁷ / ₈	24	24	8	2	INA2424F-SQC	\$538
---	--------------------------------	----	----	---	---	--------------	-------



Features:

- supported by two metal hooks
- extruded PVC 1/2" thick panel
- natural cork 1/4" thick tackable face

Options:

- specify metal finish

Round - Cork Tile Freestanding Screen Accessory	27 ⁷ / ₈	24	24	7	2	INA24F-RDC	\$538
--	--------------------------------	----	----	---	---	------------	-------

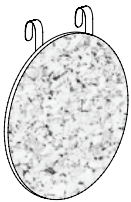

Features:

- supported by two metal hooks
- extruded PVC 1/2" thick panel
- natural cork 1/4" thick tackable face

Options:

- specify metal finish

PRIVACY

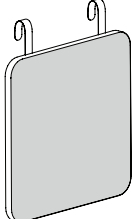
Description	D	W	H	CTN WT	CU FT	① Model	List Price Per Grade	
Square - Tackboard Tile Freestanding Screen Accessory 	27½	24	24	11	2	INA2424F-SQUT	COM \$531	
	Features:							A \$540
	· supported by two metal hooks							B \$556
	· ½" soft tack core face							C \$584
	· ¼" hardwood backer panel							D \$621
	· covered with surface glued and staple upholstery							E \$652
	· com ydg: 1 ½"							F \$707
	Options:							G \$765
	· specify upholstery							H \$815
	· specify metal finish							I \$904
								J \$1,010

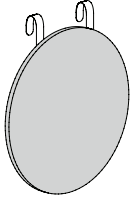
Round - Tackboard Tile Freestanding Screen Accessory 	27½	24	24	11	2	INA24F-RDUT	COM \$532	
	Features:							A \$545
	· supported by two metal hooks							B \$569
	· ½" soft tack core face							C \$612
	· ¼" hardwood backer panel							D \$667
	· covered with surface glued and staple upholstery							E \$713
	· com ydg: 1 ½"							F \$795
	Options:							G \$883
	· specify upholstery							H \$958
	· specify metal finish							I \$1,092
								J \$1,250

To Order, Specify:

- ① Model Number
- ② Fabric Selection - vendor, pattern and color
Visit www.jsifurniture.com/finishes-and-materials/textiles for our textiles program. See selection of standard and graded in manufacturers and patterns.
- ③ Metal Color - Arctic Silver (ASL), Matte Black (MBK), Pewter (PEW) or Soft Nickel (SNK)

Specifications

- two 12mm sandwiched birch plywood panel frames
- ½" polyurethane foam surface cushions on both faces
- living hinge is high density polyethylene with sewn upholstery
- solid hardwood supports
- 12 gauge metal base feet

PRIVACY

Description	D	W	H	CTN WT	CU FT	① Model	List Price
Frosted Acrylic Freestanding Fixed Screen	42	42	64	100	44	CL4242-64PP-ACR	\$4,061

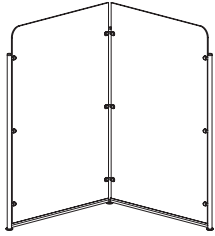

Features:

- slider glides for easy mobility
- ships kd
- frame is arctic silver

To Order, Specify:

- ① Model Number

TFL Freestanding Mobile Screen	¾	48	72	95	16	GP4872MS-TFL	\$1,594
	¾	42	72	86	15	GP4272MS-TFL	\$1,565
	¾	36	72	75	13	GP3672MS-TFL	\$1,535

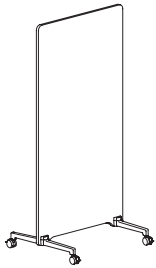

Features:

- overall height: 72"
- base allows for offset nesting
- locking casters
- see cleaning guidelines for cleaning information

To Order, Specify:

- ① Model Number
- ② Laminate Color
- ③ Metal Finish

② Laminate Color

Solid Patterns:

- ALB Alabaster
- BLK Black
- BBL Bridal Blanco
- DWH Designer White
- SHD Shadow
- SLG Slate Grey
- ZEN Zen Grey

Wood Grain Patterns:

- BEL Belair
- BRK Brickdust
- CSK Cask
- CLY Clay
- EGR Egret
- FAW Fawn
- FLN Flint
- FLO Florence Walnut
- LOF Loft
- MES Mesa
- MIN Mineral
- MCH Mocha
- OBK Outback
- PIL Pilsner

- PIN Pinnacle Walnut
- UMB Umber
- VAL Valley
- WLH Walnut Heights
- WEA Weathered Ash

TFL Freestanding Fixed Screen	¾	48	72	95	16	GP4872FS-TFL	\$1,550
	¾	42	72	86	15	GP4272FS-TFL	\$1,518
	¾	36	72	75	13	GP3672FS-TFL	\$1,491

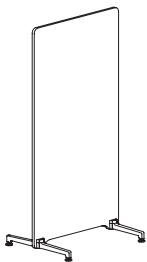

Features:

- overall height: 72"
- base allows for offset nesting
- see cleaning guidelines for cleaning information

To Order, Specify:

- ① Model Number
- ② Laminate Color
- ③ Metal Finish

② Laminate Color

Solid Patterns:

- ALB Alabaster
- BLK Black
- BBL Bridal Blanco
- DWH Designer White
- SHD Shadow
- SLG Slate Grey
- ZEN Zen Grey

Wood Grain Patterns:

- BEL Belair
- BRK Brickdust
- CSK Cask
- CLY Clay
- EGR Egret
- FAW Fawn
- FLN Flint
- FLO Florence Walnut
- LOF Loft
- MES Mesa
- MIN Mineral
- MCH Mocha
- OBK Outback
- PIL Pilsner

- PIN Pinnacle Walnut
- UMB Umber
- VAL Valley
- WLH Walnut Heights
- WEA Weathered Ash

Description	D	W	H	CTN WT	CU FT	① Model	List Price
Freestanding Mobile Screen	24	42	75	162	58	NAB2442-75MMB	\$4,465

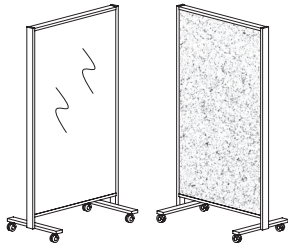

Features:

- four non-locking casters
- base allows for offset nesting

To Order, Specify:

- ① Model Number
- ② Markerboard or Cork Board
- ③ Metal Finish: matte black or arctic silver

Description	D	W	H	CTN WT	CU FT	① Model	List Price Per Grade
Freestanding Mobile Screen - Tackboard One Side	24	42	75	162	58	NAB2442-75MTKD	COM \$4,551

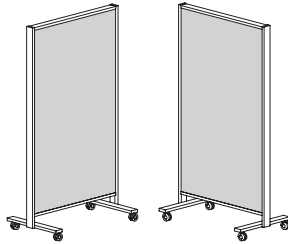

Features:

- four non-locking casters
- base allows for offset nesting

To Order, Specify:

- ① Model Number
- ② Fabric Selection
- ③ Metal Finish: matte black or arctic silver

- A \$4,615
- B \$4,628
- C \$4,666
- D \$4,719
- E \$4,767
- F \$4,822
- G \$4,887
- H \$5,020
- I \$5,083
- J \$5,200

PRIVACY

Privacy Solutions - Cleaning Guidelines

We offer numerous textile and hard surface options that will stand up to the rigors of frequent bleach cleaning, ranging from untreated surfaces to those with anti-microbial topcoats. Please contact our Customer Support Team today for more information.

MATERIALS:

ACRYLIC: water based foam or cleaner and bleach cleanable (5:1)*

ACOUSTIC PET: bleach solution cleanable (2% bleach)*

HPL LAMINATE: recommended by suppliers: Clorox Healthcare Bleach Germicidal wipes, Virex II 256, PDI Super Sani-Cloth wipes, PDI Sani-Prime Germicidal spray

TFL LAMINATE: cleaning guidelines will vary between manufacturer; cleaning details available upon request

VENEER: first clean with warm soapy water - do not soak. Pledge Antibacterial cleaner or bleach free disinfectant wipes are recommended

COATED FABRIC: water based foam or cleaner and bleach cleanable (4:1)*

FABRIC: cleaning guidelines will vary between fabric type, pattern and manufacturer; see material recommendations for bleach-solution cleanable fabrics

*Bleach solution cleanable:

Complies with BIFMA HCF 8.1 guidelines

Important to rinse repeatedly with cool, clean water after cleaning to remove all residue. More cleaning details from raw material suppliers available upon request

All surfaces with the exception of some fabrics can be cleaned with Clorox Healthcare Bleach Germicidal Wipes as well as bleach free wipes. This includes all coated fabric, laminate, acrylic and metal surfaces.

Privacy Solutions Product Information

Screen Mounting

- screens supported by brackets with powder coated cover plates to underside of top
- mounting brackets slide out for routing cables to underside of top or to install monitor arm
- screens available for approach and end of table applications
- screen link kits available (see below) for shared privacy screen application between two tables approach or end applications
- screens must be removed before tilting

Under-Surface Mount LK Style

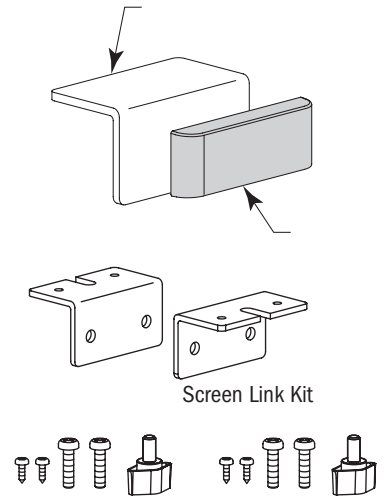
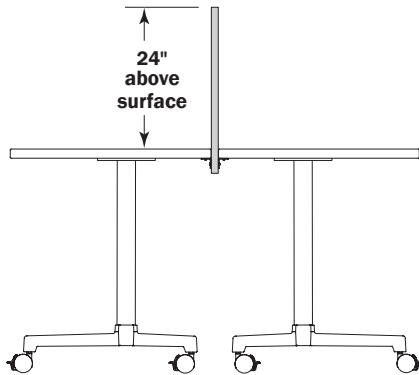
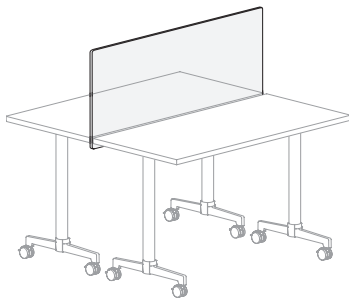
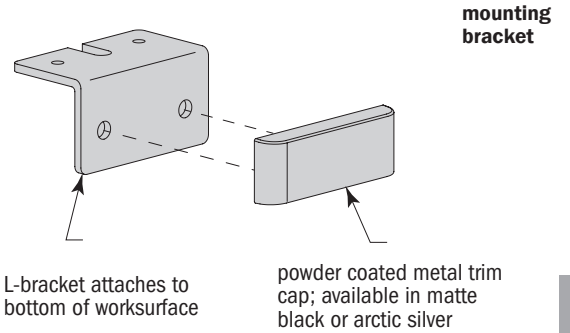
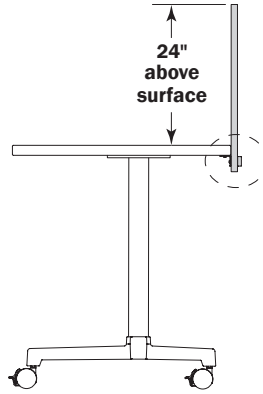
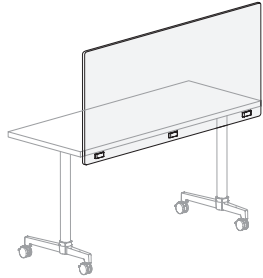

FX Style

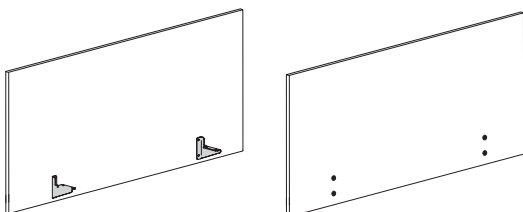
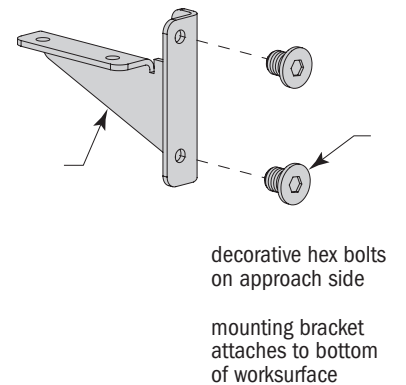
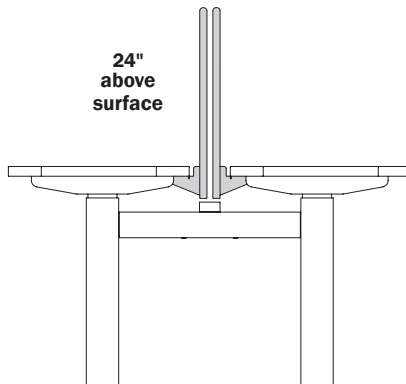
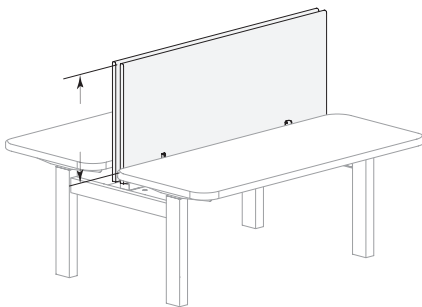

PRIVACY

Privacy Solutions Product Information

Under-Surface Mount

SS Style

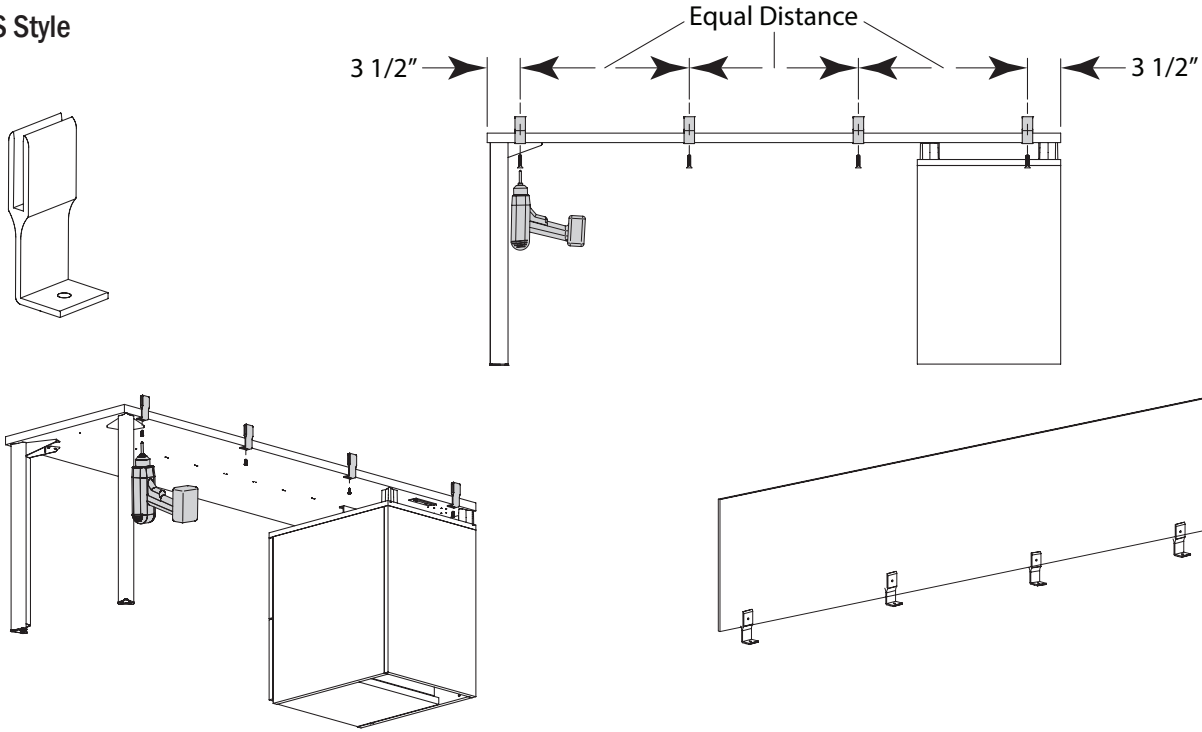

PRIVACY

Above-Surface Mount

VS Style

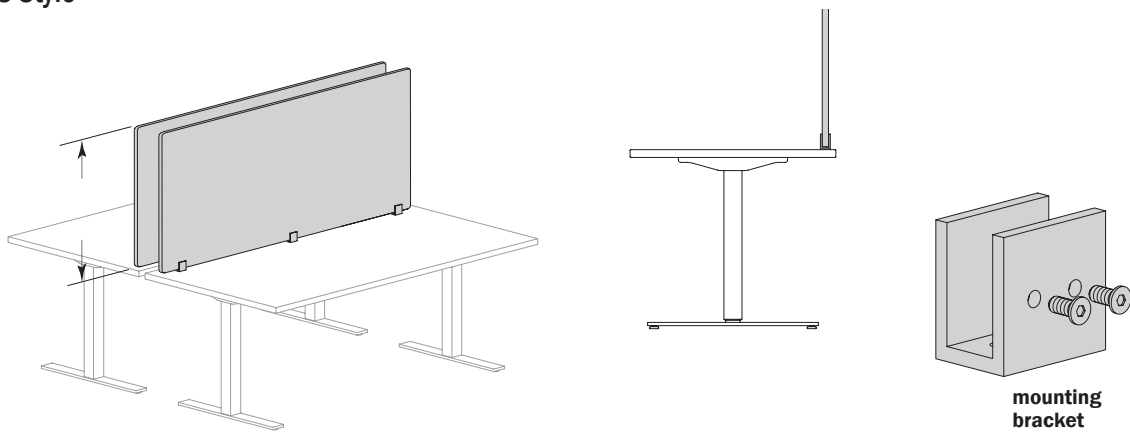

Privacy Solutions Product Information

Above-Surface Mount

Connect Style

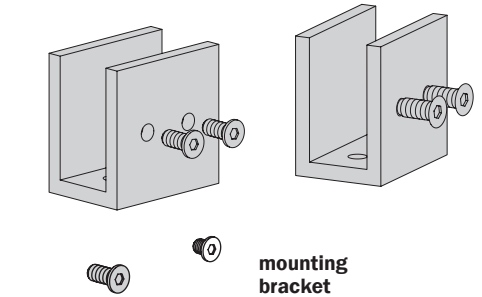
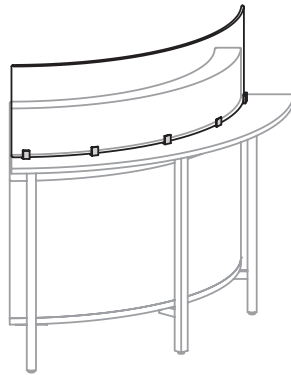
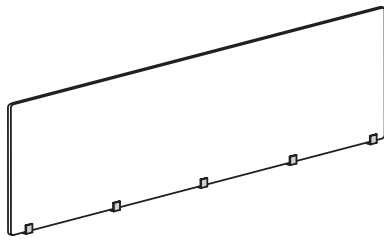
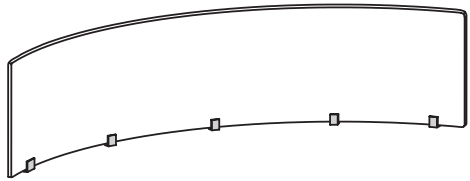

16"
above
surface

Side-Mount

