

# Seating Quickship Product Information

## Guest

### Bourne



**Bourne Guest  
Single Textile**  
[Page SQS5](#)



**Bourne Guest  
Dual Textile**  
[Page SQS5](#)

### Gatsby



**Gatsby Guest  
Fully Upholstered Back**  
[Page SQS9](#)



**Gatsby Guest  
3/4 Upholstered Back**  
[Page SQS9](#)



**Gatsby  
Chair Linking Kit**  
[Page SQS9](#)

### Knox



**Knox Guest  
Armless Stack Chair**  
[Page SQS13](#)



**Knox Guest  
Armless Stack Chair w/Casters**  
[Page SQS14](#)



**Knox Guest  
Flared Arm Stack Chair**  
[Page SQS16](#)



**Knox Guest  
Flared Arm Stack Chair with Casters**  
[Page SQS17](#)



**Knox Guest  
Straight Arm Chair**  
[Page SQS19](#)



**Knox Guest  
Straight Arm Chair with Casters**  
[Page SQS20](#)



**Knox  
Linking Bracket**  
[Page SQS21](#)



**Knox  
Transport Cart**  
[Page SQS21](#)

### Sosa



**Sosa Guest  
Fully Upholstered Back**  
[Page SQS29](#)



**Sosa Guest  
3/4 Upholstered Back**  
[Page SQS29](#)

# Seating Quickship Product Information

## Swivel

### Garvey R5



Garvey R5 Swivel  
R5 Back Style -  
Executive Adjustable High Back  
[Page SQS7](#)



Garvey R5 Swivel  
R5 Back Style -  
Management Adjustable Mid Back  
[Page SQS7](#)

### Knox



Knox Swivel  
Straight Arm Swivel Chair  
[Page SQS24](#)



Knox Swivel  
Flared Arm Swivel Chair  
[Page SQS25](#)



### Newton



Newton Swivel  
Standard Scale Executive High Back  
[Page SQS27](#)



Newton Swivel  
Standard Scale Management Mid Back  
[Page SQS27](#)

## Seating Quickship Product Information

JSI offers select Seating models, with select options, in our Quickship program. These items ship within 10 business days after receipt of a clean, credit approved purchase order. Items should be placed on order separate from standard lead time models.

Product for up to 25 seats of selected Seating can be included on a single Quickship order. Available capacity is filled by orders as they are received. If normal 10 day Quickship is not available because capacity has been filled, you will be immediately notified by JSI customer service. Changes and cancellations to Quickship orders are not allowed under any circumstances, nor are modifications to the predetermined Quickship offering. Limit one order per project.

A separate quickship catalog is available on the 20/20 Technologies through the CAP and Giza Platforms, as well as through Spec by Configura. Available product can also be specified from the Quickship tab on JSI's CET extension.

### Finish and Reference Codes - Summary

Select	Code	Select	Code	Select	Grade
<b>All Maple Seating Finishes</b>		<b>Knox Metal Finishes</b>		<b>Fabric</b>	
Barrel	BAR	Arctic Silver	ASL	Momentum - Fuse	A
Buff	Buff	Matte Black	MBK	Momentum - Graph	B
Cask	CSK			Momentum - Guild	A
Clay	CLY			Momentum - Infinity C -Zero	C
Cinder	CND	<b>Knox Plastic Finishes</b>		Momentum - Origin	A
Egret	EGR	Grey Matters	GRM	Maharam - Meld	C
Fawn	FAW	Tricorn Black	TBM	Maharam - Messenger	C
Flax	FLX			Momentum - Silica Leather	F
Flint	FLN	All other series specific product information see Order Check List		Spradling Maglia	C
Florence Walnut	FLO			Spradling Silververtex	C
Loft	LOF			Stinson - Lara	C
Mesa	MES				
Mineral	MIN				
Mocha	MCH				
Outback	OBK				
Pilsner	PIL				
Pinnacle Walnut	PIN				
Raven	RAV				
Rye	RYE				
Sable	SAB				
Saddle	SAD				
Sienna	SIE				
Truffle	TRF				
Umber	UMB				
Valley	VAL				
Walnut Heights	WLH				

For General Terms & Conditions, Warranty or Care & Maintenance refer to JSI Commercial Price List

# Bourne Quickship Seating Order Check List:

*Need it* **NOW!**  
**JSI QUICKSHIP**



**Specify:**

- 1. Model Number
- 2. Wood Species - Maple (M)
- 3. Wood Finish
- 4. Fabric Selection - vendor, pattern and color

**Example:**

**QBU7511D** | **M** | **BAR** | **MAHARAM** | **MELD** | **SKYLINE**  
 (model #) | (wood species) | (finish) | (fabric vendor) | (pattern name) | (pattern color)

**1. Model Number**

---

**2. Wood Species - Maple (M)**

---

**3. Wood Finish Options:**

**Maple Frame**

BAR	Barrel	MCH	Mocha
BRK	Brickdust	OBK	Outback
BUF	Buff	PIL	Pilsner
CSK	Cask	PIN	Pinnacle Walnut
CLY	Clay	RAV	Raven
CND	Cinder	RYE	Rye
EGR	Egret	SAB	Sable
FAW	Fawn	SAD	Saddle
FLX	Flax	SIE	Sienna
FLN	Flint	TRF	Truffle
FLO	Florence Walnut	UMB	Umber
LOF	Loft	VAL	Valley
MES	Mesa	WLH	Walnut Heights
MIN	Mineral		

**4. Quickship Seating Fabric Selection** - Please supply the following:

Fabric vendor/Pattern name/Pattern color

[Please consult carded textiles on website for a list of colorways available on Quickship from each pattern](#)

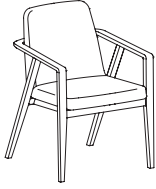
Description	Model	Specifications			List Price Per Grade		
<b>Guest Chair - Single Textile</b> 	<b>QBU7511D</b> · wall saver	<b>Dimensions</b>	<b>D</b>	<b>W</b>	<b>H</b>	A \$1,495	
		Overall	26	24¼	33	B \$1,520	
		Seat	18	20¼	18	C \$1,565	
		Arm			25	F \$1,772	
		<b>Shipping</b>					
		Ctn Wt	25				
		Cu Ft	14				

Specify: Model | Fabric Grade Selection | Maple Wood Species | Finish

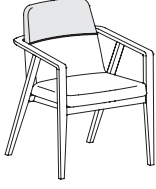
<b>Guest Chair - Dual Textile</b> 	<b>QBU7511E</b> · wall saver	<b>Dimensions</b>	<b>D</b>	<b>W</b>	<b>H</b>	A \$1,565	
		Overall	26	24¼	33	B \$1,596	
		Seat	18	20¼	18	C \$1,650	
		Arm			25	F \$1,899	
		<b>Shipping</b>					
		Ctn Wt	25				
		Cu Ft	14				

Specify: Model | Seat & Lower Back Fabric Grade Selection | Upper Back Fabric Grade Selection | Highest Fabric Grade Selection | Maple Wood Species | Finish

# Garvey R5 Quickship Order Check List:

*Need it* **NOW!**  
 JSI QUICKSHIP



**Specify:**

- 1. Model Number
- 2. Fabric Selection - vendor, pattern and color

**Example:**

QGV1724 (model #)	MOMENTUM (fabric vendor)	SILICA LEATHER (pattern name)	ALMOND (pattern color)
----------------------	-----------------------------	----------------------------------	---------------------------

**1. Model Number**

**2. Quickship Seating Fabric Selection** - Please supply the following:  
 Fabric vendor/Pattern name/Pattern color

[Please consult carded textiles on website for a list of colorways available on Quickship from each pattern](#)

**3. Arms:**

Adjustable T Arms (ATA)

**4. Control:**

Swivel Tilt (SWT)

**5. Casters:**

Black Hard Tread Dual Wheel (BLK)

Description	Model	Specifications			List Price Per Grade	
<b>R5 Back Style - Executive Adjustable High Back</b> 	<b>QGV1724</b> <ul style="list-style-type: none"> <li>back has five height ratchet positions for 2 ½" vertical adjustment.</li> <li>adjustable T arms</li> <li>swivel tilt control</li> <li>black hard tread dual wheel casters</li> </ul>	Dimensions	D	W	H	A \$1,413
		Overall	25	30	43-48 ½	B \$1,466
		Seat	18 ½	21 ½	21 ½	C \$1,561
		Arm			23 ½-29	F \$1,993
		Shipping				
		Ctn Wt	52			
		Cu Ft	16			

Specify: Model | Fabric Grade Selection

Description	Model	Specifications			List Price Per Grade	
<b>R5 Back Style - Management Adjustable Mid Back</b> 	<b>QGV1723</b> <ul style="list-style-type: none"> <li>back has five height ratchet positions for 2 ½" vertical adjustment.</li> <li>adjustable T arms</li> <li>swivel tilt control</li> <li>black hard tread dual wheel casters</li> </ul>	Dimensions	D	W	H	A \$1,396
		Overall	25	30	38-41 ½	B \$1,444
		Seat	18 ½	21 ½	21 ½	C \$1,530
		Arm			23 ½-29	F \$1,918
		Shipping				
		Ctn Wt	49			
		Cu Ft	12			

Specify: Model | Fabric Grade Selection

# Gatsby Quickship Order Check List:

*Need it* **NOW!**  
**JSI QUICKSHIP**



**Specify:**

- 1. Model Number
- 2. Wood Species - Maple (M)
- 3. Wood Finish
- 4. Fabric Selection - vendor, pattern and color

**Example:**

**QGT4901E** | **M** | **BAR** | **MAHARAM** | **MELD** | **SKYLINE**  
 (model #) | (wood species) | (finish) | (fabric vendor) | (pattern name) | (pattern color)

**1. Model Number**

**2. Wood Species - Maple (M)**

**3. Wood Finish Options:**

BAR	Barrel	MCH	Mocha
BRK	Brickdust	OBK	Outback
BUF	Buff	PIL	Pilsner
CSK	Cask	PIN	Pinnacle Walnut
CND	Cinder	RAV	Raven
CLY	Clay	RYE	Rye
EGR	Egret	SAB	Sable
FAW	Fawn	SAD	Saddle
FLX	Flax	SIE	Sienna
FLN	Flint	TRF	Truffle
FLO	Florence Walnut	UMB	Umber
LOF	Loft	VAL	Valley
MES	Mesa	WLH	Walnut Heights
MIN	Mineral		

**4. Quickship Seating Fabric Selection** - Please supply the following:

Fabric vendor/Pattern name/Pattern color

[Please consult carded textiles on website for a list of colorways available on Quickship from each pattern](#)

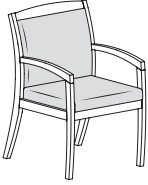

Description	① Model	Specifications			List Price Per Grade		
<b>Guest Chair</b> 	<b>QGT4901D</b> · upholstered seat · fully upholstered back · solid hardwood back frame with synthetic sheet webbing and ¾" high density polyurethane foam	<b>Dimensions</b>	<b>D</b>	<b>W</b>	<b>H</b>	A \$1,010	
		Overall	24 ½	22 ½	35 ¾	B \$1,042	
		Seat	18 ¼	20	19	C \$1,097	
		Arm			25 ¾	F \$1,353	
		<b>Shipping</b>					
		Ctn Wt	30				
		Cu Ft	17				

Specify: Model | Fabric Grade Selection | Wood Finish

Description	① Model	Specifications			List Price Per Grade		
<b>Guest Chair</b> 	<b>QGT4901E</b> · upholstered seat · ¾ upholstered back · solid hardwood back frame with synthetic sheet webbing and ¾" high density polyurethane foam	<b>Dimensions</b>	<b>D</b>	<b>W</b>	<b>H</b>	A \$1,002	
		Overall	24 ½	22 ½	35 ¾	B \$1,033	
		Seat	18 ¼	20	19	C \$1,089	
		Arm			25 ¾	F \$1,344	
		<b>Shipping</b>					
		Ctn Wt	29				
		Cu Ft	17				

Specify: Model | Fabric Grade Selection | Wood Finish

Description	D	W	H	CTN WT	CU FT	① Model	List Price
<b>Chair Linking Kit</b>						<b>QGT49BRKT</b>	<b>\$155</b>

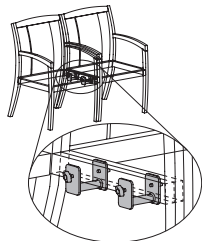
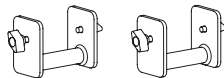

- kit contains two brackets and four thumb screws
- no tools required
- one kit required for each two guest chairs that are to be linked together
- three models linked together require two kits, four models linked together require three kits, etc.

Specify: Model

# Knox Guest Quickship Order Check List:

*Need it* **NOW!**  
**JSI QUICKSHIP**



**Specify:**

- 1. Model Number
- 2. Fabric Selection - vendor, pattern and color
- 3. Plastic Color or Wood Finish
- 4. Metal Frame - Arctic Silver (ASL) or Matte Black (MBK)

**Example:**

<b>QKN3001WUF</b> (model #)	<b>MAHARAM</b> (fabric vendor)	<b>MESSENGER</b> (pattern name)	<b>ONYX</b> (pattern color)	<b>ASL</b> (metal color)	<b>MA1</b> (wood species)	<b>BAR</b> (finish)
--------------------------------	-----------------------------------	------------------------------------	--------------------------------	-----------------------------	------------------------------	------------------------

**1. Model Number**

**2. Quickship Seating Fabric Selection** - Please supply the following:  
 Fabric vendor/Pattern name/Pattern color

[Please consult carded textiles on website for a list of colorways available on Quickship from each pattern](#)

**3. Plastic Color or Wood Finish Options**

**Plastic Colors:**

GRM Grey Matters	TBM Tricorn Black
------------------	-------------------

**Maple Wood Finish Options:**

BAR Barrel	MCH Mocha
BRK Brickdust	OBK Outback
BUF Buff	PIL Pilsner
CSK Cask	PIN Pinnacle Walnut
CND Cinder	RAV Raven
CLY Clay	RYE Rye
EGR Egret	SAB Sable
FAW Fawn	SAD Saddle
FLX Flax	SIE Sienna
FLN Flint	TRF Truffle
FLO Florence Walnut	UMB Umber
LOF Loft	VAL Valley
MES Mesa	WLH Walnut Heights
MIN Mineral	

**4. Metal Frame Colors:**

ASL Arctic Silver	MBK Matte Black
-------------------	-----------------

**Back Materials**

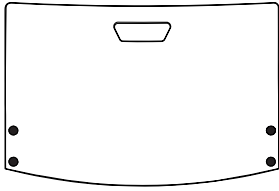

**Plastic Back**

Available Colors - [see pg SQS10](#)

Handle cut is standard

Front fasteners match frame back Screw caps match plastic color

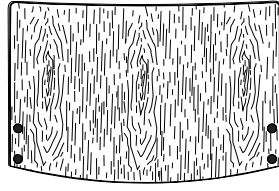

**Maple Veneer Back**

Handle cut is NOT available

Maple Finishes - [see pg SQS10](#)

Front fasteners and screw cap covers coordinate with frame on armless models; Front fasteners match frame and arms on arm models

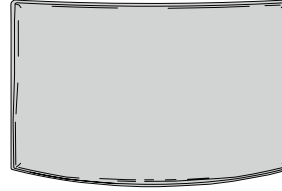

**Upholstered Flex Back**

Handle cut is NOT available

All fasteners are hidden.

**Back Screw Cap Cover**

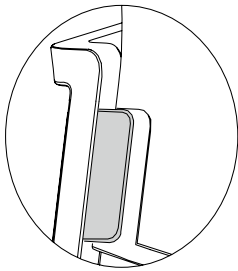

All chairs with plastic on wood backs have screw cap covers on the back side.

Upholstered multiply seating chairs have screw cap covers on the back side. All other upholstered chairs cover the hardware with the upholstery.

**Seat Materials**

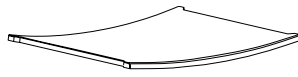

**Plastic Seat**

Available Colors - [see pg SQS10](#)

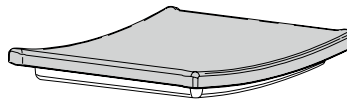

**Upholstered Seat**

Seat pan offers a recess to add additional comfort  
Seat foam is molded with a high resilient foam

**Multiple Fabrics**

Units can be specified with a contrasting upholstery. When this feature is determined the unit **will be priced based on the highest grade fabric**. At the time of ordering identify the location of each textile according to the following code.

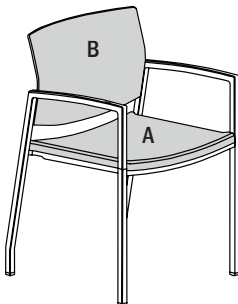

A = Seat  
B = Back

**Arms**

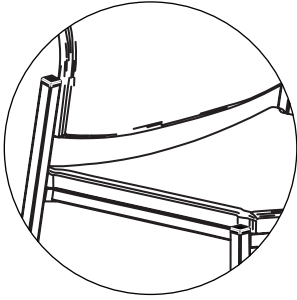

**Armless**

Available on guest seating

Armless style allows for linking

Tube cap matches the frame color

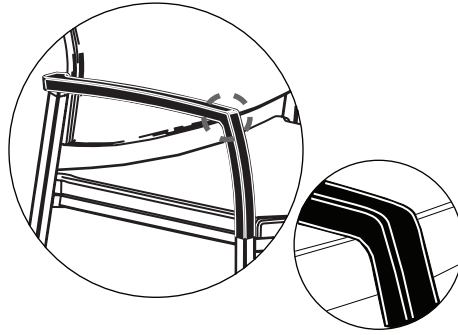

**Flared Arms**

Available on guest or swivel seating

Linking NOT available

Allows for stacking

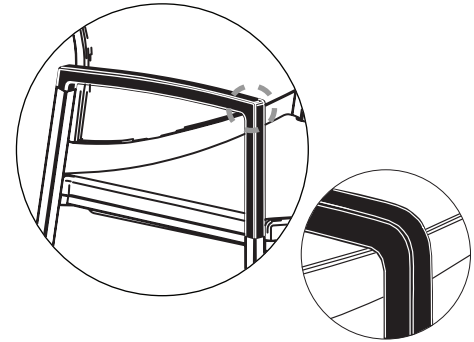

**Straight Arm**

Available on guest or swivel seating

Allows linking

Stacking NOT allowed

**Specifications**

**Frame Construction**

1. Tubular steel frame, 1<sup>7</sup>/<sub>8</sub>" , 12 gauge fabricated welded frame.
2. Caster chair frames have a gusset for additional strength.
3. All guest frames have a clear neoprene bumper on the inside of the leg to protect finish when stacking.

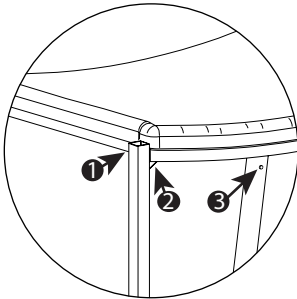

**Casters**

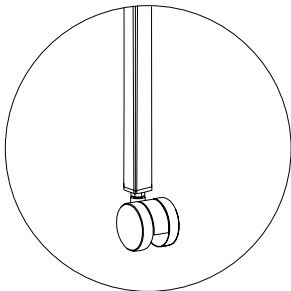

Guest chairs ending in a **C** are standard with a 50mm black nylon dual wheel caster.

**Glides**

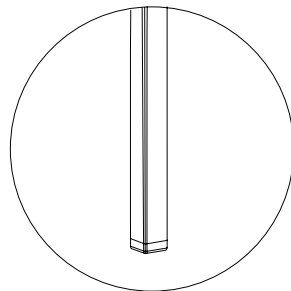

All other guest chairs are standard with nylon glides, color matched to frame.

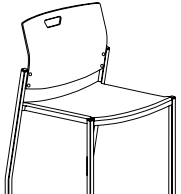
Description	Model	Specifications			List Price Per Grade	
<b>Armless Stack Chair</b>  plastic seat	<b>QKN3003PP - All Plastic</b> <b>QKN3003PU - Seat Uph.</b> · stacks six high · linking bracket available, order separately, see page <a href="#">SQS21</a> · passes a 500 lb load rating test · wall saver	<b>Dimensions</b>	<b>D</b>	<b>W</b>	<b>H</b>	All Plastic \$497 A \$656 B \$675 C \$705 F \$847
		Overall	21 ¼	21 ¼	32	
		Seat	17 ¾	19	18 ½	
		<b>Shipping</b>				
		Ctn Wt	15			
		Cu Ft	11			

All Plastic Specify: Model | Plastic Color | Metal Frame Color

Seat Uph. Specify: Model | Seat Fabric Grade Selection | Plastic Color | Metal Frame Color

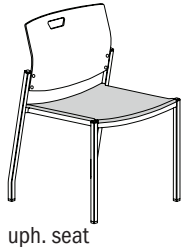

<b>QKN3003PP-3 - All Plastic</b> <b>QKN3003PU-3 - Seat Uph.</b> · sets of 3 packaged together - must have all same options · stacks six high · linking bracket available, order separately, see page <a href="#">SQS21</a> · passes a 500 lb load rating test · wall saver	<b>Dimensions</b>	<b>D</b>	<b>W</b>	<b>H</b>	All Plastic \$1,279 A \$1,668 B \$1,703 C \$1,766 F \$2,047
	Overall	21 ¼	21 ¼	32	
	Seat	17 ¾	19	18 ½	
	<b>Shipping</b>				
	Ctn Wt	41			
	Cu Ft	15			

All Plastic Specify: Model | Plastic Color | Metal Frame Color

Seat Uph. Specify: Model | Seat Fabric Grade Selection | Plastic Color | Metal Frame Color

**Armless Stack Chair - Wood Back/Upholstered Seat**

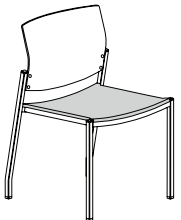

<b>QKN3003WU</b> · stacks six high · standard maple veneer back available in maple finishes · linking bracket available, order separately, see page <a href="#">SQS21</a> · passes a 500 lb load rating test · wall saver	<b>Dimensions</b>	<b>D</b>	<b>W</b>	<b>H</b>	A \$868 B \$886 C \$916 F \$1,058
	Overall	21 ¼	21 ¼	32	
	Seat	17 ¾	19	18 ½	
	<b>Shipping</b>				
	Ctn Wt	16			
	Cu Ft	11			

Specify: Model | Seat Fabric Grade Selection | Metal Frame Color | Maple Wood Species | Finish

<b>QKN3003WU-3</b> · sets of 3 packaged together - must have all same options · stacks six high · standard maple veneer back available in maple finishes · linking bracket available, order separately, see page <a href="#">SQS21</a> · passes a 500 lb load rating test · wall saver	<b>Dimensions</b>	<b>D</b>	<b>W</b>	<b>H</b>	A \$2,190 B \$2,225 C \$2,286 F \$2,570
	Overall	21 ¼	21 ¼	32	
	Seat	17 ¾	19	18 ½	
	<b>Shipping</b>				
	Ctn Wt	44			
	Cu Ft	15			

Specify: Model | Seat Fabric Grade Selection | Metal Frame Color | Maple Wood Species | Finish

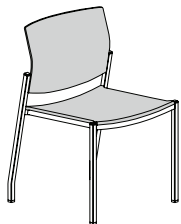
Description	① Model	Specifications	List Price Per Grade																				
<b>Armless Stack Chair - All Upholstered</b> 	<b>QKN3003UU</b> <ul style="list-style-type: none"> <li>stacks six high</li> <li>linking bracket available, order separately, see page <a href="#">SQS21</a></li> <li>passes a 500 lb load rating test</li> <li>wall saver</li> </ul>	<table border="1"> <thead> <tr> <th>Dimensions</th> <th>D</th> <th>W</th> <th>H</th> </tr> </thead> <tbody> <tr> <td>Overall</td> <td>21 ¼</td> <td>21 ¼</td> <td>32</td> </tr> <tr> <td>Seat</td> <td>17 ¾</td> <td>19</td> <td>18 ½</td> </tr> </tbody> </table>	Dimensions	D	W	H	Overall	21 ¼	21 ¼	32	Seat	17 ¾	19	18 ½	<table border="1"> <tbody> <tr> <td>A</td> <td>\$799</td> </tr> <tr> <td>B</td> <td>\$827</td> </tr> <tr> <td>C</td> <td>\$881</td> </tr> <tr> <td>F</td> <td>\$1,115</td> </tr> </tbody> </table>	A	\$799	B	\$827	C	\$881	F	\$1,115
		Dimensions	D	W	H																		
Overall	21 ¼	21 ¼	32																				
Seat	17 ¾	19	18 ½																				
A	\$799																						
B	\$827																						
C	\$881																						
F	\$1,115																						
<table border="1"> <thead> <tr> <th>Upholstery</th> <th colspan="2">Shipping</th> </tr> </thead> <tbody> <tr> <td>COM Ydg</td> <td>1 ¼</td> <td>Ctn Wt 17</td> </tr> <tr> <td>COL Sq Ft</td> <td>23</td> <td>Cu Ft 11</td> </tr> </tbody> </table>	Upholstery	Shipping		COM Ydg	1 ¼	Ctn Wt 17	COL Sq Ft	23	Cu Ft 11														
Upholstery	Shipping																						
COM Ydg	1 ¼	Ctn Wt 17																					
COL Sq Ft	23	Cu Ft 11																					
<b>Specify:</b> Model   Seat Fabric Grade Selection   Back Fabric Grade Selection   Highest Fabric Grade Selection   Metal Frame Color																							

<b>QKN3003UU-3</b> <ul style="list-style-type: none"> <li>sets of 3 packaged together - must have all same options</li> <li>stacks six high</li> <li>linking bracket available, order separately, see page <a href="#">SQS21</a></li> <li>passes a 500 lb load rating test</li> <li>wall saver</li> </ul>	<table border="1"> <thead> <tr> <th>Dimensions</th> <th>D</th> <th>W</th> <th>H</th> </tr> </thead> <tbody> <tr> <td>Overall</td> <td>21 ¼</td> <td>21 ¼</td> <td>32</td> </tr> <tr> <td>Seat</td> <td>17 ¾</td> <td>19</td> <td>18 ½</td> </tr> </tbody> </table>	Dimensions	D	W	H	Overall	21 ¼	21 ¼	32	Seat	17 ¾	19	18 ½	<table border="1"> <tbody> <tr> <td>A</td> <td>\$2,033</td> </tr> <tr> <td>B</td> <td>\$2,097</td> </tr> <tr> <td>C</td> <td>\$2,210</td> </tr> <tr> <td>F</td> <td>\$2,727</td> </tr> </tbody> </table>	A	\$2,033	B	\$2,097	C	\$2,210	F	\$2,727
	Dimensions	D	W	H																		
Overall	21 ¼	21 ¼	32																			
Seat	17 ¾	19	18 ½																			
A	\$2,033																					
B	\$2,097																					
C	\$2,210																					
F	\$2,727																					
<table border="1"> <thead> <tr> <th>Upholstery</th> <th colspan="2">Shipping</th> </tr> </thead> <tbody> <tr> <td>COM Ydg</td> <td>2 ¾</td> <td>Ctn Wt 47</td> </tr> <tr> <td>COL Sq Ft</td> <td>50</td> <td>Cu Ft 15</td> </tr> </tbody> </table>	Upholstery	Shipping		COM Ydg	2 ¾	Ctn Wt 47	COL Sq Ft	50	Cu Ft 15													
Upholstery	Shipping																					
COM Ydg	2 ¾	Ctn Wt 47																				
COL Sq Ft	50	Cu Ft 15																				
<b>Specify:</b> Model   Seat Fabric Grade Selection   Back Fabric Grade Selection   Highest Fabric Grade Selection   Metal Frame Color																						

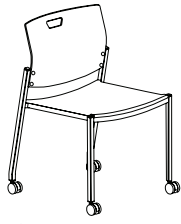
<b>Armless Stack Chair with Casters</b> 	<b>QKN3003PPC - All Plastic</b> <b>QKN3003PUC - Seat Uph.</b> <ul style="list-style-type: none"> <li>stacks six high</li> <li>wall saver</li> </ul>	<table border="1"> <thead> <tr> <th>Dimensions</th> <th>D</th> <th>W</th> <th>H</th> </tr> </thead> <tbody> <tr> <td>Overall</td> <td>21 ¼</td> <td>21 ¼</td> <td>32</td> </tr> <tr> <td>Seat</td> <td>17 ¾</td> <td>19</td> <td>18 ½</td> </tr> </tbody> </table>	Dimensions	D	W	H	Overall	21 ¼	21 ¼	32	Seat	17 ¾	19	18 ½	<table border="1"> <tbody> <tr> <td>All Plastic</td> <td>\$523</td> </tr> <tr> <td>A</td> <td>\$688</td> </tr> <tr> <td>B</td> <td>\$705</td> </tr> <tr> <td>C</td> <td>\$736</td> </tr> <tr> <td>F</td> <td>\$878</td> </tr> </tbody> </table>	All Plastic	\$523	A	\$688	B	\$705	C	\$736	F	\$878
		Dimensions	D	W	H																				
Overall	21 ¼	21 ¼	32																						
Seat	17 ¾	19	18 ½																						
All Plastic	\$523																								
A	\$688																								
B	\$705																								
C	\$736																								
F	\$878																								
<table border="1"> <thead> <tr> <th>Upholstery</th> <th colspan="2">Shipping</th> </tr> </thead> <tbody> <tr> <td>COM Ydg</td> <td>¾</td> <td>Ctn Wt 15</td> </tr> <tr> <td>COL Sq Ft</td> <td>14</td> <td>Cu Ft 11</td> </tr> </tbody> </table>	Upholstery	Shipping		COM Ydg	¾	Ctn Wt 15	COL Sq Ft	14	Cu Ft 11																
Upholstery	Shipping																								
COM Ydg	¾	Ctn Wt 15																							
COL Sq Ft	14	Cu Ft 11																							
<b>All Plastic Specify:</b> Model   Plastic Color   Metal Frame Color <b>Seat Uph. Specify:</b> Model   Seat Fabric Grade Selection   Plastic Color   Metal Frame Color																									

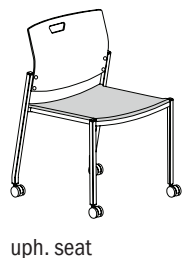

<b>QKN3003PPC-3 - All Plastic</b> <b>QKN3003PUC-3 - Seat Uph.</b> <ul style="list-style-type: none"> <li>sets of 3 packaged together - must have all same options</li> <li>stacks six high</li> <li>wall saver</li> </ul>	<table border="1"> <thead> <tr> <th>Dimensions</th> <th>D</th> <th>W</th> <th>H</th> </tr> </thead> <tbody> <tr> <td>Overall</td> <td>21 ¼</td> <td>21 ¼</td> <td>32</td> </tr> <tr> <td>Seat</td> <td>17 ¾</td> <td>19</td> <td>18 ½</td> </tr> </tbody> </table>	Dimensions	D	W	H	Overall	21 ¼	21 ¼	32	Seat	17 ¾	19	18 ½	<table border="1"> <tbody> <tr> <td>All Plastic</td> <td>\$1,333</td> </tr> <tr> <td>A</td> <td>\$1,721</td> </tr> <tr> <td>B</td> <td>\$1,756</td> </tr> <tr> <td>C</td> <td>\$1,819</td> </tr> <tr> <td>F</td> <td>\$2,102</td> </tr> </tbody> </table>	All Plastic	\$1,333	A	\$1,721	B	\$1,756	C	\$1,819	F	\$2,102
	Dimensions	D	W	H																				
Overall	21 ¼	21 ¼	32																					
Seat	17 ¾	19	18 ½																					
All Plastic	\$1,333																							
A	\$1,721																							
B	\$1,756																							
C	\$1,819																							
F	\$2,102																							
<table border="1"> <thead> <tr> <th>Upholstery</th> <th colspan="2">Shipping</th> </tr> </thead> <tbody> <tr> <td>COM Ydg</td> <td>1 ½</td> <td>Ctn Wt 41</td> </tr> <tr> <td>COL Sq Ft</td> <td>27</td> <td>Cu Ft 15</td> </tr> </tbody> </table>	Upholstery	Shipping		COM Ydg	1 ½	Ctn Wt 41	COL Sq Ft	27	Cu Ft 15															
Upholstery	Shipping																							
COM Ydg	1 ½	Ctn Wt 41																						
COL Sq Ft	27	Cu Ft 15																						
<b>All Plastic Specify:</b> Model   Plastic Color   Metal Frame Color <b>Seat Uph. Specify:</b> Model   Seat Fabric Grade Selection   Plastic Color   Metal Frame Color																								

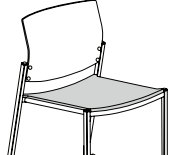
Description	Model	Specifications			List Price Per Grade	
<b>Armless Stack Chair with Casters - Wood Back/Upholstered Seat</b> 	<b>QKN3003WUC</b> · stacks six high · standard maple veneer back available in maple finishes · wall saver	<b>Dimensions</b>	<b>D</b>	<b>W</b>	<b>H</b>	A \$889
		Overall	21 ¼	21 ¼	32	B \$908
		Seat	17 ¾	19	18 ½	C \$937
		<b>Shipping</b>				F \$1,080
		Ctn Wt	16			
		Cu Ft	11			

Specify: Model | Seat Fabric Grade Selection | Metal Frame Color | Maple Wood Species | Finish

<b>QKN3003WUC-3</b> · sets of 3 packaged together - must have all same options · stacks six high · standard maple veneer back available in maple finishes · wall saver	<b>Dimensions</b>	<b>D</b>	<b>W</b>	<b>H</b>	A \$2,247
	Overall	21 ¼	21 ¼	32	B \$2,281
	Seat	17 ¾	19	18 ½	C \$2,344
	<b>Shipping</b>				F \$2,626
	Ctn Wt	44			
	Cu Ft	15			

Specify: Model | Seat Fabric Grade Selection | Metal Frame Color | Maple Wood Species | Finish

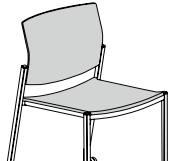
<b>Armless Stack Chair with Casters - All Upholstered</b> 	<b>QKN3003UUC</b> · stacks six high · wall saver	<b>Dimensions</b>	<b>D</b>	<b>W</b>	<b>H</b>	A \$802
		Overall	21 ¼	21 ¼	32	B \$830
		Seat	17 ¾	19	18 ½	C \$883
		<b>Shipping</b>				F \$1,117
		Ctn Wt	17			
		Cu Ft	11			

Specify: Model | Seat Fabric Grade Selection | Back Fabric Grade Selection | Highest Fabric Grade Selection | Metal Frame Color

<b>QKN3003UUC-3</b> · sets of 3 packaged together - must have all same options · stacks six high · wall saver	<b>Dimensions</b>	<b>D</b>	<b>W</b>	<b>H</b>	A \$2,086
	Overall	21 ¼	21 ¼	32	B \$2,152
	Seat	17 ¾	19	18 ½	C \$2,264
	<b>Shipping</b>				F \$2,782
	Ctn Wt	47			
	Cu Ft	15			

Specify: Model | Seat Fabric Grade Selection | Back Fabric Grade Selection | Highest Fabric Grade Selection | Metal Frame Color

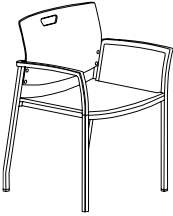
Description	① Model	Specifications	List Price Per Grade																												
<b>Flared Arm Stack Chair</b>  plastic seat	<b>QKN3001PPF - All Plastic</b> <b>QKN3001PUF - Seat Uph.</b> <ul style="list-style-type: none"> <li>stacks six high</li> <li>passes a 500 lb load rating test</li> <li>wall saver</li> </ul>	<table border="1"> <thead> <tr> <th>Dimensions</th> <th>D</th> <th>W</th> <th>H</th> </tr> </thead> <tbody> <tr> <td>Overall</td> <td>21 ¼</td> <td>24 ⅞</td> <td>32</td> </tr> <tr> <td>Seat</td> <td>17 ¾</td> <td>21 ½</td> <td>18 ½</td> </tr> <tr> <td>Arm</td> <td></td> <td></td> <td>26 ⅝</td> </tr> <tr> <th colspan="4">Shipping</th> </tr> <tr> <td>Ctn Wt</td> <td>16</td> <td></td> <td></td> </tr> <tr> <td>Cu Ft</td> <td>12</td> <td></td> <td></td> </tr> </tbody> </table>	Dimensions	D	W	H	Overall	21 ¼	24 ⅞	32	Seat	17 ¾	21 ½	18 ½	Arm			26 ⅝	Shipping				Ctn Wt	16			Cu Ft	12			All Plastic \$592 A \$744 B \$761 C \$792 F \$934
		Dimensions	D	W	H																										
Overall	21 ¼	24 ⅞	32																												
Seat	17 ¾	21 ½	18 ½																												
Arm			26 ⅝																												
Shipping																															
Ctn Wt	16																														
Cu Ft	12																														

All Plastic Specify: Model | Plastic Color | Metal Frame Color

Seat Uph. Specify: Model | Seat Fabric Grade Selection | Plastic Color | Metal Frame Color



<b>QKN3001PPF-3 - All Plastic</b> <b>QKN3001PUF-3 - Seat Uph.</b> <ul style="list-style-type: none"> <li>sets of 3 packaged together - must have all same options</li> <li>stacks six high</li> <li>passes a 500 lb load rating test</li> <li>wall saver</li> </ul>	<table border="1"> <thead> <tr> <th>Dimensions</th> <th>D</th> <th>W</th> <th>H</th> </tr> </thead> <tbody> <tr> <td>Overall</td> <td>21 ¼</td> <td>24 ⅞</td> <td>32</td> </tr> <tr> <td>Seat</td> <td>17 ¾</td> <td>21 ½</td> <td>18 ½</td> </tr> <tr> <td>Arm</td> <td></td> <td></td> <td>26 ⅝</td> </tr> <tr> <th colspan="4">Shipping</th> </tr> <tr> <td>Ctn Wt</td> <td>44</td> <td></td> <td></td> </tr> <tr> <td>Cu Ft</td> <td>16</td> <td></td> <td></td> </tr> </tbody> </table>	Dimensions	D	W	H	Overall	21 ¼	24 ⅞	32	Seat	17 ¾	21 ½	18 ½	Arm			26 ⅝	Shipping				Ctn Wt	44			Cu Ft	16			All Plastic \$1,539 A \$1,930 B \$1,963 C \$2,025 F \$2,308
	Dimensions	D	W	H																										
Overall	21 ¼	24 ⅞	32																											
Seat	17 ¾	21 ½	18 ½																											
Arm			26 ⅝																											
Shipping																														
Ctn Wt	44																													
Cu Ft	16																													

All Plastic Specify: Model | Plastic Color | Metal Frame Color

Seat Uph. Specify: Model | Seat Fabric Grade Selection | Plastic Color | Metal Frame Color

**Flared Arm Stack Chair - Wood Back/Upholstered Seat**



<b>QKN3001WUF</b> <ul style="list-style-type: none"> <li>stacks six high</li> <li>standard maple veneer back available in maple finishes</li> <li>nylon arms available in matte black</li> <li>passes a 500 lb load rating test</li> <li>wall saver</li> </ul>	<table border="1"> <thead> <tr> <th>Dimensions</th> <th>D</th> <th>W</th> <th>H</th> </tr> </thead> <tbody> <tr> <td>Overall</td> <td>21 ¼</td> <td>24 ⅞</td> <td>32</td> </tr> <tr> <td>Seat</td> <td>17 ¾</td> <td>21 ½</td> <td>18 ½</td> </tr> <tr> <td>Arm</td> <td></td> <td></td> <td>26 ⅝</td> </tr> <tr> <th colspan="4">Shipping</th> </tr> <tr> <td>Ctn Wt</td> <td>16</td> <td></td> <td></td> </tr> <tr> <td>Cu Ft</td> <td>12</td> <td></td> <td></td> </tr> </tbody> </table>	Dimensions	D	W	H	Overall	21 ¼	24 ⅞	32	Seat	17 ¾	21 ½	18 ½	Arm			26 ⅝	Shipping				Ctn Wt	16			Cu Ft	12			A \$961 B \$978 C \$1,009 F \$1,152
	Dimensions	D	W	H																										
Overall	21 ¼	24 ⅞	32																											
Seat	17 ¾	21 ½	18 ½																											
Arm			26 ⅝																											
Shipping																														
Ctn Wt	16																													
Cu Ft	12																													

Specify: Model | Seat Fabric Grade Selection | Metal Frame Color | Maple Wood Finishes | Finish

<b>QKN3001WUF-3</b> <ul style="list-style-type: none"> <li>sets of 3 packaged together - must have all same options</li> <li>stacks six high</li> <li>standard maple veneer back available in maple finishes</li> <li>nylon arms available in matte black</li> <li>passes a 500 lb load rating test</li> <li>wall saver</li> </ul>	<table border="1"> <thead> <tr> <th>Dimensions</th> <th>D</th> <th>W</th> <th>H</th> </tr> </thead> <tbody> <tr> <td>Overall</td> <td>21 ¼</td> <td>24 ⅞</td> <td>32</td> </tr> <tr> <td>Seat</td> <td>17 ¾</td> <td>21 ½</td> <td>18 ½</td> </tr> <tr> <td>Arm</td> <td></td> <td></td> <td>26 ⅝</td> </tr> <tr> <th colspan="4">Shipping</th> </tr> <tr> <td>Ctn Wt</td> <td>44</td> <td></td> <td></td> </tr> <tr> <td>Cu Ft</td> <td>16</td> <td></td> <td></td> </tr> </tbody> </table>	Dimensions	D	W	H	Overall	21 ¼	24 ⅞	32	Seat	17 ¾	21 ½	18 ½	Arm			26 ⅝	Shipping				Ctn Wt	44			Cu Ft	16			A \$2,428 B \$2,462 C \$2,524 F \$2,807
	Dimensions	D	W	H																										
Overall	21 ¼	24 ⅞	32																											
Seat	17 ¾	21 ½	18 ½																											
Arm			26 ⅝																											
Shipping																														
Ctn Wt	44																													
Cu Ft	16																													

Specify: Model | Seat Fabric Grade Selection | Metal Frame Color | Maple Wood Finishes | Finish

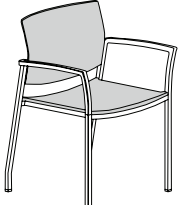

Description	Model	Specifications			List Price Per Grade	
<b>Flared Arm Stack Chair - All Upholstered</b> 	<b>QKN3001UUF</b> · stacks six high · nylon arms available in matte black · passes a 500 lb load rating test · wall saver	<b>Dimensions</b>	<b>D</b>	<b>W</b>	<b>H</b>	A \$894
		Overall	21 ¼	24 ½	32	B \$922
		Seat	17 ¾	21 ½	18 ½	C \$974
		Arm			26 ¾	F \$1,210
		<b>Shipping</b>				
		Ctn Wt	18			
		Cu Ft	12			

Specify: Model | Seat Fabric Grade Selection | Back Fabric Grade Selection | Highest Fabric Grade Selection | Metal Frame Color

<b>QKN3001UUF-3</b> · sets of 3 packaged together - must have all same options · stacks six high · nylon arms available in matte black · passes a 500 lb load rating test · wall saver	<b>Dimensions</b>	<b>D</b>	<b>W</b>	<b>H</b>	A \$2,299
	Overall	21 ¼	24 ½	32	B \$2,362
	Seat	17 ¾	21 ½	18 ½	C \$2,476
	Arm			26 ¾	F \$2,992
	<b>Shipping</b>				
	Ctn Wt	50			
	Cu Ft	16			

Specify: Model | Seat Fabric Grade Selection | Back Fabric Grade Selection | Highest Fabric Grade Selection | Metal Frame Color

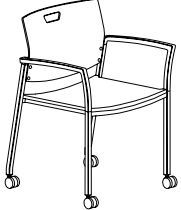
Description	Model	Specifications			All Plastic	
<b>Flared Arm Stack Chair with Casters</b> 	<b>QKN3001PPFC - All Plastic</b> <b>QKN3001PUFC - Seat Uph.</b> · stacks six high · wall saver	<b>Dimensions</b>	<b>D</b>	<b>W</b>	<b>H</b>	All Plastic \$614
		Overall	21 ¼	24 ½	32	A \$765
		Seat	17 ¾	21 ½	18 ½	B \$783
		Arm			26 ¾	C \$813
		<b>Shipping</b>				F \$956
		Ctn Wt	16			
		Cu Ft	12			

plastic seat

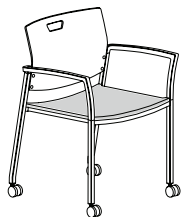

uph. seat

All Plastic Specify: Model | Plastic Color | Metal Frame Color

Seat Uph. Specify: Model | Seat Fabric Grade Selection | Plastic Color | Metal Frame Color

<b>QKN3001PPFC-3 - All Plastic</b> <b>QKN3001PUFC-3 - Seat Uph.</b> · sets of 3 packaged together - must have all same options · stacks six high · wall saver	<b>Dimensions</b>	<b>D</b>	<b>W</b>	<b>H</b>	All Plastic \$1,592
	Overall	21 ¼	24 ½	32	A \$1,983
	Seat	17 ¾	21 ½	18 ½	B \$2,017
	Arm			26 ¾	C \$2,079
	<b>Shipping</b>				F \$2,361
	Ctn Wt	44			
	Cu Ft	16			

All Plastic Specify: Model | Plastic Color | Metal Frame Color

Seat Uph. Specify: Model | Seat Fabric Grade Selection | Plastic Color | Metal Frame Color

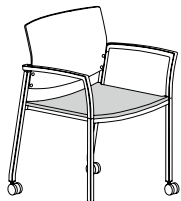
Description	① Model	Specifications	List Price Per Grade																
<b>Flared Arm Chair with Casters - Wood Back/Upholstered Seat</b> 	<b>QKN3001WUFC</b> · stacks six high · standard maple veneer back available in maple finishes · wall saver	<table border="1"> <thead> <tr> <th>Dimensions</th> <th>D</th> <th>W</th> <th>H</th> </tr> </thead> <tbody> <tr> <td>Overall</td> <td>21 ¼</td> <td>24 ⅛</td> <td>32</td> </tr> <tr> <td>Seat</td> <td>17 ¾</td> <td>21 ½</td> <td>18 ½</td> </tr> <tr> <td>Arm</td> <td></td> <td></td> <td>26 ⅝</td> </tr> </tbody> </table>	Dimensions	D	W	H	Overall	21 ¼	24 ⅛	32	Seat	17 ¾	21 ½	18 ½	Arm			26 ⅝	A \$981 B \$998 C \$1,030 F \$1,170
		Dimensions	D	W	H														
Overall	21 ¼	24 ⅛	32																
Seat	17 ¾	21 ½	18 ½																
Arm			26 ⅝																
<table border="1"> <thead> <tr> <th colspan="2">Shipping</th> </tr> </thead> <tbody> <tr> <td>Ctn Wt</td> <td>16</td> </tr> <tr> <td>Cu Ft</td> <td>12</td> </tr> </tbody> </table>	Shipping		Ctn Wt	16	Cu Ft	12													
Shipping																			
Ctn Wt	16																		
Cu Ft	12																		

Specify: Model | Seat Fabric Grade Selection | Metal Frame Color | Maple Wood Finishes | Finish

<b>QKN3001WUFC-3</b> · sets of 3 packaged together - must have all same options · stacks six high · standard maple veneer back available in maple finishes · wall saver	<table border="1"> <thead> <tr> <th>Dimensions</th> <th>D</th> <th>W</th> <th>H</th> </tr> </thead> <tbody> <tr> <td>Overall</td> <td>21 ¼</td> <td>24 ⅛</td> <td>32</td> </tr> <tr> <td>Seat</td> <td>17 ¾</td> <td>21 ½</td> <td>18 ½</td> </tr> <tr> <td>Arm</td> <td></td> <td></td> <td>26 ⅝</td> </tr> </tbody> </table>	Dimensions	D	W	H	Overall	21 ¼	24 ⅛	32	Seat	17 ¾	21 ½	18 ½	Arm			26 ⅝	A \$2,482 B \$2,518 C \$2,578 F \$2,862
	Dimensions	D	W	H														
Overall	21 ¼	24 ⅛	32															
Seat	17 ¾	21 ½	18 ½															
Arm			26 ⅝															
<table border="1"> <thead> <tr> <th colspan="2">Shipping</th> </tr> </thead> <tbody> <tr> <td>Ctn Wt</td> <td>44</td> </tr> <tr> <td>Cu Ft</td> <td>16</td> </tr> </tbody> </table>	Shipping		Ctn Wt	44	Cu Ft	16												
Shipping																		
Ctn Wt	44																	
Cu Ft	16																	

Specify: Model | Seat Fabric Grade Selection | Metal Frame Color | Maple Wood Finishes | Finish

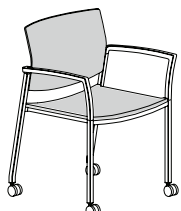
<b>Flared Arm Stack Chair with Casters - All Upholstered</b> 	<b>QKN3001UUFC</b> · stacks six high · nylon arms available in matte black · wall saver	<table border="1"> <thead> <tr> <th>Dimensions</th> <th>D</th> <th>W</th> <th>H</th> </tr> </thead> <tbody> <tr> <td>Overall</td> <td>21 ¼</td> <td>24 ⅛</td> <td>32</td> </tr> <tr> <td>Seat</td> <td>17 ¾</td> <td>21 ½</td> <td>18 ½</td> </tr> <tr> <td>Arm</td> <td></td> <td></td> <td>26 ⅝</td> </tr> </tbody> </table>	Dimensions	D	W	H	Overall	21 ¼	24 ⅛	32	Seat	17 ¾	21 ½	18 ½	Arm			26 ⅝	A \$913 B \$940 C \$993 F \$1,227
		Dimensions	D	W	H														
Overall	21 ¼	24 ⅛	32																
Seat	17 ¾	21 ½	18 ½																
Arm			26 ⅝																
<table border="1"> <thead> <tr> <th colspan="2">Shipping</th> </tr> </thead> <tbody> <tr> <td>Ctn Wt</td> <td>18</td> </tr> <tr> <td>Cu Ft</td> <td>12</td> </tr> </tbody> </table>	Shipping		Ctn Wt	18	Cu Ft	12													
Shipping																			
Ctn Wt	18																		
Cu Ft	12																		

Specify: Model | Seat Fabric Grade Selection | Back Fabric Grade Selection | Highest Fabric Grade Selection | Metal Frame Color

<b>QKN3001UUFC-3</b> · sets of 3 packaged together - must have all same options · stacks six high · wall saver	<table border="1"> <thead> <tr> <th>Dimensions</th> <th>D</th> <th>W</th> <th>H</th> </tr> </thead> <tbody> <tr> <td>Overall</td> <td>21 ¼</td> <td>24 ⅛</td> <td>32</td> </tr> <tr> <td>Seat</td> <td>17 ¾</td> <td>21 ½</td> <td>18 ½</td> </tr> <tr> <td>Arm</td> <td></td> <td></td> <td>26 ⅝</td> </tr> </tbody> </table>	Dimensions	D	W	H	Overall	21 ¼	24 ⅛	32	Seat	17 ¾	21 ½	18 ½	Arm			26 ⅝	A \$2,352 B \$2,417 C \$2,529 F \$3,047
	Dimensions	D	W	H														
Overall	21 ¼	24 ⅛	32															
Seat	17 ¾	21 ½	18 ½															
Arm			26 ⅝															
<table border="1"> <thead> <tr> <th colspan="2">Shipping</th> </tr> </thead> <tbody> <tr> <td>Ctn Wt</td> <td>50</td> </tr> <tr> <td>Cu Ft</td> <td>16</td> </tr> </tbody> </table>	Shipping		Ctn Wt	50	Cu Ft	16												
Shipping																		
Ctn Wt	50																	
Cu Ft	16																	

Specify: Model | Seat Fabric Grade Selection | Back Fabric Grade Selection | Highest Fabric Grade Selection | Metal Frame Color

Description

Model

Specifications

List Price Per Grade

Straight Arm Chair

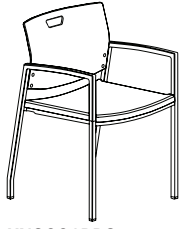

**KN3001PPS**  
plastic seat

**QKN3001PPS - All Plastic**  
**QKN3001PUS - Seat Uph.**

- non-stacking
- linking bracket available, order separately, see page [SQS21](#)
- passes a 500 lb load rating test
- wall saver

Dimensions	D	W	H
Overall	21 ¼	21 ¼	32
Seat	17 ¾	19 ¾	18 ½
Arm			26 ¾
Shipping			
Ctn Wt	16		
Cu Ft	11		

All Plastic	\$590
A	\$742
B	\$760
C	\$791
F	\$932

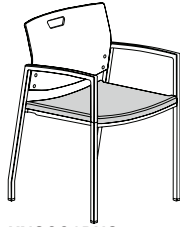

**KN3001PUS**  
uph. seat

All Plastic Specify: Model | Plastic Color | Metal Frame Color

Seat Uph. Specify: Model | Seat Fabric Grade Selection | Plastic Color | Metal Frame Color

Straight Arm Chair -  
Wood Back/Upholstered Seat



**QKN3001WUS**

- non-stacking
- standard maple veneer back available in maple finishes
- linking bracket available, order separately, see page [SQS21](#)
- passes a 500 lb load rating test
- wall saver

Dimensions	D	W	H
Overall	21 ¼	21 ¼	32
Seat	17 ¾	19 ¾	18 ½
Arm			26 ¾
Shipping			
Ctn Wt	17		
Cu Ft	11		

A	\$959
B	\$976
C	\$1,008
F	\$1,150

Specify: Model | Seat Fabric Grade Selection | Maple Wood Finishes | Finish | Metal Frame Color

Straight Arm Chair -  
All Upholstered

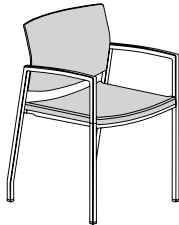

**QKN3001UUS**

- non-stacking
- linking bracket available, order separately, see page [SQS21](#)
- passes a 500 lb load rating test
- wall saver

Dimensions	D	W	H
Overall	21 ¼	21 ¼	32
Seat	17 ¾	19 ¾	18 ½
Arm			26 ¾
Shipping			
Ctn Wt	18		
Cu Ft	11		

A	\$893
B	\$921
C	\$973
F	\$1,208

Specify: Model | Seat Fabric Grade Selection | Back Fabric Grade Selection | Highest Fabric Grade Selection | Metal Frame Color

Description	① Model	Specifications	List Price Per Grade			
Straight Arm Chair with Casters 	<b>QKN3001PPSC - All Plastic</b>	<b>Dimensions</b>	All Plastic \$612			
	<b>QKN3001PUSC - Seat Uph.</b>	<b>D</b>		<b>W</b>		
	<ul style="list-style-type: none"> <li>· non-stacking</li> <li>· wall saver</li> </ul>	Overall	21 ¼	21 ¼	32	A \$763
		Seat	17 ¾	19 ¾	18 ½	B \$781
		Arm			26 ⅝	C \$812
		<b>Shipping</b>				F \$954
		Ctn Wt	16			
		Cu Ft	11			

KN3001PPSC  
plastic seat

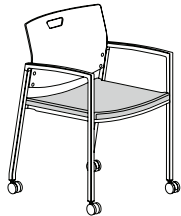

KN3001PUSC  
uph. seat

All Plastic Specify: Model | Plastic Color | Metal Frame Color

Seat Uph. Specify: Model | Seat Fabric Grade Selection | Plastic Color | Metal Frame Color

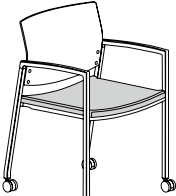
Straight Arm Chair with Casters - Wood Back/Upholstered Seat 	<b>QKN3001WUSC</b>	<b>Dimensions</b>	<b>D</b>	<b>W</b>	<b>H</b>	A \$993
	<ul style="list-style-type: none"> <li>· non-stacking</li> <li>· standard maple veneer back available in maple finishes</li> <li>· wall saver</li> </ul>	Overall	21 ¼	21 ¼	32	B \$1,010
		Seat	17 ¾	19 ¾	18 ½	C \$1,041
		Arm			26 ⅝	F \$1,183
		<b>Shipping</b>				
		Ctn Wt	17			
		Cu Ft	11			

Specify: Model | Seat Fabric Grade Selection | Maple Wood Finishes | Finish | Metal Frame Color

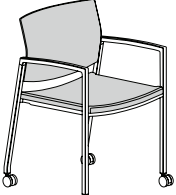
Straight Arm Chair with Casters - All Upholstered 	<b>QKN3001UUSC</b>	<b>Dimensions</b>	<b>D</b>	<b>W</b>	<b>H</b>	A \$914
	<ul style="list-style-type: none"> <li>· non-stacking</li> <li>· wall saver</li> </ul>	Overall	21 ¼	21 ¼	32	B \$941
		Seat	17 ¾	19 ¾	18 ½	C \$994
		Arm			26 ⅝	F \$1,228
		<b>Shipping</b>				
		Ctn Wt	18			
		Cu Ft	11			

Specify: Model | Seat Fabric Grade Selection | Back Fabric Grade Selection | Highest Fabric Grade Selection | Metal Frame Color

Description	D	W	H	CTN WT	CU FT	① Model	List Price
Transport Cart	34	23 ¾	40 ¾	29	22	QTC01	\$981

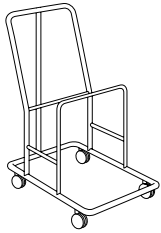

- 16 gauge steel tube
- 4" heavy duty casters
- only available in black
- stacks six armless or flared single chairs

Specify: Model

Linking Bracket				1	1	QKN30BRKT	\$68
-----------------	--	--	--	---	---	-----------	------

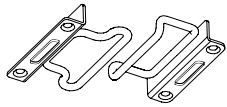

- matte black wire loop ganging bracket set

Specify: Model

# Knox Swivel Quickship Order Check List:



**Specify:**

- 1. Model Number
- 2. Fabric Selection - vendor, pattern and color
- 3. Plastic Color or Wood Finish Back
- 4. Metal Frame - Arctic Silver (ASL) or Matte Black (MBK)

**Example:**

**QKN3000WUS** | **MOMENTUM** | **Silica Leather** | **Almond** | **ASL**  
 (model #) | (fabric vendor) | (pattern name) | (pattern color) | (metal color)

**1. Model Number**

**2. Quickship Seating Fabric Selection** - Please supply the following:

Fabric vendor/Pattern name/Pattern color

[Please consult carded textiles on website for a list of colorways available on Quickship from each pattern](#)

**3. Plastic Color or Wood Finish Options**

**Plastic Colors:**

GRM Grey Matters                      TBM Tricorn Black

**Maple Wood Species Options:**

BAR Barrel	MCH Mocha
BRK Brickdust	OBK Outback
BUF Buff	PIL Pilsner
CSK Cask	PIN Pinnacle Walnut
CND Cinder	RAV Raven
CLY Clay	RYE Rye
EGR Egret	SAB Sable
FAW Fawn	SAD Saddle
FLX Flax	SIE Sienna
FLN Flint	TRF Truffle
FLO Florence Walnut	UMB Umber
LOF Loft	VAL Valley
MES Mesa	WLH Walnut Heights
MIN Mineral	

**4. Metal Frame Colors:**

ASL Arctic Silver                      MBK Matte Black

### Back Materials

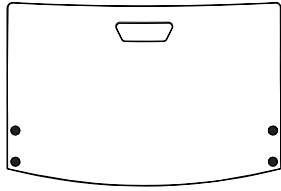

#### Plastic Back

Available Colors - [see pg SQS22](#)

Handle cut is standard

Front fasteners match frame back Screw caps match plastic color

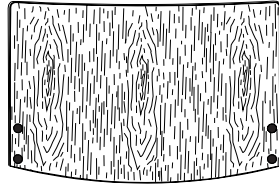

#### Maple Veneer Back

Maple Finishes - [see pg SQS22](#)

Front fasteners and screw cap covers coordinate with frame on armless models; Front fasteners match frame and arms on arm models

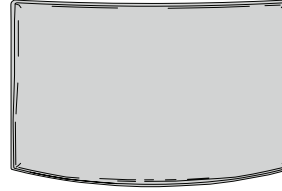

#### Upholstered Flex Back

Handle cut is NOT available

All fasteners are hidden.

### Seat Materials



#### Plastic Seat

Available Colors - [see pg SQS22](#)

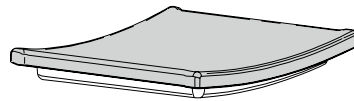

#### Upholstered Seat



Seat pan offers a recess to add additional comfort  
Seat foam is molded with a high resilient foam

### Multiple Fabrics

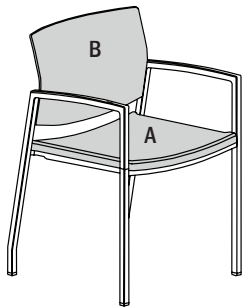
Units can be specified with a contrasting upholstery. When this feature is determined the unit **will be priced based on the highest grade fabric**. At the time of ordering identify the location of each textile according to the following code.



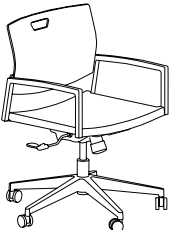

A = Seat  
B = Back

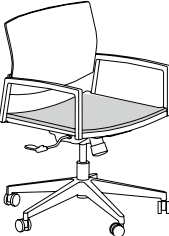
Description	① Model	Specifications	List Price Per Grade																
<b>Straight Arm Swivel Chair</b>  <b>KN3000PPS</b> plastic seat	<b>QKN3000PPS - All Plastic</b> <b>QKN3000PUS - Seat Uph.</b> <ul style="list-style-type: none"> <li>standard black nylon base with hard tread dual casters</li> <li>overall height range 31 1/2" - 36 3/4"</li> <li>seat height range 16 1/2" - 22 1/4"</li> <li>arm height range 30 3/8" - 24 5/8"</li> </ul>	<table border="1"> <thead> <tr> <th>Dimensions</th> <th>D</th> <th>W</th> <th>H</th> </tr> </thead> <tbody> <tr> <td>Overall</td> <td>28 1/2</td> <td>28 1/2</td> <td>36 3/4</td> </tr> <tr> <td>Seat</td> <td>17 3/8</td> <td>19 3/8</td> <td>22 1/4</td> </tr> <tr> <td>Arm</td> <td></td> <td></td> <td>30 3/8</td> </tr> </tbody> </table>	Dimensions	D	W	H	Overall	28 1/2	28 1/2	36 3/4	Seat	17 3/8	19 3/8	22 1/4	Arm			30 3/8	All Plastic \$839 A \$996 B \$1,014 C \$1,045 F \$1,186
		Dimensions	D	W	H														
Overall	28 1/2	28 1/2	36 3/4																
Seat	17 3/8	19 3/8	22 1/4																
Arm			30 3/8																
<table border="1"> <thead> <tr> <th colspan="2">Shipping</th> </tr> </thead> <tbody> <tr> <td>Ctn Wt</td> <td>30</td> </tr> <tr> <td>Cu Ft</td> <td>20</td> </tr> </tbody> </table>	Shipping		Ctn Wt	30	Cu Ft	20													
Shipping																			
Ctn Wt	30																		
Cu Ft	20																		
 <b>KN3000PUS</b> uph. seat	All Plastic Specify: Model   Plastic Color   Metal Frame Color  Seat Uph. Specify: Model   Seat Fabric Grade Selection   Plastic Color   Metal Frame Color																		

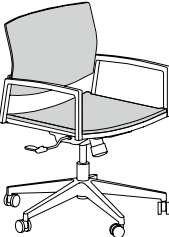
<b>Straight Arm Swivel Chair - Wood Back/Upholstered Seat</b> 	<b>QKN3000WUS</b> <ul style="list-style-type: none"> <li>standard black nylon base with hard tread dual casters</li> <li>standard maple veneer back available in maple finishes</li> <li>overall height range 31 1/2" - 36 3/4"</li> <li>seat height range 16 1/2" - 22 1/4"</li> <li>arm height range 30 3/8" - 24 5/8"</li> </ul>	<table border="1"> <thead> <tr> <th>Dimensions</th> <th>D</th> <th>W</th> <th>H</th> </tr> </thead> <tbody> <tr> <td>Overall</td> <td>28 1/2</td> <td>28 1/2</td> <td>36 3/4</td> </tr> <tr> <td>Seat</td> <td>17 3/8</td> <td>19 3/8</td> <td>22 1/4</td> </tr> <tr> <td>Arm</td> <td></td> <td></td> <td>30 3/8</td> </tr> </tbody> </table>	Dimensions	D	W	H	Overall	28 1/2	28 1/2	36 3/4	Seat	17 3/8	19 3/8	22 1/4	Arm			30 3/8	A \$1,213 B \$1,232 C \$1,262 F \$1,404
		Dimensions	D	W	H														
Overall	28 1/2	28 1/2	36 3/4																
Seat	17 3/8	19 3/8	22 1/4																
Arm			30 3/8																
<table border="1"> <thead> <tr> <th colspan="2">Shipping</th> </tr> </thead> <tbody> <tr> <td>Ctn Wt</td> <td>30</td> </tr> <tr> <td>Cu Ft</td> <td>20</td> </tr> </tbody> </table>	Shipping		Ctn Wt	30	Cu Ft	20													
Shipping																			
Ctn Wt	30																		
Cu Ft	20																		
	Specify: Model   Seat Fabric Grade Selection   Maple Wood Finishes   Metal Frame Color																		

<b>Straight Arm Swivel Chair - All Upholstered</b> 	<b>QKN3000UUS</b> <ul style="list-style-type: none"> <li>standard black nylon base with hard tread dual casters</li> <li>multiple fabrics, see page <a href="#">SQS23</a></li> <li>overall height range 31 1/2" - 36 3/4"</li> <li>seat height range 16 1/2" - 22 1/4"</li> <li>arm height range 30 3/8" - 24 5/8"</li> </ul>	<table border="1"> <thead> <tr> <th>Dimensions</th> <th>D</th> <th>W</th> <th>H</th> </tr> </thead> <tbody> <tr> <td>Overall</td> <td>28 1/2</td> <td>28 1/2</td> <td>36 3/4</td> </tr> <tr> <td>Seat</td> <td>17 3/8</td> <td>19 3/8</td> <td>22 1/4</td> </tr> <tr> <td>Arm</td> <td></td> <td></td> <td>30 3/8</td> </tr> </tbody> </table>	Dimensions	D	W	H	Overall	28 1/2	28 1/2	36 3/4	Seat	17 3/8	19 3/8	22 1/4	Arm			30 3/8	A \$1,146 B \$1,175 C \$1,227 F \$1,461
		Dimensions	D	W	H														
Overall	28 1/2	28 1/2	36 3/4																
Seat	17 3/8	19 3/8	22 1/4																
Arm			30 3/8																
<table border="1"> <thead> <tr> <th colspan="2">Shipping</th> </tr> </thead> <tbody> <tr> <td>Ctn Wt</td> <td>31</td> </tr> <tr> <td>Cu Ft</td> <td>20</td> </tr> </tbody> </table>	Shipping		Ctn Wt	31	Cu Ft	20													
Shipping																			
Ctn Wt	31																		
Cu Ft	20																		
	Specify: Model   Seat Fabric Grade Selection   Back Fabric Grade Selection   Highest Fabric Grade Selection   Metal Frame Color																		

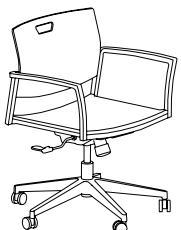

Description	Model	Specifications	List Price Per Grade																												
<b>Flared Arm Swivel Chair</b>  <b>KN3000PPF</b> plastic seat	<b>QKN3000PPF - All Plastic</b> <b>QKN3000PUF - Seat Uph.</b> <ul style="list-style-type: none"> <li>standard black nylon base with hard tread dual casters</li> <li>overall height range 31 1/2" - 36 3/4"</li> <li>seat height range 16 1/2" - 22 1/4"</li> <li>arm height range 30 3/8" - 24 5/8"</li> </ul>	<table border="1"> <thead> <tr> <th>Dimensions</th> <th>D</th> <th>W</th> <th>H</th> </tr> </thead> <tbody> <tr> <td>Overall</td> <td>28 1/2</td> <td>28 1/2</td> <td>36 3/4</td> </tr> <tr> <td>Seat</td> <td>17 3/8</td> <td>21 1/2</td> <td>22 1/4</td> </tr> <tr> <td>Arm</td> <td></td> <td></td> <td>30 3/8</td> </tr> <tr> <td colspan="4"><b>Shipping</b></td> </tr> <tr> <td>Ctn Wt</td> <td>30</td> <td></td> <td></td> </tr> <tr> <td>Cu Ft</td> <td>20</td> <td></td> <td></td> </tr> </tbody> </table>	Dimensions	D	W	H	Overall	28 1/2	28 1/2	36 3/4	Seat	17 3/8	21 1/2	22 1/4	Arm			30 3/8	<b>Shipping</b>				Ctn Wt	30			Cu Ft	20			All Plastic \$841 A \$998 B \$1,015 C \$1,046 F \$1,188
		Dimensions	D	W	H																										
Overall	28 1/2	28 1/2	36 3/4																												
Seat	17 3/8	21 1/2	22 1/4																												
Arm			30 3/8																												
<b>Shipping</b>																															
Ctn Wt	30																														
Cu Ft	20																														
 <b>KN3000PUF</b> uph. seat	All Plastic Specify: Model   Plastic Color   Metal Frame Color  Seat Uph. Specify: Model   Seat Fabric Grade Selection   Plastic Color   Metal Frame Color																														

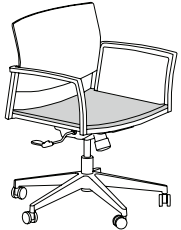
<b>Flared Arm Swivel Chair - Wood Back/Upholstered Seat</b> 	<b>QKN3000WUF</b> <ul style="list-style-type: none"> <li>standard black nylon base with hard tread dual casters</li> <li>standard maple veneer back available in maple finishes</li> <li>overall height range 31 1/2" - 36 3/4"</li> <li>seat height range 16 1/2" - 22 1/4"</li> <li>arm height range 30 3/8" - 24 5/8"</li> </ul>	<table border="1"> <thead> <tr> <th>Dimensions</th> <th>D</th> <th>W</th> <th>H</th> </tr> </thead> <tbody> <tr> <td>Overall</td> <td>28 1/2</td> <td>28 1/2</td> <td>36 3/4</td> </tr> <tr> <td>Seat</td> <td>17 3/8</td> <td>21 1/2</td> <td>22 1/4</td> </tr> <tr> <td>Arm</td> <td></td> <td></td> <td>30 3/8</td> </tr> <tr> <td colspan="4"><b>Shipping</b></td> </tr> <tr> <td>Ctn Wt</td> <td>30</td> <td></td> <td></td> </tr> <tr> <td>Cu Ft</td> <td>20</td> <td></td> <td></td> </tr> </tbody> </table>	Dimensions	D	W	H	Overall	28 1/2	28 1/2	36 3/4	Seat	17 3/8	21 1/2	22 1/4	Arm			30 3/8	<b>Shipping</b>				Ctn Wt	30			Cu Ft	20			A \$1,215 B \$1,233 C \$1,263 F \$1,406
Dimensions	D	W	H																												
Overall	28 1/2	28 1/2	36 3/4																												
Seat	17 3/8	21 1/2	22 1/4																												
Arm			30 3/8																												
<b>Shipping</b>																															
Ctn Wt	30																														
Cu Ft	20																														
	Specify: Model   Seat Fabric Grade Selection   Maple Wood Finishes   Finish   Metal Frame Color																														

<b>Flared Arm Swivel Chair - All Upholstered.</b> 	<b>QKN3000UUF</b> <ul style="list-style-type: none"> <li>standard black nylon base with hard tread dual casters</li> <li>multiple fabrics, see page <a href="#">SQS23</a></li> <li>overall height range 31 1/2" - 36 3/4"</li> <li>seat height range 16 1/2" - 22 1/4"</li> <li>arm height range 30 3/8" - 24 5/8"</li> </ul>	<table border="1"> <thead> <tr> <th>Dimensions</th> <th>D</th> <th>W</th> <th>H</th> </tr> </thead> <tbody> <tr> <td>Overall</td> <td>58 1/2</td> <td>28 1/2</td> <td>36 3/4</td> </tr> <tr> <td>Seat</td> <td>17 3/8</td> <td>21 1/2</td> <td>22 1/4</td> </tr> <tr> <td>Arm</td> <td></td> <td></td> <td>30 3/8</td> </tr> <tr> <td colspan="4"><b>Shipping</b></td> </tr> <tr> <td>Ctn Wt</td> <td>31</td> <td></td> <td></td> </tr> <tr> <td>Cu Ft</td> <td>20</td> <td></td> <td></td> </tr> </tbody> </table>	Dimensions	D	W	H	Overall	58 1/2	28 1/2	36 3/4	Seat	17 3/8	21 1/2	22 1/4	Arm			30 3/8	<b>Shipping</b>				Ctn Wt	31			Cu Ft	20			A \$1,148 B \$1,176 C \$1,228 F \$1,462
Dimensions	D	W	H																												
Overall	58 1/2	28 1/2	36 3/4																												
Seat	17 3/8	21 1/2	22 1/4																												
Arm			30 3/8																												
<b>Shipping</b>																															
Ctn Wt	31																														
Cu Ft	20																														
	Specify: Model   Seat Fabric Grade Selection   Back Fabric Grade Selection   Highest Fabric Grade Selection   Metal Frame Color																														

# Newton Quickship Order Check List:



**Specify:**

- 1. Model Number
- 2. Fabric Selection - vendor, pattern and color

**Example:**

QNW5121 (model #)	MOMENTUM (fabric vendor)	Silica Leather (pattern name)	Almond (pattern color)
----------------------	-----------------------------	----------------------------------	---------------------------

**1. Model Number**

**2. Quickship Seating Fabric Selection** - Please supply the following:  
Fabric vendor/Pattern name/Pattern color

[Please consult carded textiles on website for a list of colorways available on Quickship from each pattern](#)

**3. Arms:**

Black Polyurethane Arm Caps

**4. Control:**

Swivel Tilt Mechanism

**5. Base:**

Black Polyurethane with Casters

Description	① Model	Specifications			List Price Per Grade		
<b>Standard Scale Executive High Back</b> 	<b>QNW5121</b> <ul style="list-style-type: none"> <li>· black polyurethane arms and base</li> <li>· overall height range is 44 ¾ - 48 ½</li> <li>· seat height range is 16 ¾ - 20 ½</li> <li>· arm height range is 25 ¼ - 29</li> </ul>	Dimensions	D	W	H	<b>A \$1,668</b> <b>B \$1,711</b> <b>C \$1,788</b> <b>F \$2,134</b>	
		Overall	26 ½	26 ½	48 ½		
		Seat	17 ½	20 ¼	20 ½		
		Arm			29		
		Shipping					
		Ctn Wt	46				
		Cu Ft	19				

Specify: Model | Fabric Grade Selection

Description	① Model	Specifications			List Price Per Grade		
<b>Standard Scale Management Mid Back</b> 	<b>QNW5110</b> <ul style="list-style-type: none"> <li>· black polyurethane arms and base</li> <li>· overall height range is 36 ½ - 40 ¼</li> <li>· seat height range is 16 ¾ - 20 ½</li> <li>· arm height range is 25 ¼ - 29</li> </ul>	Dimensions	D	W	H	<b>A \$1,380</b> <b>B \$1,418</b> <b>C \$1,484</b> <b>F \$1,786</b>	
		Overall	26 ½	26 ½	40 ¼		
		Seat	17 ½	20 ¼	20 ½		
		Arm			29		
		Shipping					
		Ctn Wt	38				
		Cu Ft	17				

Specify: Model | Fabric Grade Selection

# Sosa Quickship Order Check List:

*Need it* **NOW!**  
**JSI QUICKSHIP**



**Specify:**

- 1. Model Number
- 2. Wood Species - Maple (M)
- 3. Wood Finish
- 4. Fabric Selection - vendor, pattern and color

**Example:**

QSA1061D | M | BAR | MAHARAM | MELD | SKYLINE  
 (model #) | (wood species) | (finish) | (fabric vendor) | (pattern name) | (pattern color)

**1. Model Number**

**2. Wood Species - Maple (M)**

**3. Wood Finish Options:**

BAR	Barrel	MCH	Mocha
BRK	Brickdust	OBK	Outback
BUF	Buff	PIL	Pilsner
CSK	Cask	PIN	Pinnacle Walnut
CND	Cinder	RAV	Raven
CLY	Clay	RYE	Rye
EGR	Egret	SAB	Sable
FAW	Fawn	SAD	Saddle
FLX	Flax	SIE	Sienna
FLN	Flint	TRF	Truffle
FLO	Florence Walnut	UMB	Umber
LOF	Loft	VAL	Valley
MES	Mesa	WLH	Walnut Heights
MIN	Mineral		

**4. Quickship Seating Fabric Selection** - Please supply the following:  
 Fabric vendor/Pattern name/Pattern color

[Please consult carded textiles on website for a list of colorways available on Quickship from each pattern](#)

Description	Model	Specifications			List Price Per Grade		
<b>Guest Chair</b> 	<b>QSA1061I</b> · upholstered seat · ¾ upholstered back	<b>Dimensions</b>	<b>D</b>	<b>W</b>	<b>H</b>	A \$1,142	
		Overall	23 ½	23	33 ¼	B \$1,167	
		Seat	19 ½	22 ¾	18	C \$1,213	
		Arm			26 ⅞	F \$1,420	
		<b>Shipping</b>					
		Ctn Wt	25				
		Cu Ft	12				

Specify: Model | Fabric Grade Selection | Maple Wood Finishes | Finish

<b>Guest Chair</b> 	<b>QSA1061D</b> · upholstered seat · fully upholstered back	<b>Dimensions</b>	<b>D</b>	<b>W</b>	<b>H</b>	A \$1,141	
		Overall	23 ½	23	33 ¼	B \$1,172	
		Seat	18 ⅞	22 ¾	18	C \$1,226	
		Arm			26 ⅞	F \$1,474	
		<b>Shipping</b>					
		Ctn Wt	28				
		Cu Ft	12				

Specify: Model | Fabric Grade Selection | Maple Wood Finishes | Finish